

MARCH 1984 \$2.35* NZ\$2.95

eti

ELECTRONICS TODAY INTERNATIONAL

Check Inside
JAYCAR'S
1st CATALOGUE

SHUTTLE-TO-HOUSTON VIA HAM RADIO

*Australian hams
prove amateur radio
can provide back-up
for space flights*



**MORE FUNCTIONS
FOR THE VZ200
UNDERSTANDING THE
6800-SERIES MICROS
EIGHT JOYSTICKS REVIEWED**

**ROOM LIGHTS CONTROLLER
MICROBEE ROM READER
DIGITAL ENLARGING
EXPOSURE
METER**

SPECIAL OFFER
Cheap 6800 books

HI-FI: ME SOUND AMP/PREAMP REVIEWED (Aust.made)



CDP-101

COMPACT
disc
DIGITAL AUDIO

Hear digital perfection.

Introducing the Sony Compact Disc Player.

When we used our long experience in digital technology to create the CDP-101 Compact Disc Player, we wanted to give you something more than the world's clearest sound.

WIRELESS REMOTE CONTROL Full-function remote control.

3-WAY MUSIC SEARCH □ Instant direct access to any selection with the 10-key pad on remote control unit. □ AMS (Automatic Music Sensor) allows access to the beginning of next or previous selection. □ 2-speed bi-directional search to find any desired music passage.

REPEAT FUNCTION Program to repeat the entire disc, one selection, or a specific portion of music.

3-FUNCTION DIGITAL READOUT DISPLAY □ Selection number. □ Time lapse of selection being displayed. □ Remaining time on the disc.

LINEAR SKATE DISC LOADING Just press the button, platter control and cueing are automatic.

Get even more perfect sound with the Sony Digital Audio Component System, "Precise Series".



SONY

AUD 0391

EDITOR

Roger Harrison VK2ZTB

ASSISTANT EDITOR

Jennifer Whyte B. App. Sc.

EDITORIAL STAFF

Geoff Nicholls B.Sc./B.E.

Peter Ihnat B.E., B.Sc.

Robert Irwin

Jane Hodson

ASSOCIATES

David Tilbrook VK2YMI

Jonathan Scott

B.Sc./B.E. (Hons) VK2YBN

DRAUGHTING

David Currie

PRODUCTION

Steve Landon

Mark Davis

ADVERTISING SALES

Richard Pakalnis (Group Manager)

John Whalen (National)

Steve Collett

ART STAFF

Ali White B.A.

Bill Crump

READER SERVICES

Carmel Gatt

ACOUSTICAL CONSULTANTS

Louis Challis and Associates

HEAD OFFICE

140 Joynton Avenue, (PO Box 227)

Waterloo, NSW 2017.

Phone: (02) 663-9999 Sydney.

Telex: 74488, FEDPUB.

**ADVERTISING OFFICES
AND AGENTS:**

Victoria and Tasmania: Virginia Salmon and Mel Godfrey, The Federal Publishing Company, 23rd Floor, 150 Lonsdale Street, Melbourne, Vic. 3000. Phone: (03) 662-1222 Melbourne. Telex: 34340, FEDPUB.

South Australia and Northern Territory: The Admedia Group, 24 Kensington Road, Rose Park, SA 5067. Phone: (08) 332-8144 Adelaide. Telex: 82182, ADMEDIA.

Queensland: Geoff Horne Agencies, 16 Bellbowrie Centre, Bellbowrie, Qld 4070. Phone: (07) 202-6813 Brisbane.

Western Australia: Cliff R. Thomas, Adrep Advertising Representative, 62 Wickham Street, East Perth, WA 6000. Phone: (09) 325-6395 Perth.

New Zealand: Chris Horsley, 4A Symonds Court, Symonds Street, Auckland. Telex: 260753, TEXTURE.

Britain: Peter Holloway, John Fairfax and Sons (Australia) Ltd, Associated Press House, 12 Norwich Street, London EC4A 1BH. Phone: (01) 353-9321 London. Telex: 262836, SMHLDN.

Japan: Genzo Uchida, Bancho Media Services, 5th Floor, Dai-ichi Nisawa Building, 3-1 Kanda Tacho 2-chome, Chiyoda-ku, Tokyo 101. Phone: (03) 252-2721 Tokyo. Telex: 25472. BMSINC.



ELECTRONICS TODAY INTERNATIONAL is published monthly by the Electronics Division of the Federal Publishing Company Pty Limited, 140 Joynton Avenue, Waterloo, NSW 2017. Managing Editor: Bob Izzard. Typeset and printed by ESN-The Litho Centre, Sydney. Distributed by Gordon and Gotch Limited, Sydney. Cover price \$2.35 (maximum and recommended Australian retail price only; recommended New Zealand price, \$2.95). Registered by Australia Post. Publication No NBP0407. ISSN No 0013-5216.

COPYRIGHT © 1984, THE FEDERAL PUBLISHING COMPANY

FEATURES

NEWS DIGEST	8
SHUTTLE-TO-HOUSTON VIA AMATEUR RADIO	14
SPECIAL OFFER 6800 MICROPROCESSOR BOOKS	49
SPECIAL OFFER HEWLETT PACKARD LOGIC PROBES	64
EQUATORIAL VHF AND PLASMA BUBBLES	110

SIGHT & SOUND

SIGHT & SOUND NEWS	20
ME 15 PREAMP AND ME 75 POWER AMP REVIEWED	23

COMPUTING TODAY

BATTLE FOR DESK TOP REAL ESTATE.....	33
COMPUTING TODAY NEWS	34
6800 MICROPROCESSOR SERIES	45
EIGHT JOYSTICKS AND A TRACKBALL REVIEWED	51
PROJECT 678 MICROBEE ROM READER	56
MORE FUNCTIONS FOR THE VZ200	63
MICROBEE COLUMN	66
VIC-20 COLUMN	70

TECHNICAL

SPECIAL OFFER HEWLETT PACKARD LOGIC PROBES	64
EQUIPMENT NEWS	73
COMPONENT NEWS	79
PROJECT 1522 ROOM LIGHTS CONTROLLER	86
PROJECT 1521 DIGITAL EXPOSURE METER	96
IDEAS FOR EXPERIMENTERS	101
IDEA OF THE MONTH	102
SHOPAROUND	103

COMMUNICATIONS

COMMUNICATIONS NEWS	107
EQUATORIAL VHF AND PLASMA BUBBLES	110

GENERAL

COMMENT	5
ADVERTISERS' INDEX	5
SPECIAL OFFER 6800 MICROPROCESSOR BOOKS	49
MAIL ORDER BOOKS	83
MINI-MART	113
DREGS	114

COPYRIGHT: The contents of *Electronics Today International* and associated publications is fully protected by the Commonwealth Copyright Act (1968). Copyright extends to all written material, photographs, drawings, circuit diagrams and printed-circuit boards. Although any form of reproduction is a breach of copyright, we are not concerned about individuals constructing projects for their own private use, nor by bands (for example) constructing one or more items for use in connection with their performances. Commercial organisations should note that no project or part project described in *Electronics Today International* or associated publications may be offered for sale, or sold in substantially or fully assembled form, unless a licence has been specifically obtained so to do from the publisher, The Federal Publishing Company, or from the copyright holders.

LIABILITY: Comments and test results on equipment reviewed refer to the particular item submitted for review and may not necessarily pertain to other units of the same make or model number. Whilst every effort has been made to ensure that all constructional projects referred to in this edition will operate as indicated efficiently and properly and that all necessary components to manufacture the same will be available, no responsibility is accepted in respect of the failure for any reason at all of the project to operate effectively or at all whether due to any fault in design or otherwise and no responsibility is accepted for the failure to obtain any component parts in respect of any such project. Further, no responsibility is accepted in respect of any injury or damage caused by any fault in the design of any such project as aforesaid.

IN STOCK NOW

MORE SCOPE. LESS MONEY.

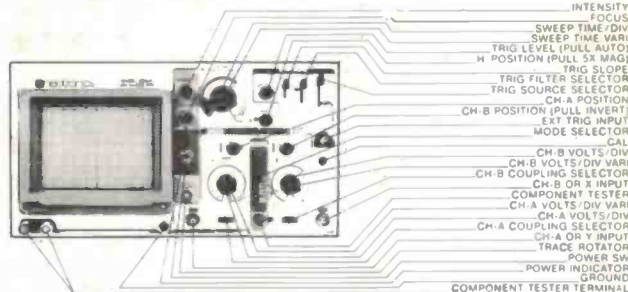

\$499.00
TAX FREE

Price Breakthrough

The Neotronics Model OS620 is a powerful 20MHz dual trace oscilloscope with performance and features normally found on scopes costing \$200-\$500 more. We sell at lower profit margins and import directly from the manufacturer. You reap the benefit!!

Compare the Features

The Neotronics OS620 is a precision measuring instrument. The tube is 150mm flat screen/ internal graticule type with 2kV acceleration potential. The bandwidth is a full 20MHz on both channels. Others offer round faced tubes, plastic graticules, less bandwidth, yet cost more! Intensity modulation is built in. By importing directly we offer you the best value on the Australian market.

\$574.50
INC. TAX

Built-in component tester

The component tester allows you to make full use of the OS620. With no additional test gear, you can check resistors, capacitors and zener diodes as well as trouble shoot solid state circuits. Testing signals are available via the COMP. TEST terminals.

Probes included in price.



Probes included

Most users will need a set of probes. These are sold as very expensive 'extras' with some other brands - often costing over \$70.00 a pair (we think this is a bit like selling a car and then saying it's extra for the tyres!). The Neotronics OS620 comes complete with a pair of high quality probes.

	Neotronics OS620	Hitachi V212	TRIO 1560
Bandwidth	20MHz	20MHz	15MHz
Flat Screen with internal graticule	Yes	Yes	No
Probes	Included	\$28 each	\$33 each
Component tester	Yes	N/A	N/A
Price (inc. tax)	\$574.50	\$699.00	\$626.75
Price with two probes	\$574.50	\$755.00	\$692.75

neotronics

FOR HIGH TECHNOLOGY ELECTRONICS

314 Lower Plateau Road, Avalon NSW
2107 Australia PO Box 289, Newport
NSW 2106. Phone: (02) 918 8220.
Telex: AA 70842



**BUY DIRECT
AND SAVE**



**DELIVERED ANYWHERE
IN AUSTRALIA FOR \$7.50**

**Phone on the Hotline
(02) 918 8220**

Avoid disappointment. Order your OS620 by Bankcard or MasterCard on the phone. Just call up, reverse the charges and we'll take your order. Shipping is only \$7.50 anywhere in Australia - including packing and insurance.

Full 12 month warranty. Your OS620 is fully guaranteed for a full year.

Prices correct and goods expected in stock at time of going to press.

ADVERTISERS' INDEX

AED	48
Applied Technology	68,69
Aust. Government	6,7,10
Avtek Electronics	80
Daneva	32
Benelec	19
Birkenhead Electronics	43
Dick Smith	22,30,31,60,61,92,93
Electromed	36
Elmeasco	77
Energy Control	48
Ferguson	19
GCS Computers	48
GFS Elect	108
Hi-tech Light & Sound	81
ICS	136
Idiak	37
Imark	78
Jaycar	54,55,104,105,109
Mcgraths	74,75
Mini Tool	29
Mytek	59
Neotronics	4
Opera House	58
Parameters	11,12
Pioneer	27
Promark Elect	62
Radio Despatch	13
Rod Irving	35,44,50,82
Rose Music	OBC
Sanyo	IBC
Scan Audio	28
Scientific Devices	58,106
Sheridan	72
Sony (Aust)	33
Shere Computers	41
Stewart Elect.	78
Soanar	94,95
Truscott Elect	78
Vicom	109
Videoactiv	16
Geoff Wood	85



COMMENT



Roger Harrison
Editor

*If the blind lead the blind,
both shall fall into the ditch.*
— St. Mathew

THERE HAVE BEEN MASSIVE STRIDES in computer hardware and software development in recent years, powered by a burgeoning market demanding ever more sophistication and power and ever more 'user friendliness' (to use the trade's jargon). What the hardware/software designers are aiming at is to reduce, or strip away, the requirement for 'computer knowledge' in users or potential users. An entirely laudable aim. Just as one needn't have a mechanical engineering background to be able to drive a car, one needn't have a computer systems engineering background to be able to use a modern computer.

Standing back a little and looking at where the industry has been, I think that point was reached some time ago and the industry is rushing headlong past the goal, unrealising.

In the main, computers and their software are no longer 'unfriendly' or difficult to use, no programming ability is necessary. What *does* make many computers difficult to use is their documentation. Some of our staff and correspondents have had things to say on this subject over the years, varying from guarded praise to scathing condemnation. It's unfortunate, but I think that, while the state of the art has moved ahead enormously in hardware and software, it remains static when it comes to documentation. There are some specific exceptions, but all too few. Too much seems to be written in some language other than plain English; though the words are recognisable, the meaning is not.

I think the industry should be now not looking to its laurels, nor the way ahead, but introspectively, focussing on the documentation delivered with their product.

NEXT MONTH



APPLE'S MACINTOSH — REIGNS SUPREME?

Apple launched their "third generation" computer on a slightly prepared public late in January. Will it lead Apple and the computer industry behind them into the next computer revolution? Collyn Rivers reports.

PROJECT 340 VEHICLE SECURITY ALARM

This alarm does not rely on interior lights being activated by a door opening to trip the alarm. It uses 'resonance' sensors to tell the circuitry your vehicle's being tampered with! It features three delays — exit, entry and alarm length before resetting. The alarm is armed in an unusual way so you can still protect the vehicle, even though you've left it in a parking station and the keys with the attendant.

6802-BASED MICROCONTROLLER

A microprocessor with a bit of ROM, a bit of RAM and some I/O lines can do all sorts of things. This project, based on the 6802, forms the basis of a whole series of controller projects. Remember the ETI-650 STAC Timer? There's an application, for one.

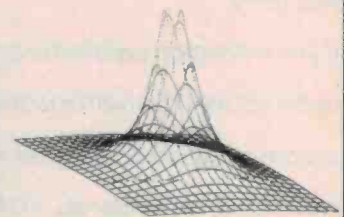

3D PLOTTING ON THE MICROBEE

How to plot three-dimensional graphs on-screen and to a printer using your Microbee computer. Simple, but smart! Excellent results, too.

Although these articles are in an advanced state of preparation, circumstances may affect the final content. However, we will make every attempt to include all features mentioned here.

SERVICES

TECHNICAL INQUIRIES: We can only answer readers' technical inquiries by telephone after 4.30pm Mondays to Thursdays. The technical inquiry number is (02) 662-4267. Technical inquiries by mail must be accompanied by a stamped, self-addressed envelope. There is no charge. We can only answer queries relating to projects and articles as published. We cannot advise on modifications, other than errata or addenda. We try to answer letters as soon as possible. Difficult questions may take some time to answer.

GENERAL INQUIRIES: For all inquiries about back issues, subscriptions (\$20.00 for 12 months/12 issues), photocopies of articles, artwork or submitting articles, call (02) 663-9999 or write to: ETI Reader Services, 140 Joynton Avenue (PO Box 227), Waterloo, NSW 2017.

CONTRIBUTIONS: Submissions must be accompanied by a stamped, self-addressed envelope. The publisher accepts no responsibility for unsolicited material.

Straight sail



If you wish to attend a university to obtain a degree, why not have the Navy to pay your way. And offer you a career at the same time.

The Navy is seeking university entrants in the fields of Science, Arts, Mechanical or Electrical Engineering to attend the Royal Australian Naval College and the new Australian Defence Force Academy.

If you have matriculated or are currently undertaking your matriculation, are an Australian citizen or eligible to apply for Australian citizenship, are under 20 on the 1st January of your intended year of entry and are able to meet our selection requirements you will be offered excellent pay to obtain the degree of your choice and qualify as an Officer in the Navy. Taking up positions such as Combat Systems Officers, Marine Engineers, Seaman Officers and Supply Officers. Commanding men and playing a key role in the defence of Australia.

So, if you want more than a degree maybe the Navy can offer you straight sailing into a career.

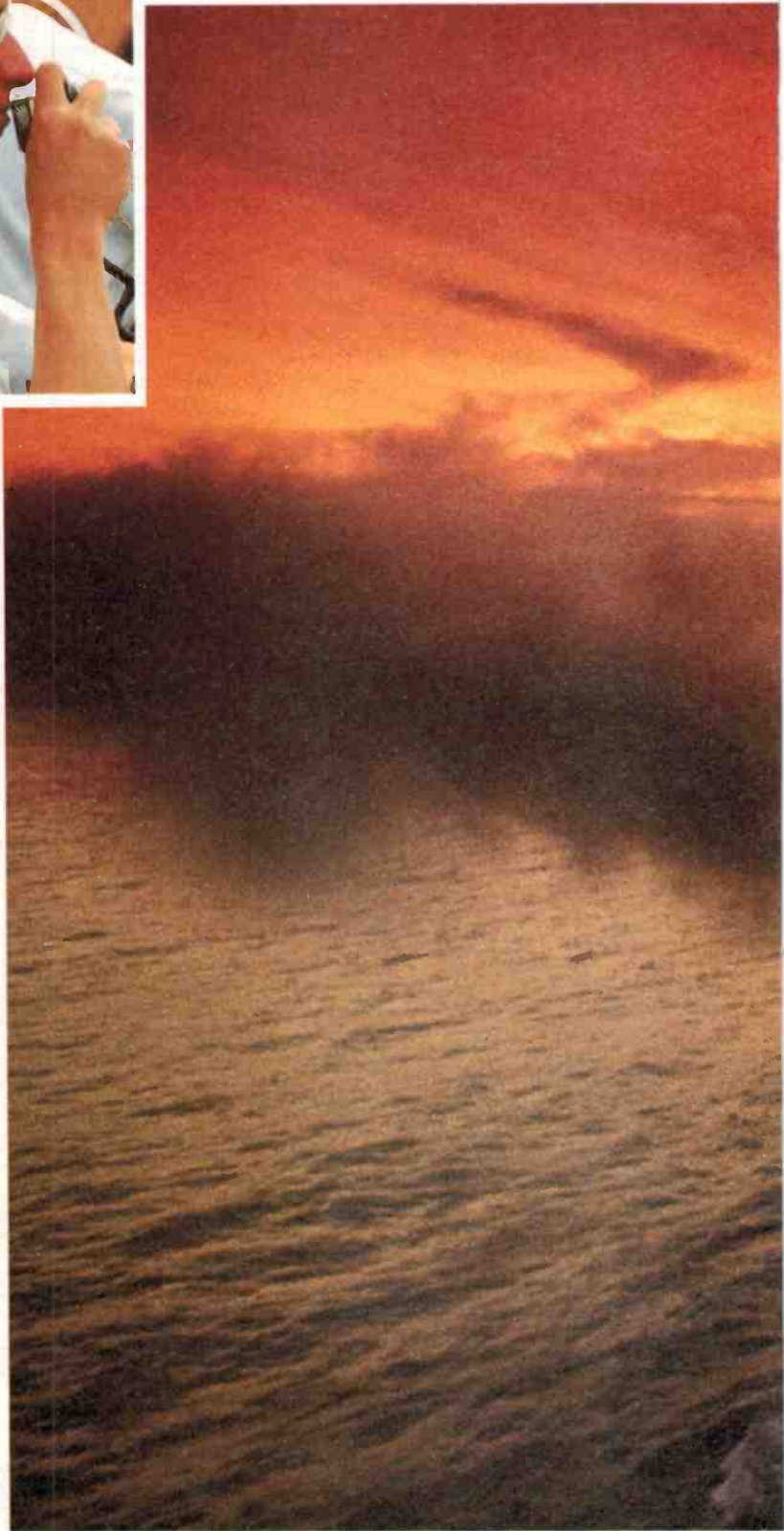

Are you good

ing through a degree course.

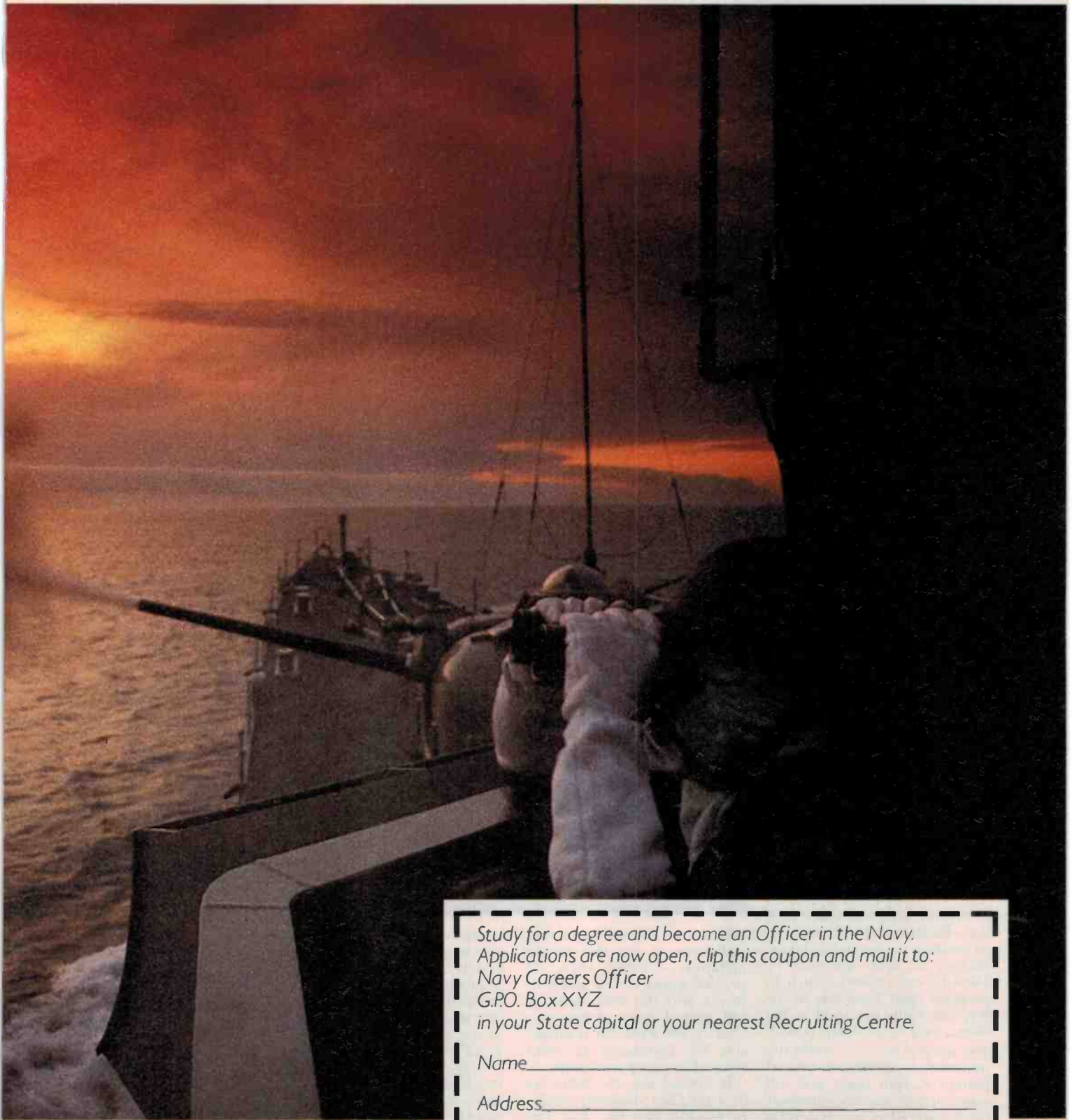

enough?

Study for a degree and become an Officer in the Navy.
Applications are now open, clip this coupon and mail it to:
Navy Careers Officer
G.P.O. Box XYZ
in your State capital or your nearest Recruiting Centre.

Name _____

Address _____

_____ Postcode _____

Birthdate _____

Authorised by the Director General of Recruiting, Department of Defence.

NCM 68. DPS. 123



SATELLITE TRIALS FOR ANTARCTICA

A satellite communications Earth station is being set up at the Australian base at Mawson in Antarctica in order to assess the potential of satellite communications to meet future needs of Australian National Antarctic Research Expeditions (ANARE) communications needs.

Trials of the system are to be conducted between Mawson and Australia this year. An investigation recently carried out by the Antarctic Division of the Department of Science has shown that existing communications networks between Australia and Antarctica are inadequate and unreliable (a fact well-known to ex-expeditioners — Ed.).

It is estimated that most of the equipment currently used at the stations will need replacing in two or three years, and an urgent assessment of future demands and systems is required.

At the present time communications between Australia, her Antarctic stations and expedition ships at sea, are carried out using high frequency radio links.

These links provide the sole means of radio communication, and are often severely effected by disturbances in the Earth's ionosphere.

In order to evaluate the suitability of satellite communications, the Antarctic Division, which is responsible for ANARE communication links, has decided to purchase an Inmarsat ground station.

The Inmarsat system has three satellites in geostationary orbit 36 000 km above the equator over the Atlantic, Indian and Pacific Oceans.

Mawson tests will use the Indian Ocean satellite, which will be some 13° above the horizon almost due north of the station.

This satellite's permanent control stations are at Eik in Norway and Yamaguchi in

southern Japan. There are no Inmarsat control stations in Australia.

Communications traffic from Mawson will travel to the satellite, down to the Japanese station, then on to Australia via either an undersea cable, or the Intelsat satellite system to a ground station in Ceduna, South Australia. On reaching Australia, traffic will be patched into the national communications network.

The Inmarsat facility will provide a single communications channel which can be used at any time day or night for either telephone, telex, facsimile, or data transmission. This will allow an adequate evaluation of satellite communications to be made.



NEW PRESIDENT FOR A.E.I.A.

The Managing Director of Plessey Pacific Pty Ltd. Mr Bruce Goddard has been appointed the new president of the Australian Electronics Industry Association (A.E.I.A.)

He succeeds Mr Allen Deegan, Chairman and Managing Director of Standard Telephones & Cables Pty Limited, who did not seek Presidential reelection but will remain on the Board of Directors.

Newly-elected Vice-President of the association is Mr Cornelis Bossers, Managing Director of Philips Industries Holding Ltd.

Other executive appointments made at the Annual General Meeting were: *Telecommunications and Defence Division*: Chairman, Mr Peter Lane, (Standard Telephones & Cables Pty Ltd); Vice-chairman, Mr Arthur Gabb (Amalgamated Wireless Australasia Ltd). *Components Division*: Chairman, Mr Bob Gibson (Morris Productions Pty Ltd); Vice-chairman, Mr Chris Tyree (Amtron Tyree Pty Ltd). *Mobile Radio Division*: Chairman, Mr Terry Stanley (Motorola Electronics Aust. Pty Ltd); Vice-chairman, Mr Ian McKenzie (Philips Industries Holdings Ltd).

to turn lights on at the right time to greet guests, or welcome the returning household following a night out.

Further information on the PC700 Security Switch is available from Arlec Pty Ltd, 30 Lexington Road, Box Hill Vic 3128. (03)840-1222.

PROGRAMMABLE SECURITY SWITCH

The new Arlec PC700 Security Switch can be programmed to turn lights on and off up to 48 times each day to give a natural 'at home' appearance to a dwelling and act as a deterrent to burglars.

To further confuse and discourage burglars the Arlec Security Switch has a built-in variability feature that automatically turns the lights on and off at slightly different times each day. Furthermore it is possible to simulate the normal 'at home' pattern of light operation by allowing the security switch to program itself according to the way the lights are used in the home over a 24 hour period. The integral memory stores the information about this normal pattern of light usage and will repeat it continuously whenever the householders are away from home.

The security switch is designed for wall mounting and can replace existing wall mounted

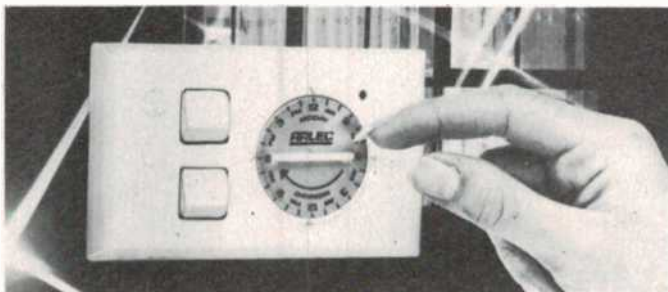

switches or be used in new installations. It can also replace architrave switches where the present wiring can be easily diverted into the wall cavity. It will control lamp globes to a total of 500 watts but is unsuitable for fluorescent or other types of gas discharge lamps.

In normal use, the lights can be controlled manually simply by pressing the time dial. This acts as the switch to turn the lights on or off without disturbing the preset time selections stored in the security switch's

memory, which will remain effective until they are deliberately changed to another sequence by the owner. The switch has a current back-up feature to provide at least five minutes retention of memory in the event of mains power failures.

It also combines the convenience of automatic lighting control with the ability to make savings in electricity costs. For example, the programmed switch will remember to turn off lights that may have been left on inadvertently and can be made

BRITISH ROBOT CONFERENCE

Industrial robotics experts are invited to submit papers to the British Robot Association (BRA) for its 7th Annual Conference to be held in Cambridge, eastern England from 14-16 May 1984.

The conference contributes to the advancement of robot technology in Britain and overseas by providing an international forum to discuss technological advancement. Presentations dealing with industrial case-studies and experience of practical applications are welcome, says BRA.

Topics for discussion include assembly and machine transfer, robot welding and design, programming, economics, human factors, safety, robot handling applications and management. To date, papers have been received from Britain, the United States, Germany, France, Finland and Bulgaria. These, together with any new contributions will be of benefit to those already involved in the manufacture or use of robots as well as others who wish to increase productivity and efficiency, says BRA.

Authors abstracts — about 100 words — should be sent to The Conference Director, BRA 7, British Robot Association, 28-30 High Street, Kempston, Bedford, England, MK42 7AJ.

NEW STANDARDS

The Standards Association of Australia has published a new standard on fixed capacitors for use in electronic equipment specifically on fixed polystyrene film dielectric dc capacitors with thin metal foil electrodes. It is identical with IEC 384-7 (1978) on that type of capacitor.

The purpose of this standard (AS 1541.2) is to establish preferred ratings and characteristics. Test severities and performance requirements for the type of capacitor are given for appropriate test procedures selected from AS 1541, Part 1, the generic standard for capacitors for use in electronic equipment.

Copies of AS 1541.2 can be purchased from any SAA office at a cost of \$11.40 plus \$2.40 postage and handling charge.

The SAA is also seeking comment on a proposed standard, DR 83247, for stabilised power supplies having on ac output.

Stabilised power supplies are generally complex units and subject to variables such as temperature, input voltage and load. The variation in performance because of these variables are specified and this should result in the rationalisation of design, construction and performance requirements.

The draft does not cover power supplies for electrical measurement equipment. It includes the electrical performance requirements and nominates the physical dimensions to be listed when specifying a unit.

Test methods covering the stabilized output quantity and electromagnetic interference are included.

Attention is drawn to the fact that this is a draft only and liable to alteration in light of comment received.

For information telephone (02)929-6022 or any state office.

NOTES & ERRATA

Project 412, October 1983: The linking for dot/bar mode is shown incorrectly on the circuit and component overlay. For a dot mode display, link pins 9 and 11 (as per the photograph of the board); for the bar mode, link pin 9 to the positive supply.

Upgrading the ETI-668 EPROM Programmer, January 1984: Two connections to the 4PDT switch have been Interchanged. Looking at the wiring diagram on page 70, the two upper and lower right hand wires have been transposed. The upper one says "PIN 7 PERSONALITY SKT" but should go to R14/15 — SW2b, the lower one says "R14/15 — SW2b" and should go to pin 7 of the personality socket.

Project 676, Microbee RS232er, February 1984: The pinout for the transistors, shown on page 65, is all screwed up. Use the pinout on page 111.

Project 274, Damn Fast NiCad Charger, February 1984: Figure 2 shows the battery negative connected to the heatsink. It should be insulated from it. The BYX/200L diode cathode connects to the collector of Q4/Q5 and R1/LED1 via the heatsink, not the wires shown.

ARLEC'S MINI ELECTRIC TOOL

Designed in Australia, the Arlec Supertool Model No. ET571 is a compact, precision power tool which has a multitude of uses in and around the home, the office, factory, workshop etc. It is described as 'ideal' for miniature and electronic engineering, educational projects and drawing office work.

Particular emphasis has been placed on the design of the casing to ensure optimum balance and ease of handling, with weight kept to a minimum. The on/off switch provides feather-touch stop/start control with a switch lock for continuous running.



The robust 12 watt motor operates at 10 000 revolutions per minute and is powered via an SEC approved plugpack adaptor.

The unit is supplied with eight tools, six eraser sticks and a collet chuck with five collets for a variety of tasks including drilling, shaping, cleaning grinding,

LONDON LAB SHOW

The Department of Trade is seeking companies manufacturing scientific, medical and laboratory equipment to participate in the 1984 London Laboratory Show. Participation in the show, to be held at the Barbican Centre from 4-6 September, will develop Australia's image as a manufacturer of world class high technology equipment.

Australian participation in Fairs covering similar products — Semlab UK 1981 and Mesucora France 1982 — has been very successful with exhibitors receiving initial orders of \$200,000 and \$938,000 respectively.

The product coverage includes scientific educational, medical and industrial equipment; services and supplies; sensors and back-up systems; medical electronics; analytical and biochemical research in instrumentation; electronic measuring and testing equipment; measurement control systems and instrumentation.

The Scientific Instrument Manufacturers' Association will run a major analytical conference concurrently with the Laboratory Show.

Australian laboratory equipment manufacturers seeking information on participation should contact the Promotions Officer, Ian French, Department of Trade, Canberra ACT 2600. (062) 72-25115.

and erasing. It can also be used with supplementary bits and cutters for milling, sanding, polishing, cutting and the superior continuous-line system of engraving.

Draughtsmen and graphic artists should find it invaluable as it is excellent for crasing ink and pencil lines quickly and cleanly from drawings, tracings, photocopies and dyeline prints.

Electronics designers and hobbyists use it as a high speed printed-circuit board drill and cutter. Handymen utilise it for small drilling, sanding and polishing jobs including using the unit to sharpen other tools.

Further information is available from Arlec Pty Ltd, 30 Lexington Road, Box Hill Vic. 3128.

HOW TO LEAVE SCHOOL WITHOUT BEING LEFT BEHIND.

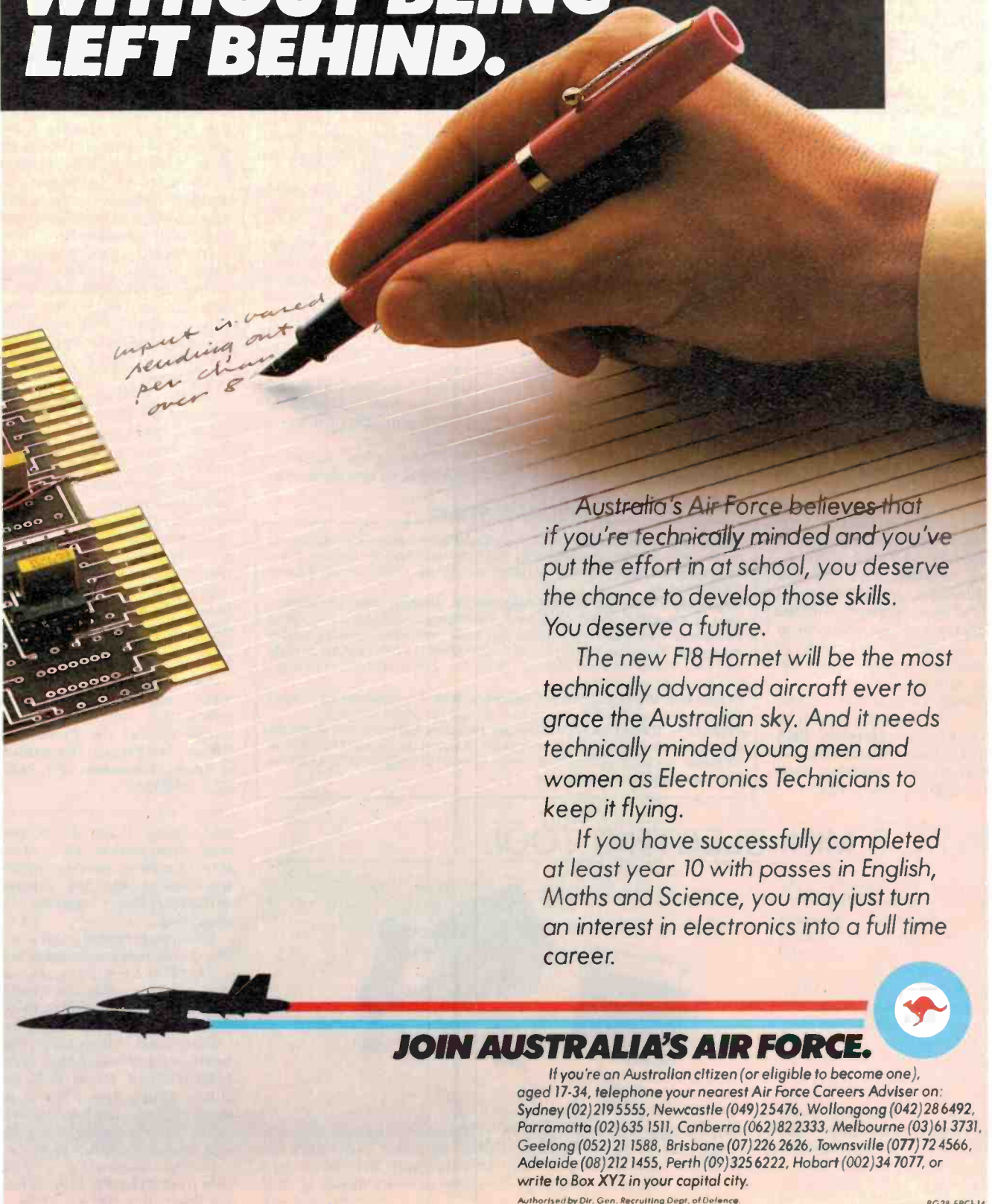

Australia's Air Force believes that if you're technically minded and you've put the effort in at school, you deserve the chance to develop those skills. You deserve a future.

The new F18 Hornet will be the most technically advanced aircraft ever to grace the Australian sky. And it needs technically minded young men and women as Electronics Technicians to keep it flying.

If you have successfully completed at least year 10 with passes in English, Maths and Science, you may just turn an interest in electronics into a full time career.

JOIN AUSTRALIA'S AIR FORCE.



If you're an Australian citizen (or eligible to become one), aged 17-34, telephone your nearest Air Force Careers Adviser on: Sydney (02) 219 5555, Newcastle (049) 254 476, Wollongong (042) 28 6492, Parramatta (02) 635 1511, Canberra (062) 82 2333, Melbourne (03) 61 3731, Geelong (052) 21 1588, Brisbane (07) 226 2626, Townsville (077) 72 4566, Adelaide (08) 212 1455, Perth (09) 325 6222, Hobart (002) 34 7077, or write to Box XYZ in your capital city.

Authorised by Dir. Gen. Recruiting Dept. of Defence.

RG28 FPCH14

UNDISPUTABLY YOUR BEST BUY IN DIGITAL MULTIMETERS...

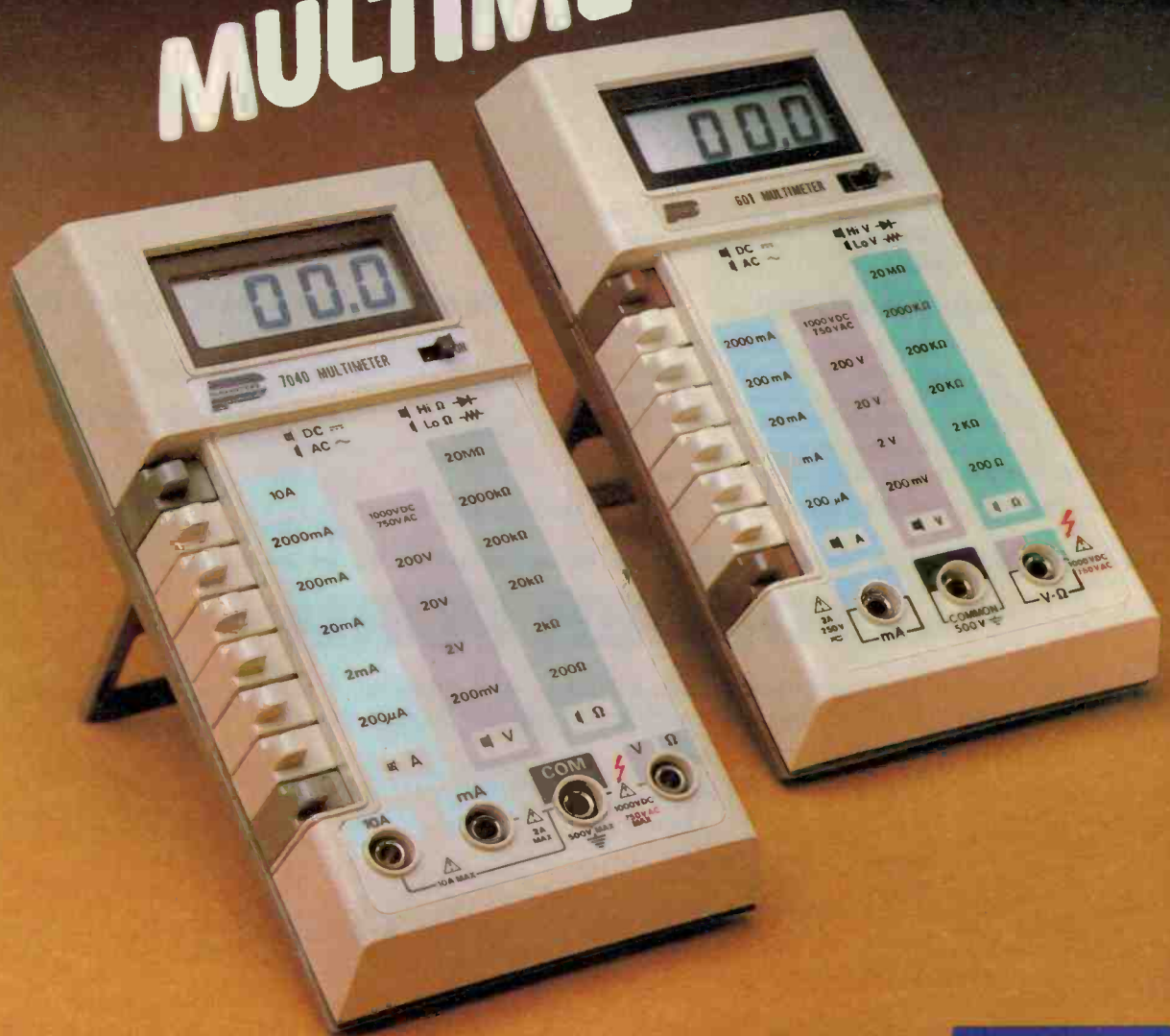

Special bonus offer from Parameters includes free carry case.

*Here's your opportunity to own
one of these superb instruments
at a very special price!*

Features

- * 3 1/2 digits
- * 28 ranges
- * Basic DCV accuracy 0.1% (7040) and 0.25% (601)
- * Battery Life >2,000 hours (7040) and >200 hours (601)
- * Hi-Lo Volt resistance tests
- * Overload Protection on all ranges
- * Current ranges 10A (7040) and 2A (601)
- * Auto polarity
- * Finger guards on probes and shrouded plugs for safety
- * Low battery indicator
- * Quality leads and Probes included

Here is what you get:

A Parameters Model 7040 or Model 601 digital multimeter, probably the best value instrument of its type in Australia. Instruments that are widely respected for their proven quality, ruggedness, dependability, accuracy and style.

Special Bonus Offer

Order your new Model 7040 or Model 601 now and receive our special bonus offer of a hard vinyl carrying case (normal retail price \$12.00) at no extra charge.

Our No-Nonsense Warranty

You have the protection of our no-nonsense warranty for a full 12 months from the date of purchase. Should your instrument develop a fault not attributable to physical abuse, simply return it to us freight paid and we will either repair or replace it at no charge to you. This applies in addition to all warranty requirements you normally receive under the trade practices act.

Hurry — This offer applies only to our current limited stocks.

**Model 7040
Only \$99 Tax Paid
\$87.75 Tax Exempt**

**Model 601
Only \$69 Tax Paid
\$59.95 Tax Exempt**

All prices include delivery anywhere in Australia.

How to Order

Simply complete the order form below and mail to:

Parameters Pty. Ltd.
P.O. Box 573
ARTARMON N.S.W. 2064

ORDER FORM

I would like to take advantage of your special digital multimeter offer. Please supply me meter(s) as set out below. I understand that I will receive a carrying case for each meter ordered at no extra charge.

QTY.	MODEL	PRICE TAX* FREE	PRICE TAX PAID	TOTAL AMOUNT
	601	\$59.95	\$69.00	\$
	7040	\$87.75	\$99.00	\$
				\$

* Tax free orders must include an exemption certificate on an official company order.

** Bankcard users be sure to include your full home address, not a PO box number.

PLEASE ALLOW 7 DAYS FOR DELIVERY

NAME

ADDRESS

I enclose my cheque for \$

Please charge my Bankcard**

No. 496

Our Company Order No. is enclosed

SIGNATURE

Detach and return to:
Parameters Pty. Ltd. P.O. Box 573 ARTARMON N.S.W. 2064 Offer closes June 30, 1984



ELECTRONICS TO JAPAN?

Sydney designers and manufacturers of computer-based musical instruments, Fairlight Instruments Pty Ltd, was one of 18 firms to win last year's Export Awards for Outstanding Achievement.

The annual awards, sponsored by the Confederation of Australian Industry and the Department of Trade since 1963, are a recognition of significant achievement in skill, enterprise and initiative in the export field.

Presented by the Minister for Industry and Commerce, Senator John Button, the award was accepted for the company by Research and Development Officer, Mr P. Vogel, at a presentation ceremony in Canberra on 2 December.

Fairlight Instruments claims a world first in the marketing of its technologically innovative microcomputer-based, multivoice, sound-producing system, the



Fairlight Computer Musical Instrument (CMI).

Accepted by leading international musicians, the CMI has achieved impressive export growth, up from sales of \$457 000 in its first year of production (1979-80) to \$1.6 million last financial year.

An arrangement with Japan's Matsushita to launch the product there, earned the firm an initial \$250 000. Other major sales have been in the USA, Britain and Europe.

World publicity was a significant success factor, much of it generated by trade show partici-

TV CHANNEL SPACING STANDARD CHANGE

The Minister for Communications, Mr Michael Duffy, announced in December that the existing official standard of 8 MHz spacing for the carriage of television signals in the UHF band would be changed to 7 MHz.

Mr Duffy said his decision would allow for more productive use of the spectrum which was a limited physical resource. The decision followed detailed consultation with the broadcasting industry and television receiver manufacturers, according to the minister's office. It would have no detrimental effect on the in-

dustry and would not cause any increase in the price of receivers, he claimed.

The existing standard of 8 MHz spacing was created in 1976 by the old Australian Broadcasting Control Board which had initially favoured 8 MHz spacing for UHF television services and 7 MHz for the more traditional VHF band. This band was becoming congested and as a result, the UHF band would increasingly be used in Australia for the future expansion of television services.

Apartment and advertising and promotional tours assisted by Trade Commissioners and export incentive grants.

The CMI was developed with the aid of an Industrial Research and Development Grant.

apart from enabling the planners to make more efficient use of UHF, adoption of 7 MHz spacing would also allow development of a national UHF television plan to proceed. The relevant technical standard for Australian television services would be altered in accordance with the decision, Mr Duffy said.

TO THE ELECTRONICALLY MINDED. (Professionals, Hobbyists, Students & Enthusiasts.)

We carry a wide range of Multimeters, Calculators, Soldering tools, Transformers, Cables, Instrument boxes, Computer Connectors, TV Aerials, Components and just about anything you may require.

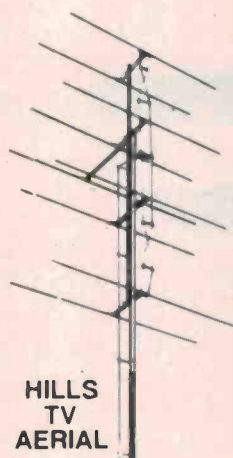

HILLS TV AERIAL

<p>MULTI-METERS</p> <ul style="list-style-type: none"> • UNIVERSITY • FLUKE 	<p>CALCULATORS</p> <ul style="list-style-type: none"> • CASIO • TEXAS INST • HEWLETT-PACKARD HP41C <p>Now in stock.</p>	<p>SOLDERING TOOLS</p> <ul style="list-style-type: none"> • WELLER • ROYEL
--	---	---

RADIO DESPATCH SERVICE

869 George St., Sydney NSW 2000 (Near Harris St.)

Tel. 211 0816
211 0191

Open: Mon-Fri 8.30am to 5.30pm
Thursday night late shopping till 6.30pm Sat 8am to 12.00pm

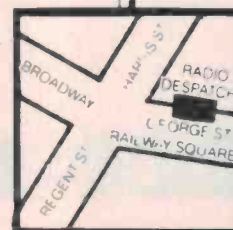

"QUALITY COMES FIRST" has been our trading principle for many years. This enables us to give you the best in service and the best in products...ensuring durability in what you buy and your own guaranteed satisfaction.

MAIL ORDERS TO RADIO DESPATCH SERVICE
869 George St., Sydney 2000 Tel. (02) 211 0191 • 211 0816

A group of Canberra radio amateurs set out to prove that amateur radio could provide viable backup communications for manned space flights.

Using 144 MHz equipment, they made an historic contact between Owen Garriott, W5LFL, aboard the Space Shuttle Columbia that flew in late November to early December last year, patching him through to the Johnston Space Centre in Houston (USA). This is their story.



MORE AMATEURS IN SPACE?

AMATEUR RADIO may well be welcome aboard future Space Shuttle flights as a direct result of the success of Dr Owen Garriott's operations on the STS-9 mission.

Although reports did not specifically mention the VK1ORR operation, its success has undoubtedly had some influence. The general amateur contacts were achieved in Garriott's 'spare time'. At a post-flight press conference on 19 December, Garriott said, "As with most hams on the ground, you have the opportunity to do that kind of work only in your spare time. That's the way we did it on board as well."

"In the hours I managed to find time for it, I talked with some 300 hams in various parts of the world, principally in the US, but also a good many in Europe, and other people scattered all over the face of the globe."

"Most of the contacts were by phone (voice), some on CW (morse code). These were all logged and will be acknowledged now that we are back here on the ground."

Carl Smith, W0BWJ, President of the American Radio Relay League, was on hand at the press conference to congratulate Dr Garriott and he expressed the hope that it will be possible to have more licensed amateur radio operators on board future Space Shuttle missions in order to prove that the amateurs' capability of providing backup and emergency communications is real.

The public relations success of W5LFL's operation cannot be denied. NASA, in need of favourable public exposure, showed that ordinary people can become involved in the space program.

(Item courtesy *Westlink Report* — Ed.)

Shuttle-to-Houston via amateur radio

P. G. Clark VK2KPG

for the VK10RR amateur group

WHEN it was announced that Dr Owen Garriott would operate as W5LEF from the Space Shuttle "Columbia" during the STS-9 mission, a great deal of interest was generated within the amateur fraternity world-wide. W5LEF used a hand-held transceiver in the two metre amateur band (144-148 MHz). This was the first time that an amateur station had been operated from an orbiting manned spacecraft.

The interest in this expansion of VHF amateur radio was shown by an active group working at the Orroral Valley NASA Space Tracking Station, situated in the Gudgenby Nature Reserve in the southern part of the Australian Capital Territory. The Orroral Tracking Station supports the Space Shuttle missions by providing tracking, telemetry and voice contact whenever the orbiter is in range. The amateurs at Orroral Valley are part of the specialist teams established to meet satellite tracking requirements. After discussion, this group decided to investigate the possibility of establishing an amateur station at the Orroral Valley Space Tracking Facility for the purpose of contacting W5LEF on the STS-9 mission. ▶



Will your child grow up to be Chairman of the Board?



Aristotle said 'give me your child from one to seven and I will give you the man.' Put simply he was saying people are products of their environment. Research confirms children brought up in an atmosphere of creativity and learning where they are encouraged to compete are the ones who get to the top.

What can a parent do to give their child that special start? To begin with you can turn off the television. And turn on the home computer. But with so many to choose from what home computer should your youngster have?

A Spectravideo is probably the perfect choice.

The Spectravideo Computer.

Spectravideo Computers are the most powerful systems in their class. Unlike the Commodore VIC 20, The Tandy TRS 80 and the Sinclair Spectrum, the Spectravideo is capable of almost infinite expansion. The 318 for example starts with 32K of Read Only Memory. And that's over twice that of the Spectrum and four times the more expensive Tandy.

What's more it can be expanded to 144K which is twice that of the Apple II, which is almost five times as costly. And the Spectravideo 318 is only half as powerful but as versatile as the 328.

The world's most understandable computer.

The Spectravideo Computer System has been created for first time computer users. Using CP/M and Microsoft Basic and complete with a comprehensive do-it-yourself manual the Spectravideo is probably the world's most understandable computer!

Work. And Play.

There is an infinite variety of programs available for the Spectravideo. Educational, scientific, financial and of course there's a range of games – including Coleco Vision. And to make the 318 even more fun it even has its own built-in joystick.

The better computer company.

Spectravideo Computers are distributed throughout Australia by Videoactiv Electronics, one of Australia's most professional computer companies.

Just \$399.

Yes! The powerful, versatile Spectravideo range of computers from Videoactiv Electronics costs from just \$399. It's not a lot to pay to see your youngster become Chairman of the Board.



Spectravideo

The world's most understandable computer.

See the amazing Spectravideo at your nearest dealer or ring Melbourne 537 2000, Sydney 328 1190, Brisbane 369 0496, Adelaide 211 7766, Perth 328 5299, Tasmania (003) 31 8551

Space tracking operations within Australia are supervised by the Department of Science and Technology, who were approached for permission to establish the amateur station. The Department declined permission on the grounds of possible interference to normal Space Shuttle communications. When the Department's decision was learned, they were requested to reconsider.

Because the amateur operations on the Space Shuttle were approved by NASA the NASA representative in Australia, Dr Joe Kerwin, was asked to intercede on behalf of the amateurs. With Dr Kerwin's help, an alternative site was located.

During this pre-mission period, Dr Kerwin was in contact with his ex-Skylab colleague, Owen Garriott, who was flying on the STS-9 mission. When Dr Garriott learned of the interest shown by the amateurs in Australia, he proposed that a special test should be conducted to prove that amateur radio could be used as a viable backup communications link. Dr Kerwin asked the amateur group at Orroral Valley if they would undertake this experiment. This challenge was accepted and the astronauts arranged with the mission planners at Lyndon B. Johnson Space Centre in Houston that one particular orbit would be made available for this historic test. Special frequencies, separate from those used for the normal amateur contacts, were arranged and kept secure by Dr Kerwin until one hour before the experiment took place. Even the orbit to be used was not revealed until after the STS-9 mission had been launched.

Site and setup

Situated in the Canberra inner-southern suburb of Deaken is the switching and communications centre for all NASA space-tracking voice, data and teletype circuits between Australia and the United States. With Dr Kerwin's help, it was at this centre that the amateur station was established. To this point, much of the ground-work and liaison with Dr Kerwin had been done by Richard Elliott, VK1ZAH, and Paul Bell, VK1BX, whose unflagging optimism and enthusiasm had brought the results so far.

Because of the number of amateurs involved, the special nature of the station, and the participation of NASA through Dr Kerwin, it was decided that a special call sign should be obtained, if possible. The Department of Communications was contacted and, thanks to their understanding and ready co-operation when the experiment was explained, they issued the special event call sign of VK1ORR for the duration of the STS-9 mission. With the preliminary arrangements completed, the site established and the call sign allocated, the equipment and antenna system was selected.

The choice of antenna was not simple because of the conflicting requirements that had to be met. By this time as well, launch day was approaching and not a great deal of time was available to construct special equipment. As this Shuttle mission had a high inclination orbit (57 degrees to the equator) an omnidirectional antenna would have been desirable. Such an antenna should have a low angle of radiation to

Shuttle-to-Houston via amateur radio

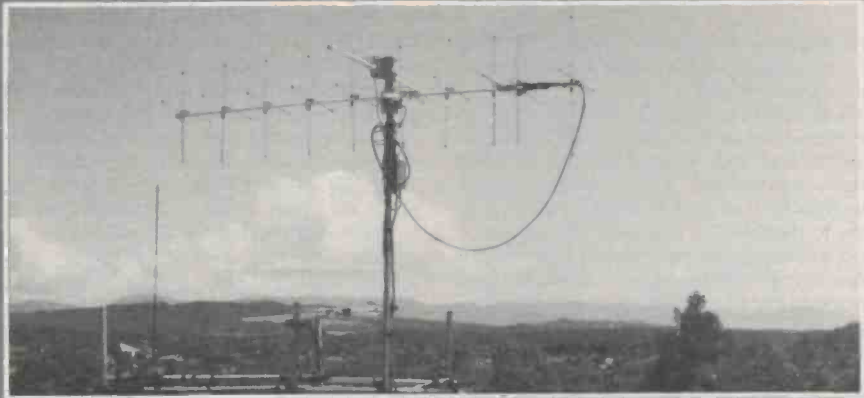

The array of antennas on the roof of the Deakin Switching Centre, Canberra. ▲



Working W5LFL aboard Columbia via VK1ORR. Left to right, Darryl Fallow VK1DF, Richard Elliott VK1ZAH and Bob Henson VK1RR. ▲

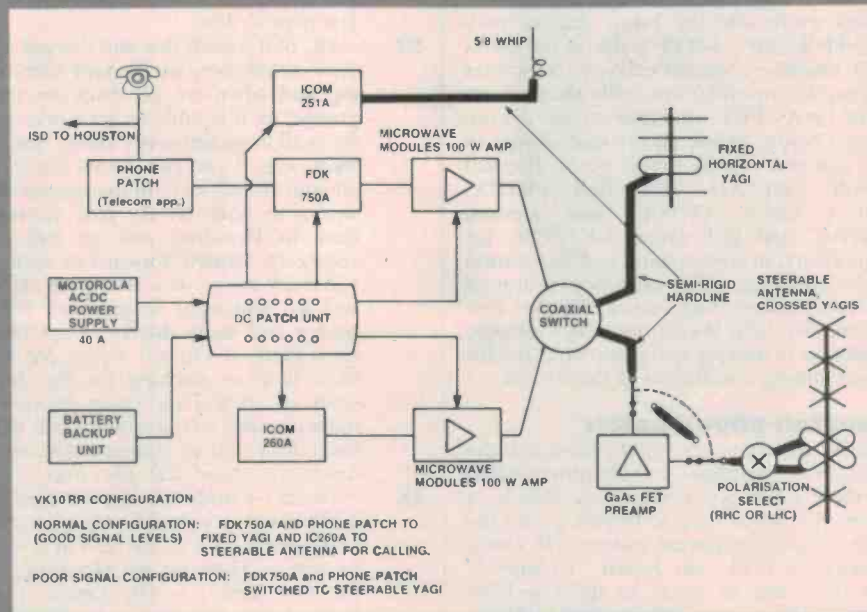

Block diagram of the VK1ORR station setup. ▲

Shuttle-to-Houston via amateur radio

cover the low-elevation horizon portions of the pass, and a higher angle for the maximum elevation point.

These characteristics are, for all practical purposes, mutually exclusive. In addition, physical size and weight had to be kept within manageable limits as the entire assembly had to be man-handled onto a roof some 15 metres above ground. The speed of a fast moving spacecraft posed problems for a directional antenna system. Finally, after consideration of all factors, a combination was selected to cover as many possibilities as was reasonable. This combination was a steerable, crossed 10-element yagi with switchable circular polarisation, a 5-element horizontal yagi oriented to maximum elevation of the pass, and a 5/8-wavelength vertical whip. The antennae were mounted on a temporary scaffold erected on the roof of the Deakin Switching Centre. Semi-rigid, low-loss hardline was used to connect the antennae to the equipment. A low noise GaAs FET pre-amplifier was used to improve the receiver noise figure.

The equipment used was provided by local amateurs and was configured in two chains to provide redundancy in the event of a failure. Alternative mains and battery power was available to all essential equipment. Three transceivers were used in the final configuration. These were an ICOM IC260A, an FDK 205 and an ICOM IC251A. The two main chains used Microwave Modules 100 W linear amplifiers with receiver preamplifiers.

This configuration allowed two 100 W uplink paths and the prime receive path threshold was -140 dBm due to the GaAs FET amplifier. Special delayed transmitter keying was installed to enable the antenna head GaAs FET amplifier to be disconnected before uplink power was applied to the antenna. Thanks must go to Richard Elliott VK1ZAH, Paul Bell VK1BX, Darryl Fallow VK1DF, Bob Henson VK1RR, and Bob Quick VK1ZQR, for their efforts in construction and installation of the equipment. The officers in charge of the Deakin Switching Centre, Mr Des Terrill and Mr John Warth, provided valuable assistance in making space available and for advice during installation of the station.

Houston phone-patch

For the actual contact, and to prove that the amateur system could provide proper backup voice capability to the Space Shuttle, a phone-patch was used to interface with the international telephone system. Dr Owen Garriott W5LFL, on board "Columbia" was then able to speak to the Cap-Com (Spacecraft voice communicator) in Houston via amateur radio through VK1ORR and an international phone-patch.

On Monday evening, 5th December 1983, this historic test took place during orbit 110 of the STS-9 mission. The test proved an outstanding success and demonstrated that amateur radio could provide excellent emergency voice communication.

The orbiter was passing from north-west to south-east over Australia, directly over Melbourne. This pass allowed only six minutes for the contact.

During his conversation with controllers in Houston, Owen Garriott said of VK1ORR: "This is one of the best stations we have heard since we have been in orbit!" A compliment indeed and a tribute to the performance of the VK1ORR station!

Also present for this history-making experiment were the US Ambassador to Australia, Robert Nesen, and Senator Jake Garn of Utah, USA, a member of the NASA Appropriations Committee. The ambassador was able to exchange a few words with W5LFL during the contact which was coordinated by Dr Garriott's colleague, Dr Joe Kerwin.

Contact

Here is a partial transcript of the historic two metre band amateur communications test between W5LFL on board the Space Shuttle "Columbia", and VK1ORR in Canberra. (S/C is the Spacecraft "Columbia", W5LFL; ORR is VK1ORR and JK is the NASA representative, Joe Kerwin).

S/C "Hello victor kilo one oscar roger roger, victor kilo one oscar roger roger; W five lima foxtrot lima, W five lima foxtrot lima".

ORR "W five lima fox lima here is VK one oscar romeo romeo. We copy you five by five. I will now hand you over to Joe Kerwin".

S/C "Columbia coming right back (signal fade) is Joe Kerwin at the station this morning?"

ORR "Roger Owen, we're copying you OK. We have had a problem with the phone-patch. We're trying to get the phone-patch up and then I'll hand you over to Joe".

S/C "OK, that sounds fine and I've got all your signals here on the tape recording and when we get back on the ground we'll be able to acknowledge them all in proper order and er, hullo there Joe, if you can get on the mic all your friends here in the spacecraft wish you hullo as do your friends back in Houston, and we will of course be looking forward to seeing you back home in a few more days and we also want to send our best wishes and many thanks to the fine crew there at Orroral Valley for all their help in tracking for the last week or so and the other previous missions, and an outstanding job has been done and we appreciate it very much. Go ahead now Joe, over".

JK "Alright, sounds like a real science party Owen, it sounds like you're getting a good time up there. I'm ready to turn — Have we got Houston on the line here? — OK Owen, I'm going to turn you over to Houston to complete the contact right now and then I want to get back with you for a

minute. Please finish your transmissions with 'over' as we are simplex and I have to push the button for Houston to talk. Go ahead and call Houston, over".

S/C "Hello Houston Cap-Com, Hello Houston Cap-Com, I expect this is er Brian on the line. This is W5LFL, Spacecraft Columbia, go ahead, Brian".

(Houston cap-Com uplink is garble on the tape and unintelligible)

S/C "Roger, outstanding. Load and clear. One of the best stations we've heard ever since we've been in orbit. The attitude of the spacecraft is just perfect, of course. We're looking right, straight down over Melbourne at just about this moment, this very moment, and we just wanted to establish the fact that we could maintain a backup comm. here. John is right behind me and he's been looking forward to er saying hello to you all or having us say hello to you through the backup ham system. — And he's giving us a thumbs up signal right now, Brian, so a fine business; we appreciate the chance to talk with you, go ahead, over".

(Houston Cap-Com transmission is garbled on tape)

S/C "Yeah, John doesn't want to get on the loop here, I would have to change the headset with him Brian, but hello to you also Bill and why don't we go back now to Australia and take a few moments here before we lose contact line-of-sight with Joe Kerwin. Thanks a lot fellas in Houston and back to you Joe, in Australia, over".

JK "OK, thanks very much Owen, I've got the Ambassador, Robert Nesen, here and incidentally, standing behind him is Senator Jake Garn from Utah who says hello to John and he still wants a ride. Here's the ambassador".

S/C "OK, fine Joe, thank you, I just passed along the hello from the senator to John who acknowledges that, and er, I am pleased to have you there also Mr Ambassador so I'm glad to see you all. The Spacecraft attitude really makes the comm. system fine here this morning and we've had a lot of good views of Australia, and er, we want to er as I say a moment ago, wish you all er a lot of many thanks and 73s for all the good work that you've done for us here in the past tracking missions. Go ahead.."

(End of partial transcript.)

The performance and success of this experiment was due to the dedication and determination of Dr Owen Garriott W5LFL, Dr Joe Kerwin, and Richard Elliott VK1ZAH, who were able to bypass international and bureaucratic boundaries by their personal involvement and interest. ●

PUT POWER ON BOARD



— with a PCB Mounted Transformer

- 3 ranges - 2.5/3VA : 5/7VA : 12/15VA
- Manufactured to AS3126
- Telecom approved • Standard PCB grid

TALK TO FERGUSON - THE AUSTRALIAN COMPANY WITH NEARLY 50 YEARS EXPERIENCE OF MANUFACTURING IN AUSTRALIA FOR AUSTRALIAN CONDITIONS

Ferguson Transformers Pty. Ltd.
331 High Street, CHATSWOOD 2067 Tel: (02) 407 0261
Telex: AA25728. Melbourne (03) 328 2843

FERGUSON

LOGCON



- MD - XXX SERIES for Motion Detectors and Speed Switches
AT - SERIES Timers and Alarm.
MDC - 4 Timers include Multi-Range Miniature 4-digit Multi-Range
PSV - 1 3-Phase Monitor Relay. Monitors for High and Low Voltage, Voltage Balance, Rotation Plus High and Low Frequency.

**Regulated Voltage Inverters -
Ideal Computer "No-Break" Supplies
Special Functions to Order
AUSTRALIAN MANUFACTURE**



minitool

AUSTRALIA PTY. LTD.
134A AYR ST.
DONCASTER (03) 850 9887

BENELEC



MEASURING POWER PLUS

Model DT-830. The accuracy and functions you need at a sensible price. Extreme electrical and mechanical ruggedness combined with the highest accuracy in its class.

- 30 ranges, including transistor testing, audible continuity test
- Auto zero and auto polarity. Sampling time 0.4sec
- Voltage inputs protected to 1000V, Ohms and Current to 250VAC
- Basic Accuracy $\pm 0.5\%$

Model DT-860 Autoranging, fast sampling (0.5sec), high resolution and moderate price:

- Continuity buzzer with fast (0.4sec) response (sampling time other ranges 0.5sec)
- Built-in stand
- Basic Accuracy $\pm 0.5\%$



For further details and latest prices contact:

BENELEC Pty Ltd

1 Greville Street, Randwick, N.S.W. 2031

Phone: (02) 665-8211 **Telex:** AA20181 BENELEC

KODAK ENTERS VIDEO MARKET

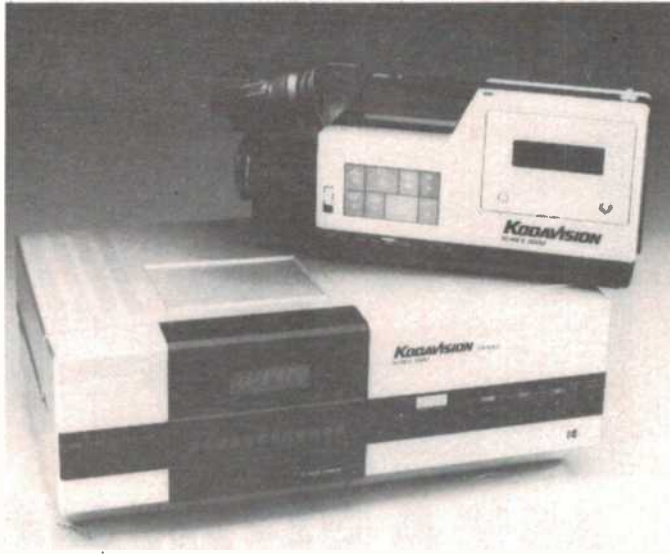

Eastman Kodak Company has announced plans to extend its reach in imaging to the worldwide video market. Kodak will market an entirely new 8 mm video camera-recorder system and more than 50 configurations of Kodak and Eastman brand video cassettes and tapes for home entertainment and professional applications.

The products will be manufactured to Kodak specifications in Japan. Video tape will be supplied by TDK and the equipment will be sourced from Matsushita.

"Our new Kodavision series 2000 video system marks the beginning of a new level of convenience in home video recording," noted Mr E. G. Woods, managing director and chief executive officer for Kodak (Australasia).

"The one-piece Kodavision camcorders are highly portable," Mr Woods added. "When compared with current camera and recorder hookups, their advantages become clear. Current 1/2" two-piece systems usually require the user to shoulder a camera that's wired to a separate recorder unit carried at waist level. The entire outfit may weigh 5 kg or more. But the smaller Kodak 8 mm video cassette (only slightly larger than an audio tape cassette) yields considerable advantages. It makes it possible to design a 2.2 kg cordless model with point-and-shoot convenience."

The new Kodavision series

2000 video system includes two 8 mm video camera-recorders; the Kodavision series 2000 camcorder, model 2200; and the auto focus camcorder, model 2400. The camcorders will accept 8 mm Kodak video cassettes.

The system's visual and audio capability is extremely high says Kodak. Both tapes have the capability of recording digital and/or FM hi-fidelity sound.

The camcorders share several common features. These include a fast f/1.2, 6:2 power zoom lens, a 1/3" Newvicon tube and a fully automatic white balance that adjusts the camera to shifts in colour temperature.

The cameras also feature a fast forward and fast reverse, a 5x visual search, and an electronic viewfinder (actually a miniature black-and-white television screen). A review feature lets the user replay the last four seconds of the most recent recording. Both cameras incorporate an automatic iris for automatic exposure control.

Both camcorders accept cassettes of either MP (metal particle) tape or a higher grade ME

(metal evaporated) tape. Both can record for up to 60 minutes on the PAL system, and Kodak anticipates that advances in high density tape technology will result in 8 mm cassettes with even longer playing times.

The Kodavision system's compact playback component, the series 2000 cradle, model 2020, allows users to play back recorded tapes.

The cradle was developed by engineers and designers from Kodak and the manufacturer. It is connected to the user's television. To play a tape, the user inserts the camcorder itself into the cradle. The camera's motor drives the tape. Circuitry within the cradle converts the signals recorded on the tape for television display.

The camcorder's battery is recharged while the camera is in the cradle. The cradle can also recharge a separate battery to extend the time the camcorder can be used.

The cradle is designed to include an optional Kodavision series 2000 tuner/timer, model 2022, a device that allows users to record television broadcasts. The cradle is designed to be compatible with existing 1/2" VCRs to facilitate dubbing 8 mm images onto 1/2" tape and vice versa.

The cable ready tuner/timer has 105-channel capability and offers 12 preset channel positions. It can be programmed to tape up to two programmes over any two-week period.

Kodak video cassettes for the home entertainment market will be sold in 1/2" width (in both Beta and VHS formats) and in various popular lengths, in regular and extra high grades.

Eastman 1/2" professional video cassettes are scheduled to be available around mid year in all popular formats and lengths, in high grade and extra high grade quality versions. Eastman 3/4" cassettes (in both professional and broadcast quality grades) will be available at the same time. Eastman broadcast quality tape will become available later this year.

For further information contact Kodak (Australasia) Pty Ltd, PO Box 90, Coburg Vic 3058. (03) 350-1222.

NEW AKAI VIDEO

Akai has announced a new addition to their video range for 1984, the VS-6EA.

The VS-6EA will join the VS-3EA and the stereo/Dolby VS-8EA in the Akai model range. Like the VS-8EA, the VS-6EA features two-speed recording and playback doubling the recording time of any video cassette. The long play mode gives up to eight hours recording (from a four hour tape). For improved picture quality at normal speed the VS-6EA has four heads, which produce a super-still picture on freeze frame, says Akai.

Akai claims that along with the VS-3EA and VS-8EA the new model has several exclusive features, including the 'can't miss' interactive monitor. The interactive monitor tells you exactly what to do by displaying operating instructions on your own television set. It tells you what buttons to press for unattended recording and even how much recording time you have left on the tape.

The timer allows you to programme the VS-6EA to record up to four programmes over a 28 day period. In case of power failure, there is an inbuilt battery that provides emergency power for up to three days for the tuner memory.

All of the functions of the video recorder can be operated with the 25 function wireless infrared remote control.

The VS-6EA has a front loading tape transport mechanism that enables it to be easily incorporated in an existing home entertainment system.

Other features include fast picture search to find a specific point on the video tape, 8-channel preset tuning and an electronic synthesizer tuning system which ensures that tuning is always accurate and stable, says Akai.

Further information can be obtained from Akai Australia Pty Ltd, PO Box 309, North Ryde NSW 2113. (02)887-2311.



SIMPLE-HIGH PERFORMANCE CD PLAYER FROM NAD

NAD's first digital Compact Disc player, the Model 5200, available from NAD retail dealers from January and priced in the mid-\$900 range, is a "second generation" CD player that employs newly developed LSI chips for its tracking and digital decoding functions.

Unlike CD players that are festooned with programming controls to provide automatic playback of recorder tracks in any randomly chosen order, the NAD 5200 is essentially a high-performance "manual turntable" for compact discs.

Its unusually simple, logical controls provide rapid access to any track; two-speed cueing in the slow-scan search mode (with audible output to facilitate precise cueing to any point within a

track) and the ability to advance or retard the laser's cue point in the music by increments as small as one second.

In view of its operating simplicity and the discs' near-immunity to fingerprints and handling damage, the 5200 is also an ideal record playing system for children.

The laser tracking and digital error-correction circuits in the NAD 5200 are particularly advanced. The standard CIRC (cross interleave) approach to error correction is augmented in the 5200 by a PLL frame-synchronizing circuit that eliminates data losses caused by timing jitter, NAD say.

It also includes a new logic processing circuit that analyzes bit error patterns, doubling the

system's capacity for error-correction both before and after signal de-interleaving. As a result, the 5200 securely tracks flawed discs that are unplayable on other, more costly CD players, claim NAD.

Special attention was paid to the design of the analogue output circuitry of the 5200 to ensure that no added noise, distortion or slew-rate limiting would compromise the purity of the playback sound. With its signal/noise ratio of nearly 100 dB, "... even the smallest details in the musical texture are heard against a background of velvety silence."

NAD equipment is distributed in Australia by **Falk Electro-sound, Rockdale NSW.**

DENON CD PLAYER

Denon engineers found that the digital to analogue conversion process was one crucial area when they looked for ways to improve the CD player. More features and functions were built in and it was made easier to operate. The result is the new DCD-1800.

One of the problems of D/A converters has been the generation of a distortion similar to crossover distortion in amplifiers. To remedy this, Denon developed the Super Linear Converter which they say drastically reduces the distortion and adds sweetness to high frequencies.

Tracking performance is improved too by the new Linear Drive Tracer system which uses a single high-precision pivot shaft instead of the conventional parallel rod system for greater overall stability. Search time is also reduced.

Denon claim a S/N ratio of 96 dB, dynamic range of 95 dB, distortion of 0.003% and wow and flutter so low it can't be measured.

The Australian distributors of Denon equipment in Australia is **Amalgamated Wireless (A/Asia) Ltd, 422 Lane Cove Rd, North Ryde NSW. (02)887-7111.**

VIDEO/AUDIO ACCESSORIES

GFS Electronic Imports of Mitcham Victoria has just announced the release of two new video/audio-related products from the factory of MFJ Enterprises, Mississippi, USA.

Both units are designed to be used in conjunction with a video recorder and stereo system to provide big theatre quality sound.

First in this new line is the model MFJ-1500 'room expanding audio enhancer'. It makes use of electronic time delay with feedback to simulate the reverberation of reflected sound normally experienced in a theatre.

The room expander connects directly to the audio jack of a VCR or TV. An auxiliary speaker on a stereo system is then connected to its output. Controls provided on the MFJ-1500 are *ambience*, for reverberation, *expand*, for time delay, volume and input.

To complement the MFJ-1500 is the new MFJ-1501 stereo syn-



thesizer. It produces a simulated stereo from the mono audio output of a TV or VCR.

The MFJ-1501 uses a sophisticated design to create a comb response that puts alternating 1 kHz bands of sound into the left and right channels of your stereo system. This technique is the same used by professional

audio engineers to produce simulated stereo LPs for the older mono recordings.

For further details of both the MFJ-1500 room expander and MFJ-1501 stereo synthesizer, contact the Australian distributors, **GFS Electronic Imports, 17 McKeon Road, Mitcham 3132 Vic. (03)873-3777.**

SANYO CAR SPEAKERS

Sanyo has announced the release of a new car speaker system — the FSP 401.

This compact unit is a single cone system with eight watts maximum power handling. It features a frequency response of 70Hz-10kHz and comes complete with a mounting baffle, wiring and instruments.

The FSP-401 is available from car stereo specialists, electrical retailers and department stores for around \$15.95.

For further information contact **Mr Wally Fabiszewski, Sanyo Australia Pty Ltd, 14 Mars Rd, Lane Cove NSW 2006. (02)428-0822.**

**WE'RE WELL
VERSED IN
VALUE VIDEO**
(SAY THAT QUICKLY!)

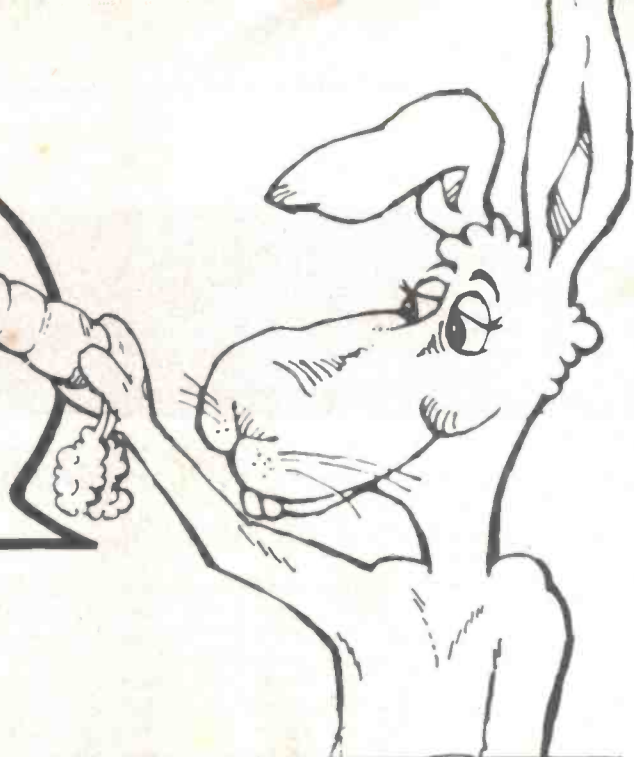

DON'T BUY JUST AN ENHANCER!



**The
DICK
SMITH
Video Processor**

Far more than JUST an enhancer! This incredible processor enhances, stabilizes, amplifies and modulates as well... Latest imported design is a boon when dubbing, restoring detail normally lost in the process. But it also includes a stabiliser for tapes with 'Copyguard' eliminating the often associated annoying rolling.

Plus it has a video distribution amplifier so you can feed up to 3 other recorders or monitors AND its in-built modulator allows you to watch the enhanced picture during playback on any ordinary TV (great for A/B comparison). Incredible? Wait until you try it: it's even better!
Cat Y-8510

WHAT A BUY!

\$129⁹⁵

Fantastic stereo sound from your mono video with this kit!

**Stereo
Simulator
Mk II**

Wish those old video movies had modern stereo sound? This low-cost gadget turns almost any mono signal into amazingly good synthetic stereo!
SEE EA APRIL 1983

\$19⁹⁵

Cat K-3421

EASY TO BUILD COMPLETE WITH INSTRUCTIONS



It's got everything!
**Video to
Video Cable**

Having trouble with video leads? No more! This incredible video lead pack will match ANY video to ANY video with its unique plug & socket system. Cat W-1287



\$19⁹⁵

Top quality,
top name
3 hour
**Video
Cassettes**

Huge bulk purchase of famous name video tapes allow this ridiculous price. Not those imported 'cheapies' which can do a lot of damage to your heads - these tapes are top quality!

VHS Polaroid Cat C-3410
BETA Agfa Cat C-3415

Polaroid
Video



**\$12⁵⁰
ea**

**BNC
to
BNC
Cable**

2 metres quality 75 ohm coax fitted with BNC plugs at each end. Suits many of the VCR's available. Why make one and risk shorts when it's already done for you? Cat W-1285

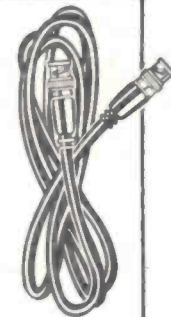

\$6⁹⁵
5 up... \$5.95

DICK SMITH Electronics
See page 93 for full address details.



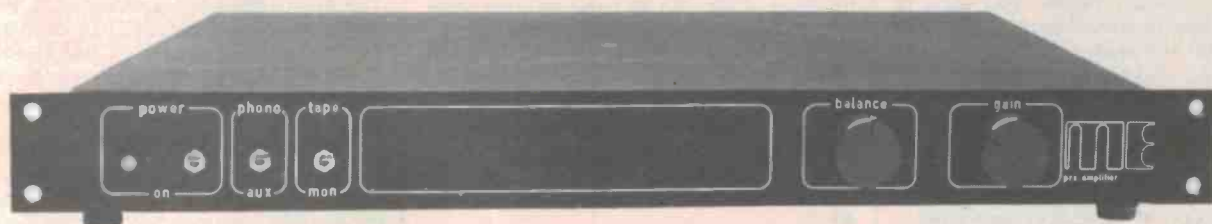

ME 15 preamplifier and ME 75 power amplifier

These Australian designed and manufactured amplifiers . . .
 "are very much like the best of the valve amplifiers which I, and
 many other audiophiles, grew to admire and accept" . . .

Louis Challis

I WAS PLEASSED when it was suggested that I review this equipment designed by ME Sound Pty Ltd because we don't often see Australian manufactured or designed equipment.

Contrary to the nasty rumours circulating in Canberra, Australian enterprise is still alive, and ME Sound is probably typical of that enterprise. The firm is young, virile, a trifle avant-garde, and knows about electronic technology.

Perhaps you may not have heard of ME Sound, or their predecessors, Modular Electronics. I must admit that, prior to conducting this review, neither had I. Their equipment is handled by only a very small number of retailers so unless you visited one of the retailers, or happen to know somebody who bought some of their equipment, your chances of seeing or hearing it would not be very great.

The trade literature which arrived with the amplifier and preamplifier was a trifle scanty. Surprisingly, there was no proper

handbook or circuit diagram with the equipment. However, the manufacturers did include a price list which will probably frighten all but the most intrepid audiophile into believing that this equipment is beyond his or her budget.

Each of the pieces of equipment came in its own solidly constructed pineboard packing case which the transport company had managed to cover with a brown treacle-like substance. Fortunately, the packing was good enough to ensure that the substance did not penetrate through to the equipment.

The appearance of the equipment did not provide the awe inspiring glitter and panache of the Marantz Esotec range or the functional and very practical characteristics of the New Zealand Perreaux range, both of which we have recently reviewed. ME Sound has chosen the stark and businesslike black colour to clothe their equipment which probably also helps with the thermal dissipation.

While ME Sound believes that 'black is

beautiful' the appearance of the equipment is not in any way avant-garde, even though it looks different.

ME 15 features

The preamplifier, in keeping with the Perreaux approach, does not incorporate tone controls and I must state that, in general terms, I support the stance of both ME Sound and Perreaux in this particular matter. The preamplifier's front panel, which is designed for rack mounting, has so few controls on it that you could well be forgiven for wondering why the designer has bothered to put the preamplifier into a separate package.

The controls consist of a power on/off switch, with its associated bezel light, a phono/auxiliary switch and a tape monitor switch, all located on the left-hand side of the panel. A balance control and a gain control are located at the right-hand side of the panel.

The preamplifier's back panel has a pair ▶



of gold-plated phono input sockets, a pair of sockets for auxiliary inputs, two pairs of sockets for tape input and output and a pair of sockets for the main signal output. The designers have also provided a universal terminal which supplies a 15 V signal to the main amplifier, as well as a DIN socket through which a separate power pack provides the main supply voltages for the preamplifier.

The concept of externally powering a preamplifier is not completely new as it does provide the designers with a possible means of reducing magnetic induction from the power transformer. In theory, this may make it possible to reduce hum and noise to a much lower level but this is, regrettably, achieved at a substantially higher manufacturing cost.

While it is possible that the mains hum leakage component in the voltage supplies may be effectively reduced by this approach, I have measured a sufficient number of competing units from other manufacturers to know that this particular approach is not the only way to achieve that aim.

The 15 V supply terminal on the back of the preamplifier provides a signal which switches the main amplifier from standby to a fully operational condition when the preamplifier is switched on. The power amplifier is claimed to operate in the Class 'AB' mode so it is obviously essential to reduce unnecessary power dissipation and consequently this feature must be included.

The inside of the preamplifier is not quite what I expected as it contains six printed circuit boards, four of which are major and two are minor. The minor ones are associ-

ated with the gain and balance controls at the front of the unit and also with the separate large and fancy-looking printed circuit board with large earthing strip for the interconnection of the coaxial connections on the rear panel.

ME 15 PREAMPLIFIER AND ME 75 POWER AMPLIFIER

ME 15
 Dimensions: 435 mm wide x 56 mm high x 300 mm deep.

Weight: 7 kg
 Price: \$695

ME 75
 Dimensions: 435 mm wide x 120 mm high x 370 mm deep.

Weight: 22 kg
 Price: \$1295

Manufacturer and Distributor: ME Sound Pty Ltd, c/- Post Office, Dyers Crossing NSW 2429. (065)50-2254.

The major printed circuit boards are for the twin balanced power supply, the high current output module and the moving magnet/phono preamplifier, together with its plug-in precision RIAA equalisation circuit. Each of these only occupy a small proportion of the available space inside the cabinet. The sixth printed circuit module is associated with the switching controls for power, phono/auxiliary and tape monitor circuits.

The unit is well made and neatly laid out, however, its cost seems a trifle higher than we would expect in terms of either the circuitry provided or based on the competitive prices from other suppliers.

ME 75 features

The main amplifier's appearance is, if anything, more avant-garde than that of the preamplifier. The designer has chosen to place the two large heat sinks on the front panel, instead of the sides or back as other designers do.

These heat sinks flank a pair of operating mode indication lights located at the centre of the panel. A red bezel light indicates that the amplifier is in the 'standby mode' while a green one shows that the amplifier is 'on' and operating normally.

Each of the heat sinks has twelve, 50 mm deep cooling fins extending across the full height of the panel. The external corners of the heat sinks are particularly sharp and, like the external corners of the front panel, are likely to leave a nasty scratch or cut if you happen to inadvertently come into contact with them.

I have criticised Jands for this fault, but they have learnt from their mistakes and their latest amplifiers no longer have this problem.

The back panel incorporates a line input socket on each side adjacent to two pairs of large, colour-coded universal output sockets. The panel also incorporates a yellow universal terminal for the amplifier's power activation circuit.

The only visible protection is a 2.5 A slow-blow line fuse which appears to provide the last line of defence for the amplifier protection.

Unlike the majority of amplifiers on the market, this unit features a Class 'AB' power output stage. This is one way to improve the linearity of the amplifier but only at the expense of considerable power dissipation.



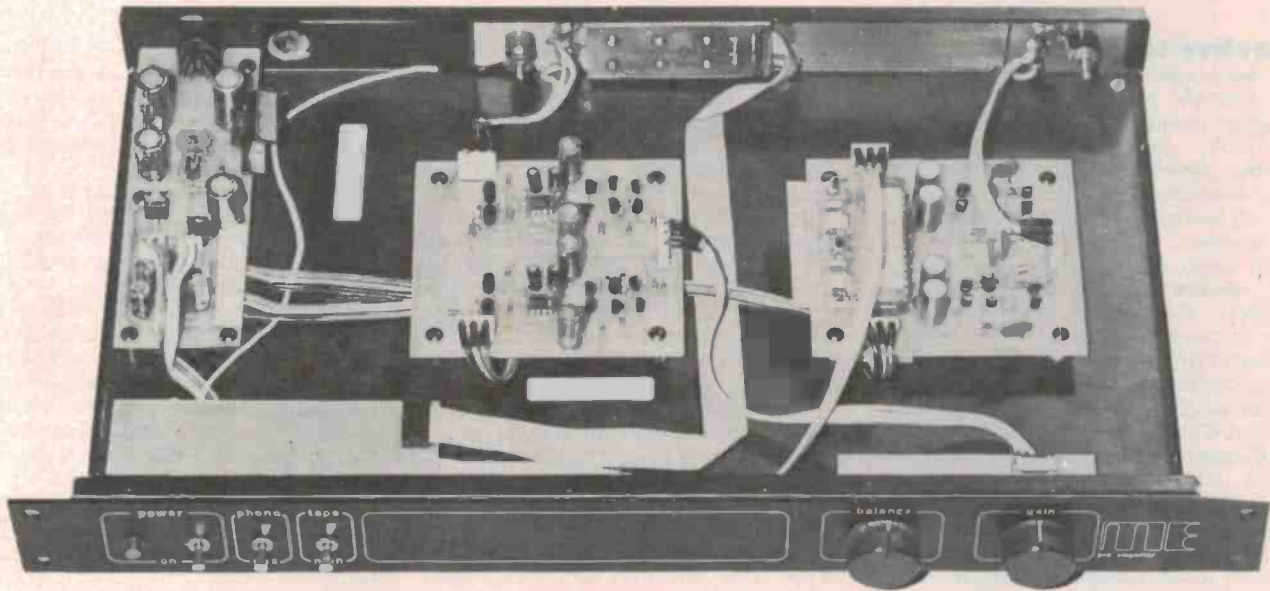

The result is lower power output and the need for a good cooling performance.

This is supplemented by a very unusual drive circuit in which the designers have chosen an even more unusual approach to negative feedback (See Figure 1). The stated purpose for this particular choice of circuitry is to reduce dynamic distortion.

As the figure shows they have divided the circuitry into two sections. The front section is the buffer amplifier in which sufficient feedback is provided to set the correct gain and overall sensitivity.

The second section incorporates the driver and output stages and these use the normal feedback of the emitter follower configuration. This has apparently been done to isolate the speaker from the internal feedback stages, particularly the capacitor and inductors normally required for the feedback loop.

These concepts are apparently based on a design feature proposed by Matti Otala who is renowned for a number of equally topical theories, many of which are currently the subject of heated debate in technical circles. Not surprisingly, some of the most heated debates on these theories have taken place in Australia where the members of the IREE audio group and the associated mem-

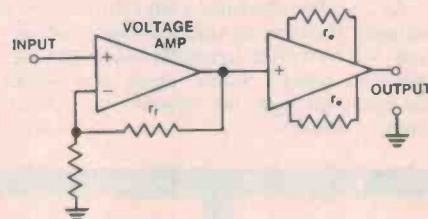

Figure 1. The ME power amplifier uses local compound emitter degeneration with only the front voltage amplifier operating with loop feedback.

bers of the Standards Association Committee TE/24 have strongly objected to the glaring inconsistencies in Otala's theories as well as some of his claims.

At a recent meeting of the Sydney branch of the Audio group of the IREE Professor Cherry provided a series of demonstrations which personally convinced me that some of Matti Otala's theories and many other generally held theories are quite specious.

The top panel of the amplifier is well ventilated and when the amplifier is operating (in the class 'AB' mode) the heat generated is enough to make you wonder whether a cooling fan might not have been a worthwhile addition.

The amplifier's internal construction was very different to any other amplifier that I have seen. The first major difference which catches your eye is the array of small electrolytic capacitors mounted on two printed circuit boards with their power rectifiers on each side of the large centrally mounted mains power transformer. The designers claim that this configuration achieves much lower impedances and much more stable rectification than the more conventional single large computer type capacitor which other designers have favoured.

The power amplifier circuit boards are located immediately behind the front external heat sinks and use a novel, but very practical, combination of heat sinks which double as mechanical bracketing. Each of the printed circuit boards uses a pair of side rails onto which the driver transistors are mounted and which enhance the rigidity of the boards and their resistance to external vibration.

The earth wires and signal wires have been designed using very large conductors which ensure minimum impedance over the operating frequency range. The amplifier appears to incorporate an output stage protection circuit although no details are provided as to how it works. ▶

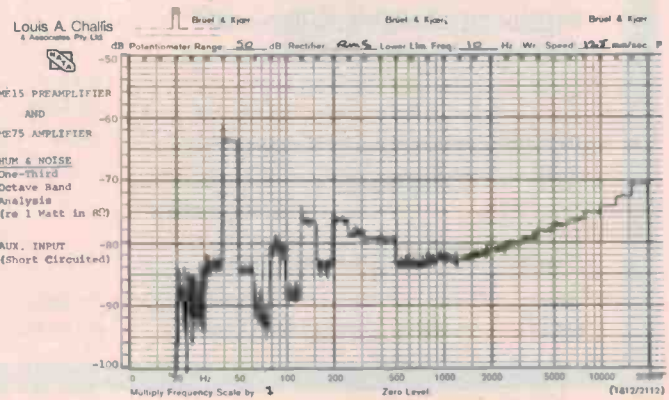
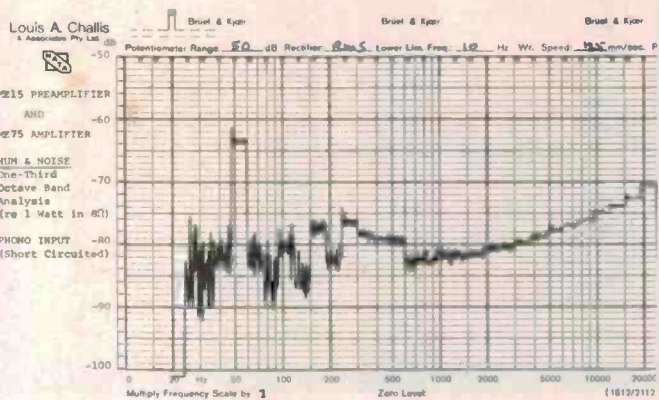

SOUND REVIEW

Objective testing

The claims made in the information supplied with the preamplifier and amplifier are quite exciting. All of the significant measurable and audible parameters including frequency response, total harmonic distortion, slew rate, output impedance, signal-to-noise ratio, audible quality, base response, sound definition as well as overall clarity are claimed to be substantially superior when compared to other amplifiers. Most of the other amplifiers, however, are generally less expensive than this particular unit.

The measured performance of the amplifier was not quite as exciting as I would have expected. The frequency response is exceptionally good extending from below 1 Hz to beyond 100 kHz with no sign of low frequency drooping response. This sounds good on paper, but if you happen to drop your cartridge on the platter the chances are that your speaker diaphragm and its voice coil are likely to jump right out of the speaker basket.

A better approach is to offer the user a variable low frequency cut-off setting which provides the ability to remove the low frequency wow and eccentricity information content on the records, as well as protecting the speaker from unwanted excursions.

At the one watt level with the preamplifier and amplifier both operating, the distortion at the three test frequencies of 100 Hz, 1 kHz and 6.3 kHz is moderately low in the range between 0.023% and 0.026%. At the 78 W level the distortion rises to between 0.06% and 0.13%.

However, before you get carried away and start pounding the table or phoning me to complain about the 'high' level of the distortion, I should point out that this level of performance is still reasonably good when you consider that the amplifier does not incorporate a feedback loop connecting the output stage directly back to the input.

The design has been conceived to specifically avoid that requirement, in the interest of achieving a stated set of audible goals. By the same token, these figures are in no way comparable with the better or best amplifiers that we have reviewed in the last few years whose distortion figures, under similar operating conditions, have been as much as three orders of magnitude better than the figures displayed by this system.

As the manufacturer's literature gives a warning about using suitable mains connections we tested the amplifier twice, the second time using a mains supply which does not come through our normal core balance circuit breakers.

We found it interesting that this produced no substantial reduction in the measured level of harmonic distortion; we were convinced that the characteristics of the amplifier are not significantly affected by the choice of mains circuitry.

Obviously, if the amplifier is to achieve the sort of performance that the designers are seeking then the measured 'IEC high frequency total difference frequency distortion' performance should be comparable with the best amplifiers that we have tested.

Surprisingly, this is not the case and the measured performance is not as good as we might have expected. The lowest level of total difference distortion was only 0.08% which is more than 10 times higher than that produced by other amplifiers that we have recently tested.

An equally significant set of parameters is the signal-to-noise ratio. The measured performance for both the auxiliary inputs and the phono inputs only achieves a 60.5 dB signal-to-noise ratio and 67 dB A-weighted performance relative to the one watt level.

An examination of the one-third octave band spectrum reveals a very high level of 50 Hz signal; this is hard to justify after all the trouble the designer has taken with external power transformers for the preamplifier and with the fancy power supply ▶

AMPLIFIER DATA SHEET

MEASURED PERFORMANCE OF ME 15 PREAMPLIFIER NO. 105011X

AND ME 75 POWER AMPLIFIER NO. 750001X

FREQUENCY RESPONSE: (-3 dB re 1 watt @ 1 kHz)

No Tone Controls Fitted 1.0 Hz to 100 kHz

SENSITIVITY: (for 1 watt in 8 ohms)

	Left	Right
AUX	6.4 mV	6.4 mV
TAPE	6.4 mV	6.4 mV
PHONO	140 uV	140 uV
OVERLOAD PHONO	210 mV	210 mV

INPUT IMPEDANCE: (@ 1 kHz)

	Left	Right
AUX	68 k ohm	68 k ohm
TAPE	68 k ohm	68 k ohm
PHONO	47 k ohm	47 k ohm

MAXIMUM OUTPUT POWER AT CLIPPING POINT

(IHF-A-202 (20ms burst repeated at 500ms intervals))

	84 V p-p
	= 110 Watts
Therefore Dynamic Headroom (re 78 watts)	= 1.5 dB

OUTPUT IMPEDANCE (@ 1 kHz)

405 milliohms

HUM AND NOISE LEVELS (re 1 watt in 8 ohms)

INPUT	0.5V	AUX.	60.5 dB (LIn.)	67.0 dB(A)
INPUT	5.0mV	PHONO m/m	60.0 dB (LIn)	66.5 dB(A)

HARMONIC DISTORTION:

(A) (At power of 1 watt into 8 ohms)

	100Hz	1kHz	6.3kHz
2nd	-79.4	-77.4	-76.3 dB
3rd	-72.4	-74.4	-74.2 dB
4th	-91.4	-	- dB
5th	-91.4	-	- dB
THD.	0.026	0.023	0.025 %
=dB	-71.7	-72.6	-72.1 dB

(B) (At rated power of 78 watts into 8 ohms = 25 volts)

	100Hz	1kHz	6.3kHz
2nd	-66.3	-69.1	-68.0 dB
3rd	-59.6	-72.4	-62.0 dB
4th	-73.2	-75.1	-75.7 dB
5th	-65.3	-68.4	-
THD.	0.13	0.06	0.09 %
=dB	-57.8	-64.5	-60.9 dB

(b) Direct to ME75 Amplifier (78 watts)
(Signal generator not earthed) Right Channel

	1kHz	
2nd	-72.4	dB
3rd	-62.5	dB
4th	-75.1	dB
5th	-68.2	dB
THD.	0.09	%
=dB	-61.0	dB

As above supply from Alternative Plug

	1kHz	
2nd	-72.4	dB
3rd	-58.5	dB
4th	-75.1	dB
5th	-64.6	dB
THD.	0.14	%
=dB	-57.3	dB

DISTURB THE PEACE.



We're not suggesting you actually break the law, but aren't you a bit sick of the wimpy sound of most of today's car stereos? You shouldn't need a power booster to let everyone know what great musical taste you have.

Introducing Pioneer's new top of the range in-dash AM/FM Radio/Cassette, the KEH 9000, with peak power of a brain rattling 20 watts per channel.

With locking fast forward and rewind. With auto reverse and automatic 'Tape Slack Canceller' to keep things rolling smoothly, preventing tape 'chew and spew' and protecting your valuable tape collection. With quartz 'Phase Lock Looped' synthesiser tuning for perfect FM reception; no more signal drift. With 15 station pre-sets and night-illuminated controls, including a digital frequency display - all in a logical layout that's as functional as it is beautiful.

The KEH 9000 has a built-in 5-band graphic and a 'Key-Off Pinchroller' to eliminate tape damage. Plus Dolby®, metal capability and much, much more.

And it's only one of 5 sophisticated, totally new systems from Pioneer.

The KEH 9000 is as crystal clear as it is powerful.

But it's only as legal as you want it to be.

Dolby® is a trademark of Dolby Laboratories.

PIONEER

Leads the world in Sound and Vision.

PIC 0053

ME Sound Pty Ltd design philosophy

This information, supplied to us at our request, is a precis of Peter Stein's handwritten notes.

Peter Stein, Managing Director, ME Sound Pty Ltd

High current output. For the ME 75 power amplifier to effortlessly drive any commercially designed loudspeaker system it must be able to deliver sufficient current to the loudspeaker when load conditions demand it. The ME 75 is capable of delivering 40 amps, measured at 20% duty cycle pulse, into an appropriate high power load.

Power supply. To supply the amplifier modules with the necessary power an unusual array of low inductance capacitors are connected in parallel. The power transformer is designed to supply large instantaneous power levels in excess of that available at the average power outlet. The losses within the transformer are of the same order of magnitude as the IR losses in the normal household wiring system.

The supplies are independent and no crosstalk is possible, other than by modulation of the mains voltage due to excessive power demands and this only manifests itself at 100 Hz with no effect on imaging since directional information occurs above 200 Hz.

High temperature performance. Dynamic performance is the prime criteria by which the design of ME products has evolved, rather than steady state or static performance. A significant contributor in the area of ME amplifier dynamics is the near constant operating temperature of the output devices.

When a bipolar transistor becomes hot its gain, bandwidth and transient distortion improve markedly, hence the ME 75 has a large constant current

heating the output devices to a temperature of 70°C. This current also ensures a low distortion at low levels since the amplifier effectively operates in a Class 'A' mode.

Thermal cycling and its related distortion products are avoided since the transistor junction is already hot, rather than being heated from cold as happens when transistors are intentionally kept as cool as possible.

ME Sound has often looked at MOSFETs as possible output devices but they have two serious problems; their distortion products are then ten times that of a bipolar device, hence ten times the negative feedback is necessary to equal bipolar amplifier designs, and they have a negative temperature coefficient. As MOSFETs heat up the gain decreases and the dynamic range is compressed.

Symmetrical balanced top. ME amplifiers are designed to clip gracefully with a rounded waveform (low order harmonics at the corners), ensuring an inoffensive excursion into overdrive.

It is also important to have a design which does not 'latch up' and here we have utilised a symmetrical topology with equal positive and negative slew rates and settling times. This has another benefit of maintaining very low distortion products by cancelling distortion generated by a 'mirror' effect within the circuitry.

The devices used in the circuitry are hand selected to vanishingly close tolerances; 1% metal film resistors,

0.05% wire wound power resistors, matched sets of semiconductors and hand selected capacitors.

Servo system. In keeping with our philosophy of simple signal processing, a separate servo system monitors and maintains the dc output level at 0 ± 0.001 volts max. rather than over-complicating the circuit design trying to maintain dc stability.

Remote sensing protection system. This monitors the output of the amplifier and operates once a signal is detected which is likely to damage your loudspeaker.

This style of protection offers a significant advantage as there are no series fuses or relay contacts to detract or interfere with the signal between the circuitry and the loudspeakers. This is the usual practice and these effects increase with age.

The turn-on and turn-off surges which appear at the loudspeaker terminals are inaudible, being less than 0.05 V peak.

A significant fact is that the muting relay used in conventional power amplifiers cannot protect against loudspeaker damage. This is due to a common amplifier failure mode, dc at the output terminals, which invariably equals the full internal dc supply voltage (in a 100 W amp 50 Vdc). This causes the relay contacts to weld together, then vapourises the voice coil of the bass driver.

Therefore, the ME protection network removes the ac mains power from

the amplifier, making it more reliable. **No negative feedback.** The ME amplifiers do not use a negative feedback loop for the output, driver and pre-driver transistors, instead, compound emitter degeneration is used with only the front voltage amplifier operating with loop feedback, however, this stage drives the purely resistive power amplifier section.

The system avoids the possibility of loudspeaker effects entering the feedback loop and regenerating throughout the amplifier chain causing 'interface intermodulation distortion', a term used by Matti Ojala. The back EMF generated by all dynamic loads can re-enter a conventional amplifier but is isolated by the separate current amplifier embodied in ME amplifiers.

Another advantage of this design is the absence of an output inductor; instability is not a problem and so the circuit can be hard-wired to the loudspeaker, a real benefit when you are talking about esoteric speaker cables of extremely low losses.

Servicing and updating. The modules are easily unplugged and exchanged. This allows the units to be serviced in remote locations while maintaining factory tolerances, as whenever a failure occurs a matched set of factory manufactured modules are fitted.

It also makes it easy to upgrade the old modules to new modules. This system is more economical as you don't have to buy a whole new amplifier.

Updating your hi-fi system? Start with the weakest link.

If your hi-fi system has a weak link, it is most probably the loudspeakers.

If you are about to spend between \$400 and \$1500 on a new pair of speakers, you will make a costly mistake if you don't first audition the JAMO Professional range before you buy.

JAMO is a specialized loudspeaker designer. Their new thinking and unique way to solve problems is obvious. Hi-fi critics worldwide have reviewed and acclaimed the speakers. JAMO incorporate the patented CBR-system (Centre Bass Reflex). It eliminates cabinet resonances found in most traditional speakers. It gives you a tight and uncoloured bass response.

With JAMO Professional you will also get excellent sensitivity, unsurpassed stereo image and phase linearity. You will get fully electronic overload protection and acoustic attenuators. And a speaker which is well suited to digital audio. But you won't get empty pockets . . .

If you give us a ring or send us a letter with your name and address, we will send you our new '84 catalog, a pricelist, a couple of reviews and the name of your nearest JAMO dealer.

Scan Audio Pty. Ltd., Phone: (03) 819 5352
P.O. Box 242, Hawthorn, Vic. 3122



JAMO HI-FI

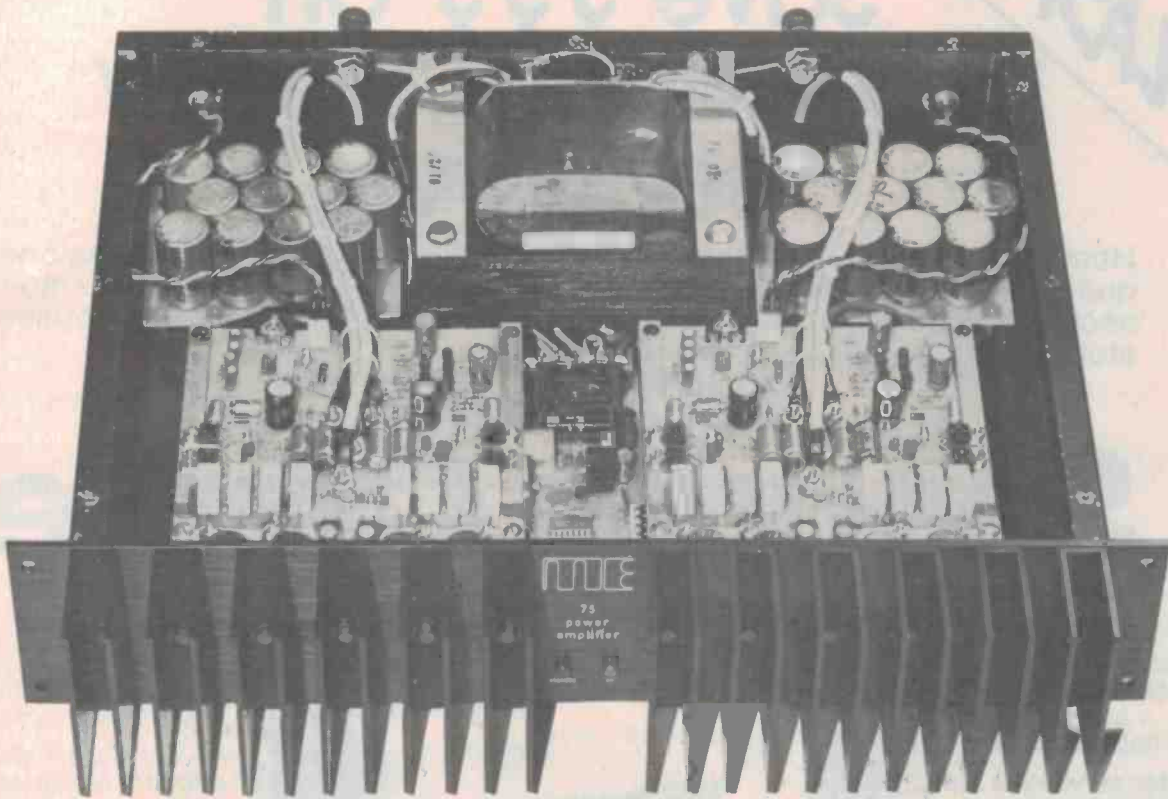

IEC HIGH FREQUENCY TOTAL DIFFERENCE FREQUENCY DISTORTION
ME 75 POWER AMPLIFIER

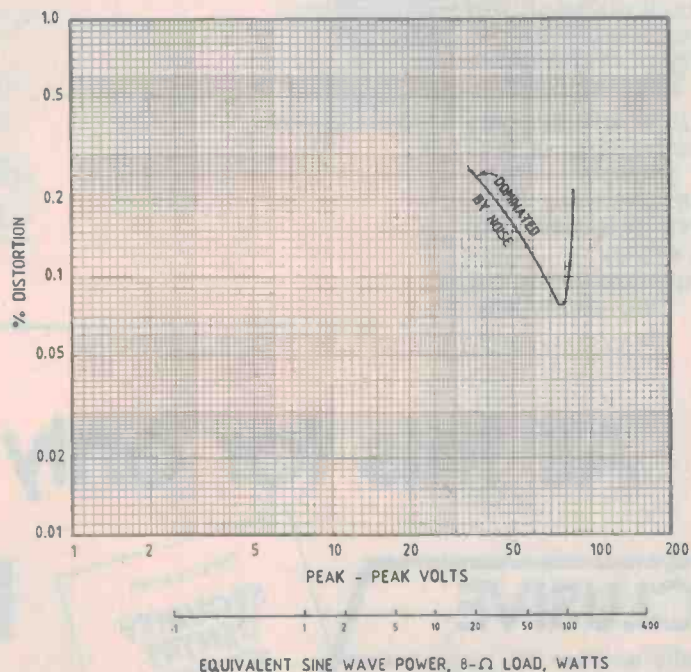

which incorporates so many capacitors at the back of the amplifier.

The preamplifier sensitivities are, however, relatively good with a $14 \mu\text{V}$ phono sensitivity and a 210 mV signal required to cause preamplifier overload.

The measurements of maximum output power using the IHF-A-202 test reveals a 110 W peak output into 8 ohms with 1.5 dB headroom. These figures do not match the claims made for the amplifier of 120 W output into 8 ohms. Neither does the peak current match the claimed 40 A peak current capability for single transient peaks.

The test of overload resistance based on our standard overload recovery performance was particularly stable and the unit exhibited no trace of jitter.

The output impedance is relatively high at 405 milliohms but the unit does not appear to exhibit any significant operational vices.

Subjective testing

The subjective assessment of the unit revealed characteristics that are a little different from what I would have expected. The audible characteristics are very much like the best of the valve amplifiers which I, and many other audiophiles, grew to admire and accept as offering better performance than the first transistorised amplifiers which sounded relatively harsh in comparison.

The quality of the sound is unquestionably different to other high quality amplifiers available at the moment. I found this

amplifier particularly pleasant to listen to as it exhibits characteristics which are audibly different, particularly on transient material.

When playing classical music and pop the amplifier works very well, but with recommended retail prices of \$695 for the pream-

plifier and \$1295 for the amplifier I can't see too many people beating a path to the retailers' door.

Australian enterprise may not be dead but only rich Australians will ever get to hear this particular equipment. ●

AT LAST!

Save \$\$\$\$ on professional quality security!

Homes... offices... factories... now you too can have a fully professional quality security system at a fraction of the price you'd expect. Yes: a multi sector, multi function alarm system as used in banks, offices, warehouses, stores, etc. can be yours with the all-new

DICK SMITH Security Centre

- Window shows all sector status by LED indicators: you can tell at a glance what's happening where!
- Sector sensing is anti-tamper 'resistive' type — if any sector is bridged or cut, the alarm will be activated.
- Inbuilt mains power supply with provision for either dry or rechargeable back-up battery.
- Uses virtually any standard N/O or N/C sensors — (reed switches, pressure mats, microwave detectors, trip wires, etc.etc.)... huge range available from us and elsewhere.

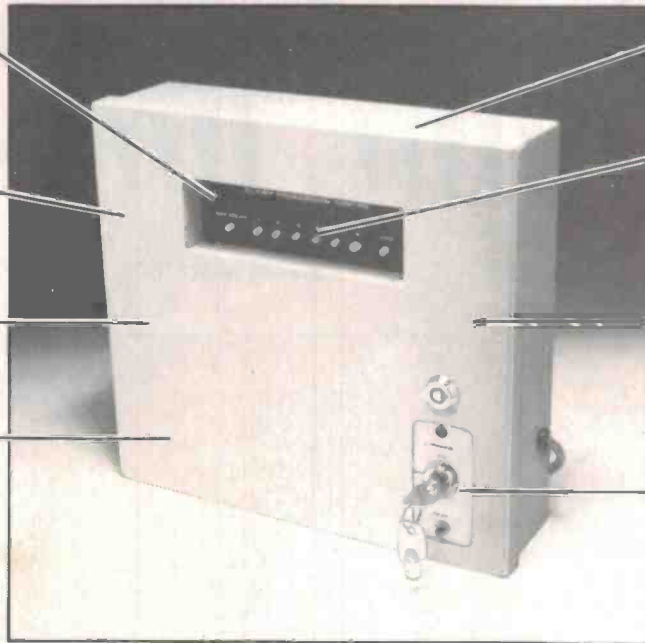

- Alarm circuitry is housed in high quality steel case fitted with anti-tamper switches.
- Very latest alarm circuitry featuring six individually controlled sectors, each capable of instant or delayed alarm or complete isolation.
- Instantaneous fire/panic circuit inbuilt, along with testing facilities and entry, exit and alarm delay adjustments.
- Twin lock system — security keys control both on/off and access to system.

Cat L-5100

All this for only \$199

EXCLUSIVE
Especially written 16 page installation/instruction manual: any handyman could install this system — and you'll know you've saved hundreds of dollars doing it yourself!



ONLY FROM
DICK SMITH Electronics

See Page 93 for full address details



A711/RW

OPENING THIS MONTH IN BRIGHTON (VIC.)

STORE LOCATIONS

NSW	Cnr. Swift & Young Sts. Parramatta Rd & Melton St T55 Terrace Level 613 Princes Hwy Oxford & Adelaide Sts 531 Pittwater Rd 147 Hume Hwy 162 Pacific Hwy 315 Mann St 4 Florence St Elizabeth Dr & Bathurst St 173 Maitland Rd Lane Cove & Waterloo Rds George & Smith Sts The Gateway, High & Henry Sts 818 George St 6 Bridge St 125 York St Tamworth Acde & Kable Ave 263 Keira St	ALBURY AUBURN BANKSTOWN SQ BLAKEHURST BONDI JCT BROOKVALE CHULLORA GORE HILL GOSFORD HORNSBY LIVERPOOL NEWCASTLE NORTH RYDE PARRAMATTA PENRITH RAILWAY SQ SYDNEY SYDNEY TAMWORTH WOLLONGONG FYSHWICK	21 8399 648 0558 707 4888 546 7744 387 1444 93 0441 642 8922 439 5311 25 0235 477 6633 600 9888 61 1896 88 3855 689 2188 32 3400 211 3777 27 5051 267 9111 66 1961 28 3800 80 4944
ACT	Creswick Rd & Webster St	BALLARAT	31 5433
VIC	Cnr Hawthorn Rd & Nepean Hwy 260 Sydney Rd Nepean Hwy & Ross Smith Ave 205 Melbourne Rd 399 Lonsdale St Bridge Rd & The Boulevarde Springvale & Dandenong Rds	BRIGHTON COBURG FRANKSTON GEELOGNE MELBOURNE RICHMOND SPRINGVALE	592 2677 383 4455 783 9144 78 6766 67 9834 428 1614 547 0522
QLD	293 Adelaide St 166 Logan Rd Gympie & Hamilton Rds Cnr Gold Coast Hwy & Welch St Bowen & Ruthven Sts Ingham Rd & Cowley St. West End	BRISBANE BURANDA CHERMESIDE SOUTHPORT TOOWOOMBA TOWNSVILLE	229 9377 391 6233 359 6255 32 9033 38 4300 72 5722
SA	Wright & Market Sts Main South & Flagstaff Rds Main North Rd & Darlington St	ADELAIDE DARLINGTON ENFIELD	212 1962 298 8977 260 6088
WA	Wharf St & Albany Hwy William St & Robinson Ave Centreway Acde, Hay St	CANNINGTON PERTH PERTH	451 8666 328 6944 321 4357
TAS	25 Barrack St	HOBART	31 0800
NT	17 Stuart Hwy	STUART PARK	TBA



**CNR.
HAWTHORN RD.,
& NEPEAN HWY.
BRIGHTON**

**WATCH YOUR LOCAL PAPER
FOR DETAILS
OPENING SOON IN BENDIGO,
& DARWIN NT.**



STORE HOURS

All Dick Smith stores are open for trading during the normal trading hours for their particular area (either 9 - 5.30 or 8.30 - 5). Many stores are also open for late night trading. Please ring the store concerned for their particular hours.



Terms available to approved applicants through...



MAJOR RESELLERS

● Atherton Qld: Mawter's Music Centre, 55 Main St 91 1208 ● Ballina NSW: A. Cummings & Co 91-93 River St 86 2285 ● Broken Hill NSW: Hobbies & Electronics, 37 Oxide St. 88 4098 ● Cairns Qld: Electronic World Shop 27 K-Mart, Westcourt Plaza, Mulgrave Rd 51 8555 ● Cairns Qld: Thompson Instrument Services, 79-81 McLeod St 51 2404 ● Campbelltown NSW: Fishers' Chip Shop, Shop 3, 274-276 Queen St 27 1475 ● Coffs Harbour NSW: Coffs Harbour Electronics, 3 Coffs Plaza, Park Ave 52 5684 ● Darwin NT: Ventronics, 24-26 Cavanagh St 81 3491 ● Danilquin NSW: Deni Electronics, 220 Cressy St 81 3672 ● East Maitland NSW: East Maitland Electronics 99 High St 33 7327 ● Echuca Vic: Webster Electronics 220 Pakenham St ● Geraldton WA: KB Electronics & Manne, 361 Main Terrace 21 2176 ● Gladstone Qld: Purely Electronics Shop 2 Cnr Herbert & Auckland St 72 4321 ● Gosford NSW: Tomorrows Electronics & Hi-Fi 68 William St 24 7246 ● Inverell NSW: Lyn Willing TV 22A Evans St 22 1821 ● Kingston Tas: Kingston Electronics Channel Court 29 6082 ● Launceston Tas: Advanced Electronics 5A The Quadrant 31 7075 ● Lismore NSW: Decro Electronics 3A/6-18 Carrington St 21 4137 ● Mackay Qld: Stevens Electronics 42 Victoria St 51 1723 ● Maryborough Qld: Keller Electronics 218 Adelaide St 21 4559 ● Morwell Vic: Morwell Electronics 95 George St 34 6133 ● Mt Gambier SA: Hutchesson's Comm 5 Elizabeth St 25 6404 ● Mildura Vic: McWilliams Electronics 173 Summer St 62 6491 ● Port Macquarie NSW: Hall of Electronics 73 Horton St 83 7440 ● Rockhampton Qld: Purely Electronics 15 East St 21 058 ● Shepparton Vic: G.V. Electronics Centre 189B Cox St 21 8866 ● Toowoomba Qld: Hunt's Electronics 18 Neil St 32 9677 ● Townsville Qld: Tropical TV 49 Fulham Rd, Vincent Village 79 1421 ● Wagga NSW: Wagga Wholesale Electronics 89 Forsyth St ● Whyalla SA: Mellor Enterprises Shop 2 Forsyth St 45 4764

SPEEDY PHONE/BANKCARD ORDER SERVICE

Just phone your order and Bankcard details - it's so simple!

(02) 888 2105
ORDER ONLY ON THIS NUMBER
ENQUIRIES: (02) 888 3200



**HEAD OFFICE AND MAIL ORDER CENTER:
P.O. Box 321, NORTH RYDE, NSW 2113.
TEL. (02) 888 3200**

POST & PACKING CHARGES		CHARGE	
ORDER VALUE	CHARGE	ORDER VALUE	CHARGE
\$5.00 - \$9.99	\$2.00	\$50.00 - \$99.99	\$5.00
\$10.00 - \$24.99	\$3.00	\$100.00 or more	\$6.50
\$25.00 - \$49.99	\$4.00		

Charges are for goods sent by post in Australia only - not airmail, overseas or air freight.

Dear Customers,

Quite often, the products we advertise are so popular they run out within a few days. Or unforeseen circumstances might hold up shipments so that advertised lines are not in the stores by the time the advert appears. And very occasionally, an error might slip through our checks and appear in the advert (after all, we're human too!). Please don't blame the store manager or staff - they cannot solve a dock strike on the other side of the world, nor is an error that's appeared in print. If you're about to drive across town to pick up an advertised line, why not play it safe and give them a call first - just in case!

Dick Smith & Staff

CONSIDER THE ADVANTAGES OF SHOPPING BY MAIL ORDER...

* Lightning Fast Service - our fully computerised mail order centre will have your goods speeding back to you within 24 hours of receipt - maximum! (Normally, they're even quicker!)

* Special 14 day Satisfaction Guarantee - our normal 7 day Satisfaction Guarantee is extended to 14 days for mail order customers: If you're not absolutely delighted, return your purchase within 14 days (in original condition) for a full refund. What can you lose?

* New products, mail-order-only specials, etc: as a mail order customer, you'll receive up to 6 bargain packed mailers per year AND, from time to time,

special offers for mail order customers only (not even available from our stores!)

* Above all, our 15 years of reliable mail order experience. You know when you send us an order we'll be around to serve you: some mail order companies have given the industry a bad name, but Dick Smith Electronics sets the high standards others try to match. You can trust Dick Smith Electronics.



DICK SMITH Electronics

at the leading edge

3" COMPACT FLOPPY GRABS LEAD IN STANDARDS RACE

Chinon Industries of Japan recently joined the ranks of companies supporting the \mathcal{C} -standard. This compact 250KB (500KB in floppy mode) storage unit features low power consumption and 5¼" compatible operation. Chinon's CFO31 has a 3ms track-to-track access time and uses standard Compact Floppy media. Schools and remote recording applications will benefit from the rigid jacket and dust protection features of Compact Floppy disks.

GENERAL INSTRUMENTS' SPEECH RECOGNITION CHIP SPEAKS FOR ITSELF

Claimed to be the only real-time linear-predictive-coding-analysis chip on the market, this chip, when teamed with a micro-processor, manages both recognition and synthesis with just one reconfigurable filter. Known as the SP1000, the combo chip will work with most micro-processors and will also work with no hardware interface with the 6502 device.

WESTERN DIGITAL CORP. RIDES THE IEEE STD 488 BUS

A general purpose interface bus (GPIB) controller performs the interface function between the micro-processor and the GPIB. Western Digital's WD9914 is a second source for TI's TMS9914A. The chip automatically handles talker, listener and controller operational modes, relieving the micro-processor from bus protocol maintenance. The WD9914 features system controller service request, serial/parallel polling device, clear trigger and DMA facilities. Look for this one early 1984.

IBM® PC STYLE KEYBOARDS TO TRUE DIN PROFILE

Advanced Input Devices' packaged and encoded keyboard features ergonomically designed tactile feel keys and comes complete with curly cord. Measuring a mere 30mm in height to the home row of keys, the Ergokey Tm ED-184-243 also incorporates a two position angle adjuster. This keyboard is the vanguard for the Ergokey Tm series and is predicted to cost less than \$200 plus tax in small quantities.

daneva australia Pty Ltd

66 Bay Rd., Sandringham, Vic. 3191
P.O. Box 114, Sandringham, Vic. 3191
Telephone: 598-5622 Telex: AA344939

Sydney: (02) E&M Electronics 51-5880
Adelaide: (08) DC Electronics 223-6946
Perth: (09) Micro Controls 445-2544
Brisbane: (07) Ballec 369-5900



BATTLE FOR DESKTOP REAL ESTATE

The new year saw the beginning of the battle for domination of the desktop — suddenly all the computer manufacturers woke up to the importance of making a machine that any executive would be proud to have on his or her desk. In fact, the companies went further than that; they came out with some wizard little machines calculated to make any executive who doesn't have one look rather warily over the shoulder.

The computers in question all went for compactness combined with power; gone are the days when having a computer on your desk means there's no room to do anything else.

Of the many new releases, five machines stood out as likely to make the grade: the Apple Macintosh; the HP-150 with its touch screen; the Apricot; the Eagle; and the MIC-504 from Multitech.

The Apple Macintosh is possibly Apple's last chance to retain its high position in the marketplace. The Lisa was a revolutionary machine with many useful features, but it was just too expensive for most people, especially in small businesses, to invest in.

While there's no Australian price available for the Macintosh at the time of going to press, its US price is expected to be between \$2000 and \$3000 which, even when translated into Aussie dollars with a hefty

import tax added, works out a lot cheaper than the Lisa.

For this reduction in price, however, you don't lose much power or capability. A Motorola MC68000 processor running at 8 MHz has 64K ROM and 128K RAM, with the memory upgradeable to 512K, and a second microfloppy disk drive may be added.

The Macintosh retains the Lisa's mouse/icon arrangement of operation, which makes it a cinch for even the most ignorant computer novice to work with. For example, when the Macintosh is switched on it displays a floppy disk on the screen as an icon. By clicking the mouse on the icon, the user opens the disk to reveal a window showing more icons for the various files and folders on the disk ('folders' are directories containing other files).

Moving the mouse to one of these folders and clicking twice will open the file and invoke the



The HP-150. "Ta-ta-ta-touch me, I wanna be dirty".

appropriate applications program to display it — all without the user having to know what is happening in computing terms.

Four applications for the Macintosh will initially be available: MacWrite, a word processor; MacPaint, a drawing program; and MacPlan and MacChart, which are spreadsheet and graphing programs (respectively) from Microsoft.

The Macintosh is an unusual shape for a personal computer, taking up more space vertically than horizontally; ideal for minimising the space needed for it on a desktop.

Hewlett-Packard's HP-150 has two things going for it: its incredibly small size and its touch-sensitive screen. Its 305 mm footprint makes sure it won't dominate the desktop, but the basic unit still manages to contain 256K of memory, two serial I/O ports, an HP-IB interface, a screen — and room for an optional printer. To add to this machine's appeal, it uses an 8088 processor and the popular MS-DOS operating system.

The 23 cm screen is a very high-quality green phosphor type, with a resolution of 512 by 390 for graphics and 720 by 378 for alphanumeric display. Both can be displayed at the same time, and this is how many of the

touch screen graphics work.

The touch-sensitive screen is what it sounds like; the user can make things happen simply by pointing to areas on the screen. 'Touch screen', in fact, is not strictly accurate. HP Touch consists of a grid of infrared light beams just in front of the screen.

The 14 horizontal by 21 vertical beams define a 23 by 40 grid on the text screen and set of eight programmable function keys along the bottom of the screen. When you point to and/or touch the screen you break at least one vertical and one horizontal beam, which returns a code to the system indicating what part of the screen is being pointed to.

How this information is used depends on the software, but it means that areas of the screen can be defined in menu form, and the user need only point to the appropriate area of the screen to make a selection.

VisiCalc and WordStar are available for the HP-150, and such popular packages as Lotus 1-2-3, dBase II, Multiplan and Condor are promised for the near future. All the software runs under HP's 'Personal Applications Manager' (PAM), which forms a user-friendly bridge between the operating system and the user. ▶

The Apple Macintosh. Man or mouse control?



The Eagle PC Plus is available in configurations with either floppy or hard disks (retailing for \$3840 with one floppy drive, \$4580 with two, and \$7380 with 10M hard disk storage), and is claimed by its distributors, Asia/Pacific Technology marketing Pty Ltd (ATM), to be fully compatible with the IBM-PC and XT.

The Eagle was specifically designed for desktop use, and offers an 'enhanced' IBM keyboard with 84 keys, 10 function keys and a 10-key numeric pad.

Powered by a 16-bit Intel 8088 microprocessor, the Eagle has as standard 128K RAM, expandable to 640K on the main CPU board without adding extra pc boards. The design accommodates both 64K and 256K dynamic RAMs, and all models have four IBM-PC compatible option slots. There are also two serial and one parallel ports for printer, modem or mouse connection.

intricacies of computer operating systems".

The Apricot comes standard with one microfloppy drive, a 23 cm screen monitor and the new 'microscreen' with a liquid crystal display which, with its six associated touch-sensitive keys, provides dynamic choice of operation within each application program, acts as a window on the screen, allowing the system to be used without a monitor if necessary, displays the day, date and time whenever required, and acts as a calculator without necessitating an exit from the main computer system.

A second drive is incorporated in the basic unit, making expansion simple, and the whole package is an extremely compact, elegant desktop design.

The system comes with three operating systems (MS-DOS II, CP/M-86 Plus and Concurrent CP/M-86), a full range of utilities, System Manager, Digital Research's GSX Graphics, asyn-



The Apricot. Fruitful for Barson?

Multitech's MIC-504, distributed in Australia by Emona, is a single-board, Z80A-based computer with 4K ROM, 64K RAM and 2M of storage provided by two 5.25 inch floppy drives. It has two full-duplex RS232 serial ports with baud rates programmable from 110 baud to 19.2 kilobaud, as well as one Centronics parallel port.

The Z80A processor provides access to the large library of CP/M 2.2 applications programs, but the MIC-504 comes with a fully documented software pack-

age comprising Word Right, a word processor; Spell Right, a user-expandable 20 000-word dictionary; Magic Worksheet, a spreadsheet program; Qsort, a sorting utility; Analyst, a database management system; and NAD, a name and address file with Word Right merge facilities.

So there are the contenders for the top position on desktops throughout the world. It'll be interesting to look back in a year's time and see which machines have made it to the top. ●



The Eagle . . . they fly high in Mobile.

The Eagle PC Plus runs under both MS-DOS and CP/M-86, and word processing and spreadsheet software is available for it.

The Apricot, distributed in Australia by Barson Computers, has been announced as a 'Fourth Generation Computer', which the manufacturers, Applied Computer Techniques Ltd of the UK, define as "an almost total shielding of the user from the

chronous communications pack, and a printer spooler. It runs three microprocessors: the 8086, the 8089 I/O processor, and optionally the 8087 maths processor. The keyboard can both transmit and receive data.

The Apricot is claimed to run 90% of IBM-PC software with its IBM emulator, and has a recommended retail price of \$4444.



Multitech MIC504. "No Frills" on the desktop.

WE HAD SUCH GREAT RESPONSE TO OUR FEBRUARY SPECIALS, THAT WE HAVE EXTENDED THEM TO THE END OF MARCH '84

(These prices are only for March '84, or letters post-marked March '84)

DON'T FORGET TO CHECK OUR STORE SPECIALS

WE WILL GIVE YOU THE BEST DEAL ON COMMODORE COMPUTERS PLEASE RING BERNEICE FOR THE BEST PRICE POSSIBLE ON (03) 489-8866

THIS MONTH SOMETHING FREE! FREE! FREE! WITH EACH PURCHASE.

MN3001
(SCOOP PURCHASE FOR OUR KITS)
NORMALLY \$19.95
THIS MONTH
BUCKET BRIGADE IC'S
SAVE, SAVE, SAVE,
EX1 IC EXTRACTOR

1-9 \$14.95 10+ \$13.95



DON'T DAMAGE YOUR IC'S WHEN YOU HAVE TO PULL THEM OUT.

1-9 \$1.20 10+ .95

2K OHM MULTIMETER
11 RANGES POCKET SIZE



SPECIFICATIONS
11 RANGES

DC VOLTAGE: 0-10-50-250-1000 volts
2000 ohms/volt

AC VOLTAGE: 0-10-50-250-1000 volts
2000 ohms/volt

DECIBELS: -10 TO +22dB in four ranges

OHMMETER: 0-10 k/ohms, 0-1 megaohms

DC CURRENT: 1-100mA

NORMALLY \$14.95

THIS MONTH \$9.95

BUTTON CELLS
FREE CHART ON WHAT THEY FIT. CHARGE YOUR FRIENDS \$4.00 TO FIT THEM INCLUDING THE BATTERY FOR FIVE MINUTES WORK.

	1-9	10+
SG13/G13	1.50	1.00
SG12/12	1.20	.80
SG10/G10	1.20	.80
SG3/G3	1.20	.80
AG13/LR44	1.00	.75
AG12/LR43	.75	.60

HI WATT BATTERIES
WE JUST LANDED A TONNE OF THESE LITTLE "HEART" STARTERS TO CHEAP THAT YOU CAN THROW THEM AWAY AFTER USING THEM ONCE IF YOU WANT TO.

	1-9	10+
AA	15c	10c
C	20c	15d
D	25c	20c
9V	40c	30c

SOLDER CENTRONICS PLUGS

(UNREAL PRICE. BUT ABSOLUTE TOP QUALITY)

1-9 \$7.95 10-99 \$6.95 100+ \$5.95

NORMALLY \$14.95. (OUR OPPOSITION CHARGE UP TO \$19.95. ARE YOU PAYING TOO MUCH FOR OTHER PRODUCTS FROM THEM AS WELL.)



ELECTRET MIC INSERTS
WITH PINS FOR EASY BOARD INSERTION



1-9 \$1.75 10-99 \$1.65 100+ \$1.50

DON'T PAY TOO MUCH BREADBOARD SPECIALS

CAT. No.	No. HOLES	COMP. PRICE	OUR PRICE
P11000	100	2.95	\$1.50
P11005	640	8.95	\$5.95
P11009	840	14.85	\$10.95
P11012	1680	27.95	\$19.95
P11015	2420	45.00	\$29.95



HALF HEIGHT 5" DRIVE SPECIALISTS

MITSUBISHI	BARE DRIVE	WITH BOX + P.S.
M4851 500K BYTE	\$329.00	\$369.00
M4853 1M BYTE	\$359.00	\$399.00
M4854 1.6M BYTE	\$399.00	\$439.00

MP 5" STANDARD DRIVES

B51	\$269.00	\$299.00
B52	\$349.00	\$379.00
B91	\$349.00	\$379.00
B92	\$439.00	\$459.00

ALL DRIVE PRICES INCLUDE SALES TAX
COMPUTER CABLES



NEW PRODUCTS TO SAVE YOU HEAPS OF TIME TRYING TO CRIMP THEM IN A VICE.

P19001	SYSTEM 80 OR EARLY TRS80 2x34 WAY EDGE CONNECTORS 1 METRE 34 WAY IDC CABLE SINGLE 5 1/4" DRIVE CABLE	\$29.50
P19003	SYSTEM 80 OR EARLY TRS80 3x34 WAY EDGE CONNECTORS 1 METRE 34 WAY 1DC CABLE DOUBLE 5 1/4" DRIVE CABLE	\$39.50
P19005	BIG BOARD 2 OR LATE TRS80 1x34 WAY EDGE CONNECTOR 1x34 WAY IDC CONNECTOR 1 METRE IDC CABLE SINGLE 5 1/4" DRIVE CABLE	\$26.50
P19007	BIG BOARD 2 OR LATE TRS80 2x34 WAY EDGE CONNECTORS 1x34 WAY IDC CONNECTOR 1 METRE IDC CABLE DOUBLE 5 1/4" DRIVE CABLE	\$39.50

DATA BOOKS, DATA BOOKS YOU WILL NEED THESE FOR SCHOOL

FAIRCHILD CMOS	\$9.95
NATIONAL LOGIC TTL	\$9.95
NATIONAL LINEAR I	\$9.50
NATIONAL LINEAR II	\$9.50
NATIONAL CMOS	\$9.50
NATIONAL LINEAR APPLICATIONS	\$14.50

CHASIS PUNCH SET

(WE KNOCK A HOLE IN THE OPPOSITION'S PRICES ON THIS ONE) **\$16.95**



JOYSTICKS



(AS USED IN YOUR STANDARD COIN OPERATED MACHINE'S. THESE SHOULD GIVE YEARS' OF SERVICE AS USED BY THE PROFESSIONAL OPERATORS.)

2 WAY (2 MICROSWITCHES)	1-9 \$21.50 18-50 \$18.50
4 WAY (4 MICROSWITCHES)	23-50 \$19.50

DIP SWITCHES 4 WAY \$1.00 8 WAY \$1.50

AA NICADS 1-9 \$1.75 10-99 \$1.60 100+ \$1.50

NORMALLY \$2.50 EACH

BARGAIN HUNTERS CORNER

(GET YOUR BIG GAME HERE)

THE STING DISK FOR MICROBEE™ 50 only in stock WAS \$395.00 NOW \$195.00. GET IN QUICK.

5 CP-80 RIBBONS FOR \$49.50 (HOW DO WE DO IT?)

NEON TEST SCREWDRIVER
WE HAVE ZAPPED THE PRICE TO 75 CENTS

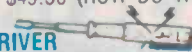

OUR NEW RANGE OF OSCILLOSCOPES ARE ON THE WAY

ASK FOR DETAILS. SHOULD ARRIVE LATE FEBRUARY

15 MHz AC-DC PORTABLE	\$695.00 Including Tax
20MHz Dual Track	\$495.00 Including Tax
45MHz Dual Track	\$995.00 Including Tax

Probes are extra at \$29.50 each
BUY IN LOTS OF 10 AND SAVE

PIC A PAK SPECIALS

10 2SJ49 for	\$49.00	10 74C926 for	\$59.00
10 2SK134 for	\$49.00	10 2732 for	\$49.00
10 2N3055 for	\$7.50	10 2764 for	\$79.00
10 BUX80 for	\$39.00	10 74LS245	\$12.00
10 BD139 for	\$3.90	10 4164 for	\$69.00
10 BD140 for	\$3.90	10 7400 for	\$2.90
10 RED LEDS 5mm .90		10 H1044 DELUXE	
10 GREEN LEDS \$1.40		METAL CASES for	\$49.50

LINE FILTERS 3 AMP 240 VAC. \$11.95



JUST ARRIVED (WE HOPE) NEW DIGITAL MULTIMETER

PUSH BUTTON CONTROLS BUT UNDER \$60.00



WOW!!!
10 AMP
1-9 \$59.95 10+ \$52.50

ROD IRVING ELECTRONICS

425 High St., Northcote, Vic. 48-50 A'Beckett St., Melb., Vic.
Phone (03) 489 8866, (03) 489 8131, Mail Order Hotline (03) 481 1436
Mail orders to P.O. Box 235 Northcote 3070 Vic.

Minimum P & P \$3.00. Errors & omissions excepted.
Please address tax exempt, school, wholesale and dealer enquiries

RITRONICS WHOLESALE

1st floor 425 High St. Northcote 3070 (03) 489 7099 (03) 481 1923
Telex AA 38897



EC-80 PRINTER

Energy Control has recently released the EC-80 dot matrix printer available for less than \$250 in quantity of 50 units.

The EC-80 is a compact desk top dot matrix impact printer used for hardcopy of data from any microcomputer, personal computer, office computer etc. It will print upper and lower case alpha-numeric characters in both Normal and Italic fonts, in condensed, normal or enlarged sizes and in normal or enhanced modes.

It features both friction and adjustable sprocket feeds as standard; high print quality from carbon film ribbon; logic seeking for faster throughput; high resolution bit-image graphics (640 dots/line); built-in graphics symbols; self-stacking paper basket; square pin print head for improved character registration.

Further information can be obtained from Energy Control, PO Box 6502, Goonda Qld 4300. (07)288-2455.

CONTROLLER COMBINES HARD AND FLOPPY CONTROL

A multibus-compatible mass-storage controller that combines control of both Winchester and floppy disks on the same board is being offered by National Semiconductor.

The BLC-8230 and BLC-8232 disk controllers are capable of supporting up to two Winchester and two floppy-disk drives. In particular, the BLC-8230 controls up to two 20 cm Winchesters and two 20 cm floppy-disk drives, while the BLC8232 controls up to 13 cm Winchesters and either 13 cm or 20 cm floppy-disk drives.

Both products represent a single-board solution to the problem of addressing the two most popular types of peripheral memory. The BLC-8232 provides an SA1000-type 20 cm

disk interface, and the BLC-8232 a 13 cm ST506-type interface.

Capable of handling 16, 20 or 24-bit addresses, as well as byte or word-size data transfers, the new disk controllers offer a number of key performance features to users.

These include support of either eight- or 16-bit I/O addressing, programmable error retry with media fault management, comprehensive on-board diagnostics, and the ability to perform direct multisector transfers at the full disk data rate.

For more details, contact National Semiconductor, Cnr Stud Road and Mountain Highway, Bayswater Vic. 3153. (03)729-6333.

Sendata 2000 Direct Connect Modem

Auto Answer/Disconnect

Speed Selectable



12 Months Warranty
Telecom Approved

An unbeatable price/performance package of features including:

- 300bps Full Duplex.
- 1200bps Half Duplex Synchronous.
- 600 or 1200 Half Duplex V23 Standard.
- V24 (RS232) Interface.
- CCITT and Bell frequencies.
- Slimline Case (30mm high)
- Automatic (or manual) answer and disconnect.

OEM AND DEALER ENQUIRIES WELCOME.

SENDATA

MODEMS
Designed and manufactured by
ELECTROMEDICAL ENGINEERING P/L

69 SUTHERLAND ROAD, ARMADALE,
VICTORIA 3143, AUSTRALIA
TELEPHONE: (03) 509 5844.
TELEX: AA34008

NEW INTERFACES FOR IBM PC

3D Digital Design and Development has announced the introduction of two interface systems for the IBM PC. These are the Inlab and Thinklab.

Both systems are modular in design allowing a number of extended Eurocard subunits to be slotted into a 19" industrial rack. These modules include multi-channel analogue to digital converters, digital to analogue converters, instrumentation amplifier, thermocouple conditioning amplifier, intelligent stepper motor controller, programmable shaft encoder etc.

Both interfaces allow up to 128 analogue inputs, 64 analogue outputs, 384 digital input lines, 129 on/off outputs etc. Both analogue inputs and outputs have 12-bit resolution. Digital input and output lines may be opto-isolated from the interface.

Thinklab has been designed specifically for remote data acquisition and control over a serial communication link such as the RS232C or equivalent.

The Inlab Buss controller card may also be used by itself as a 24 line bidirectional input/output device with status bit and interrupt facility.

The company claims that the combination of the IBM PC and 3D interfaces offers a very powerful system with maximum adaptability but without incurring high costs.

3D provides full product support including a detailed manual and suite of demonstration programmes on a diskette. Machine code programming and custom software can be written against specification.

For further information please contact **3D Digital Design and Development**, 18/19 Warren Street, London W1P 5DB.



IDIAK II LOW COST QUALITY TERMINAL FAST CP/M 2.2 COMPUTER



- \$1999 DUAL DRIVE COMPUTER (A&T)
- \$1450 SINGLE DRIVE COMPUTER (A&T)
- \$590 DRIVE UPGRADE KIT
- \$447 TERMINAL COMPLETE KIT (NEEDS VIDEO MONITOR)
- \$110 10 x HIGH DENSITY DISKS
- \$12 1 x HIGH DENSITY DISK
- \$45 1 x CENTRONICS CABLE
- \$40 1 x TERMINAL/PRINTER CABLE

* TERMINAL FEATURES

- Emulates Televideo 910 terminal
- 80 character x 24 line display
- Dual Intensity Highlight Mode
- 9600 maximum BAUD rate

* COMPUTER FEATURES

- 2 x Slim-line 5 1/4" Drives (Optional 1 Drive)
- Disk Access-Faster than 8" systems
- Disk Capacity-2.8 M Byte formatted
- Z80A 4MHz CPU
- 64K RAM
- 2 x RS232 I/O Ports
- 1 x Centronics Port
- Includes CP/M 2.2 Software

SALES TAX INCLUDED

\$2 PACK & POST ON ORDERS LESS THAN \$150

10A Bannister Street Mall, Fremantle 6160 W.A.
P.O. Box 694, Fremantle 6160 W.A.

IDIAK COMPUTER PRODUCTS



APPLE II MOUSE

Apple Computer has announced a mouse and new software called MousePaint which it will offer early next year for its Apple II personal computers.

A mouse is a pointing device that can be used instead of a keyboard to select computer operations and modify information displayed on the screen. Apple's Lisa computer, introduced earlier this year, ignited broad interest in the mouse among computer owners, software developers and other computer manufacturers. The Lisa is designed to be almost completely controlled by a mouse, one of the things that makes it much easier to use yet more powerful than conventional computers.

AppleMouse II will be packaged with MousePaint software that uses the mouse to design charts, diagrams, free-hand drawings and other visual aids for reports and presentation. Users can insert text in a drawing and can choose from a variety of character fonts and fill patterns. MousePaint simulates bit map graphics to support the Apple II family's high resolution capabilities.

Independent software developers are being encouraged to write applications that take advantage of the mouse. Most future Apple software programs for the Apple II family will offer the mouse as an option.

For further information contact Apple Computer Australia Pty Ltd, 37 Waterloo Rd, North Ryde NSW 2113. (02)888-5888.

MACINTOSH — SOFT WEAR SOFTWARE?

Microsoft has announced a full line of application software for the Apple Macintosh and its intent to announce other programs for the Macintosh as well.

Microsoft claim that their versions of Multiplan, Word, Chart and File programs comprise the first line of software to be announced for the Macintosh by any vendor. In addition, Microsoft BASIC is also available for the Macintosh.

The company says that Macintosh's unique interface, together with the Microsoft programs, provides a powerful and func-

tional environment for increasing a user's productivity. The high resolution graphics screen enables graphics to be applied universally to all modes, whether they be charts and graphs as in Microsoft Chart, columns of figures in Multiplan, or words, sentences, and paragraphs in Microsoft Word. Thus, users can readily combine text with graphics without the usual intermixing problems.

Further details of this software can be obtained from Microsoft Pty Ltd, PO Box 98, Terry Hills NSW 2064. (02)450-2522.

H-P TOOLS FOR ZILOG

Zilog Corporation and Hewlett-Packard have announced a collaborative effort in which HP will develop support tools for the new Z800 family of microprocessors.

The cooperative project will provide significant benefits for users of Zilog microprocessors and the HP 64000 logic-development system. Such as support tools for the Z800 microprocessor will be available much earlier than otherwise possible.

Otherwise the HP64000 design and development aids will be closely attuned to the Z800 device, allowing designers to take full advantage of the distinctive Z800 CPU features from the very first phases of development.

The Z800 microprocessor family integrates cache memory, a memory-management unit, an interrupt controller, DMA channels and timer/counters with a powerful central processing unit. These features, coupled with a versatile instruction set and up to 25 MHz clock rates, provide a solid base for the development of effective and cost-efficient 8-bit and 16-bit microprocessor-based products. Code written for Z800-based products is transferable to the Z800 CPU without modification, making a transition to the new processor easier.

For further information contact Z Systems Pty Ltd, 1966 Vulture St, South Brisbane Qld 4101. (07)44-3715.

MICROPROCESSOR FUNDAMENTALS AND APPLICATIONS

A two-part course of microprocessor fundamentals, with a sequel on microprocessor applications, will be offered by radio and cassette as part of the University of New South Wales continuing education program for 1984. The series is being repeated after being widely acclaimed following previous broadcasts.

According to the lecturer, Dr David Mee, of the University's School of Electrical Engineering and Computer Science, it requires no more than a basic understanding of electronic circuits and simple logic networks, and only general computing experience, to do the courses.

Part 1 of Microprocessor Fundamentals reaches a level where simple programming and application of microprocessors can be understood. Part 2 discusses further hardware and software functions, typical evaluation modules, and demonstrates how to design, develop and debug a simple project on a microprocessor.

The course on Microprocessor Applications will enable the student to use a microprocessor in his own system for measurements, monitoring or control. It covers applications in a variety

of common situations, each exemplifying different aspects of microprocessor systems design.

Each part of the microprocessor fundamentals course consists of 10 broadcast lectures, a video program and two attended tutorials at a cost of \$42.50. There are 8 radio lectures, backed by a video program and two tutorials on microprocessor applications for \$35.

The broadcasts start on 10 April, each lecture being broadcast at 8 pm on Tuesdays and 7 pm on Fridays over the University's educational radio station, Radio University 2UV.

Audio cassettes of the lectures are already available, at \$80 for each part of Microprocessor Fundamentals, and \$64 for Microprocessor Applications. The video programs cost \$30 or \$50 each, depending on the format chosen.

Transistor radios adjusted to pick up Radio University courses in the Sydney metropolitan area are available for \$12, including postage.

Full particulars on this and other continuing education courses by radio and cassette can be obtained from the University of New South Wales by phoning (02)662-2691.

NEW IMPROVED LOW-COST DIRECT MODEM

Dick Smith Electronics has just released a new version of its Dataphone direct-connect data modem. The new Dick Smith Dataphone II offers not only upgraded performance, but also includes a pushbutton type electronic phone. It sells for the same price as the original model: \$199.

Besides the added convenience in establishing data calls, the built-in phone brings a further bonus: installing the Dataphone II is now simply a matter of the user plugging it into a standard Telecom phone socket. There's no delay or installation fee to pay.

The built-in phone also provides a last-number-redial facility, which makes it much easier and faster to re-establish a call following a dropout.

On the performance side, the Dataphone II offers improved demodulator phase stability and significantly greater tolerance of Telecom line impedance variations, claims Dick Smith.

Original Dataphone features still featured in the model II include: full duplex, answer/originate operation for convenience; operates at the standard switched-network data rate of 300 baud; designed and manufactured in Australia and fully authorised by Telecom; uses standard RS232C computer interface and provides 'carrier detect' output and LED indication.

Designated as Cat X-3272, the Dick Smith Dataphone II modem is available from all Dick Smith Electronics stores, plus selected resellers.



ANOTHER MOUSE

Penny & Giles Potentiometers have released the model M2/100 Mouse.

This device translates movement over any convenient flat surface into movement on a computer screen, thereby eliminating many laborious cursor and keyboard control operations. Three finger operated button switches are fitted as standard. Its primary uses are cursor control, menu selection, graphics and text editing.

Its features include: self cleaning bearing surface; easily dismantled for cleaning after accidental contamination; high impact low friction bearings for main drive ball; operates on a wide variety of surfaces; non



contacting solid state pulse generators and low cost.

Penny & Giles are represented in Australia by Paton Electronics, 90 Victoria Rd, Ashfield NSW. (02)797-9222.

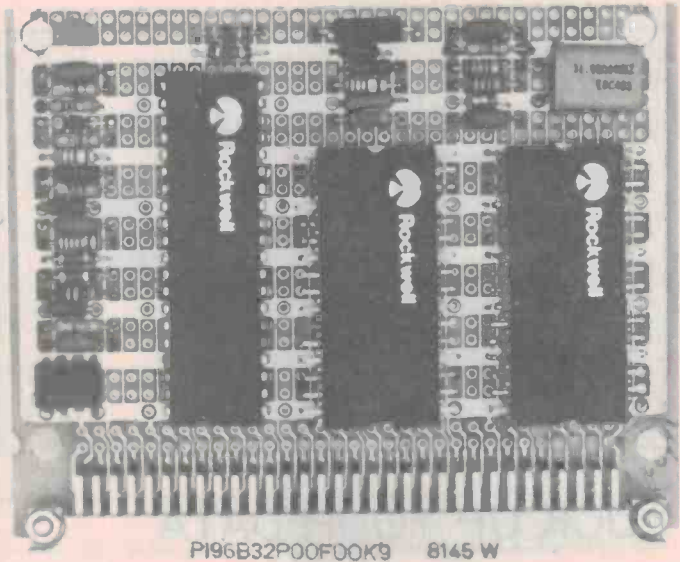

MODEMS ACT LIKE PERIPHERALS

LSI-based modems from Energy Control designed to link to the microprocessor bus, offer an error rate of 1 in 10⁶, claim the company.

The family of highly integrated 1200, 2400 and 9600 baud card-level modems designed to be addressed as microcomputer peripherals is aimed at several lucrative market segments. The models in the line cost \$450 in unit quantity for 1200 baud full-duplex units.

The modem family derives from Rockwell-designed very large-scale integrated circuits: two basic signal-processing

devices with memory capacities that vary with performance. They might eliminate up to \$50 of components previously required to implement modems.

More importantly, these chips boost the modems into full-fledged computer peripherals, with control data transferred over the microcomputer bus, explains Dennis Kaliher, general manager for telecommunication products.

Rockwell International is represented in Australia by Energy Control, PO Box 6502, Goodna Qld 4300. (07)288-2455.

APPLE AND FRANKLIN TERMINATE LITIGATION

Apple Computer and Franklin Computer Corporation have announced that they have agreed to terminate the litigation commenced by Apple against Franklin in the Federal Court in the Eastern District of Pennsylvania by the entry of a judgement of US\$2.5 million against Franklin and Franklin's agreement not to infringe on Apple's copyrights.

In its complaint, Apple asserted that Franklin had copied fourteen of Apple's computer operating system programs. Franklin had challenged the validity of Apple's copyrights and also asserted that Apple was

guilty of anti-trust violations and unfair competition.

A decision by the third circuit court of appeals held that Apple's operating system could be protected by copyrights. The consent judgement, when entered, will settle Apple's copyright claims in Apple's favour and dismiss Franklin's pertinent counterclaims.

The settlement agreement between Apple and Franklin sets up an arbitration procedure for any future copyright infringement disputes between the companies relating to any substitute Apple-compatible computer program.



LOCK UP YOUR DATA

The JED DataSafe is a new Australian-designed way to hold 64K of data safely and securely in any data gathering, machine monitoring or recipe holding application.

The data is locked away in a box full of lithium battery powered CMOS RAM against marauding power supply dropouts, shock, vibration, humidity, temperature extremes and passing time.

The DataSafe is designed to replace cassette tapes, punched tape or EEPROMs with their high voltage requirements. The DataSafe does away with the need for cassette and floppy drives with their motors, or the complexities and power requirements of bubble memory with its fancy pulses and ramps. It offers

an easily loaded and unloaded data store which is then easily transported.

It is a 30 x 60 x 115 mm diecast box and connects via a 15-way D-type connector to a data reading or writing system. During reading and writing, the box draw a few microamps at 5 V. If the DataSafe is then disconnected, or the main system power goes down, the data is stored for years in the RAM.

The DataSafe is available in 8, 16, 32 and 64 kilobyte capacities and a version is also available with two sockets to make the box a safe way to hold and transport 16 kilobytes of PROM data in 2764s. Full details from JED Microprocessors Pty Ltd, PO Box 30, Boronia Vic 3155. (03) 762-3308.

SEVEN-USER NETWORKING SYSTEM FOR THE DESKTOP

The Discovery 500, a desktop networking computer for business, science and industry, has been released in Australia by Archives Computers.

The Discovery 500 is an S-100 desktop single- or multi-user system offering both eight- and 16-bit microprocessors and up to 26 megabytes of inbuilt hard-disk storage.

The basic system is just under \$9000.

A feature of the Discovery 500 is the 8086/8087 16-bit processor option and its ability to expand disk storage to 128 megabytes.

With the aid of the 8087 numeric data processor, the Discovery 500 can execute 'number crunching' programs at speeds previously only attainable on mainframes.

The Discovery 500 user has a choice of four operating systems, including CP/M, CP/M 86, CP/M Plus and DPC/OS.

Available with the system is a series of Dataflex-based programs, which enable up to seven users to be able to inquire on or update the same database at the same time.

File- and record-locking is managed by the system so that

8-BIT MICRO WITH 12K ROM

The first 8-bit, single-chip microcomputer with 12K bytes of on-chip ROM has been announced by Texas Instruments.

The new TMS70120 can store a complete, 12K applications program without the need for any external ROMs, buffers and latches. By reducing the chip count for applications in the 4K-12K program range, the TMS70120 allows OEMs to lower the cost, power consumption, weight, and space requirements of many 8-bit applications.

The TMS70120's large, on-chip memory frees up the twenty or more general-purpose I/O lines usually required to interface a microcomputer with off-chip ROMs. This gives designers much greater flexibility to enhance an application by interfacing the TMS70120 to various peripherals.

These capabilities make the TMS70120 well suited for 8-bit applications with moderate memory requirements. Possible uses range from point-of-sale terminals and test equipment to 'smart' appliances and auto dashboard controls.

Fabricated using NMOS technology, the TMS70120 operates from a single 5 V supply. Nominal operating frequency for the device is 5 MHz, with a typical power dissipation of 550 mW. The TMS70120 is provided in a standard 40-pin, 600-mil, dual-

in-line plastic package.

For further information, contact Texas Instruments Australia, Semiconductor Group, 6-10 Talavera Road, North Ryde NSW 2113. (02)887-1122.

NEW DOS FOR APPLE II

Apple software developers are being supplied with a new disk-operating system for the Apple II family of personal computers.

Distributed by Apple Computer Australia for applications development, the Prodos system provides increased compatibility between Apple II and Apple III environments and the higher performance required for more sophisticated Apple II applications.

Prodos uses the hierarchical file structure, file-naming conventions and data formats of the Apple III sophisticated operating system. As a result, Prodos data files and data media are interchangeable on the Apple II or Apple III.

Prodos' design frees the Apple II from the physical limitations of the 143K Apple disk II drive. Using Prodos, the Apple II can handle larger files, such as those often required by the word-processing and data-base applications. It can also recognise any storage device, either floppy or hard disk, that uses Apple's protocols.

In addition, Prodos' hierarchical, Unix-like structure provides the Apple II user with an organised method for managing larger numbers of files on larger storage devices.

Prodos does not make the Apple DOS 3.3, SOS or Pascal operating environments obsolete, and all will continue to be available as licensed products from Apple. Users will be able to convert DOS 3.3 data files, so that they work with Prodos-based application programs, to take advantage of the advanced capabilities that Prodos provides.

For further details, contact Apple Computer Australia, 37 Waterloo Road, North Ryde NSW 2113. (02)888-5888.

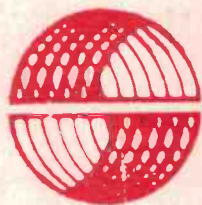

SPHERE
COMPUTERS

PRESENTS
AN INTELLIGENT
TERMINAL

FANTASTIC VALUE

ONLY
\$799

+ S.T. if applicable F.O.B. Ex Sydney.



Keyboard

- Detachable, capacitive, typewriter-style keyboard
- N-key rollover with auto repeat capability
- 4 LED indicators for caps lock, on line, block mode and keyboard lock/protect
- Audible keyclick enable/disable
- Auto repeat enable/disable
- Keyboard lock enable/disable
- Repeat rate 20 characters per second
- 5 cursor control keys, 10 editing function keys with 14-key numeric key-pad

Communication

- Code: 128 ASCII characters
- Baud rate: 75, 110, 150, 300, 600, 1200, 1800, 2400, 4800, 9600, 19,200
- Parity: Odd, even, mark, space
- Operating Mode: Full duplex, half duplex or block mode
- Interface: EIA RS-232C or 20-mA Current Loop

**OEM
DEALERS WELCOME
SPECIFICATIONS**

Emulation

- LEAR SIEGLER ADM-3A, HAZELTINE 1500, ADDS VIEWPOINT

Screen Presentation

- Display format: 24 lines x 80 characters
- Display unit: 12-inch, non-glare Green CRT
- Character type: 7 x 9 dot matrix

- Refresh rate: 50/60Hz
- Character set: 96 ASCII characters, 15 graphic symbols, 32 control character symbols
- 5 screen attributes: Blink, underline, blank, reverse, dual intensity
- Cursor type: Selectable slow, fast blinking or steady cursor, block, underline or invisible cursor

Editing Function

- Cursor: up, down, left, right, home
- Insert character, delete character, insert line, delete line, erase to end of line, page and field, field tab, field back tab, column tab, column back tab, block mode on/off, protect mode on/off, graphic mode on/off, clear unprotected.

External Control

- Power on/off
- Contrast adjustment
- Baud rate
- Parity and data format
- End of message
- Emulation mode
- Refresh rate
- Half duplex or full duplex
- Auto line feed
- Auto new line
- EIA or 20-mA Current Loop
- Reverse video or standard video

ENQUIRIES FROM: AVAILABLE FROM OFFICES AND SHOWROOM **PARIS RADIO ELECTRONICS**, SHOP 1, 165 BUNNERONG ROAD, KINGSFORD, NSW 2032. TEL. (02) 344 9111. TELEX AA22579.



H-P WORKSTATIONS SUIT IBM SYSTEMS?

Two new terminals from Hewlett-Packard Company provide individual workstation capabilities for office-automation applications.

The HP 2625A dual-display terminal can communicate with both H-P and IBM systems simultaneously. On the IBM system, the terminal emulates the IBM 3276/78 display station.

By pressing a single function key, the user selects either the H-P or IBM feature set. Word-processing and graphics capabilities are available as options.

The HP 2628A word-processing workstation operates as a dedicated word processor under

control of HP 3000 Word software. Graphics capabilities are available as an option. The HP 2628A terminal is priced 40% below previous comparable models from H-P.

Both workstations come standard with H-P VPLUS compatible data entry feature sets. They store up to six pages of text. Maths, line drawing and 11 national-language character sets all come standard with both terminals.

Ergonomic design features include high-quality lettering on a low-glare, flicker-free display, smooth scrolling and an optional tilt-and-swivel base.

BARSON PLANS COMPUTER MANUFACTURE IN WA

Following an offer of a package of incentives by the West Australian Government, Barson Computers plans to begin manufacturing in Australia this year.

The Melbourne-based company imports BBC microcomputers from Britain and Sirius business computers from the US.

Mr Barson expressed disappointment that the Victorian Government had not offered any incentives but he did not see manufacturing based in Perth as any disadvantage, although 70% of BBC sales would be in the eastern states.

Barson Computers began selling BBC computers in Australia 18 months ago and they now claim to be selling 1000 a month. They also forecast sales of the Sirius machine to double in the second year that the company has had the agency.

Barson has drawn up manufacturing plans for the BBC micros that call for 88% Australian content.

Studies conducted by the company indicated that the cost of manufacturing in Australia would be up to 15% more than it would be in Hong Kong or other South East Asian countries because of the higher wages. However, government support, the stable political situation and

the high quality of the Australian workforce would outweigh the advantages of cheaper labour.

Mr Barson believes that electronic manufacturing resources in Australia are considerably under-utilised — in some cases manufacturing equipment was only being used one or two days a month.

For further information contact Barson Computers Pty Ltd, 335 Johnston St, Abbotsford Vic. 3067. (03)419-3033.

TEXT EDITOR FOR HANDHELD COMPUTERS

Text-File is a text editor program for the Sharp PC-1500 or Tandy PC-2 handheld computers and is the first software release from Razor-Soft.

The program requires a computer with at least a 4K RAM expansion module installed. For the most common 8K RAM expansion, the program allows up to 85 lines of text, each 79 characters long, to be handled.

Text-File has been designed to make full use of the features of the PC-1500/PC-2 computer. The 26 character single line display is used as a window through which text is viewed. Full cursor controls allow this window to be shifted around easily.

Other review functions include requesting the display of a specific line, and a scroll function which scrolls through the whole entered text.

Two print functions are provided for use with the computer's printer.

Text-File is supplied on cassette and comes with a comprehensive instruction manual. The recommended retail price is \$25. For further information contact Razor-Soft, 1 Lantana Court, Frankston Vic 3199.

VMEBUSS CAPABILITIES EXPANDED

Projecting a market size of \$750 million for VMEbus compatible products by 1988, executives of Mostek, Motorola and Signetics/Philips have announced technical agreement on additional key elements of the total VMEsystem architecture.

The newly-defined supporting buss structures include a high-speed memory expansion buss, VMXbuss; and a self-arbitrating high-speed serial buss, VMSbuss, which may be optionally employed in systems based on the existing VMEbuss standard.

The VMEbuss and its extension buss structures form the basis of a total VMEsystem architecture which simplifies integration of complete systems from high-performance 8-, 16-,

and 32-bit board level system components. The existing VMEbuss interconnect standard provides the basic data transfer buss between major system components, while the VMXbuss facilitates expansion of local processor memory.

For rapid communication of brief messages between system modules, the VMSbuss uses only two conductors (clock and data) to provide an efficient 'party line' between system components.

Mostek and Signetics/Philips both produce the 16/32-bit M68000 MPU originally developed by Motorola. While not limited in application to 68000-based systems, the VMEsystem architecture has been designed

to provide a set of system-level features desirable for microcomputer systems where the M68000 MPU family will be used most frequently.

Additional buss-support IC designs in the M68000 family have also been announced to facilitate development of VMEsystem-compatible boards and the companies project that samples of these new chips will be available in the second half of 1984.

Continuing technical discussions among the three companies are expected to result in definition of additional buss support chips to complement the overall VMEsystem architecture.

BIRKENHEAD ELECTRONICS

THE MOST comprehensive range of Altronics Products
outside of Western Australia.

VINYL BINDER

Holds 12 magazines, each on a spring out wire rod. Just the shot for each year's set of Electronics Australia, ETI or any of your favourite magazine.

Suits all A4 size publications (275 x 210). Very smart Royal Blue colour with beautiful gold embossing.

B 9999 . . . \$5.50

THIS MONTH

\$5.00 each

4 pr more \$4.50 each

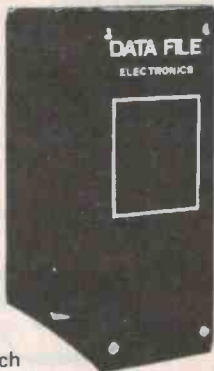

DUAL CONE WIDE RANGE

200 mm (8 in.), 10 Watts Max. power input. Public Address, Background Music, Ideal HI FI extension speaker. Includes transformer holes at 51 mm.

Over 50,000 sold in Australia!
Mounting holes 140 x 140 mm

C2000 . . . NOW \$6.50
WAS \$9.50 . . . \$6.00 10 UP



Powerful 6000 RPM Mini Drill for PC Work

Tons of Torque. Just the shot for PCB work. 12V DC operated from external Power Pack 1.2mm chuck capacity. Supplied c/w 1mm drill bit.

T2302
Incredible value now only. \$10.00



VELOSTAT

Non static sheeting for storing CMOS IC's, LSI's etc 1000 times better than aluminium foil. Will store up to 150 IC's on one 225 x 150mm sheet.

H 0600 \$2.50 per sheet

Premium Quality Genuine Phillips IN914/IN4148 Signal Diodes — Out they go at never to be repeated prices.

1's \$2.50 per 100
20101 4c \$20.00 per 1,000

SAVE ON BULK QUANTITIES

NEW PRODUCT

10 SEG. RED BAR GRAPH MODULE



Z 0180 \$2.50 10 up \$2.20 ea.
100 UP \$1.80

CEILING SPEAKER GRILL



Suits 200 mm (8 in.) speaker. Ideal for PA/Background music systems, tension speakers etc. Colour: White.

C 0800 ~~\$2.75~~

Now Incredible
\$1.50 ea

SOLDERING IRON STAND UNIVERSAL TYPE



T 1302
NOW

~~\$8.50~~

\$5.00

MICRON 30 WATT

This brilliant little 30 watt iron is just the "bee's knees" for the electronics hobbyist, electrician or home handyman. We searched the world for a low cost yet quality iron which met the criteria of • light-weight • screw in interchangeable tips • efficient thermal transfer from element to tip • tip temperature maintains within the limits suitable for electronic work and also small household jobs • and of course, fully S.E.C. tested and approved.



Comes fitted with T 2435 Tip

WAS \$12.95

REPLACEMENT TIPS T 2430 \$9.50

T 2434 Flat Tip .95
T 2435 Conical Tip .95
T 2436 Instrument Tip .95

THE COMPUTER YOU HAVE BEEN WAITING FOR HAS FINALLY ARRIVED
THE MOST POWERFUL, FLEXIBLE AND BUSINESSLIKE MACHINE IN ITS CLASS

★★★★★ THE EXCALIBUR 64 IS HERE ★★★★★

BIRKENHEAD ELECTRONICS

SHOP 71 QUAY WEST ARCADE
BIRKENHEAD POINT
PHONE: 81-4077
OPEN 7 DAYS

KIT SPECIALISTS

ROD IRVING ELECTRONICS

425 HIGH STREET, NORTHCOTE 3070, MELBOURNE, VICTORIA. Ph (03) 489 8131. Telex N° 38897

THIS MONTH'S KITS



ETI-1521 DIGITAL EXPOSURE METER

Don't be caught with indecent exposure! Our digital exposure meter is low in cost, simple to build and operate and includes a three digit readout.



ETI-678 MICROBEE ROM READER

This project enables your favourite games or utilities to be loaded quickly into your MicroBee from an EPROM - no more agonising waiting for a cassette to load or going to the expense of a disk system.



ETI-1522 CONTROL FOUR ROOM LIGHTS OVER A TWO-WIRE PAIR

It is probably a not-uncommon problem to want to replace the single ceiling light in a room with a more exotic arrangement only to find that the control wires to the switch are concreted in! Either that, or you don't want to "chase" more wires through the wall and have to replace the wallpaper and/or redecorate. This project fixes that.

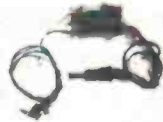

ETI-268 NICAD FLOAT CHARGER

\$9.00 ETI MARCH '83

Keep your NiCad batteries in tip-top condition with this cheap, simple charger.



\$18.50

ETI Oct 83

ETI-412 PEAK PROGRAMME METER

This project uses a 10-LED bargraph display module to show audio level from -23 dB to +6 dB. It's simple to build and set up.

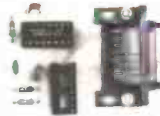

ETI Oct 83 **\$16.50**

ETI-672 MICROBEE TELETYPE INTERFACE

The 'Claytons' of printers is the old surplus teletype—such as the Model 15 etc. For around a tenth the price of a dot-matrix printer, you can have hard copy from your microBee using this simple interface.



ETI MAY '83
ETI-163 LAB SUPPLY \$165

Fully variable 0-40 V current limited 0-5 A supply with both voltage and current metering (two ranges 0-0.5 A 0-5 A). This employs a conventional series-pass regulator, not a switchmode type with its attendant problems, but dissipation is reduced by a unique relay switching system switching between taps on the transformer secondary.



ETI-668 MICROBEE EPROM PROGRAMMER \$47.50
ETI FEB '83

Simple, low cost programmer for the MicroBee can program 2716s, 2732s and 2764s.

ETI-153 TEMP. PROBE

\$19.95

ETI JUNE '83

Can measure temperature from -50°C to +150°C. It simply plugs into your multimeter—great for digital multimeters. Accuracy of 0.1°C resolution of 0.1°C.

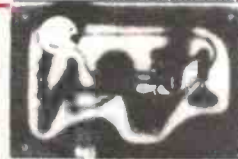

ETI MAY '83
ETI-323 HEADLIGHT DELAY UNIT \$17.50

Park your car and turn off the lights. Can't see where you're going? Press the button and the headlights come on to light your way, switching off automatically after 50 seconds. This is a simple, easy to build, low cost project.

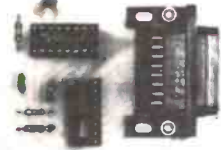

ETI-671 MICROBEE PRINTER INTERFACE

\$12.50 ETI Oct 83
A simple interface unit for parallel printers.



ETI-162 30 V/1 A FULLY PROTECTED POWER SUPPLY \$47.50
ETI DEC '83

The last power supply we did was the phenomenally popular ETI-131. This low cost supply features full protection, output variation from 0 V to 30 V and selectable current limit. Both voltage and current metering is provided.



ETI-654 APPLE II ANALOGUE/DIGITAL INTERFACE \$159.00 ETI MARCH '83

This project will give your Apple a set of 8-bit digital inputs and outputs plus one analogue input and one analogue output. Applications include driving a robot, recording science experiment results, etc. (digital only shown).



ETI-688 BIPOLAR PROM PROGRAMMER \$47.50 ETI JUNE '83

Every digital workshop should have one! Can be used to program the popular fusible-link PROMs like the 74S188, 288, 82S23 and 82S123 etc.



ETI-461 GENERAL PURPOSE BALANCED INPUT PREAMP \$20.00

ETI Oct '82

This project can be used as a balanced mic amp with low impedance input, a low or high impedance input differential amplifier or a balanced input instrumentation amplifier.



ETI Oct 83 **\$475 inc. tax**

ETI-690 LITTLE BIG BOARD
Just what you've always wanted in a computer—a big computer on a little board! This design runs a Z80A at 4 MHz, comes with 64K RAM, two RS232 ports and a floppy disk controller. It'll run CP/M 2.2 and the board fits the soon-to-be-popular STD buss.



\$75.00

ETI Oct 83

ETI-175 20 MHz HANDHELD FREQUENCY METER

A portable 4 1/2-digit frequency meter that also measures period from 200 us to 200 ms. What's more, it looks so good, nobody will believe you built it yourself!

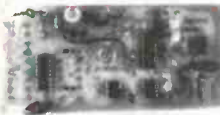

ETI-335 PUSHBUTTON PROGRAMMABLE WIPER CONTROLLER \$28.50 ETI MARCH '83

No more fiddling with knobs and not getting the delay between wipes that you want—this windscreen wiper controller is simply programmed with two pushbuttons to provide the wiping delay you need.

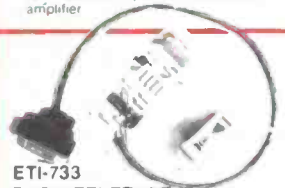

ETI-733 RADIOTELETYPE CONVERTER FOR THE MICROBEE \$20.00

ETI APRIL '83
Have your computer print the latest news from the international shortwave news service. Just hook up this project between your shortwave receiver's audio output and the MicroBee's parallel port. A simple bit of software does the decoding. Can be hooked up to other computers too.

The 6800 microprocessor series

With these versatile devices in the M6800 series it is possible to design and build a minimum component system for dedicated applications.

Peter Ihnat

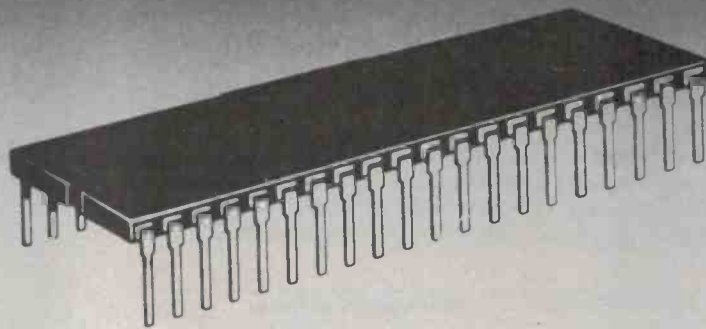

Part 1

THE M6800 FAMILY of LSI devices has been around for some time. Now with the release of several updated chips it is possible to design and build a system for a dedicated application with a minimum amount of time, effort and sometimes more importantly, with the minimum number of components.

This stems from the fact that there is compatibility between the different members of a family; once a particular microprocessor has been purchased almost any number of chips within the family of that microprocessor can be added to obtain the required system.

If care is taken it is also possible to use chips from other families in the same system. It seems that each new device introduced into a family by the manufacturer either performs some new function or is an existing chip which has had 'something extra' added.

The latter is the case with the MC6802 microprocessor. Basically, it is the 6800 microprocessor with two 'added extras'. Firstly, an external clock is no longer required since the oscillator is built-in. All one needs to do is to connect a crystal and two capacitors to the chip and it works.

Secondly, the designers have placed 128 bytes of user RAM on the chip (the lower 32 bytes can be placed in standby mode when the microprocessor is powered down).

Not very much RAM you say? Well, in certain applications you're right. But let's imagine that a system is required to control some specific device, e.g. a pushbutton combination lock. Ah, you say. My Apple IIe will do that. Yes, OK. But isn't that a bit of an overkill?

What would be nice is to have a small single-board microprocessor which can be

configured to do the job required for tens of dollars rather than hundreds. This single board microprocessor could then be mounted in the device and left there to run it. One advantage of this method is that the microprocessor unit could be programmed to be a lot more 'intelligent' than a controller made up from discrete components.

As you probably know, large amounts of RAM may not be required in many applications. The combination lock would only need RAM to store the correct combination, entries from the keyboard and other 'housekeeping' data. The 128 bytes available in the 6802 would probably be more than enough!

Figure 1 shows one possible minimum system (keyboard and display hardware is not shown). Note that this system would not be flexible enough for the home constructor since the ROM part of the MC6846 needs to be mask-programmed during manufacture.

A more flexible system would use a PIA for I/O and an EPROM to hold the control program.

There are two other versions of the MC6802; the MC6808 is identical but does *not* have the internal RAM whereas the MC6802NS does have RAM but not the standby feature. They are all available at speeds of 1 MHz, 1.5 MHz and 2 MHz.

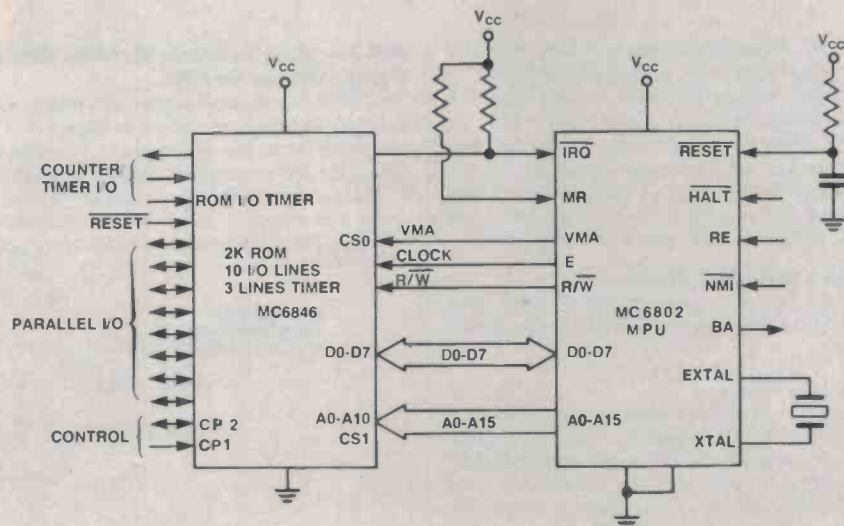
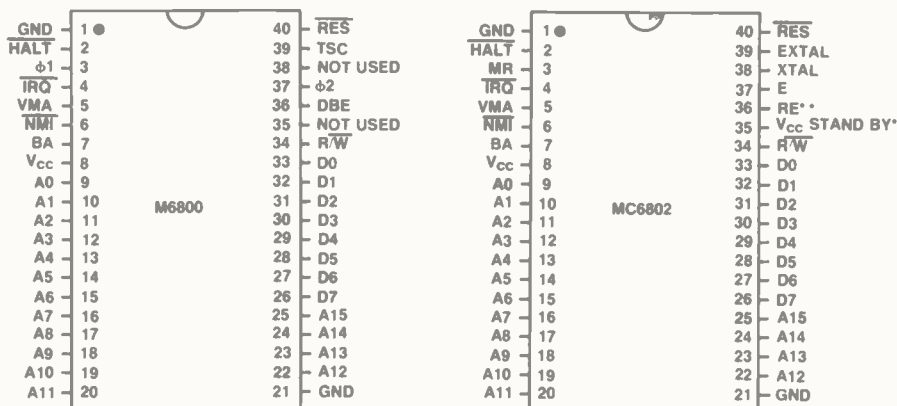

Figure 1. One example of a cost effective microcomputer.

The 6800 microprocessor series



NOTE: * PIN 35 SHOULD BE TIED TO +5 V ON THE 6802NS ** PIN 38 MUST BE TIED TO GND ON THE 6800

Figure 2: Pinouts of M6800 and MC6802 microprocessors

Microprocessor description

From the hardware point of view the 6800 and 6802 are both available as 40-pin packages. Figure 2 shows the pinouts of the two

low, Read/Write (R/W) and data lines will be tri-stated and address lines will be tri-stated in the 6800 or will display the address of the next instruction in the 6802.

pin no.	6800 signal description	6802 signal description
1	ground (GND)	ground (GND)
2	halt (HALT)	halt (HALT)
3	phase 1 ($\phi 1$)	memory ready (MR)
4	interrupt request (IRQ)	interrupt request (IRQ)
5	valid memory access (VMA)	valid memory access (VMA)
6	nonmaskable interrupt (NMI)	nonmaskable interrupt (NMI)
7	buss available (BA)	buss available (BA)
8	power (V_{cc})	power (V_{cc})
9-20	address lines (A0-A11)	address lines (A0-A11)
21	ground (GND)	ground (GND)
22-25	address lines (A12-A15)	address lines (A12-A15)
26-33	Data lines (D0-D7)	data lines (D0-D7)
34	read/write line (R/W)	read/write line (R/W)
35	not used	V_{cc} standby
36	data buss enable (DBE)	RAM enable (RE)
37	phase 2 ($\phi 2$)	enable (E)
38	not used	xtal
39	three state control (TSC)	extal
40	reset (RES)	reset (RES)

Table 1. M6800 and MC6802 pin summary.

devices. Notice that they are almost pin for pin equivalent; the differences are due to the 6802 having a clock oscillator and 128 bytes of RAM on the same chip.

It is important to note that the two devices are fully software compatible. Let's examine the function of each of the 40 pins so that differences between the 6800 and 6802 signals can be noted and explained.

PINS 1 and 21 — ground.

These are the ground connections and should be connected to 0 V from the power supply.

PIN 2 — HALT

During normal operation of the microprocessor this input should be tied high. When pulled low the microprocessor will complete execution of the current instruction and then stop. While in this halted mode the various control lines will be set to the following states: Buss Available (BA) line set high, Valid Memory Access (VMA) line set

PIN 3 — phase 1 clock on the 6800; Memory Ready (MR) on the 6802.

The 6800 needs an external two-phase non-overlapping clock as shown in Figure 3. The two waveforms are called phase 1 and phase 2 and are fed in via pins 3 and 37 respectively. Since the 6802 has a built-in clock the input for phase 1 clock is not necessary, whereas pin 37 is used as a clock output for

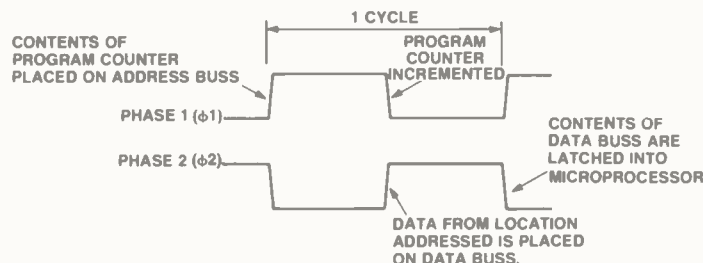

Figure 3. Two phase non-overlapping clock required for the M6800 microprocessor showing how certain operations are based around it.

synchronising data transfers with peripheral devices.

PIN 3 on the 6802 is used as an input which controls the 'stretching' of the clock output (E) signal. When MR is low, E will be stretched integral numbers of half periods which allows interfacing with slow memories. For normal operation, MR should be tied high (it can be connected directly to V_{cc}).

PIN 4 — Interrupt Request (\overline{IRQ}).

A low level of this input requests that the microprocessor jump to an interrupt servicing routine upon completion of the current instruction if, and only if, the interrupt mask bit in the condition code register is not set (see discussion on interrupts).

PIN 5 — Valid Memory Access (VMA).

This does not have tri-state capabilities but when high it indicates that there is a valid address on the address buss. It is usually used in combination with an address decoder to enable peripheral devices.

PIN 6 — Non Maskable Interrupt (\overline{NMI}).

Similar to \overline{IRQ} except that the interrupt cannot be masked (see discussion on interrupts).

PIN 7 — Buss Available (BA).

This output signal is normally low but when high it indicates that the microprocessor has stopped and the signal lines are no longer under its control (those which have tri-state capability are placed in the high impedance state). This usually means that either the HALT line is low or the machine is in WAIT mode as a result of executing a WAIT instruction.

PIN 8 — V_{cc}

This is connected to +5 V from the power supply.

PINS 9 to 20, 22 to 25 — address lines.

These sixteen address lines give the microprocessor an addressing capability of 64K. The lines have tri-state capability only on the 6800.

PINS 26 to 33 — data lines.

Eight bidirectional lines which transfer data to and from peripherals. These lines have tri-state capability.

PIN 34 — Read/Write (R/W) line.

The microprocessor uses this line to indicate to the peripheral devices whether it wants to perform a read or write operation. It has tri-state capability and is high when the microprocessor is performing a read operation and low during a write. Its normal standby state is read (high).

PIN 35 — V_{cc} standby.

This line is only available on the 6802 (not used on the 6800) and applies the supply voltage to the first 32 bytes of the internal RAM as well as the RAM Enable (RE) logic. By ensuring that +5 V is applied to this pin when the microprocessor is powered down, data will be retained in this portion of memory.

PIN 36 — Data Bus Enable (DBE) on 6800; RAM Enable (RE) on 6802.

With the 6800, a high on the DBE input line permits data to be outputted during the microprocessor write cycle. This is replaced by the RAM Enable (RE) function on the 6802.

A high on this line enables the internal RAM which is fully decoded from \$0000 to \$007F. If external RAM or ROM exists at these addresses, a low should be applied to RE to disable the internal RAM.

PIN 37 — phase 2 clock on 6800; Enable (E) on 6802.

These two signals are equivalent and supply the clock signal to the microprocessor and the rest of the system. Note that this pin is an input on the 6800 and an output on the 6802.

PIN 38 — not used on 6800; Xtal on 6802.

This input connects one side of an external crystal to the internal oscillator. It is used in conjunction with pin 39.

PIN 39 — Three-State-Control (TSC) on 6800; Extal on 6802.

Applying a high to this pin on the 6800 places the microprocessor's tri-state lines into the high impedance state. On the 6802, the line is used as the other input from the external crystal (see pin 38) and is connected as shown in Figure 4.

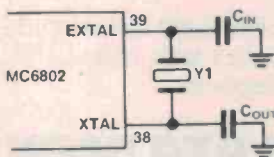

Y1	C _{IN}	C _{OUT}
3.58 MHz	27 pF	27 pF
4 MHz	27 pF	27 pF
6 MHz	20 pF	20 pF
8 MHz	18 pF	18 pF

Figure 4a. Crystal connections to the MC6802.

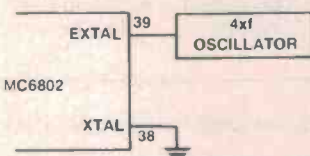

Figure 4b. External clock oscillator connection.

Since the 6802 includes a divide-by-four circuit as part of its internal oscillator, the crystal's frequency should be four times the required operating frequency, i.e.: 4 MHz crystal for a 1 MHz clock cycle.

Note also that the oscillator can be driven externally with a TTL input signal running at four times the required E clock frequency. It should be fed into pin 39 and pin 38 should be grounded in this case.

PIN 40 — Reset (\overline{RES}).

A low placed on this input resets the microprocessor. All information stored in the registers will be lost during this period. When the line is brought up to a high again, the microprocessor performs the restart sequence which includes setting the interrupt mask bit and loading the program counter with the contents of address location \$FFFE and \$FFFF. Execution then begins at this specified address.

Operation of interrupts

The 6800 and 6802 microprocessors allow for three types of interrupts: maskable, nonmaskable and software (note that reset could be treated as a nonmaskable overriding interrupt since it is serviced in a similar manner to the other types). Two of the interrupts are initiated by signals applied to external connections on the chip. The software interrupt is different since it is initiated by the program. Otherwise the servicing of each of the interrupts is very similar.

When an interrupt occurs, the microprocessor will first complete the current instruction. Next the contents of the internal registers are pushed onto the stack, i.e.: condition codes, accumulators A and B, index and program counter.

The insides

As already stated, the MC6802 is software compatible with the M6800. This implies that the internal structure is similar. Both microprocessors have six internal user registers:

accumulator A	8-bit
accumulator B	8-bit
index register	16-bit
program counter	16-bit
stack pointer	16-bit
condition code reg	8-bit

Both accumulators are used as temporary storage registers for results from logical and arithmetic operations and for data manipulation. Depending on the results of many of the operations, any of six condition codes can be set or cleared to indicate various conditions. These codes form the lower six bits of a special register and they indicate the status of these conditions: half carry, interrupt mask, negative, zero result, two's complement overflow and carry/borrow.

The program counter contains the address of the next byte to be fetched and is incremented automatically. The stack pointer is a register that contains an address where the status of the microprocessor registers can be stored when some other function needs to be performed. Bytes can be 'pushed' onto the stack (data actually stored at the address pointed to and the pointer is then decremented) or 'pulled' off the stack (the pointer is incremented and the data is read).

address (hex)	contents
FFFF	LSB of restart address
FFFE	MSB of restart address
FFFD	LSB of start address of NMI service routine
FFFC	MSB of start address of NMI service routine
FFFB	LSB of start address of software Interrupt service routine
FFFA	MSB of start address of software interrupt service routine
FFF9	LSB of start address of IRQ service routine
FFF8	MSB of start address of IRQ service routine

Table 2. Location of the interrupt vector addresses.

The only exception here is the maskable interrupt where the mask bit in the condition code register is first tested to see if the interrupt is allowed. If it is allowed then the interrupt will be serviced by the method to be described, otherwise program execution proceeds as normal.

After saving the registers, the \overline{IRQ} mask bit is set to inhibit any other interrupts. Then the program counter is loaded with the address of the appropriate interrupt service routine. These addresses are found in the eight highest locations in memory and are listed in Table 2. Program execution jumps to the specified location where hopefully the programmer has placed an appropriate service routine.

The interrupt service routine usually ends with the Return From Interrupt (RFI) command which tells the microprocessor that servicing is complete and that it can restore all the registers to the same status as before the interrupt. Execution then continues with the instruction that would have been executed if the interrupt hadn't occurred.

From the software point of view, the 6800 and 6802 have seven addressing modes which can be used by the programmer. They are: accumulator, implied, immediate, direct, extended, indexed and relative addressing modes.

These will not be discussed here but are explained quite well in the two books which are on special offer this month.

So as you can see, the MC6802 is a more versatile device than the M6800 and is well suited to forming the CPU of a minimum component system for dedicated applications. Next month we'll look at such a system.

References

1. Bishop, Ron, *Basic Microprocessors and the 6800*, New Jersey, Hayden Book Company, Inc.
2. Staugaard, Andrew C. *How to Program and Interface the 6800*, Indiana, Howard W. Sams & Co., Inc.
3. Motorola, *MC6802 data sheet*.

Train at home for a better career

Choose from 32 opportunities!

Now without attending school or university, without any previous experience, you can train at home in your spare time for a money making career... even obtain a Career Diploma. Send for free facts about the exciting programme that interests you most. Mail coupon today and you will receive complete information that shows you how easy it is to qualify for a great new career or advancement in your present job.



SEND FOR FREE FACTS!
International Correspondence Schools
400 Pacific Highway, Crows Nest
NSW 2065

YES! Please send me without cost or obligation free facts on how I can study at home for the career I have chosen.

TICK ONE BOX ONLY!

- | | |
|---|---|
| <input type="checkbox"/> Computer Programming | <input type="checkbox"/> TV Technician |
| <input type="checkbox"/> Business Management (IBA) | <input type="checkbox"/> Sales/Marketing (AMI) |
| <input type="checkbox"/> Executive Management | <input type="checkbox"/> Civil Engineering |
| <input type="checkbox"/> Small Business Owner | <input type="checkbox"/> Electrical Engineering |
| <input type="checkbox"/> Refrigeration/Air Conditioning | <input type="checkbox"/> Mechanical Engineering |
| <input type="checkbox"/> Hotel/Motel Management | <input type="checkbox"/> Pharmacy Assistant |
| <input type="checkbox"/> Practical Accounting | <input type="checkbox"/> Secretarial |
| <input type="checkbox"/> Management Accounting | <input type="checkbox"/> English Language |
| <input type="checkbox"/> A.C.I.S. Coaching | <input type="checkbox"/> Recreational Art |
| <input type="checkbox"/> Auto Mechanic | <input type="checkbox"/> Commercial Art |
| <input type="checkbox"/> Motorcycle Maintenance | <input type="checkbox"/> Photography |
| <input type="checkbox"/> Building | <input type="checkbox"/> Interior Design |
| <input type="checkbox"/> Builder's Draftsman | <input type="checkbox"/> Guitar |
| <input type="checkbox"/> Drafting | <input type="checkbox"/> Commercial Writing |
| <input type="checkbox"/> Architecture | <input type="checkbox"/> Short Story Writing |
| <input type="checkbox"/> Electronics | <input type="checkbox"/> Dressmaking |

Mr/Mrs/Ms _____

Address _____

P/code _____ Phone (Home) _____

Tick Here if Full Time Student

0744



Synertek
Incorporated



Rockwell
International

6500 PRICES SLASHED Upgrade to 2MHz with these LOW Prices

6502A	CPU, 40 Pin, Clock, 64K	A\$ 5.83
6511AQ	Single Chip Micro, CPU, RAM, etc	26.44
6541AQ	Periph. Controller, RAM, I/O Host Slave I/F	19.25
Z8-03	2801 Pin Compatible, 24 Pin Piggyback	78.62
6522A	VIA 40 Pin two bit I/O Ports	5.13
5632A	COMBO 40 Pin	6.86
6545A-1	or 6545-1PE CRT Controller	11.41
6511A	ACIA 28 Pin	7.24
6592	Single Chip Printer-Controller (for Epson Series 200 and 500)	27.34
1791-02	FDC 40 Pin	31.80
1793-02	FDC 40 Pin	31.80
2661-1	Sync/Asyn Coms I/F 28 Pin	14.14
2128	2K x 8 RAM 120 nSec LP mode	5.52
4164	64K x 1 Dynamic RAM	7.72
2532	4K x 8 Industry Standard EPROM	6.16
QUIP64	Socket for 6511AQ and 6541AQ	1.78
CRYSTALS	1.8432MHz, 2.00MHz, 32.768KHz, 3.686MHz, 8.00MHz, 4.00MHz, 12.00MHz	2.75

Plus Sales Tax, Postage and Pack. (where applicable)

PO Box 6502,
GOODNA 4300
Brisbane
Australia
Tel 07-288 2757
Telex AA43778 ENECON



3 Edgeware Rd
Wadestown
WELLINGTON
New Zealand
Tel 4-72 6462

You need not own a bank to have a personal computer, Look at our prices.

48K Ram Z80 CPU with intelligent keyboard 188 function keys, 10 user define keys \$360



64K Z80 & 6502 CPU IBM look-a-like case detachable keyboard 188 function keys, 10 user define keys \$480



12" green & amber monitors high frequency, from \$110

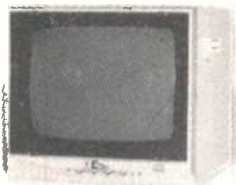

Floppy disk drivers suitable Apple II, from \$230



Dot matrices printers using continuous and sheet paper \$275

Daisy wheel printer, letter quality \$575



Floppy Disks 5 1/4" and 8" S/S, D/S, S/D & D/D, from \$2.50



Add on Cards, 80 column, Parallel cards, Rs232 Serial card, Disk Card (2), Pal card, Printer card, Clock card, Eprom writer Card, Speak Card.

Ring or write for details and our free catalogue.

G.C.S. Sydney — 67 Blackshaw Ave., Mortdale. 2223. Phone 570-1215

Wollongong — 46 Charles Road, Fairy Meadows. Phone (042) 84-5544.

Enquiries from agents and distributors invited.

We've searched and compared data sheets and catalogs from over 500 manufacturers ... SO YOU WON'T HAVE TO.

Now you can locate the exact device that will solve your design and replacement problems in minutes with:

- SIDE-BY-SIDE COMPARISONS of devices shown in a standard format
- SEQUENCING OF DEVICES — by type number
- CROSS-REFERENCING OF SYSTEMS AND DEVICES
- CROSS INDEXING — type numbers to generic numbers
- DETAILED DRAWINGS — logic, block, board and pin diagrams

D.A.T.A. BOOKS

gives you effortless answers to your design questions.

- Software
- Discontinued Devices
- Discrete Devices
- Power Supplies
- Integrated Circuits
- Modules/Hybrids

Call or write for free information.

J.H. BOOK SERVICES PTY LTD

75 Archer Street, P.O. Box 311, Chatswood, N.S.W. 2067.

Sole Representatives for D.A.T.A. Inc. in Australia, New Zealand & Papua New Guinea. Phone: (02) 419 7779 Telex: 27621.

SPECIAL READER OFFER

BOOKS ON 6800 MICROPROCESSORS

Here's an unbeatable opportunity to get all the fundamental information you need on the 6800-series microprocessors at a cost of around half what you might pay. If you're considering getting into the project series featuring 6800-series microprocessors, or you're studying them at University or Tech. College, then these books provide essential background and information on the subject.

BOOK 1. Basic Microprocessors and the 6800

Written by Ron Bishop, Manager of the Motorola Semiconductor Group Technical Training division in the US, this is the "fundamental" text on the 6800. This book assumes nothing, save a high school science background. It starts right at basic electronic principles, goes on to explain logic elements, number systems, decimal, binary and hexadecimal, digital arithmetic, what are microcomputers, programming concepts, addressing modes, 6800 software, the 6800 micro family, system configuration, example programs and the M6800 instruction set summary. It's all there. Straight from "the prophet's" pen. All in 262 pages with a comprehensive index, measuring 152 x 228 mm. The US price on this book is US\$14.95, which means it would normally sell here for around \$25-\$30.

SPECIAL OFFER PRICE \$15.00!

BOOK 2. How to Program and Interface the 6800

This book has been written to get you and your 6800 microprocessor into "the real world". Written by Andrew C. Staugaard, an award-winning engineer/educator in microelectronics, this book is a practical introduction to using the 6800 and includes experiments (based on the Heath ET3400 and Motorola MEK6800D2 trainers). This book introduces fundamental microprocessor concepts, talks about the ET3400 and MEK6800D2 trainers, then goes on to 6800 logic and data handling, the code registers and their operation, 6800 branching/indexing and stacks, 6800 input/output, interfacing with memory, peripheral interface adaptors (6820/6821), 6800 system interfacing and four appendixes covering basic logic, number systems and computer arithmetic, the 6800 instruction set and various data sheets. Its 414 pages are chock-full of well-organised and well-written material. 136 x 216 mm. A comprehensive index is included. The book's US price is US\$15.95 and it would normally sell here for near \$30. It is currently sold through ETI's Book Sales for \$22.95, but it's been marked down for this special offer.

**SPECIAL OFFER PRICE \$18.00!
(save 26%!)**

This special offer, exclusive to ETI readers, is being made by Avtek in conjunction with Electronics Today magazine. ETI is acting as a clearing house for orders. All orders will be despatched by post following clearance of cheques, etc. Please include postage charges as indicated. Books will be delivered ex-stock, but demand may be heavy, so please allow up to four weeks for delivery (from receipt of order) to cover order processing and any mail delays.

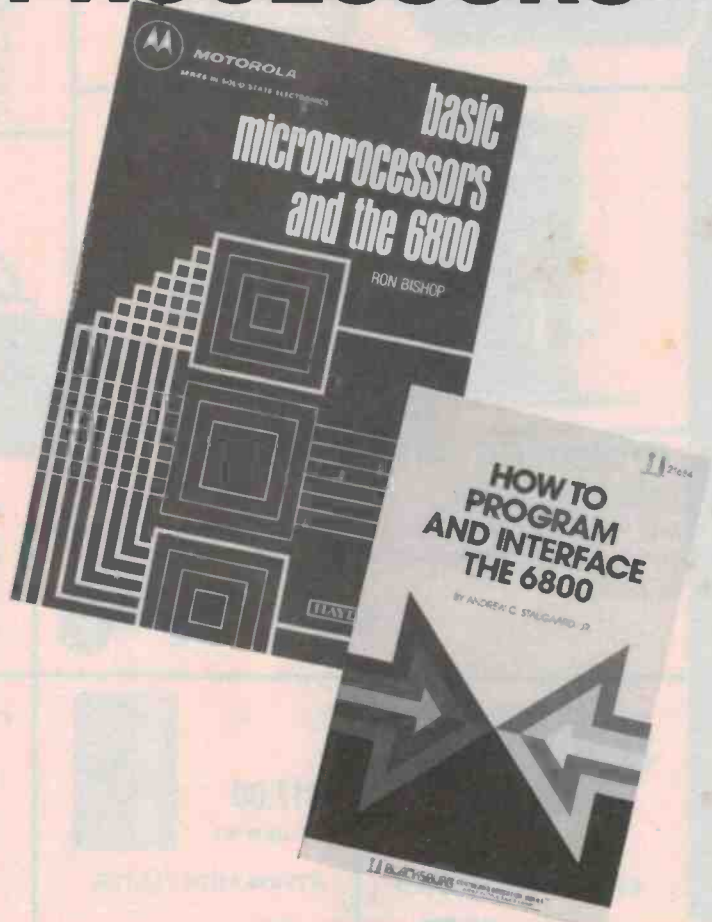

HOW TO ORDER YOUR 6800 LIBRARY

Fill out the coupon here, or a photostat of it if you don't wish to cut your magazine. Enclose a cheque, bank cheque, money order or fill out your credit card details for the amount required, not forgetting the postage and handling charges. Make cheques, etc, out to ELECTRONICS TODAY 6800 BOOKS OFFER. Send the coupon to:

**ETI 6800 BOOKS OFFER c/o ETI Magazine
P.O. Box 227 Waterloo NSW 2017**

Tick box to indicate payment:

American Express Bankcard Cheque*

Credit Card No:

--	--	--	--	--	--	--	--	--	--	--	--	--	--	--	--	--	--	--	--

Card Expiry Date: _____

Cheque or Money Order No. _____

Signature _____

Name _____

Address _____

Postcode _____

COUPON

Please rush me: copies of **Basic Microprocessors and the 6800**
@ \$15 each, plus \$2.50 post & handling.

..... copies of **How to Program and Interface the 6800**
@ \$18 each, plus \$2.50 post & handling.

OR

..... set(s) of **both books** @ \$33, plus \$5.00 post & handling
(For airmail outside Australia, please add A\$5.00 to these charges)

I enclose \$ total.

NOTE: Offer closes 31st May, 1984.



ETI-274 damn fast NiCad charger
 This project is specifically designed for modelers and photographers who make heavy demands on NiCad batteries quite routinely. There's nothing more frustrating than having your RC model run out of juice as it runs out of sight, or your flash run out of flash at an inopportune moment. If you use NiCads and need a quick charge then this project is for you.
 ETI FEB 1984



\$49.50 ETI FEB 1984
ETI-676 RS232er for the Microbee
 The Microbee, among other home computers has a sort of RS232 port in that it doesn't implement the negative-going portion of its output signal (Tx0). Most peripherals with an RS232 input can cope with that, but inevitably, there are those that can't. This project fixes that.



ETI JAN 1984
ETI-675 Microbee serial-to-parallel interface
 When you're on a good thing... Here's another Microbee project, but this one can be readily adapted to other machines, too.



ETI-1502 ELECTRONIC "SLINGSHOT" PSYCHROMETER — WET BULB/DRY BULB HUMIDITY METER
 A whizzer of a project. It's an electronic version of the weather man's wet bulb/dry bulb humidity meter. Uses two copper-constantan junctions, one 'wetted' with damp gauze or cotton wool. The temperature difference between the two thermocouples is measured by a sample-and-hold circuit so that, when you've finished 'whizzing' the temperature difference can be measured with a digital multimeter directly from the volts scale.
 P.O.A.
 ETI DEC 1983

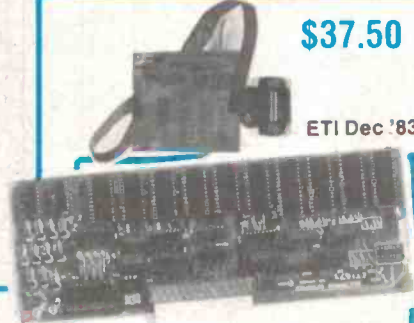

\$37.50 ETI Dec '83
ETI-674 MICROBEE PROPORTIONAL JOYSTICK CONTROLLER
 Oh the joy of a 'proper' joystick! Most computer joysticks are of the switch type. But, when you want to get into some 'real' joystick action, nothing beats a proportional joystick with potentiometers. This straightforward project for the Microbee, in our continuing popular series, simply plugs into the Bee's parallel port.



ETI Nov '83
ETI-673 MICROBEE \$99.95
MULTIPROM INTERFACE
 This project allows extension of the Microbee's ROM capacity. It plugs into the Bee's 50-way expansion buss and can either be fitted inside or externally, giving 11 open-collector outputs and eight buffered inputs. Turns your microbee into a really versatile machine.

Project HE-106 — Radio Microphone.
 All kinds of uses for this microphone/transmitter. Only needs an ordinary FM radio to detect its signals.
\$9.50



ETI Nov '83
ETI-272 AUDIO POWER LEVEL INDICATOR
 This is a simple project that employs three LEDs. To suit installation in the series 4000 or series 5000 amplifiers. This project is more useful than a simple clipping indicator (your ear is better at that!) and cheaper and easier to install than a bargraph level display.



ETI-164 ZENER TESTER
 ETI MAY '83 **\$9.50**
 A simple, low cost add-on for your multimeter. This checks zeners and reads out the zener voltage directly on your multimeter. It can also check LEDs and ordinary diodes.



\$17.00 ETI JAN '83
ETI-334 AUTO TESTER

Just the thing to keep in the glovebox or toolkit to find those nasty electrical bugaboos that occur at awkward times. Simple to build; simple to use.



ETI JAN 1984
ETI-656 THE BUG DEBUGGER
 Ever burnt a program into EPROM and then found it wouldn't run? Without a logic analyser, it's difficult to debug the system. This project costs far less than a logic analyser and will get you out of that jam.

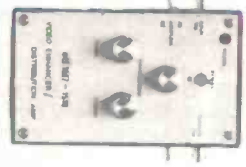

ETI-1518 VIDEO ENHANCER
 This simple to build project features three controls for curing video 'image ills' — floor, ceiling and enhancement. It's designed to be installed either 'stand alone' or in with the ETI-1517 Video Distribution Amplifier.
\$25.00 ETI DEC 1983



ETI-1516 \$41.50
MODEL ENGINE IGNITION SYSTEM
 Get sure starts every time and no more glow plug burnouts on your model engines.
 ETI JUNE '83



ETI JAN 1984
ETI-273 LET CALLER
 Play tennis anyone? This unit provides you with clear indication when a ball 'tips' the net in flight—requiring a LET call. Much more reliable than umpires and ball boys. Avoid disputes and tantrums (sorry Mac...). Cheap and simple to build.



ETI-1512 ELECTRIC FENCE TESTER
\$24.50
 ETI FEB '83

No more checking the 'feel' of a fence with a blade of grass (and maybe ending on your...). This project tells you how much your fence energiser delivers and can be used for fault-finding on a fence.



ETI-1515 DRILL/BLENDER SPEED CONTROLLER
\$27.50 ETI APRIL '83

This project provides a full range of speed control for appliances having 'universal' ac motors. Once the speed is set, the motor will maintain that speed from no-load to heavy-load. Great for drills, blenders, grinders, etc.

Errors & omissions excepted.

ROD IRVING ELECTRONICS
 425 High St., Northcote, Vic. 48-50 A'Beckett St., Melb., Vic.
 Phone (03) 489 8866, (03) 489 8131, Mail Order Hotline (03) 481 1436
 Mail orders to P.O. Box 235 Northcote 3070 Vic. Minimum P & P \$3.00.



Please address tax exempt, school, wholesale, and dealer enquiries to:
RITRONICS WHOLESALE
 1st floor 425 High St. Northcote 3070 (03) 489 7099
 (03) 481 1923 Telex AA 38897



Eight joysticks and a trackball reviewed

So you want to buy a joystick for your micro, but don't know which one to purchase (for the kids, of course!)? This review should help you come to grips with the problem.

Peter Moxom

THE ATARI-TYPE joystick has undoubtedly become the most popular format for games control on micros and video games machines. It's virtually an industry standard amongst manufacturers. However, there's *lots* of competition, with many accessory manufacturers getting 'on the bandwagon'. A huge variety of styles and models is now offered. If you're confused enough after choosing a micro or video game, you're going to be just as confused all over again trying to choose a 'better' joystick.

To clear away a fog of confusion, it was suggested to the Editor that a number of joysticks be obtained for review. All in good time, some eight joysticks arrived, along with one 'trackball'. The units reviewed were:

Atari — by Atari (the 'benchmark')
Quickshot — by Spectravideo
Mini Champ — by Championship Electronics
Super Champ — by Championship Electronics
Pointmaster — by Discwasher
The Boss — by Wico
Red Ball — by Wico
Red Stick — by Wico
Trackball — by Wico

Each unit was examined for control accuracy, fire button response, grip, con-

struction and suitability for right and left handers alike. A VIC-20 was used as the review machine with a variety of games kindly supplied by Ramond Bermeister of The Computer Spot, Shop C4, MLC Centre, Martin Place, Sydney.

Firstly, control accuracy would have to be the most important feature of any joystick to its user because, when using a joystick for its designed purpose — games control — you want to get away from those aliens and other nasties and zap, rather than be

zapped. To zap effectively, the fire button must have good response or else you're more than likely to be zapped!

Apart from the requirement of good fire button response, it must be well located. The best location for fire buttons is on the stick itself so that the joystick can be placed on a table, or other solid surface, making single-hand operation possible. The stick-located fire buttons are particularly suited to left hand users.

The table here gives a rating out of five for the four parameters, along with other pertinent details about the joysticks.

The trackball was a ring-in, supplied along with the Wico joysticks. Trackballs are relatively rare at present, probably for reasons of cost, but they have certain advantages in some applications although they don't match up to joysticks in general games control. Basically, they consist of a ball sitting on a set of rollers placed at right angles (X and Y axes). Attached to each roller mechanism is a light and detector arrangement that is 'cut' by a perforated disc. The light detector acts as a switch, in a similar manner to the switches on the joysticks.

Joysticks, internally, have four switches activated by the stick, giving eight control directions. The fire button is a separate switch.

Now for the reviews! ▶

DISTRIBUTORS

The units reviewed were kindly supplied by the following firms:

Atari and Wico: Futuretronics Australia Pty Ltd, 1076 Centre Rd, South Oakleigh, Vic. 3167.

Quickshot: Videoactiv, 70 St. Kilda Rd, St. Kilda, Vic. 3182.

Mini Champ and Super Champ: Computerplay, 16 Hertford Crescent, Wheelers Hill, Vic. 3150.

Pointmaster: Arena Distributors, 642 Albany Highway, Perth, W.A. 6000.



The Atari

The Atari only has one fire button, located on the top left of the base. The stick is very stiff in usage and very uncomfortable for long sessions. It's good for a 'benchmark', because every other manufacturer has tried to outdo it — and generally succeeded. But, it's still the cheapest!



The Super Champ

This, too, has a retractable cord that winds up in the base. The cord is a sensible length. The fire buttons are sensibly located — one trigger-style at the top of the hand grip, the other on the very top of the stick. Both have excellent response. The unit is comfortable to use in the hand. The base has suction caps so is best for table use, rather than held in one hand — which I found uncomfortable. Construction is just acceptable, the design covers this up.



The Quickshot

This one was early on the market and 'set the standard' for many others to follow. It has suction caps on the base and a contoured hand grip with fire buttons both on the base and stick. I found it hard to use as an in-hand joystick (which is the Atari's main mode) but it is good for use on a table or floor. Construction seemed flimsy, confirmed by its being prone to breakage. It's no better than the Atari in this regard.



Pointmaster

This joystick is well thought out in design and has excellent response for directional control and the fire buttons. It is also sensibly priced. The stick has more movement in the forward direction than the rearward direction, equal movement left and right, although I don't know that that's much of an advantage. If it is, it's very subtle. In general, stick movement is greater than most of the others reviewed but ensures that you move your 'piece' in the direction intended.

Construction is 'solid', above average, but not as good in this area as the best reviewed. The Pointmaster is ideal for either right or left hand users. It has only one fire button, located on top of the stick. The base is smaller than most and most comfortable to hold in your other hand, I found.



The Mini Champ

Clearly, this one was designed for competition use by under-15s. It fits small hands . . . er, like the proverbial. It has three fire button locations — one on top of the stick, two on the base. Thus, it suits right or left handed use. The cord is retractable and winds up inside the base. I found it hard to hold in my hand at first, but it became easier the more I used it. Response in control is reasonable, construction is average, somewhat better than the Atari and it's competitively priced.



The Boss

Made by Wico this joystick is distributed by the video games company in Australia — Futuretronics. The grip on this stick is suited not for small hands, but *minute* hands (obviously aimed at the Irish Leprechaun market). The single fire button, located atop the stick, is hard to get your thumb around as it is tall and square and exhibits no 'feedback'. Control accuracy is good, but maimed by the grip. In all, a *very* disappointing product from Wico who normally produce an excellent product.



The Red Stick

Aptly named, this is another one from Wico. This must be the best joystick I've ever used — it has *unbelievable* response in directional control and with the fire button. Left handers should have no problems with this one as there is a fire button atop the stick. Movement is *very* smooth — only hampered by the price! Five marks in all categories.



The Red Ball

Brother to the Red Stick, again from Wico. Another 'miracle' joystick, it only lets the side down in the grip. I found it hard to get a good grip, at first, but once perfected it's as good as the Red Stick.



The Trackball

Yet another Wico creation. I think this is really a gimmick for games control in that, in general, it's hard to control — particularly at speed, and is only suited to right hand players. I found it over-sensitive, a sneeze will throw your piece right off course. Once the novelty wears off, it's only another one for the toy heap at the bottom of the wardrobe. This is unfortunate because some games are suited to a trackball style of control. If the price weren't so high, it would probably be a big hit, I suspect.

Conclusion

In concluding, I would like to say that the Wico Red Stick is leaps and bounds ahead of the rest of the field, but it costs \$45, which is a consideration. When considering value for money the Pointmaster, I feel, would definitely be the best. At only \$25 (5c change), it is an excellent buy.

ATARI QUICKSHOT MINI CHAMP SUPER CHAMP POINTMASTER THE BOSS WICO REDSTICK WICO REDBALL WICO TRACKBALL

	ATARI	QUICKSHOT	MINI CHAMP	SUPER CHAMP	POINTMASTER	THE BOSS	WICO REDSTICK	WICO REDBALL	WICO TRACKBALL
CONTROL ACCURACY	2	3	3	4	5	4	5	5	2
BUTTON RESPONSE	2	3	3	5	5	3	5	5	5
GRIP	1	3	4	4	5	2	5	4	N.A.
CONSTRUCTION	2	2	3	3	4	4	5	5	5
CORD LENGTH (metres)	1.22	1.24	1.21	2.95	1.61	1.64	1.53	1.56	1.68
L or R HANDED	R	R or L	R or L	R or L	R or L	R or L	R or L	R or L	R
FIRE BUTTON LOCATION(S)	BL	BL, ST	BL, BR, ST	ST, SG	ST	ST	BL, ST	BL, ST	BL
NO. OF BUTTONS	1	2	3	2	1	1	2	2	1
PRICE (rrp)	\$19.95	\$24.95	\$24.95	\$29.95	\$24.95	\$29.95	\$44.95	\$49.95	\$89.95

NOTES: BL = bottom left; BR = bottom right; ST = stick top; SG = stick grip.

LOWEST PRICES -

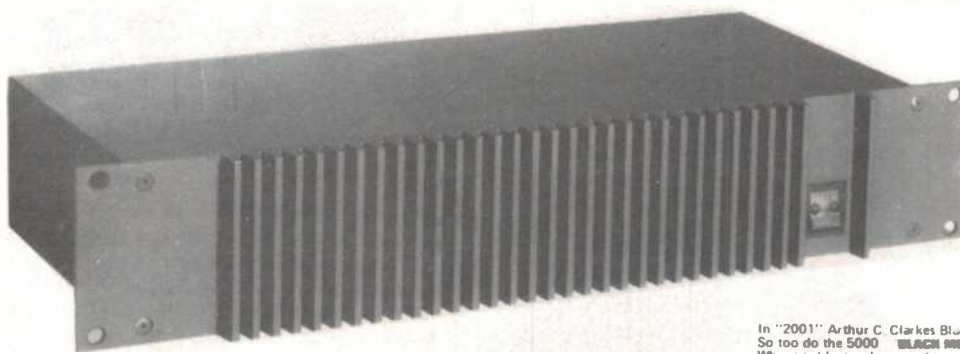

5000 POWER AMPLIFIER

REF: ETI JAN/MARCH 1981

"BLACK MONOLITH"

- THE CLASSIC POWER FET DESIGN
- SOLID ALUMINIUM FOUNDRY CAST AND MACHINED FRONT PANEL HEATSINK. SUPERFINISH
- DUAL 200V.A. POWER SUPPLIES WITH 35A BRIDGE AND 32,000uF OF FILTERING!!
- PROFESSIONAL 19" RACK MOUNT CONFIGURATION **CAT KE 4200**

In "2001" Arthur C. Clarke's Black Monolith symbolised awesome power - intelligence. So too do the 5000 **BLACK MONOLITH** Power Mosfet amp kits from Jaycar. Why would you choose a Jaycar **BLACK MONOLITH** 5000 Power amp kit over conventional kits? Because you too, are intelligent.

You have seen the specs, and you know that this amp IS the best. You want the best because (whether you know it or not) you are a perfectionist. You won't be conned by cheap and nasty compromises to David Tillbrook's brilliant design. You will want to know if there have been mods to the original design. (There have - and only Jaycar kits reflect them). But let's be specific about the improvements - Completely redesigned flag heatsinks for the Driver Transistors. Thoroughly endorsed by David Tillbrook. (The original ones were too small if the bias current was set high for low distortion). Ventilation grilles in the covers. These were not included in the original design.

- Blind tapped holes in the exclusive "Superfinish" front panel. Heavy gauge screws used for stronger connection of the heatsink bracket to the panel.
- Jig drilled, EXTRUDED deburred and black anodised heatsink bracket in heavy gauge. All other kits we have seen, a flimsy punched out piece of sheet metal is supplied. Not even anodised!! This is one of the most critical components in the kit.
- Beryllium Oxide heatsink washers supplied. A tube of heatsink compound is also supplied with enough left over to use elsewhere.
- "Superfinish" Front Panel. Despite what others may claim ours is still the best.
- Dual 3 Pin DIN 30V Power Outlets. This extra power outlet enables you to power extra 5000 series components as they arrive on the scene.
- And all of the extra features of our notorious 5000 amp, like Metal IX film resistors. Pre wound chokes, Fibreglass PCB's, Heavy duty earth lead, Quality capacitors, Original chassis bar design, Flux shoring strips on transformers etc, etc.

The Jaycar **BLACK MONOLITH** is worth far more than the inferior kits around the market today. However, in some cases it costs no more!! Remember you only get out of a product what you put in to it and the performance of Jaycar kits is measured IN RESULTS.

Jaycar has two versions of this kit, the **BLACK MONOLITH** (see right) and our budget (but still high quality) version. The Jaycar budget 5000 Mosfet still contains many of the exclusive features of the **BLACK MONOLITH** and is still far better than any full 5000 amp kit under \$300.

You get the same chassis and exclusive "Superfinish" front panel so your amp will still look great. The main difference between the two is that you do not get the Beryllium Oxide washers (Mica supplied), heatsink grease, the special driver transistor heatsinks (original ones supplied), ventilated cover and dual 3 pin DIN power outlets (single supplied).

If you are on a tight budget this is the amp for you. You will not be able to hear the difference between either version.

ONLY \$299 FOR THE COMPLETE KIT

COMPLETE BLACK MONOLITH KIT ONLY \$319

LABORATORY MEASURED PERFORMANCE

POWER OUTPUT	Around 100W RMS into 8 ohms (both channels driven)
FREQUENCY RESPONSE	8Hz to 20kHz $\pm 0 - 4$ dB 2.8Hz to 65kHz $\pm 0 - 3$ dB Note: These figures are determined solely by passive filters.
INPUT SENSITIVITY	1V RMS to 100W output
HUM	100dB below full output (flat)
NOISE	116dB below full output (flat 20kHz bandwidth)
2nd HARMONIC DISTORTION	0.001 at 1kHz (0.0007% on p aotopes) at 100W output us ing a 56V supply at d at 4A continuous 0.003 at 10kHz at 100W
3rd HARMONIC DISTORTION	0.003% for a. f. f. is less than 10kHz at all power s below cl p p ng
TOTAL HARMONIC DISTORTION	Determined by 2 rd ha n o n c i s t o t on (see above)
INTERMODULATION DISTORTION	0.003% at 100W (50Hz at d 7kHz mixed 4:1)
STABILITY	Unconditional

5000 CONTROL PREAMPLIFIER FEATURING A MOVING COIL CARTRIDGE PREAMP WITH UNBELIEVABLY LOW NOISE FIGURES



"BLUEPRINT"

REF: ETI JUNE/OCT 1981

CAT KE 4202

SPECIFICATIONS

Frequency Response	High level input 15Hz 130kHz $\pm 0 - 1$ dB Low level input conforms to RIAA equalisation $\pm 0 - 2$ dB (see data on Phono specs)
Distortion	1kHz $\pm 0.003\%$ on all inputs (limit of resolution on measuring equipment due to noise level)
S/N noise	High level input: master full with respect to 300mV input signal at full output (12V) 92dB flat ± 100 dB A weighted MM input: master full with respect to full output (12V) at 5mV input 500 ohm source resistance connected ± 85 dB flat ± 75 dB A weighted MC input: master full with respect to full output (12V) and 200V Gain ± 74 kHz ± 71 dB flat ± 75 dB A weighted
ETI 478MW MOVING MAGNET INPUT STAGE	
Gain	74 1kHz
Frequency Response	Conforms to RIAA Equalisation $\pm 0 - 2$ dB
Total Harmonic Distortion	0.001% 1kHz 10mV RMS
Headroom	± 2 dB in respect to 5mV RMS input signal ± 135 mV RMS
Noise	Total equivalent input noise 122mV A input shorted 216mV flat input shorted
S/N ratio	Flat 1mV 5mV 10mV A weighted 73dB 87dB 93dB 78dB 92dB 98dB
ETI 478MC MOVING COIL INPUT STAGE	
Gain	24
Frequency Response	7Hz ± 135 kHz $\pm 0 - 1$ dB
Total Harmonic Distortion	$\pm 0.003\%$ 1kHz 30mV input
Noise	Total equivalent input noise 83mV flat input shorted 42mV A input shorted 56V flat after RIAA E input shorted 34V A after RIAA E input shorted

The refinement to this preamp has been incredible. At one stage we had two versions of the preamp but people were only interested in the Blueprint. Now we only have the Blueprint. Why is the Blueprint so good? Well, there are many reasons but a few of the main ones: Firstly, we use a far, far superior screened cable in the kit. It is much lower in capacitance than the cheap imported excuse for screened cable found in ALL other versions that we have seen. This cable is made in Australia especially for us and costs over 5 times more than the imported junk. When you consider that over THIRTY FEET of screened cable runs around inside the preamp you will appreciate the low capacitance cable. High capacitance cable in signal lines could effect high frequency performance.

We use a specially selected version of the LM394 ultra matched transistor for the moving coil preamp. It is a whisker better than the other LM394's and part of our Blueprint philosophy.

We employ HARD (not soft) gold plated RCA input sockets on ALL INPUTS (previously just M.C.). Probably a bit extravagant (except M.C.), we think, but nice. A pair of solid metal, gold plated RCA line sockets are provided to connect to your M.C. cartridge. Special Nylon mounting grommets are provided for all input and output sockets. Far superior to squishy and perishable rubber grommets provided in other kits. Extra touches like roller tinned PCB's (to reduce dry or noisy solder joints), 1% metal film resistors, quality I.C. sockets where practicable, English 'torlon' low noise selector switches, special rear panel, solid machined matching aluminum knobs and specially polished rectangular (multicoloured) LEDs, add up to a classic kit.

Like the Black Monolith the Blueprint is the intelligent choice. Even if you were a millionaire and could afford anything you probably would do no better spending virtually any amount of money more.

THE BLUEPRINT IS UNBELIEVABLE VALUE FOR MONEY AT ONLY \$299 FOR THE COMPLETE KIT

- FUNCTIONS**
- MOVING COIL INPUT
 - MOVING MAGNET (DYNAMIC) CARTRIDGE
 - INPUTS (2 OFF)
 - TUNER INPUT
 - AUX INPUTS (2 OFF)
 - TAPE INPUTS (2 OFF)
 - INPUT LEVEL CONTROL
 - TAPE OUTPUTS (2 OFF)
 - 4000Hz CALIBRATION OSCILLATOR
 - LED AVERAGE IVU1 & PEAK
 - LEVEL METERS 48dB to ± 9 dB
 - MODE SWITCH, STEREO
 - BALANCE CONTROL
 - LINE OUT MONITOR OUT
 - MONITOR VOLUME CONTROL
- FEATURES**
- EXTREMELY CLOSE TRACKING TO RIAA PHONO EQ
 - GOLD PLATED CONNECTORS ON ALL INPUTS
 - ENGLISH LORLIN LOW NOISE SELECTOR SWITCHES
 - LOW NOISE 1 50ppm METAL FILM RESISTORS USED
 - TINNED FIBREGLASS PCB
 - LOW CAPACITANCE SCREENED CABLE USED THROUGHOUT
 - DUALITY I.C. SOCKETS
 - SPECIAL REAR PANEL
 - MULTICOLOURED RECTANGULAR LED, USED

JAYCAR QUALITY

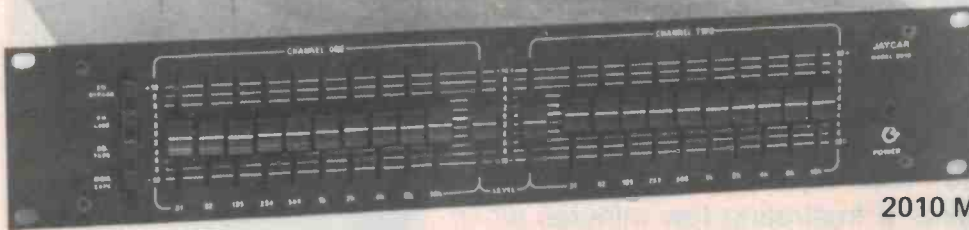

ONLY
\$139

2010 Mk IIA

For those whose budget does not extend to \$389, may we suggest the 2010 MkIIA Octave (10 band) Equaliser. This unit is rack mounted in the same format as the 5000 series Equaliser. It is stereo (in one 3 1/2" high cabinet) with one slider per octave. It represents a refinement of the ETI 485 graphic and, as you can see is no slouch when it comes to performance.

The 2010 is a two channel graphic equaliser featuring 10 adjustable controls on octave centre frequencies (independent for each channel). Each control provides up to +14dB of adjustment. Each channel is also equipped with a level match control giving an overall gain of adjustment of +14dB. The functional versatility of the 2010 equaliser is unsurpassed. Eight modes of operation are available from the push button switches on the front panel. Included amongst these are the ability to equalise both recording and playback when dubbing tapes. The 2010 has been designed to be compatible with all commercially available equipment and is ideal for use in a Hi Fi system or P.A. system.

CAT
KE 6535

SPECIFICATIONS

ELECTRICAL (EACH CHANNEL)
FREQUENCY RESPONSE
EQ LINE OR TAPE
EQ BYPASS
SIGNAL TO NOISE RATIO
2 VOLTS OUT CONTROLS FLAT
TOTAL HARMONIC DISTORTION
1 VOLT OUT CONTROLS FLAT
OUTPUT IMPEDANCE
RATED OUTPUT
OUTPUT AT CLIPPING
INPUT IMPEDANCE
MAXIMUM INPUT VOLTAGE
EQ CENTRE FREQUENCIES

0.5dB 10Hz to 20kHz, Controls flat
Flat
Greater than 8:1dB
Less than 0.4% 20Hz to 20kHz
100 ohms
2 Volts RMS into 10K Load
10 Volts RMS
50K Resonant
10 Volts RMS
31, 62, 125, 500, 1K, 2K, 4K, 8K, 16K,
Hz - 10%

RANGE OF CONTROLS
INDIVIDUAL FILTERS
LEVEL MATCH

+12dB at Centre Frequency
-10dB

CONTROLS
EQUALISATION
LEVEL
EQ BYPASS
EQ LINE
EQ TAPE
MONITOR TAPE
POWER
TERMINATIONS
PHYSICAL
DIMENSIONS
WEIGHT
FINISH

10 Vertical Slide Controls for each channel
Vertical Slide Control each Channel
Pushbutton Switch
Pushbutton Switch
Pushbutton Switch
Pushbutton Switch
Pushbutton Switch with LED indicator
Rear panel RCA sockets for both input and output connections

483mm x 89mm x 152mm
6 1/2" x 3 1/2" x 6 1/8"
4 kg
Front panel brushed, black anodised Aluminium
slit screened bezelling, Black Maxigrip covers

Infra-Red Movement Detector

The Infra-red or IR Detector for short, falls into the Black Magic category. It basically is a high gain passive tuned receiver of a particular IR band. The heart of the unit consists of a high gain lens (antenna?) which has a "Commutated" field of view. Its reception pattern is count-like, but highly tuned to the IR wavelength of human bodies.

When a human passes within proximity of the pick-up area, the lens will selectively pick up IR radiation and then not.

Movement across the pick-up area will result in a series of pulses sent to a detector circuit.

IR detectors are very reliable as they do not transmit and will not respond to non heat radiating objects. Curtains for example, can wave about without tripping the alarm. Even the cat is unlikely to trip the unit.

The "Arrowhead" is the latest of a series of IR Detectors that we have sold. It represents the latest developments.

Features:

- 40 x 30' Range
- 12V D.C. Powered.
- Small 4 1/2" x 2" x 1 1/2"
- Double Sensor
- Computerised O.C. to Lower failure rate
- Built In test lamp
- Tamper switch included
- Alarm Output JPST 30 V DC @ 1 AMP.

Cat. No. LA5017

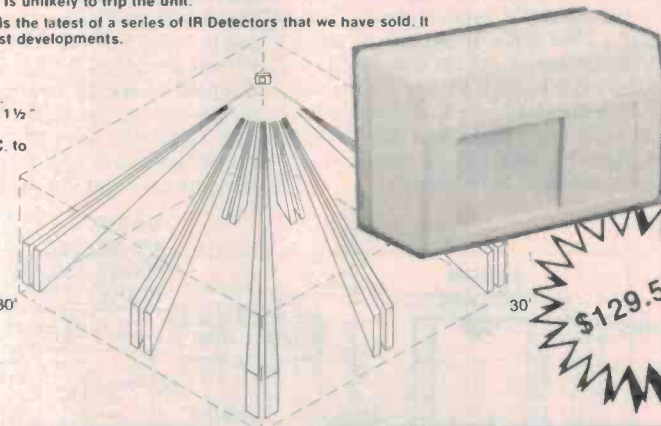

THE RED FLASHER

Car theft has risen dramatically recently, is your car safe? Thieves stay away from cars which have those expensive flashing light alarms. The ones with the red square pushbutton switch that flashes.

Now you can make your car look like it has one of those alarms, whether you have one or not.

We supply a quality Swiss pushbutton illuminated square switch and the electronics to make it flash. We even put in two deterrent stickers. ALL THIS PEACE OF MIND FOR ONLY \$20.95.

KJ 7000.

IGNITION KILLER FOR CARS

See EA Feb. '83

This kit could well save your car from being one of the 70,000 cars stolen each year in Australia.

The kit is simply connected in parallel with the points.

Easy to build.

Complete with two deterrent stickers.

Cat. No. KA1535



Jaycar Incorporating 40' ELECTRONIC AGENCIES

SYDNEY SHOWROOMS

117 YORK STREET - PHONE: (02) 264 6888 and (02) 267 1614

CARLINGFORD TELEX: 72293

Cnr. CARLINGFORD & PENNANT HILLS ROAD - PHONE: (02) 872 4444

CONCORD

115 - 117 PARRAMATTA ROAD - PHONE: (02) 745 3077

HURSTVILLE 121 FOREST ROAD - PHONE: (02) 570 7000

NUMBER 1 FOR KITS

POST AND PACKING CHARGES
\$5 - \$9.99 (\$1.50) \$10 - \$24.99 (\$3.20)
\$25 - \$49.99 (\$4.50) \$50 - \$99.99 (\$6.50)
\$100 - \$198 (\$8.00) Over \$199 (\$10)

Free INSURANCE for Road & Registered Post over \$200
All heavy or bulky items (over 20kg.) sent Comet Road Freight \$12.00 anywhere in Australia.

SHOP HOURS CARLINGFORD, CONCORD & HURSTVILLE
Mon - Fri 9am - 5.30pm Sat - 9am - 12pm Thurs night 8.30pm

SHOP HOURS SYDNEY
Mon - Fri 8.30am - 5.30pm Sat - 8.30am - 12pm Thurs night 8.30pm

MAIL ORDERS AND CORRESPONDENCE: P.O. Box 185, Concord, 2137



Mail Order
By



BANKCARD
Via Your Phone

A ROM reader for the Microbee

So you've written your 32K 'Adventure' program and you're impressing all your friends with the graphics and the witty text — but they're not impressed at how long it takes to load the goldang program from tape! Then again, loading those short, useful utilities from tape takes a frustrating few minutes when you're hot to get on with the job. This project fixes that — transfer those tape programs to EPROM and load them with the ROM Reader.

Paul Leonardi

THIS PROJECT enables your favourite games or utilities to be loaded into your Microbee very quickly and cheaply. At the moment, if you want to change programs in the Microbee, you must either wait agonising minutes for an 8K program to load from cassette, or if you want it faster, a disk drive and associated software is needed (rather expensive for most of us). The ETI-673 MultiPROM board described in the November 1982 issue is another approach but is limited to a number of programs and the program must be written for a certain area of memory.

The ROM Reader was designed to enable you to read a program previously written for tape storage and then transferred to EPROM. The project plugs into the 15-pin D-socket on the Microbee's rear apron and requires no external power. The program you wish to read into memory must have previously been put into a 2716, 2732 or a 2764 EPROM. If the ETI-668 Microbee EPROM blower is available, you can quite easily do this by reading the program from tape and copying to EPROM with a few small modifications to the code. This way, a library of EPROMs can be kept, similarly to your library of tapes.

A machine code support program is necessary to read the information into memory quickly. A USR (XXXX) call from BASIC is all that is necessary to read in and execute the program as the first seven locations of the EPROM contain the type and load address information.

PARTS LIST — ETI-678

- Resistors.....nil
- Capacitors.....nil
- Semiconductors
- IC1.....74LS257
- IC2.....4040B

Miscellaneous
 ETI-678 pc board; 28-pin ZIF socket or 28-pin low insertion pressure socket; DA15P right-angle pc mount 15-pin plug; tinned copper wire for links.

Price estimate: \$23-\$30

Details

The design is very simple, as you can see from the circuit diagram. However, I've pulled a few tricks. The Microbee's parallel I/O port has only eight signal lines. To read eight data lines from the EPROM, select each address location in turn and do whatever else is necessary, I have arranged the Microbee I/O lines to be a 4-in/4-out set, multiplexing the eight EPROM data lines onto the four Microbee input lines set up. Naturally, some 'driving' software is needed.

Driving software

The program which enables the EPROM to be read can be ORGED to reside in RAM and thus needs to be loaded from cassette occasionally or reside in the NETWORK EPROM socket.

The software initially sets up the PIO for 4-in and 4-out lines. It then resets the address generator, sets A12 low and selects the least significant nibble (half a byte, four bits). The first location in the EPROM describes the EPROM type: 4 for a 2732 (4K), 8 for a 2764 (8K). If the data is zero then a 2716 is assumed. A11 is connected to Vpp and this must be high to read a 2716, so the address generator is clocked 2048 times to set A11 high. If a 2 is the first data in the EPROM then the next step is carried out, else an error message is displayed.

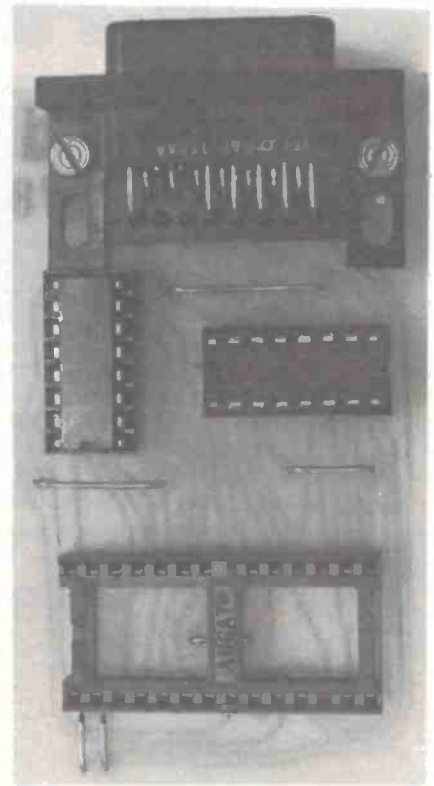

The 4040 is clocked to address the EPROM's next location, the data read by setting and resetting the MUX select line (pin 1) — this byte is the most significant byte of the address to where the program is to be loaded. The next location contains the least significant byte of the load address. The following two locations specify the number of bytes to be transferred and the next two contain the program start address. The actual program resides after the initial seven bytes.

Construction

Assembling the project is quite easy. First, pins 6, 7 and 9 of the DB15P need to be cut off and discarded so that the socket can be mounted to the pc board. The way tracks had to run on the board made this necessary. Carefully check the pc board to see that all holes are correctly drilled and that there are no breaks in the tracks or hairline

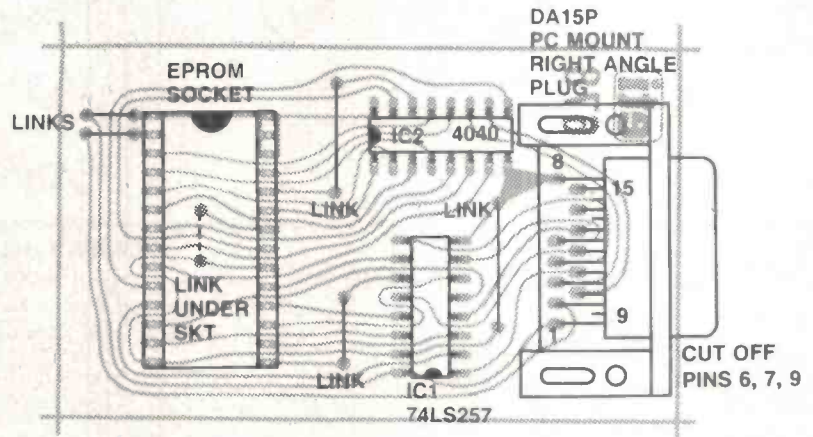

TO MICROBEE
PARALLEL PORT
DA-15 PLUG

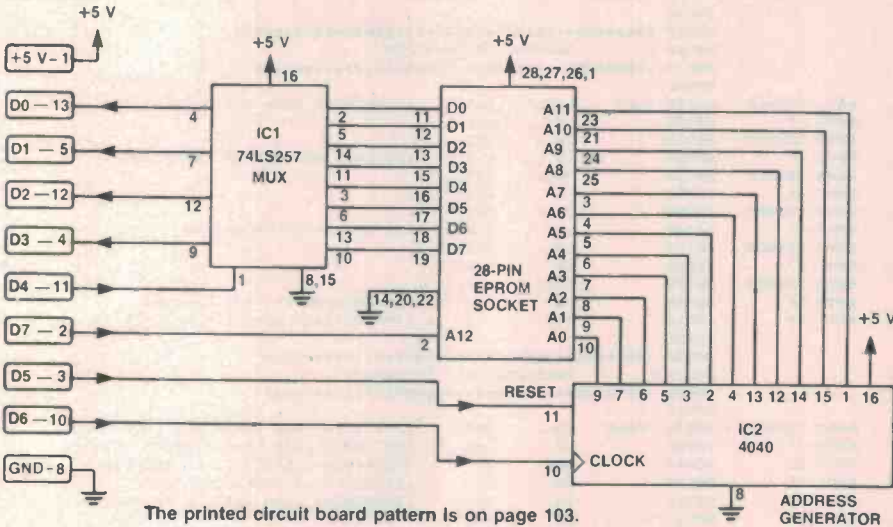

The printed circuit board pattern is on page 103.

HOW IT WORKS — ETI-678

To enable only eight I/O lines to read eight data lines from the EPROMs, resent the address generator, clock the address generator and select A12 on 2764's, the port I/O A lines are arranged to be four in and four out.

The eight data lines are multiplexed by IC1, a 74LS257, on the four input lines to the Microbee (D0-D3) and one output line (D4) is used to select the higher or lower nibble (4 bits) when reading.

Two output lines reset and clock the 12-bit ripple counter IC2, a 5050, used as an address generator. The last output is used to address A12 as the address generator only goes to A11.

The driver software which enables the data to be read into the Microbee is described in the software section. Power is derived from the Microbee, via pin 1 of the DB15 connector.

'bridges', particularly where tracks or pads are closely-spaced. See that you can screw the DB15 plug to the board without straining the pins. Don't mount it just yet, though.

The six links need to be inserted and soldered in place first. Don't forget the one beneath the EPROM socket. While two IC sockets were used on the prototype shown in the photograph, they aren't essential. If you're using them, put them on next, otherwise, mount the EPROM socket. You have three alternatives here: the expensive way, the less expensive way and the cheap way. The expensive way is to buy a 28-pin zero insertion force socket. It's elegant, handy to use and saves your valuable EPROMs from harm. But they cost \$15-\$20. The less expensive way is to use a low insertion force socket. They're easy to use, the EPROMs slip in and out comfortably, reducing the risk of damaged pins, and they cost under \$10. The cheap way is just to use an ordinary IC socket and take care. Use a good quality IC socket if you must go for the cheap option.

Fit the DB15 plug next, bolt it to the board before soldering the pins to avoid placing strain on the soldered joints.

Assemble the ICs to the board last of all, taking care with their orientation. The 4040 is a CMOS type, so only handle it by the ends of the package, using your thumb and forefinger, and avoid touching the pins. Better still, use a static-safe IC insertion tool. If you're soldering it in, solder pins 8 and 16 first — in that order. Use a soldering iron with a grounded tip.

0	2, 4 OR 8	2 FOR A 2716, 4 FOR A 2732, 8 FOR A 2764
1	A A	AABB = HEX LOAD ADDRESS
2	B B	
3	C C	
4	D D	CCDD = NO. OF BYTES IN PROGRAM
5	E E	EEFF = AUTO START ADDRESS
6	F F	= 8021 FOR RETURN TO BASIC
7	X X	
8	X X	
9	X X	PROGRAM CODE

Testing

Plug the unit into the Port A socket of the Microbee. Insert a pre-programmed EPROM. If the driver software resides in the NETWORK socket, a simple MEM

command from the BASIC command level will read in and execute the program, else aUSR (XXXX) to where you have assembled the program will be needed.

Swift and happy ROM reading to you!

ADDR	CODE	LINE	LABEL	MNEM	OPERAND
00100					*****
00110					EPROM READING PROG.
00120					BY P.J.LEONARDI
00130					*****
00140					
00150	BSEL	0010H		EQV	MUX SELECT BIT
00200	BRESET	0020H		EQV	4040 RESET BIT
00400	BCLOCK	0040H		EQV	4040 CLOCK BIT
00800	BAD12	0080H		EQV	ADD. A12 BIT
00190					
00200					*****
E000	ORG	0E000H			0E00 FOR NETWORK SPACE
00210					
00220					
00221					*****
00222					MAIN PROGRAMM STARTS HERE
00223					*****
00224					
E000	C303E0	00230	MEM	JP	START ITO PREVENT Option not fitted ERROR
E003	CD15E0	00240	START	CALL	INIT INITIALIZE PIO AND 4040
E006	CD25E0	00250		CALL	TYPE DETERMINE EPROM TYPE
E009	CD3CE0	00260		CALL	INFO GET DESTINATION,LENGTH,START ADDR.
E00C	D5	00270		PUSH	DE SAVE START ADDR. ON STACK
E00D	11F90F	00280		LD	DE,4096-7 FIRST 7 LOCATIONS DATA
E010	CD55E0	00290		CALL	TRANS TRANSFER CONTENTS TO MEMORY
E013	E1	00300		POP	HL GET START ADDR. FROM STACK
E014	E9	00310		JP	(HL) JUMP TO START ADDR.
00320					
00330					
00340					*****
00350					INITIALIZE
00360					*****
00370					
E015	3EFF	00380	INIT	LD	A,0FFH
E017	D301	00390		OUT	(1),A ISELECT PIO MODE 3
E019	3E0F	00400		LD	A,0FH
E01B	D301	00410		OUT	(1),A ISELECT MS NIBBLE AS OUTPUT AND LS NIBBLE AS INPUT
00420					
E01D	3E20	00430		LD	A,BRESET
E01F	D300	00440		OUT	(0),A IRESET THE 4040 COUNTER
E021	AF	00450		XOR	A ICLEAR A
E022	D300	00460		OUT	(0),A ICLEAR THE RESET LINE
E024	C9	00470		RET	INITIALIZE COMPLETE
00480					
00490					*****
00500					EPROM TYPE DETERMINATION
00510					*****
00520					
E025	CD6BE0	00530	TYPE	CALL	GET1 IGET DATA FROM EPROM (1 BYTE)
E028	FE00	00540		CP	0 IIS DATA=0
E02A	CC96E0	00550		CALL	Z,A2716 IYES, ASSUME A 2716 EPROM
E02D	FE02	00560		CP	02 IIS DATA=2
E02F	C8	00570		RET	Z IEPROM=2716 i.e. VALID
E030	FE04	00580		CP	04 IIS DATA=4
E032	C8	00590		RET	Z IEPROM=2732
E033	FE08	00600		CP	08 IIS DATA=8
E035	C8	00610		RET	Z IEPROM=2764
E036	2174B7	00620		LD	HL,0B774H IADDRESS OF "SYNTAX" MESS.
E039	CD56A2	00630		CALL	0A256H IPRINT ERROR MESSAGE AND GOTO BASIC

WAVETEK

NEW APPOINTMENT

Commencing on the 25th day of December, 1983, Scientific Devices Australia Pty. Ltd. was appointed as the new Australian representative for Wavetek Corporation U.S.A.

Wavetek made this appointment after many months of assessing and negotiation with both Scientific Devices and other leading instrumentation representatives. This now allows Scientific Devices to offer one of the largest and most comprehensive electronics instrumentation product lines in Australia.

Wavetek, with the addition of two new divisions to their structure, namely Nicolet Scientific Corporation and Pacific Measurements, are one of the largest instrumentation suppliers in the U.S.A.

Their products include F.F.T. analyzers, synthesizers, programmable filters, R.F. signal generators, R.F. components, communication service monitors, radio and C.A.T.V. test equipment, R.F. sweep generators, microwave generators, instrumentation controllers, pulse/function generators, arbitrary programmable generators, instrument controllers, network analyzers and power meters.

From the 25th December, 1983, Scientific Devices offers marketing and support for Wavetek products with full service facilities.

Please contact Scientific Devices Australia Pty. Ltd. for further information on this appointment at any one of the offices in Melbourne, Sydney or Adelaide.



**Scientific Devices
Australia Pty. Ltd.**

2 Jacks Road, South Oakleigh 3167. Phone: 579 3622
31 Halsey Road, Elizabeth East, S.A. 5112
Phone: 255 6575
35-37 Hume St., Crow's Nest, N.S.W. 2065
Phone: 43 5015



**ELECTRONICS TECHNICIAN, GRADE III
SYDNEY OPERA HOUSE**
Position No. S 425

SALARY:

\$19,904 range \$20,310 per annum.

QUALIFICATIONS:

Essential: Thorough knowledge and extensive experience of analogue and digital systems. TV Operator's Certificate, Electronics & Communications Certificate or equivalent. Ability to construct electronic projects, good colour vision.

Desirable: Experience with TV/audio systems and knowledge of microprocessor applications.

DUTIES:

Maintain and construct video, audio and microprocessor equipment.

CONDITIONS:

40 hours per week, non-continuous shift work for which appropriate penalties will be paid. Four weeks annual leave, Superannuation benefits (subject to certain conditions).

INQUIRIES:

(02) 2-0588 extension 271 (Mr G. Wilson).

Application forms may be obtained by phoning the Employment Officer, Sydney Opera House on (02) 20-588 and are to be returned to this office by 6th April, 1984.

microbee ROM reader

```

ADDR  CODE  LINE  LABEL  MNEM  OPERAND
00640
00650 | *****
00660 | PROGRAM INFORMATION
00670 | *****
00680
E03C CD6BE0 00690 INFO CALL GET1 |GET EPROM DATA AND CLOCK 4040
E03F 47 00700 LD H,A
E040 CD6BE0 00710 CALL GET1
E043 6F 00720 LD L,A |HL=LOAD ADDRESS OF PROGRAMME
E044 CD6BE0 00730 CALL GET1
E047 47 00740 LD B,A
E048 CD6BE0 00750 CALL GET1
E04B 4F 00760 LD C,A |BC=LENGTH OF PROGRAMME
E04C CD6BE0 00770 CALL GET1
E04F 57 00780 LD D,A
E050 CD6BE0 00790 CALL GET1
E053 5F 00800 LD E,A |DE=PROGRAMME START ADDRESS
E054 C9 00810 RET |INFORMATION COMPLETE
00820
00830 | *****
00840 | TRANSFER DATA TO MEMORY
00850 | *****
00860
E055 CD6BE0 00870 TRANS CALL GET1 |GET DATA FROM EPROM AND CLOCK 4040
E058 77 00880 LD (HL),A |PUT DATA INTO LOAD ADDRESS POINTER
E059 0B 00890 DEC BC |DECREMENT LENGTH TO GO COUNTER
E05A 18 00900 DEC DE |DECREMENT A12 OFF COUNTER
E05B 23 00910 INC HL |INCREMENT LOAD ADDRESS POINTER
E05C 7A 00920 LD A,D
E05D 83 00930 OR E |IS DE=0000
E05E 2005 00940 JR Z,MA12 |YES SET A12 HIGH
E060 78 00950 CONT LD A,B
E061 B1 00960 OR C |IS BC=0000 IE PROGRAMM TRX COMPLETE
E062 20F1 00970 JR NZ,TRANS |NO SO DO IT AGAIN SAM
E064 C9 00980 RET |PROGRAMME TRANSFER COMPLETE
E065 3E00 00990 MA12 LD A,BAD12 |A12 BIT
E067 D300 01000 OUT (0),A |SET A12 HIGH ON EPROM
E069 10F5 01010 JR CONT |CONTINUE WITH TRANSFER
01020
01030
01040 | *****
01050 | GET 1 BYTE OF DATA FROM EPROM
01060 | AND CLOCK THE ADDRESS GENERATOR
01070 | *****
01080
E06B C5 01090 GET1 PUSH BC |SAVE BC ON STACK
E06C DB00 01100 IN A,(0) |LOOK FOR A12 STATUS
E06E E600 01110 AND BAD12 |RETAIN A12,LOSE MUX SELECT AND CLOC
K
E070 D300 01120 OUT (0),A |SELECT LS NIBBLE
E072 DB00 01130 IN A,(0) |READ IT
E074 E60F 01140 AND 0FH |MASK OUTPUTS
E076 47 01150 LD B,A |SAVE IN BREG
E077 DB00 01160 IN A,(0) |RETAIN A12
E079 F610 01170 OR BSEL |SET SELECT HIGH
E07B D300 01180 OUT (0),A |SELECT MS NIBBLE
E07D DB00 01190 IN A,(0) |READ IT
E07F CB27 01200 SLA A
E081 CB27 01210 SLA A
E083 CB27 01220 SLA A
E085 CB27 01230 SLA A |PUT MS NIBBLE IN MS NIBBLE OF A
E087 00 01240 ADD A,B |ADD MS NIBBLE TO LS NIBBLE
E088 47 01250 LD B,A |SAVE DATA IN BREG
E089 DB00 01260 IN A,(0) |RETAIN A12
E08B F640 01270 OR BCLOCK |SET CLOCK BIT HIGH
E08D D300 01280 OUT (0),A |CLOCK THE ADDRESS GENERATOR
E08F E600 01290 AND BAD12 |REATIN A12,CLEAR OTHER OUTPUTS
E091 D300 01300 OUT (0),A |RESET CLOCK BIT
E093 78 01310 LD A,B |A REG = DATA NEEDED
E094 C1 01320 POP BC |GET BC REG BACK
E095 C9 01330 RET |DATA IN A REG AND 4040 CLOCKED
01340
01350
01360 | *****
01370 | 2716 EPROM SPECIAL TREATMENT
01380 | *****
01390
E096 01FF07 01400 A2716 LD BC,07FFH |2047 CYCLES
E099 CD6BE0 01410 A21 CALL GET1 |CLOCK 4040
E09C 0B 01420 DEC BC |DECREMENT COUNTER
E09D 78 01430 LD A,B
E09E B1 01440 OR C |IS BC=0?
E09F 20F0 01450 JR NZ,A21 |NO DO IT AGAIN
E0A1 CD6BE0 01455 CALL GET1
E0A4 C9 01460 RET |A11 OF 4040 IS NOW HIGH
|TO ENABLE EPROM COMPATIBILI
TY
|A11 ON 2716=VPP AND MUST
|BE HIGH TO READ IT
01480
01490
01500
01510
01520 END
0000
0000 Total errors
A21 E099 CONT E060 MA12 E065 A2716 E096
GET1 E06B TRANS E055 INFO E03C TYPE E025
INIT E015 START E003 MEM E000 BAD12 0000
BCLOCK 0040 BRESET 0020 BSEL 0010

```

NEW MYTEK PROGRAMS FOR THE MICROBEE

GRAPHICS TUTORIAL

YES! We're giving away secrets!
 A series of interactive tutorials which explore the Microbee and its graphics capabilities. Commencing with the design of graphic characters, and character by character animation. You are shown every conceivable technique including Pixel by Pixel animation as used in many of our programs in 280 assembly language and run programs in the top half of the screen while Tutorial Text is displayed in the lower half. Contains documented source codes for your own use and modification. NOTE: Requires MYDAS.

YOU WILL LEARN ENOUGH TO START YOUR FIRST GAMES PROGRAM.

Cassette ... **\$2500**

MYDAS

LD (MICROBEE), MYDAS OUT A. (PROGRAM)
 EPROM based, works with either 16K or 32K Microbees. This full featured assembler enables the compilation of 280 machine code programs. Fast execution and extremely user friendly.
 Write arcade quality games, with superfast high resolution graphics, gain direct access to every hardware aspect of the Microbee.

- Full screen editing — use as a mini wordprocessor.
- Supports the International standard RADIX 40 convention.
- Built in Monitor — may be used from within the assembler.
- Supports all 280 mnemonics, plus pseudo's.
- Save source at 1200 baud and 300 baud.
- Incredibly fast assembly.
- Many printing options.

The Editor/Assembler with Golden Features.
MYDAS \$4250 ON EPROM.
 Recommended for use with our Machine Code and Graphics Tutorials.

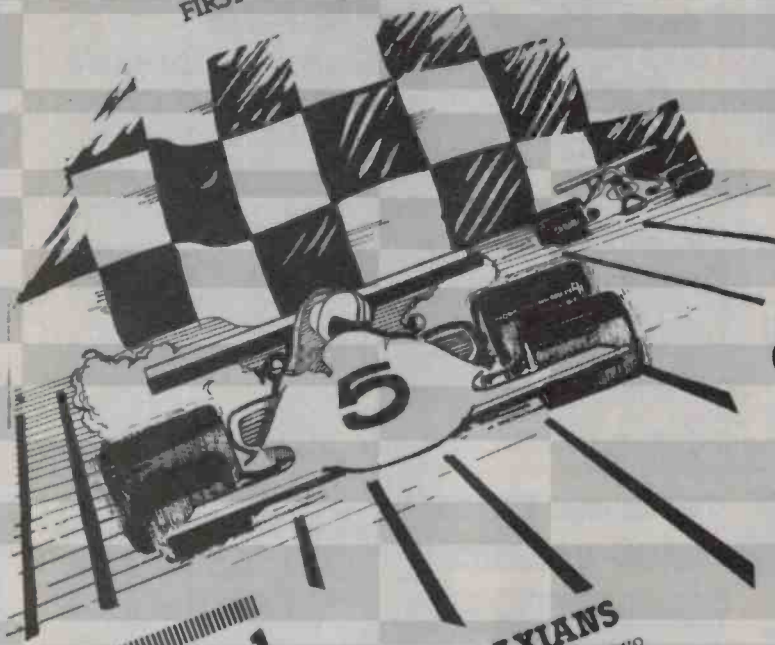

GRAND PRIX

A Game of Reflexes, Fast and Furious.
 Your engine screams, pushing your car and yourself to the limit. Victory is in sight if you can avoid the slower less experienced drivers. Watch the tachometer carefully, hit the brakes for fear of a blown engine and instant death.
High Speed Graphics — Real Time Sound — Joystick Compatible.

Cassette ... **\$1995**
 Disk **\$2500**

2 FOR 1 SPACE INVADERS & GALAXIANS

Based upon the original arcade games of the same names, two all time favourites presented in the one package.
OUTSTANDING VALUE.

Cassette ... **\$1995**
 Disk **\$2500**



FOR THE SERIOUS GAME PLAYER
JOYSTICKS WITH "REAL FEEL"
CAPTAIN GRANT \$2999



MYTEK COMPUTING
 Suite 7, 42 Ardross St., Ardross,
 WA. 6153. Tel. 364 8177

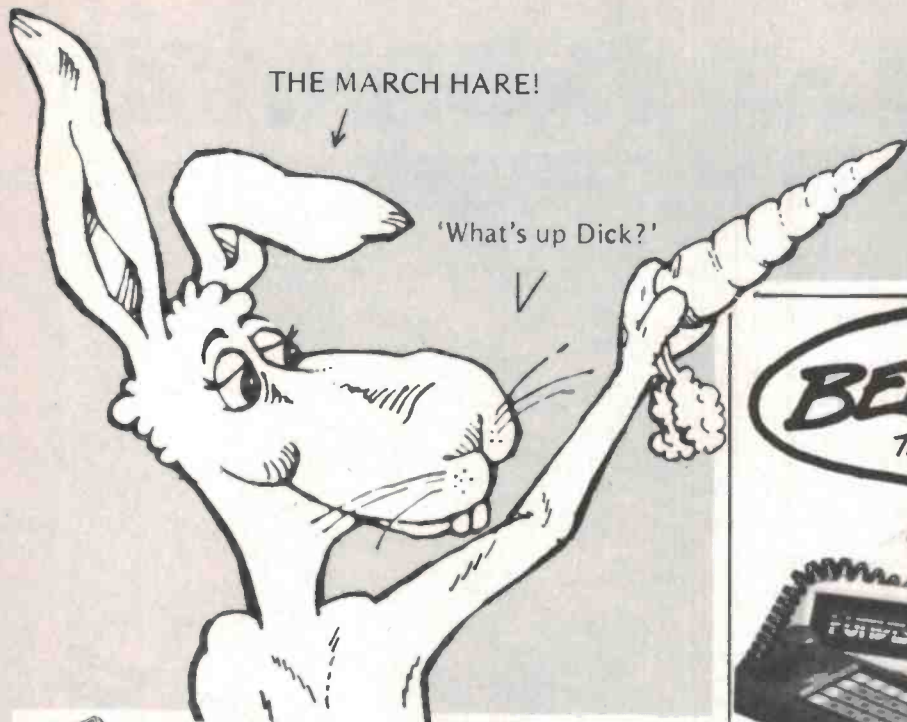

It's the and Dick's



ONLY \$135 WHILE STOCKS LAST! **FUNVISION Video Games Console**

Our loss... your gain! We bought a huge shipment of these fantastic Funvision games consoles but now have to clear our warehouse (there's nowhere left to store the carrots for winter). Electrically identical to the famous Dick Smith Wizzard, same great range of cartridges available. But look at the difference in price. Hurry in and save over \$160.00!!! Cat. Y-2600

Save on tune ups!
Engine Analyser
If your widdle wed waggon wuns woughly, it could need a tune-up. Do it yourself with this deluxe engine analyser and Save! Cat. A-8514
SAVE \$5
WAS \$29.95 **\$24.98**

Radar Detector

Find out if they're shooting microwaves at your car before they start taking your carrots. Suits both X & K band, latest superheterodyne circuitry for fantastic sensitivity. Cat. A-8502
GREAT VALUE! \$225

Remote Communications Speaker \$11.98
Even with rabbit's ears, it's hard to hear the tiny speakers used in most radios. This quality 10cm speaker will normally give much clearer sound (particularly in mobile use!); comes with cable & 3.5mm plug. Cat. A-2451

30W Mini Brutes
You'll be amazed at the quality sound from such tiny speakers; and they handle a huge 30W each! Absolutely superb in 4wd's, vans, cars, etc. And bunny burrows. Cat. A-2380
only \$44.95

Xenon Timing Light
Much more light than a neon type - almost enough to light a whole burrow. Set engine timing easily, save fuel and money. Cat. A-8508
SAVE \$5
\$24.98
WAS \$29.95

Two in one! FM/AM RADIO CASSETTE
Not much room in the old jalopy, eh? But you want great sound? Get it from the superb AM/FM stereo cassette. Not one of the cheapies you find anywhere: this one is real quality with auto reverse, huge 8W max/ch power output and locking fwd/rew. Cat. A-6482
\$125

Super Thin Door Mount Speakers
Some cars are so crowded the only room left for speakers is in the doors. No worries: these ones fit in the doors! Super thin; but don't sacrifice anything in sound quality. Handle 15W, 100mm size. Cat. A-7050
\$19.95 pr.

Low Cost Ultralight Headphones
Very difficult to fit on a hare's ears - but they fit great on humans. And the sound is really great! Suits virtually all modern stereos, comes with 3.5/6.5mm adaptor plug. Cat. C-4106
\$8.98

2-tape Answering Machine
Never miss an important call again! Deluxe 2-tape answering machine is Telecom Permitted, easy to use - and includes remote beeper at no extra cost. Cat. F-6136
WAS \$329
\$299

27MHz Helical Whip Antenna
Be quick for this bargain! 27MHz helical whip complete with base & coax for \$55 off normal price! Ideal for all 27MHz CB's; takes full 40 channels. Cat. D-4078
\$29

Inductive pick-up
Suction cap sticks to intercom so no electrical connection needed. Ideal for amplifiers, tapes, etc (recording of phone conversations may not be permissible).
Cat. C-7300
only \$1.80

2 Station Intercom
Yelling through the burrow isn't easy - so use a two station intercom. Battery operated, cable included. Also use as a baby-sitter for the little bunnies. Cat. F-1020
\$16.80 pr

The one and only GENUINE Dick Smith Catalogue... FREE in the April issue of Electronics Aust. & E.T.I. BEWARE OF IMITATIONS!

mad month of March! prices are crazier than ever!

Famous Ampex Cassettes
Hurry! Only two types left.

C90	\$2.24
LN Cat. C-3082	
10 up	\$2.00
C90	\$2.69
EDR Cat. C-3088	
10 up	\$2.30



PARKING IS EASY
Ultrasonic Back-up Sensor

Don't be a bunny! Park safely and easily with the back-up sensor. As you reverse it squeaks to you letting you know how close you're getting. No more crunches, no more bills. And no more grey hairs. Cat. A-8520

ONLY \$59.00



Don't take chances with Modems..

Why build a Modem which may be impossible to have Telecom permitted (and if it could would cost you a fortune!!) The Dick Smith Dataphone II is already Telecom permitted - so you can legally plug it in to any telephone socket. And even more: latest improved model has a push-button phone...at no extra cost!

\$199.00



IMPROVE RECEPTION!

Metropolitan UHF/VHF Antenna

What's better than rabbit ears? Nothing if you're a rabbit. But for good VHF/UHF TV you need a good antenna. This one has both in one - no need for separate antenna or feed ins. Suits 300 ohm ribbon.

\$59.95

Cat. L-4020



TV & FM Cable

New video for Christmas? But the pic's too crook? You could need new cable!

300 Ohm Flat Ribbon	
Cat. W-2070	20¢ per m.
100m	17¢
78 Ohm Coax	
Cat. W-2080	45¢ per m.
100m	32¢

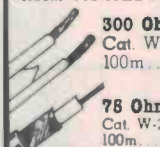

16 Drawer Parts Cabinet

Store away all your goodies in this deluxe parts cabinet. Individual drawers so you can keep the celery & carrots separated. Measures 300 x 180 x 140. Cat. H-2588

\$19.95



NEW KIT

Ignition Killer

Watch your tails! No worries - this one's a new kit to protect your car. It disables it so the crook thinks something's wrong and pinches someone else's! Easy to build, easy to fit. Cat. K-3255

ONLY \$12.95

STALLS CAR THIEVES!



Economy Indoor Antenna

And even this is better than rabbit's ears! Spiral indoor TV antenna is great in primary signal areas. And it doesn't take up much room in the burrow. Cat. L-4010

\$5.00

IT'S A BARGAIN!



Printed Stripboard

Fantastic for stocking up circuits or building the real thing. No more birds nests - or even rabbit warrens.

2.5mm spacing	75mm x 153mm	\$3.15
Cat. H-5612		
2.54mm spacing	76mm x 76mm	\$1.65
Cat. H-5614		

Versa Stripboard

2.54mm spacing	76mm x 153mm	\$3.55
Cat. H-5616		

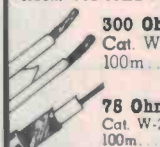

Etching Kit

Make your own PCB's at home or in the lab. No need to send them out (costs a fortune) Mock them up yourself. Kit has ferric chloride, resin, Dalo PC pen and a sample piece of PC board - plus instructions. Cat. H-5650

\$6.99



Power Heatsink

Massive boo-boo! We had hundreds of heatsinks drilled at great cost for our kits and found the holes too close! You reap the benefit - Drilled heatsinks only 20¢ dearer than undrilled!!!

Undrilled H-3460	\$5.75
10 up	\$5.45
Drilled H-3461	\$5.95
10 up	\$5.50



SCOOP PURCHASE!

Mini hi-torque carbon brush motor

Wow! Huge scoop purchase - ideal for modellers, etc. You'll be amazed at the torque from such a tiny motor. And it operates from 6-15V DC. And our low low price? Cat. M-9950

24 CARROT BARGAIN! 95¢



IT'S HARE! THE INCREDIBLE BICYCLE COMPUTER



Ferric Chloride

Super strength ferric for fast PCB etching. 600 ml bottle. Cat. H-5652

\$3.99



AMAZING!

The new Dick Smith

Multimeter with Logic Probe

This is the very first analog multimeter ever with its own built-in Logic Tester! Built-in LED's give instant recognition of 'HIGH', 'LOW' and 'PULSE' states of logic circuits. 18 voltage, current and resistance ranges, with 20K ohm/V sensitivity DC and 8K ohm/V AC. Complete with instructions, batteries and probes. Cat. Q-1025

GREAT VALUE! \$32.50



Multi-tap TRANSFORMERS

DSE 2155 Our most popular tranny - with 6 taps between 6.3 & 15V @ 1A, giving up to 21 voltage combinations! Cat. M-2155

\$5.90

10 up... \$5.10

DSE 6672

Our second most popular - taps between 15 and 30V @ 1A, giving you every voltage you could ever want (except a few million). Cat. M-6672

MULTIPLY YOUR SAVINGS! \$6.75

10 up... \$6.10



Now you can find out exactly how well you're doing on your bike. Just like the latest cars with their car computers, you can tell how fast you're going, time, distance, etc etc. Real easy to fit, complete with sensor ring for wheel and removable computer head so some other wascally little gwey wabbit won't pinch it! Cat. X-3010

\$49.50



NiCad AA Batteries

Re-charge hundreds of times... save money! 10 up... \$2.47

Cat. S-3300

GE NiCad \$2.95

Charger

Plug-pack charger with snazzy snap-on adaptor set to suit most nicads. Cat. M-9520

\$10.95



NEW! 12V 2.6Ah Gel Battery

Ideal for burglar alarms (see our new Security Centre elsewhere!) but also ideal for other high current 12V applications. Leak-proof Gel type, huge 2.6Ah capacity. Cat. S-3320

ONLY \$24.80



DICK SMITH Electronics
See Page 93 for full address details



Mail Order... Promark Distributors... Mail Order

Your First Choice for High Technology Electronic Components
(Founded 1976)

★★ SPECIAL OFFER ★★

These 3½ digit voltmeter kits from TELEDYNE include all the components necessary to build a high accuracy meter with 1,000 megohm input resistance. TK-1 is an LCD unit with ½" readout and runs from a single 9 Volt battery for about 200 hours continuous use. TK-2 is a high brightness LED readout with ½" red displays and uses a single 5 Volt supply at about 150mA. Both kits include Fibreglass PCB, IC sockets and all components. Both are 200mV full scale sensitivity.

Application notes are included for voltage, current and resistance meters, also temperature, RMS AC, ratios and many more. Packing and Freight \$3.50 per order. Prices included Sales Tax.

TK-1 LDC\$28.50 TK-2 LED\$33.50

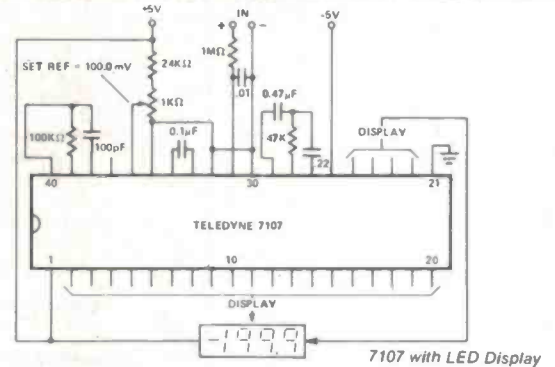
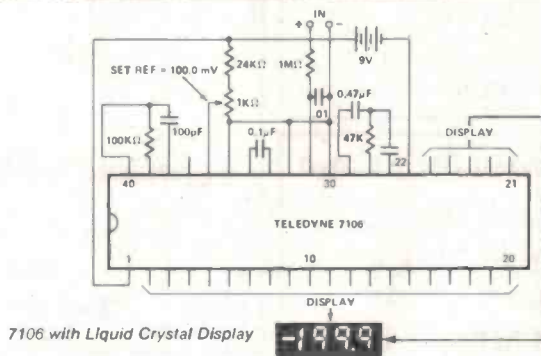

TELEDYNE SEMICONDUCTOR 7106 LCD DIGITAL PANEL METER

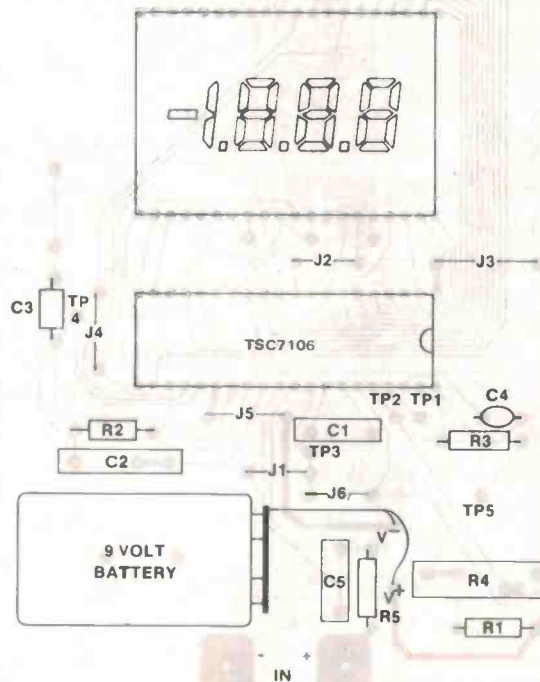

TELEDYNE SEMICONDUCTOR 7107 LED DIGITAL PANEL METER

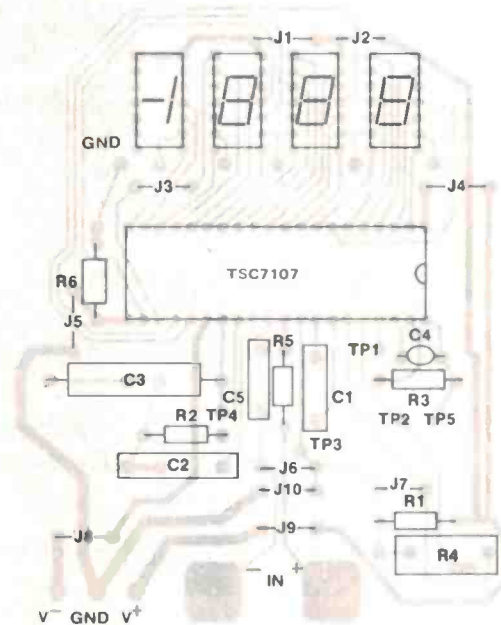

P.O. BOX 381 CROWS NEST N.S.W. 2065. PHONE (02) 439 6571

More functions for the VZ200

HERE is a simple way to add *automatic line numbering* and *trace* functions to VZ200 BASIC. Automatic line numbering should be self-explanatory. However, the trace function may need some explanation. When attempting to debug a BASIC program, it is sometimes useful to see exactly what sequence of instructions the computer is interpreting. This is the function of the trace command. It prints out on the video the sequence of line numbers the computer (the interpreter) is stepping through when executing a program. This allows you to make sure the program is doing what you intended it to do. (Especially useful in the case of conditional GOTO's or GOSUB's).

As adding the trace functions (TRON and TROFF) is the simplest task, I will deal with that first.

Before running your program, type in POKE 31003,175 from the immediate mode (no line numbers *That's it!* This is equivalent to typing in 'TRON'. Now when you run your program, each time a new line is selected to be interpreted (or the same line number repeated) it will be printed on the video. To disable this function just type POKE 31003,0 from the command level. This simulates using the 'TROFF' command.

A drawback with this method is that you might only want to debug a small section of the program and so have to contend with sorting out that small section from the rest of the displayed line numbers. This can be simply overcome by adding POKE 31003,175 into your program with a line number which places it in the program just before where you want to start the trace. Then add POKE 31003,0 with a line number which places it where you want the trace to stop.

Auto

Now to deal with the slightly more complex 'AUTO' function. This function, when enabled, saves you the trouble of typing sequential line numbers when entering a program. This very useful function will automatically display the next line number when you hit 'RETURN' at the end of a line of program.

To do this you need to supply the starting line number and the increment between lines. Next you need to set a flag which tells the BASIC that the 'AUTO' function is enabled. (This must be done last or you will go into the 'AUTO' mode before you have supplied the starting line and increment.)

The starting line number must be POKED into locations 30946 and 30947, and the line increment POKED into locations 30948 and 30949. These have to be in two-byte form with the least significant bit (LSB) going

This article details how you can simply add automatic line numbering and TRON and TROFF trace functions to the Dick Smith VZ200 colour computer.

Steve Olney

into the first location of each pair, and the most significant bit (MSB) going into the second.

For the line increment this is no problem as long as you keep the increment below 255. (Most increments would normally be less than 100). Just POKE 30948, 'increment' and then POKE 30949,0 where 'increment' is less than, or equal to 255. (I usually use 10 or 20 as the increment.)

Of course, the line number would most likely be above 255, so you must convert your starting line number into two bytes where:

$$\text{LINE NO.} = (\text{MSB} * 256) + \text{LSB}$$

and where we:

POKE 30946, LSB and POKE 30947, MSB

Example: For a starting line number of 2000

$$\text{MSB} = \text{INT}(2000/256) = 7$$

$$\text{LSB} = \text{LINE NO.} - (\text{MSB} * 256) = 208$$

So we must:

POKE 30946, 208

POKE 30947, 7

For those not content with trouble of calculating this every time the 'AUTO' mode is entered, I have written a short program to do this as well as to enable the 'AUTO' function itself. (Can be done directly by POKE 30934,175.) Use line numbers which will put it well out of the way of any main program you are entering.

```
0 CLS
10 INPUT"STARTING LINE NO. ";S
20 INPUT"INCREMENT ";I
30 MS=INT(S/256): LS=S-MS*256
40 POKE 30946,LS: POKE 30947,MS
50 MI=INT(I/256): LI=I-MI*256
60 POKE 30948,LI: POKE 30949,MI
70 POKE 30945,175
80 END
```

For convenience, type this small program in starting from line number 0. This will enable quick access by just typing 'RUN' and then 'RETURN'. However to run your program, you will now need to type, 'RUN xxxx', where 'xxxx' is the first line number of your program.

To exit from the 'AUTO' mode, type 'CTRL' and 'BREAK' simultaneously exactly the same way you exit or interrupt a BASIC program. Incidentally, BASIC will automatically exit from the 'AUTO' mode when the new line number would have been greater than 65529. (The maximum line

number allowed in this BASIC.)

A useful feature of this 'AUTO' function is that, if you specify line numbers which include previously entered lines, then not only is the line number displayed but also the statements previously entered.

The cursor is conveniently positioned at the end of the line ready for any additions to that line. This can be used as a convenient editing feature. For example, let us suppose you have entered your program and now wish to go through and make corrections. Enter the first line number of the program to be corrected and the appropriate line increment for that program. You can now single step through your listing and make corrections as you wish! Unfortunately, there is no simple way of decrementing the line number. (other than manually POKING in location 30946).

Why So Simple?

How was I able to add these two functions so easily? Well, on close scrutiny of the VZ200 BASIC in ROM, I discovered that it was fundamentally similar to Level II TRS-80 BASIC. By finding the equivalent control areas in RAM for the VZ200 BASIC, and by experimentation, I was able to get the functions working.

Apparently, the machine code for the execution of the 'AUTO', 'TRON' and 'TROFF' functions is still present in the VZ200 BASIC ROM, but the interpreter has been altered so as not to recognise the commands as valid in an input text string.

Why the machine code would be present in the BASIC ROM but not enabled is a bit strange. Perhaps some functions were dropped in order to implement all functions provided on the multi-function keys.

A word of warning! Like all situations where you are patching software (especially when written by someone else), beware of yet-undiscovered gremlins. I take no responsibility for any havoc wreaked by same!

A more elegant and flexible approach would be to intercept the text interpreter and make it recognise the 'AUTO' and trace commands from the immediate command level, and perhaps add a line re-numbering command. But that's another story!

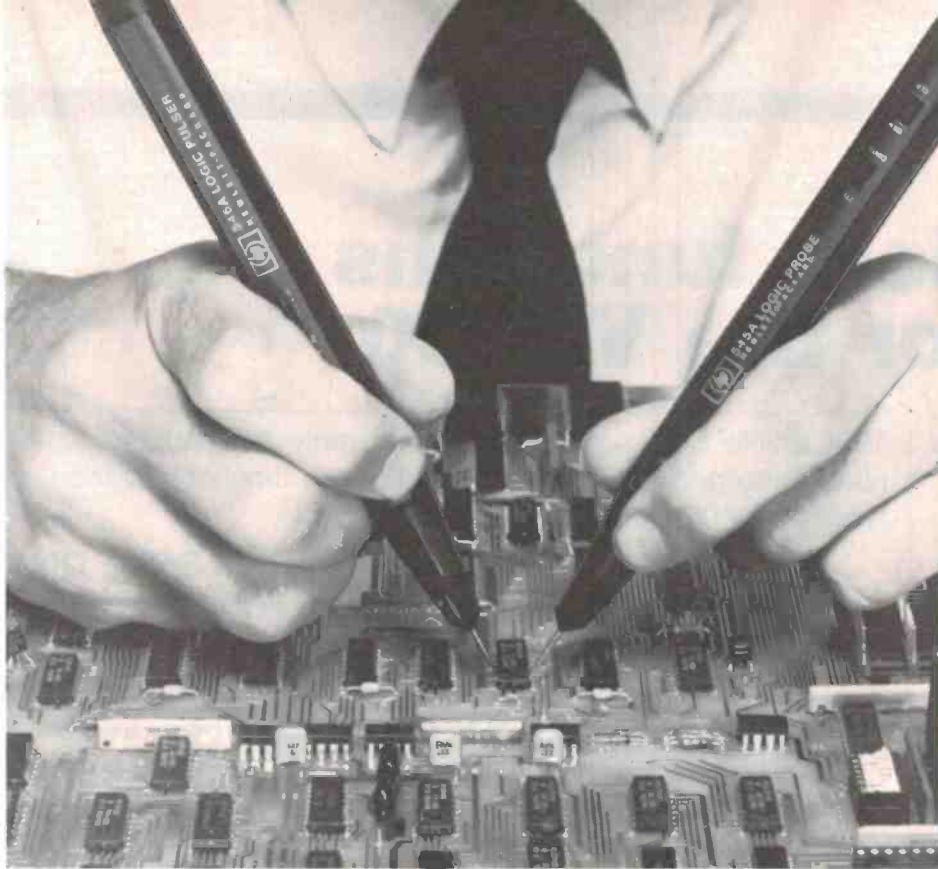

Hewlett-Packard IC Troubleshooters to show it like it is:



1

2

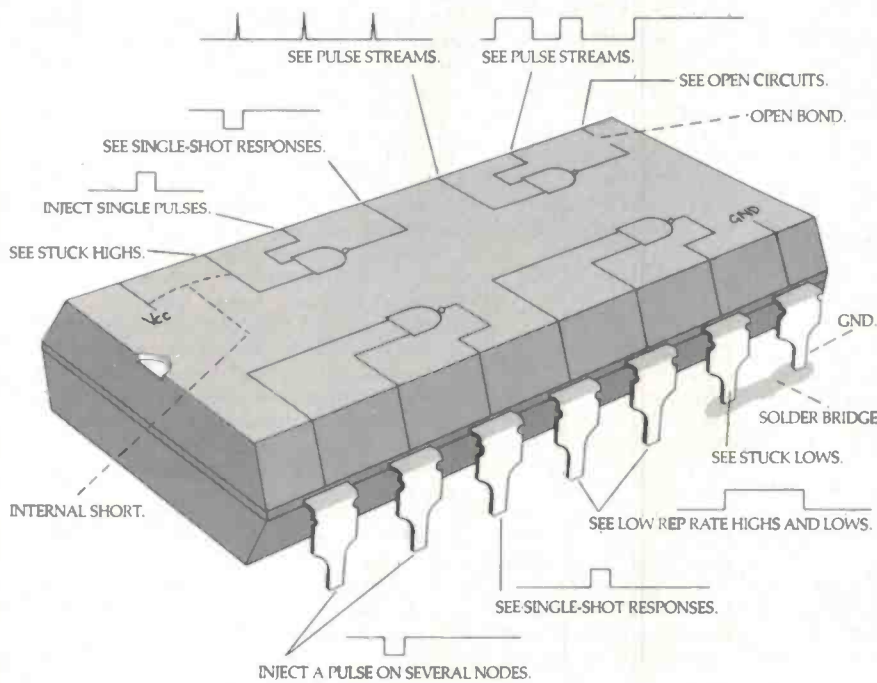

The Model 545A Multi-Family Probe. See logic high's, lows, bad levels and open circuits with logic probes. Capture one-shot pulses. See pulse streams.

The Model 546A Pulser. Inject a pulse or pulses into a circuit without trace cutting or unsoldering. Automatically drives low nodes high or high nodes low. The Model 546A Logic Pulser creates your programmed number of logic pulses and has multi-family capability.

ETI
READER OFFER
20% OFF! SAVE UP TO \$197

3

The kit puts it all together. The HP5024A Kit puts the logic tool kit all together in a convenient carrying case. In addition to the Multi-Family Probe and Pulser, the kit contains the model 547A Current Tracer. The 547A will trace current when you reach

a node where the logic probes cannot work because the node is stuck low and you don't know which bus component of many is faulty. No pc board trace cutting or good component removal is necessary.

INSPECTION.

You are welcome to inspect the Logic Troubleshooters during office hours at the following locations:

SYDNEY

ETI Offices,
 Federal Publishing Company,
 140 Joynton Avenue, Waterloo.
 OR
 Hewlett-Packard Australia Limited,
 17-23 Talevera Rd., North Ryde.

MELBOURNE

Federal Publishing Company,
 150 Lonsdale St., Melbourne.

BRISBANE

Hewlett-Packard Australia Limited,
 10-14 Payne Rd., The Gap.

ADELAIDE

Hewlett-Packard Australia Limited,
 153 Greenhill Rd., Parkside.

PERTH

Hewlett-Packard Australia Limited,
 261 Stirling Hway, Claremont.

HOW TO ORDER YOUR TROUBLESHOOTER.

Fill out the coupon here and enclose a cheque, bank cheque or money order for the amount required made out to HEWLETT-PACKARD AUSTRALIA LIMITED. If you are not paying sales tax, please quote your sales tax number on the coupon or use an official order. Schools, colleges, etc. should enclose a tax declaration on official letterhead. The completed coupon, together with your payment should be sent to:

Hewlett-Packard Troubleshooters Offer
 C/- ETI,
 140 Joynton Avenue, Waterloo, N.S.W. 2017

Delivery. Hewlett-Packard will endeavour to deliver your Troubleshooters in less than four (4) weeks from receipt of payment.

Nothing else quite measures up.



**HEWLETT
 PACKARD**

ORDER NOW! OFFER CLOSES MARCH 31, 1984. LAST CHANCE!

Please supply, on the terms outlined in this offer and the Terms and Conditions of Sale of Hewlett-Packard Australia Limited.

Qty. _____ HP545A Logic Probe @\$139 (normally \$176) each.
 Qty. _____ HP546A Logic Pulser @\$215 (normally \$275) each.
 Qty. _____ HP5024A Logic Kit @\$790 (normally \$987) each.

Sales Tax No. _____
 (if applicable)

All prices excluding tax. Add 16% if applicable

Name _____ Position _____

I enclose \$ _____ total

Address _____

Postcode _____

Cheque or Money Order No. _____ Signature _____

Send completed coupon with payment to: Hewlett-Packard Troubleshooters Offer.

C/- ETI,
 140 Joynton Avenue, Waterloo, N.S.W. 2017

ATOM

Miroslav Kosteckı, Elizabeth Park SA.

Atom is a HI RES moving model of electrons orbiting an atom. The model is not meant to be accurate but shows a way of moving objects quickly along complex paths.

A path is first calculated and stored in an array. Then a loop is used to move along the stored points, thus the path is only calculated once before the movement. This greatly speeds the movement since calculation time is removed.

This method can be used where calculation time slows moving objects on a predictable path. Spinning shapes, bouncing balls and many physical simulations can easily use this method to speed up the graphics. The 'Atom' program may be changed to a model of the solar system.

ATOM

```

00120 SD4: DIM C(72),D(72),I(80),J(80): HIRES
00130 E=256: F=128: A1=0: A2=0
00140 PLOT E+1,F+1 TO E-1,F+1 TO E-1,F TO E+1,F
00150 FOR A=1 TO 64: REM # Calculate & store paths #
00160 A1=A1+.1964: E1=COS(A1): F1=SIN(A1)
00170 X=INT(27*(E1+F1/2))+E: Y=INT(20*(E1/2+F1))+F
00180 C(A)=X: D(A)=Y: SET X,Y: SETH X,Y
00190 A2=A2-.09818: E1=COS(A2): F1=SIN(A2)
00200 X=INT(58*(E1+F1/3))+E: Y=INT(50*(E1/3+F1))+F
00210 I(A)=X: J(A)=Y: SET X,Y: SETH X,Y
00220 NEXT A
00230 FOR A=1 TO 8: C(A+64)=C(A):D(A+64)=D(A):NEXT A
00240 FOR A=1 TO 16: I(A+64)=I(A):J(A+64)=J(A):NEXT A
00250 FOR A=1 TO 64: REM # Main loop for moving #
00260 RESET R+1,S: RESET R,S
00270 R=C(A): S=D(A): SET R,S: SET R+1,S
00280 RESETH G+1,H: RESETH G,H
00290 G=C(A+8): H=D(A+8): SETH G,H: SETH G+1,H
00300 RESET L+1,M: RESET L,M
00310 L=I(A): M=J(A): SET L,M: SET L+1,M
00320 RESETH P+1,Q: RESETH P,Q
00330 P=I(A+16): Q=J(A+16): SETH P,Q: SETH P+1,Q
00340 NEXT A: GOTO 250
    
```

VOLUME CONTROL

Graham Taylor, Fitzroy Victoria.

When playing with the sound possibilities of the Microbee late at night I received a certain amount of abuse. I thought that a volume control would be useful and, after studying the circuit diagram, I came up with this idea.

A cermet trimpot can be mounted just below and to the right of the 'RESET' key where there is a convenient hole in the keyboard's baseplate. Mount the trimpot on a small piece of veroboard and glue it over the hole, then drill a hole of appropriate diameter in the case to allow access.

A cermet trimpot is recommended as it is the ideal height and of sufficient ruggedness to work well. I just happened to have a 2k version but I imagine that any value between 1k and 20k will work.

The circuit diagram for my Microbee, which is now more than one year old, shows a capacitor (10 µF) in

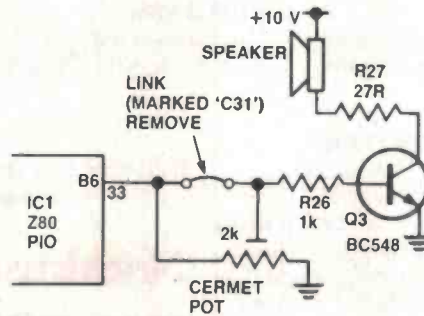

series with the speaker drive transistor's base resistor. However, there is a link in the corresponding place on the pc board so a track may have to be cut on later models.

Remove this link (see diagram) and attach wires from the trimpot to the appropriate places on the pc board. Now I can play 'Asteroids' and other noisy games without incurring the wrath of half the neighbourhood.

A toothpaste tube cap can be used as a knob, however, an appropriately sized screwdriver works better as the trimpot is flush with the top of the case and so it out of the way of the keys.

Another useful idea, when writing machine code sound routines, is to output 042H to port 2 as this will send the noise to the cassette port as well.

AUTOMATIC CASSETTE CONTROL

Tony Clay, Logon Qld

This modification uses only one IC and relay and allows automatic control of the cassette player during SAVES and LOADS.

To save, type OUT 10,0:SAVE "TEST". The cassette turns on, the program is saved and the beep from the speaker (which occurs after both SAVE and LOAD) turns the motor off.

The relay resistance should be greater than 100 ohms.

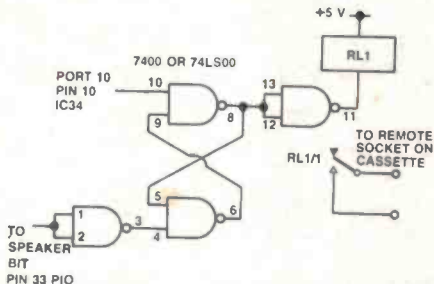

A CAPITAL IDEA

Lindsay Ford, Dreamcards Victoria

As a software publishing firm, we get heaps of good software sent to us for evaluation. But one failing that occurs in about 50% of submitted programs is that programmers persist in using "POKE 257,1" to force the Microbee into only allowing input in upper case (i.e. in CAPITALS).

This is bad technique as it does not eliminate lower case, but simply reverses the operation of the shift key, causing all sorts of errors and crashes.

If you're writing software to a commercial (i.e. inflexible) standard, then the *only* acceptable way to input a string (say A0\$) in upper case exclusively is with this subroutine.

```

00100 REM Subroutine to INPUT string A0$ in mixed cases, then
00110 REM convert it to entirely upper case. Uses variables
00120 REM A0$, X and Y - by Dreamcards 1983 (Not copyright)
00130 INPUT A0$: IF A0$="" THEN 130
00140 FOR X=1 TO LEN(A0$): Y=ASC(A0$(X)): IF Y>96 THEN LET
    A0$ = A0$(X) + CHR(Y-32) + A0$(X+1)
00150 NEXT X: RETURN
    
```

A PREDATOR/PREY SIMULATION

J. Murfet, Hadspen Tasmania

The original program 'Prey', a predator/prey simulation for the Apple II, was written by Phil Cohen and was published in ETI, September 1982.

The program has now been modified for the Microbee. One drawback is that when fed with erratic changes in variables, the 'Bee sometimes runs out of PCGs.

A PREDATOR/PREY SIMULATION

```

00130 CLS
00140 A1 = 500:C1 = 130: B1= 85: D1 = 15
00150 PLAY 16;16; 20; 23; 0;20;23,8
00160 F1 = 10: G1 = 20:H1 = 1
00170 PRINT " THIS IS A PROGRAM TO SIMULATE THE EFFECT
ON THE POPULATION"
00180 PRINT " OF TWO SPECIES BY ENVIRONMENTAL CHANGES
(CULLING BY HUMANS,"
00190 PRINT "FOOD LOSS BY DROUGHT, DISEASE, ETC)."
```

```

00200 CURS 15, 12: PRINT " PRESS RETURN TO BEGIN PROGRAM"
00210 A$ = KEY $: IF A$ = "" THEN 210
00220 CLS
00230 PRINT " 1 SIZE OF TERRITORY"; TAB (40); A1
00240 PRINT
00250 PRINT " 2 PREY POPULATION"; TAB (40); C1
00260 PRINT
00270 PRINT " 3 PREDATOR POPULATION"; TAB (40); B1
00280 PRINT
00290 PRINT " 4 FOOD YIELD PER UNIT AREA"; TAB (40); D1
00300 PRINT
00310 PRINT " 5 PREY NATURAL LIFE SPAN"; TAB (40); F1
00320 PRINT
00330 PRINT " 6 PREDATOR NATURAL LIFE SPAN"; TAB (40);G1
00340 PRINT
00350 PRINT " 7 PREY CULL LOSSES"; TAB (40); H1
00360 INPUT " WHICH WOULD YOU LIKE TO ALTER (9 = FINISHED);
?"; T1
00370 ON INT (T1) GOTO 390, 400, 410, 420, 430, 440, 450,
220, 460
00380 PRINT
00390 INPUT " TERRITORY SIZE?";A1: GOTO 220
00400 INPUT " PREY POPULATION? ";C1: GOTO 220
00410 INPUT "PREDATOR PULATION? ";B1: GOTO 220
00420 INPUT " FOOD YIELD PER UNIT AREA?";D1: GOTO 220
00430 INPUT " PREY NATURAL LIFE SPAN?"; F1: GOTO 220
00440 INPUT " PREDATOR NATURAL LIFE SPAN? "; G1: GOTO 220
00450 INPUT "PREY CULL LOSSES?";H1:GOTO 220
00460 INPUT " YEAR FOR CHANGE (0 - 10)?";E
00470 J = (49 * E ) + 10
00480 INPUT "WHICH VARIABLE TO CHANGE (1 - 7) ? " ; L
00490 IF L > 7 OR L < 1 THEN 520
00500 PRINT " VALUE TO BE SET AT YEAR ";E;
00510 INPUT K1
```

```

00520 U1 = 10: CLS: HIRES
00530 REM *** PUT BASE LINE ON SCREEN ***
00540 FOR I = 1 TO 10
00550 PLOT INT(U1), 0 TO INT (U1) + 49, 0 TO INT (U1) + 49, 4
00560 U1 = U1 + 49
00570 NEXT I
00580 X1 = 11
00590 P1 = (C1 * B1) /A1
00600 A3 = A1 * D1
00610 IF C1 = 0 THEN LET M1 = 0: GOTO 630
00620 M1 = A3/ C1
00630 IF M1 > C1/4 THEN LET M1=C1/4
00640 N1 = P1 * P1/B1
00650 IF N1 > B1/4 THEN LET N1 = B1/4
00660 Q1 = (C1-M1)/F1
00670 R1 = (B1-M1)/G1
00680 C1 = C1 - Q1 - P1 = M1 - H1
00690 B1 = B1 - R1 + N1
00700 IF C1 < 0 THEN LET C1 = 0
00710 IF B1 < 0 THEN LET B1 = 0
00720 Y1 = (.8 * C1)
00730 IF Y1 < 1 THEN LET Y1 = 1
00740 IF Y1 > 200 THEN LET Y1 = 200
00750 IF X1 = 10 THEN 760: IF X1 < 10 THEN LET X1 = 10
00760 SET INT (X1), INT (Y1)
00770 Y1 = (.5 * B1)
00780 IF Y1 > 1 AND Y1 < 250 AND X1/3 = X1/3 THEN PLOT INT (X1),
INT (Y1)-1 TO INT (X1), INT (Y1) + 2
00790 X1 = X1 + 2
00800 IF INT (X1) < J OR INT (X1) > J + 1 THEN 910
00810 PRINT " YEAR" ;E; "";
00820 ON L GOTO 830, 840, 850, 860, 870, 880, 890
00830 PRINT " TERR " ;A1;:A1 = K1: GOTO 900
00840 PRINT " PREY " ; INT (C1);: C1 = K1: GOTO 900
00850 PRINT " PRED " ; INT (B1);: B1 = K1: GOTO 900
00860 PRINT " YIELD " ;D1;:D1 = K1: GOTO 900
00870 PRINT " PREY SPAN " ; F1;: F1 = K1: GOTO 900
00880 PRINT " PRED SPAN " ;G1;: G1 = K1: GOTO 900
00890 PRINT " CULL " ; H1;: H1 = K1
00900 PRINT " -> " ;K1; "";
00910 IF X1 < 490 THEN 590
00920 INPUT "" ;A2$
00930 GOTO 220
```

START AND STOP KEY

P. J. Bisset, Benowa Qld.

A useful keyboard addition would be a RUN/STOP key to start program execution and halt single key operations. This program simply allows the ESC key to be used to run and halt BASIC programs.

It is based on a program written by D. J. Whyatt for

the Microbee and published in ETI, December 1983 on page 57.

The routine checks the keyboard input and if ESC is pressed then control is passed to ESCKEY. Pressing any key will automatically start the BASIC

program currently in memory.

When a program is running ESC will also halt the program temporarily.

Once the BASIC listing has been entered it can be deleted and the ESC key used to start and stop BASIC programs that are subsequently entered.

SOURCE LISTING

LINE	LABEL	MNEM	OPERAND
00100		ORG	3A98H
00110		CALL	0A3E9H
00120		PUSH	AF
00130		CP	1BH
00140		JR	Z,ESCKEY ;if ESC pressed then jump
00150		POP	AF
00160		RET	
00170	ESCKEY	POP	AF
00180		CALL	8006H ;wait for key to be pressed.

00190	CP	1BH
00200	RET	Z ;if ESC pressed then leave routine
00210	JP	801EH ;otherwise start BASIC program.

BASIC LISTING

```

00100 FOR I=15000 TO 15019:READ D:POKE I,D:NEXT I
00110 POKE 194,152:POKE 195,58
00120 DATA 205,233,163,245,254,27,40,2,241,201
00130 DATA 241,205,6,128,254,27,200,195,30,128
```

**NEW
RELEASE**



microbee

**SERIES 2
PERSONAL
COMMUNICATOR
NOW WITH TELCOM 1**



- Built-in real time clock with alarm facility
- 16 programmable baud rates from 50 to 19200 (7/8 Bit)
- Auto dialling/hangup for modem
- File capture to Wordbee format and screen printing
- Super friendly menu driven
- Usable as stand alone or through Wordbee or Basic
- Now available for all IC or later microbees
- World standard Christensen protocol for file transfer



Now every microbee can become a personal terminal using TELCOM 1. TELCOM 1 is a ROM based communications program suitable for all ROM based microbee IC and later models. It allows the use of the serial RS232 port at 16 baud rates from 50 to 19200 Baud, provides real time clock with alarm feature, modem control functions such as automatic dialling, BASIC WORDBEE and MACHINE LANGUAGE file transfer via the serial port. Additionally the ROM emulates the ADM 3A and Televideo 912 terminals for connection to other computers. All information can be viewed on the screen and retrieved as a WORDBEE file and even printer-out using the built in screen print utility.

1984 IS THE YEAR OF THE NETWORK with over 20,000

microbees now in everyday use and most with integrated software including WORDBEE, MICROWORLD BASIC and COMMUNICATIONS capability are you missing out on the computing opportunity of the year? Using a low cost modem such as the BEEMODEM you can now talk to other computers around the world, use the public domain bulletin boards, shop electronically, communicate with friends with your own home telex and extend your computing horizons by converting your microbee to your personal INFORMATION WINDOW to the world.

A big feature of the microbee PERSONAL COMMUNICATOR is the battery backed CMOS RAM which stores your programs even when the power has been disconnected. This

is particularly useful with WORDBEE or BASIC files which can be entered at home and then your microbee can be taken to school or the office for printout or further editing. If your needs grow you can expand your PERSONAL COMMUNICATOR to the ADVANCED PERSONAL COMPUTER using disk drives. Ask your microbee computer shop for details.

- microbee SERIES 2 PERSONAL COMMUNICATOR (with TELCOM 1) \$499.00
- microbee HIGH RESOLUTION MONITOR (Green) \$249.00
- microbee HIGH RESOLUTION MONITOR (Amber) \$269.00
- microbee DOT MATRIX PRINTER with cable \$449.00
- microbee DATA TAPE RECORDER \$49.50
- BEEMODEM 300 baud DIGITAL MODEM (Telecom approved) \$149.50
- TELCOM 1 ROM SET (with manual and conversion details) \$15.00



**ADVANCED
PERSONAL
COMPUTER**

The microbee Series 2 Advanced Personal Computer with 400K disk drive and world class software such as CP/M, MICROSOFT BASIC, MULTIPLAN, WORDSTAR and a powerful library of support programs all for only \$1495.

The microbee Series 2 Advanced Personal Computer is the most powerful and best price/performance computer in its class. What's more any existing microbee owner can convert his microbee to the Series 2 APC at any time.

The microbee Series 2 APC uses the popular Z80 microprocessor and runs standard CP/M so that users have access to the vast library of CP/M software available world wide.

You can expand your microbee Series 2 APC to drive 2 or more disk drives. A hard disk drive unit is now operational and will release soon.

Your microbee Series 2 APC is a world class machine from the hardware as well as the software point of view. The exclusive SETDRIVE utility will convert your disk system to read diskettes from a host of other computers. The Series 2 APC is also equipped with VIRTUAL DRIVE capability. This means single disk owners can readily copy from A to B using only one drive. Another world first is the CONFIG program which enables a Series 2 APC user to reCONFIGure his CP/M system to select screen positioning, background and foreground colour, parallel and serial printers disk drive information and even auto-start disks.

**\$1495 WITH SINGLE
400K DISK DRIVE**

**\$1795 WITH DOUBLE
400K DISK DRIVE**



STIMULATING SOFTWARE

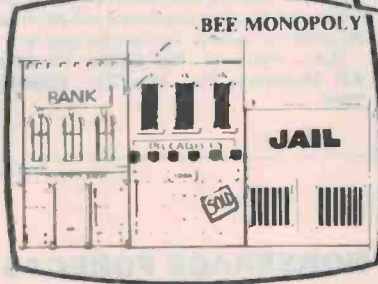
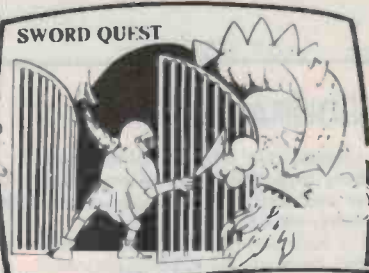
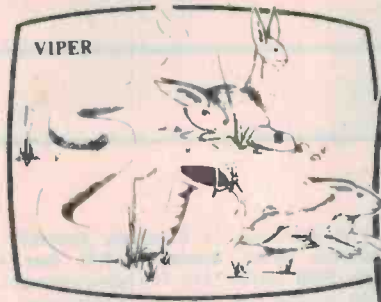

VIPER

A highly addictive game. You must eradicate the rabbits before they reach plague proportions but each time you catch a rabbit your tail grows.

Cassette \$14.95 Diskette \$19.95

BEE MONOPOLY

Now a full graphic version of the old family game of the same name. The entire board, players, Community Chest and Chance cards are displayed as required in this fast moving game. Full details of land ownership and finances. Superb graphics and sound effects. (Requires 32K).

Cassette \$14.95 Diskette \$19.95

SWORD QUEST

Just like the 'Dungeons and Dragons' series. Select your characters level of armour, weapons, strength and skill. Explore in search of treasure and the Great Sword, and battle with the dungeon's creatures.

Cassette \$14.95 Diskette \$19.95

FROG HOP

A most graphic variation of the popular arcade game. You must hop across a busy street (watch out for the trucks ...) and across a crocodile infested stream before your frogs are safely home. Guaranteed to appeal to all ages.

Cassette \$14.95 Diskette \$19.95

ROBOT MAN '84

Now one of the most popular games ever written for the microbee has been rewritten with new twists, a joystick and colour option.

Cassette \$14.95 Diskette \$19.95

MICROSPACE INVADERS '84

New update of one of the original microbee games. Now with full colour and joystick option. Sound and speed controls. Turn your microbee into a home arcade machine.

Cassette \$14.95 Diskette \$19.95

SCRAMBLER

A full colour version of the popular arcade game. You are the sole surviving defender of earth and you must destroy the aliens at all cost ... very effective colour graphics (also suitable for non colour microbees).

Cassette \$14.95 Diskette \$19.95

EYE OF MIN

A graphic adventure game that will absorb you for hours. If you can solve this excellent mystery then you can proceed to the next saga 'Sabre of Sultan'. (Requires 32K).

Cassette \$14.95 Diskette \$19.95

SKETCH PAD

Use the high resolution graphics in your microbee with this most effective drawing aid. Ideal as an introduction to Cad techniques and you can create complex shapes with a little practice. You can also 'trace' from images taped onto the screen to generate faithful reproductions. Have you ever wondered how programmers create the graphics for their software?

Cassette \$14.95 Diskette \$19.95

LEARNING CAN 'BEE' FUN

Now the full series by John Grimley in one value package containing 6 cassette tapes (or 1 diskette). Utilizing well known games such as 'Donkey Kong', 'Frog Hop' and 'Rescue' you can enjoy the game and learn at the same time.

Cassette Library Pack \$49.95
Diskette \$39.95

ELECTRONIC HOBBY MATE

A real first. This clever program deals with resistors, capacitors, electronic terms and contains a wealth of 'live' information. A must for all experimenters. Your microbee will become a useful design aid.

Cassette \$14.95 Diskette \$19.95

TUTORIAL: Touch Typing Tutor and Basic Tricks.

The microbee is an ideal educational computer recommended by educational authorities across Australia. This package enables you to learn to touch type using the Pitman touch typing method. For those who want to master Microworld Basic there is a series of hints and suggested subroutines arranged in a most effective menu driven style.

Cassette \$14.95 Diskette \$19.95

RING OF DOOM

Your quest is to search for the Dark Lord of Saurean's Ring of Power. This action adventure game will operate in a 16k microbee.

Cassette \$14.95 Diskette \$19.95



Ask your nearest microbee dealer for a catalogue of over 100 microbee programs now available on cassette, diskette and ROM covering applications in education, games and utility functions.

microbee computer shops

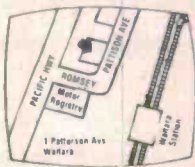

1 Pattison Ave,
Waitara 2077.
Phone (02) 487 2711

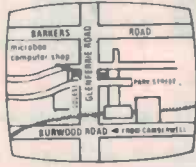

729 Glenferrie Rd,
Hawthorn 3122.
Phone (03) 819 5288

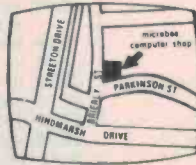

Coleman Court,
Weston A.C.T. 2611.
Phone (062) 88 6384



141 Stirling Highway,
Nedlands, Perth.
Phone (09) 386 8250



DIRECT ORDERS
PHONE (02) 487 2711

APPLIED
TECHNOLOGY
RETAIL
PTY LTD



microbee

Authorised Dealers:

NSW: Jaycar, Inc. Electronic Agencies
117 York Street, Sydney.
115 Parramatta Road, Concord.
121 Forest Road, Hurstville.
Cnr Carlingford and Pennant Hills Road,
Carlingford.
Compu-K, 7 Casino Street, Lismore.
Comput/Ed, 8 Park Arcade,
Park Avenue, Coffs Harbour.

ACT: Computech, Belconnen Churches Centre,
Benjamin Way, Belconnen.

VIC: Computerland South Melbourne,
37 Albert Road, Melbourne.

S.A. Key Computers,
1061 South Road, Edwardstown.
77 Grenfell Street, Adelaide.

QLD: Software 80, 105 Milton Road, Milton.
Electrographic Office Systems,
25 Grafton Street, Cairns.

Town and Country Computers,
CTL Centre, Anne Street, Aitkenvale, Townsville.

TAS: Central Data, 14A Goodwin Street,
Launceston.

★ ENCOURAGEMENT ★

Ozi-Soft, in conjunction with Computer Technics, is offering to donate a VIC-20 expansion board for the best software item submitted to this column every month.

The board is Australian-designed and manufactured and simply plugs into the VIC-20's expansion slot. It features three sockets that can be independently switch-selected, plus an on-board reset switch. With it you can plug in up to three separate expansion units to your VIC-20 and avoid the hassle of plugging things in and out and turning the computer on and off each time.

It is distributed by Computer Technics, 123 Clarence Street, Sydney (G.P.O. Box 4936) NSW 2000. (02)29-7244. The board costs \$59.95.

All submissions must be accompanied by a signed letter from you stating that it's your original work. The winning submission will be judged by the Editor and no correspondence will be entered into. All published submissions will be paid for.

Send entries to: The Editor, VIC-20 Column, ETI Magazine, P.O. Box 227, Waterloo NSW 2017.

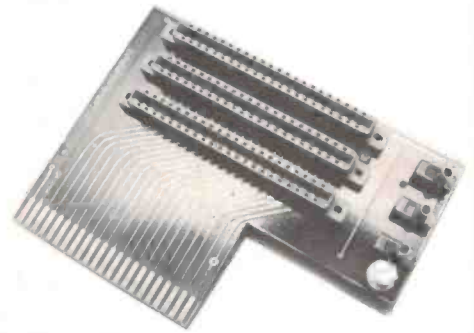

HORSERACE FORECAST

Matt Underwood, Box Hill North, Vic.

If you like to have a bet on the horses then this program may help you to make some money. However, the predictions of this program as to which horse will run first, second, etc, may not be accurate as there are many factors which affect the result. But with a bit of common sense the punter should show a profit over a number of races.

I tried this program for the Caulfield and Melbourne Cup and I found it very helpful. It picked three of the first five place getters in the Caulfield and the winner of the Melbourne Cup, so I am showing a profit so far.

The program gives the option of having a printout made of the results. Some lines may exceed the allowable 88 characters so some words may have to be abbreviated.

Most of the data needed to feed into this program may be found in any newspaper which has a turf or form guide of the races.

HORSERACE FORECAST

READY.

```

10 PRINT "J":POKE36879,26
20 DIMHN$(50),VA(50)
30 GOSUB1000
40 CO=1:OC=CG:PRINT "J":POKE36879,29
50 PRINT "ENTER TRACK CONDITIONS"
60 PRINT "1=HEAVY":PRINT "2=SOFT":PRINT "3=SOFT-GOOD":PRINT "
4=GOOD":PRINT "5=GOOD-FIRM":PRINT "6=FIRM":PRINT "7=HEAVY"
70 INPUTCG:CG=INT(CG)
80 IFCG<1ORCG>7THEN50
90 PRINT "J"
100 PRINT "ENTER NAME OF RUNNER":CO:INPUTHN$(CO)
110 PRINT "ENTER POSITION IN ODDS":INPUT OP
120 PRINT "J: NOW ENTER#":FC=0
130 PRINT "ENTER BARRIER NUMBER":INPUTPR
140 IFOC=CGANDPR=1THENFC=FC+2
150 IFOC=CGANDPR<4THENFC=FC+1
160 IFOC=CGANDPR>8THENFC=FC-2
170 IFOC=CGTHENFC=FC-1
180 IFPR=1THENFC=FC+1
190 FC=FC-1
200 IF FC>10THENFC=10ORIF FC<-10THENFC=-10
210 PRINT "PLACING IN LAST RACE RUN":INPUTP1
220 PRINT "PLACING IN SECOND LAST RACE":INPUTP2
230 PRINT "PLACING IN THIRD LAST RACE":INPUTP3
240 PRINT "PLACING IN FOURTH LAST RACE":INPUTP4
250 PRINT "ENTER CLASS OF JOCKEY (1-4)":INPUTJC
260 PRINT "ENTER ZERO IF WEIGHT CARRIED OR TEN IF NOT":
INPUTWE
270 PRINT "ENTER NO. OF TIPS GIVEN":INPUTTP
280 IFP1=0THEN300
290 P1=12/P1
300 IFP2=0THEN320
310 P2=12/P2
320 IFP3=0THEN340
330 P3=6/P3
340 IFP4=0THEN360
350 P4=6/P4
360 OP=OP+3
370 OP=60/OP
380 JC=12/JC
390 TP=TP/2
400 OT=P1+P2+P3+P4+OP+FC+JC+WE+TP
410 VA(CO)=OT
420 PRINT "J"
430 PRINTHN$(CO);" HAS BEEN ASSIGNED THE RATING OF ";VA(CO):
435 PRINT
440 PRINT "ANY MORE HORSES (Y/N)":INPUTAA$
450 IFAA$="Y"THENCO=CO+1:GOTO90
460 OT=0:FORX=1TOCO:OT=OT+VA(X):NEXT
465 PRINT
470 PRINT "PRINTOUT YES/NO":INPUTP$
480 PRINT "J"
490 IFP$<>"YES"THEN520
494 PRINT "PLEASE WAIT"
495 PRINT "FOR PRINTOUT"
500 OPEN3,4
510 CMD3
520 PRINTRN$
525 PRINT
530 PRINT "FIRST IS":GOSUB2000:PRINT
540 PRINT "SECOND IS":GOSUB2000:PRINT
550 PRINT "THIRD IS":GOSUB2000:PRINT
560 PRINT "FOURTH IS":GOSUB2000:PRINT
570 PRINT "FIFTH IS":GOSUB2000:PRINT
575 IFP$<>"YES"THEN595
580 PRINT#3
590 CLOSE3
595 PRINT
600 PRINT "ANY MORE RACES TO FORECAST (Y/N)":INPUTAA$
610 IFAA$="Y"THENRUN
620 END
1000 PRINT "* HORSE RACE FORECAST *"
1005 PRINT "BY MATT UNDERWOOD"
1006 PRINT "HAPPY PUNTING":PRINT "GOOD LUCK!"
1008 POKE36878,15
1010 READP:IFP=-1THEN1040
1020 READD:POKE36876,P:FORX=1TOD:NEXT:POKE36876,0:
FORX=1TO50:NEXT:GOTO1010
1040 PRINT "ENTER NAME OF RACE TO BE FORECAST":INPUTRN$
1050 RETURN
2000 HI=0:WH=0
2010 FORX=1TOCO
2020 IFVA(X)>HI THENWH=X:HI=VA(X)
2030 NEXT
2040 PRINTHN$(WH);" WITH ODDS OF ABOUT ";OD=(OT-HI)/HI:
IFOD<1THEN3000
2050 PRINTOD;" TO 1"
2060 VA(WH)=0
2070 RETURN
3000 OD=HI/(OT-HI):PRINT "1 TO";OD
3010 GOTO2060
4000 DATA195,50,209,50,219,50,225,50,225,50,225,50
4010 DATA219,50,219,50,219,50,209,50,219,50,209,50,195,300
4020 DATA195,50,209,50,219,50,225,50,225,50,225,50
4030 DATA195,50,195,50,195,50,209,300,-1
READY.

```

THE VIC-20 COLUMN

Peter Skilton of Seaford Vic. is the winner of the VIC-20 expansion board this month. His useful program, Curve Fitter, gives the line-of-best-fit to graphical data.

CURVE FITTER ☆☆☆

Peter Skilton, Seaford, Vic.

This program proves that the VIC-20 can do more than just play video games. It gives you the line-of-best-fit to graphical data, the procedure being to obtain the gradient and intercept of the line. In this simple case we are adjusting two parameters (m and c, if $y=mx+c$).

This program is a general routine for fitting any (x,y) data for any mathematical function with any number of adjustable parameters. The theory from which this algorithm comes can be found in most advanced books on non-linear least-squares techniques i.e. *Data Reduction and Error Analysis for the Physical Sciences* by P. R. Bevington.

A general subroutine at line 740 is provided to find the inverse matrix of the P x P matrix A1. This will work for any square matrix of any size and so could be used in many other programs. The inverse is returned in the P x P array E.

The listing shown fits a cubic equation with its four adjustable parameters. Pictorially, this is done by

searching five-dimensional parameter hyperspace (with a program pointer of length equal to lambda) for the minimum of the well that is present. The parameter values corresponding to the bottom of the well are those of the curve-of-best-fit. By the nature of the cubic power series, if your data is more accurately represented by a parabola or line, then the higher order parameters will approach zero as required.

When the program is running it just fits into the unexpanded VIC and can handle up to 34 input data points. Of course, more can be input with a memory expansion cartridge and by redimensioning the array Y in line 70.

Intermediate calculations are displayed on the screen during execution. The time between these iterations will increase with the number of data points.

The criterion for convergence of the fit is that the smallest value of chi-square is obtained. This variable is related to the deviation of your data from the calculated curve-of-best-fit. So the closer chi-square is to zero, the better the fitted equation matches your data. The final results give the parameters followed by their respective standard deviation in brackets.

A sample printout is shown using the temperature dependence of resistance for a thermistor. The calculated curve-of-best-fit is drawn on the graph. I strongly recommend that you try these data once you have typed in the program as any bug may distort the apparent parameter values obtained.

This is an entirely general routine which can be used to fit any mathematical function. If you wish to

change the equation fitted then seven lines need to be altered.

At line 60 set P equal to the number of adjustable parameters in the function and let FS be whatever equation you are fitting. In line 80 set PS to be all the adjustable parameters (each must be two characters long) exactly as you gave them in FS.

In 630 you must give P expressions of the form $Q_n=P(n)$. In 640 is the value of the function at X. Q1, Q2, Q3, etc, correspond to the parameters in the order you gave them in PS, so write 640 in the form $F0=$ (right-hand side of FS) except using Q1, Q2, Q3, etc, in the expression for FS instead of the nomenclature you chose in PS.

In line 650 are the partial derivatives of line 640 with respect to each parameter Q_n . Thus the partial derivative of, say, $F0=Q1*EXP(Q2*X)$ with respect to Q1 would be $D(1)=EXP(Q2*X)$ and with respect to Q2 would be $D(2)=Q1*X*EXP(Q2*X)$.

Line 680 is identical to 630 except for using the array P1 instead of P. Line 700 is simply $T=Y(J,2)$ which is the expression given in the right-hand side of line 640.

If you are unfortunate enough to get an error message (assuming no typing mistakes), then probably your initial guesses were grossly wrong i.e. several orders of magnitude out, or else your derivative expressions in 650 are incorrect.

Remember that the number of data must exceed the number of adjustable parameters by at least one to define chi-square and unambiguously give the curve-of-best-fit.

CURVE FITTER

```

10 POKE36879,110:PRINT"CURVE FITTER"
20 PRINT"DATA FITTING PROGRAM FOR ANY DIFFERENTIABLE
   *****FUNCTION"
30 PRINT"DATA MUST BE ENTERED***** (X,Y) VALUES*****"
40 REM P.F.SKILTON 1/2/83
50 P=4:F$="Y=A0+A1.X+A2.X**X+A3.X**X**X"
70 DIMA(P,P),A1(P,P),D(P),E(P,P),P(P),P1(P),S(P),X(P,1),
   Y(35,2),P$(P*2)
80 P$="A0A1A2A3"
90 DATA0.0001,0.001,100,1:REM PERFORM A NON-LINEAR LEAST-
   SQUARES FIT
100 READE1,L1,H,W:GOSUB460:PRINT"PARAMETER GUESSES"
110 FORI=1TOP:PRINTMID$(P$,2*I-1,2)="":INPUTP(I):
   GOSUB500:NEXT
120 FORI=1TOP:P1(I)=P(I):X(I,1)=0:FORJ=1TOP:A(I,J)=0:NEXT:
   NEXT
160 FORY=1TOI1:GOSUB620:FORJ=1TOP:X(J,1)=X(J,1)+H0*(Y(Y,2)
   -F0)*D(J)
200 FORK=1TOJ:A(K,K)=A(K,K)+H0*D(J)*D(K):NEXT:NEXT:NEXT
230 FORJ=1TOP:FORK=1TOJ:A(K,J)=A(K,K):NEXT:NEXT:
   IFN0=0THENGOSUB670:GOSUB540
250 S0=S
260 FORK=1TOP:FORL=1TOP:A1(K,L)=A(K,L)/SQR(A(K,K))*A(L,L):
   NEXT:A1(K,K)=1+L1:NEXT
300 GOSUB740:FORJ=1TOP:P1(J)=P(J)
330 FORK=1TOP:P1(J)=P1(J)+X(K,1)*E(K,J)/SQR(A(K,J))*A(K,K):
   NEXT:NEXT
350 GOSUB670:IFS<=(1+E1)*S0THENGOTO300
360 L1=L1*10:IFL1>1E+10THENPRINT"MAX. LAMBDA EXCEEDED":STOP
370 GOTO260
380 N0=N0+1
390 FORJ=1TOP:P(J)=P1(J):S(J)=SQR(E(K,J)/A(K,J))*SQR(S0)
   :NEXT:GOSUB540
410 IF(S0-S)/S0<=E1THEN440
420 IFN0=0THENPRINT"MAX. ITERATIONS REACHED":STOP
430 L1=L1/10:GOTO120
440 PRINT"FINAL RESULTS" :PRINT F$ :Q1:GOTO550
460 I=1:PRINT"ENTER DATA.....*****FINISH BY TYPING 999**"
470 PRINT"X";I:)=":INPUTY(I,1):IFY(I,1)=999THENI=I+1:
   GOTO510
490 PRINT"Y";I:)=":INPUTY(I,2):GOSUB500:I=I+1:GOTO470
500 FORJ=0032TO8185:POKEJ,32:NEXT:PRINT"TTTT" :RETURN
510 INPUT"ANY CHANGES TO DATA?":Y$:IFY$="N"THENRETURN
520 GOSUB500:PRINT" DATUM NO. =":INPUTI:GOSUB500:PRINT
   "X";I:INPUT"Y";I:)=":Y(I,1)
530 PRINT"X";I:INPUT"Y";I:)=":Y(I,2):GOSUB500:GOTO510
540 PRINT"J"

```

```

. 550 FORI=1TOP:PRINTMID$(P$,2*I-1,2)" "P(I):PRINT" ("S(I)"):
   :PRINTNEXT
. 590 PRINT"ITERN:"N0" DATA:"I1:PRINT"LAMBDA "L1:PRINT"
   :CHISQR:"S
. 600 IFQ=1THENPOKE36879,13:END
. 610 RETURN
. 620 REM FUNCTION AND PARTIAL DERIVATIVES SUBROUTINE
. 630 Q1=P(1):Q2=P(2):Q3=P(3):Q4=P(4)
. 635 X=Y(Y,1)
. 640 F0=Q1+Q2*X+Q3*X**X+Q4*X**X**X
. 650 D(1)=1:D(2)=X:D(3)=X**X:D(4)=X**X**X
. 660 RETURN
. 670 REM CHISQR SUBROUTINE
. 680 O1=P1(1):O2=P1(2):O3=P1(3):O4=P1(4)
. 690 S=0:FORJ=1TOI1:X=Y(J,1)
. 700 T=Y(J,2)-O1-O2*X-O3*X**X-O4*X**X**X
. 710 S=S+T**T*H0:NEXT:S=S/(I1-P):RETURN
. 740 REM MATRIX INVERSION SUBROUTINE E=INV(A1)
. 750 FORI=1TOP:FORJ=1TOP:E(I,J)=A1(I,J):NEXT:NEXT:FORK=1TOP:
   :FORJ=1TOP:IFJ=KTHEN800
. 790 E(K,J)=E(K,J)/E(K,K)
. 800 NEXT:E(K,K)=1/E(K,K):FORI=1TOP:IFI=KTHEN880
. 840 FORJ=1TOP:IFJ=KTHEN870
. 860 E(I,J)=E(I,J)-E(K,J)*E(I,K)
. 870 NEXT
. 880 NEXT
. 890 FORI=1TOP:IFI=KTHEN920
. 910 E(I,K)=-E(I,K)*E(K,K)
. 920 NEXT:NEXT:RETURN
. FINAL RESULTS
. Y=A0+A1.X+A2.X**X+A3.X**X**X
. A0 (.93999998
   (.497089077)
. A1 -2.32488093
   (.0428482003)
. A2 .041071428
   (.13789603E-03)
. A3 -2.58333329E-04
   (.9.44878522E-06)
. ITERN: 7 DATA: 5
. LAMBDA: 1E-09
. CHISQR: 1.28571414E-03
. READY

```

X[°C]	Y[kΩ]
20	29.8
30	22.2
40	18.1
50	16.1
60	14.5

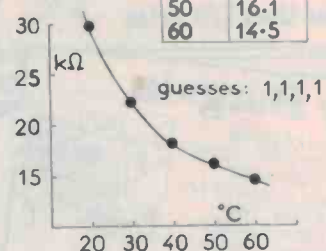

High Speed Drill Deluxe Drill Set \$69⁰⁰

Precision drill with 3 interchangeable collets for sizes from .1mm to 2.4mm. 10-500 RPM 9-16V. Ref 20,000

\$16⁵⁰

Includes Drill, stand and flexible drive complete with 30 accessories in carrying case. Includes the High Speed Drill shown above plus the drill set shown below. Ref 20100

Drill Stand

Stand for Ref 20,000 drill (above). Ideal for PCBs Ref 20,400

\$12⁵⁰

Knockout Bargains

Save on Solder Vac

Buy the best quality desoldering tool at the lowest price around. The incredible U.S. made Soldervac comes with teflon™ tip, powerful low inertia plunger and self lubricating trigger latch. Gets parts out of PCBs in seconds.

don't pay \$12.80

only \$8⁵⁰



Current/Polarity Checker

Incredibly versatile AC and DC checker works over the range 3.5V to 400V. Ingenious three LED system indicates AC (both lights), DC positive (plus light) DC negative (minus light). Use it in the home, the car and the workshop.

don't pay \$6.95

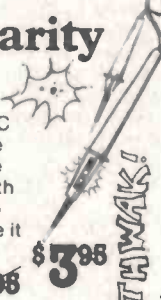

Centronics Plugs at Knockout Prices

Our opposition are asking around \$20.00 for these plugs. Come to Sheridans for a Knockout deal!!

Amphenol type 57/303/60 solder spill type **\$9.50**

Ribbon cable type **\$9.70**



Jawbreaker purchase!!

Top quality English Made by SAE. 10 way .1" DIL DIP switch. Special top quality pushbutton type. At a punchup price!! \$1.30 each 10+ \$1.20

Less than 1/2 price

The Ultimate joystick for the VIC-20 and Atari

The incredible Pointmaster is truly the finest Joystick on the market and will add incredibly to your enjoyment of video computer games. Just look:

- High speed thumb trigger
- Unique hand grip (as on actual aircraft)
- Self centring
- Long 150cm cord.

\$29⁹⁵



Illuminated Pushbutton

These superbly made IMO pushbuttons are perfect for car and other alarm situations. SPDT momentary action with 12V long life globe. Available in red, green or yellow lense. Others are asking \$15.00. Put them in the losers corner!!

only \$8⁹⁵

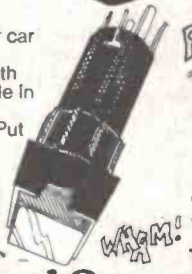

Hewlett Packard Opto HDSP-5301 .56" Common Anode

Equivalent to FND507 (but better) **only \$2.05 each, 10+ \$1.85**

HDSP5303 .56" Common Cathode equivalent to FND500 (but better) **only \$1.70 each, 10+ \$1.55**

HP 5082-7730 .3" common anode equivalent to MAN71, DL707) **only \$1.50 each, 10+ \$1.35**

HP 5082-7740 .3" common cathode equivalent to MAN74, DL704 etc **only \$1.50 each, 10+ \$1.35**



Flexible Drive Shaft

Suits the high speed drill above. Complete with chuck and colletes. Ref 20,700

\$10⁹⁵



NEW! Precision High Speed Model

Capacity to 3.5mm, 9 to 18 volts. 20,000RPM. A really superb drill that will give years of use.

\$24⁰⁰

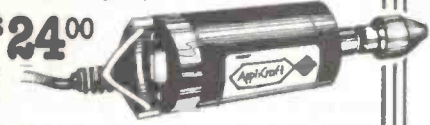

Drill Set

This fantastic drill set includes the high speed precision drill shown above plus a wide range of 15 accessory drills, brushes and grinders. Ref 40,100

\$35⁹⁵

Heavy Duty Stand

Suits precision high speed drill. Perfect for any hobbyist work. Ref 40,400

\$20⁰⁰



Modutec Car Alarm

This is the most powerful and comprehensive car protection system on the Australian market we have seen. Compare the features. Then you'll know its the best.

- Automatic or Manual start
- When tripped it sounds horn and disables ignition system
- Dash mounted warning light
- Variable entry and exit times
- 12 months warranty
- Protects accessories

only \$89⁰⁰



Relay Bargain

New Shipment of these superb miniature PC mount relays. Both types have SPDT contacts. Rated at 1A/125V and 2A/30V. Two types: 5V/75ohm coil and 12V/400ohm coil. Quality at a really low price.

\$1.75 each \$1.50 ten up



SHERIDAN ELECTRONICS

164 - 166 Redfern Street, Redfern NSW 2106. Phone (02) 699 6912, (02) 699 5922. Mail Orders to Dept ETL, PO Box 229 Redfern NSW 2016

Trading Hours

Mon-Fri 9am-5.30pm
Thursday 9am-7pm
Saturday 9am-12noon

NB: All Prices include tax

Mail Charges

\$5.00-\$9.99 \$3.50
\$10.00-\$24.99 \$4.00
\$25.00-\$49.99 \$6.00
\$50.00-\$99.99 \$7.00
\$100.00 or over \$8.00

Note:

We regret we cannot give quantity discounts on Credit Card purchases.

Credit Cards: We accept both Bankcard and American Express.

Minimum Order \$6.00

Large and heavy items sent Freight On.

Air Express 923 1499

SPECTRUM ANALYSER TWINNS FROM TEK.

Tektronix is adding a new set of 'twins' to its 490 series spectrum analyser family. The two major new products — the 494 and its programmable compatible counterpart, the 494P — offer many features never before available in a spectrum analyser, the company claims.

The new analysers cover the frequency range from 10 kHz to 325 GHz and offer an exclusive 'help' mode which provides explanations of controls and functions, on the CRT itself, at a push of a button.

The new 494/494P spectrum analysers are similar to the popular 492/492P (50 kHz to 220 GHz) and the 496/496P (1 kHz to 1.8 GHz) spectrum analysers in appearance, operation, and rugged environmental specifications.

The 494/494P possesses the first three-year warranty in the history of the spectrum analyser industry, Tektronix claims. The 494 and 494P offer frequency measurement accuracy typical of a counter; ± 27 Hz at 21 GHz, a first for portable analysers the company say. Frequency coverage is extended to 325 GHz.

Another significant industry first, according to Tektronix, is the unique 'help' mode that gives the new user operational confidence by displaying control func-

tion descriptions with the touch of a button. When you press the help button instructions appear on the CRT. You can then press any pushbutton and a description of its function appears. The help text, plus all other screen messages, are in English with an optional second language of either German, French, or Spanish.

Ten on-board registers for pre-setting instrument control settings saves set-up time and improves measurement repeatability. Measurements made in the field are transported to the laboratory for comparison and analysis. Up to nine displays are stored with front panel control settings.

A data dump-to-plotter facility provides a plotter interface for hard copies without having to hook up a controller. It is compatible with both Tektronix and Hewlett-Packard GPIB plotters.

The 50-75 GHz, 75-110 GHz and 110-170 GHz bands have been included, plus new wave-

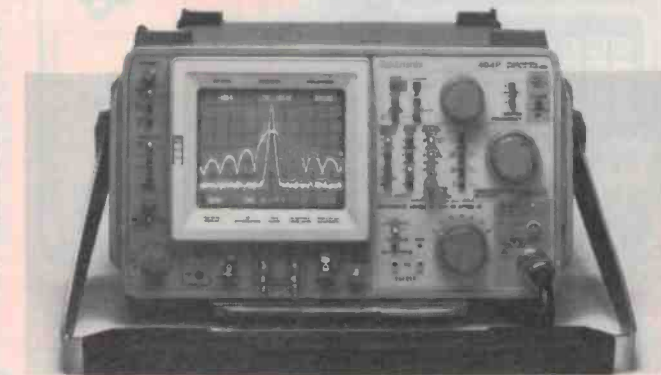

guide mixers for these bands and others that cover from 18 GHz to 325 GHz.

The multiple line CRT read-out displays up to 16 lines of 40

characters for expanded operator prompt messages when operating in programmable mode. For further details contact your local Tektronix office.

LOW-COST FREQUENCY COUNTERS FROM H-P



Two new frequency counters from Hewlett-Packard, the HP 5384A and HP 5385A, offer new levels of accuracy and resolution in economy-priced systems counters covering the frequency range of 10 Hz to 1 GHz.

High input sensitivity coupled with extensive input-signal conditioning result in enhanced performance in R&D testing. Additionally, low-priced systems capability is available in either HP-1B (standard) or HP-1L (Hewlett-Packard Interface Loop), which is optional.

Frequency range for the HP 5384A is 10 Hz to 225 MHz. For the HP 5385A, it is 10 Hz to 1 GHz. Key specifications common to both units include: measurement resolution is nine digits per second minimum; four-

11-digit display resolution is front-panel selectable to simplify readings; input sensitivity is a high 10 mV RMS (typical); and three gate time selections (0.1, 1.0 and 10 seconds) are provided.

Options enhance operation in the lab or the field. They are: HP-1L for low-priced bench or field automation, a battery pack for portable operation and an oven timebase for laboratory accuracy in the field. The remote display feature allows measurement displays in engineering units, such as RPM, % drift, IF, etc., as well as message and prompts, when the counters are used in conjunction with a handheld or desktop computer.

Contact your local H-P office for more details. Tell them "ETI sent me"!

FLEXIBLE LIGHT

The FL-100 flexible light illuminates those hard-to-reach work areas, putting the light where you need it.

Its high-intensity prefocussed bulb and reflector system measures only $\frac{1}{2}$ " in diameter. The tool's 4" long flexible shaft positions light in any direction.

Additional features are a convenient rotary switch and a spring clip on the handle which allows it to be clipped to any handy surface, thereby freeing both hands. Ideal for checking and repairing electronic and mechanical equipment of all types, the FL-100 is essential for workshop and field service use, the company claims. It requires two "AA" batteries (not included).

The FL-100 is available from



stock at local electronics distributors nationwide or directly from **OK Industries, 92 Chandos St, St Leonards NSW.**

WAS
1,345.50/
NOW
\$1,210.95

EPSON HX-20 PORTABLE COMPUTER FROM MAGRATHS

The HX-20 portable computer package—you get a computer, a printer and a display unit—all in one, go anywhere, self-contained system.

LOOK AT THE FEATURES:

• FULL FUNCTION PORTABLE COMPUTER—NOT A CALCULATOR • STANDARD 16 KB RAM EXPANDS UP TO 32 K BYTES OR THE 32 KB ROM MEMORY TO 72 KB • ABLE TO COMMUNICATE • FULL SIZE ASCI I KEYBOARD • BUILT-IN PRINTER • LCD SCREEN • MUSIC GENERATION VIA PIEZO-ELECTRIC SPEAKER • MICROSOFT BASIC • TIME AND DATE FUNCTIONS.

For fixed location use you can also add on the following options—display controller for monitoring on large screens (even your home TV), floppy disk drive for expanded memory, and acoustic coupler for two-way information transfer.

SPECIFICATIONS:

Peripheral Interfaces	Special Connector
Bar Code Reader	Standard audio cassette interface.
External Cassette	16-bit address bus; 8-bit data bus and control lines; 40 pin connector.
System Bus	1/10 port with 3 input, 6 output lines
ROM Cartridge/Microcassette Interface	NiCd batteries; internal; Sub C type; 1200 mA/H capacity; 40 hour capacity running BASIC (less depending on use of RS-232C port, printer or optional microcassette). Full charge within 8 hours.
Power Supply	29.0 x 21.5 x 4.4 cm (11.4" x 8.5" x 1.7"). Approx. 1.7 kg (3 lbs 13 oz).
Recharge	8 KB RAM plus 24 KB ROM or 16 KB RAM plus 16 KB ROM.
Physical Characteristics	Total expansion is 32 KB. Uses standard microcassette tapes.
Size	Microcassette
Weight	ROM Cartridge
Options	
Expansion Unit	

INSTRUMENT CASES

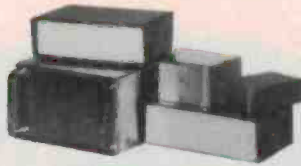

BETACOM

	w	d	h	
IC 1-1	155	120	55	\$16.79
IC 1-2	230	180	80	\$26.40
IC 1-3	300	230	105	\$38.01
IC 2-1	160	110	55	\$8.23
IC 2-2	200	140	70	\$10.95
IC 2-3	270	220	90	\$18.24
IC 2-4	330	230	100	\$23.95

EDDYSTONE DIECAST BOXES

7969P	92.1 mm	38.1 mm	27 mm	\$3.61
6908P	119.1 mm	93.6 mm	52.4 mm	\$5.83
6827P	187.7 mm	119.5 mm	52.4 mm	\$9.32
6357P	187.7 mm	119.5 mm	77.8 mm	\$12.35
9970P	187.3 mm	187.3 mm	63.5 mm	\$21.74

HORWOOD

H84/17V	430 mm	210 mm	100 mm	\$18.89
H84/12V	305 mm	210 mm	100 mm	\$15.71
H84/10V	255 mm	210 mm	100 mm	\$14.51
H84/12V	305 mm	210 mm	100 mm	\$16.78
H84/10V	255 mm	210 mm	100 mm	\$15.42
H84/6V	150 mm	210 mm	100 mm	\$13.37
H93/12V	305 mm	224 mm	75 mm	\$15.90
H93/10V	255 mm	224 mm	75 mm	\$12.79
H34/1/D	100 mm	25 mm	75 mm	\$3.15
H34/2/D	100 mm	50 mm	75 mm	\$3.30
H34/3/D	100 mm	75 mm	75 mm	\$4.46
H34/4/DS	100 mm	100 mm	75 mm	\$4.85
H34/6/DS	100 mm	152 mm	75 mm	\$5.42
H34/8/DS	100 mm	200 mm	75 mm	\$7.14
H34/10/DS	100 mm	255 mm	75 mm	\$8.11

THE LITTLE BIG BOARD

KIT INCLUDES:

- Users Manual
- Printed Circuit Board.
- MP7A Monitor Prom.
- LB00T6 Boot Prom.
- CompoNet Set
- Set Up Sheet

\$494.50

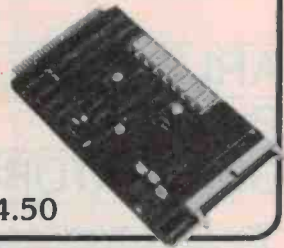

ARISTA ELECTRONICS TV-VIDEO ACCESSORIES

Video Dubbing Kit.
For recording from any video machine to any video machine.

KIT INCLUDES:

- Video Cable 1.5 m 1 PC.
- Audio Cable 1.5 m 1 PC.
- RCA-UHF Adaptor 2 PCS.
- RCA-BNC Adaptor 2 PCS.
- RCA-3.5 mm Adaptor 2 PCS.
- Cable Adaptor, 5 PIN DIN Plug to RCA Jacks (in/out) 2 PCS.

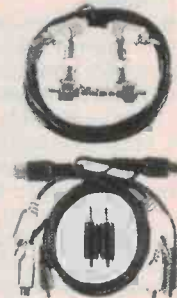

\$16.11

ARISTA ELECTRONICS ALARM-SECURITY ACCESSORIES

MAGNETIC REED SWITCH
SCREW MOUNT

\$3.22



VIDEO TAPE SPECIALS

TDK 3 HOUR VHS \$15.45
TDK 3 HOUR BETA \$15.45



NASHUA DATA DISKS

MD-1	SSD	5 1/4"	\$39.67
MD-1D	SSDD	5 1/4"	\$45.77
MD-2D	DSDD	5 1/4"	\$52.73
FD-1	SSSD	8"	\$46.57
FD-2D	DSDD	8"	\$58.65



SPHERE COMPUTERS PRESENTS

SPECIFICATIONS: AN INTELLIGENT TERMINAL

- Keyboard
- Detachable, capacitive, typewriter-style keyboard.
 - N-key rollover with auto repeat capability.
 - 4 LED indicators for caps lock, on-line, block mode and keyboard lock/protect.
 - Audible keyclick enable/disable.
 - Auto repeat enable/disable.
 - Keyboard lock enable/disable.
 - Repeat rate 20 characters per second.
 - 5 cursor control keys, 10 editing function keys with 14-key numeric key-pad.

- Communication
- Code: 128 ASCI 11 characters.
 - Baud rate: 75, 110, 150, 300, 600, 1200, 1800, 2400, 4800, 9600, 19200.
 - Parity: Odd, even, mark, space.
 - Operating Mode: Full duplex, half duplex or block mode.
 - Interface: EIA RS-232C or 20-mA Current Loop.

- Emulation
- LEAR SIEGLER ADM-3A, HAZELTINE 1500, ADDS VIEWPOINT.
- Screen Presentation
- Display format: 24 lines x 80 characters.
 - Display unit: 12-inch, non-glare

- Green CRT.
- Character type: 7 x 9 dot matrix.
 - Refresh rate: 50/60 Hz.
 - Character set: 96 ASCI 11 characters, 5.1 graphic symbols, 32 control character symbols.
 - 5 screen attributes: Blink, underline, blank, reverse, dual intensity.

- Cursor type: Selectable slow, fast blinking or steady cursor, block, underline or invisible cursor.
- Editing Function
- Cursor: up, down, left, right, home.
 - Insert character, delete character, insert line, delete line, erase to end of line, page and field, field tab, field

back tab, column tab, column back tab, block mode on/off, protect mode on/off, graphic mode on/off, clear unprotected.

- External Control
- Power on/off.
 - Contrast adjustment.
 - Baud rate.
 - Parity and data format.
 - End of message.
 - Emulation mode.
 - Refresh rate.
 - Half duplex or full duplex.
 - Auto line feed.
 - Auto new line.
 - EIA or 20-mA Current Loop.
 - Reverse video or standard video.

WAS
\$1,029.25
NOW
\$914.25



FANTASTIC
VALUE

— Mail or phone orders add \$2.00 up to 1 kg pack post
Special rates for heavy items on request.

ARLUNYA PATTERN GENERATORS

The Arlunya PG100Z series of pattern generators produce video signals for testing VCRs, VTRs, monitors, TV receivers and CCTV systems operating to Pal standards.

All versions give eight monochrome and ten colour patterns with override controls providing superimposed variable size circle, spot, porthole, chroma level, burst level and interlace or non interlace selection.

Patterns include: crosshatch, dots, checkerboard, vertical bars, horizontal bars, multi burst, resolution bars, linear gray scale, standard colour bars, white-red-green-cyan and plain rasters, chroma decoder pattern, chroma staircase, chroma resolution and 'colour black'.



Outputs are video, RF (switched and variable for most VHF and UHF TV channels) and trigger.

The PG100XB model provides slaving from any colour SPG generating subcarrier and standard pulses thus enabling broadcast format signal generation in combination with a broadcast station SPG. A rear internal/external switch determines operating mode.

PG100XP provides slaving facilities from the Arlunya

VPS210 video processor with which it is mainframe compatible.

Versions are available with separate RGB outputs for testing monitors that require such signals. Other versions can be supplied with multiple outputs with or without superimposed number character identification.

For further information, contact: The Dindima Group Pty Ltd, PO Box 106, Vermont, Vic 3133. (03) 873-4455.

NEW LOW VOLTAGE HEXFET

International Rectifier, whose products are distributed in Australia by Warburton Franki, has introduced a new low R_{DS} (on) 60 V HEXFET.

Designated the IRFZ32, the FET has a maximum R_{DS} (on) of 100 milliohm and incorporates the quality and reliability benefits of HEXFETs including .04% AQL, the company claims.

They say that this is due, in large part, to product design factors such as wire bonding pads, solder die attach, epoxy package, passivated die and proven device structure.

Particular features of the IRFZ32 include, extremely low R_{DS} (on), compact plastic package, fast switching, low drive current, ease of paralleling, no second breakdown, excellent temperature stability and excellent parts per million quality.

For full specification details on this latest addition to the HEXFET range, contact Warburton Franki, 199 Parramatta Rd, Auburn NSW 2144.



1 GHz FREQUENCY COUNTER FROM AWA

The LDC-825 from AWA is a digital frequency counter made by Leader capable of measuring frequency over the wide range 10 Hz to 1 GHz and period 100 mS to 1 μ S.

Featuring bright 7-segment fluorescent displays the 8-digit readout provides resolution of 0.1 Hz up to 80 MHz and 10 Hz up to 1 GHz.

The high sensitivity of 20 mV up to 80 MHz and 50 mV, via the 50 ohms input of the pre-scaler, combine with the accurate time base of ± 3 in 10^8 to make the LDC-825 suitable for

many applications in production testing and service of radio-communications systems.

The counter is small and lightweight and can be used over the temperature range 0 to 40°C. It is mains operated and supplied with two input cables and comprehensive operating instructions.

Further information is available from Amalgamated Wire-less (Australasia) Ltd, North Ryde Division, Cnr Talavera & Lane Cove Roads, Macquarie Park, North Ryde NSW 2113. (02)887-7111.

WAVETEK FOR SCIENTIFIC DEVICES

COMMENCING on the 25th day of December, 1983, Scientific Devices Australia Pty Ltd was appointed the new Australian representative for Wavetek Corporation USA.

Wavetek, with the addition of two new divisions to their structure, namely Nicolet Scientific Corporation and Pacific Measurements, is one of the largest instrumentation suppliers in the USA.

Their products include FFT analysers, synthesisers, programmable filters, RF signal generators, RF components, RF sweep generators, microwave generators, instrumentation controllers, pulse/function generators, arbitrary programmable generators, instrument controllers, network analysers and power meters.

Scientific Devices offer marketing and support for Wavetek products with full service facilities. Contact Scientific Devices Australia Pty Ltd for further information on this appointment at any one of the offices in Melbourne, Sydney or Adelaide.

H-P's RF SIG GEN FAMILY

Hewlett-Packard describes its family of RF signal generators in a new eight-page, four-colour product brochure providing key features and benefits of each instrument.

Included in the brochure are selection guides based on both applications and specifications for each of the programmable and manually-tuned generators and a spectral-purity-comparison graph. The literature number is 5953-8383. Enquire at your local H-P office.

FOR QUALITY, PERFORMANCE & VALUE, AARON MUST BE YOUR FIRST 'SCOPE CHOICE

(and for after sales service too!)

AARON

The most popular low cost

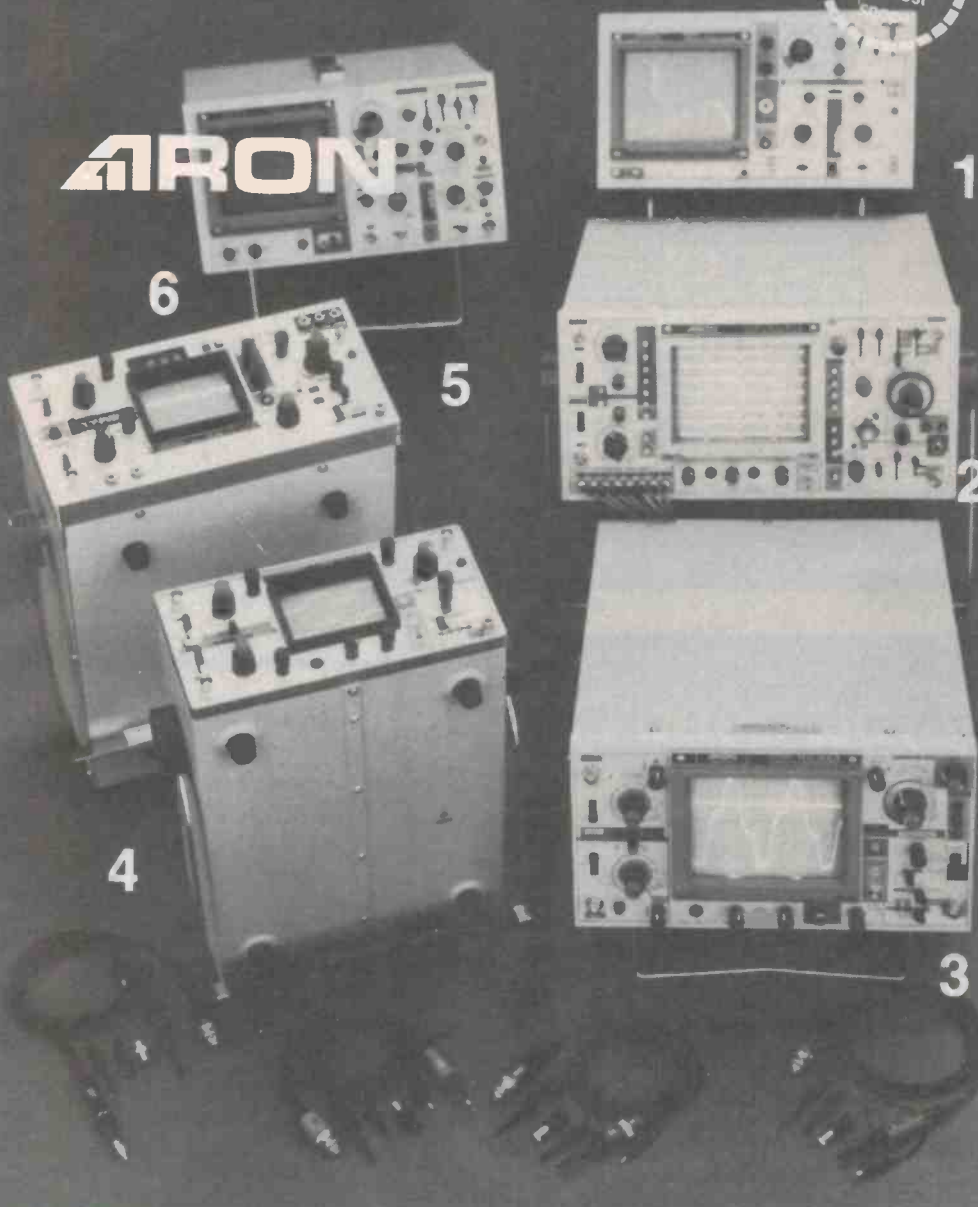

1 BS601 - 20MHz/5mV with Built-in Component Tester

\$535 ex tax
\$620.20 tax paid

- Check components on screen
- 19 range timebase • Triggers to over 30MHz • 17nS risetime

2 BS810 - 100MHz/1mV with 4 Channels and 8 Traces

\$2295 ex tax
\$2708.10 tax paid

- 2nS/div max sweep time
- Alternate time base with B ends A mode • Variable trigger hold-off
- Independent position controls
- Signal delay

3 BS625 - 45MHz/1mV with Signal and Timebase Delay

\$1095 ex tax
\$1270.20 tax paid

- Single sweep • Trigger delay
- 7.7nS risetime • X, Y, Dual, Chop, Add, Subtract etc

4 BS310S - 15MHz/2mV Battery Portable

\$795 ex tax
\$922.20 tax paid

- Ideal for field service use
- 2 hour operation from built-in NiCads • Automatic re-charging
- Auto trigger free run • TV sync

5 BS320 - 15MHz/2mV with Digital Storage and DMM

\$2295 ex tax
\$2708.10 tax paid

- Built-in 3½ digit multimeter
- Digital storage mode • Trigger delay • X-Y mode component tester • 3 channel operation for 3-phase measurements

6 BS635 - 35MHz/1mV with Alternate and Delayed Timebase

\$875 ex tax
\$1015.00 tax paid

- 21 range timebase • 100mS-1uS trigger delay • Front panel trace rotate • Multi-mode display

Optional carrying cases available for all 'scopes.

Coline Probes

A comprehensive range of probes and accessories is available. Modular types have pencil slim heads and detachable earth leads. They offer excellent pulse responses and very wide bandwidths. A comprehensive catalogue is available on request.

SP100 - 100MHz Probe

\$28 ex tax
\$32.20 tax paid

With x1, ref, x10 positions. 1.5m lead, BNC connector and selection of tips in heavy duty pouch.

All prices are plus sales tax if applicable and subject to change without notice.

SOLD & SERVICED IN AUSTRALIA BY

ELMEASCO

Instruments Pty. Ltd.

NEW SOUTH WALES
15 Macdonald Street,
MORTLAKE
P.O. Box 30, CONCORD
NSW 2137
Tel (02) 736 2888
Telex AA25887

VICTORIA
21-23 Anthony Drive,
MT. WAVERLEY
P.O. Box 107, MT. WAVERLEY
VIC 3149
Tel (03) 233 4044
Telex AA36206

QUEENSLAND
243 Milton Road,
MILTON
P.O. Box 2360, BRISBANE
QLD 4001
Tel (07) 369 8688
Telex AA44062

SOUTH AUSTRALIA
99 King William Street,
UNLEY
P.O. Box 1240, ADELAIDE
SA 5001
Tel (08) 271 1839
Telex AA88160

WESTERN AUSTRALIA
P.O. Box 95, GOSNELLS
WA 6110
Tel (08) 398 3362

N.S.W. Ames Agency 699 4524 • George Brown 519 5855, (049) 69 6399 • Davred 267 1385 • DGE Systems (049) 69 1625 • Macelec (042) 29 1455 • Radio Despatch 211 0191 • Sheridan Electronics 699 6912 N.T. Thew & McCann (089) 84 4999 A.C.T. George Brown (062) 80 4355 VIC. Browntronic 419 3986 • G.B. Telespares 328 4301 QLD. Colourview Wholesale 275 3188 • St. Lucia Electronics 52 7466 • Electronic Shop (075) 32 3632 • W.G. Watson (079) 27 1099 • Nortek (077) 79 9600 • ECQ Electronics 376 5677 • Northern Circuits (070) 51 9063 • Fred Hoe & Sons 277 4311 S.A. Redarc Electronics 278 7488 • Trio Electrix 51 6718 • Protronics 212 3111 W.A. Atkins Carlyle 321 0101 T.A.S. GHE Electronics (002) 34 2233 & (003) 31 6533.



TEXTTOOL ZERO INSERTION FORCE SOCKETS



ZIP DIP II Sockets

TEXTTOOL'S versatile ZIP DIP II socket features a flat top plate for easy insertion and extraction. Contacts are on 1" increments for standard sizes, thus mating with standard layouts. All standard sizes from 14 to 40 pin are available from stock at realistic prices.

Pins	Stock Number	Price
14	PB01	9.10
16	PB02	9.74
18	PB03	9.31
20	PB04	9.96
22	PB05	14.10
24	PB06	7.25
28	PB07	7.50
40	PB08	11.95
64	PB28	29.70



ECONO-ZIP Sockets

For applications requiring low cost for not so often used sockets the ECONO-ZIP is the answer. A simple mechanism is used with contacts and body of standard TEXTTOOL materials. Ideal for use on P.C.B.'s within equipment for PROMS or EPROMS. Available immediately in 16, 24, 28 and 40 pin, others to follow.

Pins	Stock Number	Price
16	PB20	6.97
24	PB24	6.83
28	PB25	9.11
40	PB26	11.37
64	PB29	13.50



ZIP-STRIPS

Combine all the usual TEXTTOOL features into a useful socket for testing non-standard packages or pinned board assemblies. The ZIP-STRIP handles may be ganged for ease of use.

Pins	Stock Number	Price
10	PB17	11.30
20	PB18	14.98
32	PB27	17.01

All above prices plus 20% sales tax

Stewart Electronics

44 Stafford St., Huntingdale 3166. Phone: (03) 543 3733 Telex: 369013
437 City Rd., Sth. Melbourne. Phone: (03) 690 8333

Whatever your needs!

FARMING

RECREATION

BUSINESS

EMERGENCY

Sawtron 990

For Superior Communications

Whatever your business you can save time and money and improve your efficiency with a Sawtron 990 UHF CB Radio

I M A R K

167 RODEN STREET, WEST MELBOURNE, VIC. 3003
PHONE: (03) 329 5433. TELEX: AA37753 IMARKO

PTY. LTD.

Ian J. Truscotts

ELECTRONICS WORLD

For all your Electronic needs

- KITS
- COMPONENTS
- TOOLS ETC.

Resellers of Dick Smith, Alltronics

Call in and browse around

Cnr. Bayswater & Eastfield
South Croydon

Phone
723 3860

HIGH SPEED DIVIDERS REACH 3 GHz

Plessey semiconductors of Swindon, southern England, has announced availability of prototype samples of an emitter-coupled logic (ECL) divide-by-four device for operation above 2 GHz.

Known as the SP8712 EXP, it is the first fully production specified divider of its type. Full production will start shortly, the company say.

Operation is guaranteed at input frequencies up to 2.4 GHz, and under ideal conditions a typical device will achieve almost 3 GHz which, say Plessey Semiconductors, represents an improvement in frequency performance of 50 per cent in less than two years and is indicative of major advances in silicon ECL technology.

An important feature of the SP8712 is that it is supplied in a conventional dual-in-line package so that it can be mounted on a printed circuit board, along with accompanying components. It had been thought that DIL packages were unsuitable for operation above 1.5 GHz because of the length of bond wires between the chip and the package leadouts. However, experience gained from manufacture of the SP8612 has shown otherwise.

The design of the SP8712 EXP features a carefully designed chip layout which matches the input stage with the self-induct-

ance of bond wires. This means that the SP8712 EXP can be operated in a conventional manner using conventional board assembly techniques.

Like other Plessey SP8000 series high speed dividers, the SP8712 EXP is guaranteed to operate over a defined temperature, supply voltage, input voltage and frequency range with no compromise in performance.

As well as the applications in professional test and measurement equipment, the SP8712 EXP is ideal for use in direct broadcast satellite (DBS) systems, say Plessey. Present DBS systems used in the USA require a divider to perform at 2 GHz with a typical IF frequency.

The ability to divide at higher frequencies will now allow the user of higher IF frequencies, with a resulting improvement in performances. European systems are planned to operate at even higher frequencies and the introduction of the SP8712 EXP now makes this possible.

For further information contact Plessey Semiconductors Limited, Cheney Manor, Swindon, Wiltshire, England SN2 2QW. Telephone (079)3-6251.

TRW SECOND-SOURCE OPTOCOUPPLERS

TRW Electronics Components Group, Opto-electronics Div, has unveiled alternate sources for the 6N Series of optocouplers. The five-member series is available off the shelf in eight-pin DIPs with temperature compensation over the 0° to 70° Celcius range and 3000 Vdc isolation.

The high speed 6N135 and 6N136 have open-collector outputs for use as line receivers and isolators in applications having data rates of up to one megabit.

The high-gain 6N138 and 6N139 devices are said to provide high sensitivity for EIA RS232C line-receiver and telephone-ring detection.

The ultra-high speed 6N137 device is an optically-coupled logic gate designed for digital-interfacing applications and usable for 10 megabits.

For further information contact Total Electronics, 9 Harker St, Burwood 3125 Vic. (03)288-4044.

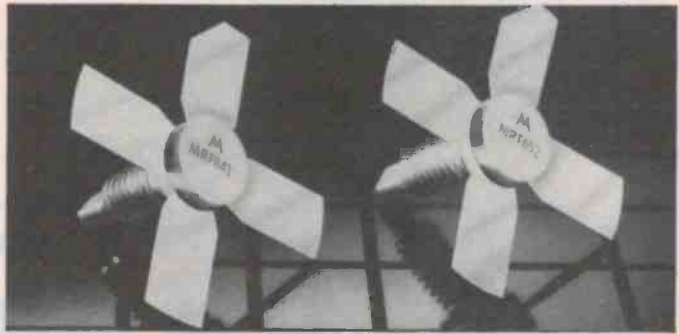

UHF POWER TRANSISTORS

Motorola has announced the new MRF652 and MRF841, cost-effective, high gain UHF and 800 MHz mobile radio RF power transistors.

The devices provide 8.5 to 10 dB minimum gain and 65% typical efficiency specified at 5.0 W output power and 512 or 870 MHz.

These new transistors also feature improved ruggedness, which is 100% tested at high supply, over drive and 30:1 VSWR. Both the MRF652 and MRF841 are designed primarily

for driver and output stages in land mobile and hand held radios operating in the UHF and 800 MHz frequency bands.

These devices provide at least 1 dB more gain than previously existing RF power transistors, thereby significantly reducing the cost of driver stages, claim Motorola.

These devices are available from Motorola Semiconductor Products, 250 Pacific Hwy, Crows Nest NSW 2065. (02)438-1955.

IMPROVED CONVERGENCE FOR 30AX TV SYSTEM

Improved convergence for their 30AX TV tube deflection system is announced by Philips. Convergence improvement over previous data is 10-20% for the three new deflection units, type numbers AT1850 (20"), AT1860 (22") and AT1870 (26").

Several improvements have been made in the deflection units, including a new winding technique, which gives better control of tolerances during production. The 22" coil also now includes field shapers.

Samples of the 22" and 26" deflection units are available now; samples of the 20" unit will be available by the end of the year.

For further information, contact Philips Electronic Components & Materials, 67 Mars Road, Lane Cove NSW 2066. (02) 427-0888.

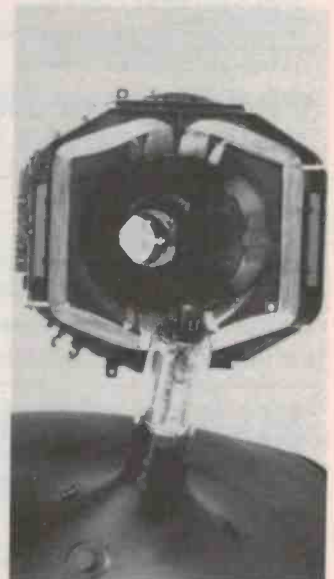

AVTEK MULTI MODEM

SEE EA JAN. 1984

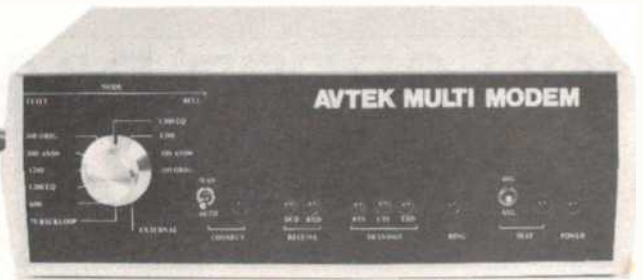
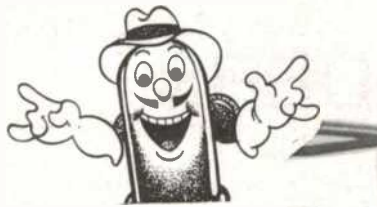

THIS KIT WILL 'KILL' ALL OTHER KITS AVAILABLE IN ITS TOTAL COMMUNICATION WITH THE WORLD... READ ON

Modulation - Frequency shift keying: Digital Interface - RSC-232C: Auto answer and disconnect: Data communication to basic Bell or CCITT specifications giving a world data communications capability: Operates with your normal phone: 300BPS or 1200BPS with backward channel 75BPS: Indicators and test switch: Auto answer or manual connect: Backward channel standard on 1200BPS mode: Direct connection, inbuilt line isolation unit. Operates in the following modes:- Bell 103 originate 300BPS, Bell 103 answer 300BPS, Bell 202 equalised 1200 BPS, Bell 202 1200BPS, CCITT V23 mode 2 equalised 1200BPS, CCITT V21 mode 2 1200BPS, CCITT V21 originate 300BPS and CCITT V21 answer 300BPS.

ONLY \$229

ATTENTION MICROBEE OWNERS MULTIPROM INTERFACE KIT

\$99

The Multiprom board is an extension of the Microbees memory in ROM. It simply plugs into the fifty way bus expansion port on the core board. It fits either neatly inside the Microbee or behind it, using the Microbee's own power supply.

The board takes the EDASM and NET eeprom normally residing inside the Microbee, but allows several different sets to fit in: Editor-Assembler, Wordbee, Logo, MiniPascal, Network ROM, Bemon or your own program. It has room for 4 sets of eeproms in the EDASM location and 3 sets of eeproms in the NET location, a total of 44K of eeprom. The board can be simply daisy chained with up to 6 slave boards (using an outside power supply in this case), allowing a maximum total of 308K in ROM. The EDASM locations accept either type 2532 or 2764 eeproms and they can be mixed. Another powerful feature of the board is the input/output system, 11 outputs, open collector transistor driven. Each can turn ON or OFF a relay under program control. 8 inputs, buffered and protected can read 8 switch status - ideal for computer controlling of model trains, alarm systems, tape recorders, machinery etc.

The Avtek kit includes a plated through board plus all components to make this exciting project. There is also provision on the board to change the address of the ports used for eeprom selection and input/output.



PCB, Tape and Manual Available separately - \$69

SEE ETI NOVEMBER 1983

Little BIG Board

SEE ETI OCTOBER 1983 FOR FULL DETAILS

The Pulsar Series 6000 microcomputer card has been designed to provide a cost-effective general purpose central processor that will find application in a wide range of systems, from stand-alone and dedicated control processors to multi-processing and network configurations. While the 6000 Series is fully compatible with the industry standard STD bus, attention was given to partitioning the circuit so that a complete disc-based computer system could be constructed using just one card. Included on the board is: 280A processor operating at a full 4MHz, 64K bytes dynamic RAM, single/double density floppy disc controller, two RS232C serial I/O ports, 2K bytes EPROM bootstrap/monitor and battery-backed real-time clock and calendar. Interfacing to the STD bus allows systems to include modules from a range of over 1800 cards available from some 80 manufacturers.

Card Includes:

- Power-on automatic bootstrap to CP/M in on-board EPROM
- Real time clock chip with battery backed supply

BUS interface:

- All signals meet STD Bus electrical specs.

External Connections:

- 50 way edge connector provided for 8" floppy disc connections
- 1 x 16 pin RS232C for terminal conn
- 1 x 16 pin RS232C for printer connection

PCB, Manual
and ROM \$149
FULL KIT
\$450

CP/M in 8" or 5 1/4" 1200 or 9600 Baud
(please specify) ONLY \$150

NEW KIT - SERIAL TO PARALLEL CONVERTOR

SEE ETI JANUARY 1984

KIT without Centronics Connector \$29

KIT with pre-crimped Centronics Connector and lead \$59

MULTI ROM BOARDS

XM-1 - This is a totally new product developed EXCLUSIVELY for AVTEK - It takes two sets of EPROMs (e.g. WORDBEE and EDASM) and allows you to choose between them by simple KEYBOARD COMMANDS. It will take a short time to assemble and is simply installed inside the MICROBEE with one DIP plug (supplied) and two solder connections.

Suits early model MICROBEE plus models using 2532 type EPROMs.

These have serial numbers starting with 8.

SAVE \$4.95 - NOW ONLY \$15.00

XM-2 - same as XM-1 but suits the MICROBEE IC and is even simpler to fit. Also responds to PAK1 and PAK2 commands.

These have serial numbers starting with 9.

SAVE \$1.95 - NOW ONLY \$15.00

EPROM PROGRAMMER

See ETI January 1983

Plugs straight into the MICROBEE I/O port. Suitable for 2716, 2732, 2532, 2732A and 2764 EPROMs. Burn your games programmes and eliminate cassette loading time.

FEATURES: ● Sockets for all other IC's ● 1 x 2716 supplied - get started straight away ● Front panel and mains (SEC approved) transformer ● 28 pin and 16 pin wire wrap sockets to flush mount personality plugs (2 included) and ZIF socket (included) ● DB15 plug ● Complete to last nut and bolt ● See review ETI August 1983.

ONLY \$55.00

RADIOTELETYPE DECODER

See ETI April 1983

Display RTTY encoded messages on your video monitor. Receive up to date weather information, international news before the papers and all sorts of military info. Simple circuit, uses PLL techniques. Single PCB construction. Kit includes DB15 plug and backshell for connection to MICROBEE. Shielded pre-tinned PCB.

ONLY \$19.50

MICROBEE LIGHT PEN

See ETI August 1983

AT LAST! A light pen for the BEE. This pen works in the low resolution graphics mode and connects directly from the I/O port. Complete kit including DB15 and 2m cord. Fully documented with software example.

PROVIDES DIRECT PERSONAL CONTACT WITH YOUR BEE!

ONLY \$19.95

FAX DECODER

See ETI September 1983

This project allows you to decode the signals of shortwave stations transmitting radio facsimile weather maps, satellite pictures etc., and then reproduce them on your dot matrix printer. Complete kit of parts includes DB15 and ribbon cable. Software listing.

ONLY \$24.50



AVTEK

(ELECTRONICS) Pty. Ltd.

TWO GREAT LOCATIONS
119 YORK STREET, SYDNEY 2000
PHONE: (02) 267 8777
(Above Charlie Browns Place)
172 LIVERPOOL ROAD (HUME HIGHWAY), ENFIELD
PHONE: (02) 745 2122
All Correspondence to:
P.O. BOX Q302, QUEEN VICTORIA BUILDING,
SYDNEY 2000

POST AND PACKING
Divide the value of your order by 20 (5%) to get post and packing value and then add \$2.00 - it's that simple!
All Bankcard orders can only be sent to a normal address (NOT a P.O. Box). All Bankcard orders will be sent by registered mail (add \$3 to P&P charges)
ENFIELD OPEN ON SUNDAY

DAP PRECISION POTS

Novotechnik KG of Ostfildern, Western Germany, manufacturers of precision potentiometers, are using diallylphthalate (DAP) for base plates in their 'Dino-pot' potentiometers. This high quality plastic is a product of Synres-Almoco BV of the Netherlands.

More than ever before, electronic components demand high reliability and quality. In particular, materials used in high performance process control equipment have to meet rigorous requirements.

Heat resistance and dimensional stability up to temperatures of 180°C combined with excellent resistance to oil and water were essential basic requirements. Further, as the sliding contact is to be capable of 100 million movements, a high degree of wear resistance in the conductive trace is necessary.

As their conductive traces are also based on a diallylphthalate resin system and are chemically bonded to the DAP substrate during the moulding operation, a completely unified system is achieved with a flat, mirror smooth surface.

The electrical insulation performance of DAP meets the highest requirements. More importantly, it retains these excellent properties even under extreme conditions, such as high humidity at elevated temperatures.

In the automotive and transport industries, electronic accelerator pedals and anti-jackknife systems for flexibuses are already being developed. Projects involving stroke adjusting panels for industrial machines and control devices for electronic systems are also underway.

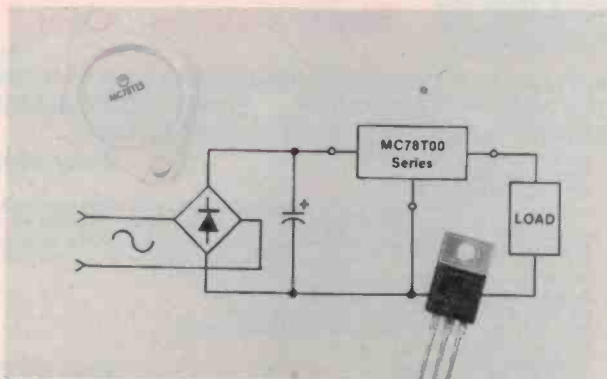
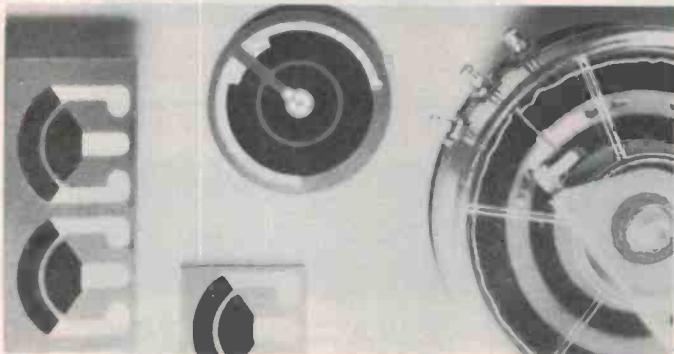

VOLTAGE REGULATORS

Motorola has introduced a family of fixed output, three-terminal voltage regulators with a load driving capability in excess of 3.0 amps.

The Motorola MC78T00 series of devices are available in 5, 6, 8, 12, 15, 18 and 24 volt versions. These devices provide improved load and line regulation over existing industry products and have guaranteed limits for thermal regulation and ripple rejection, Motorola claim.

The Prime Grade (A-Suffix) devices of the MC78T00 series offer even tighter specifications on many of the electrical characteristics, including a 2% output voltage tolerance. For example, the Prime Grade, 5 V devices (MC78T05AC) have a load regulation within 25 mV over the entire load range and line regulation (output voltage variations due to line input voltage

changes) is less than 10 mV.

All of these monolithic devices employ internal current limiting, thermal shutdown, and safe area compensation. Although designed as fixed voltage regulators without external components, these devices can be used with additional components to obtain adjustable voltages and currents. This series of regulators can also be used with a series-pass transistor to boost its standard 3.0 ampere output to 15 amperes.

Devices are offered in standard and A-suffix versions, plastic TO-220 (T-suffix) and metal can TO-3 (K-suffix) packages, and in two temperature ranges. Information can be obtained from Motorola Semiconductor Products, 250 Pacific Hwy, Crows Nest NSW 2065. (02)438-1955.

4 + 1000W MUSICHASER



WRITE OR CALL FOR FURTHER INFORMATION ON OUR EXTENSIVE RANGE OF SOUND AND LIGHTING EQUIPMENT

\$225.00

POST FREE ANYWHERE IN AUSTRALIA

- ☆ SENSITIVITY CONTROL
- ☆ ZERO VOLTAGE TRIGGERING
- ☆ DRIVES NORMAL × INDUCTIVE LOADS
- ☆ 3 CHASE MODES
- ☆ 12 MONTHS WARRANTY



Hi-TECH LIGHT AND SOUND

DISCO SOUND AND LIGHTING SPECIALISTS
63 HARDGRAVE ROAD, WEST END. 4101
POSTAL ADDRESS: P.O. BOX 377, WEST END. QLD. 4101
PHONE: (07) 44-4971



SERIES 5000

PRICES SLASHED

As designed by ETI

INDIVIDUAL COMPONENTS TO MAKE UP A SUPERB HI-FI SYSTEM. BY DIRECTLY IMPORTING AND A MORE TECHNICALLY ORIENTED ORGANISATION BRING THESE PRODUCTS TO YOU AT LOWER PRICES THAN OUR COMPETITORS.

EXTRA FEATURES OF OUR KITS

POWER AMPLIFIER

KIT PRICE \$319 P&P \$12.00

- 1% Metal Film Resistors are used where possible • Prewound Coils are supplied
- Aluminium case as per the original article • All components are top quality • Over 400 Kits now sold • We have built this unit and so know what needs to go into every kit • SUPER FINISH Front panel supplied with every kit at no extra cost to you. • We are so confident of this kit that we can now offer it assembled and tested so that people who do not have the time can appreciate the sound that this amplifier puts out. This is done on a per order basis delivery approx. four weeks after placement.

Only \$449

PREAMPLIFIER

KIT PRICE \$289 P&P \$12.00

- 1% Metal Film Resistors are supplied • 14 metres of Low Capacitance Shielded are supplied (a bit extra in case of mistakes) • English "Lorlin" Switches are supplied no substitutes as others supply • We have built and tested this unit and so

Only \$449

know what needs to go into every kit • Specially imported black anodised aluminium knobs • Again as with the power amp we are offering this kit A & T at a price which we do not believe there is a commercial unit available that sounds as good. Same delivery as the PA.

PREAMPLIFIER Kit Price \$289, P&P \$12.00

SPECIFICATIONS

Frequency response: High-level input: 15Hz-130 kHz, +0, -1 dB Low-level input — conforms to RIAA equalisation, ±0.2 dB
1kHz <0.003% on all inputs (limit of resolution on measuring equipment due to noise limitation).
Distortion: High-level input, master full, with respect to 300 mV input signal at full output (1.2V): >92 dB flat >100 dB A-weighted.
S/N noise: MM input, master full, with respect to full output (1.2V) at 5 mV input, 50 ohm source resistance connected: >86 dB flat >92 dB A-weighted.
MC input, master full, with respect to full output (1.2V) and 200 μV input signal: >71 dB flat >75 dB A-weighted.

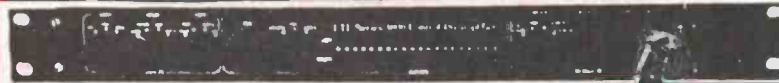

On Special at \$259
Normally \$289

**All parts available separately for both kits.*

POWER AMPLIFIER Kit Price \$319, P&P \$12.00

SPECIFICATIONS 150W RMS into 4ohms

Power output: 100W RMS into 8 ohms (+55 V supply).
Frequency response: 8 Hz to 20 kHz, +0—0.4 dB 2.8Hz to 65 kHz, +0—3 dB. NOTE: These figures are determined solely by passive filters.
Input sensitivity: 1V RMS for 100W output.
Hum: —100dB below full output (flat).
Noise: —116 dB below full output (flat, 20 kHz bandwidth).
2nd harmonic distortion: <0.001% at 1 kHz (0.0007% on prototypes) at 100 W output using a ±56 V supply rated at 4 A continuous. <0.003% at 10 kHz and 100 W.
3rd harmonic distortion: <0.003% for all frequencies less than 10 kHz and all powers below clipping.
Total harmonic distortion: Determined by 2nd harmonic distortion (see above).
Intermodulation distortion: <0.003% at 100 W. (50 Hz and 7 kHz mixed 4:1).
Stability: Unconditional

Please note that the "Superb Quality" Heatsink for the power amp was designed and developed by Rod Irving Electronics and is being supplied to other kit suppliers. This product cost \$1,200 to develop so that your amplifier kit would have a professional finish as well as sound.



On Special at \$299
Normally \$319

MX-1200 MICROPHONE/AUDIO MIXER



MX 1200 \$79900 this month only

This unit features: 12 microphone line inputs with pan, bass, treble, effect and fold back controls for each channel • LED peak indicators for each channel • 2 turntable inputs with cross-fade and individual output controls • master equaliser for bass, midrange and treble • variable headphone output etc. etc. • complete with carrying case.

\$79900

SPECIFICATIONS
INPUTS
Level impedance Mic .46 db/1K
Line 22 db/16K x 12
Phono .52 db/50K STEREO + 2 (2mv) at 18KHz
Effect Return (Aux) 20 db/50K + 1
OUTPUTS
Level impedance L & R 0 db/2K
Effect Send 0 db/2K F/B Out 0 db/2K
Head phone Stereo +10 db/500 (100 .1K)
EQUALISATION
Channel
Bass +15db
Treble +15db
Master
Bass +12db
Treble +10db
Middle +12db

FADER & CONTROLLERS
12 channel fader, Slider 60mm; LOG 25%
2 Master fader, Slider 60mm; LOG 15%
1 F/B Master level, 300 LIN
12 Effect Send, 300 LIN
1 Effect Return, 300 LOG 15%
2 Phono, 300 LOG 15%
1 Head Phone, 300 LOG 15%
S/N: 58dB
FREQUENCY RESPONSE: 20.20 KHz
TOTAL HARMONIC DISTORTION: Less than 0.1%
METER: 2 illuminated VU Meters 0db = 0.775V
PEAK INDICATOR: 12 LED Peak Indicators
VOLTAGE: 240 VAC 50Hz
POWER CONSUMPTION: 7.2 watts
DIMENSIONS: 620 (W) x 365 (D) x 108 (H) mm
(supplied complete with carrying case)

THIRD OCTAVE GRAPHIC EQUALIZER



SPECIFICATIONS E.T.I. Dec. 1982

Bands: 28 Bands from 31.5 Hz to 16 kHz
Noise: <0.008 mV, sliders at 0, gain at 0 (-102 dB),
20 kHz bandwidth
Distortion: 0.007% at 300 mV signal, sliders at 0, gain at 0, max. 0.01%, sliders at minimum.
Frequency Response: 12 Hz-105 kHz, +0, -1 dB, all controls flat.
Boost & Cut: 14 dB

\$19500 1 Unit
\$37900 2 Units

SERIES 4000 SPEAKERS.

- 8 speakers with crossovers \$499
- Speaker boxes (assembled with grill and speaker cutout) ... \$299
- Crossover kits \$199
- Complete kit of parts (speakers, crossovers, screws, inner-band boxes) \$799
- Assembled, tested, ready to be hooked up to your system ... \$849



WE BELIEVE THAT WE ARE NOW THE ONLY ONE TO SUPPLY COMPLETE SPEAKER KITS ASSEMBLED AND TESTED FOR THOSE WHO HAVEN'T GOT TIME \$849 EX STOCK.

PLEASE WRITE FOR CONSTRUCTION NOTES, THESE COMPLIMENT THE SERIES 5000 AMP RANGE AND ADD THE FINAL TOUCH.

ROD IRVING ELECTRONICS

425 High St., Northcote, Vic. 48-50 A'Beckett St., Melb., Vic.
Phone (03) 489 8866, (03) 489 8131, Mail Order Hotline (03) 481 1436
Mail orders to P.O. Box 235 Northcote 3070 Vic.
Minimum P & P \$3.00. Errors & omissions excepted.

Please address tax exempt, school, wholesale, and dealer enquiries to:
RITRONICS WHOLESALE
1st floor 425 High St. Northcote 3070 (03) 489 7099 (03) 481 1923
Telex AA 38897

ETI Book Sales

electronics textbooks

ESSENTIAL THEORY FOR THE ELECTRONICS HOBBYIST

A0013B \$5.95
Supplies the electronics hobbyist with the background knowledge which will exactly suit his specific requirements. Minimum maths.

INTRODUCTION TO AUTOMOTIVE SOLID-STATE ELECTRONICS

A0015P \$14.95
For the professional as well as the home mechanic — explains the functions of most on-board automotive black boxes and logic systems, including anti-skid braking, electronic spark control and diagnostic systems.

ELECTRONICS: IT'S EASY — VOL 1

A0016E \$12.95
Meters, resistance, capacitance and inductance, emitter followers, op-amps, power supplies and electronic filters. Hardcover.

ELECTRONICS: IT'S EASY — VOL 2

A0017E \$12.95
Digital sub-systems, counters and shift registers, A-D and D-A conversion, digital instruments and test equipment, computers, transmission links and oscilloscopes. Hardcover.

reference and data handbooks

FIRST BOOK OF TRANSISTOR EQUIVALENTS AND SUBSTITUTES

B0025B \$5.95
This guide covers many thousands of transistors showing possible alternatives and equivalents. Covers transistors made in Britain, Japan, United States, Europe and Hong Kong, and includes types produced by more than 120 different manufacturers.

SECOND BOOK OF TRANSISTOR EQUIVALENTS AND SUBSTITUTES

B0026B \$6.25
Interchangeability data covers semi-conductors manufactured all over the world. Immediate equivalents are shown and possible substitutes are included.

PRACTICAL ELECTRONIC CALCULATIONS AND FORMULAE

B0027B \$9.95
For the practical person's workbench. Bridges the gap between technical theory and cut-and-dried methods which work but leave the experimenter unfulfilled. There's a strong practical bias. High maths avoided where possible.

HANDBOOK OF ELECTRONIC TABLES AND FORMULAE

B0320P \$19.95
Covers formulas and laws, constants and standards, symbols and codes, service and installation data, design data and mathematics. Fifth edition.

electronics for beginners

HOW TO BUILD ELECTRONIC GAMES

C0032E \$3.95
Alien invaders, electronic die, sound effects, two-slot car controllers, electronic poker machine and lots more.

HOW TO BUILD GOLD AND TREASURE DETECTORS

C0033E \$3.95
Tells you how metal detectors work and how to construct the different types of detectors: discriminating, BFO, induction balance and a professional deep-seeking unit.

ELECTRONIC GAMES

C0040B \$5.95
How to build many interesting electronic games using modern ICs. Covers both simple and complex circuits for beginner and advanced builder alike.

SOLID-STATE SHORTWAVE RECEIVERS FOR BEGINNERS

C0044B \$5.95
Design and construction of several solid-state shortwave receivers giving high level of performance yet utilising few components.

constructional projects

POWER-SUPPLY PROJECTS

D0047B \$5.95
Gives a number of power-supply designs, including simple unregulated types, fixed-voltage regulated type and variable voltage stabilised designs. The designs are all low-voltage types for semiconductor-circuits.

ELECTRONIC PROJECTS USING SOLAR CELLS

D0049B \$6.75
Includes a number of projects that benefit from solar power and obviate the problems encountered with batteries, such as weight and bulk, frequency of replacement, and failure when batteries are exhausted.

BUILD YOUR OWN HI-FI AND AUDIO ACCESSORIES

D0052B \$4.95
Essential for keen hi-fi and audio enthusiasts. Projects include stereo decoder, three-channel mixer, FET preamp for ceramic pick-ups, mic preamp with adj. bass, stereo dynamic noise limiter, loudspeaker protector, etc.

28 TESTED TRANSISTOR PROJECTS

D0053B \$4.50
Some circuits are new, others are familiar designs. Projects can be split and/or combined.

PROJECTS IN DPTO-ELECTRONICS

D0057B \$6.75
Included are simple circuits using ordinary LEDs as well as more sophisticated designs such as Infra-red transmitters and detectors, modulated light transmission and also photographic projects, etc.

SECURITY SYSTEMS

D0294P \$14.95
Step-by-step instructions show you how to carry out a security survey of your home and then plan, install and maintain an alarm system.

BUILD YOUR OWN ELECTRONIC EXPERIMENTER'S LABORATORY USING ICs

D0384B \$2.75
Projects include a simple audio frequency oscillator, a TTL pulse detector, a simple square wave generator and a high impedance voltmeter. Limited supplies.

circuit techniques and design

PRACTICAL TRANSFORMER DESIGN HANDBOOK

E0075P \$38.95
An easy to understand, illustration-filled guide to designing and constructing transformers. Reviews the fundamentals of electricity, magnetism and algebra needed to understand transformer theory, and covers general design considerations, transformer types, power losses and transformer use in converters and inverters.

TTL COOKBOOK

E0083P \$20.50
A complete look at TTL logic circuits — what TTL is, how it works, and how to use it. Many kinds of practical TTL are included, such as digital counters, electronic stopwatches, digital voltmeters, etc.

PRACTICAL SOLID-STATE CIRCUIT DESIGN

E0094P \$16.95
An introductory course in practical solid-state circuit design for the experimenter, designer or technician who is interested in constructing tailor-made circuits.

50 CIRCUITS USING 7400 SERIES ICs

E0111B \$5.95
Fifty interesting and useful circuits and applications using these versatile devices.

test equipment and fault-finding

USE OF THE OSCILLOSCOPE

F0117P \$27.95
Programmed instruction course for use in a basic electrical engineering laboratory course. Author assumes basic knowledge of DC and AC circuits but none of oscilloscopes. This is an essentially practical course — thoroughly recommended.

USE OF THE DUAL-TRACE OSCILLOSCOPE

F0259P \$30.25
This programmed text breaks down the process of operating a scope into a series of logical steps, starting with the deflection of the electron beam and continuing through proper use of the triggering controls to measure the phase difference between two waveforms.

Save time and trouble with mail order — simply fill out the reply-paid coupon!

140 Joynton Avenue, Waterloo, NSW 2017, Australia. Phone (02) 663-9999 Sydney. Telex 74488.

Postal Address: ETI Book Sales, PO Box 227, Waterloo, NSW 2017.

computer hardware and techniques

COMPUTERS AND COMPUTING YEARBOOK '83

J0014E \$4.95
Includes ZX81, Epson MX80 printer, System 80 joystick project, 660 software, ZX80 programs, etc, etc.

COMPUTERS AND COMPUTING YEARBOOK '82
J0155E \$4.95
Includes disks, CP/M and your computer, learners microcomputer, programming in CHIP-8, alphasort, fast plotter, PET talk, System 80.

INTERFACE PROJECTS FOR THE APPLE II
J0158P \$17.95
A series of interface projects that are easily built and enable the user to realise the computer's potential through project construction. Projects are primarily hardware-orientated, with some software supporting the hardware.

THE S100 AND OTHER MICRO BUSES
J0160P \$14.50
The key to successful computer expansion is a complete understanding of the bus system, through which the computer communicates with peripherals. This book will give you that understanding.

MICROCOMPUTER DESIGN AND TROUBLESHOOTING
J0161P \$26.75
Tells you how to design microcomputer systems and make them work without an expensive commercial development system or the need for costly test instrumentation. Includes a complete description of two microprocessors — the 8085 and the 6502.

A STEP-BY-STEP INTRODUCTION TO 8080 MICROPROCESSOR SYSTEMS
J0165A \$16.95
Doesn't require any electronics or computer background. This book describes the 8080 architecture and Instruction set through simple examples. Some basic software is introduced.

computing software

32 BASIC PROGRAMS FOR THE APPLE COMPUTER
K0218A \$29.50
Full of programs with practical applications, educational uses, games and graphics.

PET/CBM BASIC
K0219P \$19.25
Provides a thorough introduction to BASIC programming on a Commodore PET computer, explaining programming concepts for graphics, including three-dimensional letters, bar graphs and the use of sound effects.

PET GAMES AND RECREATIONS
K0221P \$18.85
Presenting an interesting mixture of diversions guaranteed to entertain and educate. Ideal for beginners, yet also challenging to computer veterans, the book features progressive levels of difficulty.

32 BASIC PROGRAMS FOR THE PET COMPUTER
K0222A \$29.50
Each chapter fully documents a different bug-free program. If readers have a good working knowledge of BASIC, they can devise their own program changes.

EXPLORE COMPUTING WITH THE TRS-80 (AND COMMONSENSE)
K0225P \$17.95
This introduction to microcomputers and the BASIC language is suitable for novices and users of the TRS-80. Among the topics covered are creating tables, arts and graphics, games and simulation.

PROGRAMMING THE Z8000
K0232A \$25.95
A complete introduction to programming concepts and techniques for use with the 16-bit, Z8000 microprocessor. Presents detailed descriptions of the architecture and functions of this 'super chip'.

BASIC: FUNDAMENTAL CONCEPTS
K0314P \$29.75
Contains many practical example programs, including compound interest and amortisation, a collection letter and a plot program for graphing data. Programs are listed in two dialects, DEC-BASIC II and MicroSoft BASIC.

8080, 8085 SOFTWARE DESIGN — BOOK 1
K0352P \$17.75
The 190 executable program examples can be run on just about any 8080-based microcomputer. Detailed explanations of how the program examples operate are also provided.

8080, 8085 SOFTWARE DESIGN — BOOK 2
K0353P \$18.95
Includes asynchronous serial communications, interrupts and their applications, data structures, searching, sorting, command decoders and debuggers. More than 90 program examples.

PASCAL PRIMER
K0357P \$23.95
Includes popular USCD Pascal, tear-out reference card, machine-language interfacing, progress quizzes and graduated examples.

32 BASIC GAMES FOR THE EXIDY SORCERER
K0365A \$23.25
Full of programs with practical applications, educational uses, games and graphics. Each chapter documents a different bug-free program. Limited supplies.

PROGRAMMING WITH ADA
K0368P \$26.95
An introduction by means of graduated examples, including an overview of Ada, basic language features, data description, modularity and program structure and multi-tasking.

THE C PUZZLE BOOK
K0375P \$23.00
Includes C programs that each explore a particular aspect of C, detailed descriptions of how the programs work and tips on writing successful C programs.

LEARNING LOGO ON THE APPLE II
K0378P \$12.50
An introduction to the Logo language. Includes starting up the turtle, editing and debugging procedures, secret codes and recursion.

AN END-USER'S GUIDE TO DATA-BASE
K0401P \$42.95
An introduction to data-base, including productivity and flexibility, data modelling, design tools, data-base languages for end-users and separate end-user systems. A James Martin book.

computing for business

BASIC FOR ACCOUNTANTS
L0234P \$11.95
Shows accountancy students and accountants how to use a computer to perform the repetitive tasks associated with record keeping, calculating and report writing. Using the BASIC language attention is concentrated on debtors, inventory and general ledger systems.

SMALL COMPUTERS FOR THE SMALL BUSINESSMAN
L0240A \$27.95
How and where to shop for a computer successfully; what to expect their computer to do for them; how to select software; whether or not to use a consultant; how to introduce the computer to the staff and how much computer is necessary.

BASIC BUSINESS SOFTWARE
L0242P \$18.45
A basic insight into how business software is designed. Aimed at the small-business operator.

MICROCOMPUTERS IN LARGE ORGANIZATIONS
L0389P \$16.75
A guide to the planned implementation of microcomputers in government, industrial and educational distributed data-processing organisations.

SMALL-BUSINESS COMPUTERS: A GUIDE TO EVALUATION AND SELECTION
L0397P \$39.95
A guide for business and home computer buyers. Includes advice on various systems and how to ensure successful installation.

THE VISICALC BOOK — ATARI EDITION
L0398P \$18.95
An invaluable aid for those using VisiCalc on the Atari. How to enter data, solve problems about profit/loss projections, pricing costing estimates, etc.

electronic calculators

ELECTRONIC CALCULATOR USER'S HANDBOOK
M0245B \$5.50
Presents formulae, data, methods of calculation, conversion factors, etc. for use with the simplest of most sophisticated calculators. Includes the way to calculate using only a simple four-function calculator, trigonometric function, hyperbolic functions, logarithms, square roots and powers.

YOUR ELECTRONIC CALCULATOR AND YOUR MONEY
M0246B \$4.75
Starts with a basic revision of percentages and decimals, then deals with mortgages, cars, insurance, fuel, shopping, tax, etc. There's a section on investment and one on the calculator in a small business.

TAKE A CHANCE WITH YOUR CALCULATOR
M0248A \$14.95
An introduction to modern mathematics, this book deals with programming of programmable calculators and includes probability problems. Limited supplies.

FUN AND GAMES WITH YOUR ELECTRONIC CALCULATOR
M0370B \$2.50
A collection of 101 jokes and riddles, several mind-boggling games for two or more players, and a dictionary of words with their corresponding numbers.

amateur radio, dx communications

TELEMATIC SOCIETY
N0254P \$20.00
Demonstrates how developments in telecommunications will affect the way we live.

FIBER OPTICS
N0295P \$31.75
Gives the electronics technician a practical foundation for the challenge of fibre optics. No prior knowledge of optics is necessary.

FIBER OPTICS: COMMUNICATIONS, EXPERIMENTS AND PROJECTS
N0296P \$24.35
An Introduction to fibre optics for the hobbyist, student, experimenter, computer buff, radio amateur, technician or engineer.

HOW TO BUILD ADVANCED SHORTWAVE RECEIVERS
N0340B \$6.95
Contains full practical construction details of a number of receivers.

ANTENNA ANTHOLOGY
N0364R \$5.75
Theoretical explanation and complete instructions for building different types of antennas for amateur work.

All prices of publications in this catalogue listing are subject to change without notice.

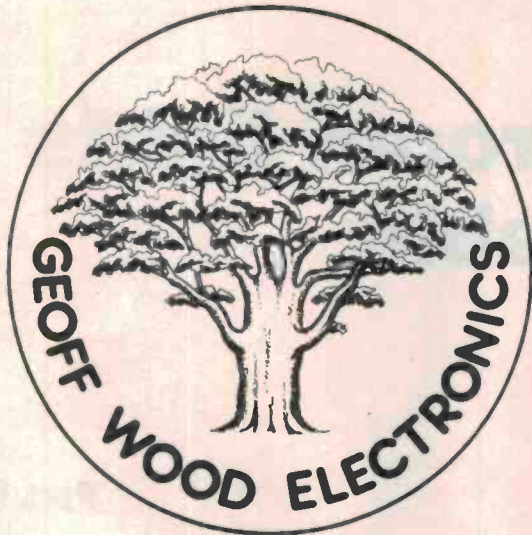

Geoff Wood is well known on the retail electronics scene in Sydney. Now he's opened his own store in a brand new location and he's stocking the broadest range of prime quality National Semiconductor product ever stocked at a retail level in Sydney.

The specials listed will be available only while stocks last - so get your orders in early. Many other specials for personal shoppers only.

GEOFF WOOD ELECTRONICS PTY LTD

Incorporated in N.S.W.
656A Darling St, Rozelle 2039
(One door from National Street)
Tel: 810 6845

8.30 to 5 Monday to Friday, 8.30 to 12 Sat.
Mail Orders add \$3.00 to cover postal charges.
Next day delivery in Sydney add \$5.00.
All prices INCLUDE sales tax.
Tax exemption certificates accepted if line value exceeds \$10.00.



LINEAR DEVICES

LM349N 0.95
WIDE BAND DUAL QUAD 741 OP AMP

LM309K 1.80
5V TO-3 REGULATOR

LM338K 8.80
5A ADJUSTABLE REGULATOR TO-3

LM381N 1.45
LOW NOISE DUAL PREAMPLIFIER

LM386N-1 0.55
LOW VOLTAGE AUDIO AMPLIFIER

LM565CN 0.95
EVER POPULAR PHASE LOCK LOOP

LM723CN 0.45
14 PIN DIL ADJUST VOLTAGE REGULATOR

UA741HC 0.95
METAL CAN VERSION

UA741PC 0.35
MOST POPULAR OF AMP EVER MADE

LM7805CT 0.75
TO-220 5 VOLT POSITIVE REGULATOR

LM7812CT 0.75
TO-220 12 VOLT POSITIVE REGULATOR

LM7815CT 0.75
TO-220 15 VOLT POSITIVE REGULATOR

LM7905CT 0.85
TO-220 5 VOLT NEGATIVE REGULATOR

LM7912CT 0.85
TO-220 12 VOLT NEGATIVE REGULATOR

LM7915CT 0.85
TO-220 15 VOLT NEGATIVE REGULATOR

LM78L05ACZ 0.35
TO-92 5 VOLT NEGATIVE REGULATOR

LM78L12ACZ 0.35
TO-92 12 VOLT POSITIVE REGULATOR

LM78L15ACZ 0.35
TO-92 15 VOLT POSITIVE REGULATOR

LM79L05ACZ 0.70
TO-92 5 VOLT NEGATIVE REGULATOR

LM79L12ACZ 0.70
TO-92 12 VOLT NEGATIVE REGULATOR

LM79L15ACZ 0.70
TO-92 15 VOLT NEGATIVE REGULATOR

RC4195 0.50
PLUS/MINUS 15V AT 100mA, TO66 PKG

CAPACITOR SCOOP
SIEMANS 10.00/C
.047 250 VOLT

74LS HARD TO GET?
NOT AT GEOFF WOOD ELECTRONICS AT
PRESENT. GET YOURS TODAY.

CMOS

CD4007C 0.40
DUAL COMPLEMENTARY PAIR PLUS INV.

CD4008C 0.85
4 BIT FULL ADDER

CD4015C 0.75
DUAL 4 BIT STATIC REGISTER

CD4028B 0.85
BCD-DECIMAL DECODER

CD4050B 0.45
HEX NON INVERTING BUFFER

CD4069 0.35
HEX INVERTER

CD4070 0.35
QUAD 2 INPUT EXCLUSIVE OR

CD4160B 0.95
DECADE COUNTER, ASYNCHRONOUS CLEAR

CD4175B 0.95
QUAD D FLIP FLOP

CD4584B 0.85
HEX SCHMITT TRIGGER

CD4724B 0.85
8 BIT ADDRESSABLE LATCH

MM74C04 0.35
HEX INVERTER

MM74C86 0.35
QUAD 2 INPUT EXCLUSIVE OR

MM74C150 3.80
16 TO 1 MULTIPLEXER

MM74C160 0.95
DECADE COUNTER, ASYNCHRONOUS CLEAR

MM74C162 0.95
DECADE COUNTER, SYNCHRONOUS CLEAR

MM74C175 0.95
QUAD D FLIP FLOP

MM80C97 0.70
THREE STATE HEX BUFFER

INTERFACE PARTS

DS1488 0.92
MOST COMMON RS232C LINE DRIVER.

DS1489 0.92
QUITE USEFUL WITH DS1488.

SUPER REG

LM396K 20.99
10 AMP ADJUSTABLE REGULATOR WE NOW
HAVE LIMITED QUANTITIES IN STOCK.

PM001 32.50
9V 10AMP TRANSFORMER TO SUIT 396
IDEAL FOR 5V SUPPLY.

MICROPROCESSORS

8085A 12.68
THEY TELL US SOME COMPUTER MGS
HAVE BOUGHT UP WORLD PRODUCTION
FOR THE NEXT FEW MONTHS. THEY AINT
GOT OURS.

SOCKETS

100-S 3.95
TRUE 8100 BUS EDGE CONNECTOR FITS
MOTHER BOARD WITHOUT MODIFICATION.

AXR-3-11 3.95
FEMALE

AXR-3-12 2.05
MALE

AXR-3-31 4.40
FEMALE

AXR-3-32 2.40
MALE

AXR-LNE-11 6.25
FEMALE

AXR-LNE-12 6.10
MALE

AXR-LNE-31 6.25
FEMALE

AXR-LNE-32 3.45
MALE

DB25P 2.35
D TYPE PLUS SOLDER

DB25S 3.45
D TYPE SOCKET SOLDER

MEMORY

MM2114N 1.95
1024 X 4 RAM

MM2114N-055 0.95
1024 X 4 RAM 0-95 DEG C

MM2716Q-1 10.49
POPULAR 350ms UV PROM

LOGIC WINNERS

DM7406N 1.20
30V INVERTER ALMOST IMPOSSIBLE
TO GET.

DM7407N 1.20
LIMITED QUANTITIES ONLY BE QUICK

DM7438N 1.20
QUAD BUFFER-A BEAUTY

LITTLE TRIMMERS

3326H-1 0.30
BOURNS SINGLE TURN SK TRIMMER
LIMITED QUANTITIES ONLY

NATIONAL SEMICONDUCTOR DATA BOOKS

AUDIO/RADIO 9.25
CONTAINS HEALTH OF INFORMATION ON
PREAMPS, AM/FM/STEREO, POWER AMPS AND
FLOOBYDUST.

ADV. LOGIC 9.25
COVERS ADVANCED LOGIC FAMILIES
(74ALS AND 74AS).

CMOS 10.95
CONTAINS DETAILS ON 74C AND CD4000
SERIES. INCLUDES SPECIAL FUNCTION
LOGIC, MEMORY AND APPLICATION NOTES.

INTERFACE 83 17.00
NEW NEW NEW NEW NEW NEW NEW NEW
CONTAINS LINE DRIVERS/RECEIVERS-PALS-
DISPLAY DRIVERS-BIT SLICE-BIPOLAR
MEMORY AND MUCH MORE.

LIN APPLIC 17.00
SORRY SOLD OUT

LINEAR DATA 2 VOLTS PER PAIR 20.00
THE FINEST COLLECTION OF DATA AND
TYPICAL APPLICATIONS ON OP AMPS, REGG
COMPARATORS, REFERENCES, INSTRUMENT
AMPS, ANALOG SWITCHES, SAMPLE & HOLD,
BUFFERS, SPECIAL FUNCTION, AUDIO AND
SPEECH DEVICES EVER PUBLISHED.

LOGIC 9.95
COVERS 7400, 741, 74M, 74LS, 74S PLUS A
WIDE RANGE OF PROPRIETARY PARTS.

TRANSISTOR 7.00
WHO NEEDS TRANSISTORS? APPARENTLY
EVERYONE. THIS BOOK INCLUDES 2N, PN,
MU, TIP, FETS ALL IN ONE HANDY VOLUME.

VOLT REGUL. 9.25
NOT REALLY A DATA BOOK, MORE A DESIGN
TEXT ON POWER SUPPLY CONSIDERATIONS,
HEAT-SINKING AND POWER DISSIPATION.

AD/DA

ADD3501 12.00
3 3/4 DIGIT DVM LED OUTPUT

DAC0808 2.25
8 BIT D TO A

HIGH POWER SPECIALS

NEC701 POA
600 VOLT, 500 AMP DIODE

BTY99-600R 50.00
600 VOLT, 100 AMP SCR

OPTO

MA1026ALR 27.00
TIME/TEMPERATURE MODULE

DL1416 36.00
4 DIGIT ALPHA NUMERIC DISPLAY MODULE
WITH INBUILT DECODER/DRIVER.

NSM39152 9.95
10 SEGMENT BARGRAPH MODULE ALL GREEN
WITH INBUILT LOGARITHMIC DRIVER.

NSL4855 0.15
RED 5 MM

NSL4955 0.20
GREEN 5 MM

NSL5086 0.15
RED 3 MM

TIL313 1.50
0.3" COMMON ANODE WITH RIGHT HAND
DECIMAL POINT.

RED BEZEL 1.95
4 DIGIT 0.5" BEZEL WITH INTEGRAL
BLACK SURROUND.

OTHER BEZELS ALSO
AVAILABLE PLEASE
ASK.

DISCRETE

PK40F 2.50
400V 12AMP BRIDGE

1N914 0.05
OLD OLD FAVOURITE SIGNAL DIODE

2N2222A 0.48
NPN GENERAL PURPOSE TO-18

2N2904 0.40
PNP GENERAL PURPOSE TO-18

2N3019 0.69
NPN MEDIUM POWER TO-3

2N3053 0.64
NPN MEDIUM POWER TO-3

2N4032 0.64
NPN MEDIUM POWER TO-5

2N4360 0.60
VERY POPULAR FET

2N5485 0.70
NFET/RF TO-92

2N5656 0.92
NPN POWER TO-126

2N6707 0.49
NPN MEDIUM POWER TO-92 PLUS

PN3563 0.18
NPN LAF TO-92

PN3643 0.18
NPN MEDIUM POWER TO-92

TIP3055 1.20
NPN POWER TO-220

specialising in electronic components for the professional and hobbyist.

Control up to four room lights over a twin-wire cable

Ian Thomas

Part 1

It is probably a not-uncommon problem to want to replace the single ceiling light in a room with a more exotic dimmable arrangement only to find that the twin-wire switch cable is concreted in, or otherwise hard to get at without spoiling the room decoration. This project allows you to control up to four room lights — two dimmable and two switched — over the existing twin-wire cable. No need to spoil the wall and ruin the room decor.

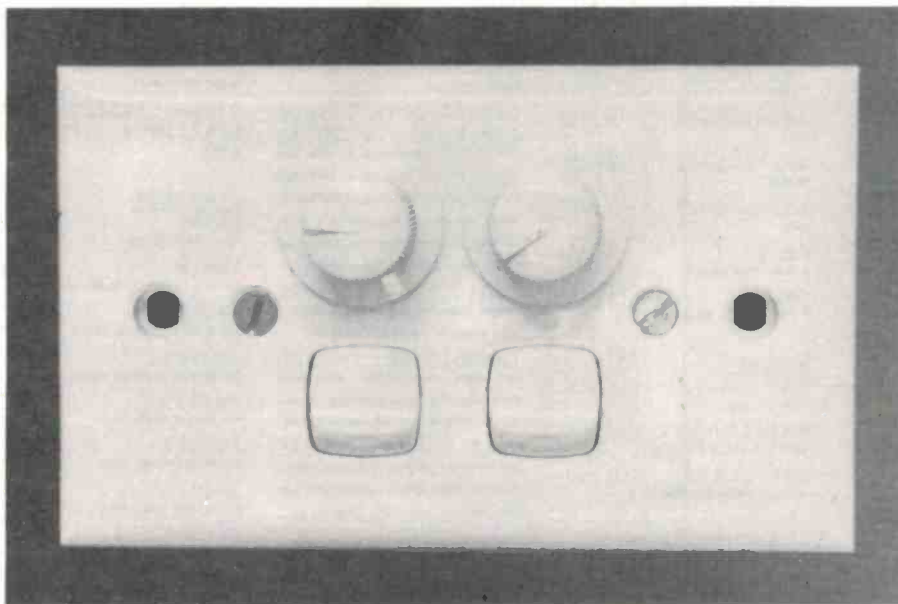

The controls. I modified a standard, commonly available, HPM light fitting (made in Australia) to take the controls. This provided a neat and convenient solution, the switches and dimmer pots snap into the panel, the encoder pc board mounts behind them. The end result is only distinguishable from an 'ordinary' light fitting by the two pc board mounting screws visible here (which should be earthed or covered). If the pc mountings are epoxied in place — who'd know the difference?

IT IS PROBABLY a not uncommon problem to want to replace the single overhead light fitting with a more exotic dimmable arrangement only to find that the control wires to the switch are *concreted in*. Also, in keeping with Murphy's Law, the walls have only been re-papered a year or so ago and the wallpaper is now totally unavailable and to string more wires to the switch would involve a major redecoration of the whole room, so the idea is scrapped.

This project is intended to solve such problems by replacing the single wall switch with the required multiple switch-control pot combination and a very compact printed circuit board. A matching electronics box in the ceiling feeds power to the control board and also recovers the control information to operate triacs to drive the multiple lights.

It was considered essential that the replaced wall controls look exactly like normal 'bought' controls and avoid that 'home made' look so, normal, purchased, wall fittings were used for the controller. The unit in the ceiling merely had to work reliably and could be any size or shape at all.

The design

The first problem to be dealt with in the design was how many controls and what type were wanted. Also, it had to be decided how to multiplex the switch/control pot information onto the single wire pair available. A survey of the many types of controller integrated circuits available (what we were trying to do is not dissimilar to the remote control of a TV or VCR) showed that while there were dozens (literally!) manufactured, precisely none (zip! zero! zilch!) were to be had in Australia unless you wanted to buy 1000 or so.

The only ray of light to be found was from National Semiconductor, and a perfectly satisfactory ray it turned out to be too. National make the LM1871 Radio Control Encoder/Transmitter and its companion LM1872 Radio Control Receiver/Decoder, which are intended to be used as remote controllers for toy cars or model aeroplanes. They provide, in their simplest configuration, two linear analogue control

room lights controller

channels plus two separate on-off channels. The encoder/transmitter also contains a moderate power high- f_T transistor to be used as an RF transmitter and the receiver/decoder has all the circuitry to construct a (simple) RF receiver so, as I could actually go out and buy some over the counter (good marketing National!) this integrated circuit pair seemed to be the way to go. They would give two completely linear, dimmable lights plus two simple on-off lights which should cover most rooms adequately.

The LM1871/LM1872 integrated circuits operate on a rather peculiar combination of pulse-width modulation plus (once again in their simplest configuration) pulse counting to transmit the analogue and digital information. The receiver/decoder half of the pair contains no memory so the encoder/transmitter must send the information continuously to keep the system 'alive'.

The encoder section of the LM1871 generates a series of up to six pulses in each data frame with each pulse separated by a fixed off time. At the end of the up-to-six pulses a much longer synchronisation pulse is sent so the receiver/decoder can lock on correctly. The first two pulses in each data frame are of variable width to convey the analogue information of the two channels and the other, up-to-four, fixed width pulses give the status of the two on-off switches. Figure 1 shows a typical encoder output and indicates how the width of the first two pulses gives the analogue data.

As Figure 1 shows, the analogue information is contained in pulses repeated at the frame rate whose width varies. The values recommended by National give a frame rate of 50 Hz. However, as the analogue information derived from this repetition rate data is to be used to control triacs running from 50 Hz mains the two similar frequencies would be sure to give rise to all sorts of unwanted slow beat effects (you would be amazed how sensitive the eye is to slow beats in, say, light intensity). For this reason I opted to have a frame rate of 75 Hz so any beats would be at 25 Hz and thus unnoticeable.

Also, the National design data is based on bandwidth restrictions and no such restraints exist for us. I also opted to shorten the fixed off time between all pulses to 0.4 ms from the National-recommended 0.5. The analogue channel limits were left the same as in the recommendations at 1 ms minimum and 2 ms maximum. The digital information pulses were left at 0.5 ms to finish defining all the times in the frame sent from the encoder.

The LM1871 is intended to be used as a very low power 27 MHz or 46 MHz (or, by straining and a bit of extra circuitry, 72 MHz) radio transmitter. This seemed like a good idea except that I had no desire to further crud up the ether with lighting control information. Instead, I chose to use the wires carrying power to the controller to carry switched low frequency RF data in the

The works! This is the receiver and triac driver board which mounts away in the ceiling cavity, or somewhere else.

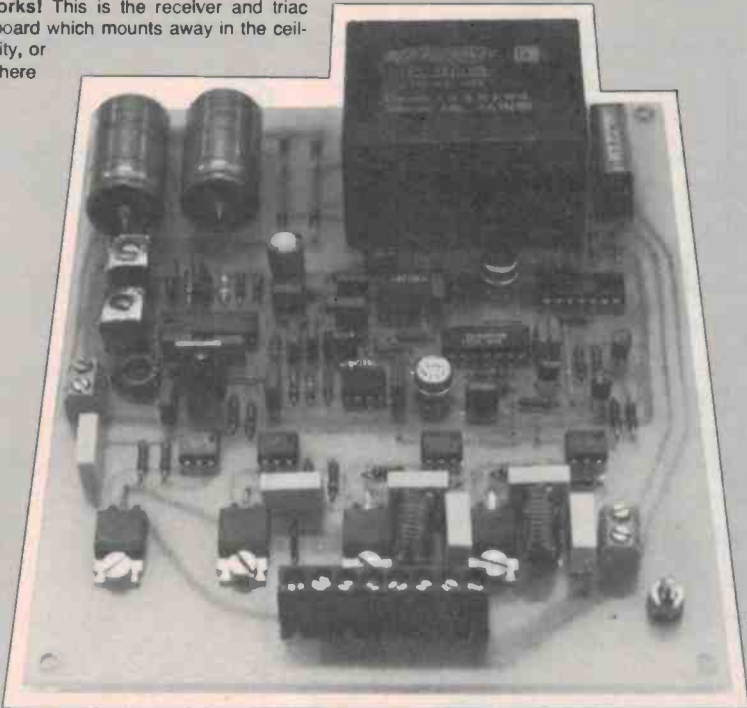

Typical application

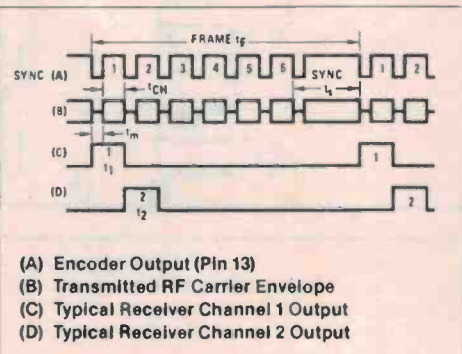
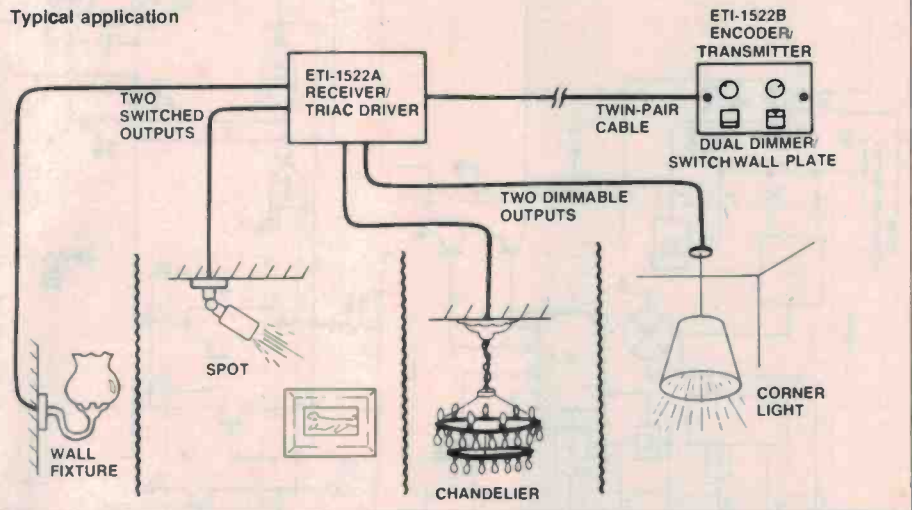
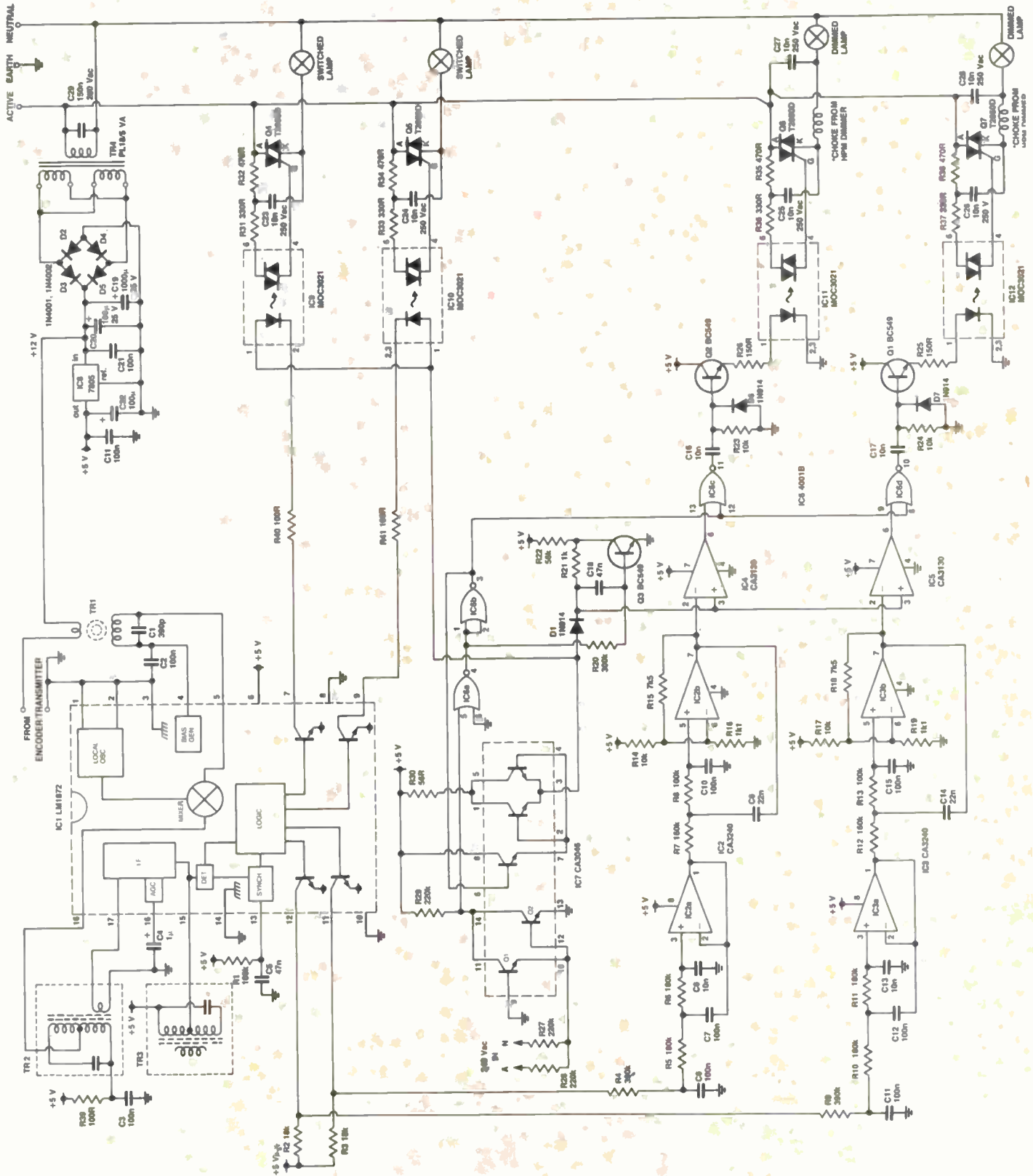

Figure 1. Typical encoder output waveform. The width of the first two pulses gives the analogue data.

- (A) Encoder Output (Pin 13)
- (B) Transmitted RF Carrier Envelope
- (C) Typical Receiver Channel 1 Output
- (D) Typical Receiver Channel 2 Output

Project 1522

Circuit of the receiver and triac driver (ETI-1522A)



HOW IT WORKS — ETI-1522

The light controller can be divided into two major sections; the transmitter and the receiver and the receiver itself can be divided into several sections which are: the RF receiver, analogue filtering, mains synchronisation and triac drive. First, consider the transmitter.

The transmitter sends its information as to potentiometer position and switch status by sending a series of between three and six data pulses followed by a much longer pulse to synchronise the system (see Figure 1). All the pulses are separated by an off period of exactly the same time. The first two pulses are individually pulse-width modulated to encode the two analogue channels and the next one-to-four pulses contain the switches, encoded by a simple counting system. As the width of the first two pulses and also the number of subsequent pulses can vary, the actual time taken for data transmission varies as the input controls are varied. However, the LM1871 allows for this by varying the length of the synchronising pulse so the length of every data frame is the same.

While it is interesting to go into details of the internal operation of the LM1871 the essential part is to understand how the external components affect the operation of the integrated circuit. The IC consists of several separate RC timing circuits and some combining logic, together with voltage reference generators to give both stable timing and stable RF output level. Overall data frame timing is set by R8 and C10 and this time constant sets the 75 Hz data rate for the system. The time between each individual pulse of the data and the duration of each data pulse is set by capacitor C11, together with different resistors for the inter-pulse time and the actual pulse durations.

When the LM1871 is measuring the time between the pulses it is charging C11 from $0.33 V_{ref}$ to $0.67 V_{ref}$ by switching in R1. When the LM1871 determines an actual pulse it discharges C11 through the resistor associated with that pulse. For example, when it sets the length of the first pulse in the data frame it switches in the resistance connected to pin 3, which is R7 and RV2. Thus, R7 sets the minimum pulse width of the first analogue channel and RV2 varies the pulse width from that minimum. The same cycle is repeated for the second analogue channel; charging C11 through R1 and then selecting the second discharge resistance, R6 and RV1.

If desired, four more analogue pulse-width modulated channels can be generated by connecting four more variable resistors to pins 1, 18, 17 and 16 but we don't want six analogue channels and also, the LM1871 contains extra circuitry to convert these potential extra channels to two digital channels and at the same time make the receiver much simpler. If pins 1, 18, 17 and 16 are all connected together (as they are here) then for pulses three to six, the same resistor will be used and the last four pulses will have the same length.

Internal logic exists in the LM1871 to operate on information provided on pins 5 and 6 and vary the number of pulses that are sent according to that information. For example, if both pins 5 and 6 are left open (the IC has internal pullup resistors) then only one fixed duration pulse is sent after the two analogue pulses and the rest of the frame time is made

up with the synchronising pulse. If both pins 5 and 6 are shorted to ground then a further four fixed duration pulses are sent and the synchronising pulse is proportionally shorter. This is clearly illustrated in Figure 2.

This takes care of the encoding and timing but leaves the problem of the actual transmission. For this purpose the LM1871 provides a single transistor with its emitter internally connected to ground (which removes a few design options but I think they ran out of pins!). As I wanted an oscillator whose frequency was stable but didn't want to spend money on a crystal I chose to use a ceramic resonator as the major frequency selective element. These resonators behave very much like crystals except that they are not quite as accurate or stable and seem to have a whole lot more spurious resonances. In order to control the spurs it is necessary to have the oscillating amplifier selective by itself so that where the spurs occur there is low loop gain.

In the circuit chosen, the collector of the oscillator drives a tuned circuit and the power supply and ac earth is connected to a tap almost at the other end of the coil. Thus, the other end of the resonant circuit has a voltage in opposite phase to the collector and of much lower amplitude, suitable to drive the base. The signal to the base is divided down through C6 and C8, together with the ceramic resonator. Thus, the base drive is heavily attenuated for all frequencies except the resonant frequency of the ceramic resonator which controls the frequency of oscillation.

The output from the oscillator is taken from a secondary winding and one end is tied to ac earth via C5. The other side of the winding has a current limiting (and impedance defining) resistor R3, which connects to the +12 volt supply line. Thus, the oscillator signal is coupled at low level to the transmitter supply. R2, C1 and C2 protect the logic circuitry from interference from the transmitter output.

Capacitors C3 and C7 are used to wave shape the data pulses out of the digital section so the RF spectrum of the transmitter output does not "splatter", but this is principally for radio type applications and not strictly necessary here. They are included more for nicety than necessity.

The receiver and data recovery part of the main controller revolves around the National LM1872 which is the companion IC to the LM1871 transmitter. The receiver section of the LM1872 is designed as a superheterodyne receiver, but for this application all that was necessary was a tuned amplifier at 455 kHz with adequate agc as it is indeterminate what attenuation from the transmitter can be expected. For this reason, the local oscillator section of the LM1872 was disabled by grounding its crystal inputs, pins 1 and 2. This makes the mixer of the LM1872 into a simple amplifier (the local oscillator modulates the emitter current of a differential pair and grounding pins 1 and 2 sets a constant emitter current). Thus, what would normally be the RF input becomes an "IF" port and accepts the input from the line.

The actual input signal is coupled in by TR1, a 20:1 step down transformer. The primary is a single turn and the secondary is 20 turns wound around a Philips 3H1 9 mm toroid. This gives a secondary inductance of about $320 \mu\text{H}$ which resonates with C1, a 390 pF capacitor, at 455 kHz. Thus, the high

input impedance as seen at pin 5 of the LM1872 is transformed down by 20^2 to present a few tens of ohms to the 12 volt supply line at 455 kHz and almost no impedance for other frequencies.

The next two stages in the IC provide more than adequate gain for our needs. TR1 couples into the base of one side of a differential pair and TR2 is connected to the collector of the opposite side. The secondary of TR2 couples via diode biasing to the lower section of a cascode pair which is also part of the agc system. TR3 acts as a simple resonator in the collector of the upper transistor of the cascode pair. This collector also drives the agc system and rf detector. Thus, as the agc system has high gain itself, the RF level seen at pin 15 doesn't vary and it is necessary to monitor the dc agc voltage when tuning the receiver.

Once the detector has recovered a binary signal from the RF data bursts the LM1872 must separate the two analogue channels and, by pulse counting, determine the state of the two transmitter switches. The LM1872, like the LM1871, has one master timer which is used to recover frame rate. This is set by R1 and C5. Whenever the LM1872 sees no incoming RF it resets the timer R1C5 and while a continuous carrier is being received the timer is allowed to exponentially rise (see Figure 3).

If the carrier is present for long enough, such as for a synchronising pulse from the LM1871, then a comparator in the LM1872 fires and its decoding cycle is started. The next ON to OFF transition is read as the start of the first analogue pulse and the next ON-to-OFF transition is the end of the first channel pulse and the start of the second. The third transition terminates the second analogue channel pulse and from then on the LM1872 merely counts ON-to-OFF transitions to determine the status of the transmitter switches.

The two digital outputs from the LM1872 are used to drive the cathodes of two optocouplers directly and the anodes are pulsed on zero crossings of the mains. For the two analogue channels the processing necessary is more complicated. The outputs from the IC are set as open collectors and R2 and R3 act as pullups to 5 V. All the timing from the LM1871 is set so that the two analogue channels have pulse widths of between 1 ms and 2 ms (with an allowance for tolerancing — it is less than one and more than two).

As the 75 Hz frame rate gives a pulse repetition rate of 13.33 ms then the two pulse-width modulated outputs have dc components of between $5(1/13.33)$ and $5(2/13.33)$ or approximately between 0.4 and 0.8 volts. Superimposed on this is a very strong signal at 75 Hz, plus harmonics. Therefore, the dc component must be dc-shifted and amplified to give an output of between 0 V and +3 V. The two active filters achieve this and provide an attenuation of about 60 dB for the 75 Hz. They are equiripple group delay filters with a phase ripple of 0.5° , which provide an optimum transient and frequency response for this application (see text).

As the dc output is being used to fire triacs, the dc must be related to mains 50 Hz to be of use. IC7, and principally transistors pins 9-10-11, labelled Q1, and pins 12-13-14, labelled Q2, are used as a mains zero cross- ▶

... How It Works, continued.

sing detector. The base of Q1 and the emitter of Q2 are both grounded and the emitter of Q1 is connected to the base of Q2 and, via R27 and R28, to the actual 240 volts 50 Hz mains (one of the resistors is connected to the active and the other is connected to neutral so that if active and neutral are reversed, then everything still works). When the mains is at greater than one V_{be} above ground Q2 is turned on. Also, when the mains voltage is greater than one V_{be} below ground then Q1 is turned on (in fact it must be less than $-5 V$ before Q1 saturates completely). Only for mains voltages between ± 0.6 volts are both transistors completely off and their common collectors, pins 11 and 14, at +6 volts. Thus, the two commoned collectors have a positive-going pulse every time the mains voltage passes through zero. This pulse is buffered and cleaned up by two gates in IC6.

The buffered, positive-going pulse is impedance transformed by the rest of the transistors in IC7 acting as a Darlington emitter follower and used to reset a ramp generator formed by Q3 and its associated resistors and capacitors. C18 is forcibly charged to about 2.6 volts through D1 on a mains zero crossing (the other side of C18 is held at 0.7 V by Q3's base). C18 is then charged through R20 and the current is mir-

rored by collector current through R21. This produces a linear negative-going ramp at the node of C18, D1 and R21. This ramp is applied to the non-inverting inputs of the two analogue channel comparators while the dc signals derived from the filters are applied to the inverting inputs. The two gates of IC6 following the comparators ensure that even when the comparators are always low, which corresponds to lights full on, there is still a pulse on mains zero crossing to fire the triacs. The gate outputs are CR differentiated and buffered, then used to drive the MOC3021 optocoupler input anodes directly.

The four triacs have one terminal connected permanently to the active mains input, the other is connected to the load. This means that when the triacs are off, the driven light fittings are safe. A second, much smaller, triac in the optocoupler is used to trigger the main one on for each circuit. A resistor-capacitor-resistor combination protects the optocoupler triacs from excessively high dV/dt and hence accidental triggering from mains transients. The two triacs that are driven from the dimmer controls have simple LC filters in their outputs to suppress radio frequency interference. The on-off triacs have no need for this as they are always fired on zero crossings.

opposite direction. The coil used to operate the transistor in the IC provided as an oscillator also gave an easy way of injecting the oscillator output onto the line. Oscillator frequency stability was provided by using a 455 kHz if ceramic resonator (readily available from Tandy, and others) as part of the feedback.

As the LM1871 provides all the necessary circuitry to modulate and waveshape the oscillator output from the encoder output, a complete and compact controller was easy to construct.

The actual controls feeding the LM1871 were made from modified light fitting controls purchased for the purpose. I chose to use HPM light fittings as they have a neat and convenient arrangement where a panel is purchased with the required number of holes as there are to be controls and then the controls (switches or dimmers) are snapped into the panel.

In order to keep things looking exactly like ordinary light fittings I bought two light dimmers and removed all the works from them except the 500k pots, which are the dimmer control elements (see How It Works). The end result can only be distinguished by the two mounting screws for the electronics printed circuit board. In order to save space in the controller all capacitors are the smaller 5 mm pin spacing, 63 V metallised film type which are increasingly becoming an industry standard and are available from many manufacturers.

Once the encoder/transmitter had been designed and modelled, the next problem was to design a modified receiver/decoder which would recover the 455 kHz bursts and regenerate the analogue and digital

information. The LM1872 contains all the circuitry for a complete superheterodyne receiver which was somewhat more than was strictly necessary for this application. The on-chip local oscillator was therefore disabled and only the IF amplifier section used. Two of the IF transformers from a set carried by Dick Smith Electronics (L-0260) were used and gave satisfactory performance.

The 455 kHz was coupled from the power supply line with a toroidal transformer whose output was approximately resonated with C1, a 390pF capacitor. This means that the input impedance of the RF section is accurately transformed down to about 20 ohms to recover the 455 kHz from the line. The agc for normal applications is filtered with a 100 nF capacitor on pin 16. In this application, where there is no variation in input signal level, the filter capacitor can be increased to 1 μF , or even greater, with no problems and in fact helps by preventing the agc following the input pulses.

The LM1872 IF and detector sections recover the pulses generated by the LM1871 encoder and pass them onto the decoder section whose operation is shown in Figure 2. It can be seen that the decoder simply counts negative-going edges after the synch pulse to determine the status of the two switches in the LM1871 circuit. The timing diagram also illustrates just how the LM1872 derives timing information from the first two pulses after the synch pulse for the analogue channels.

Figure 3 shows how different numbers of pulses are sent from the LM1871 to convey switch status. As the frame timing in the LM1871 is set by a separate resistor and

Circuit of the encoder/transmitter.

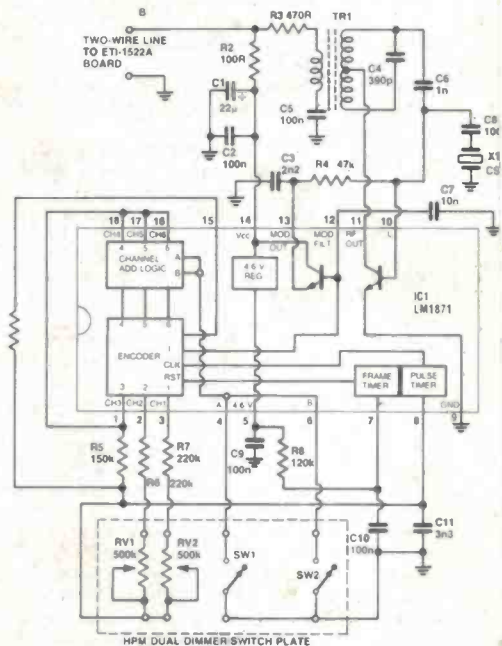

capacitor from the data RC circuit, as the number of data pulses is reduced the synchronising pulse gets longer so the frame rate remains constant at 75 Hz.

In the decoder circuit used, both the analogue and digital outputs were configured as open-collector transistors (the LM1872 offers a choice of open-collector or open-emitter drivers for the digital outputs). Processing of the digital outputs, was no problem and the collectors switched the triac drives directly (see "How It Works").

However, the analogue channels needed a lot of processing before they could be used to operate triac drives. As the whole of the LM1872 had a maximum operating voltage of 7 V the whole of the receiver and triac drive circuitry was operated from a regulated 5 V rail. (I'm sure National had a good reason for the voltage restriction but it escapes me).

When resistors R2 and R3 are connected to the output collectors the resultant output is a pulse-width modulated signal with the pulses swinging between about 40 mV (the transistor $V_{ce sat}$) and 5 V. This signal has a dc component and a somewhat larger ac signal. In order to recover and amplify the dc, and at the same time remove the ac, several methods were considered but finally the simple and straightforward way was chosen; namely — a low pass filter to preserve and amplify the dc and at the same time provide about 60 dB attenuation of the 75 Hz fundamental (and appropriately more for the higher harmonics of the ac signal).

When it comes to filters there must be about as many different types and class of filter as there are applications; and there are an equally large number of realisations for

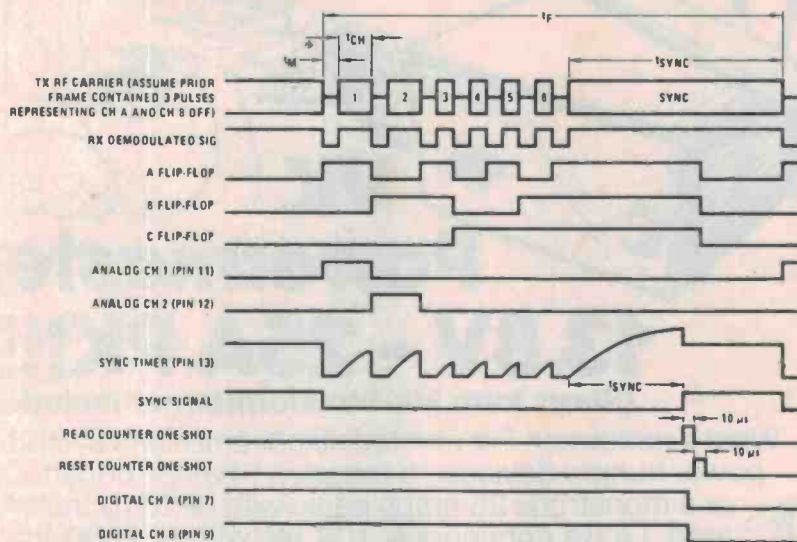
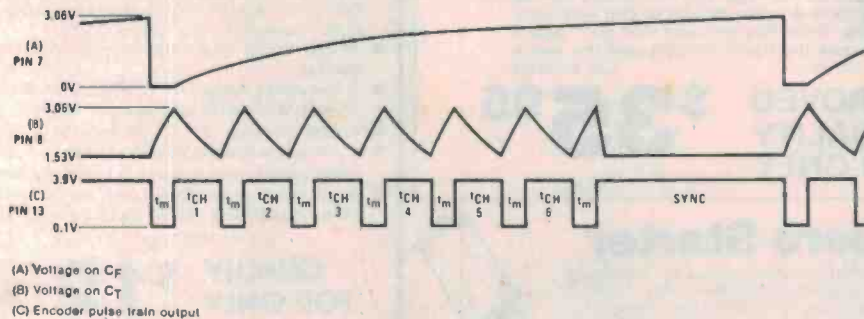

Figure 2(a). Receiver timing waveforms.

PIN CONDITIONS		LM1871 TX	LM1872 RX		
PIN 5 (CH A)	PIN 8 (CH B)	TRANSMITTED WAVEFORM	BINARY PULSE COUNT	DIGITAL OUTPUTS	
				CH A	CH B
OPEN	OPEN		100	OFF	OFF
GND	OPEN		101	ON	OFF
OPEN	GND		110	OFF	ON
GND	GND		111	ON	ON

Figure 2(b). Digital channel encoding and decoding via pulse-count modulation.



(A) Voltage on C_F
(B) Voltage on C_T
(C) Encoder pulse train output

Figure 3. Simplified waveforms for the encoder timing circuits.

each class. Filter types vary from *ye olde Butterworth* (whose chief merit lies in the simplicity and regularity of its transfer polynomial) up to the more exotic *Cauer-Chebyshev* filters which give optimum cutoff response but fierce group delay distortion (and hence ring like a bell).

For this application we really need optimum step response, as if the filter rang then, when the lighting intensity was suddenly changed, it would brighten and fade several times before settling down. This would suggest a Bessel filter which has an optimised step response (it doesn't overshoot or ring at all) but a rather slow and soggy frequency response. However, we can do a little better than Bessel's filter by accepting a tiny amount of overshoot (only a few per cent) and using an equi-ripple group delay filter where the filter phase response is allowed to vary a small amount around the ideal linear (Bessel) response and a slight improvement in frequency performance obtained.

The filter actually used is a 5th-order, 0.5° equi-ripple group delay filter which sounds all gosh! gee! wow! fantastic!! but nonetheless actually works just fine. (Linear phase or equi-ripple phase filters also have the advantage that they don't have any very high Q sections and so are a bit more forgiving on component tolerances).

The first section of the filter is a 3rd-order block with the capacitor values shifted to preferred values and the resistor values varied accordingly (this involves fun things like solving a hexic equation (you beat it to death with a calculator!)), but it means you can buy the components in this country. The second section is only a 2nd-order block but it has all the gain necessary to bring the pulse-width modulated dc up to about 0-to-3 volts.

At this stage in the circuit the fact that the information was transmitted at 75 Hz has been removed and all that remains is to relate the dc signals to the mains 50 Hz. In order to do this, IC7, a transistor array, is used to generate pulses on zero crossings of the mains and these pulses are used to generate a ramp which is compared with the dc from the filters (once again, see "How It Works"). After suitable gating to ensure the triac trigger pulses occur when wanted and don't when not (for a pot fully anti-clockwise it is essential that the lights be completely out and when fully clockwise they should be full on — care was taken here with end-limit tolerances) the processed analogue outputs are fed to the triac drives.

All four triacs are triggered through optoisolators to ensure that all the electronics is safe to work on **but beware!! there is 240 volts on the board!!** The two triacs that are switched from digital outputs have no output filtering as they are triggered on zero crossings, but the two dimmer triacs are filtered to suppress RFI. ●

... to be continued, next month.

BUILD DICK'S KITS & SAVE!



Don't miss out on these

DICK SMITH KIT BENEFITS

- Instructions for all kits are written by professionals, in easy to understand language.
- Kits are laboratory tested to prove that they actually work and all components are thoroughly checked by our Quality Control Department.
- We are proud of our kits. We have built our reputation based on their quality and back every kit we sell with our exclusive 7 day satisfaction guarantee.

That's the
DICK SMITH GUARANTEE

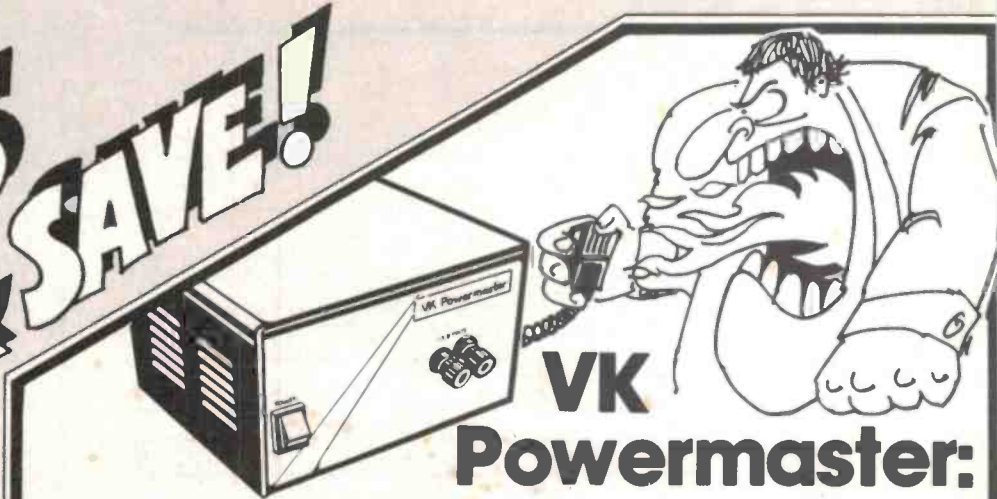
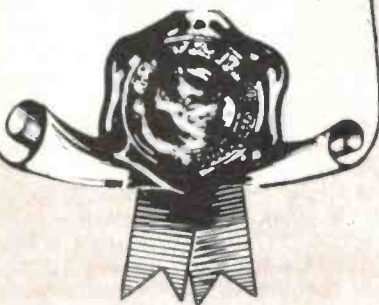

VK

Powermaster: 13.8V - 25A PK!!!*

(Short form kit; transformer not included)

What a performer! For amateur linear amplifiers and other power hungry devices - a massive 14 amps continuous or a monstrous 25 amps peak (with M-2010 transformer). Or 6A continuous, 10A pk (with M-2000 transformer).

So you choose the power supply you want to build. With electronic fuse (short circuit or over-current protection) housed in heavy gauge aluminium case. Cat K-3448

Transformers to suit:

- 14A Transformer Cat M-2010 . \$49.95
- 6A Transformer Cat M-2000 . \$24.95

ONLY **\$99**

**NEW!
LET CALLER**

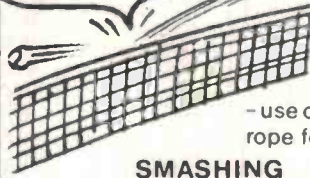

**ANYONE
FOR TENNIS?**

When you play McEnroe, he won't be able to dispute any calls! Portable, battery operated - use on any Court with wire rope for net. Cat K-3098

**SMASHING
VALUE \$19⁹⁵**

Video Enhancer



VCR's are all the rage. But the quality can be pretty crook. A video enhancer can help considerably. Build this one and find out - and it won't break the bank! Don't forget the patch over your eye... Cat K-3463

**IMPROVED
QUALITY
FOR ONLY \$35⁹⁵**
See EA
OCTOBER 1983

Fluoro Starter

This substitute electronic starter solves the problem of lights going blink, blink, blinky blink and gives you a smooth rapid start EVERY time you switch on. And all the parts are housed in a standard starter case! Outlasts conventional starters by far! Cat K-3082



ONLY **\$4⁵⁰**

See EA OCTOBER 1982

**INCLUDING
EXCLUSIVE
MOULDED CASE**



500MHz Digital Period/Frequency Counter

Superb design uses the latest IC technology. The low component count makes it very reliable and easy to build. It will measure frequency to 500MHz (with optional pre-scaler - see left) and period both with a 7 digit resolution. It rivals the performance of commercial units costing many times the price! Cat K-3439

- Huge, bright high efficiency, 7 segment display.
- 3 frequency ranges, 0-10MHz, 0-50MHz, 10-500MHz (with optional pre-scaler).
- 4 gating times, .01, .1, 10 seconds.
- 4 period measuring ranges, 1, 10, 100 and 1,000 input cycles to give a 0.1us resolution.
- High input sensitivity, 10mV to 30MHz, 10mV to 50MHz @ 1M input impedance.

SEE EA DEC. 1981

**QUALITY
FOR ONLY \$125**

Pre Scaler FOR ABOVE
Cat K-3432 **\$34⁵⁰**



TV SERVICEMEN
BUILD-IT-YOURSELF BARGAIN!

TV Pattern Generator

A bargain for the serviceman, technician, hobbyist, etc. We had one of these 5 years ago and sold thousands! Now here's a brand new kit giving crosshatch, dot and raster for fast and simple convergence, etc.
SEE EA NOV. 1983 Cat K-3472

YOUR OWN CASINO! The Dick Smith Electronic Roulette Wheel

PLAYING
MAT
EXCLUSIVE
TO DICK SMITH

Wow! All the fun and excitement of Las Vegas... West Point... even Forbes Street. Now you can have a completely random roulette wheel - without the bias of some commercial units.
Cat K-3389 SEE EA MAY, 1983



AMAZING
VALUE AT
\$29⁵⁰

A GAME OF SKILL!

Leds & Ladders

A game of skill which is not only a lot of fun to play, but which also gives you a chance to improve your reflexes. Can you climb out of the well without being dumped back in? Easy to construct, the kit comes with all parts required and full instructions. Also included is a specially printed foil label for the box. Cat K-3390



VALUE AT
ONLY

\$16⁵⁰

SEE EA AUG. 1980

EXCLUSIVE
VIDEO MODULATOR
INC. IN THIS KIT

ONLY
\$29⁹⁵

Alien Invaders

Wow! You could save the earth from those pesky aliens... and on a kit you built yourself! Multi-level LED display, easy to build and battery operated. Fantastic for Christmas gifts for technically inclined kids.
Cat K-3393

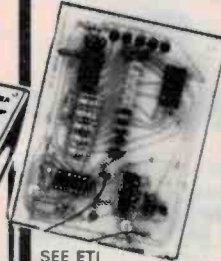

SEE ETI
AUG. 1983

ONLY **\$15⁹⁵**

The not so random Breath Tester

Beware boys in blue and booze buses bailing belligerent Brabhams blowing bad breath into bags before banning. Check out our breath tester kit - it could be the answer to your problems!
Cat K-3391

See EA
May 1983

ONLY
\$29⁹⁵



MORSE PRACTICE SET



Thinking of becoming an amateur radio operator? If you are, you'll need to be able to send and receive perfect Morse at a speed of 5 words per minute (or 10 words for a 'full' licence) before you can pass the amateur operator's licence examination. This Morse Practice Set will help you learn the code, and achieve the speeds necessary.

PREPARE FOR
AOCP EXAMS

ONLY **\$4⁵⁰**

SEE FUNWAY 2 800K



IT WILL AMAZE
YOUR FRIENDS!

Electronic Door Chime

An exclusive design, this unit plays a different tune every time you press the front door button. Perhaps you like one tune in particular, this is also possible. Everything you need is supplied in this great kit.
Cat K-3502

ONLY **\$34⁹⁵**

SEE EA SEPT. 1979

IT'S AMAZING

Stereo Simulator

Wish those old video movies had modern stereo sound? This low-cost gadget turns almost any mono signal into amazingly good synthetic stereo!

Easy to build, tool
Cat K-3421
See EA, April 1983

\$19⁹⁵



SOUNDBENDER

With this great little kit you can sound like a Dalek, a Darth Vader, a Cylon, or any one of a dozen robotic spin offs!
Cat K-3509

ONLY **\$24⁵⁰**

ETI FEB. '82 WAS \$29.50



BUILD YOUR OWN

Phoney Patch

SEE ETI MAY, 1983

Phone patching is legal from November 1st. Build your own phone patch and save a fortune... very simple kit, suits most transceivers. Compare our price with built-up units.
Cat K-3054

\$59⁵⁰

Not Telecom Permitted

THE AMAZING

Musicolour Mk IV

The latest model Musicolour combines all the features of Musicolour III and Light Chaser, plus much more. Chaser plus 4 chase patterns, plus automatic and reverse modes for startling effects.
Cat K-3143

SEE EA AUG. 1981

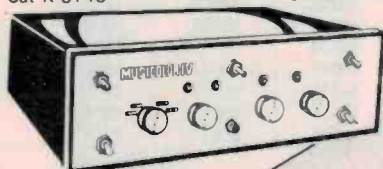

\$109

FOR YOUR CAR!



IMPROVED! Car Alarm Mk 2

See ETI
JULY 1981

The Car Alarm Mk 2 uses a different triggering technique - one that makes it less prone to false triggering! It will detect a current flow ANYWHERE in the vehicle's electrical system.

\$22⁵⁰

WAS \$28.50

Transistor Assisted Ignition

Ideal for use in all conventional ignition systems, this revised unit adds to stability and gives higher energy. Housed in a die-cast box with deluxe radial fin heatsink for best possible performance. Cat K-3301

SEE EA FEB. 1983



\$34

150W Mosfet PA/ Guitar Amplifier

Guitar and public address amplifier utilising ETI's 499 Mosfet 150 watt power amplifier module as published in ETI March, 1982. Comes complete with pre-amp PCB and special Hitachi mosfets 2SJ49 and 2SK134.

Cat K-3525

\$119

SEE ETI MARCH/
JUNE, 1982

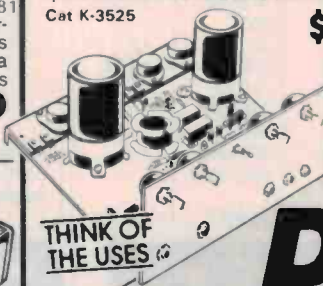

THINK OF
THE USES

MY KITS
LOOK SO GOOD YOUR
FRIENDS WON'T BELIEVE
YOU BUILT THEM!



DICK SMITH Electronics

See Page 93 for full address details

A678/CT

ARLEC

TRANSFORMER

GUIDE

O.E.M. Enquiries welcomed



Tamura Miniature Pulse

Designed principally for computers and measuring instruments.

Type No.	Primary Inductance (uH)	Details
G 52 J12C	800	Centre tap
G 53 E21C	2500	Centre tap
G 50 J111	8	3 windings
G 51 H111	50	
G 52 E111	250	
G 52 H111	500	
G 52 J111	800	
G 73 H111	5000	
G 74 B111	12500	
G 52 E211	250	

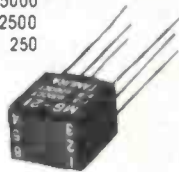

O.E.M. Enquiries welcomed

Tamura Green Chip Series

Miniature transformers designed for transistor circuitry.

Type No	Impedance (Ω)		Details
	PRI	SEC	
MG 24	500	50	AUDIO
MG 22	500CT	600	
MG 25	600CT	12	
MG 21	600CT	600CT	
MG 23	1K	50	
MG 17	10K CT	1.5K CT	
MG 16	10K CT	2K CT	
MG 15	10K CT	10K CT	
MG 14	20K CT	1K CT	
Inductance			
MG 106	O.I.H.	Inductor	

Low Profile

AL 7 VA Series. Insulated to AS 3126. P.C.B. mounting pins compatible with other current models and provision for additional anchorage to PCB's. 240V, 50HZ PRIMARY.

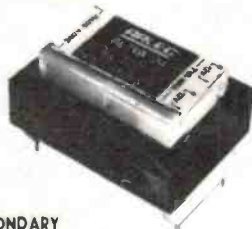

Type No.	VOLTS	SECONDARY AMPS	Details
AL 7VA/30	30	.23	2 equal secondaries for - Series - Centre Tap or Parallel Connection.
AL 7VA/24	24	.29	
AL 7VA/18	18	.39	
AL 7VA/15	15	.47	
AL 7VA/12	12	.58	
AL 7VA/9	9	.78	
AL 7VA/6	6	1.17	

P.C.B. Transformers



Type No.	VOLTS	POWER VA	Details
75000 Series	2-12V	1, 2, 5, 7, 10, 12	2 Secondaries May be used separately or connected in Series or Parallel.



Low and Extra Low Voltage

Type No.	VOLTS	SECONDARY AMPS	Details
2150	12.6CT	1.25	240V, 50 HZ PRIMARY
2155 A	8.5, 9.5	1	
5502	12.6CT, 15CT	1.25	
5504	15	2	
5508	12.6CT	2	
5579	6.3	1	
5755	40CT	1.25	
6474	12.6CT	0.15	
6625	25	0.5	
6672 A	17.5, 20, 24CT, 27.5CT	1	
6978 A	9, 10.5, 12.6CT, 15CT	2	
7309	12	2.5	
7310	24	1.25	
60817	24	1.25	
5503	11.5, 17	4	
7243	19, 33, 40, 50CT	2	
7311	24	4.2	
9583	10.9, 18.5x2	4.7, 0.87x2	
60202	17.5, 20, 24CT, 27.5, 30CT	3	
60203	30CT, 40CT	2	Two secondaries can be series or parallel connected.
	50CT, 60CT		
60291	25.2CT	3.5	

Type No.	VOLTS
60202	2.5, 3, 3.5, 4.5, 5.5, 6, 6.5, 7.5, 8, 9, 10, 12, 12.5, 15, 17.5, 18, 20, 24, 27.5, 30.
60203	5, 10, 15, 20, 25, 30, 45, 50, 55, 60
2155 A	1, 1.2, 2, 2.2, 2.4, 3.1, 3.2, 4.1, 5.1, 5.5, 6.3, 6.5, 7.5, 8.5, 8.7, 9.5, 12.6, 15.
6978 A	1.2, 1.5, 2.1, 2.4, 2.7, 3, 3.6, 4.2, 4.5, 5.1, 6.6, 6.3, 7.5, 8.7, 9, 10.5, 12.6, 15.
6672	2.5, 3, 3.5, 4.5, 5.5, 6, 6.5, 7.5, 8, 9, 10, 12, 12.5, 15, 17.5, 18, 20, 24, 27.5, 30.

Thyristor (SCR) Trigger Transformer

For power supplies, lamp dimmers, motor speed controls.

Type No.	VOLTS
XT1185	415 (Max voltage between windings)

HEAD OFFICE VICTORIA
30-32 Lexton Road, Box Hill, Vic., 3128
Ph (03) 840 1222 Telex 32286

NEW SOUTH WALES
47 Drummond St., Belmore, N.S.W.,
2192 Ph (02) 789 6733 Telex 22874

WAGGA
K. J. Warden (Agencies) Pty Ltd
7 Norton Street, Wagga, N.S.W., 2650
Ph (069) 21 2735 Telex 69960

ARLEC



Multi Tap

General purpose transformers for special projects and experimental work provide a wide choice of output voltages 240V, 50HZ PRIMARY.

SECONDSRY AMPS	Details
3	Centre tapped 5V, 24V, 30V.
2 Amp Series 4 Amp parallel	Centre tapped 10, 20, 30, 40, 50 and 60V.
1	Centre tapped 2, 12.6 and 15V.
2	Centre tapped 3, 12.6, and 15V.
1	Centre tapped 5, 24 and 30V.



SECONDSRY Max. SCR AMPS

70



Enclosed Stepdown Transformers

240V, 50 HZ PRIMARY

Ideal for garden lamps, pond lights and water pumps, automatic trouble lamps, safety lights, pool lighting etc.

Type No.	VOLTS	SECONDSRY AMPS	Details
60269	32	2.25	Type No. 60280, 60426, and 60480 have two fuses in the secondary output for pool lighting applications.
60279	32	7.8	
60280	32	5.9	
50425	24	3	
60426	24	7.9	
60453	12	6	
60480	12	15	

Portable Stepdown Transformers

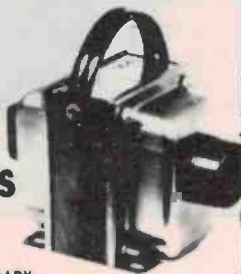

Type No.	VOLTS	SECONDSRY AMPS	Details
PT 5578	115	0.35	For shavers, radios, tape recorders, heating blankets, TV receivers appliances and instruments. 2 Pin socket.
PT 2164	115	0.87	
PT 2166	115	2.17	
PT 2168	115	4.35	
PT 2170	115	8.7	
PT 9585	240	1	
PT 9789	240	2	

Constant Voltage

Isolated, constant RMS Voltage output.



Type No.	INPUT	OUTPUT
CV 9024	190-260 RMS	240V-1A
CV 9027	190-260 RMS	240V-4.17A

Audio

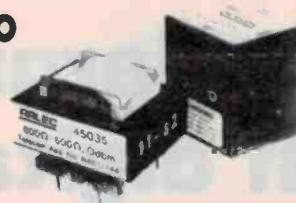

Type No.	PRIMARY IMPEDANCE	POWER	Details
45012	70 100V Line. 4 8 16 ohm	1 1/2-4 WATTS	Line to speaker impedance
45035	600 ohm	odbm	PCB Mounting. Telecom approved.
45065	600 ohm	- 20 dbm	Line isolation to Telecom 1053, 1054

Control Circuit

For switchboards. PRIMARY 240V 50 HZ Insulation to AS 3126.



Type No.	IMPEDANCE	SECONDSRY POWER	Details
PT 9169	32.24	1.88	SEC approved
PT 9170	32.24	3.12	
PT 9171	32.24	6.25	

Soldering Iron

For low voltage soldering irons or similar applications PRIMARY 240V 50 HZ.

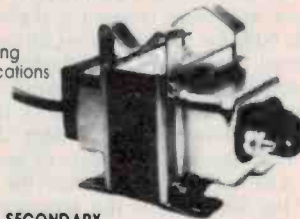

Type No.	VOLTS	SECONDSRY AMPS	Details
60158	3.3	30 Int	SEC approved

Bell and Chime Transformer

PRIMARY 240V, 50 HZ.



Type No.	VOLTS	SECONDSRY AMPS	Details
60999	Choice of 5, 8, 12, and 16 Volts.	1	Specially designed to power door bells and chimes. Double insulated and short circuit protected.

A.C.T.
K. J. Warden (Agencies) Pty. Ltd.
24 Geelong St. Fyshwick, A.C.T., 2609
Ph. (062) 80 5519 Telex 89234

SOUTH AUSTRALIA
30 Beulah Rd., Norwood, S.A., 5061
Ph. (08) 42 8918 Telex 89234

QUEENSLAND
Cnr. Vernon Terrace & Ethel St.
Newstead, Qld., 4006 Ph. (07) 52 1131
Telex 43263

WESTERN AUSTRALIA
611 Hay St., Jolimont, W.A., 6014.
Ph. (09) 381 9834, 381 9522
Telex 93973

TASMANIA
Launceston: GHE Electronics
76 York St., Launceston, Tasmania,
7250 Ph. (003) 31 6533

Hobart: GHE Electronics
162 Argyle St., Hobart, Tasmania, 7000.
Ph. (002) 34 2233

An enlarging exposure meter with digital readout

Peter Ihnat

With this project you'll get a higher yield of decent exposures from your darkroom. It includes a sensor that compensates for 'cosine error'.

NUMEROUS photographers develop their own films and prints in anything from well-equipped darkrooms to bathrooms and laundries made light-tight with blanket-covered windows. Rapidly rising costs of 'commercial' production, coupled with the fact that the photographer has complete control over the finished product, are some of the reasons for photographers "rolling their own". Fortunately, there is a surprisingly small number of electronic gadgets necessary in the darkroom to produce good quality black and white and colour prints. Even so, darkroom oriented projects in electronic magazines are few and far between.

One electronic gadget which is a must in the darkroom is an exposure meter — a device which quickly and accurately indicates exposure time and ends up paying for itself in terms of time and photographic paper saved. The current project evolved when I decided to buy a commercial exposure meter and soon realised a digital one could be built for the same cost as a simple commercial "two-LED comparative" type.

The device described here is very simple to operate since it consists of a remote probe (light detector), three-digit display (which indicates exposure time in seconds) and a "calibration" control on the front panel. One simply puts the sensor on the brightest area of the enlarger baseboard and the meter will indicate the correct exposure time. But more of this later. Let's look at the design details and construction.

Circuit description

The basic idea behind the unit's operation is to produce a digital output inversely proportional to the intensity of light falling on a sensor. Why inversely proportional, you might ask? Well, for a given type of photographic paper, the light intensity times the required exposure time is a constant (which takes into account the speed of the paper and the spectral "colour" of the enlarging lamp). Mathematically:

$$I \times E = C \quad [i]$$

where I = light intensity, E = exposure time and C = a constant.

Since we need the output from the meter to be E , the equation can be rearranged as follows:

$$E = C/I \quad [ii]$$

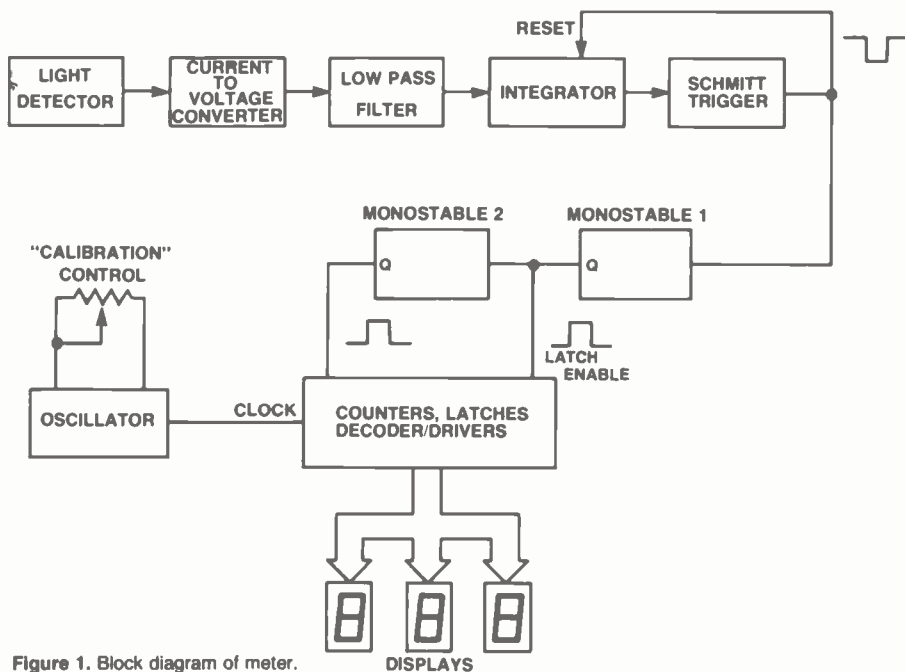

Figure 1. Block diagram of meter.

Notice that the exposure is *inversely* proportional to light intensity — the more light you have the less exposure is necessary. How is C handled by this meter? It's the "calibration" control on the front panel!

Figure 1 shows the block diagram of the meter. Originally, I used a phototransis-

tor as the light sensor and it worked well at high light levels. Unfortunately, at the low light levels typically encountered in darkrooms (0.001 — 10 foot candelas) the response was highly non-linear. The alternative was to use a photodiode as a light-to-current converter — the current then being

digital exposure meter

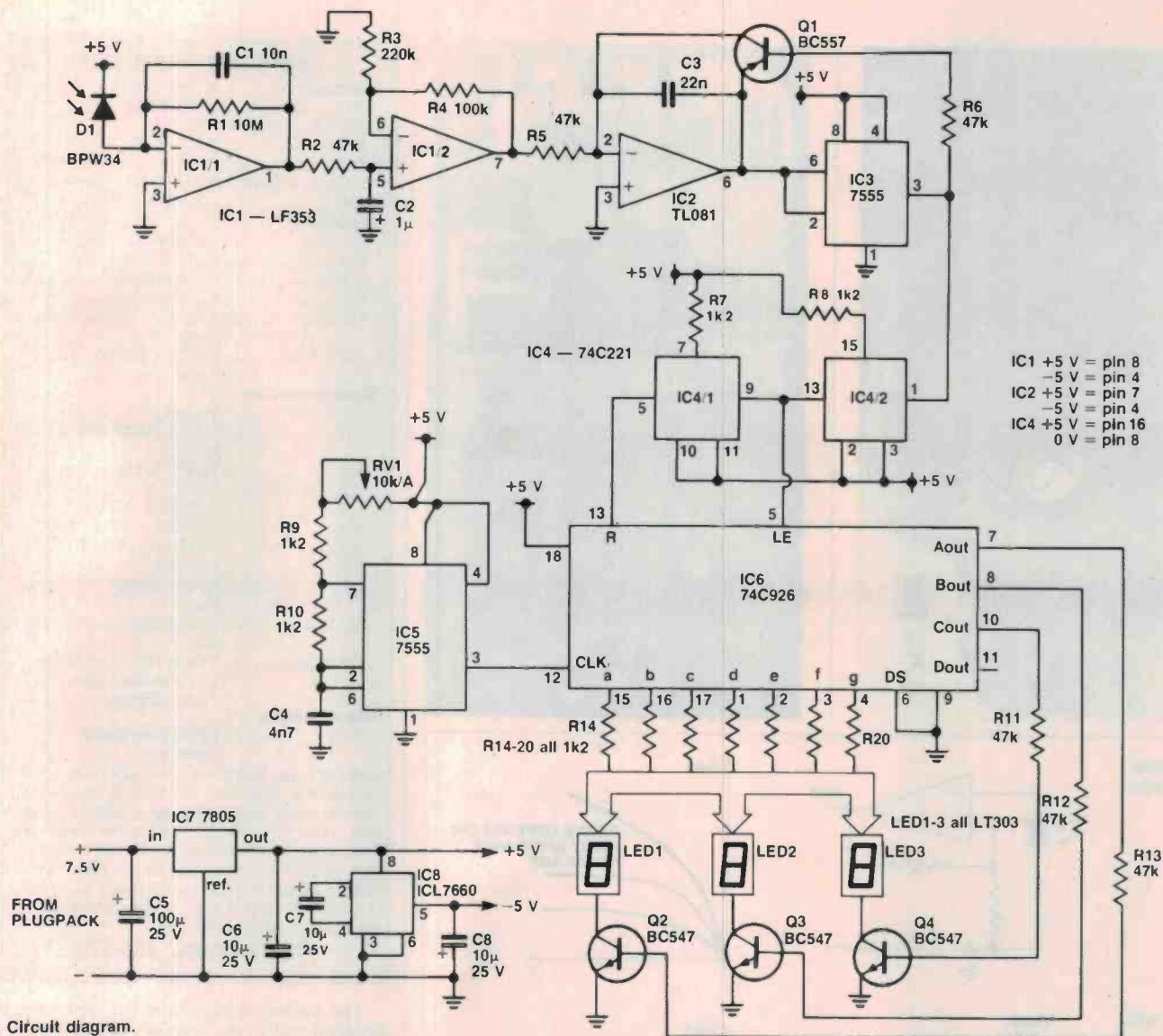

Circuit diagram.

HOW IT WORKS

The meter simply provides gating pulses whose period is inversely proportional to the intensity of the incident light. The pulses gate counts for a master oscillator into a four-digit counter which then displays the reading obtained.

Light falling on photodiode D1 produces a proportional current which is converted to a negative voltage by op-amp IC1/1. Resistor R1 affects the sensitivity and C1 is used to filter out any stray ac signals (HF and LF) picked up by the remote probe and connecting cable. IC1/2 is set up as a low pass filter with a gain of approximately 1.5 ($= R4/(R3 + 1)$) and a cutoff frequency of approximately 3 Hz ($= 1/(2 \cdot R2 \cdot C2)$). A first order filter is sufficient here since at 100 Hz the gain is approximately five octaves by -6 dB/octave $= -30$ dB.

IC2 and IC3 together form a voltage-to-frequency converter. IC3 is a 7555 timer set up as a Schmitt trigger with trigger levels set at 1/3 and 2/3 of the supply, i.e. 1.6 V and

3.3 V. IC2 is connected as an integrator and Q1 is used as a resetting switch. Operation is as follows — assume Q1 is initially off. A constant negative voltage applied to the input of the integrator causes the output voltage to increase linearly while charging C3.

When the output voltage exceeds the upper trigger level of the Schmitt (3.3 V), its output goes LOW which switches on Q1, discharging the integrator capacitor. The output of the integrator falls until it equals the Schmitt's lower trigger level (1.6 V). This sets the Schmitt's output HIGH again switching off Q1, allowing the cycle to repeat. The length of the cycle is inversely proportional to the magnitude of the voltage applied to the integrator.

The integrator reset pulse (from the Schmitt trigger) is used to trigger monostable IC4/2 which in turn triggers monostable IC4/1. The two respective outputs put active-high pulses on the latch enable (LE) and reset (R) inputs of the counter IC6 (refer to Figure 3 for relevant timing information) to latch the current count and reset the counter. IC6 is

basically a four-digit counter with latches, decoders and multiplexer (to drive four displays) all in the one package. This has the advantage of low component count and low power dissipation.

Note that resistors R14-R20 control the brightness of the displays and can be varied to suit. The least significant digit of the counter seems not to be used but is actually used as a divide-by-ten stage to reduce jitter in the final display. IC5 is the master oscillator whose frequency is controlled by RV1. It is a typical astable oscillator based on the 7555 timer.

Power for the meter is derived from a 7.5 V plugpack. The positive supply (+5 V) is produced by a 7805 voltage regulator. Since a split supply is required for the op-amps, I used the Intersil ICL7660 CMOS voltage converter to produce -5 V directly from the +5 V supply. This IC, plus two other components (C7 and C8), produce a very simple and effective negative supply generator. Refer to ETI July 1982, page 51 for a technical description of the IC.

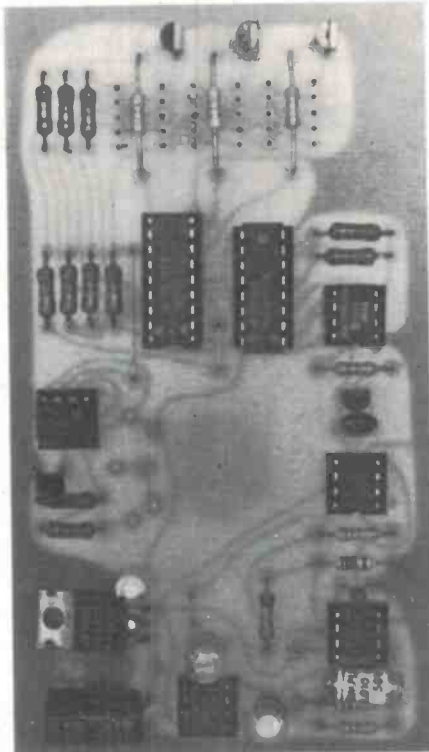
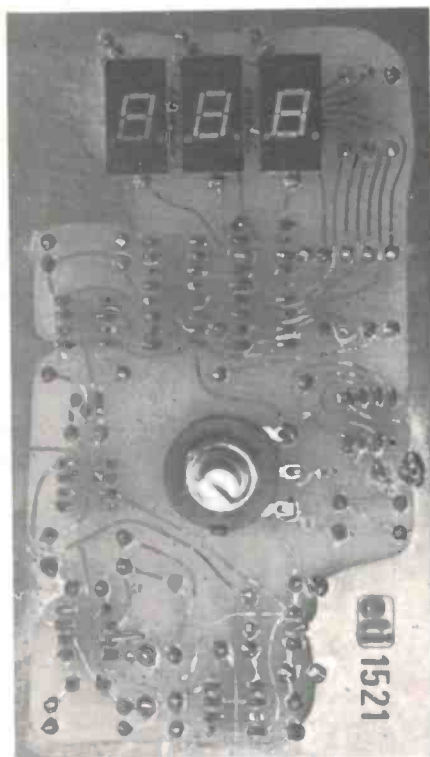

Figure 2(a).
Photovoltaic mode.

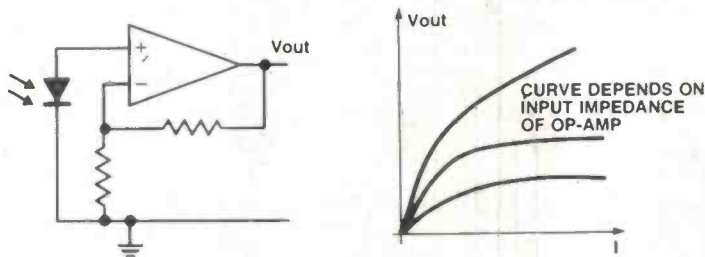
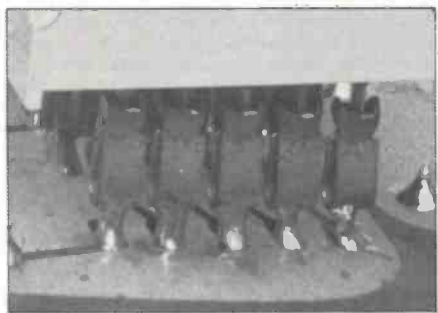
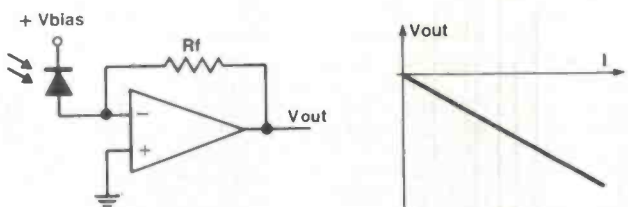

Figure 2(b).
Photocurrent method.



The trickiest part of the construction is the mounting of the molex pins which hold the 7-segment display on the copper side of the pc board.

converted into a voltage by an appropriate op-amp circuit. Figure 2 shows two possible methods.

The photovoltaic mode shown in Figure 2(a) unfortunately has a logarithmic transfer characteristic so I used the photocurrent method (Figure 2(b)) which has a very linear response. The diode I used is the BPW34 which is commonly available. Unfortunately, photodiodes which cover the same spectral range as the eye are difficult to obtain in Australia. The BPW34 has its peak response at 850 nanometres wavelength which is well in the red but since all enlargers use incandescent lamps of some description, no problems arise.

PARTS LIST — ETI-1521

Resistors	all 1/4W, 5%
R1.....	10M, 10%
R2, 5, 6, 11, 12, 13	47k
R3.....	220k
R4.....	100k
R7, 8, 9, 10, 14-20	1k2
RV1.....	10k/A see text
Capacitors	
C1.....	10n poly
C2.....	1 μ /10 V tant.
C3.....	22n greencap
C4.....	4n7 greencap
C5.....	100 μ /25 V electro, radial leads
C6, 7, 8.....	10 μ /25 V electro. radial leads
Semiconductors	
D1.....	BPW34
IC1.....	TL082, TL072, LF353 or sim.
IC2.....	TL081, TL071 or sim.
IC3, IC5.....	7555
IC4.....	74C221
IC6.....	74C926
IC7.....	7805, LM340T/5
IC8.....	ICL7660
Q1.....	BC557, BC558, BC559 or sim.
Q2, 3, 4.....	BC547, BC548, BC549 or sim.
LED1, 2, 3.....	LT303, HP5082-7740 or sim. common-cathode 7-seg. dlsplays
Miscellaneous	
SW1.....	DPDT slide switch (optional)

ETI-1521 pc board; dc plugpack with 7.5 V output (e.g. DSE cat. no. M-9526 or similar); coaxial socket to suit plugpack connector; zippy box 158 x 95 x 50 mm; half metre length of single core shielded cable; 35 mm film container; strip of 50 Molex pins; 30 x 60 mm piece of red filter; 5 x 8-pin IC sockets; 1 x 16-pin IC socket; 1 x 18-pin IC socket; hookup wire; Scotchal front panel label; nuts & bolts, etc.

Price estimate: \$65-\$73

The output voltage from the first stage is proportional to the intensity of the incident light but unless you have an enlarger which operates from a dc power supply, this voltage will have a significant 100 Hz ac component. The signal is then passed through a low pass filter to remove the ac and finally feeds the input of an integrator — a voltage-to-frequency converter. But since we need a signal which is inversely proportional to the light intensity, I have used the period of the waveform produced to gate the output of a master oscillator into the digital counter. The master oscillator essentially runs at some constant frequency which is set by the "calibration" control. The overall timing diagram shown in Figure 3.

Construction

If the project is assembled on the pc board I designed for it, then there should be little trouble with construction. A close visual inspection of the pc board should be done before assembly to see there are no cracks in tracks or bridges between tracks or pads. See that all the holes are correctly drilled. Firstly, insert and solder the three wire

digital exposure meter

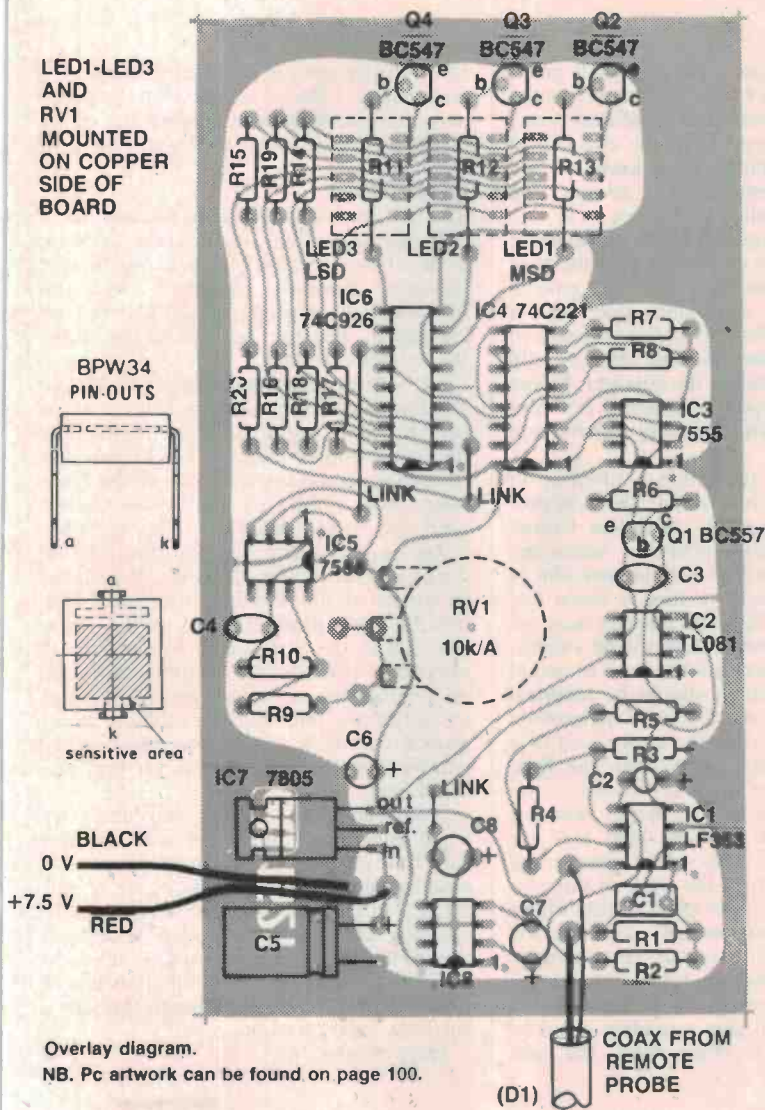
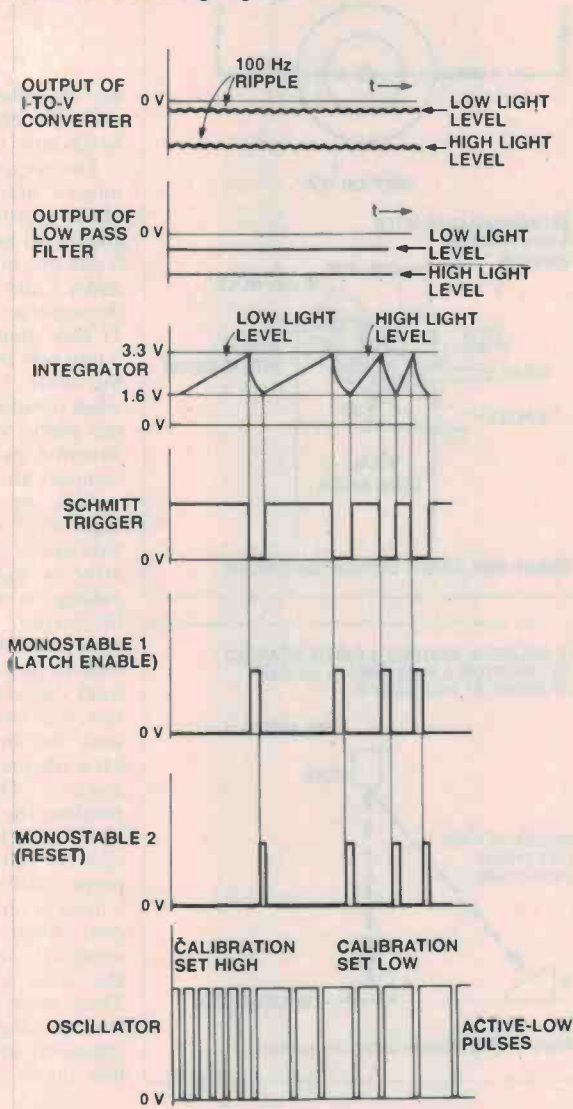

Figure 3. Overall timing diagram.



links, then the resistors (except R11-R13) and capacitors. It is recommended that IC sockets be used and these should be soldered in next followed by the 7805 voltage regulator, IC7.

The trickiest part of the construction is the mounting of the molex pins which hold the 7-segment displays. Note that these and the calibration potentiometer are mounted on the *copper side* of the pc board. The tracks around the 7-segment display area are very close together and so great care must be taken to avoid solder bridges between tracks or even worse, overheating the tracks causing them to lift. The following procedure should only be attempted with a fine-to-medium tipped iron.

Firstly, break the molex strip into six strips of five pins each. Using emery paper or steel wool, clean the oxide coating off the part which will be soldered. I noticed while constructing the prototype that any rubbish on these pins caused a weak solder joint to be produced and several pins came loose when I attempted to insert the displays. These loose pins are extremely hard to replace without producing solder bridges

and so the extra time spent cleaning saves problems later on.

When cleaned, a strip of five pins can then be inserted until the ends just show through the reverse (component) side of the board. The pins should be soldered before continuing with the other strips (if all six are inserted first, it will be almost impossible to solder them). The connecting bridges can then be carefully removed.

The remaining resistors and the transistors can now be mounted along with RV1. As mentioned before, RV1 is mounted on the copper side of the board and since the completed pc board "hangs off it", a drop of Araldite can be used to hold the two together with greater reliability.

Talking about reliability, a normal carbon pot can be used for RV1 but since these get dusty and end up with "dead" spots, I recommend a cermet, or conductive plastic type, such as the ones made by Bourns. If these are hard to get hold of I have made provision on the board for mounting the standard type. At this stage, the board can be powered up and the supply voltages checked. If all is OK, the ICs and displays

can be inserted ensuring that they are all orientated correctly. To aid insertion, the pins on the 7-segment displays should first be straightened with long nose pliers.

Now on to the mechanics. The prototype was mounted in a 158 x 95 x 50 mm zippy box. The pc board itself is mounted on the lid of the box by means of RV1. I used two nuts on the pot shaft — one below and the other above the lid to position the board at a suitable distance from the lid. The artwork for the Scotchal front panel is reproduced elsewhere in this article. I mounted the on/off switch (optional) and power socket (to suit a plug pack) on the left side of the unit.

Remote probe

The BPW34 photo diode can be mounted in any convenient container to act as a remote probe, e.g. a pill box lid. Note that this container should not be very high since you need to measure the light intensity as close as possible to the base board of your enlarger where the photographic paper will sit. A 50 mm high container may not make much difference to your reading when mak-

Project 1521

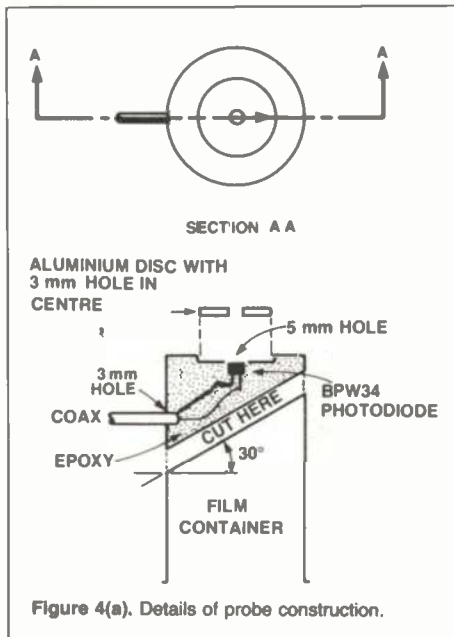

Figure 4(a). Details of probe construction.

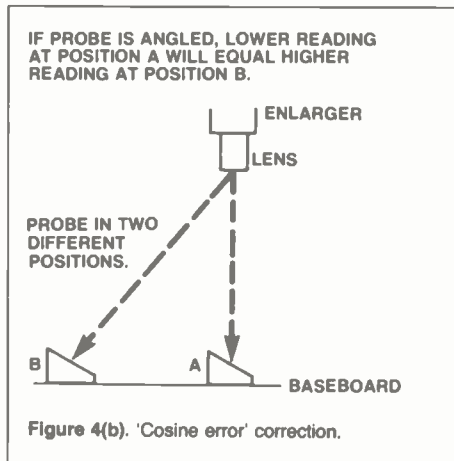

Figure 4(b). 'Cosine error' correction.

ing big enlargements, but for small prints when the lens may be only 100 mm from the baseboard, there will be a significant error.

For the prototype I cut the end off an unused film container (you know — the black plastic container that 35 mm film comes in) and drilled two holes in it — a 5 mm one in the top to hold the photo diode and a 3 mm one in the side to pass the coax through (see Figure 4(a)). On top I glued a 17 mm diameter aluminium disc with a 3 mm hole drilled in it to let light through to the diode. I painted the disc white to help when positioning under the enlarger. Filling the probe with epoxy completes its construction and results in a very durable and compact unit.

Note also that the probe is tilted at an angle of 30° to the horizontal. This is to provide some "cosine error" correction. Cosine error is most easily observed when the enlarger is switched on without any film in the carrier. If a light reading is taken directly beneath the lens and another near the edge of the baseboard, there will be a significant difference between the two. In actual fact, the two readings should be identical since the idea of an enlarger is to provide even illumination over the entire area of a negative. The error exists since the light reaching the sensor when at the edge of the baseboard hits it at an angle, whereas directly below the lens the light rays are perpendicular to it. Any sensor experiences a drop in sensitivity as the angle of the incident radiation increases (with respect to the vertical). One easy way of correcting for this is to angle the sensor permanently. Then, when readings are taken beneath the lens, the angled sensor has slightly reduced sensitivity and will give a reading equal to that taken near the edges where the light

falls directly onto it (see Figure 4(b)). For consistency, I placed an arrow on the probe and orientate it to point towards the centre of the baseboard when taking all readings.

Operation

The unit itself is very easy to use and needs only one control, the "calibration" control, to be set for each type of paper you use, e.g: Ilfospeed, Bromide, Ektaprint 2 etc. The idea is initially to prepare a test strip of your "standard" negative or slide to determine the correct exposure.

Let's assume for Ilfospeed grade 3 paper you find that 12 seconds is the correct exposure for your negative. Without changing the lens f-stop or enlarger height, position the probe on the *brightest* area of the baseboard and adjust the calibration control until the meter reads 12. The exposure meter is now calibrated for this type of paper and the reading from the dial should be written on the outside of its packet. The next time you produce prints on this paper you simply set the meter to the setting previously determined, position the probe on the brightest area of the projected image and adjust the lens aperture until the meter gives a reasonable reading, say between five and 60 seconds. Then expose for the indicated time.

Note that a test strip is only necessary when *initially* setting up the unit and not each time it is used. Also, since the meter is used to measure the intensity of the brightest area of the negative, this corresponds to allowing sufficient light through the lightest area of the negative to *just* produce black on the paper in this area. The other shades of darkening will then fall in line to produce a correctly exposed print.

Happy exposing!!

Front panel artwork.

eti 1521

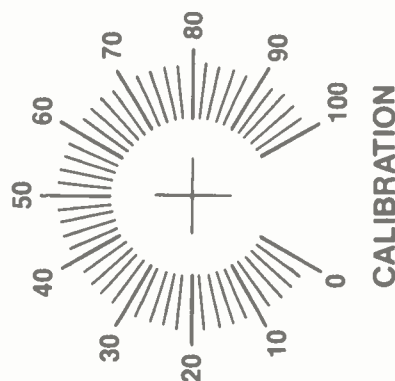

DIGITAL
EXPOSURE
METER

The printed circuit board pattern is on page 103.

IDEAS FOR EXPERIMENTERS

These pages are intended primarily as a source of ideas. As far as reasonably possible all material has been checked for feasibility, component availability etc, but the circuits have not necessarily been built and tested in our laboratory. Because of the nature of the information in this section we cannot enter into any correspondence about any of the circuits, nor can we produce constructional details.

Peak level indicator

David Hamill of The Gap, Queensland designed this peak level indicator which is useful for recording when it is more important to know what the peak level of a signal is, rather than its average level.

VU meters are normally used for this purpose, however, you will find that the LED output of this circuit is easier to interpret and makes the recording more accurate as the distortion will be reduced.

IC1a gauges the positive peaks while IC1b does the same for the negative peaks. Both positive and negative are set by RV1. You can select any threshold from ± 1 V. Whenever the input exceeds the positive of the negative level LED1 lights for about 0.1 second.

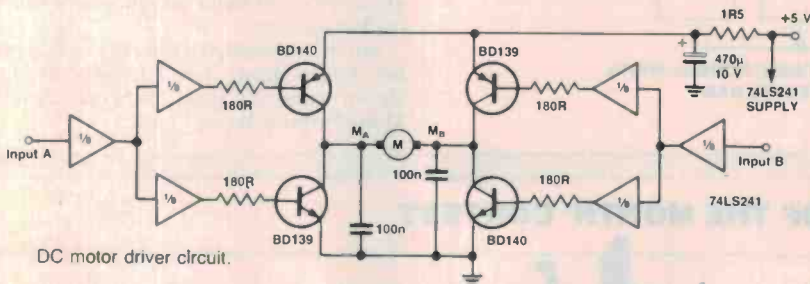
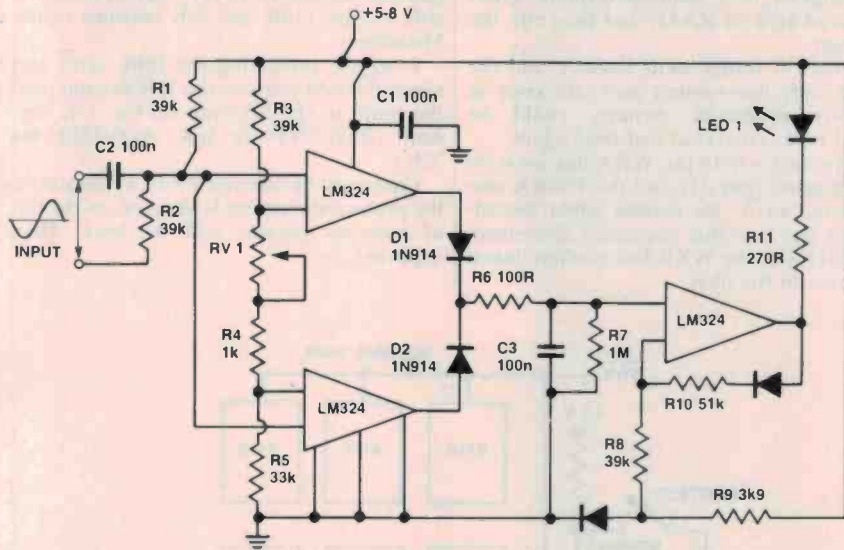

DC motor driver circuit.

Input A	Input B	M _A	M _B	Result
0	0	+5V	+5V	no operation
0	1	+5V	GND	motor turns
1	0	GND	+5V	motor turns opposite
1	1	GND	GND	no operation

Two circuits for the 74LS241

Brian O'Conner of Box Hill Victoria, has come up with two circuits for use with microprocessor parts. Both of them use the 74LS241 and in each case pin 1 is tied to ground and pin 19 to Vcc.

The first circuit is for a dc motor driver suitable for use with 400 mA/6 V motors like Fisher Technic. Little or no heatsink is required as all transistors are either saturated or off.

The second circuit is for a very simple 8-bit digital to analogue converter which can be built from scrap box components. It will give a linear output of 8 V p-p and the ramp produced by an 8-bit increment is quite smooth.

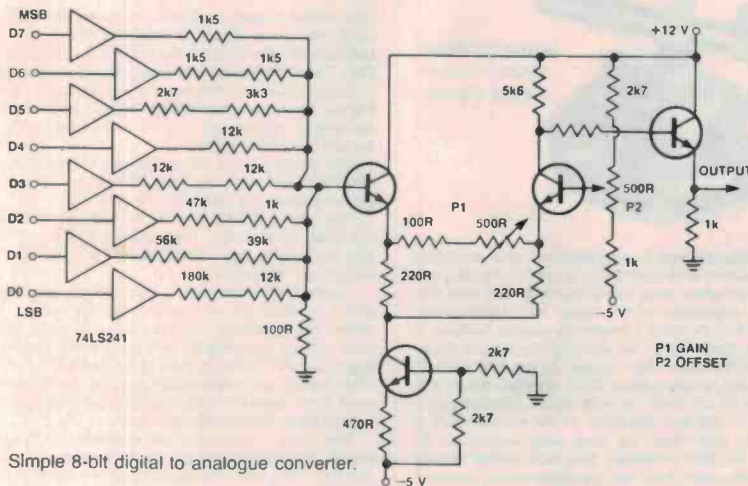

Simple 8-bit digital to analogue converter.

IDEA OF THE MONTH

Microbee write-protected memory ★☆☆

Paul Leonardi, Canley Vale NSW

After having inadvertently written over my source code or BASIC program with an untried program, I decided to put a copy of the program in a switch-selectable write-protected area of RAM, and then run the program.

So then if things went haywire and the source code was written over, the copy in the write-protected memory could be copied back, corrected and tried again.

To protect a 6116 the WRX line must be disconnected (pin 21) and the PWRX line connected to it. Be careful when disconnecting one line that you don't disconnect other 6116s as the WXR line is often linked from one to the next.

In the Microbee the first and last 2K blocks (6116s) should not be protected; the first is used for a BASIC-EDASM scratch pad and the last for BASIC strings and variable storage (16K and 32K versions of the Microbee).

I suggest protecting the fifth, sixth and seventh RAM chips on the 16K version, and the ninth to the fifteenth on the 32K version. (2000-37FF for 16K, 4000-77FF for 32K).

Care must be exercised with a cold start if the protected memory is selected, as the top of memory pointer will be lower than expected.

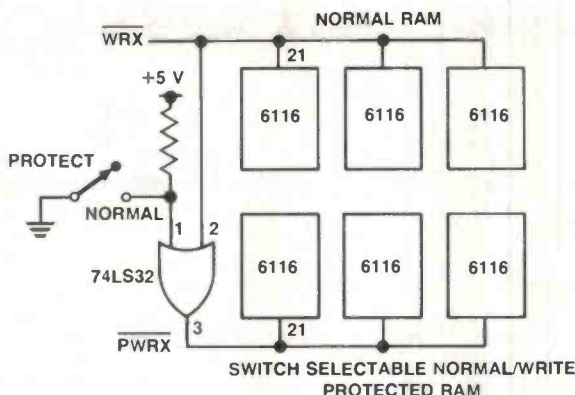

Scope for electronics in heaven

The Scope/ETI 'Idea of the Month' contest was won by Ian Johnston in November, 1983. Ian is now the Minister for the Mornington Parish of The Uniting Church. However, before joining the Ministry he studied electronics and holds a Diploma of Electrical Engineering.

Ian, who designed a tone operated switch for ETI's 'Ideas for Experimenters', is shown using his prize, a Scope Panavise Multi-Purpose Work Centre.

PRIZE WORTH \$90!

'IDEA OF THE MONTH' CONTEST

COUPON

Cut and send to: Scope/ETI 'Idea of the Month' Contest, ETI Magazine, P.O. Box 227, Waterloo NSW 2017.

"I agree to the above terms and grant *Electronics Today International* all rights to publish my idea in ETI Magazine or other publications produced by it. I declare that the attached idea is my own original material, that it has not previously been published and that its publication does not violate any other copyright."

* Breach of copyright is now a criminal offence.

Title of Idea

Signature

Name

Date

Address

Postcode

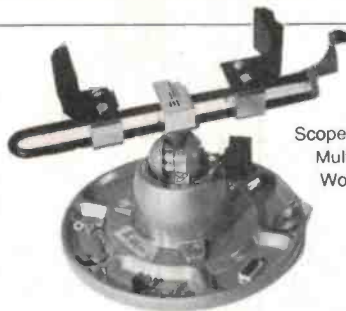

Scope Panavise Multi-Purpose Work Centre.

Scope Laboratories, which manufactures and distributes soldering irons and accessory tools, is sponsoring this contest with a prize given away every month for the best item submitted for publication in the 'Ideas for Experimenters' column — one of the most consistently popular features in ETI Magazine. Each month, we will be giving away a Scope Panavise Multi-Purpose Work Centre, Model 376/300/312, comprising a self-centering head (376), standard base (300) and tray base mount (312), all worth about \$90! Selections will be made at the sole discretion of the editorial staff of ETI Magazine. Apart from the prize, each winner will be paid \$10 for the item published. You must submit original ideas of circuits which have not previously been published. You may send as many entries as you wish.

RULES

This contest is open to all persons normally resident in Australia, with the exception of members of the staff of Scope Laboratories, The Federal Publishing Company Pty Limited, ESN, The Litho Centre and/or associated companies.

Closing date for each issue is the last day of the month. Entries received within seven days of that date will be accepted if postmarked prior to and including the date of the last day of the month.

The winning entry will be judged by the Editor of ETI Magazine, whose decision will be final. No correspondence can be entered into regarding the decision.

The winner will be advised by telegram the same day the result is declared. The name of the winner, together with the winning idea, will be published in the next possible issue of ETI Magazine.

Contestants must enter their names and addresses where indicated on each entry form. Photostats or clearly written copies will be accepted but if sending copies you must cut out and include with each entry the month and page number from the bottom of the page of the contest. In other words, you can send in multiple entries but you will need extra copies of the magazine so that you send an original page number with each entry.

This contest is invalid in states where local laws prohibit entries. Entrants must sign the declaration on the coupon that they have read the above rules and agree to abide by their conditions.

SHOPAROUND



ETI-1521 digital exposure meter

It's a long time since we did a photographic-type project, so this should please and surprise all the photo-hobbyists who read ETI. If you have any photo-hobbyist friends, show them this project — they might be interested.

Components for this project are all commonly available items, with the exception of the cermet calibration pot — but a little digging will get you one. Jaycar had some ('manufacturer's surplus') recently. The 74C926 counter is readily available from many suppliers. The Intersil ICM7225 can also be used. The Intersil ICL7660 supply rail inverter is imported by R&D Electronics and All Electronic Components of 118 Lonsdale St, Melbourne act as their retail distributor.

Kits will likely be supplied by Rod Irving Electronics in Melbourne and maybe All Electronic Components. You could also enquire from Altronics in Perth.

Film of the printed circuit and front panel artwork is obtainable from ETI-1521 Artwork, ETI Magazine, P.O. Box 227, Waterloo NSW 2017. Positive or negative film costs \$3.50 each for the pc board or front panel art, post paid (\$7.00 the pair).

ETI-678 Microbee ROM reader

This project will be carried in kit form by those firms giving hardware support to the Microbee. Try Altronics in Perth, Jaycar and Avtek in Sydney,

Rod Irving Electronics and Magraths in Melbourne. You might also try All Electronic Components.

If you're making your own pc board and want positive or negative film, you can obtain what you want for just \$1.60 post paid from ETI-678 Artwork, ETI Magazine, P.O. Box 227, Waterloo NSW 2017. Make sure you ask for positive or negative film, according to what your photoresist requires.

PCB outlets

Alf Capas of Better PC Boards in Bass Hill, Sydney (02)645-1241, has advised us that you

can now purchase ETI project pc boards, made by him, through Sheridan Electronics in Redfern and Geoff Wood Electronics in Rozelle.

Printed circuit boards

Almost every pc board (and most front panels) ever published by ETI may be obtained from:

All Electronic Components
118 Lonsdale St
Melbourne Vic 3000

For pc boards produced in recent years, the following suppliers either keep stocks on hand or can supply to order:

Jemal Products
P.O. Box 168
Victoria Park WA 6100

Jaetronics
58 Appian Drive
St Albans Vic 3021

Better PC Boards
112 Robertson Rd
Bass Hill NSW 2197
(02)645-1241

RCS Radio
651 Forest Rd
Bexley NSW 2207

Mini Tech
P.O. Box 9194
Auckland N.Z.

The following retailers generally keep stocks on-hand of pc boards from recent years' ETIs:

Rod Irving Electronics
425 High St
Northcote Vic 3070

Billco Electronics
Shop 2, 31 Pultney St
Dandenong Vic 2175

Jaycar
117 York St
Sydney NSW 2000

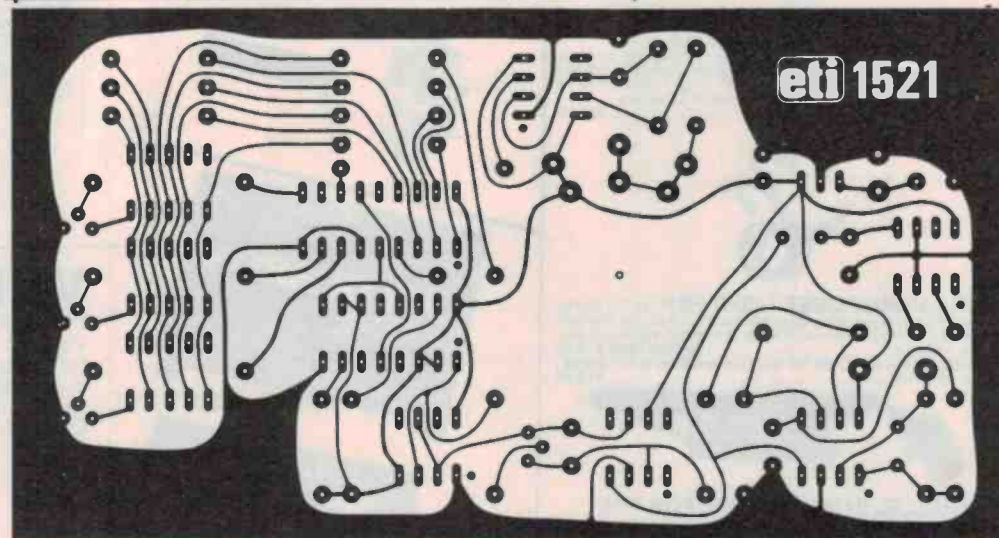
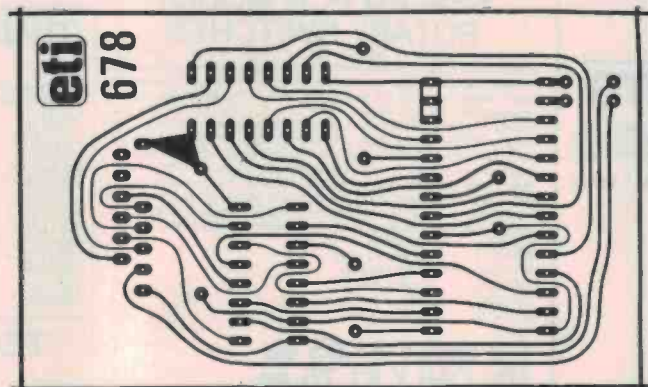
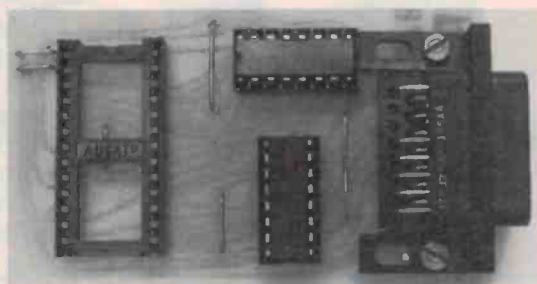

GREAT NEW PRODUCTS

60-KEY COMPUTER KEYBOARD

- AS USED IN THE FAMOUS MICROBEE!
- SPST CONTACTS
- FRAME MOUNTED - QUALITY UNIT
Cat. XE-3522

ONLY \$29.95



MINI BREADBOARD

Just the right thing for many small projects. This board has the same features as our larger breadboards but measures a compact 80 x 60mm. It has 420 holes. Perfect for the occasional project.
Cat. PB-8A08

ONLY \$6.95

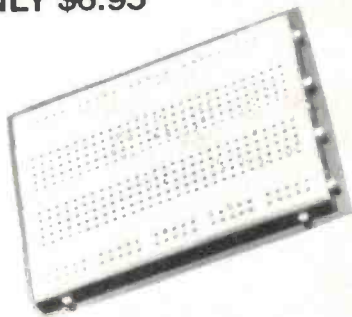

MICROBEE KITS

ETI 733 RTTY CONVERTOR. Ref. ETI April 1983
This simple project allows you to hook-up your MicroBee to a HF receiver and print radio teletype messages on a monitor screen. Listen to the world news FREE!
Cat. KE-4654.....

ONLY \$17.95



ETI 668 MICROBEE EPROM PROGRAMMER

Ref. ETI February 1983
This simple, low cost EPROM programmer just plugs into the Bee's I/O port and enables you to save programs in any of 5 different common EPROMs available (2716, 2532, 2732, 2732A, 2764). Kit comes complete with Personality plug and all IC sockets.
Cat. KE-4650.....

\$39.95



ETI 649 MICROBEE LIGHT PEN

Ref. ETI Aug 83
This simple, low cost device plugs into the Bee's 8 bit port. The "pen" gives you an entry into the world of light pens and interactive software.
Cat. KE-4656.....

SHORTFORM \$19.50

SPECIAL PROBE CASE TO SUIT (as specified in ETI article) Cat. HB-6400..... \$19.95



PARALLEL INTERFACE KIT FOR THE MICROBEE

Includes 15 pin D7 plug - add \$15 if Centronics plug required.
Cat. KE-7017.....

\$15.00

WHAT ARE STICKIES?

As you can see, "stickies" are stick-on templates. Attach the template to a panel (note the crosshairs for accurate alignment) and proceed to cut out a perfect hole! The plastic film also protects the panel from scratches while you are working on it.

Stickies are available for the common irregular hole cutouts i.e. Cannon DB-25, XL series chassis plug and socket and IEC-320 chassis (mains) plug.

Cat. No.

DESCRIPTION

Price	DESCRIPTION	
NL-4010	25 way 'D' template - Pkt of 6	\$1.95
NL-4014	XLR-31 series template - Pkt of 6	\$1.95
NL-4018	XLR-32 series template - Pkt of 6	\$1.95
NL-4020	IEC 320 chassis plug - Pkt of 6	\$1.95
NL-4024	DIN chassis socket - Pkt of 6	\$1.95



DID YOU MISS OUT?



Jaycar's brand new 1984 Catalogue appeared as an insert in this magazine. If it has gone it has been stolen!

If you want one (or another one) simply send \$1.00 for postage to the address below.

SEALED PCB MOUNT ROTARY SWITCHES

We have decided to discontinue our range of open "skeleton" switches for these. The new switches have contacts enclosed in a fully molded plastic housing - reminiscent of European design rotaries. The silver plated contacts are terminated with PCB pins instead of the usual eyelet. You can solder to the pin, of course, but the pin also inserts straight into the PCB. Another feature of the switch is its programmability. A removable ring with tab can be inserted into the switch several ways to fit your particular requirements. For example, if you purchase a 1 x pole 12 way (max.) switch you could convert it to, say, 1 pole 7 way between stops. Versatile! Naturally the switches feature 4x32 TPI bush mount and a 1/4" shaft with standard flat. The shaft is hard nylon moulded to help reduce signal capacitance problems. They are almost the same price as the inferior wafer units.

Cat. No.	Description
SR-1210	1 pole x 12 way
SR-1212	2 pole x 6 way
SR-1214	3 pole x 4 way
SR-1216	4 pole x 3 way
SR-1218	6 pole x 2 way

1-9 ONLY \$1.95 ea

10« ONLY \$1.75 ea



TRADE PACKS OF SCREWS & NUTS etc.

By popular demand! Now you can get commonly used hardware in bulk and save a fortune!

Cat. No.	DESCRIPTION	Price
HE-0736	Rubber feet stick-on 12mm Pkt 100	\$9.60
HE-0738	Rubber feet stick-on 20mm Pkt 100	\$11.50
HE-0913	TO-3 Mica insulator kit Pkt 100	\$12.50
HE-0922	TO-220 Mica insulator kit Pkt 100	\$9.80
HP-2742	6BA Flat washer Pkt 500	\$6.95
HP-2752	4BA Flat washer Pkt 500	\$6.95
HS-1521	6BA 1/2" Cheesehead screw Pkt 500	\$7.50
HS-1522	4BA 1/2" Cheesehead screw Pkt 500	\$5.95
HS-1527	4BA 1/2" Cheesehead screw Pkt 500	\$6.95
HP-2712	6BA Hex nut brass Pkt 500	\$12.50
HP-2722	4BA Hex nut brass Pkt 500	\$12.50
HS-1607	No.4x1/4" Self tappers Pkt 500	\$4.50
HS-1609	No.4x1/2" Self tapper Pkt 500	\$5.50

TECHNICIANS LIGHT PROBE

This NZ made unit enables you to place a spot of bright light in the most awkward places. Ideal for servicemen or kit assemblers. A flashlight or lamp always seems to cast a shadow where you need to see! The exclusive design allows you to "poke light" around corners! The unit is solidly made (Aluminium) and takes two 9v night cells. A two function switch (lock-on and press-on) is also a feature.
Cat. TH-1838

ONLY \$12.95



WILDCARDS II

Volume One

A premium of application notes and tips for the Microbee Personal Computer

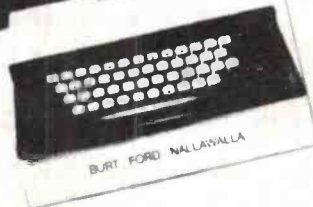

WILDCARDS II

This book is the sequel to Wildcards Vol.1. It contains much, much more information and a memory map of 7 pages. If you liked the first volume you're going to love the second even more.

Cat. XE-8016..... **\$16.00**

ETI644A

See ETI Jan '83!

DIRECT CONNECT MODEM NEW MODEL

Ref. ETI October 1982

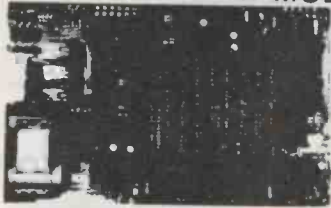

Two models (i) Short form which contains ALL PCB components as specified by ETI (BEWARE!). The genuine ETI PCB with plated-thru holes, solder mask and component overlay is supplied. We also supply at NO EXTRA CHARGE a full set of quality IC sockets. A must with plated-thru PCB - remember this when making comparisons.

(ii) Full kit. Includes: all of the above plus 12V plug-pack, case, switch and LED bezel and Cannon DB-25 RS-232 connector. Makes a complete stand-alone modem. ● Capable of a range of Answer/Originate operating modes ● Selectable Baud rate ● Software controlled ● Uses new patented technique ● More reliable and faster than most acoustic modems. Airtel transformer as used in this project only \$22.00

SHORTFORM KIT
Cat KE-4600

COMPLETE KIT
Cat KE-4601

ONLY \$169

ONLY \$199

**LESS FEBRUARY SPECIAL
DISCOUNT OF 10%**



DIGITAL DELAY LINE KIT

The Digital Delay Line is designed to produce a huge variety of electronic effects. It works very well but the amazing thing is the low, low price! The effects depend on the time delay selected and some of those included are: Phasing, Flanging, Chorus, ADT (Automatic Double Tracking), Echo, and Vibrato. The delay time can be varied from 0.32ms to 1.6 seconds! Because the signal is stored in digital form there is, unlike analog systems, no degradation of the signal with time and unlimited repetition is provided by use of the freeze control. All the controls mount directly upon PCBs to eliminate wiring and to further simplify construction the main board is plated-thru! i.e. there are no wire links or link-thru pins. The whole of the memory whether for the basic 400ms machine or the fully expanded 1.6 second model all fits on the main board. The cabinet which is free standing but also suitable for 19" rack mounting, is fully finished to a very high standard. The panel is deep blue whilst the cover is sprayed with a durable black enamel. The kit is available for only \$449 - compare with inferior units that can cost over \$2,000!
Cat. KJ-6621

**COMPLETE 400MS VERSION
ONLY
\$449**

30W « 30W Stereo pre-amp STEREO AMPLIFIER

- Fully built and tested
 - Separate bass, treble, balance and volume controls
 - Less than 0.1% distortion
 - Mic, phono and aux. inputs (line)
 - Power supply components on board
- Back at last! No hassle amplifiers. Just connect a transformer, speakers, a signal and you're away!

ONLY \$34.95

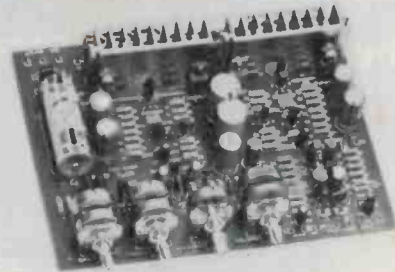

SYNTOM

Original design from the U.K. magazine "Electronics and Music Maker" April 1981. Self-contained unit produces a variety of fixed and falling pitch effects. Trigger by tapping the unit itself or by striking the drum to which the unit is attached. The Jaycar "SYNTOM" comes complete with high quality pre-drilled moulded all ABS box 152 x 80 x 47mm with professional silk-screened front panel. FEATURES: Decay from less than 0.1 second to several seconds, pitch control, sweep control and volume on/off. Cat. KJ-6502

ONLY \$36.50

INFRA RED DIMMER KIT

\$25.95

Ref. EA January 1984
Now you can dim or turn off the lights from the comfort of your armchair!
Short form kit contains all parts for IR kit. Note this must be used with a Jaycar KA-1509 Touch Sensitive Dimmer (\$19.95)
Cat. KA-1530



VK POWERMATE NEW MODEL ONLY \$89.95



Ref. EA December 1982
Get up to 13.8V @ 10 amps to run those mobile rigs at home! The Jaycar kit is complete.

IONISER KITS COMPLETE KIT

- High efficiency emitter head - Fits completely inside a high quality ABS box (NOT a metal lid) - Only 2-core mains flex protrudes from the box - You can pay over \$80 for a built-up inferior unit!
Cat. KJ-6511

ONLY \$45

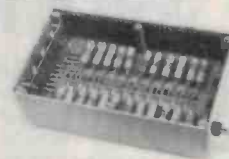

50V/5A LABORATORY POWER SUPPLY

Ref. EA May/June 1983
Cat. KE-1520

\$149

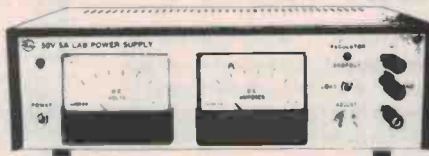

SHORTFORM KIT

- runs directly from 240V mains
- low power consumption
- produces high intensity electric field
- output around 7.5kV
- will not necessarily produce ozone in standard form
- Ideal for those who wish to 'try' an ioniser at an economical price.

ONLY \$24.50

Cat. KJ-6510

CENTRONICS PLUG 36 WAY

Cat. PP-2420

\$14.95



Jaycar

Incorporating
ELECTRONIC AGENCIES

SYDNEY SHOWROOMS

117 YORK STREET - PHONE: (02) 264 6688 and (02) 267 1614

CARLINGFORD TELEX: 72293

Cnr. CARLINGFORD & PENNANT HILLS ROAD - PHONE: (02) 872 4444

CONCORD

115 - 117 PARRAMATTA ROAD - PHONE: (02) 745 3077

HURSTVILLE 121 FOREST ROAD - PHONE: (02) 570 7000

NUMBER 1 FOR KITS

POST AND PACKING CHARGES

\$5 - \$9.99 (\$1.50) \$10 - \$24.99 (\$3.20)

\$25 - \$49.99 (\$4.50) \$50 - \$99.99 (\$6.50)

\$100 - \$199 (\$8.00) Over \$199 (\$10)

Free INSURANCE for Road & Registered Post over \$200

All heavy or bulky items (over 20kg) sent Comet Road Freight \$12.00 anywhere in Australia.

SHOP HOURS CARLINGFORD, CONCORD & HURSTVILLE

Mon - Fri 9am - 5.30pm; Sat - 9am - 12pm; Thurs night 8.30pm

SHOP HOURS SYDNEY

Mon - Fri 8.30am - 5.30pm; Sat - 8.30am - 12pm; Thurs night 8.30pm

MAIL ORDERS AND CORRESPONDENCE: P.O. Box 185, Concord, 2137



Mail Order

By



BANKCARD

Via Your Phone

CHECK OUR CONCORD STORE FOR SATURDAY AFTERNOON TRADING IN FEBRUARY

The National VP-5512A Pana Scope.

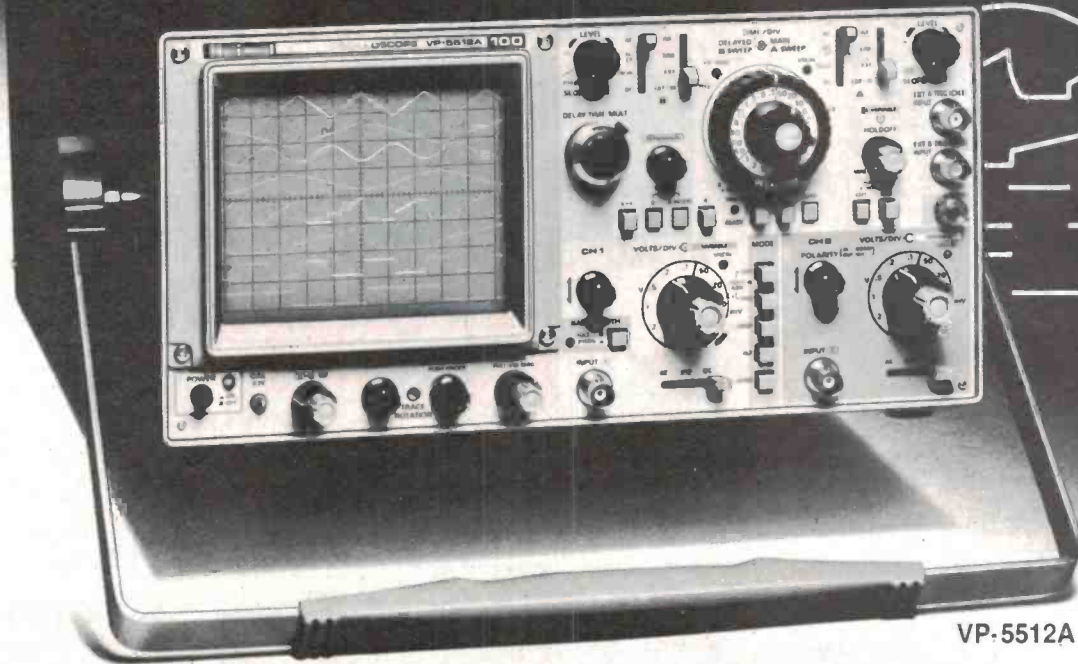

VP-5512A

We increased the range to 100MHz, the channels to 4 and the trace to 8, but you'd never know it from the price.

A Scope that does more and tells more

Here, for the bottom liner, is a scope that really performs! You get your 100MHz with an alternate sweep function in a compact package. You get a 4-channel, 8-trace format so that a large number of signals can be simultaneously observed with ease. And you not only watch 4 different kinds of waveforms at the same time but you also get measurements of phase differences in signals and their timing.

Features galore in a unit you can trust

And that's not all. Listen to these outstanding features: an Auto-Fix circuit for easy triggering, a National exclusive; bright, clear waveforms on an advanced domed-mesh CRT, a National speciality; 2mV/DIV sensitivity; 2 nSec/DIV maximum sweep rate; $\pm 2\%$ time axis accuracy; a TV sync separation circuit for video signals; variable hold-off function for trigger stabilization; alternate triggering; drift compensation; and more.

Ideal for lab, line or field service

You also get that world renowned National reliability in every National oscilloscope. We have, for example, reduced parts by one-quarter, which means, of course, less wiring and less failures. We have installed glass epoxy circuit boards which have far greater resistance to shock and heat. There is also a 15,000-hour MTBF (Mean Time Between Failures) rate, certainly one of the finest in the industry.

So the next time you're looking for a reliable scope that's been fully upgraded in range, channels and trace—everything, in fact, except price—remember the VP-5512A Pana Scope. From National.



VP-5234A

- DC-40MHz.
- 15,000 hours MTBF.
- Triggering waveform on CH 3.
- Auto-Fix and Hold-Off control.
- Delayed sweep.
- Alternate triggering function.
- TV sync separation circuit.



VP-5256A

- DC-60MHz.
- 15,000 hours MTBF.
- Alternate sweep function.
- Auto-Fix and Hold-Off control.
- Alternate triggering function.
- Triggering waveform on CH 3.
- Domed-mesh CRT with illuminated internal gratitudes.



**SCIENTIFIC DEVICES AUSTRALIA
PTY. LTD.**

2 JACKS ROAD, STH OAKLEIGH 3167. PHONE: 579 3622
31 HALSEY ROAD, ELIZABETH EAST, S.A. 5112. PHONE: 255 6575
35 - 37 HUME ST., CROWS NEST., N.S.W. 2065 PHONE: 43-5015

National

MELBOURNE READER WINS SCANNER CONTEST



David Paxton of North Ringwood, an outer Melbourne suburb, won the SX-200 Scanner Contest featured in the October issue last year. He correctly answered the five questions and wrote what was judged to be the best 'essay' on what features of the SX-200 attracted him.

David is 22 years old and works as a Technical Officer with Telecom. He was delighted to receive the prize as he said he'd never won anything before!

The picture shows David (standing) accepting his prize, an SX-200, from Greg Whiter, proprietor of GFS Electronic Imports, who kindly donated the prize.

On his entry form, David said, "The SX-200's versatile scan and squelch modes, extensive frequency coverage, FM and AM detection and simple operation are features guaranteed to make scanning a pleasure".

David says his interests are computers and, recently, ham radio. He said scanning is a new interest which is the reason why he entered the contest.

For those still puzzling over the five questions, here are the answers.

The world's first radio patent was applied for by Guglielmo Marconi in June, 1896. The first 'radio' apparatus installed by the British Wireless Telegraph and Signal Co. was installed in the Kaiser Wilhelm der Grosse. Martin, Barton and Fargo did not invent the transistor, it was Shockley, Bardeen and Brattain. Australia's WT Act was passed into law in 1905.

Thanks to the hundreds of enthusiastic contestants who made the contest such a success. Keep your eyes peeled for another exciting contest.

RF & COMMUNICATIONS SOFTWARE DESIGN

Technical Imports has released three 'design kit' software packages for the analysis and optimization of RF performance, PLL characteristics and communication-circuit design.

Each design kit comprises several computer programs for electrical engineering applications, available and tested on both the Tektronix 4050 Series of graphics desktop computers and the HP 9800, 200 and 9000 Series.

Each package contains program functions for universal mathematical function plot and frequency selection for minimum IMD products in mixers.

The RF design kit contains a program for optimization of noise figure or intercept point of cascaded amplifiers, mixers and filters. The PLL design kit has a

program for optimization of type-2, 2nd, 3rd and 5th-order loops and one for general analysis of PLL circuits.

The communications design kit includes program functions for complex impedance of electrically short antennas, digital filter design and antenna spray patterns with driven elements.

The kits are intended to give the designer a better understanding of circuit functions and produces computed results of circuit analysis and optimization in the form of tables and graphical plots.

Prices start from around \$2000 per kit, with individual programs available for less than \$1000.

For further information, contact Technical Imports Australia, P.O. Box 176, Crows Nest NSW 2065. (02)922-6833.

NOISE FIGURE MEASUREMENTS

Hewlett-Packard's new application note AN/57-1 *Principles of RF & Microwave Noise Figure Measurement* is now available for all those working on device, component, sub-system and system noise figure. It replaces the long-popular AN/57, *Noise Figure Primer*.

The 40-page note serves as a comprehensive tutorial on noise figure for the neophyte engineer with detailed material on thermal and shot noise, concepts of noise figure, effective noise temperature, Y-factor, etc.

The experienced engineer also will find plenty of useful information on subtle measurement considerations including single-sideband vs double-sideband, effects of local oscillator noise, second-stage effects and corrections, hot/cold techniques, frequency conversion and image considerations.



An extensive glossary includes common symbols and detailed technical explanations of most terms. Also included is a bibliography of 34 other noise-figure related references. AN/57-1 (Pub. No. 5952-8255) is available at Hewlett-Packard sales offices free of charge.

ECONOMICAL UNIVERSAL COUNTER



Hewlett-Packard's new HP 5334A universal counter, priced less than \$4000, offers new performance and measurement capabilities for a counter in this price class, says the company.

A major feature is that it allows users to measure frequency, period, rise time, fall time, pulse width and peak-to-

peak volts — all the fundamental waveform parameters — automatically, at the touch of a button.

Auto trigger and auto attenuation further simplify measurements, while internal storage of up to 10 complete front-panel setups speeds and simplifies operation.

HP-IB, included as standard

equipment, allows automatic operation with a computer or other instrumentation.

Key instrument features include two-channel, 100-MHz capability; 9-digits-per-second resolution; two nanosecond, single-shot time interval and keyboard-selectable gate times in millisecond increments, from one millisecond to 99.99 seconds.

In addition to performing the standard counter measurements of frequency and time interval, the HP 5334A includes period, ratio and totalise measurements plus external arming capabilities. Options include a high-stability oven oscillator, a 1000 V floating DVM and a 1.3-GHz C channel.

Full details available from your local Hewlett-Packard office.

MICROWAVE PHASE NOISE

Hewlett Packard's Product Note 11729B-1, 'Phase Noise Characterization of Microwave Oscillators (Phase Detector Method)', presents an overview of the importance of phase noise in microwave devices and systems and compares several common measuring techniques with emphasis on the phase-detector method.

The note describes specific operational features of the HP 11729B carrier-noise test set for measurements on sources from 5 MHz to 18 GHz. The HP 11729B turns a relatively complex and subtle measurement procedure into a high-confidence routine exhibiting a noise floor of -123 dBc/Hz at a 10 kHz offset in X-band.

Specific topics include: multiplier chains, downconversion considerations, various phase-lock methods, system calibration and correction, accuracy considerations, loop noise suppression, and the use of the HP 11729B in fully automated test systems.

Five technical appendices expand on earlier material and a 10-reference bibliography is given. Product Note 11729B-1 (Publication 5952-8286) is available free of charge from Hewlett-Packard sales offices.

WOMAN AMATEUR OPERATOR HONoured BY CLUB

Evelyn Bahr, has been honoured with Life Membership of the Townsville Amateur Radio Club in recognition of "her outstanding services to amateur radio".

Evelyn Bahr (VK4EQ) obtained her Amateur Operator's licence in the mid-1950s and then went on to become the first-ever female member of the

Townsville Amateur Radio Club. She has remained an active participant in Club activities ever since.

One of her first official positions was as Club Treasurer during 1974. She became co-editor of the Club magazine 'Backscatter' in March 1975, but soon took over full editorial responsibility and has continued in the

position until the present day.

She has been net co-ordinator for the Club station VK4WIT for the Sunday evening news broadcasts throughout North Queensland for a number of years and also participates in the activities of the Wireless Institute Civil Emergency Network.

JIL SX-200

COVERS 26-88 MHz & 108-180 MHz & 380-514 MHz



GFS Electronic Imports
17 McKeon Road, Mitcham, 3132, Vic.
Telex 38053 GFS. Phone (03) 873 3777

A BETTER SCANNING MONITOR RECEIVER.

Monitors over 33,000 frequencies from 26 to 88 MHz, 108 to 180 MHz and 380 to 514 MHz. Bands included within this range are HF and UHF CB, 27 and 155 MHz MARINE, Australian LOW BAND, AIRCRAFT band, VHF SATELLITE band, 10 Mx, 6 Mx, 2 Mx and 70CMx AMATEUR BANDS, VHF High BAND as well as UHF two-way band.

Mechanically rugged the SX-200 uses high quality double-side Epoxy-Glass printed circuit boards throughout. Some of its other outstanding features include 3 MODE SQUELCH circuitry which allows the lockout of spurious and carrier only signals, extremely low spurious count, AM and FM detection on all bands, FINE TUNING control for off channel stations, 240 VAC or 12 Volt DC operation, Accurate QUARTZ CLOCK, Squelch operated OUTPUT for switching a tape recorder etc, 16 Memory channels, MEMORY BACKUP, which lasts up to two years, high SENSITIVITY and SIGNAL-TO-NOISE ratio on all bands, CRYSTAL FILTER for excellent SELECTIVITY and easy servicability due to component layout as well as a 90 day warranty.

Its high quality and performance is testified by the fact that it is in use by a large number of State government and Federal bodies including most state and federal police departments. Contact GFS, the Australian Distributors, or our interstate outlets for full technical specifications. We also market a range of pocket scanning receivers and transceivers. Contact us for full details.

PRICE \$599 INC. S.T. + \$12 P&P; SERVICE MANUAL \$12 + \$1.50 P&P; SCAN-X BASE ANTENNA \$62 + \$10 P&P; EXP-32-32 CHANNEL MEMORY EXPANDER KIT \$53 + \$5 P&P; A4-AM AUTO AM KIT FOR AIRBAND \$32 + \$5 P&P; CVR-1B CONVERTER 225-380 MHz \$199 + \$5 P&P; CVR-2 CONVERTER 5-26 MHz \$189 + \$5 P&P; LOG S DIRECTIONAL ANTENNA 100-520 MHz 9el \$89 + \$10 P&P; LOG-SP DIRECTIONAL ANTENNA 65-520 MHz 13el \$125 + \$10 P&P; INTERSTATE DEALERS: NSW: (02) 211 0531; QLD: (07) 397 0808; SA: (08) 269 4744; WA: (09) 328 4160; VIC: (03) 329 7888

HIGH QUALITY BUDGET-PRICED HAND HELDS



- LOW BAND VHF
- HIGH BAND VHF
- UHF

- Light, small and ruggedly constructed
- 12 months warranty
- Choice of operating bands and RF output power
- 6 channel simplex or semi duplex operation
- Complete with rechargeable nicad battery pack, wall charger, vinyl case, earpiece and shoulder strap
- Full range of accessories available
- All models D.D.C. approved
- Vicom hand helds - for crisp, clear communications

Regency Scanners Touch M400

Hear all the action on 30 channels covering over 15,000 frequencies. At home or on the go.

Ring and enquire about our full range of synthesised and crystal locked scanning receivers - at prices that cannot be beaten!

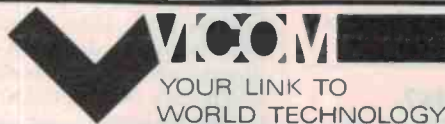

VICOM INTERNATIONAL PTY. LTD.
Melbourne: (03) 62 6931 Telex AA36935 PROVIC
Sydney: (02) 436 2766 Telex AA70619 PRONSW

**BELOW
MANUFACTURER'S
COST!!**

CAR COMPUTER - PRICE SLASHED!

**ONLY
\$125
COMPLETE**
MASSIVE SAVING
OF \$74



Mail Order By
BANKCARD
Via Your Phone

FULL 90 DAY WARRANTY

At \$199 the Voyager Car Computer represented absolutely outstanding value for money. No one else had such a low priced, **FULL FUNCTION** car computer. The Voyager is the only low-cost unit that will give you full consumption (the most important feature in a car computer) in both metric litres/100km AND good old MILES PER GALLON!

At \$199 many, many hundreds have been sold. **NOW** you can grab one absolutely complete for only \$125 - a saving of 37% or \$74!

The Voyager comes absolutely complete with all fitting hardware - even down to a roll of insulation tape! Installation generally takes between 4 and 6 hours depending on vehicle.

or by mail order to:
Jaycar
Box 185
Concord 2137

Jaycar Sydney (City) 264 6688/267 1614
Jaycar Concord 745 3077
Jaycar Carlingford 872 4444
Jaycar Hurstville 570 7000
Zap Electronics Parramatta
Hornsby

Rod Irving
Melb A'Becket St
Northcote
Altronics Perth (03) 347 9257
(03) 489 8131
(09) 328 1599

Spare Flow Sensors: Jaycar will be supporting this product for many years to come. To avoid problems changing cars, why not buy a spare fuel flow sensor? They are about the only things that wear out

Cat. XC2036
ONLY \$29.50

AS REVIEWED
OCT '82
EA (p.26-28)
ETI NOV '82 (p.26)

CAT. XC2010

**NEW IMPROVED
MODEL!**

VOYAGER OPERATING FEATURES

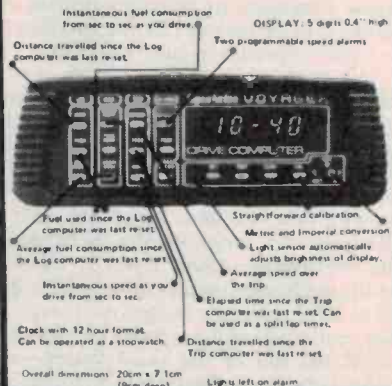

Transequatorial VHF propagation and equatorial plasma bubbles

Massive depleted zones in the equatorial ionosphere, stretching in field-aligned interhemispherical arcs, have been observed experimentally in recent years. Theoretical explanations of the gross features have been put forward. This paper argues the case for collecting a further round of experimental data and outlines a low-cost way of using VHF trans-equatorial propagation, available to radio amateurs, to study behaviour patterns of individual equatorial plasma bubbles.

1976 WAS A YEAR of good vintage for equatorial aeronomy. It brought with it the first reports of so-called equatorial plasma bubbles, and with them the basis of the new way of thinking about irregularities in the equatorial ionosphere. The classic account was given by Ron Woodman and Cesar La Hoz (1), where they present records showing rising plume-like structures in the equatorial ionosphere recorded on the 50 MHz radar at Jicamarca in Peru. The radar, operating in the conventional mode of power return from a range-gate, receives echoes from ionospheric irregularities having a scale size of three metres. A sketch of one of their records is shown in Figure 1 where the vertical axis has been converted from pulse time-delay into height. The horizontal axis is more complicated. It is like the photo-finish record at the Cluden race-course (Qld), where the film moves past a slit at the expected speed of galloping horses. Here the moving record assumes that the ionospheric plasma is galloping eastwards at 125 metres/second, which is about average for the early evening. On this basis a conversion from a distance of 450 km gives a time lapse of one hour. The plume structures are therefore drifting eastwards at more or less 125 m/s and they rise to higher altitudes as time progresses.

The next significant revelation was the data of McClure, Hanson and Hoffman, working at the University of Texas at Dallas, who published some results in 1977 taken from ion density probes on board the equatorial orbiting satellite AE-C (2). This satellite flew in a near equatorial orbit and showed a wide range of holes, or bubbles, in the ionospheric plasma typically 100 km in width and having plasma density reduced by 10 to 1000 times the background level. The fact that many of these holes rise up engendered the use of the word 'bubbles' and indeed the theory has been developed often with the aid of the analogy with air bubbles in water.

M. L. Heron

Physics Department, James Cook University of North Queensland, Australia

Bananas or spheroids?

One thing that the theoreticians are agreed upon, in a maze of general uncertainty about bubble growth, is that the bubbles must faithfully extend along the magnetic field lines right across the equator as depicted in Figure 2. This must be so, because diffusion time constants parallel to the magnetic field in the ionosphere are much less than a second, whereas horizontal drifts and vertical rises across the field (Figure 1) are measured in tens of minutes.

The concept of elongated bubbles has been verified experimentally by Dyson and Benson (3) and by Heron and Dorling (4). Peter Dyson, a Melbournian, has even dared to suggest that the word "bananas" be used to describe the bubbles. In his defence it should be said that the banana image needed to be argued to dispell the false concept of oblate spheroids as in air-in-water bubbles. And this shape question has most important consequences in transequatorial VHF propagation.

Symbiosis of theory and experiment

Before we think about propagation, interference and the rash of transequatorial two metre QSOs, we should note the interaction to and fro between theory and experiment.

Very quickly after the initial experimental data, a flurry of theoretical modelling and prediction began (5, 6) so that now, some three years later, we have models of fully field-aligned depletions in plasma density, moving upwards (at the equator) as time proceeds and drifting eastwards (7). In fact, the theories have predicted more than the currently known observations and since they don't all agree it is now the experimenters' turn for the next move.

Specifically, we need to have observations of the growth and decay of individual bubbles to be able to test the theoretical time histories, and also we need more observations of the ionospheric conditions which allow bubbles to form on some nights but not on others.

One approach which allows a path for interaction between theory and experiment was the numerical modelling by the author and Leo McNamara of the Ionospheric Prediction Service in Sydney (8). The idea was to treat individual bubbles as ducts for radio wave-guiding so that if a transmitter (at VHF) had a line-of-sight access to the end of a bubble then energy may be directed into a certain prescribed geographical region in the other hemisphere. A "best model" for the bubble cross-section, height above the equator, plasma densities, and velocities both upwards and eastwards was synthesized from the most reliable theories and experiments and a numerical study of the possible transequatorial propagation paths was done on the NOAA CDC-6600 computer in Boulder, Colorado in 1978.

The resulting parameters of frequency dependence, latitude dependence and Doppler shifts agreed well with the published record of transequatorial propagation and gave some confidence to the assertion that VHF transequatorial propagation in the evening is via these bubble waveguides. While relative powers on the TEP link agreed with observations, the absolute power levels predicted by this numerical model were far too high. Clive Winkler of DSE at Salisbury is following this up by applying some concepts of wave-guiding in optical fibres (9).

Where from here?

We have enough accumulated wisdom to be able to take another step. Let's reiterate:

(i) the plasma bubble phenomenon was discovered experimentally;

(ii) theoretical studies have explained the

general formation of bubbles but do not agree too well about the growth and movement;

(iii) numerical models relate VHF transequatorial propagation to bubbles.

The next step is to use VHF transequatorial observations to shed light on the detailed growth and movement of individual bubbles. This will allow the theoreticians to go through another cycle of refinement. Ultimately one would hope that the phenomenon and its ramifications in communications will be understood to the point where it is predictable — at which point we can use it (TEP contacts), abuse it (intertropical interference), or avoid it (VHF scintillation on satellite communications) as we see fit.

The role of the amateur

Amateur radio operators on the two metre band have already made a contribution to the development of ideas which form the current knowledge of equatorial plasma bubbles. The transequatorial QSO reports, for example, support the banana shape and also indicate the integrity of the bubbles right across the interhemispheric connection, as opposed to the idea of unconnected 'spread-F' or "scintillation" irregularities. QSO logs have enabled some degree of evaluation of the size of the conjugate region typically available for potential two metre contacts.

On a limited study (we would like more QSO logs) it seems that a receiver within 1000 km of the magnetic conjugate point of a transmitter on two metres has some chance of a contact. The conjugate point needs to be accurately calculated from magnetic field tables rather than from any dipole model.

Jurgen Rottger of the Max-Planck Institut für Aeronomie in West Germany has produced some graphs of S-meter readings plotted against time every minute by SVIAB in Zimbabwe-Rhodesia and ZE2JV in Greece during contacts.

The two metre transequatorial openings lasted typically 40 minutes to one hour which agrees reasonably well with the concept of moving ducts. An important implication is that some properties of individual bubble waveguides can usually be observed without interference from nearby bubble structures. Occasionally, a double-peaked power curve suggested closely spaced ducts.

Such power level graphs and even QSO reports alone are useful for basic statistics but the potential for involvement of radio amateurs on two metres now extends further. There is the possibility of using direction-finding techniques to locate the point on the base of the ionosphere where the interhemispheric duct terminates. If the bubbles do indeed move eastwards and do rise upwards at the equator whilst remaining field-aligned, then the duct termination should move eastwards and appear higher and higher above the horizon. Observations of azimuth and elevation angle of arrival at one minute intervals are required to check

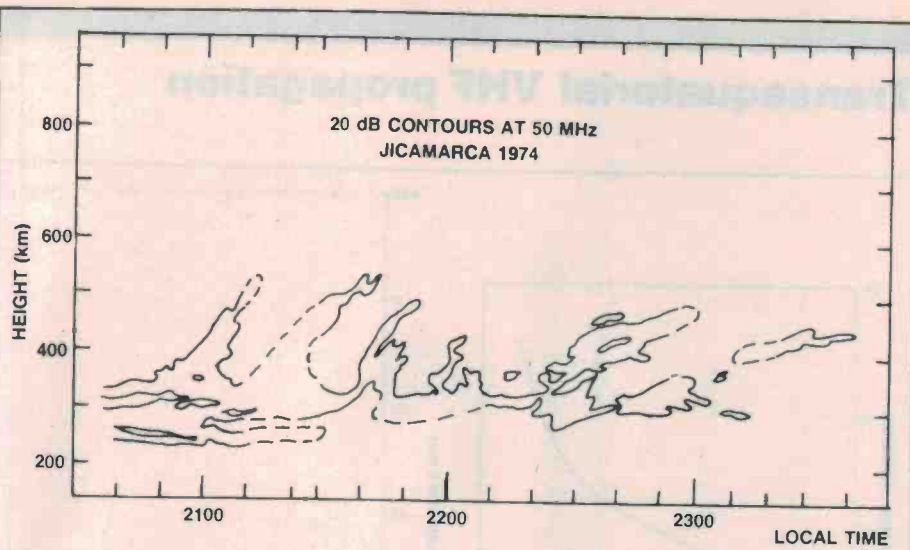

Figure 1. 20 dB contours of the backscatter power from small scale F region structure on the 50 MHz Jicamarca radar. The broken lines are interpolated sections. After Woodman and La Hoz (1976).

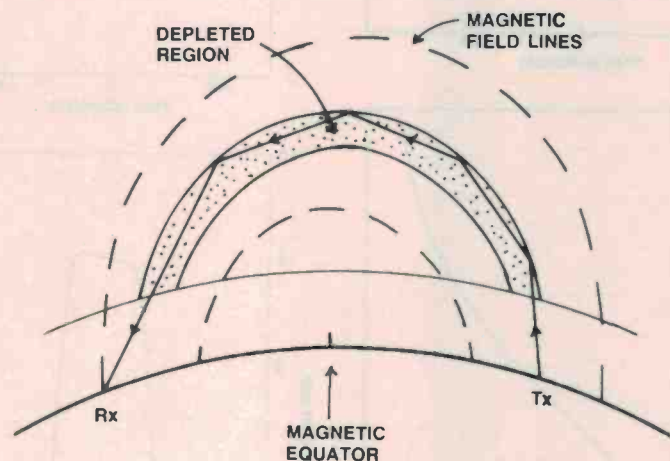
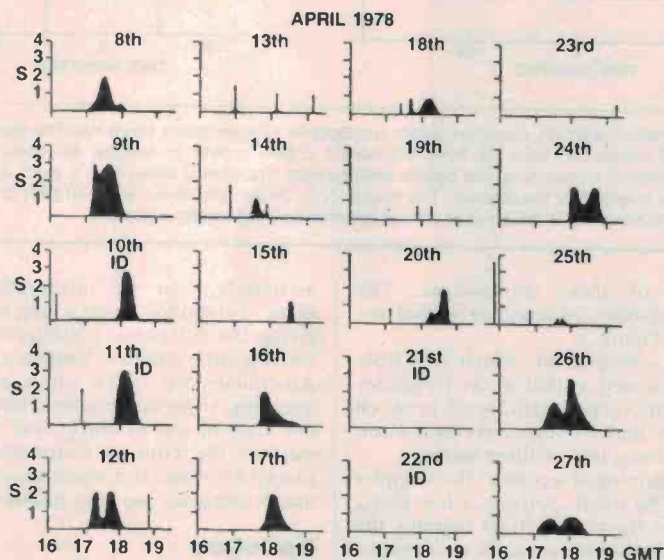

Figure 2. The wave-guide structure of the field-aligned inter-hemispheric equatorial plasma bubbles.



Signal strengths versus time, 144 MHz. Jurgen Rottger's graphs of S-meter readings of reception from the ZE2JV beacon (144.118 MHz) at Salisbury, South Africa, by 5B4WR at Limassol, Cyprus, during April 1978. Double-peaked curves suggest closely-spaced ducts moving through the path.

Transequatorial VHF propagation

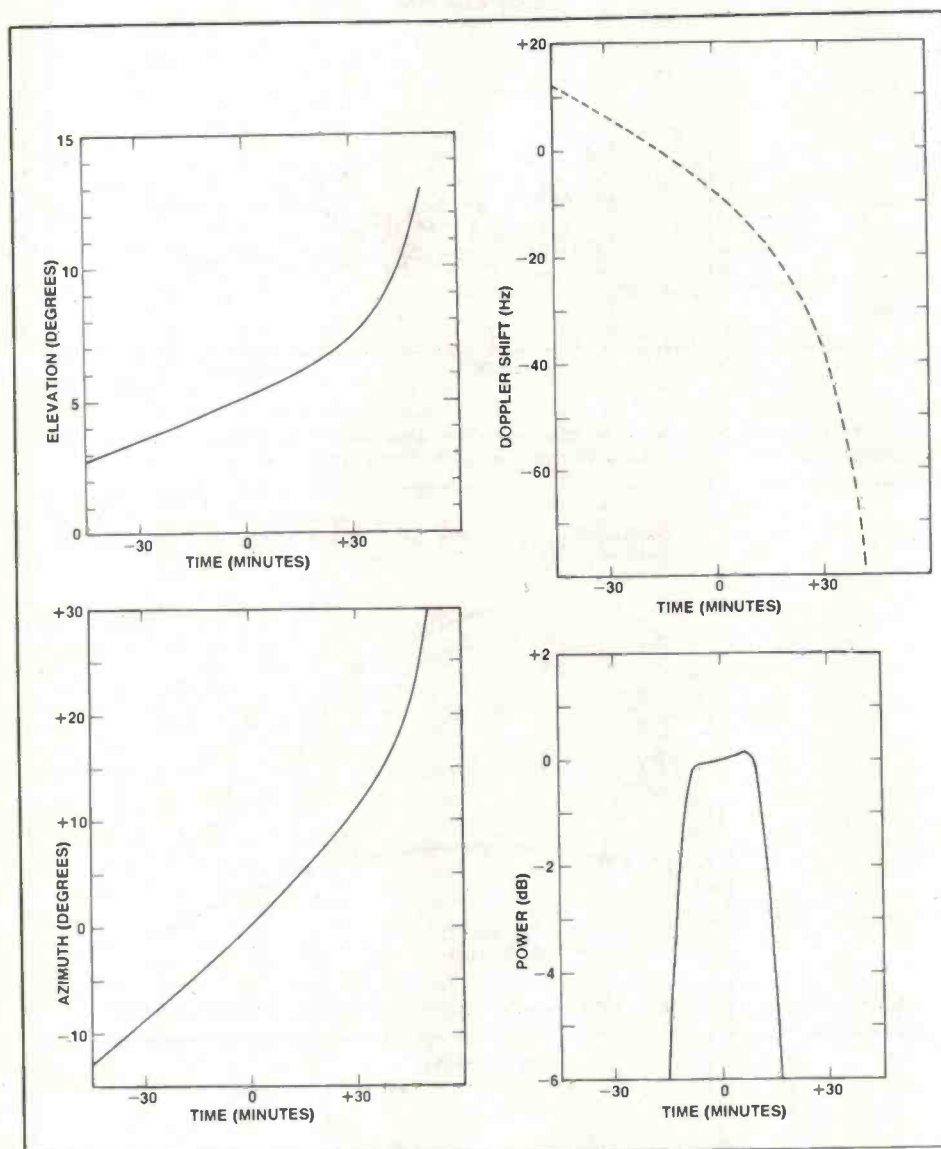

Figure 3. The type of azimuth, elevation, power and Doppler shift variations which might be observed from a conjugate VHF transmitter. Here we have assumed a bubble growth; in practice we would go from the observed parameters to specifying the bubble development. The time is taken from a zero value when the bubble is at the longitude of the receiver. The frequency for these calculations was 100 MHz and the bubble was assumed to be rising at the equator with an exponentially increasing velocity.

the theory of these movements. The expected variations of angle of arrival are indicated in Figure 3.

A further observation, which is a little more sophisticated, is that of the frequency shift due to the varying path length between a transmitter and conjugate receiver communicating along one of these ducts.

At the beginning of a contact the Doppler shift should be small, perhaps a few Hertz positive, and then over 30-40 minutes the Doppler shift should normally go negative to several tens of Hertz, if the theoretical dynamics are anywhere near correct.

The four observations of elevation, azimuth, frequency shift and power, if made

accurately, can be interpreted via the numerical models to go a long way towards giving the behaviour patterns of the equatorial plasma bubbles. Unfortunately, many Australians are too far south, magnetically speaking, to be in the action, but the Northern half of the country, and particularly west of the Gulf of Carpentaria, is well placed for Asian conjugate stations. Darwin and Yamagawa are very nearly conjugate.

Epilogue

It is interesting to speculate on two points. One is that this phenomenon was due for a rapid development because of technological moves. If the two metre activity explosion

had occurred before the last sunspot maximum then the discovery of the propagation mode may well have been made by radio amateurs. The second point is a challenge. The Jicamarca record shown in Figure 1 clearly shows the bubble phenomenon. It was made in 1974, very near sunspot minimum. Are we kidding ourselves that the two metre path through equatorial plasma bubbles is restricted to high sunspot epochs?

REFERENCES

1. Woodman, R. F. and C. La Hoz (1976), *Radar observations of F region equatorial irregularities*, J. Geophys. Res., 81 5447-5466.
2. McClure, J. P. W. B. Hanson and J. H. Hoffman (1977), *Plasma bubbles and irregularities in the equatorial ionosphere*, J. Geophys. Res., 82, 2650-2656.
3. Dyson, P. L. and R. F. Benson (1978), *Topside sounder observations of equatorial bubbles*, Geophys. Res. Letters, 5, 795-798.
4. Heron, M. L. and E. B. Dorling (1979) *Equatorial ionospheric plasma density bubbles observed by ESRO-4*, preprint Mullard Space Science Laboratory, University College London.
5. Chaturvedi, P. K. and S. L. Ossakow (1977), *Nonlinear theory of the collisional Rayleigh-Taylor instability in equatorial spread F*, Geophys. Res. Letters, 4, 558.
6. Chaturvedi, P. K. and S. L. Ossakow (1979), *Nonlinear stabilization of the E x B gradient drift instability in ionospheric plasma clouds*, J. Geophys. Res., 84, 419-422.
7. Anderson, D. N. and G. Haerendel (1979), *The motion of depleted plasma regions in the equatorial ionosphere*, preprint, Space Environment Laboratory, NOAA, Boulder Colorado 8030.
8. Heron, M. L. and L. F. McNamara (1979) *Transequatorial VHF propagation through equatorial plasma bubbles*, Radio Science.
9. Winkler, C., *Ionospheric transequatorial radio wave guidance at VHF*, preprint, DSE Salisbury, Adelaide, S.A. 5001.

You might also refer to: Harrison R. (1979), *Investigations of long-distance VHF/UHF amateur contacts across the geomagnetic equator*, Proceedings of the 1979 Symposium on Future Amateur Communications Techniques (available from the author). ●

This article is reprinted from Proceedings of the 1979 Symposium on Future Amateur Communications Techniques. Despite its age, it remains relevant, especially in view of the huge number of two metre contacts across the equator recorded in the intervening years. Anyone interested in submitting logs for study should contact the Editor of ETI at P.O. Box 227, Waterloo NSW 2017. (02)663-9999.

MINI-MART

For Sale/Wanted/Swap/Join

AUDIO

FOR SALE: PLAYMASTER speakers. Large 70 litre cabinets, 3-way, 300 mm woofers. High and mid-range faders. Showroom condition. Cost \$374, sacrifice \$240. Brian Proctor, (02)579-6867.

FOR SALE: 100 W SPEAKERS in two cabinets. \$6000 ono. (062)86-2475.

MISCELLANEOUS

FOR SALE: OSCILLOSCOPE, Trio CS1830, dual trace, delay triggered, dc-30 MHz. As new with three probes, manual and service manual, \$1000. (053)34-7630.

FOR SALE: OSCILLOSCOPE, 60 MHz Tektronix 2213, mint condition. \$1400. Digital multimeter, Beckman 3010, as new, \$150. R. Coleman, 7 Mallee Place, Rivett. 2611. (062)88-5369.

FOR SALE: B&W 12" GENERAL monitors receivers. High resolution video in, professional conversion brand new sets surplus to needs. \$108. (08) 264-3073.

WANTED: 'EVERYDAY Electronics and Computer Projects', September 83 or a photocopy of Part 3 of 'Microcomputer Interfacing Techniques'. B. Le Marshall, 6 Exchange St, Ballarat Vic 3350. (053)32-2793.

FOR SALE: TELETYPE MODEL 15 with 240/110 Vac transformer, EA computer interface and manual \$70. N. Frencken, Mt Waverley Vc. (03)606-8046 bh. (03)277-4478 ah.

COMPUTERS

FOR SALE: SUPER 80 computer, 48K RAM, BASIC on tape, Editor-assembler, debugger-disassembler, graphics, in case, basic and technical manuals, BASIC programs (book), \$300 ono. (053)34-7630.

FOR SALE: MICROBEE software, 'Gorge of Death' real time graphics adventure for 32K machines. \$10 including tapes and instructions. G. Swan, 20 Cashel Cres, Killarney Heights NSW 2087.

FOR SALE: S100 16K 150 nsec static memory boards (two off) supports Phantom addressing. \$120 each. Peter Kay, 140 Watsons Rd, Glen Waverley Vic 3150. (03)560-5453 bh. (03)44-0791 ah.

WANTED: INFORMATION about the Mini-Scamp. Details of the hardware and software would be appreciated. Write to F. Testi, c/- A. C. K. Kilmore Vic. 3601.

• We'll publish up to 24 words (maximum) free of charge for you, your club or your association. Copy must be with us by the 1st of the month preceding the month of issue. Please — please — print or type advertisements clearly, otherwise it may not turn out as you intended! Every effort will be made to publish all advertisements received; however, no responsibility for so doing is accepted or implied. Private advertisements only will be accepted. We reserve the right to refuse advertisements considered unsuitable.

• **Conditions:** Your name and address plus phone number (if required) must be included with the 24 words. Reasonable abbreviations, such as 25 W RMS or 240 Vac, count as one word. Advertisements must relate to electronics, audio, communications, computing, etc — general advertisements cannot be accepted.

Send your advertisement to:

ETI Mini-Mart,
P.O. Box 227,
Waterloo NSW 2017.

FOR SALE: OSBORNE 1, dual single density drives, 64K, CP/M 2.2, Wordstar/Mailmerge, Supercalc, CBASIC/MBASIC, manual. As new condition for \$1190. David (02)516-9528 bh.

FOR SALE: SUPERMON, the Aussie monitor for Atari 400/800. Full disassembler functions such as List, Trace, Move, Change etc. Full disk controller, four more graphics modes from BASIC, seven splitscreens. Most revision B features, some XL. Many more functions, requires no extra memory, \$89. W. Visser, P.O. Box 507, Beenleigh Qld 4207. (07) 209-7891.

FOR SALE: SUPER 80, 48K, EPROM BASIC, S100 expansion monitor and cassette recorder. All as new, \$500. (02)887-3148 ah.

WANTED: IBM keyboard in any condition, disk drive and monitor. Wayne (02)668-9616.

FOR SALE: NEC COLOUR APC. 2x1MB drives, 256K, 8086. Hi-res graphics sub-system and development software. Various highly useful disks. Warranty until end of June. \$6900. M. Mowbray. (02)230-5438 bh. (02)923-2974 ah.

FOR SALE: MICROBEE personal communicator (32K), software, documentations; Mitsubishi SV-1290X VDU; all one month old for \$675. Mr Lim, 9 Malua Cres, Mill Park Vic. (03)404-2063.

FOR SALE: HITACHI MB6890 (Peach) micro-computer system 48K RAM, colour monitor (hi-res), DSSD disk, tractor printer, 20 disks with programs, lots of documentation. Cost \$5200, sell \$3250 ono. David Morton, 26 Myrtle St, Murwillumbah NSW 2484.

FOR SALE: SYM-1, CASE and power supply, full ASCII keyboard and 64x28 video board (128 characters in EPROM) with drivers auto linked in EPROM. \$250 ono. Rob. (053)30-1524 ah. Ballarat.

FOR SALE: S100 boards. Static RAM, 64K, 8 MHz, extended addressing, phantom disable, EPROM substitution. Four boards, each \$375 or \$1400 the lot. East Ryde. (02)888-7624.

FOR SALE: BIG BOARD2 chess program, Sargon derivative using BB2 graphics on 8" CP/M disk. D. Craig, 2 Bridle St, Mansfield Qld. 4122. (07)349-9719 ah.

FOR SALE: MICROACE computer, 2K RAM, direct video, power supply, software, information (newsletters etc), excellent condition, \$130 ono. (07)209-7841 ah.

WANTED: ADDRESSES of suppliers of software/hardware for the System 80 computer. Contact Mr R. Schatz, P.O. Box 17, Koorawatha NSW 2807.

WANTED: OSI C1P disk drive with OS65D and D.T. disk interface board. Also OS65D manual and software. J. Barnes, 8/3A Montagu St, Hobart Tas. 7008. (002)31-0414.

MICROBEE USERS: FREE newsletter with program hints, handy hints etc. available for the asking. To register for your inclusion in our mailing program write to Tom Bontes, P.O. Box 79, Gosnells WA 6110.

FOR SALE: DGZ80 CPU, MW640 VDU, 48K CMOS RAM, RCA keyboard, 10-slot 10A frame, tape i/f. Tapes: BASIC, EDASM, Pilot, etc. \$700. G. Harrod, (07)378-8534.

WANTED: APPLE BOOKS, especially 'Beneath Apple DOS', Apple magazines (In-Cider, Softalk, Orchid, etc.), Apple software (games, utilities, etc). Rom (02) 217-2434 bh.

FOR SALE: Z80 DEVELOPMENT system Tec-1, by Talking Electronics \$90 ono. complete with manuals and power supply. Mark (02)872-3407.

FOR SALE: S100 boards 16K static RAM \$115, 64K dynamic RAM \$295, I/O board 25 & 9P \$240, disk controller & CP/M \$399. (07)30-1949 after 6pm.

FOR SALE: SEKONIC printer plotter S200-GP. As new condition with one roll of paper. Centronics interface. \$550 only. W. Fiala, 21 Hallows St, Glen Waverley Vic. 3150. (03)232-0713 ah. (03)758-9000 bh.

ACT VIC-20 bimonthly magazine: Many interesting articles and programs. April issue \$2. Bimonthly \$12 per year. Chris Groenhout, 25 Kerferd St, Watson ACT 2602.

COMMUNICATIONS

FOR SALE: PHILIPS FM 320 UHF transceiver and 10 ft co-linear. \$280 ono. (062)86-2475.

FOR SALE: DICK SMITH 40 channel UHF transceiver. Built and tested. S meter and repeater options. Selling due to unfortunate geographical location. \$225 VK5BCD (085)22-5241.

... wings on the keel and cannons on the foredeck — an unbeatable combination!

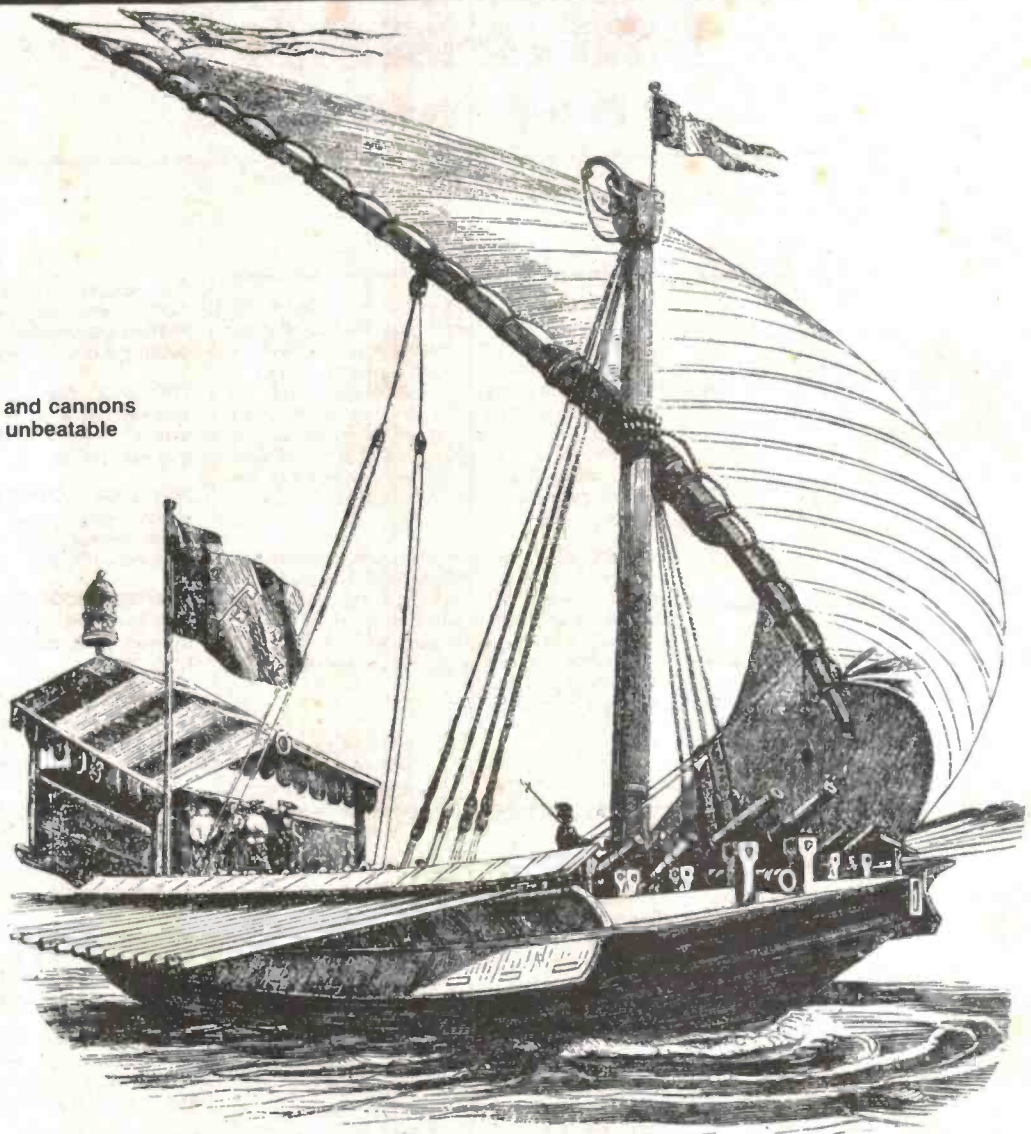

**D
R
E
G
S**

GATHERED RECENTLY, in that other Apple Isle across the Big Pond, were a score of technical journalists from around the world — including ETI's correspondent Collyn Rivers. All were there for the pre-release of an exciting new computer.

All went well until Murphy intervened — during a demonstration of the ease with which the machine could access data-bases. Three successive attempts failed — a happening which should neither surprise nor dismay anyone who's ever experienced the sheer inanimate malevolence of computers in mid-sulk.

In retrospect, the hapless demonstrator should have retired wounded (or acquired some more haps), but

he pressed on with the demo — which from then on went well.

Until question time.

Then a British journo (arrogant, even for a Pom) asked how come the machine was the ultimate in user-friendliness when even experts couldn't make it work. The demonstrator rose to the bait and asked what on earth the questioner meant.

"Stuffed it three times in a row, didn't you," said our charmer.

"Now we know," observed Collyn upon his return, "what St John really meant in Corinthians 15:33." (For those unacquainted with apostolic aphorisms John 15:33 reads, 'evil communications corrupt good manners'.)

For champion performance from compact discs, look to the audio giants.

Totally faithful sound reproduction is no longer out of reach. Thanks to Sanyo's compact disc technology, a quantum leap into the future of audio enjoyment.

Ask to hear a demonstration of Sanyo's CP 300 Compact Disc Player. The sound quality you'll experience from the 12cm, up to an hour-long, one-sided compact disc is identical to that of the original digital master tape.

Examine the unit carefully. You'll find winning features like horizontal slide loading system; soft-push microcomputer controls; 16-selection programmable auto-search system; and synchronous recording to name a few.

Already, this digital audio technology using laser optics is transforming the audiophile's world, with the kind of champion performance from compact discs that only the audio giants can deliver.

But with Sanyo, that's life.

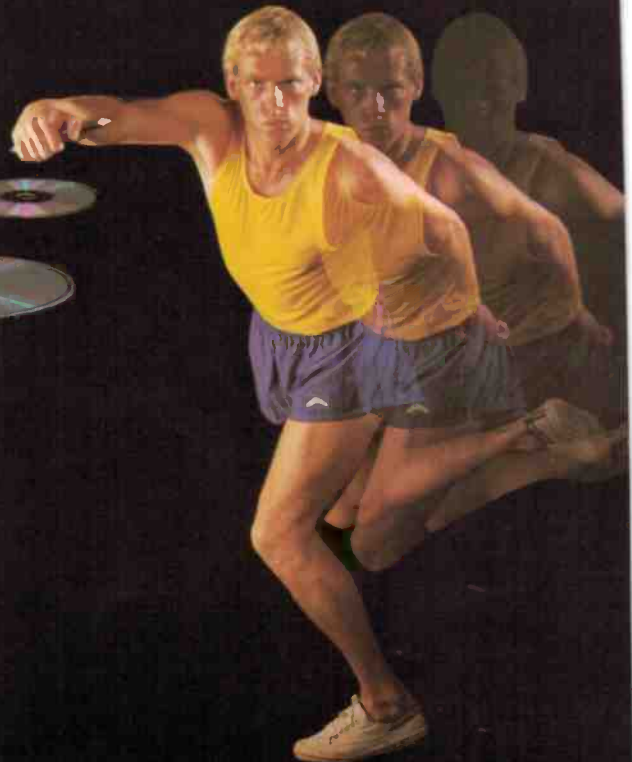

CP 300



SANYO

That's Life!

The range of Hi-Fi equipment you thought was beyond your means is now within your grasp.

RECEIVERS

SEPARATE AMPS

CASSETTE DECKS

INTEGRATED AMPS
TUNERS
CASSETTE DECKS
TURNTABLES
RECEIVERS
SEPARATE AMPS
SPEAKERS
CARTRIDGES
HEADPHONES
SYSTEM COMPONENTS

A Hundred Years of Musical Experience

YAMAHA
HI-FI



Please send me the latest
Yamaha Hi-Fi catalogue.

Name _____

Address _____

Postcode _____



Yamaha Hi-Fi Division, Rose Music Pty. Ltd.,
17-33 Market St., South Melbourne. Victoria. 3205.

MCR/RM 3861E/R