



## The *-hp-* Audio Signal Generators

**A**MONG the *-hp-* line of audio test instruments are four instruments known as audio signal generators. The basic function of these generators is to provide an accurately known audio frequency at an accurately-known and adjustable output level. The generators are specially arranged to simplify gain and response measurements on both high- and low-level equipment.

All of the generators provide a wide range of output powers. Three of the generators have a very high output of 5 watts and are thus suitable for high-level as well as general test work. The fourth is especially suitable for use with broadcast equipment and has a maximum output of 30 milliwatts (+15 dbm). All are provided with wide-range output attenuators that reduce the output level to the lower microvolt region.

The 30-milliwatt generator is the *-hp-* Model 206A. This instrument is specifically designed to be used in the most exacting

audio applications and is unquestionably the finest audio test source available commercially. The 206A is used extensively in applications such as testing of high-quality amplifiers, recording devices, transmission lines, FCC proof of performance measurements on audio systems in f-m and a-m broadcast stations, etc.

The 206A operates from 20 cps to 20 kc and is provided with a multi-impedance output system to match to common audio impedances of 50, 150, and 600 ohms. All of these outputs are balanced and center-tapped. A single-ended output having a 600-ohm source impedance is also provided.

One of the special features of the 206A is its very low distortion of less than 0.1%. The circuit arrangement that provides this low distortion is indicated in Fig. 2. The oscillator section (Fig. 2) is a resistance-capacity circuit in which all design factors have been carefully exploited so that distortion in the generated voltage is very low—less than approximately 0.2%. This value represents the practical limit obtainable in the generating circuit itself with present tubes.

To reduce distortion in the generated voltage from 0.2% to less than 0.1%, the oscillator is followed by a frequency-selective amplifier arranged as indicated in Fig. 3. Within the amplifier is located a tuned bridge whose tuning capacitors are tracked with the tuning capacitors for the oscillator. The bridge and the oscillator are always tuned to the same frequency.

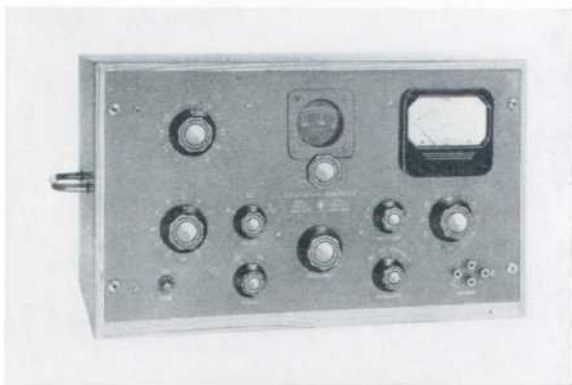

Fig. 1. *-hp-* Model 206A Audio Signal Generator operates from 20 cps to 20 kc with less than 0.1% distortion above 50 cps.



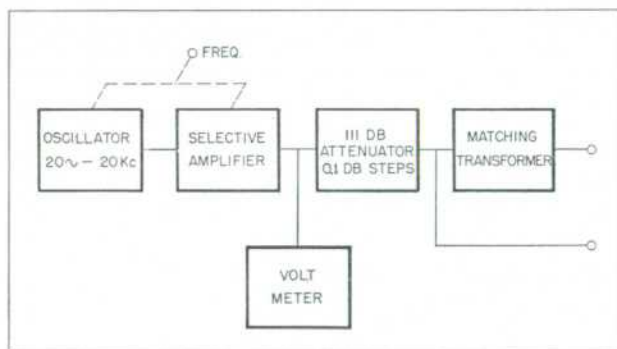

Fig. 2. Circuit block diagram of -hp- 206A Audio Signal Generator.

The bridge is arranged to separate harmonic voltages from the fundamental. At the frequency for which the bridge is balanced, no output at the fundamental frequency will be obtained between the balance points of the bridge. However, output will be obtained for the harmonic frequencies applied to the bridge. The bridge thus operates as an elimination filter which suppresses the fundamental and passes harmonics.

The harmonic output is amplified in a separate amplifier and applied to the input of the main amplifier as negative feedback. Through this arrangement, negative feedback occurs only for the harmonics, while the fundamental is relatively unaffected. The overall amplifier thus has less distortion in its output than in its drive voltage. A reduction in distortion of approximately 10 db is obtained in the circuit, so that less than 0.1% distortion is obtained at the output of the amplifier at frequencies above 50 cps. Less than 0.25% distortion is obtained at frequencies below 50 cps. This low distortion is sufficient for testing highest quality equipment and permits exacting measurements to be made even at low audio frequencies.

The output of the main amplifier is monitored by a voltmeter with a spread scale that allows the level applied to the attenuator to be metered very accurately. The attenuator has an overall range of 111 db so that outputs as low as approximately 10 microvolts can be obtained. The at-

tenuator is adjustable in steps of 10 db, 1 db, and 0.1 db. The 0.1 db step section is particularly useful in making measurements on high-quality equipment where only small variations in frequency response are involved. The attenuator is accurate within 0.25 db up to 80 db of attenuation at all frequencies within the range of the equipment.

The output attenuator feeds into a specially-designed output transformer which is constructed with a high-permeability core of large dimensions. The quality of the transformer is such that changes in level or operation at low output frequencies cause very little variation in overall accuracy. The output transformer is provided with windings for use with 50, 150, and 600-ohm circuits. All of these windings are center-tapped and balanced.

The output circuit is also arranged to have a single-ended system which by-passes the output transformer. Where the utmost is required in signal purity and frequency response, a slight advantage can be obtained by using the single-ended output. The internal impedance of the single-ended system is 600 ohms.

The frequency response of the output system is constant within 0.2 db over a 30 cps to 15 kc range.

#### MODEL 205AG

The -hp- Model 205AG Audio Signal Generator consists of two separate instruments in one cabinet: a complete audio signal generator and

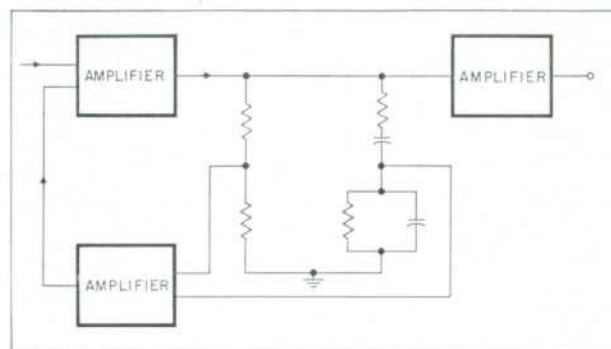

Fig. 3. Basic arrangement of selective amplifier in -hp- 206A.

an additional vacuum tube voltmeter (Fig. 4). This arrangement results in an instrument that is a gain-measuring set complete in itself for which no external level-measuring equipment is required.

The 205AG provides a maximum of 5 watts over the range from 20 cps to 20 kc. The instrument has a multi-tap output system to permit this power to be delivered to loads of 50, 200, 600, and 5,000 ohms.

The 205AG has many uses in testing audio systems and because of its high power output is especially useful in applications where a combination of an oscillator and a power amplifier is necessary to obtain a high-level test signal. Such applications include measurements on loud speakers, power amplifiers, high-voltage bridges, transducers, etc.

The high power and frequency coverage of the 205AG also make the instrument suitable for a number of industrial applications. The instrument can be used in fatigue tests of materials as in Fig. 5. Here the 205AG is used to drive a magnetic head which is coupled to magnetic material on the end of the specimen to be tested.

The 205AG is especially useful as a gain-measuring set because of its separate voltmeter for measuring the output of equipment under test. The instrument has advantages over the usual gain- or transmission-measuring set in that it has a self-contained oscillator that covers the complete audio range, in that its voltmeters



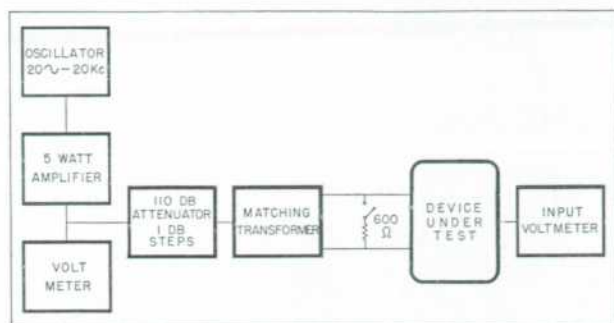

Fig. 4. Circuit block diagram of *-hp-* 205AG Audio Signal Generator.

are more accurate than the usual copper-oxide type voltmeters used in gain sets, and in that its price is less than the price of the separate components necessary to make accurate measurements of transmission characteristics.

Referring to Fig. 4, the oscillator section in the 205AG is similar to the oscillator in the 206A. Care is taken to maintain high purity of waveform, although the oscillator waveform is not enhanced by the use of a frequency-selective amplifier as in the 206A.

The frequency calibration of the generator is accurate within 2%. Where higher accuracy is desired, provision is made in the oscillator circuit for convenient standardization of frequency calibration. The standardization arrangement consists of a variable resistor for each frequency band. When the frequency calibration is checked against suitable standards, the resistors can be adjusted for best accuracy over each band or for any one area of the band.

The output amplifier is conservatively designed to realize the 5-watt output with low distortion. The output stage of the amplifier consists of two 6L6's operated in push-pull. Overall negative feedback for the amplifier is provided by a tertiary winding on the output transformer.

A second transformer in the output circuit is used for matching to various load impedances. Although this transformer is of high-quality construction, its low-frequency response characteristics (Fig. 6) at low output levels are not equal to the low-frequency characteristics of the *-hp-* 206A. Therefore, where constancy of response at low audio frequencies is important at levels below  $-10$  dbm, the *-hp-* 206A is recommended.

The input to the matching transformer is controlled by a 110-db attenuator adjustable in 1 and 10 db steps. To permit the full 5-watt output to be obtained in an economical circuit, the output system is arranged to have a low impedance when the attenuator is set for zero attenuation. A matched source impedance is obtained when the attenuator is adjusted for approximately 20 db or more of attenuation

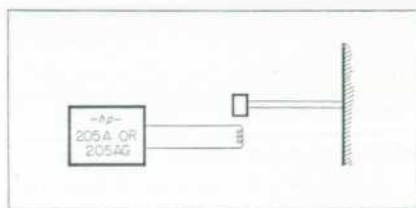

Fig. 5. Arrangement for simple fatigue testing of materials.

(of the 5 watt level). Since the combination of a 5-watt output level and a matched source impedance is seldom required in practice, this output arrangement is suitable for both high- and low-level applications.

The output meter monitors the input to the attenuator and is calibrated for zero attenuation at the

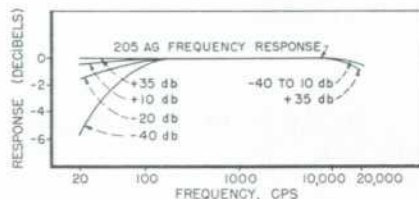

Fig. 6. Frequency response characteristics of *-hp-* 205AG Audio Signal Generator.

600-ohm output terminal. So that the voltage across high-impedance loads can be known accurately, a built-in 600-ohm load can be switched across the 600-ohm taps on the matching transformer.

The separate voltmeter for measuring the output of devices under test has an input impedance of 5,000 ohms. The meter face is calibrated from  $-5$  to  $+8$  db referred to a 0 db level of 1 milliwatt in 600 ohms. The input voltmeter also includes a 0-40 db attenuator adjustable in 5 db

### *-hp-* AUDIO SIGNAL GENERATORS

Model	Freq. Range	Max. Power Output	Output Impedances	Distortion	Special Features
205A	20 cps - 20 kc	5 watts	50, 200, 600, and 5,000 ohms	Less than 1% above 30 cps	
205AG	20 cps - 20 kc	5 watts	50, 200, 600, and 5,000 ohms	Less than 1% above 30 cps	Includes separate voltmeter for gain measurements
205AH	1 kc - 100 kc	5 watts	50, 200, 500, and 5,000 ohms	Less than 1% at 5 watts; Less than 1/2% at 1 watt	
206A	20 cps - 20 kc	30 mw	50, 150 and 600 ohms	Less than 0.1% above 50 cps	Extra low distortion



steps. Thus, the meter can be used to read levels as high as +48 db (195 volts). The lower limit of the voltmeter is 0.45 volt.

#### MODEL 205A

The third *-hp-* audio signal generator is the Model 205A. This instrument is the same as the Model 205AG, except that no input meter section is included.

#### MODEL 205AH— ULTRASONIC RANGE

The fourth *-hp-* audio signal gen-

erator is the Model 205AH. The general circuitry of this instrument is similar to the Model 205A, except that the 205AH covers a range from 1 kc to 100 kc in two bands. The instrument is used widely in ultrasonic work where a high power output is useful in testing ultrasonic transducers.

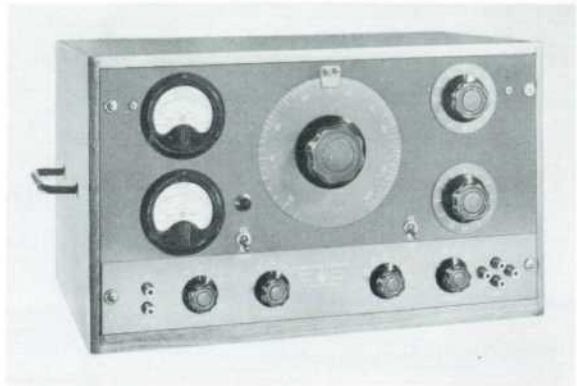

Fig. 7. *-hp-* 205AG Audio Signal Generator provides 5 watts over 20 cps to 20 kc range.

#### *-hp-* MODEL 205AG AUDIO SIGNAL GENERATOR

**Frequency Range:** 20 cps to 20,000 cps in three ranges.

**Calibration:** Calibrated directly in cycles for the lowest range, 20 cps to 200 cps. Each range covers approximately 270 degrees on the 6½" main dial.

**Stability:** Under normal temperature conditions frequency drift is less than 2% over long periods of time. Each range is provided with an internal adjustment so that 1% accuracy may be maintained if required.

**Maximum Output:** Five watts output will be delivered to a matched resistance load.

**Output Attenuator:** 110 db in 1 db steps. Consists of a 100 db attenuator with 10 db steps and a 10 db attenuator with 1 db steps.

**Load Impedances:** A switch selects transformer taps for use with loads of 50, 200, 600, and 5,000 ohm resistive loads. The output circuit is balanced and center-tapped; any terminal may be grounded. Internal impedance is approximately 1/5 of the load impedance with zero attenuator setting. Internal impedance approaches the load impedance with attenuator setting of 20 db or more.

**Frequency Response:** The system beyond output meter is down 2.0 db at 20 cps and 1 db at 20,000 cps (at levels from +37 to -10 dbm). Drop in response exceeds these limits at levels lower than -10 dbm.

**Distortion:** Less than 1% at rated output at all frequencies above 30 cps.

**Hum Level:** 60 db below output voltage or 90 db below zero level, whichever is larger.

**Output Meter:** Calibrated directly in volts at 600 ohms and in db above a 1 mw level (54.7 volts and plus 37 db full scale).

**Input Meter:** Input meter has a range of minus 5 db to plus 48 db based on a 1 mw level in 600 ohms. Meter scale calibrated from minus 5 db to plus 8 db; multiplier switch adds 40 db to reading in 5 db steps. Meter input impedance is 5,000 ohms.

**Input Meter Response:** Within 0.2 db over range from 20-20,000 cps.

**Power Supply:** 115/230 volts, 50/60 cycles. Power consumption: 125 watts.

**Mounting:** Available in either relay rack or cabinet mounting. Panel size on either instrument, 19" x 10½". Cabinet models are mounted in wood cabinets.

**Net Weight:** 63 pounds. Shipping Weight: 100 pounds.

**Price:** \$425.00 f.o.b. Palo Alto, California.

#### *-hp-* MODEL 205A AUDIO SIGNAL GENERATOR

Same as *-hp-* Model 205AG except that instrument does not include input voltmeter.

**Price:** \$390.00 f.o.b. Palo Alto, California.

#### *-hp-* MODEL 205AH SUPERSONIC SIGNAL GENERATOR

**Frequency Range:** 1 kc to 100 kc, in two ranges.

**Frequency Calibration:** Accurate within 2%.

**Stability of Frequency:** ±½% after ½ hour warm up. Line voltage changes of ±10 volts have negligible effect on frequency as power supply to oscillator is regulated.

**Power Output:** 5 watts at 1% distortion, 1 watt at ½% distortion.

**Output Attenuator:** 0 to 110 in 1 db steps. Accurate within ½ db in first 80 db, 3 db in last 30 db.

**Output Meter:** Calibrated directly in volts at 500 ohms and in db above 1 milliwatt level (50 volts and +37 db, full scale).

**Load Impedances:** 50, 200, 500, and 5,000 ohm resistive. Output circuit is balanced and center-tapped; any terminal may be grounded. Internal impedance is approximately 1/7 of the load impedance with zero attenuator setting. Internal impedance approaches load impedance with attenuator setting of 20 db or more.

**Frequency Response:** ±1 db from 10 kc reference.

**Hum Level:** At least 65 db below output voltage or 65 db below 1 milliwatt into 500 ohms, whichever is greater.

**Power Supply:** 115/230 volts, 50/60 cycles, 125 watts.

**Mounting:** Same as 205AG.

**Net Weight:** 50 pounds. Shipping Weight: 90 pounds.

**Price:** \$550.00 f.o.b. Palo Alto, California  
Data subject to change without notice.

#### *-hp-* MODEL 206A AUDIO SIGNAL GENERATOR

**Frequency Range:** 20 cps to 20 kc in 3 ranges.

**Calibration:** Calibrated directly in cycles for the lowest range, 20 to 200 cps. Each range covers approximately 270 degrees of the 6" dial. A six to one rim drive provides for fine frequency adjustments.

**Stability:** The frequency is calibrated to within better than 1% when the instrument leaves the factory. The circuit elements in the frequency-determining network have low temperature co-efficients and good stability so that better than 2% accuracy will be maintained over long periods of time.

**Output:** Maximum output is +15 dbm above 1 mw into impedances of 50, 150, and 600 ohms. Approximately 10 volts are available on an open circuit.

**Output Impedances:** The generator has matched internal impedances of 50, 150, and 600 ohms center-tapped and balanced; and 600 ohms single-ended.

**Frequency Response:** Response of the system beyond the output meter is better than 0.2 db at all levels, 30 cps to 15 kc.

**Distortion:** Less than 0.1% at frequencies above 50 cps and less than 0.25% from 20 cps to 50 cps.

**Hum Level:** Residual hum and noise in the output signal is at least 70 db below the output signal or more than 100 db below zero level, whichever is larger.

**Output Meter:** The output voltage is measured ahead of the attenuators by a 4" square meter calibrated in dbm and volts.

**Output Attenuators:** Output attenuators provide a range of 111 db in 0.1 db steps. Individual resistors in the attenuators are adjusted to better than 0.2% and the accuracy of the attenuators is approximately 0.1 db.

**Mounting:** Standard relay rack size panel 10½" by 19". Depth behind panel is approximately 13". Either cabinet or relay rack mounting can be supplied. The panel is finished in smooth gray enamel, or special colors to match transmitter installations.

**Power Supply:** 115/230 volts, 50/60 cycles.

**Net Weight:** 65 pounds. Shipping Weight: 110 pounds.

**Price:** \$550.00 f.o.b. Palo Alto, California.