

QST

DEVOTED ENTIRELY TO

AMATEUR RADIO

PUBLISHED SINCE 1915 BY THE AMERICAN RADIO RELAY LEAGUE INC.

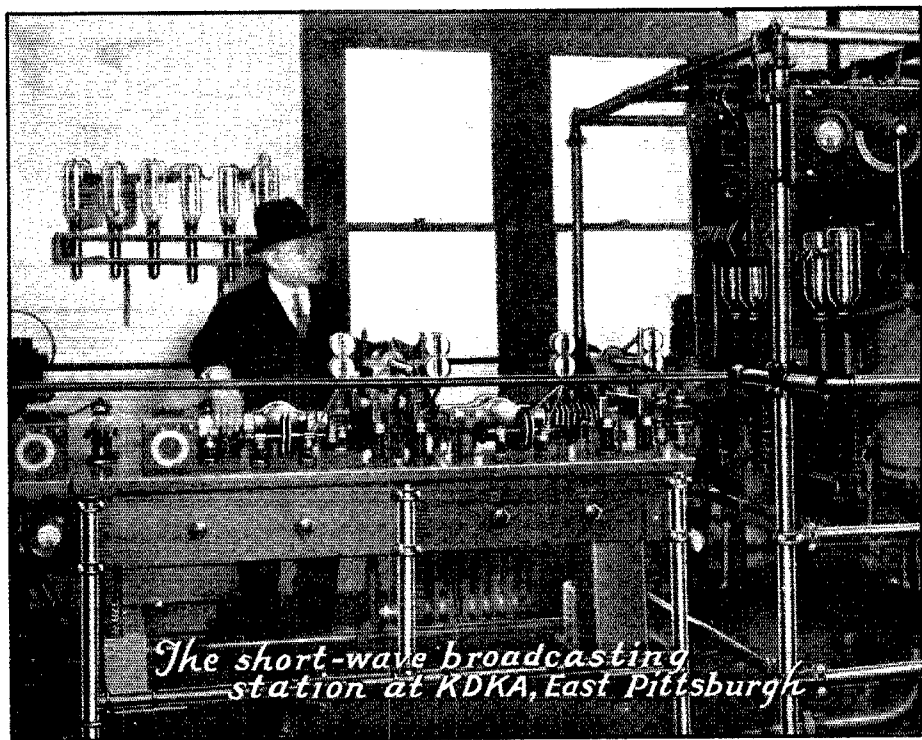

The short-wave broadcasting station at KDKA, East Pittsburgh.

MAY

1928

25¢

TRANSFORMERS AND FILTERS

The General Radio Company have recently developed a complete line of Transformers and Filters. While primarily intended for use in conjunction with the new UX 250 Power Amplifier tubes, they may be employed in any heavy duty plate supply unit utilizing either one or two UX 281 Rectifier tubes or equivalent. This line consists of both a half and a full wave transformer, a complete filter unit consisting of suitable chokes and condensers, and a power speaker filter. Bulletins describing these units will be sent on request.

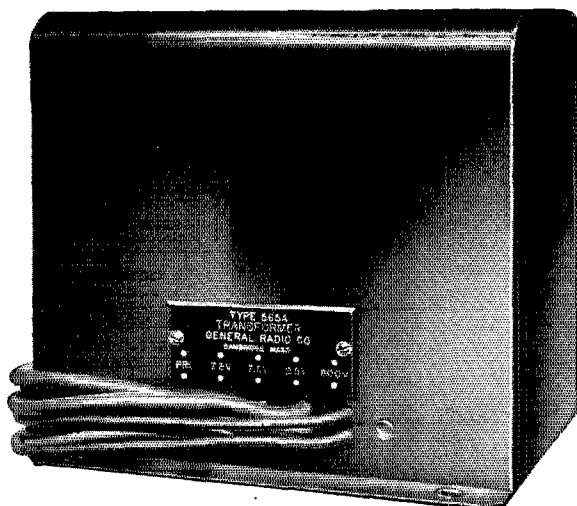

Type 565-A Half Wave Transformer

The primary is wound for 105-120 volt, 60 cycle operation, while four secondaries are provided, namely, one 600 volt for the plate supply; one 2.5 volt for filament lighting of tubes of the UX 226 or 277 type, and two 7.5 volts for lighting the filaments of the rectifier and power tubes. This transformer has a rating of 200 watts, thus providing adequate power without over-heating.

Price \$20.00

GENERAL RADIO CO.

Manufacturers of Quality Radio Apparatus

30 State St., Cambridge, Mass.

274 Brannan St., San Francisco, Calif.

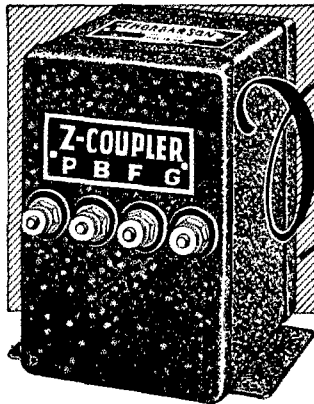

The Thordarson Z-Coupler, a special audio impedance coupler for use with screen grid tubes; price each, \$12.

New! SCREEN-GRID Audio Amplification

Screen grid audio amplification, most revolutionary development in audio systems since the introduction of the power tube, is now an established fact.

The Thordarson Z-Coupler is a special audio coupling device designed for use with the screen grid tube UX-222.

With the remarkable amplification thus obtained a mere whisper from the detector is stepped up to a point that gives the power tube all it can handle in the way of signal voltage. In fact, one stage Z-Coupled audio has the amplification equivalent of two, or even three, stages of ordinary coupling. Signals barely audible before may now be heard at normal room volume.

In tone quality, too, the Z-Coupler is unexcelled. Despite the high amplification the tonal reproduction is as nearly perfect as any audio amplifier yet developed. Both high and low notes come through with the same volume increase. Even at 60 cycles the amplification is over 95% of maximum.

Regardless of the type of your receiver you can vastly improve its performance by including this new system of amplification. The Z-Coupler replaces the second audio transformer, with very few changes in the wiring. The screen grid tube is used in the first audio stage. No shielding is required.

THORDARSON Z-COUPLER

THORDARSON ELECTRIC MANUFACTURING CO.
Transformer Specialists Since 1905
WORLD'S OLDEST AND LARGEST EXCLUSIVE TRANSFORMER MAKERS
Huron and Kingsbury Streets - Chicago, Ill. U.S.A.

*Write To-Day
for Complete
Information*

THORDARSON ELECTRIC MFG. CO.
Huron and Kingsbury Sts., Chicago, Ill.
Gentlemen:

Without obligation on my part, please send me complete information on screen grid audio amplifiers using your new Z-Coupler. (3578-F)

Name.....

Street and No.....

Town.....State.....

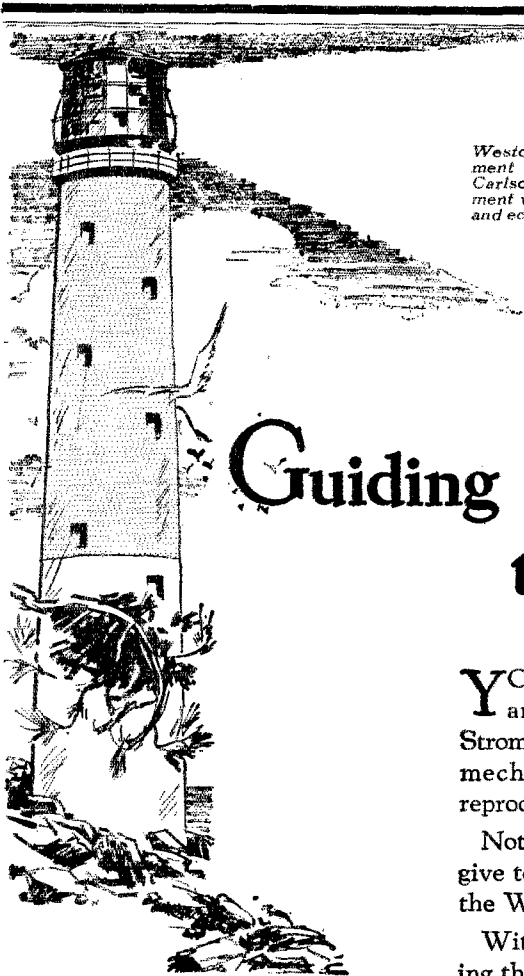

Weston Meter standard equipment on every Stromberg-Carlson assures correct filament voltage for most efficient and economical use of tubes.

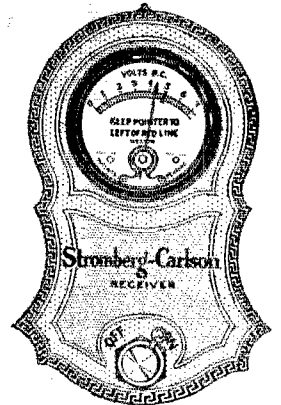

Guiding the way to Tone Quality!

YOU thrill to the exquisite beauty of the artist's performance as you listen in with a Stromberg-Carlson—unconscious of the splendid mechanism which is creating this wonderful reproduction.

Not least among the infinite refinements which give to Stromberg-Carlson its celebrated tone is the Weston Meter.

With this instrument you are guided in keeping the current through the tubes always at the exact point where the finest tonal results are secured. The meter also enables you to protect tubes from over-voltaging—so detrimental to tube life.

This important item of equipment keeps down the operating cost of a Stromberg-Carlson as well as safeguards the splendor of its tone.

Your nearest Stromberg-Carlson dealer's address may be learned from his advertisements in your newspapers or in your telephone directory.

**Stromberg-Carlson Telephone Mfg. Co.,
Rochester, N. Y.**

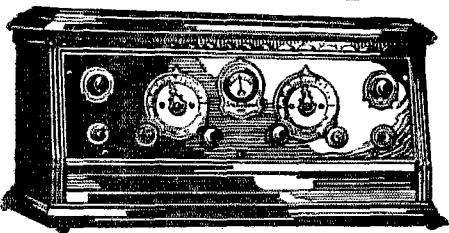

Stromberg-Carlson Receivers complete for A. C. house current operation, East of Rockies \$295 and up; Rockies and West \$315 and up; Canada \$390 and up. No. 523 A. C. Stromberg-Carlson, illustrated.

Every new Stromberg-Carlson has handy jack to facilitate playing Phonograph records.

Stromberg-Carlson

MAKERS OF VOICE TRANSMISSION AND VOICE RECEPTION APPARATUS FOR MORE THAN THIRTY YEARS

Section Communications Managers of THE COMMUNICATIONS DEPARTMENT, A. R. R. L.

ATLANTIC DIVISION				
Eastern Pennsylvania	3QP	J. B. Morgan, 2nd	431 E. Willow Grove Ave.	Chestnut Hill, Phila.
Maryland-Delaware-District of Columbia	3AIS	Dr. H. H. Layton	305 Washington St.	Wilmington, Del.
Southern New Jersey	3CFG	M. J. Lotysh	Box 49, RFD 1	Cranbury, N. J.
Western New York	8PZ	C. S. Taylor	398 Masten St.	Buffalo
Western Pennsylvania	8XE	G. L. Crossley		State College
CENTRAL DIVISION				
Illinois	9AAW	W. E. Schweitzer	4264 Hazel Ave.	Chicago
Indiana	9CQY	D. J. Angus	310 N. Illinois St.	Indianapolis
Kentucky	9ARU	D. A. Downard	116 No. Longworth Ave.	Louisville
Michigan	8CEP	Dallas Wise	9187 Falcon Ave.	Detroit
Ohio	8BYN	H. C. Storck	894 Carpenter St.	Columbus
Wisconsin	9VD	C. N. Crapo	443 Newton Ave.	Milwaukee
DAKOTA DIVISION				
North Dakota	9DM	H. L. Sheets		Brinsmade
South Dakota	9DB	F. J. Beck		Milbank
North Minnesota	9EGU	C. L. Barker		Henning
South Minnesota	9BYA	D. F. Cottam	3538 Third Ave. So.	Minneapolis
DELTA DIVISION				
Arkansas	5AIP	Leonard Clippard	2408 North Pierce St.	Little Rock
Louisiana	5URK	C. A. Freitag	129 Camp St.	New Orleans
Mississippi	5AKP	J. W. Cullett	1708 23rd Ave.	Meridian
Tennessee	4KM	L. E. Rush	4 Second St.	Bemis
HUDSON DIVISION				
Eastern New York	2CNS	F. M. Holbrook	2 Livingston Ave.	White Plains
N. Y. C. & Long Island	2CWR	F. H. Mardon	1399 W. Farms Rd.	N. Y. C.
North New Jersey	2WR	A. G. Wester, Jr.	50 Princeton St.	Maplewood
MIDWEST DIVISION				
Iowa	9BKV	A. W. Kruse	Rt. 6, Box 19	Akron
Kansas	9DNG	F. S. McKeever	1325 W. Campus Rd.	Lawrence
Missouri	9RR	L. B. Lazure	8010 Mercier St.	Kansas City
Nebraska	9RYG	C. B. Delhl	5605 Cedar St.	Omaha
NEW ENGLAND DIVISION				
Connecticut	1BM	H. E. Nichols	82 Elmwood Ave.	Bridgenort
Maine	1BHG	Frederick Best	13 E. Crescent St.	Augusta
Eastern Massachusetts	1UE	E. L. Battey	39 Royal St.	Wollaston
Western Massachusetts	1DB	A. H. Carr	30 Vassar St.	Worcester
New Hampshire	1ATJ	V. W. Hodge	227 Main St.	Claremont
Rhode Island	1BYB	D. B. Faneher	9 1/2 Hobart St.	Westerly
Vermont	1AJG	C. T. Keer		Poultney
NORTHWESTERN DIVISION				
Alaska*	1ST-7ALD	W. B. Wilson, U. S. LHT	Fern Ketchikan	
Idaho	7AAT-7QT	Henry Fletcher	1610 N. 10th St.	Boise
Montana	7PP	O. W. Ylers		Red Lodge
Oregon	7FD	R. H. Wright	310 Ross St.	Portland
Washington		Otto Johnson	4340 30th Ave. W.	Seattle
PACIFIC DIVISION				
Hawaii	6CFQ	F. L. Pullaway	2714 Manoa Rd.	Honolulu
Nevada	6UO	C. B. Newcombe		Yerington
Los Angeles	6AM	D. C. Wallace	109 W. Third St.	Long Beach Calif.
Santa Clara Valley	6NX	F. J. Quement	252 Hanchett Ave.	San Jose
East Bay	6CZR	J. Walter Frates,	368 62nd St.	Oakland
San Francisco	6VR	J. W. Patterson	400 Octavia St. Apt. 29	San Francisco
Sacramento Valley	6CRS	C. F. Mason	2530 N. St.	Sacramento
Arizona	6ANO	D. B. Lamb	229 W. First St.	Mesa
Philippines*	6L1AT	Jose B. Jimenez	835 San Fernando St.	Manila
San Diego	6BQ	G. A. Sears	236 Bonair St.	La Jolla
ROANOKE DIVISION				
North Carolina	4JR	R. S. Morris	413 S. Broad St.	Gastonia
Virginia	5CA	J. E. Wohlford	118 Cambridge Ave.	Roanoke
West Virginia	8HD	C. S. Hoffman	126 Chantal Court	Wheeling
ROCKY MOUNTAIN DIVISION				
Colorado	9CAA	C. R. Stedman	1641 Albion St.	Denver
Utah-Wyoming	6RM	Don C. McRae	214 Belvedere Apts.	Salt Lake City
SOUTHEASTERN DIVISION				
Alabama	5AJP	A. D. Trum	217 Catoma St.	Montgomery
Florida	4LK	C. E. Froulkes	502 Sparring St.	Jacksonville
Georgia-South Carolina-Cuba-Porto Rico-Isle of Pine	4KU	H. L. Reid	11 Shadowlawn Ave.	Atlanta
WEST GULF DIVISION				
Northern Texas	5AKN	J. H. Robinson, Jr.	522 Cumberland St.	Dallas
Oklahoma	5AAG	E. M. Ehret	2904 N. Robinson St.	Oklahoma City
Southern Texas	5YK	E. A. Sahn	146 N. Academy St.	New Braunfels
New Mexico	5TT	L. E. Radka		Tucuman
MARITIME DIVISION				
Newfoundland	8AR	Loyal Reid	Avalon House	St. Johns
New Brunswick	1EI	T. B. Lacey	c/o N. B. Power Cp	St. John
Nova Scotia	1DD	W. C. Borrett	14 Sinclair St.	Parliament
Prince Edward Island	1BZ	F. W. Hrdman	25 Fitzroy St.	Charlottetown, P. E. I.
ONTARIO DIVISION				
Ontario	9BJ	W. Y. Sloan	167 Close Ave.	Toronto
QUEBEC DIVISION				
Quebec	2BE	Alex. Reid	169 Logan Ave.	St. Lambert
VANALTA DIVISION				
Alberta	4HA	E. J. Taylor	10107-87th Ave.	Edmonton
British Columbia	5BJ	E. S. Brooks	c/o Forestry Dept.	Radio Court House, Vancouver
PRAIRIE DIVISION				
Manitoba	4FV	D. R. Sinclair	205 Cambridge St.	Winnipeg
Saskatchewan	4FC	W. J. Pickering	514 19th St. W.	Prince Albert

*Temporary officials appointed to act until the membership of the Section concerned choose permanent SCMs by the nomination and election.

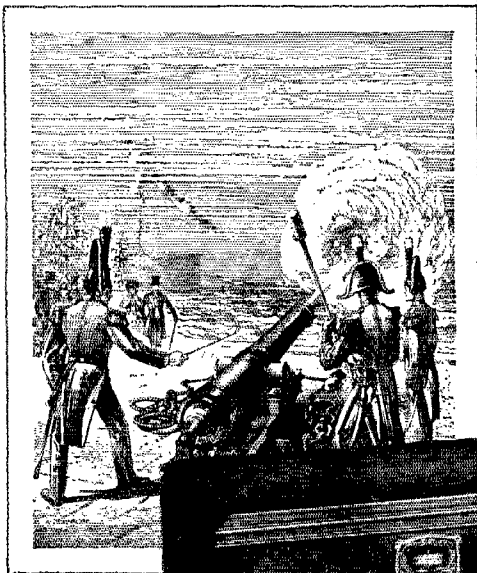

News of the completion of the Erie Canal on October 26, 1825, was passed across the state by firing cannon, placed at intervals, each being fired as soon as the nearest one was heard. The news thus traveled from Buffalo to the Battery in New York City in the amazing time of one hour.

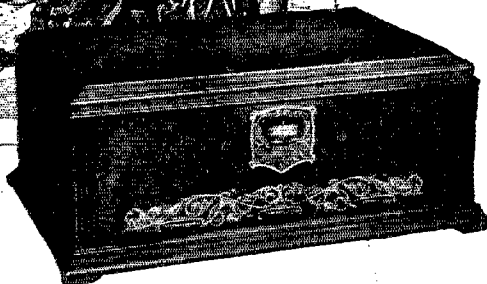

Get it Better with a Grebe



Among true enthusiasts, probably no feat of present-day radio engineering has aroused greater interest than the Grebe Synchronphase A-C Six. Probably none has been awaited with greater expectancy—not from Buffalo to the Battery, but from Coast to Coast.

For those who appreciate real radio enjoyment—the utmost in tonal beauty, range and selectivity—have long since come to a realization that the nineteen-year-old Grebe method of slow, painstaking production has, in each step of radio development, resulted in perfection.



The Grebe Synchronphase A-C Six is no exception to the rule. With distinctive Grebe innovations it proves that there is as wide a difference between Alternating Current (All-Electric) sets as between those using batteries.

Grebe Synchronphase Seven, \$145; Grebe Synchronphase Five, \$105; Grebe Natural Speaker, \$35; Grebe No. 1750 Speaker, \$17.50.

Hear the Grebe Synchronphase A-C Six today, or send for Booklet Q, which fully explains this new receiver.

GREBE

SYNCHROPHASE

A-C Six

RADIO

A. H. Grebe & Company Inc., 109 West 57th Street, New York City
 Factory: Richmond Hill, N. Y. Western Branch: 443 S. San Pedro St., Los Angeles, Cal.
 Makers of quality radio since 1909



QST



The Official Organ of the A.R.R.L.

VOLUME XII

MAY, 1928

NUMBER 5

Editorials	7
Getting Started at 30 Megacycles	<i>Robert S. Kruse</i> 9
10 Meters and the Ultraudion	<i>J. T. McCormick</i> 11
Recent Changes in Radio Law and Regulations	14
Rotten DX	<i>The Old Man</i> 16
Amateur Television	<i>Paul H. Thomsen</i> 17
Central Division Convention	18
Practical Audio Filters	<i>L. W. Hatry</i> 19
Some Changes at Headquarters	23
Let's Be Tolerant	<i>Hiram Percy Maxim</i> 24
The Twin City Vigilance Committee	<i>Carleton H. Kohler</i> 25
The Middle Capacity in a Two-Section Power-Supply Filter	<i>James Millen & D. E. Replogle</i> 27
6CMQ	29
Another Part of the Family	33
A Crystal Grinder	<i>H. F. Mason</i> 37
Atlantic Division Convention	38
A Combination Fieldmeter-Wavemeter-Voltmeter	<i>Eugene C. Woodruff</i> 39
Official Wavelength Stations	40
Experimenters' Section Report	41
A.R.R.L. Technical Information Service Rules	43
Designing Small Transformers	<i>R. C. Hitchcock</i> 44
I.A.R.U. News	60
Calls Heard	61
Correspondence	62
The Roanoke Division Convention	90
Hamads	91
QRAs	93
Index of Advertisers	94

QST is published monthly by The American Radio Relay League, Inc., at Hartford, Conn., U. S. A.
Official Organ of the A.R.R.L. and the International Amateur Radio Union

Kenneth B. Warner (Secretary, A.R.R.L.),
Editor-in-Chief and Business Manager

F. Cheyney Beekley,
Managing Editor and Advertising Manager

Robert S. Kruse,
Technical Editor

Harold P. Westman,
Assistant Technical Editor

David H. Houghton,
Circulation Manager

Subscription rate in United States and Possessions, Canada, and all countries in the American Postal Union, \$2.50 per year, postpaid. Single copies, 25 cents. Foreign countries not in American Postal Union, \$3.00 per year, postpaid. Remittances should be by international postal or express money order or bank draft negotiable in the U. S. and for an equivalent amount in U. S. funds, entered as second-class matter May 29, 1919, at the post office at Hartford, Connecticut, under the act of March 3, 1879. Acceptance for mailing at special rate of postage provided for in section 1103, Act of October 3, 1917, authorized September 9, 1922. Additional entry as second-class matter, acceptable at special rate of postage provided for above, at Springfield, Mass., authorized September 17, 1924.

Copyright 1928 by the American Radio Relay League, Inc. Title registered at United States Patent Office.
Member of the Radio Magazine Publishers' Association.

The American Radio Relay League

The American Radio Relay League, Inc., is a non-commercial association of radio amateurs, bonded for the promotion of interest in amateur radio communication and experimentation, for the relaying of messages by radio, for the advancement of the radio art and of the public welfare, for the representation of the radio amateur in legislative matters, and for the maintenance of fraternalism and a high standard of conduct.

It is an incorporated association without capital stock, chartered under the laws of Connecticut. Its affairs are governed by a Board of Directors, elected every two years by the general membership. The officers are elected or appointed by the Directors. The League is non-commercial and no one commercially engaged in the manufacture, sale or rental of radio apparatus is eligible to membership on its board.

"Of, by and for the amateur", it numbers within its ranks practically every worth-while amateur in the world and has a history of glorious achievement as the standard-bearer in amateur affairs.

Inquiries regarding membership are solicited. A bona fide interest in amateur radio is the only essential qualification; ownership of a transmitting station and knowledge of the code are not prerequisite. Correspondence should be addressed to the Secretary.

Directors

- | | | |
|---|--|--|
| <p><i>President</i>
 HIRAM PERCY MAXIM
 Drawer 2102,
 Hartford, Conn.</p> <p><i>Vice-President</i>
 CHARLES H. STEWART
 St. David's, Pa.</p> <p><i>Canadian General Manager</i>
 A. H. K. RUSSELL
 5 Mail Bldg.,
 Toronto, Ont.</p> <p><i>Atlantic Division</i>
 DR. EUGENE C. WOODRUFF
 234 W. Fairmount Ave.,
 State College, Pa.</p> <p><i>Central Division</i>
 CLYDE E. DARR
 137 Hill Ave., Highland Park,
 Detroit, Mich.</p> | <p><i>Dakota Division</i>
 C. M. JANSKY, JR.
 Dept. of Elec. Eng., U. of M.,
 Minneapolis, Minn.</p> <p><i>Delta Division</i>
 BENJ. F. PAINTER
 424 Hamilton Nat'l Bank Bldg.,
 Chattanooga, Tenn.</p> <p><i>Hudson Division</i>
 DR. LAWRENCE J. DUNN
 480 East 19th St.,
 Brooklyn, N. Y.</p> <p><i>Midwest Division</i>
 PORTER H. QUINBY
 817 Lauderman Building,
 St. Louis, Mo.</p> <p><i>New England Division</i>
 DR. ELLIOTT A. WHITE
 Dartmouth College,
 Hanover, N. H.</p> <p><i>Northwestern Division</i>
 K. W. WEINGARTEN
 3219 No. 24th St.,
 Tacoma, Wash.</p> | <p><i>Pacific Division</i>
 ALLEN H. BABCOCK
 65 Market St.,
 Southern Pacific Co.,
 San Francisco</p> <p><i>Roanoke Division</i>
 W. TREDWAY GRAVELY
 Box 245,
 Danville, Va.</p> <p><i>Rocky Mountain Division</i>
 PAUL M. SEGAL
 P. O. Box 571
 Denver, Colo.</p> <p><i>Southeastern Division</i>
 HARRY F. DOBBS
 c/o Dobbs & Wey Co.,
 Atlanta, Ga.</p> <p><i>West Gulf Division</i>
 FRANK M. CORLETT
 2515 Catherine St.,
 Dallas, Tex.</p> |
|---|--|--|

Officers

- | | |
|---|---|
| <i>President</i> | HIRAM PERCY MAXIM, Hartford, Conn. |
| <i>Vice-President</i> | CHAS. H. STEWART, St. David's, Pa. |
| <i>Secretary</i> | KENNETH B. WARNER, Hartford, Conn. |
| <i>Treasurer</i> | ARTHUR A. HEBERT, Hartford, Conn. |
| <i>Communications Manager</i> | F. EDWARD HANDY, Hartford, Conn. |

Address General Correspondence to Executive Headquarters, Hartford, Conn.

EDITORIALS

LAST month on this page we discussed some of the problems which will face us amateurs next year when the Washington Convention takes effect. We found those difficulties divisible in the main into two groups, technical problems and operating problems involving cooperation, and we then particularly discussed the latter group and presented an A.R.R.L. plan designed to meet the need, at least as a starter. Now just as the very finest of stations will be helpless under next year's conditions unless we have international cooperation, so will the very finest effort at cooperation be futile unless the technical problems are overcome. Tempus is very rapidly fugiting and it is time for the amateur world to sit up and take notice, examine the situation carefully, analyze its difficulties, find out how to overcome them, and then apply the information to the rebuilding of individual stations—not next year but right now, during 1928, so that the stations may possess a reasonable chance of performing satisfactorily when the bands get clipped and all the world's amateurs get pitchforked into the same restricted territories.

Honest confession is good for the soul, we're told, and an honest examination of amateur radio ought to help it. Let us grow introspective; let's examine ourselves as keenly as we can and talk plainly about it; let's not look too closely at either our few super stations or at our few terribly-poor ones, but at the great average of American amateur stations. It is not a reassuring spectacle in view of next year's requirements. It is our opinion that amateur radio in this continent has grown up in such a liberality of operating privileges and such a laxity of regulation-enforcement that the average American amateur station is utterly incapable of successful operation in a situation making such requirements as the international bands of the new convention make. We seriously doubt if as many as one-half of one percent of the active stations of to-day are good enough to offer their operators any reasonable chance of success in international work next year. The rest, we think, will have to be rebuilt: transmitters, receivers and frequency-meters. We don't mean that most of these stations are incapable of meeting the requirements of law and regulation to-day; almost all of them are. Nor that all of them wouldn't be capable of meeting the requirements of next year's

regulations; perhaps many of them would. That isn't the point at all. The government turns over certain territory to us, with certain fundamental limitations upon us, and doesn't care what we do within those limitations. However, the problem has only started then. The great job is to equip ourselves to carry on satisfactorily after we have met all the requirements of law and regulation.

It is not impossible. *The chief requirement is going to be the exercise of thought.* The defects in our equipment are immediately apparent and the remedy is known in many cases. Perhaps it has never been actually necessary in the past, while our privileges were relatively so great, to have more than a transmitter which transmits legally and a receiver which receives; but now it becomes necessary to do a much better job than that. We must prepare ourselves not only to meet quite difficult regulations but to be able to engage in two-way communication with other stations who are under the same handicaps, and to do this through a closely-packed mass of signals from many other stations attempting the same thing.

Under these conditions, of what use is a wave-meter that barely suffices to tell an amateur whether he is within or outside of a 1000-Kc. band? Is it not obvious that an amateur will have to possess a wave-meter, and a precise one, and one with an open scale capable of discerning between, say, 7080 Kc. and 7085 Kc.? And isn't it obvious that they will be called frequency-meters rather than wave-meters, and that we shall be thinking almost exclusively in terms of frequency? Again, when all the amateurs of the world are in bands but a few hundred kilocycles wide, of what utility is an autodyne receiver which has the present-day 1000-Kc. American band crowded into 18 degrees of dial movement? It becomes apparent, we think, that autodynes will have to be rebuilt for wide-open scales and that even then, because of the inherent mathematics of simple heterodyne reception, the job may not be good enough for really high-class and satisfactory reception. Whereas, in days now almost past, the complication of more elaborate receivers was never justified on the ground of their increased sensitivity, such complication may become very much warranted next year because of increased selectivity. Any method for obtaining selectivity from im-

improvements in the simple autodyne to the construction of short-wave superheterodynes and the employment of band-pass filters, for example, becomes worth investigating. And transmitters! Imagine emptying thousand American amateurs transmitting in a 150-Kc. band. Suppose you're one of them and you've just hooked some choice DX and have received a GA. And then your frequency drifts 5 Kc. as your tube heats. Where are you? Sunk, fellow, sunk! Freely admitting and, in fact, insisting that American amateur transmitters have performed marvelous feats, they need a complete house-cleaning to meet next year's requirements. The crystal-controlled d.c.-supply set represents an ideal except for its difficulty in shifting frequency and its cost. Other sets, it seems to us, need to be redesigned so that the frequency is steady and stays steady during keying, changes in voltage, tube heating and antenna swaying. They must be much more precisely adjustable than they are today, capable of finding an exact frequency when wanted, holding it as long as desired, changing, and settling down on exactly a previous frequency when required. Do you know many transmitters that do that to-day? Probably a great deal can be done in the design of self-excited transmitters but it may be that we shall have to come to a master-oscillator arrangement of some sort as most desirable for next year, just the same as a somewhat more advanced type of receiver than the simple autodyne may be warranted. The problem will be to devise arrangements that are not too complicated and not too expensive, so that they remain within the technical ability and the pocketbook-range of average amateurs. A general power reduction may be a positive help in the new difficulties, and surely it is not going too far to say that "raw a.c. on the plate" of self-excited oscillators must be tabu next year.

In pointing out the manifold defects of present American stations and the necessity for rebuilding most of them, we do not mean to be too discouraging. It is not that the new convention brings restrictions which make operation impossible. It is simply that in the past it has not been necessary for us to be precise and build really good "gear" and now it is necessary. With lots of room we have been successful in the past despite floppy waves, bum notes, crawling frequencies, too-big condensers, sloppy practices, haywire assembly, and lack of precision measurements. These must go and the amateur station which survives this year must be prepared to overcome them. This general thinking over and reconstructing amateur stations is, we think, the biggest job ahead of amateur radio this year, and the greatest thing that

the League can do to help is to see that *QST* presents practical, helpful information on the subject. Our Board of Directors carefully considered this subject at their recent annual meeting and eventually appropriated a sum from the League's surplus to finance a technical development program at Headquarters for the very purpose of finding answers to these problems and publishing the answers in *QST* this year, while we are all engaged in rebuilding. The work is now being organized and soon we hope to supplement the usual array of *QST* articles with results from our own shop, practical articles relating mostly to transmitters, receivers and frequency-meters and designed to be of immediate application by the average member in meeting these pressing problems. The Board feels that this is one of the finest things that the League can do for amateur radio.

We believe that every member ought to commence now to take stock of his station and plan how it should be altered to meet these needs. *QST* for the past two years has been full of information which is still modern and which bears upon all these problems. The *Handbook* will be a potent help. And our pages during the remainder of this year we trust will contain the answers to the remaining problems. This year, fellows, is rebuilding year, from power supply to corona shield, from the receiving antenna to the ear-cans.

One of the things we must look into is this new 10-meter band of ours. It is now open to general amateur use. It contains 2000-Kc., more than all of our new bands from 20 meters upward. It is commonly supposed to be worthless because something happens to all waves shorter than 12 or 13 meters which keeps them from producing useful signals even at the Antipodes except under rare and very freakish conditions. Eminent engineers have told us that the secret of the 10-meter band lies in devising a method of controlling the angle of radiation, that if we can find this we will have 10 meters tamed. No more fertile field for the amateur experimenter was ever offered. Lasting fame and glory await the successful. If a few hundred able amateurs devote their talents to this band for a while we believe the answer will be found. It just *must* be found—amateur radio has to have some way of making all those good kilocycles perform usefully.

In the general course of reconstruction to meet 1929 difficulties the average amateur can do much to help himself. A.R.R.L. Headquarters is going to do everything it can to help. But we, too, need help and the Staff will welcome ideas, suggestions and papers that bear upon this work.

K. B. W.

Getting Started at 30 Megacycles

By Robert S. Kruse, Technical Editor

30 MEGACYCLES, of course, is the same thing as the lubberly 30,000 kilocycles, which in radio is related to 10 meters. Use the term you prefer and we will proceed.

In the last issue of QST there was an announcement to the effect that the Federal Radio Commission had just opened the 28-30 megacycle band* to general amateur use. If anyone knows what the procedure is and what formalities are to be gone through, he hasn't bothered to tell me about it. As far as I am concerned it is still between the Commission and the Supervisors, which has the advantage that we needn't talk about the legal formalities.

The main effect of the announcement so far appears to have been a complete collapse of the bootleg activity on 30 Mc.—the attraction probably went out when it became legal. This story is being written to

several years of ballyhooing were needed on 200, then 100, next 80, again 40 and so on and so on, and even at this day 20 is being used half enough and 5 is still the personal property of a handful of us—plus the General Electric Company which is now starting the work that could have been done very nicely if there had been any coöperation through the League as a whole. All

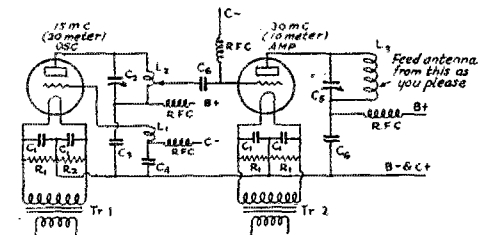

FIG. 1. AN OSCILLATOR-AMPLIFIER TRANSMITTER USING TWO TUBES OF THE SAME SORT WITH THE SAME B AND C VOLTAGES BUT NOT FROM THE SAME SOURCES

There must be a separate B supply at least and it is best to use separate filament transformers. Do not use center taps on transformers but use resistance center taps instead as shown.

- L1 Cut and try—depends mostly on the tube.
- L3 & 2nd L2 One turn copper strip or tube, diameter 3" as a start.
- C1 Bypass condensers, large enough.
- C2 Depends on the tube, 200 picos maximum may do.
- C3, C4 and C6 Stopping condensers, must stand plate voltage, plus some r.f. and should have capacity of 200 picos or so.
- C5 100 picos max. is enough here.
- R.F.C. For the oscillator 3/4" diameter and 2" long with winding of one layer No. 36 double silk or single cotton. For the amplifier reduce diameter winding to 1/4". Put the chokes at the job—not a foot away.

meet a demand for some encouragement of work by folks who were willing to stay in line until the word was given.

Do not become excited, for I have not the faintest illusion that anyone will put on more speed because of anything said here—

*30 Mc.=30,000 Kc.=10 meters.

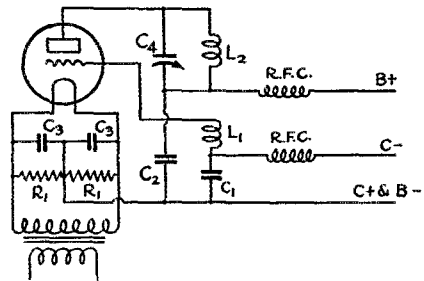

FIG. 2. 10-METER OSCILLATOR THAT WILL WORK WELL, AS WILL A LOT OF OTHER KINDS

- C1 and C2 Stopping condensers, had better be of mica and with capacity of 200 picos or more.
- C3 Bypass condensers. Good if large enough.
- C4 100 picos max. will serve.
- L1 Cut and try.
- L2 One 3" turn of tubing or strap firmly screwed to C4.
- R.F.C. 2" windings No. 36 double silk or single cotton on 1/4" core.
- Feed the antenna from L2 by any method you like.

of this suggests an idea; maybe if the tone of this story was disgusted enough it would make some of you angry enough to start something on 30 Mc. Unfortunately, I have no desire at all to stir up anyone by that

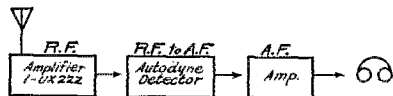

FIG. 3

method—it is too easy and not lasting enough. No, we will have to go through the same weary business all over again, with my successor prodding away at 30 Mc, and the Communications folks rubbing it in via the mimeod bulletins and the "X" Section running tests and so on and so on, and it will perhaps take the usual 18 months to get enough people going on the new frequency to find out anything.

THE NEEDLESS DIMENSIONS

It seems quite senseless to talk dimensions for 30 Mc*, when every reader of the magazine can in the last year's file find all the information he has the slightest need for. Anyone can see that 30 Mc. is half

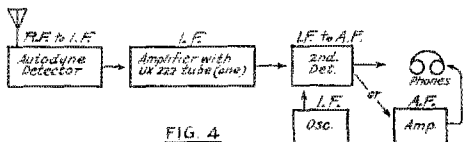

FIG 4

way between 15 Mc. and 60 Mc., so that if we know how to send and receive 15 and 60 it is almost an insult to explain how to work at 30. It happens that we do know how to use both for 60 Mc. is at 5 meters—which we have explained until blue in the face—and 15 is at 20 meters, on which several stations work now and then.

Please understand therefore that I am not going to talk to anyone except the folks who have just lost all their QSTs and haven't the necessary \$2.50 to get a replacement file from Circulation Manager Houghton. The rest of you will please turn to something else, for I do not wish to anger you in my last "story" as Technical Editor. You might retain the irritation and carry it over to Westman, who hasn't done a thing to deserve it and must be given a clean and fresh start at this desk.

Very well then; the transmitter must of course be something between a 5- and 20-meter transmitter, which is to say it must have very little coil, as much condenser as you can stand and a circuit that will be decently steady, considering the frequency.

Crystal control will be very nice if you care to try it—and I hope you do. For the rest of us something simpler must serve. Probably the best arrangement is somewhat that of Fig. 1, which explains itself except for the fact that the two tubes are of the same size but have separate plate supplies. This isn't a funny notion, it is a strict necessity. It is unfortunate that the first circuit cannot use more C and less L, for that would make it steadier, but at the same time would cut down the 2nd harmonic, which is what we wish to amplify and feed to the antenna. Keying had best be by Beverly Dudley's method—see his recent article on the oscillator-amplifier transmitter, in fact see both the first article and the follow-up on keying.

THE PLAIN OSCILLATOR

If that still seems too complex try a plain oscillator and use all the C and as little L as you can. Figure 2 tells that story pretty well. Here there isn't any decent

place to key. My suggestion is that you break the antenna circuit or detune it—but mount the key so it will not vibrate the set.

THE RECEIVER

Need I recommend a receiver after all that has been said on that subject? Surely you remember that, even though all of your QSTs were burned with the house and the insurance company will not replace them.

Yes, you are right, it will be a double-detection receiver using the circuit of Fig. 3, 4 or Fig. 5. There isn't the slightest need of showing the internal connections, for anyone able to operate the set will know them by heart now.

THE ANTENNA

The antenna system can be anything you have a liking for, half-wave, odd harmonic, bent, straight, with or without reflections, high or low, horizontal, vertical, slanted and fed by one of the 99 methods. Since nobody has admitted knowing how to radiate 30 Mc. so that it will do something useful you are perfectly welcome to try anything—remembering that it may be just as well not to waste tests in the customary fashion—which is to say by telling QST about it so late that nobody can be warned. This article should appear in the May issue of QST, your apparatus can therefore easily be ready by May 15th, private tests can be run in that and the next month and a notice sent to QST for the "X" Section at the same time for June tests. These can be transmitted to the Section by mimeod

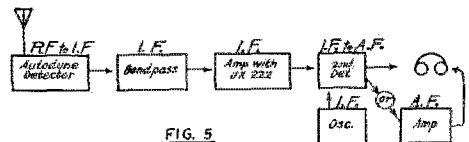

FIG 5

bulletin if the test dates are on and after June 15. At the same time state some test schedules for July and August and make the schedule simple enough so that one can print it in a small space. Then the July issue of QST can carry the announcement—the U. S. amateurs can listen in July and everyone in August. Please understand that all this depends on individual activity because, unfortunately, our experimental activities continue to depend upon spare time and the Ex. Section even now has not the complete time of one man here at Headquarters. It will therefore not be able to run any tests; only to exchange information as suggested. The Communications Department is announcing a 10-meter test in their Department, this issue of QST, to take place in May.

(Concluded on page 15)

Ten Meters and the Ultraudion

By J. T. McCormick*

Ten meters is coming. Some of us are afraid of it; some are doubtful as to its practical possibilities; and, no doubt, many of us will be too plain lazy to give it a trial. Nevertheless, QRM is going to give many a low-powered station its choice of trying ten meters or else suffering what is almost sure to be an almost QSOless existence. High time, then, that we start mental preparation for a ten-meter future.

Mr. Kruse has frequently told us that the Ultraudion is a 'star performer' at short wavelengths. That circuit, then, is likely to prove to be our best bet. The credit for our initial 'tip' goes to those 5-meter pioneers whom we have assisted so poorly in the past. Crystal control, with its frequency multipliers, will be beyond the purse-strings of most of us; some circuits, such as T. P.-T. G., may prove hopeless. It seems profitable, therefore, to become more familiar with the Ultraudion.

I nearly fainted when I found that some beginners were interested in the Ultraudion circuit, but afraid to try it because it was 'tricky.' The Ultraudion is a 'star performer' at short wavelengths for the very reason that it is less 'tricky' than any other oscillating circuit in existence!

The first step is to 'get' the Ultraudion "straight". Since writing the article which appeared in the September, 1927, issue of QST, I have discovered that a great many fellows are entertaining wrong impressions of the Ultraudion circuit.

Some seem to have acquired the impression (from goodness knows where!) that the Ultraudion is inefficient. The Ultraudion is exactly as efficient as the Hartley circuit if the adjustment of each circuit is equally good. (I wouldn't have dared to make that "crack" if I were an R. E.—more of that later.) The real difference lies in the fact that the Ultraudion is simpler to adjust and hence the adjustment is likely to be more nearly perfect.

The antenna coupling does *not* need to be of the type shown in the September article. You may use any type of coupling permitted to amateurs. 9CV uses voltage feed. 9AEK uses very loose inductive coupling.

Some fellows complain that they miss the extra grid and plate clips outside of the tuned circuit, to which they have been accustomed. Use 'em; go to it! However, they are likely to cause complications to 'set in' at 10 meters. If you like, you may

also QSY by means of clips rather than by the use of plug-in coils.

Even the method of keying has been questioned. Key wherever you would key any circuit—but *watch those clicks!* 9AEK keys in the primary of the plate transformer and solves the problem of 'tails' by

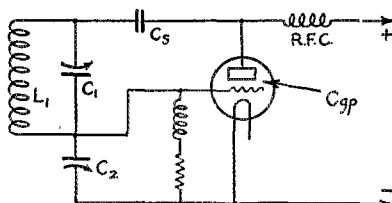

FIG. 1. AN ULTRAUDION CIRCUIT WITH THE STOPPING CONDENSER PLACED SO THAT THE HELIX ISN'T 'HOT'

Note that shunt feed and parallel tuning are used. C1L1 is the main tuned circuit. Of course the capacity C1 is shunted by a combination of the tube capacity Cgp and the stopping condenser Cs. C2 is the feedback-control which works in the opposite fashion from the usual regeneration control—that is the regeneration goes down as the capacity is raised—for which action the September 1927 story gives an explanation. C2 may have a max. capacity of 25 pfd. while C1 has a max. of about 500 pfd for 80 meters and so on down to 30 pfd for 5 meters, with corresponding changes in the coils as was shown in the September article.

using a filter which is not quite good enough to produce a d.c. note. Since the tails are d.c., they do not bother. Another scheme which might be used in this connection is to put a 'bleeder' on the filter; to connect a high resistance across the filter output. The resistance, of course, would need to be able to dissipate the necessary energy without undue heating, and the plate transformer capable of handling the additional load. A relay might be used to disconnect the 'bleeder' when the key is down, but look out for clicks. These schemes, of course, are applicable to any circuit.

Some have asked if a ground is necessary. 9AEK has no ground on its 'fifty' and the owner brags that his Ultraudion is more efficient than his old Hartley, W.A.C. and pride of his heart.

Some think that the helix must be 'hot'. What's the matter with Fig. 1? Surely it will work! The helix is at grid potential which isn't high enough to be dangerous.

Can self-rectification be used? I haven't tried Fig. 2, but it certainly ought to work.¹

Perhaps some of the foregoing state-

*9BHR, 210 N. Knox Ave., Topeka, Kansas.

ments are silly and some radical, but something of the sort seemed to be necessary in order to clear up a lot of misconceptions.

Now to clear up another erroneous impression. Some of you fellows seem to have gathered the idea that I am a radio engineer. I'm just *common ham*—the dumb variety that shies and runs at the first hint

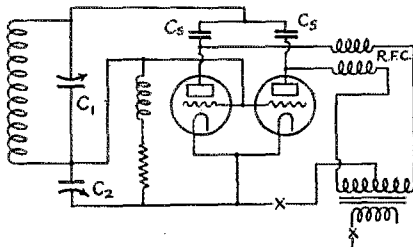

FIG. 2. A CIRCUIT FOR A. C. OPERATION WITH FULL-WAVE SELF-RECTIFICATION

of anything that sounds like mathematics; I'm even a rotten operator. I hear the gentleman in the back row mutter, 'Well then, where does the big stiff get the nerve to take up valuable space in *QST*?' The 'nerve', dear friend, is inherited from Irish

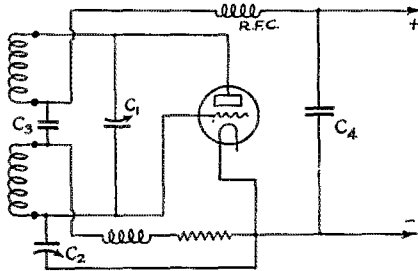

FIG. 3. A SERIES-FEED VERSION FOR 5, 10 AND 20-METER WORK. SEE FIGURE 4 FOR DETAILS

grandparents; the only reason my stuff gets into *QST* is because it's *ham stuff*! The kind of information we hams need the most can be obtained only from a fellow ham. If that ham happens to also be a college graduate, E.E., R.E., etc., so much the better, but we can't all be R.E.s, you know. Whenever I discover something

1. I have and it does. This is a nice chance to ask why we call two tubes on opposite side of a.c. "self-rectified" but never say "self-rectified" when only one is being used. Why? They are both operating "self-rectified" and the real difference is between a full-wave and half-wave self-rectified set. Tech Ed,

about radio that I think is new and useful, I feel it my duty to pass it on to the rest of the fraternity. The A.R.R.L., remember, is 'of, by and for' the amateur; no contributions, no *QST*. Afraid of your grammar? Send it in; H.Q. will fix it up so that the rest of the gang will think you're a college professor. Don't try to be brilliant. Do give your contribution a good injection of horse sense. Fellows, we're going to want all the 'dope' on the Ultraudion we can get when that 10-meter band opens up. Every fellow who discovers even just enough material to fill a 'stray' ought to quit riding for a minute and 'come across.' We fellows have a big advantage over the R.E.s inasmuch as we have no reputation to lose if we happen to 'pull a boner'—the editing at H. Q. will protect us, anyway.

Now let's consider the future. When the new international agreement becomes

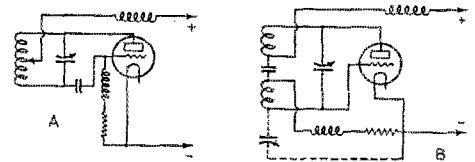

FIG. 4. HOW THE SERIES-FEED ARRANGEMENT WAS GOTTEN FROM THE USUAL FORM

(This is repeated from the September story in the hope that you will not recognize it.) At very short waves choke coils become less effective and all efforts must be made to cut down the voltage applied to them. At A, a clip has been put on the coil so as to feed where there is supposed to be no r.f. voltage. Another way of doing this thing is shown at B. The stopping condenser has been moved to the center of the "coil" (sometimes only a straight strip) in the fashion of the Hoffman version of the Colpitts circuit.

effective, we will have six amateur bands, all in harmonic relation with one another. The Ultraudion, with its ability to cover three such bands, makes it possible for those who have the time, money and desire, to make use of all of these bands with but two transmitters and two antennas. A receiver which will cover all bands might be built, but it is probable that most of us will also need two receivers.

Some fellows doubt the efficiency of chokes designed to cover three bands. It must be admitted that there is a 'best' choke for every wavelength, but the fact remains that a choke can be made to cover three bands and do the job in each band just as well as the chokes that are actually used in the average amateur one-band set. Let us suppose that you want a pair of chokes to cover the 40-, 80- and 160-meter bands. Here is my prescription: Select a

winding form not over $1\frac{1}{2}$ " in diameter. Select a wire-size as small as is consistent with the plate current of the tube you use, remembering that a single-layer winding has excellent cooling properties. Wind what you consider to be a good 160-meter choke. Wind another just like it. Now connect both chokes in their proper places in the set and test in each of the three bands with *antenna and counterpoise disconnected*. Watch the plate milliammeter for "dead spots" as you swing the tuning condenser across the band. If excessive plate current indicates a "dead spot" in one of the bands, remove $\frac{1}{4}$ " or so of the winding from each choke and repeat the test. If the "dead spot" remains or if one appears in another band, repeat the unwinding process. It sounds as if one would finish by removing the entire winding, but such is not the case.

I would suggest a similar procedure in winding chokes for the 5-, 10- and 20-meter bands, using a form not over $\frac{1}{2}$ " in diameter and spacing turns.

The circuit shown in the September article would be proper for a 40-, 80- and 160-meter transmitter. Fig. 3 is suggested for the 5-, 10- and 20-meter set.

Make C3 (in Fig. 3) as large as your purse will permit. Insert it in the helix about half-way between the center and the grid end. Don't try to find the exact node, because 'there ain't no such animal'. There is, of course, a node if we regard only the current and voltage which belong strictly to the tuned circuit, but this circuit *does not* present infinite impedance to the r.f. component of the plate current—hence there must be an r.f. voltage drop across the plate choke through which the plate current flows; that is, the whole of the r.f. voltage drop in the external plate circuit is divided between the tuned impedance and the plate choke in series, the tuned portion, of course, taking the major part of the drop. The reactance of the untuned choke is neither directly in phase nor directly out of phase with that of the tuned circuit and, therefore, is unlikely to either aid or hinder oscillation to any great extent.

C3 must be able to stand up under the plate voltage plus the grid bias voltage and must be able to carry the r.f. current of the tuned circuit without heating. If the set is to use low power, I suggest that you buy four good fixed condensers of the receiving variety of 2,000 pfd., or larger, capacity and connect them in series-parallel. The combination will have the same capacity as one of the condensers used alone, but the voltage breakdown and current-carrying capacity will be doubled. Mount C3 as close to the helix as the plug-in clips will permit.

Unless the filter is jammed right up against the transmitter—and it shouldn't be—the use of C4 is advisable for the purpose of by-passing whatever r.f. gets past the plate choke and thus keeping it from wandering all over the shack. 1,000 pfd. will probably provide ample capacity in the case of C4.

THE FEEDBACK CONTROL

An ordinary single-spaced receiving condenser may be used to control feedback in a fifty-watt Ultraudion set. The condenser may or may not stand up if used at C2 in Figs. 1, 2, 3 or 5, but will easily stand the 'gaff' if used in either of the positions indicated by the dotted lines of Fig. 5. In these positions the plate voltage is re-

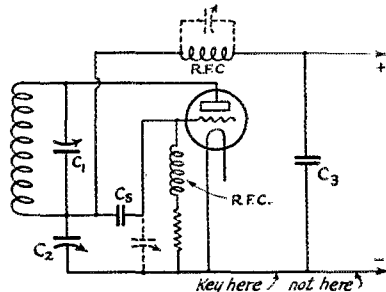

FIG. 5. THE FEEDBACK-CONTROL CONDENSER MAY BE USED IN SEVERAL WAYS

moved and the condenser has only to withstand the r.f. voltage applied to the grid.

If the connection across the plate choke is chosen, the last filter condenser, C3, should be moved up close to the set, as it is now a part of the r.f. circuit. See that the key is not on the wrong side of C3.

It is obvious that C2 shunts the r.f. chokes when used in any position and thereby forms a tuned circuit. The natural period of the circuit thus formed, however, is far removed (longer wavelength) from the transmitting frequency and for this reason it is possible for the functions of condenser and chokes to be separate.

The two chokes are practically in parallel where r.f. is concerned and, theoretically, it would seem a good idea to put them on an equal footing by shunting the grid leak with a fairly large fixed condenser. Such a condenser seems to make very little difference in actual practice, but it does tend to protect the leak if the grid choke happens to show 'fire' on the wrong end.

Now look up all the 5-meter 'dope' you can find and—let's go.

Recent Changes in Radio Law and Regulations

The 10-Meter Band Opened; Phone Waves Changed; Amateurs Defined; Washington Convention Ratified.

AT the urgent request of the American Radio Relay League the Federal Radio Commission has opened the 28,000-30,000 Kc. band at 10 meters to general amateur occupancy. This large band offers promise of relieving amateur congestion in the narrowed short-wave bands of next year if its secrets can be mastered, but obviously it must be available for experimentation before this end can be accomplished; therefore the request for its immediate opening.

The Commission has also altered the amateur phone allocations in accordance with the recommendations of the A.R.R.L. Board of Directors, as explained in detail in our last issue. At the same time a definition of the amateur station was adopted which will prevent the granting of amateur licenses for non-amateur purposes and protect our bands against invasion.

These matters are covered in the Commission's General Order No. 24, dated March 7, 1928, which reads as follows:

For the purpose of clarifying the amateur situation the Federal Radio Commission has adopted the following definition and regulation:

"An amateur station is a station operated by a person interested in radio technique solely with a personal aim and without pecuniary interest. Amateur licenses will not be issued to stations of other classes."

In accordance with the channels designated for amateur use under the new International Radiotelegraph Convention, the Federal Radio Commission has opened for amateur use the new additional band between 30,000 and 28,000 kilocycles, or 9.99 and 10.71 meters. The Radio Division of the Department of Commerce is hereby authorized to open this band immediately for amateur use.

The Federal Radio Commission has revised the list of radio telephone bands open for amateur operation to read as follows:

Kilocycles	Meters
64,000 to 56,000 or	4.69 to 5.35
3,550 to 3,500 or	84.5 to 85.7
2,000 to 1,715 or	150.0 to 175.0

Acting upon this authority the Department of Commerce has published revised amateur regulations summarizing all current orders, and here reprinted for the guidance of members:

REVISED AMATEUR REGULATIONS

March 6, 1928.

Supervisors of Radio and Others Concerned:

For your information and guidance the Federal Radio Commission has established the following regulations governing the licensing and operation of amateur radio stations. *These regulations supersede those dated October 25, 1927.*

An amateur station is a station operated by a person interested in radio technique solely with a personal aim and without a pecuniary interest. Amateur licenses will not be issued to stations of other classes.

Amateur radio stations are authorized for communication only with similarly licensed stations, except as indicated below, and on wavelengths or frequencies within the following bands:

Kilocycles	Meters
401,000 to 400,000	0.7477 to 0.7496
64,000 to 56,000	4.69 to 5.35
30,000 to 28,000	9.99 to 10.71
16,000 to 14,000	18.7 to 21.4
8,000 to 7,000	37.5 to 42.8
4,000 to 3,500	75.0 to 85.7
2,000 to 1,500	150.0 to 200.0

and at all times unless interference is caused with other radio services, in which event a silent period must be observed between the hours of 8:00 p.m. and 10:30 p.m., local time, and on Sundays during local church services.

Amateur radio telephone operation will be permitted only in the following bands:

Kilocycles	Meters
64,000 to 56,000	4.69 to 5.35
3,550 to 3,500	84.5 to 85.7
2,000 to 1,715	150.0 to 175.0

Spark transmitters will not be authorized for amateur use.

Amateur stations must use circuits loosely coupled to the radiating system or devices that will produce equivalent effects to minimize key impacts, harmonics and plate supply modulations. Conductive coupling, even though loose, will NOT be permitted, but this restriction shall not apply against the employment of transmission line feeder systems to Hertzian antennae.

Amateur stations are not permitted to communicate with commercial or government stations unless authorized by the licensing authority except in an emergency or for testing purposes. This restriction does not apply to communication with small pleasure craft such as yachts and motor boats holding limited commercial station licenses which may have difficulty in establishing communication with commercial or government stations.

Amateur stations are not authorized to broadcast news, music, lectures, sermons or any form of entertainment, or to conduct any form of commercial correspondence.

No person shall operate an amateur station except under and in accordance with an operator's license issued to him by the Secretary of Commerce.

W. D. TERRELL,
Chief, Radio Division.

The Washington International Radiotelegraph Convention of 1927 was ratified by the Senate in executive session on March 21st, and thus the United States becomes a party to the treaty. Its provisions do not become binding until January 1, 1929, and it is to be expected that the orders quoted above will be the basis of amateur regulation for the remainder of this year.

The Congress having failed to take action on new radio legislation by March 15th, the date on which the administrative authority of the Federal Radio Commission was to terminate, control passed to the Secretary of Commerce as provided under the 1927 Act. The Secretary, however, immediately delegated the Commission to carry on for

him, as is authorized in the Act, until Congress should take definite action on pending legislation. Eventually the new bill was passed and on March 28th was signed by the President, thus definitely continuing the Commission in administrative power. A bitter fight occurred over provisions of this bill relating to broadcasting, but there is little in it of concern to transmitting amateurs. The Act provides that the terms of the present members of the Commission shall expire at the end of one more year, the commission's authority and salaries being continued for another year. Broadcasting station licenses are to be issued for no longer than three months, and all other licenses for no more than one year. The Commission is directed to make a reallocation of broadcasting stations, wavelengths and power for each of the five zones.

The Commission at once extended all broadcasting licenses until May 1st and on March 27th issued the following order terminating all old *Department of Commerce* station licenses on August 31st.

GENERAL ORDER NO. 26

All licenses covering coastal, point-to-point, technical and training school, experimental, ship and amateur radio transmitting stations extended by the Federal Radio Commission General Orders 1 and 3, dated March 15 and 29, 1927, respectively, are hereby terminated on August 31, 1928.

Applications for new licenses or renewal in these classes must be filed with the Federal Radio Commission not later than July 31, 1928, through the Supervisor of Radio of the Department of Commerce, unless already filed.

All formal licenses in these classes issued by the Federal Radio Commission for definite periods subsequent to General Orders 1 and 3 are not affected by this order.

Thus the Commission definitely undertakes to put all stations under Commission licenses and, by calling for a new deal, prepares to take action in the commercial short-wave field. Particular attention is called to the last paragraph of the above order. As previously reported in *QST*, Supervisors of Radio are at present engaged in calling in old Department of Commerce licenses to amateur stations and replacing them with Commission licenses. This work is proceeding as rapidly as the clerical facilities of the district offices permit. By next month we expect to have definite instructions for amateur procedure under this order but it seems plain that if an amateur does not already possess a station license from the Federal Radio Commission and does not automatically receive blanks for making application therefor, he should write his Supervisor for the blanks in time to get the application filed prior to July 31st—particularly if he wants to retain his present call.

Speaking of application in advance of expiration date, we are reminded that there has been some confusion about the policy of the Department of Commerce with re-

spect to operators' licenses. Amateur operators' licenses may almost always be renewed upon application, without re-examination, provided the application is made before the license expires; otherwise examination is necessary. Nor can an amateur expect to be notified that his license is about to expire: it is up to him to watch his dates. The following is quoted from the January 31st issue of the *Radio Service Bulletin*:

Renewal licenses may be issued to operators of other (than commercial extra first—Ed.) classes without examination, provided the operator has had three months' satisfactory service during the last six months of the license term. One year satisfactory service out of two years of the license term may be accepted for renewal at the discretion of the examining officer.

Renewals or new licenses may be issued a reasonable length of time previous to the expiration of existing licenses, but must bear the exact date of issue, which must correspond with the date on the back of Form 756 forwarded to the Radio Division.

Operators who fail to apply for renewal of their licenses (This means operators' licenses—Ed.) on or prior to the date of expiration must be re-examined. If, because of circumstances over which the applicant has no control, an operator is unable to apply for renewal of license on or prior to the date of expiration, an affidavit may be submitted to the Radio Division through the Supervisor of Radio or examining officer, attesting to the facts, which will be considered by the Radio Division, which will advise the Supervisor of Radio or examining officer in regard to the issue of a renewal of the license without re-examination.

With increasing complexity of radio administration, we amateurs must now expect a sterner enforcement of regulations, particularly in anticipation of the difficulties of next year under the new convention. The Radio Division has many new inspectors and assistants in training school now, ready soon to proceed to the districts to assist in enforcement, and they are being supplied with test cars and elaborate measuring equipment. IAAH of Weymouth, Mass., has been suspended for six months for operating phone on 210 meters, complicated by having changed address without notifying and receiving the endorsement of the Supervisor. Wholesale housecleaning of off-wave amateurs is to be expected at once. Every amateur should watch his step and comply strictly with regulations.

—K. E. W.

Getting Started at 30 Mc.

(Concluded from page 10)

All of which cooks down to this: if we will just use the information we have had for the last two years it *should* be easy to find out things about 30 Mc. by the end of August. We will *not* do it unless there is much more coöperation than there ever was on 20 and 5 meters.

Rotten DX

By the Old Man

SAY SON, something's got to be done by someone about this bum DX business. I have studiously refrained from venturing my opinion of it for a long time because of the laws regarding profane language in print. I cannot hold in any longer and by gorm here goes.

I suppose that two-thirds of the boys I have hooked up with lately on the forty-meter band have kissed me good-bye because I was not DX enough. Say—where has a man got to live to be DX? These rascals holler their heads off CQing until you begin to believe they are in need of help. When you feel sorry for some poor gink and call his back, thinking to assuage his hungry soul with a little chat, you find he quickly glances over the walls of his shack and when he finds he has already accumulated four of your QSL cards, he drops you like a hot potato and bursts out again in a CQ yell.

Have these poor creatures got bitten by some kind of a bug, or something, or what it is that ails them?

I'll be keelhauled if I answer any more CQ's unless the gent indicates by some Q signal that he is not afflicted with DX-itis. How are we to know the blamed disease is not catching?

To-night, sitting here with Kitty, I answered a "six" whose soul seemed to be yearning for something or other. A "six" used to send the hair up on the back of my



"SAY- WHERE HAS A MAN GOT TO LIVE TO BE DX?"

neck and thrill me all through. But this piece of pork came back saying, "Abt R4 OB FB want DX CUAGN ta ta de dah de dah" and went off into another CQ spasm without even breaking.

I just about lost what little I have left of a sweet disposition, and Kitty, being within range, got spat upon promptly and copiously.

Renouncing my own country in disgust I, twisted into the foreign band and ran across

a Frenchman squalling for somebody to answer him.

I answered, thinking here's a polite nationality, known down the centuries for holding all long—and short—distance records for gentlemanly behavior. If he hears me, which he will not, he will respond in the good old-fashioned way and we shall have a nice little bit of two-way communication.

By golly he came back! The hair went up on the back of my neck and the thrills surged up and down my insides the way



-- WE SPEND OUR JUICE AND OUR TIME GRUBBING FOR QSL CARDS.

they do when you hook on to some chap you never hoped to get. Finishing my call he said, "GM OM Abt R4 want DX CUAGN 73 ta ta de dah de dah" and garbed if he didn't burst out in more CQ flames!

Kitty was over across the shack cleaning up, so I hove the corn cob at her, slammed down the cans and delivered myself of my favorite and most profane expletive, which is, "Well Garb Bish his Zork", and spent the rest of the evening reading "Calls Heard".

I say it's time to vaccinate somebody or something. Here we are, a world full of amateurs, able to communicate two-way anywhere upon this 'ere earth, and instead of doing something worth while we spend our juice and our time grubbing for QSL cards.

Who is going to care a thousand years hence whether George collected an acre of QSL cards or not? What we want is efficient, reliable and consistent two-way telegraphic communication. That's where the big thrill comes from. That's what we are here for.

I'll be gormed if I don't wouff-hong the next gazaybo who tells me he wants DX and a QSL card. It's enough to make a man swear and call the cat a litch. There now!

Amateur Television

By Paul H. Thomsen*

THE General Electric Company, at Schenectady, is experimentally broadcasting television¹.

These are all the data that are needed to enable the amateur to pick up these signals and make a picture out of them.

It will be recalled that when Mr. C. Francis Jenkins, himself a member of the A.R.R.L., showed government officials visiting his laboratory, June 13, 1925, what was happening at the moment in the Anacostia Navy Radio Shack, NOF; he made the prediction that sooner or later the amateur would get a new kick out of radio by picking pictures out of the air. The first published account of this work appeared in *QST* for July of that year.

The purpose of the following description is to point out the essentials in the method and show how simple the receiving apparatus may be.

Reduced to its lowest terms, television reception consists of some white and black dots arranged in proper order on a flat screen at persistence-of-vision speed. This is strikingly illustrated when one cuts off the motor, and discovers that the picture instantly vanishes, and in place of it is a great collection of unrelated dots.

With a neon lamp costing one dollar, and almost any motor to rotate a suitable disc, these radio signals can be made into a picture. While with the only lamps available at present, the pictures will not be very large, it is fair to suppose that more suitable lamps will be available soon. The lamp first referred to is the General Electric Co's G-10 lamp, $\frac{1}{4}$ watt, cylindrical electrodes, medium screw base.

The motor should be at least 1/16 h.p., and preferably attached to the house-lighting circuit. A flanged hub is mounted on the motor shaft to carry the scanning disc.

The disc is 12" in diameter and has 48 tiny holes therein, arranged about $\frac{5}{16}$ " apart and in a spiral of a mean diameter of $9\frac{1}{2}$ ". The holes should be approximately $\frac{1}{32}$ " in diameter; and the inner end of the spiral is $\frac{5}{8}$ " shorter radius than the outside end. (See Fig. 1.)

The neon lamp is attached, like a loud-speaker, to a radio receiving set, with perhaps 250 volts of battery in circuit. You may find it desirable to increase the bias on the grid. The incoming signals blink this light in a picture order.

*3LA, 1456 Clifton Street, N. W., Washington, D. C.

1. Information as to transmitting schedules and wavelength has not been announced but the signals can be located by listening for them.—Ed.

You can listen to these picture signals but they don't make sense. However, if you will start the motor and look at the neon lamp through the flying holes in the disc

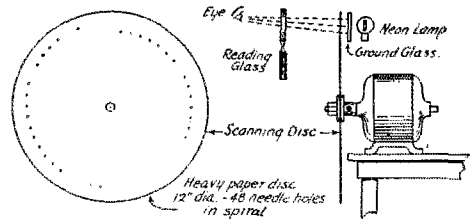

FIG. 1

you will see a lot of black and white dots and dashes scattered over the picture area, and probably without intelligible order at first.

If, however, the speed of the disc is slowly increased until it is in synchronism with the transmitting station, a perfectly formed picture suddenly flashes out in the picture plane.

The picture will tend to move to the right or to the left, but by increasing or decreasing the speed of the motor the picture can be held rather steady in the lighted plane.

If you are in the d.c. district, a d.c. motor

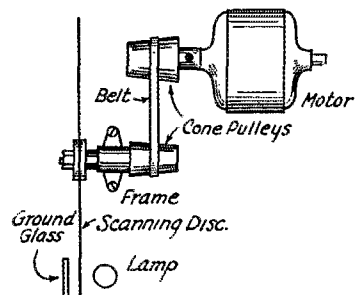

FIG. 2

with an adjustable rheostat in the field of the motor, gives the necessary speed adjustment to bring the disc into synchronism with the transmitting station. Another smaller adjustable resistance in series as a vernier helps to more easily hold the motor in synchronism.

If you have only a.c. juice available then the cone pulley arrangement shown in the

illustration is better. For that matter, the cone pulley scheme can be worked with any kind of motor. (See Fig. 2.)

The making of the disc is not difficult. Get a cardboard, or black piece of paper, or

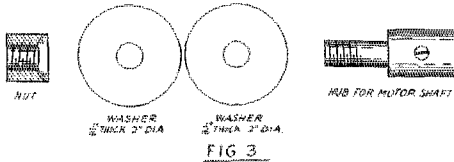

even the cover of dad's Saturday Evening Post. Cut a 12-inch disc out of it, with an accurately located centre opening to go on the flanged hub on the motor. On this disc lay off 48 dots, spaced very accurately in even decrements of radius to give about a $\frac{3}{8}$ " offset of the ends of the resultant spiral arrangement of dots on the disc.

Now take a sewing needle. Break off the eye and the point. This is to be used as a punch to cut tiny holes in the disc where you put the dots. If you find the needle hard to hold, put it in a small stick, and hold the stick. Lay the disc on a block of wood sawed so short that the punching can be done in the end grain of the wood. Or get a piece of lead, and scrape it smooth, and cut the holes in the disc by punching out tiny discs of paper, with the needle-punch, which will leave the holes in the paper cut clean.

Of course, thin metal sheet or bakelite, or most any other material can be substituted for the paper or thin cardboard disc, but the paper disc is easier to make and is just as good if it is not torn.

About the only thing you will need to get made outside is a suitable hub, with nut and two washers between which latter the disc is clamped. The illustration shows how it should be made. (See Fig. 3.)

A ground-glass plate about 1" square is mounted near the rotating disc. It may be on either side, that is, next to the lamp, or on the opposite side of the disc from the lamp, in alignment with the holes in the disc. In the first mentioned position one looks at the illuminated disc through the tiny holes; in the other position the glass is illuminated by light from the lamp shining through flying holes, to build up the picture.

The ground-glass can be made, if it is not readily available, by rubbing a piece of clear glass on very fine sandpaper to which a little oil or turpentine has been applied.

Of course, mat celluloid film or mat surface mica will also answer very well. The impression of good workmanship is heightened if one mounts it in a small frame, like a picture frame.

The radio picture signals broadcast by WGY are sent out from pictures made up

of 48 lines to the picture. The rate is about 16 to 18 complete pictures per second, but to know the exact rate is not important because the motor of the receiving machine is speeded up until the picture appears, no matter what the rate may be.

The received picture can be made to seem about a $1\frac{1}{2}$ " square by looking at it through a reading glass, or a condenser lens such as is used in magic lanterns and motion picture theatre projectors.

We understand Mr. Jenkins will also be broadcasting movies soon, with the same number of lines per picture, which will add another source of pictures for the amateur.

Central Division Convention

May 25, 26, 27, Milwaukee, Wis.

YES! fellows, the Milwaukee Radio Amateurs' Club is taking the bull by the horns and is sponsoring the first big Central Division Convention to be held at the Republican Hotel in Milwaukee, Wisconsin, on the above dates.

The mayor of the city will give the address of welcome to the delegates. Lectures and demonstrations of electrical phenomena will be given at the School of Engineering. Entertainments of all kinds have been arranged to give those who attend all the pleasure possible. Prizes will be awarded to winners of stunts.

Two men from A.R.R.L. Headquarters will be with us; F. E. Handy, Communications Manager and one other. We are doing our best to prevail upon Secretary-Editor K. B. Warner to drop his mantle of responsibility and be our guest of honor. Director Darr will be here and act as toastmaster.

From the above you see what we are trying to do for you and we extend to everybody a cordial invitation to attend.

Let's hear from you, gang. Write Frank J. Jutrash, 9ALL, Chairman, 385 Eleventh Ave., Apt. 5, Milwaukee, Wis., for reservations.

Strays

Durham metalized resistors may now be obtained in values from 250 to 3,000 ohms. They are designed for use in grid circuits of radio frequency amplifiers to keep them from oscillating. The fact that they have a very small amount of self inductance and capacity should make them suitable for various jobs around the work table of the experimenter.

Practical Audio Filters

By L. W. Hatry*

THIS is a strictly practical discussion so I can discuss 10X conditions and enjoy myself. A newspaper office is generally a bum place in which to talk amateur radio, in addition to being a bum place to have an amateur station anyhow.

With fifteen or twenty linotypes, each with its electric motor, three metal saws, lathes, presses, punches, drills, compressors, an elevator and a door with a squeak I find myself harassed with not less than 1,391 different noises including WIZ and programs from WTIC. How to cure it? Ask the guy with the mania for by-passing his a.f. transformer secondary. Says he, "What you need is a low-pass amplifier." This actually gets rid of $\frac{1}{2}$ of 1% of annoyance and brings the set within the prohibition amendment.

The amplifier I use goes down and dredges up bass, and I find it useful because of that alone, but also at times I find it useless when used only with treble filtering. After I by-pass to get low-pass (and succeed) I also get a nice husky rumble which makes my headset sound like Rip Van Winkle's dream. The cause of the rumble was easy to discover without extensive meditation or cerebration: 10X lives twenty feet from a nice husky compressor which shakes the floor, the receiver, the transmitter and my teeth. Mechanical vibration generates unnecessary bass in my set. Shunt capacity wasn't all I needed! I had to filter out some bass and lose that rumble, as well as filter out the treble and lose hisses and other higher noises. Figure 10, which is detailed further along in this article, was assembled for the purpose from a box full of Electrad fixed condensers, an A.F.T. primary (General Radio, incidentally) and a bunch of test leads with clips to allow quick change. The final result of high and low filtering was a quiet headset (except for some clicks) and some pleasure in reception.

This introduction is being written in full view of a short note about 300 words long in which Kruse tells me I have not said positively that I *tried* any of the things this article tells about. I do therefore this day appear before myself and swear that this is the whole truth and nothing else but; (1), that I have tried each and every one of these things and that each and every one of them worked except when the test clips shorted against each other, or the condenser cases, or choke cores, or on general

principle, and (2), furthermore I can prove the whole of this by the tube that got burned out trying to assimilate 45 volts

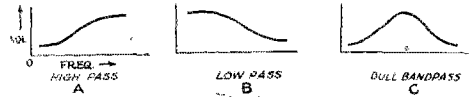

FIG. 1. THE MEANING OF HIGH PASS, LOW PASS AND BANDPASS

Where the curve is low the signal has been cut down.

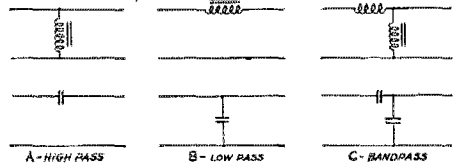

FIG. 2. THE SIMPLEST POSSIBLE MEANS OF GETTING (a) HIGH PASS, (b) LOW PASS, AND (c) BANDPASS

None of these simple affairs give sharp cutoffs but it does not matter for the present purpose.

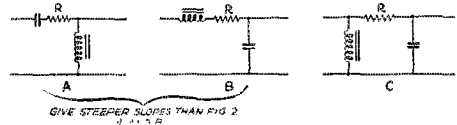

FIG. 3. AS IN FIG. 2 WE HAVE HERE FROM LEFT TO RIGHT, (a) LOW PASS, (b) HIGH PASS AND (c) BANDPASS

The curves of a and b will have rather sharper cutoff than the ones shown in the same position in Fig 2.

from a Burgess (adv't.) B battery, a procedure which I had often warned that tube against.

But to be serious, and to make this article useful, let's start at the beginning of filtering in an a.f. amplifier, telling the methods that may be used and why in theory and end up with the specific practical methods which evolve therefrom. Therefore, proceed.

WHAT THE FILTERING DOES

Audio filtering is desirable and necessary because: 1, it reduces background noises which mask signals; 2, it increases selectivity because it tends to keep out beat notes of a pitch within the filtering limits.

I shall neglect setting a position for the

*Radio Editor, *Hartford Times*, Hartford, Connecticut.

filter. It may be on the first or second a.f. transformer, or at the headset. I can't find a preferable location for it.

What may be done toward choosing some frequencies and eliminating some others best may be summarized in three curves as shown in Fig. 1. In A we represent high-pass selection or filtering, the lower fre-

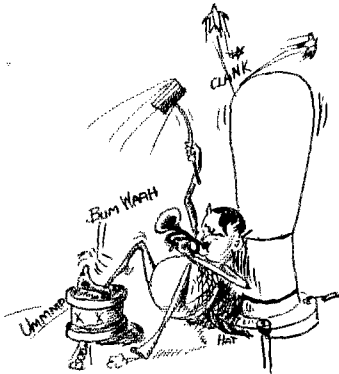

ONE OF THE PRINTERS' DEVILS HELPS AT 10X

quencies are variously obstructed. And so on to C which attenuates on both sides of one frequency. We have some control of the cut-off, the slope may start at approxi-

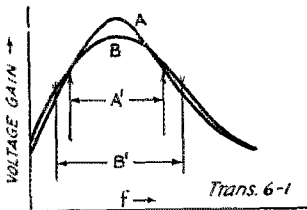

FIG. 4. RESULT OF INSUFFICIENT GRID BIAS IN BROADENING A PEAKED TRANSFORMER

Curve a is with proper bias, b with insufficient bias. In Morecroft ¹ the cutoff is considered as having become important when the voltage gain has dropped $\frac{1}{4}$. By this rule curve A at the point A' spans from 275 to 1300 cycles while B at B' spans from 190 to 1800, a difference of nearly 500 cycles! In general the effect of any secondary load is to flatten the peak without greatly widening the lower part of the curve. The transformer does not pass more frequencies, simply the proportion between those amplified is altered.

mately any frequency within the a.f. range. Similarly we have means that allow us to shift the peak of a curve like C to wherever in the a.f. range we wish.

Note. 1. Page 918 Prin. Radio Com. 2nd. Ed. for curve. Pp 905 to 920 for general discussion.

The simplest filters are the condenser and the coil. Both may be used for purposes of producing curves such as Fig. 1, A, B or C.

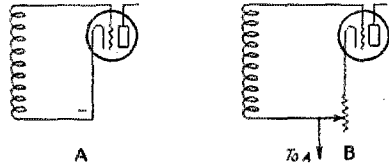

FIG. 5. GRID RETURN TO GIVE BEST RESULTS FROM A PEAKED TRANSFORMER

The return shown at B, or else a one-cell (1½ volt) grid bias is recommended.

In combination, generally, they may be used to steepen the slope of cutoff, to increase selectivity. Simple filter units used in the line to give curves of the type of A, B and C in Fig. 1 are lettered similarly in Fig. 2 in order that comparison will be facilitated, and similarly Fig. 3.

SOME DEFINITIONS

In the amateur language which we will use in this article a "tuned" transformer is as selective as a single transformer can be (Erla made one but it was often not used correctly as will be shown) while a "peaked" transformer is not as selective but is best at one frequency. (Old R.C.A. 9/1, old Acme 4½/1, Thordarson 5/1, Hedgehog 3/1, and some others, all of which were also misused.) Finally the "good" transformer is the modern broadcast listener's type costing \$6 and up at list and having weight in proportion.

If all waves were "d.c.c.w. with crystal control" a sharply tuned amplifier would be the only sensible kind. Since there are such waves, and since they gradually become more numerous let us think about the proper use of such tuned or peaked transformers.

THE EFFECT OF GRID BIAS

From Fig. 4, if a transformer has a peak, and we wish to preserve the peak, the load on the secondary must be minimized. The grid should, as much as possible be kept from drawing current. The ordinary grid return is to the negative leg of the filament as in A of Fig. 5. The positive half of the a.f. thus swings the grid positive, as F minus is the point of lowest potential natural to a tube. When the grid goes positive the load resistance is lowered; the BCL when compelled to use such transformers improves quality by shunting fixed resistors across the secondary, thus lowering the load resistance and thereby decreasing the ac-

centration of certain frequencies (or flattening the peak).

On the other hand, when we want the peak to be there and do business such resistances must not be used, likewise we must make sure that the grid never goes positive; This can be done by connecting as in Fig. 5 which puts the rheostat drop on the

the amplifier is incomplete if only the upper end of the a.f. band may be attenuated. To modify at the bass end, a shunt primary choke accomplishes effects which are graphically shown in Fig. 7. To have both in an amplifier is only sensible, and this is possible from a single switch as shown in Fig. 8, an arrangement I found very useful.

With the switch arranged as in Fig. 8, rotation gives only the very high, and then more and more into the bass. After that, beginning on the capacities, a little treble cut-off, and more and more until only the very low tones are left. But although such a simple switching arrangement is handy, two switches would be better, one for the bass and one for the treble cut-off, so that a combination of both will make a peak (Fig. 9) at any one of three places in the spectrum at will. The more taps on the inductance or the more capacities available the more control of cut-offs obtainable and the greater number of peaks may be placed, but I find three choices each of capacity and inductance sufficient.

I have tried a number of stunts, all of which are fairly simple, and which have various merits. Fig. 10 requires one switch for control. It progressively attenuates both ends of the band as it is advanced and it ends by giving a peak. The series condenser attenuates bass and the shunt condenser attenuates treble. When attached to the headset, a detector or amplifier may be used without reconstruction. As the switch lever progresses to the right it causes reduced series and increased shunt

capacity, cutting both bass and treble progressively. The same effect with a choke is obtained by B. Only here the shunt choke attenuates bass while the series portion attenuates treble. In both cases where the switch connects directly to plate the choke is so large or the capacity so low, that no particular effect at filtering is experienced. In A of Fig 10 the shunt battery choke L, is used only to keep the a.c. to the phone path. A fixed resistance of 25,000 ohms is just as good and is cheaper. The choke would be the primary of an a.f. transformer, or at least 5 henrys although more inductance is desirable; 20 hys. being the maximum desirable. Of course, either 10A or B may be applied earlier in the audio system, for instance, to the primary of an a.f. transformer, in which case L would be 50 hys. or a fixed resistance of 50,000 ohms.

Fig. 11 shows three other simple arrangements. The variable resistance gives control of cut-off, whether high or low. Again

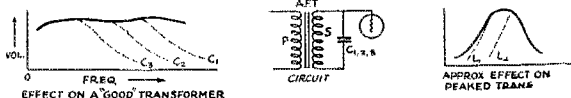

FIG. 6. THE EFFECT OF A SHUNT CONDENSER ON A "GOOD" TRANSFORMER, WHICH IS TO SAY A MODERN BCL TRANSFORMER WITH A FLAT CURVE SUCH AS SHOWN BY THE HEAVY LINE

A small capacity C1 gives the curve labeled accordingly. a larger one gives C2 and so on. Note that for the peaked transformer the effect is not important.

grid as bias and since we can run a 201-A filament at 4½ volts this makes possible a bias around 1½ volts, and not even the strongest signal from the detector is likely.

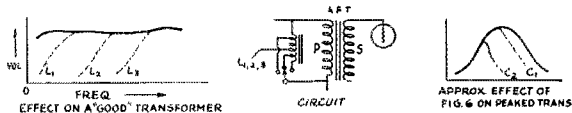

FIG. 7. THE EFFECT OF A SHUNT INDUCTANCE ON A "GOOD" TRANSFORMER

As the inductance of the choke is cut down we have in turn the curves L1, L2 and so on. Compare this with Fig. 6. Notice that in both cases the curve is cut away more and more as the reactance of the shunt is reduced. Note also that as before with the peaked transformer the gain in sharpness isn't worth bothering with.

to exceed that, therefore the grid will not go positive at any time, and therefore the sharpness will be preserved. The bias may of course be gotten from a C battery. At any rate, complaints of lack of selectivity from peaked or tuned transformers mostly may be laid at the door of improper negative grid bias for the amplifying tube or tubes.

CUTTING THE LOW END

Without any modifier of its frequency characteristic an a.f. amplifier is certainly inflexible. The simple filters, condenser or choke, provide the necessary modifiers. Consider the condenser's effect upon a good transformer, such as the Sangamo, which has a curve of the general type shown in Fig. 6. This figure shows the modifying effects, of three capacities shunted across the secondary. Obviously the flexibility of

the ideas are applicable at any earlier position in the a.f. net, but the choke as in the case of Fig. 8 must be across the primary

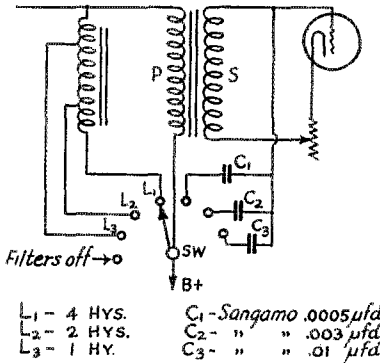

FIG. 8. A SWITCHING SCHEME THAT WILL GIVE SUCH CURVES AS SHOWN IN FIGS. 6 AND 7

It would be better to provide two switches, one for the capacities and one for the choke so that both ends can be cut at once. The capacities can be bought, the chokes must be made.

while the condenser is across the secondary. As an example of peculiar methods of getting a filtering effect when no other scheme is available and something must be



FIG. 9. THE EFFECT OF A PRIMARY SHUNT CHOKE AND A SECONDARY SHUNT CAPACITY IN PRODUCING PEAKS AND HIGH OR LOW CUTOFFS.

The effects are as follows:

Primary Shunt Choke	Secondary Shunt Capacity	Passes
8 henry	.005 $\mu\text{fd.}$	peak at 250
4 henry	.0025 $\mu\text{fd.}$	peak at 500
2 henry	.0015 $\mu\text{fd.}$	peak at 1000
16 henry	.015 $\mu\text{fd.}$	peak at 120
none	.05 $\mu\text{fd.}$	60 cycles and down
1	none	2000 " & up
1/2	none	4000 " & up

The effects would be somewhat different with other transformers than the Sangamo.

done, consider Fig. 12. Here is a large choke L, of 30 henrys, keeps the a.f. to the transformer while R and battery D load the core of the A.F.T. with a fixed magnetic field under control of R. Saturation of the A.F.T. core cuts down the inductance of P and causes high cut-off under control. The limit of current is that which heats the

A.F.T. somewhat. D would be 40 volts and R 25,000 ohms maximum.

We should not forget that even with a "good" transformer a peaked effect may be gotten by using a tube with excessive plate impedance. The "good" transformer, being designed for the 201-A begins to suffer with

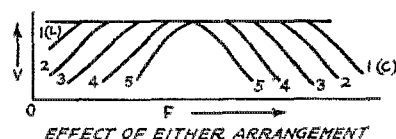
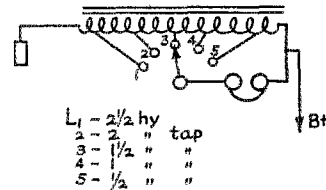
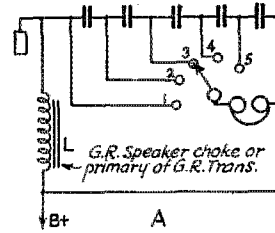

FIG. 10. A SIMPLE CONDENSER OR CHOKE STUNT FOR SHARPENING UP BY STEPS AND FINISHING WITH A PEAK

When using the condensers as shown at A the C in series with the phones cut the low notes and those in shunt cut the high notes. When using the inductances as shown at B the series L cuts down the high and the shunt L cuts down the low notes. The switch arrangement is such that with either the effect is to make the peak sharper as the switch is turned from 1 to 5.

the 240 high mu to some extent, and with the shield-grid tube shows a fairly sharp peak.

No tuned filters are included. My general criticism of them is due to their tendency when sharp to have a decrement that allows them to hang on to clicks with the twang peculiar to their natural period. If the click is going to "sing", as it will with tuned filters or transformers, it is an annoyance to me of a major order. Tuned traps have received attention in other numbers of QST.

More elaborate filter nets are easy to construct. Their selectivity may be made excellent, for band or single frequency pur-

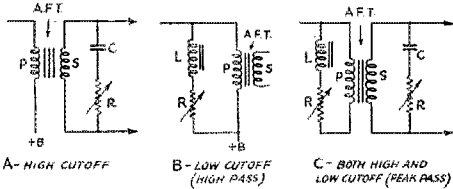

FIG. 11. WHEN A SWITCH ISN'T HANDY ONE MAY USE A VARIABLE RESISTANCE TO CHANGE THE EFFECT OF THE SHUNT OR CONDENSER

Otherwise this scheme is much the same as earlier ones. When used as shown the values are: C .2 μ l., L .5 henry, R Royalty, Prosl. Electrad (or the like) rheostat, 25,000 ohms. Either the RC or the LC combination or both may be used across the phones.

poses. But when that is accomplished their inflexibility is great, nearly as great as their expense and constructional difficulty. But don't avoid experimenting with them for they teach excellent lessons. For the best set of easy to use information on the sub-

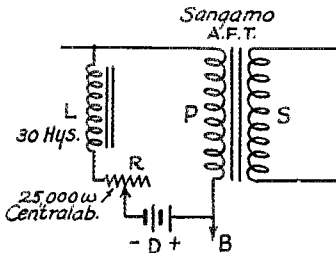
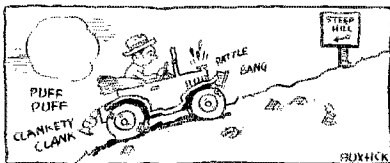

FIG. 12. A FREAK METHOD OF MAKING A MISFIT CHOKE DO THE WORK OF CUTTING OFF LOW END

As the current of battery D is increased the core of the A.F.T. is gradually saturated, its effective inductance cut down and therefore it becomes unable to pass low notes.

ject consult the July and August 1923 QST's for the articles by Dellenbaugh, nothing in radio literature on the subject is as clearly explained; or as easily handled by the man able to work arithmetic with symbols as well as figures.



Some Changes at Headquarters

WITH great regret QST announces the separation from its staff of Mr. Robert S. Kruse, for the last five years its Technical Editor. Mr. Kruse has resigned in order to launch on his own in the radio consulting field, retaining his residence at West Hartford, QST for January of 1923 first bore his name as Technical Editor and his work in the ensuing five years is known wherever amateur radio is known. His lucid writings have created an enviable reputation for him and for QST, and under his technical direction QST has become a world-respected medium in the radio field. Best wishes, "LQ"!

Mr. Harold P. Westman, for the past year and a half the Assistant Technical Editor of QST, succeeds Mr. Kruse as Technical Editor. His long and varied radio experience along development and experimental lines, and his recent work in the constructional field as evidenced by his articles in QST, assure him of success in his new duties. Mr. Westman was in charge of 2BQH and the Segal Radio Laboratory at Mamaroneck, N. Y., before he joined the QST staff and he has since been known as 1AL and as partner in 1DQ. Prior to his tenure as Assistant Technical Editor, he conducted the A.R.R.L. Technical Information Service.

Mr. Ross A. Hull, ex-0a3JU, for the past year in charge of the A.R.R.L. Technical Information Service and Experimenters' Section, has accepted an appointment as Associate Technical Editor, in which duties he will be associated with Mr. Westman in the technical editorship of the magazine. He will also be in charge of the A. R. R. L. technical development program over the remainder of this year, a subject discussed at some length on this month's editorial page.

Mr. James J. Lamb, 3CEI and ex-9CEI, has joined our staff to assume the Technical Information Service and the management of the Experimenters' Section. Mr. Lamb is the author of the article describing a portable receiver, published in our April number.

Mr. G. Donald Meserve, of 1FL, Hudson, Mass., ex-president of the Eastern Massachusetts Amateur Radio Assoc., has joined us to become QST's Assistant Advertising Manager.

For those who still wonder who "RP" at 1MK is, let us say that this is the sine of 1MK's new Chief Op, Mr. R. B. Parmenter, formerly of 9WR-90X, Louisville.

It will be noted that we do have openings at A.R.R.L. Headquarters, and in a variety of occupations. Qualified A.R.R.L. mem-

bers are logical candidates when vacancies occur. The headquarters office would be glad to have applications on file from interested members, for consideration in such events, reciting fully their attainments and qualifications.

—K.B.W.

Strays

Howard F. Mason (no further identification needed) tells us that the Bureau of Standards will tell you the frequency of your crystal within a gnat's eyebrow if you will send them twelve dollars together with your crystal, holder and oscillator unit. By using harmonics of the crystal circuit and another oscillator, it is possible to get accurate calibrations of frequency meters.

We are told by E. Kohls that 6BSB has recently purchased some bird seed for his slop-jar rectifier. He hopes to get one of these "peep peep" notes.

A simple way of making a substitute gimlet is to clamp a small twist drill in a two-inch dial. We don't know who to blame for this idea as it was swiped from a carpenter who was installing a lock at hdq. We suppose it may be just another proof of how radio is revolutionizing other industries.

McMinn of 2WC made 37 points in the International Contest which he believes will entitle him to a binding post or about eight inches of BX.

When removing bases from tubes, a simple method is to put the whole tube in boiling water for about five minutes. Then, twist the glass part and it will come loose from the base. Hold the tube, prongs downward and touch the ends of the prongs to the tip of a very hot soldering iron. After a moment, the solder can be flipped out with a snap of the wrist which will leave the leads running through the prongs free. This is much less painful than busting the glass and digging the remains out.

—A. S. Mason.

Let's Be Tolerant

By Hiram Percy Maxim, President A.R.R.L.

Not so long ago the fellow who advocated C.W. was regarded as an enemy of amateur radio. The spark was the thing, and no amateur with true amateur spirit could consider C.W. I remember some of us used to print on our QSL cards "The spark forever".

To-day there are a lot of us who regard phone as something derogatory, and beneath notice. Is it possible that we may be making the same mistake as the fellows who scorned C.W.?

Times change, and we have to change with them. The thing we sneer at to-day is often the whole works to-morrow. The older a person grows, the more he realizes this continual change. Thus it comes about that the older among us are the more patient and tolerant.

It is with this in mind that I am sorry when I see the attitude of some of us toward amateur phone. Phone does not require a knowledge and a proficiency in handling code. People can phone who cannot communicate by dot and dash. The dot and dash man will always have something up his sleeve that the phone man never can have. But many of our best dot-and-dash men are interested in phone. How do we know that this phone bug might not bite some of us who now sneer at it? Are not our ideas regarding phone likely to change profoundly, should the little bug by chance pick us out to bite? And will not we expect decent treatment when we get to fooling around on the air with our phone? And so, until we know more than we now know, would it not be prudent to be tolerant toward the fellow who has different ideas regarding phone than we may happen to have at the present time?

Let's be tolerant. Let's remember the early days of C.W. vs. Spark. Besides, there's nothing to fear. Code will never go out. We do not have to say "V as in Victoria" nor "Z as in Zebra" in code. The dots and dashes can be counted, and there is no doubt. Our code is as safe as the ages. We code men can easily afford to be tolerant.

The Twin City Vigilance Committee

By Carleton H. Kohler*

As we have mentioned in recent issues, the amateur-listener interference situation is again acute. This article describes the excellent work of the amateurs of Minneapolis and St. Paul in caring for this situation. We hope that it may serve as an inspiration to other clubs to undertake similar work and as a guide to individual amateurs everywhere. The Chicago Radio Traffic Association is taking care of Chicago needs in a similar arrangement. Where are all the rest of the cities?—Editor.

THE amateur interference situation had, for some time, been growing increasingly serious in Minneapolis and it was deemed necessary that something be done at once. The relations between the Minneapolis amateur and the broadcast listener, and between the amateur and the City of Minneapolis, had been unduly strained for a considerable period of time. Consequently, early this year a Committee on Amateur Interference was formed by the executive council of the Twin City Radio Club to aid in bringing about a readjustment of affairs.

We were faced with the possibility that silent hours from 6 p.m. to 12 a.m. would be made compulsory for all amateur stations in this vicinity unless immediate action was taken to relieve the QRM situation. Therefore the Committee on Amateur Interference gave Twin City amateurs decisive notice that interference on their part would no longer be tolerated. We have discovered that, for the most part, only a few stations were causing interference, and as we felt that such interference could be eliminated, we justly decided that we would ostracize any amateur not cooperating with us. Surely we cannot let the uncompromising attitude of a few amateurs definitely injure the well-being of the majority. In addition, due to the rather chaotic conditions here, amateurs of this vicinity were being blamed for interference not caused by them at all. Briefly, then, we came to the conclusion that prompt, vigorous action would have to be taken if we were ever to rectify this complex and unsatisfactory state of affairs.

Now, however, that the Committee has been formed, we are cooperating directly with the City of Minneapolis through Mr. O. M. Frykman, City Electrical Inspector, and also we have the backing of and are cooperating with the Supervisor of Radio at Chicago.

The effect of these arrangements has been very gratifying, for the Minneapolis amateur now has the good-will of the city officials and the general public, and as a result of the work complaints of amateur interference have decreased practically to zero.

Our Committee not only has arranged to be informed of, to investigate and to adjust all complaints received by the radio office at Chicago and the Minneapolis city authorities, but also we have arranged to supply the Supervisor at Chicago and the City of Minneapolis with complete details of every interference case investigated by us. We have, in addition, requested the Supervisor to call upon us at any time for special investigations and reports. Thus the office at Chicago is able to have in its files a complete report on all complaints originating in this vicinity. To show to what an extent Mr. H. D. Hayes, the Supervisor, appreciates the help rendered to his office and the broadcast listeners of this territory, I quote from one of his letters:

This office appreciates the cooperation thus extended to the broadcast listeners and believes that your action will tend to prove to the general public that the amateurs, both individually and collectively, are not only willing but anxious to assist in making radio conditions as near ideal as possible, especially as far as unnecessary interference is concerned.

In order that the amateurs may be more than ever in a position to show that they are a more or less self-regulatory body and that they will play the game when given a chance, this office will until further notice refer to you personally, as chairman of the amateur interference committee in Minneapolis, all reports of amateur interference received from that vicinity, with the request that through your organization you will make every effort either to relieve the condition complained of or attempt to satisfy the complainant that his complaint is one that cannot be remedied by the amateurs, either due to the interference experienced by him being caused by the operation of electrical equipment, other than radio transmitters, or possibly by the limitations of his particular type of receiver and receiving installation.

In the operations of the Amateur Interference Committee we make it a practice to investigate personally every complaint received and to adjust the situation definitely in order that the complainant will

*9EFO-9EZM; chairman and manager of Amateur Interference Committee, Twin City Radio Club; 2000 Humboldt Ave., South, Minneapolis.

have no further reason for protest. This has stopped the flow of complaints to the Federal authorities.

In order to inform the general public of the existence of the Committee and to convince them that we are here to serve them, we have had the cooperation of Minneapolis newspapers. One member of our Committee looks after publicity. We have spent considerable time during meetings of the Twin City Radio Club in discussing ways and means of preventing interference to broadcast reception as caused by the operation of amateur transmitters, and so far we have been quite successful in devising means for eliminating such interference. All amateur stations complained of are inspected by us, and we can usually thus clear up the trouble. Personally I believe that amateur interference to broadcast reception is not preventable and can, except perhaps in unusual cases, be eliminated if a sensible attempt is made. Many amateurs, however, do not seem to be sufficiently ambitious to make such an attempt unless a very perceptible stimulus is provided. In my own case I am using a transmitter designed for one-half kw. operation on 40 meters and it has been necessary to devise a special interference-filter in order to eliminate QRM to neighboring B.C.L.'s. Now that this special filter is employed it has been proven that no interference is caused even to a B.C. receiver (4-tube T.R.F.) located in the same room with the transmitter. Nor does the use of such a filter reduce the amount of DX worked—instead the tendency is in the other direction.

For a time we experienced considerable trouble from interference arising from sources other than the operation of amateur transmitters. At the present time both the local electric company and the telephone company are aiding us in our interference-elimination work. Mr. D. F. Cottam, our S.C.M., has been doing some very excellent work for the Northern States Power Co., in eliminating interference caused by the equipment of the power company and other electrical apparatus.

Matters have now reached a very satisfactory stage in this city; in fact we are approaching a state of idealism which we did not think could ever materialize. We have received aid and assistance from every side. We are indebted to the Supervisor at Chicago for excellent support and continual encouragement; Mr. Hayes has made some very helpful suggestions and has been most courteous and sincere in his supervision of our work. Likewise Minneapolis city officials deserve much credit for the splendid backing they have given us, especially Messrs. O. M. Fryckman and E. L. Harris, chief electrical inspectors. Above all, Minneapolis amateurs have been ex-

remely unselfish in their cooperation. We have obtained the good-will of the broadcast listeners. As a result of all of this, complaints of amateur interference have practically disappeared.

Our work, while much of the time tedious and difficult, has been upon the whole a great pleasure and we are now reaping the rewards. We have discovered that the policy of cooperating with the broadcast listeners is a policy that "pays big"—for isn't it much better to exert ourselves a bit and perhaps voluntarily curtail a few of our privileges and thus receive the friendship of the B.C.L. and the respect of the Federal radio authorities, than to do "what we darn please" and be "in Dutch" with everybody? This information is submitted in the anticipation that, by its publication, amateurs all over the country may be moved to follow similar methods. It is hoped that amateurs in other cities will awaken to action and that soon the interference problem can be remedied nationally. It is well known that, in general, the situation is serious and that the amateurs will suffer unless corrective measures are quickly and effectively adopted. Minneapolis is doing its part and is looking forward to some cooperation from other cities.

Editor's Note: Since the receipt of the above article a letter has been received from Mr. Kohler explaining an expansion of the work of the Twin City QRM committee, from which the following is quoted:

"Now that the broadcast listeners have been pacified and are no longer encountering interference with their reception, we have decided that a few other matters should be taken care of, these matters being 'off-wave' operation, use of raw a.c. on plate, poor operating, operation without license, and other kindred evils. Accordingly we have arranged to supply the Supervisor with regular reports on amateur affairs in this territory. Infractions of law and regulations are being acted upon by the Supervisor, while we are taking care of other phases such as 'poor operating'. The executive council of the Twin City Radio Club felt that there was no reason why all Twin City amateurs should be brought into discredit by the improper actions of a few of our number. The best way to correct the existing troubles was to turn the offenders over to the Supervisor. Consequently the club has advised Twin City amateurs that the off-wave business and similar offenses had best be stopped at once. This was sufficient to correct the situation and at present amateurs of this vicinity are cooperating very well. The official observation stations still maintain supervision and are making frequent

(Continued on page 28)

The Middle Capacity in a Two-Section Power-Supply Filter

By James Millen* and D. E. Replogle †

This is the fourth of a series of articles by members of the Raytheon organization. The first appeared in the September, 1927, issue, the second in the February, 1928, issue, and the third in the April issue. The fifth will follow shortly. These discussions relate to design, construction and operation of the type of low-pass filters which are used in "A" and "B" substitutes and in transmitting plate supplies.—Technical Editor.

As has already been pointed out in earlier papers of this series, the function of the first filter condenser (C_1 of Fig. 1) of a 2-section filter of the conventional type is to control voltage regulation. It was also shown that

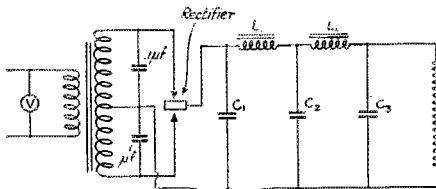

FIGURE 1. THE TYPE OF CIRCUIT UNDER DISCUSSION

The effect of condenser C_1 was discussed in the September article and the effect of C_3 in the February article. The present discussion treats C_2 .

this condenser had some effect on the magnitude of the ripple voltage in the filter output, likewise that the capacity of the final condenser C_3 (though it also had some effect upon the amount of ripple in the output circuit) operated primarily to control the audio tone quality obtainable from the receiver to which the unit was connected. In the case of a transmitter the effect of C_3 is similar but the manner in which this appears depends on the nature of the modulation, the nature of the keying, the circuit constants and the adjustment.

The purpose of this paper is to treat upon the functions of the middle condenser of such a filter circuit, C_2 in Fig. 3. The purpose of C_2 is purely that of ripple suppression. That it can have no appreciable effect upon regulation, as does C_1 , or upon

audio quality, as does C_3 , is quite obvious. Measurements were made, therefore, to determine the relative effectiveness of different values of C_2 in suppressing the rip-

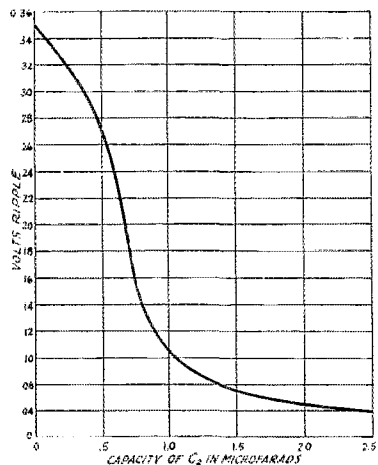

FIGURE 2. CURVE TO SHOW EFFECT OF VARIOUS CAPACITIES FOR C_2

The applied voltage was 300 per half of the secondary winding of the transformer, i.e., 300 volts on each side of the center-tap.

ple voltage in the filter circuit output. The result is the curve given in Fig. 2, showing the relation of the value of C_2 in microfarads to the value of ripple voltage (r.m.s.) in the output. The power unit and filter circuit employed was of the standard Raytheon variety. The output was loaded to 40 m.a., which was selected as equivalent to the current consumption of the majority of radio receiving sets in use at present.

The method employed was to measure the impedance drop across a known resist-

*Consulting Engineer, 61 Sherman St., Malden, Mass.

†Director, Raytheon Circuit Laboratories, Raytheon Mfg. Co., Cambridge, Mass.

ance in the output circuit (Fig. 3) by means of a vacuum tube voltmeter. The ratio of this resistance to the total value of resistance across the power unit output is a known constant by which all of

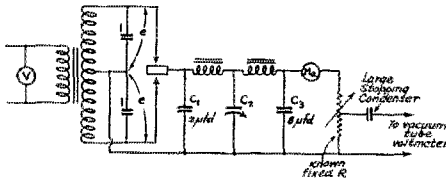

FIGURE 3. CIRCUIT USED TO OBTAIN THE CURVE OF FIG. 2
e = 300 volts as before.

the vacuum tube voltmeter readings are multiplied in order to obtain the full value of ripple voltage across the filter output.

As a result of the exceedingly low value of ripple voltage obtained when using large values of C_3 , it becomes necessary to employ a carefully constructed resistance coupled amplifier between the output circuit and the vacuum tube voltmeter for values of C_3 much in excess of 1 μ f.

SERIES RESONANCE EFFECTS

Upon study of the circuit given in Fig. 1, it will be seen that a series resonance circuit is formed by L_1 and C_2 . Should the value of L_1 and C_2 be such as to cause resonance at 120 cycles, then the effectiveness of the filter will be seriously impaired.

Generally, as in this instance, the inductance L_1 , has a value of approximately 30 henries in a high grade power unit filter circuit. Under such conditions, what value of C_2 will cause resonance at 120 cycles?

$$\omega L = \frac{1}{\omega C}$$

$$\text{or } C = \frac{1}{\omega^2 L}$$

$$C_2 = 5.9 \times 10^6 \text{ farads} = .06 \text{ microfarads (approx.)}$$

- and for $L_1 = 15$ henries, at 120 cycles $C_2 = .12$ microfarads
- at 60 cycles (Half wave rectification) $C_2 = .24 \mu$ f for 30 henries
- and $C_2 = .5 \mu$ f for 15 henries

Thus we see that the values of C_2 that will cause trouble, due to series resonance effects, are considerably below those ordinarily employed in practical applications,

and need, therefore, be given no further consideration in circuits of the conventional types.

While this concludes the data available at this time on the functions of the three condensers, individually, the curves given in Fig. 4, showing the effect upon ripple voltage of various combinations of inductance and capacity will no doubt also be of interest. From a careful study of the data shown here and in the preceding articles the designer of a B-power unit filter circuit may readily determine the most economical combination of inductance and capacity for a desired minimum value of ripple voltage. Likewise, the owner of a power pack who is desirous of decreasing the "hum" may obtain a rather good idea of the most

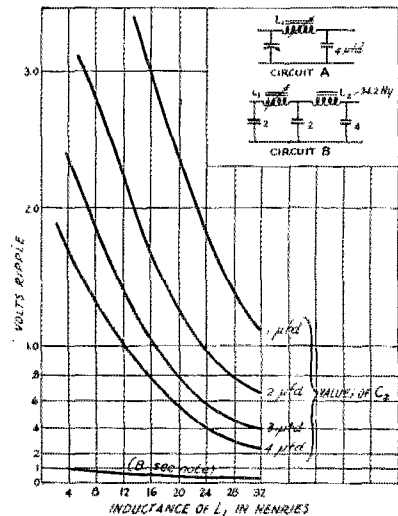

FIGURE 4. CURVES SHOWING EFFECT OF CHANGES IN BOTH L AND C

The four top curves relate to the single-section filter circuit labeled "circuit A" and show the effect of changes in the inductance of L_1 for each of 4 values of C_1 . The lower curve, B, relates to the circuit labeled B and shows the effect of various values of L_1 when L_2 has an inductance of 34.2 henries and the condenser values are 2, 2 and 4 μ f. The voltage input to the rectifier is the same as in the other figures.

effective method in which to apply the additional material at his disposal.

In obtaining the data for Fig. 4, the actual inductance of the filter chokes under the different operating conditions was measured in each instance so as not to introduce errors due to variation in inductance with different values of either a.c. or d.c. passing through the choke.

6CMQ

6 CMQ is primarily an experimental station. It consists of two main parts. The first is more or less permanent, and consists of the short wave receiver and amplifier, key, and transmitting control panel. As may be seen from the picture, these are mounted in cabinets, fastened to the desk, with all wiring concealed. The rest of the station is experimental. Any one of three trans-

mitters can be connected in the radio room or in a "dog house" mounted on the roof within six feet of the end of the antenna. No matter what transmitter is in use, or where it is connected, it is operated from the same control panel.

The short wave receiver is of the conventional condenser control of feedback variety with plug-in coils for the 20-, 40- and 80-meter bands. It is also equipped with interchangeable choke coils, although one covers all the bands. The filament of the 201-A detector tube is run at only three volts and seems to give better results this way than when five volts are used. The receiver is connected to a Grebe RORK two step audio amplifier. This receiver unit operates from a separate set of "A" and "B" batteries. A trickle charger mounted under the desk can be connected to the "A" battery, when desired, by the switch at

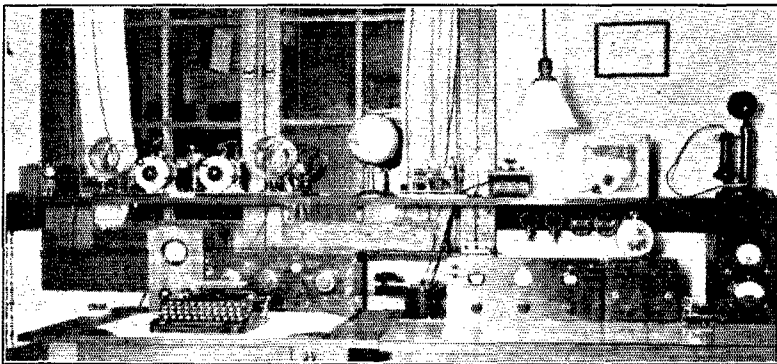

THE EQUIPMENT AT 6CMQ

The transmitter on the shelf in front of the window is a tuned plate-tuned grid arrangement employing a single UX-210. At the present time, any one of three transmitters may be shifted in this place and connected to the power supply circuits in short order. To the right of the globe is an omnigraph and next is the field rheostat for the high voltage generator. The biscuit tin is the monitor box for checking the transmitted signals. The phone needs no further introduction. Just beneath it is the control panel for the transmitter. To its left is the receiver and Grebe two-stage audio amplifier which also holds up the clock. Behind the typewriter is the Kennedy receiver and between it and the short-wave set is a G.R. wavemeter.

mitters can be connected in the radio room or in a "dog house" mounted on the roof within six feet of the end of the antenna. No matter what transmitter is in use, or where it is connected, it is operated from the same control panel.

The short wave receiver is of the conventional condenser control of feedback variety with plug-in coils for the 20-, 40- and 80-meter bands. It is also equipped with interchangeable choke coils, although one covers all the bands. The filament of the 201-A detector tube is run at only three volts and seems to give better results this way than when five volts are used. The receiver is connected to a Grebe RORK two step audio amplifier. This receiver unit operates from a separate set of "A" and "B" batteries. A trickle charger mounted under the desk can be connected to the "A" battery, when desired, by the switch at

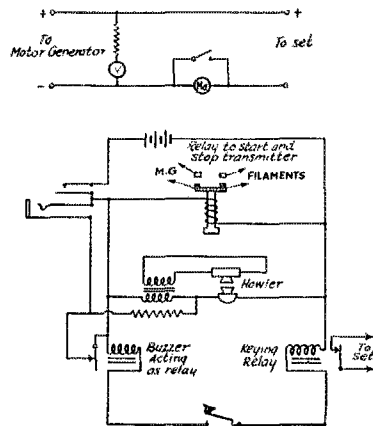

FIG. 1 TRANSMITTER CONTROL PANEL CIRCUIT

a microphone howler so the operator can listen to his own fist. It also connects another six-volt storage battery to the starting relay. Fig. 1 shows the internal connections of the control panel. The relay which short circuits the phones when the



A VIEW OF THE LOW-POWERED TUNED GRID-TUNED PLATE TRANSMITTER WHICH MAY BE USED AS IS OR AS A MASTER OSCILLATOR FOR A 50-WATT AMPLIFIER

key is up is an old high-frequency buzzer. This works well here due to its high speed operation and to its small size. The phones are connected in series with a 10,000-ohm resistance, the two being shunted across the primary of the howler modulation transformer. The resistance cuts the howler signal down to comfortable volume and prevents the howler relay from shorting the primary of the transformer and stopping the howl. The filament control jack connects the battery to the starting relay, howler, keying relays, etc. Since the jacks

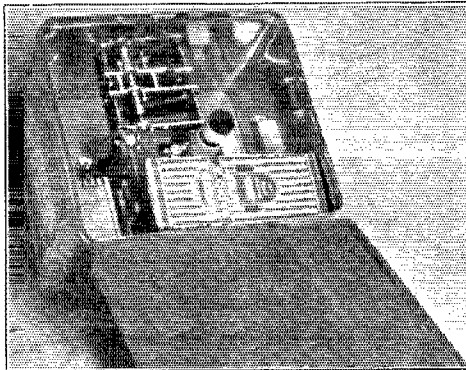

A LOOK UNDER THE COVER OF THE BISCUIT TIN WHICH HOLDS THE MONITORING CIRCUIT

in Grebe amplifier are also filament control, the phone plug is the only switch necessary to start either the transmitter or receiver.

The howler itself is nothing but a microphone and loud-speaker unit, mounted facing each other, and connected through a modulation transformer. A Ford coil works very well as the transformer. The howler

does not appear in the photograph since it is mounted under the table. When it is desired to use a break-in system, a blank plug is used to start the transmitter, and the phones are left connected to the receiver.

The above description covers the permanent part of the station. At times it has been known to survive as long as six weeks without an appreciable change. The rest of the equipment was built with an eye on simplicity and flexibility. The transmitter usually consists of one of three units, or combinations thereof.

The transmitter operates from a 110-to 220-volt 3-Kw. power line. The story of this power line is the standing joke of the station. Not long ago a 1000-to 1500-volt Kenotron plate supply outfit was replaced by the present 1000-volt motor generator. As a word of explanation it might

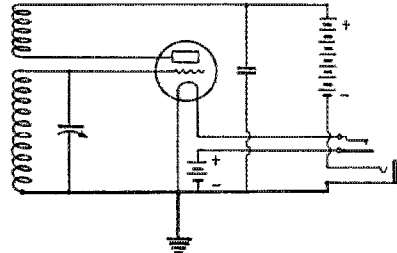

FIGURE 2

be stated that the motor draws a starting load of 40 amperes. About a week after the arrival of the M.G. a recording voltmeter, property of the local power company, made its appearance on our back porch, duly connected to the light wires. An investigation proved it had a circular scale, calibrated from 70 to 130 volts, which revolved once every twenty-four hours. The record was traced on this scale by a broad pen. When the motor-generator was started the pen went about ten volts below the minimum on the scale. Goodness only knows how much lower it would have gone if the hub of the disc had not interfered. That night the set was on the air for a twelve-hour stretch, with the aid of another operator. The meter disc turned so slowly that it had not moved the width of a pen line before the generator was started up again, and so on far into the wee, small hours. In the morning the disc was solid red in the region between 110 volts and the hub, for a period of twelve hours. There

was no one at home the next day when the meter was called for. That night a second meter was in the place of the first one, freshly loaded, and ready to go. From about seven until ten the results were the same as the previous night. Explanations were forthcoming, and now 6CMQ has a private 3-Kw. pole transformer, for it seems that there were four long blocks supplied from the same transformer, and the inhabitants found the 40-volt drop annoying.

The entire shelf over the desk and table can be used for the transmitter, if the need arises. Two sets of five wires each, tipped with lugs, come up from behind the table to the shelf to connect the plate and filament supplies to one or more of the transmitter units. This system of connections is largely responsible for the flexibility of the transmitter system in use.

There are three main units in the transmitter. The first is the tuned grid-tuned plate oscillator, shown in the photograph, which operates on 40 or 80 meters, by changing the clips on the inductances. It is used for low power work on either of the two waves, or as a master oscillator for the 50-watt power amplifier. Like all other of the transmitter units, its plate supply comes from the motor-generator. When used as a master oscillator, a 10,000-ohm resistance is placed in series with the positive high voltage so that the full output of the motor-generator may be applied to the 50-watt without overloading the 210. As may be seen from the picture, the base on which this unit is mounted is an old panel that used to be something else. From the lack of visible wiring in the photographs, it may also be guessed that all filament and non radio frequency wires are under the base.

The second unit is a 160-meter crystal oscillator, with a frequency doubling, 80-meter amplifier. Similar sets have been described in *QST* many times so that its description will be omitted. This unit is used as a low power 80-meter set or as a master oscillator for the frequency doubling 50-watt amplifier when used on 40 meters. Due to the fact that two of the three original crystals are now broken, and the wave of the remaining one coincides with in 200 cycles with Mexican XC51, and is almost on top of nu2UO's xtal, this unit is seldom used.

The third unit is the 50-watt power amplifier before mentioned. It is equipped with interchangeable coils for the 20-, 40- and 80-meter bands. It is normally used

as a frequency doubler, but may be used as a neutralized amplifier on the same wave as the master oscillator. Its plate supply is the 1000-volt motor-generator, a series resistances being used to lower the voltage to the master oscillator tube, if necessary.

The antenna is one of the most interesting features of the station. It is supported from a 40-foot, one-inch iron pipe mast,

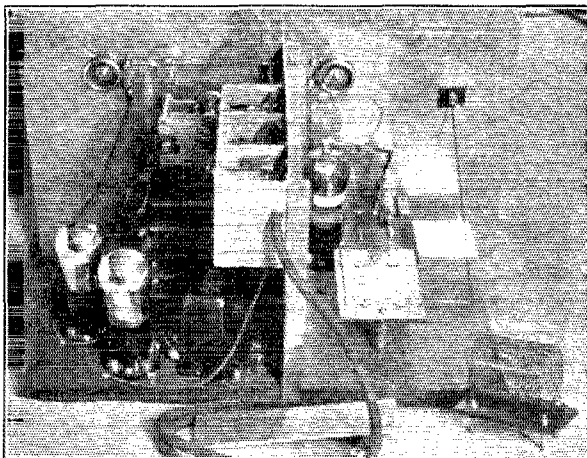

THIS IS THE RECEIVER USED FOR MOST WORK

The circuit is of the conventional type employing capacity control of regeneration. It is a pretty mechanical job that might well be copied by many.

and the chimney of the house, which are about 80 feet apart. The average height of the antenna is only 27 feet. Both supports are equipped with a continuous rope through a pulley. The chimney is provided with a cleat to which the rope is fastened. The pole end has a harness clip to which are hooked 35 pounds of flat irons, and window weights, which allow the rope to expand and contract under varying weather conditions. Perhaps this device is the only reason why the pole is still vertical, despite the winds or, rather, gales which Altadena experiences at times. Harness clips are spliced on both ropes, and the antennas are hooked to these.

There are available two antennas always. The first is a 60-foot wire with a 60-foot lead-in. This is voltage fed at 20, 40 or 80 meters. The second is a 40-meter Zepp of standard construction, and size. The unused antenna is wound on a drum until needed. The lead-ins bolt under winged nuts to No. 10 x 32 brass bolts passing through a quarter-inch, plate glass window, mounted just behind the transmitter. With this system it is not unreasonable to ask a fellow to, "QRX for a new antenna". When the antenna was first built, considerable difficulty was experienced with har-

monics falling outside the band. The trouble was finally corrected by grounding the pole and all guy wires.

All the receivers operate off a 25-foot antenna, that is 15 feet high at the far end.

Beside the regular short-wave receiver, there is a tuned radio-frequency receiver using one of the new UX-222 tubes. This receiver was built from the article by R. B. Bourne, in December, 1927, *QST*. This, and the photograph are description enough and shows that the receiver slides into a tightly

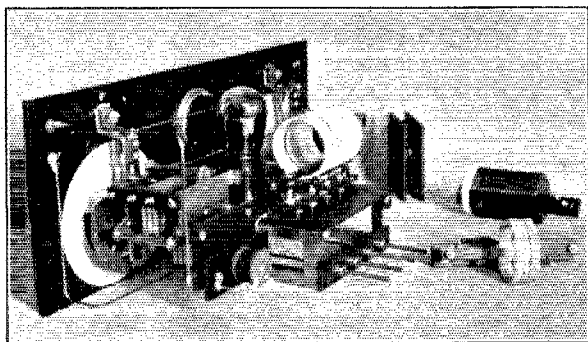

THE RECEIVER EMPLOYING A STAGE OF RADIO FREQUENCY AMPLIFICATION WITH THE SCREEN-GRID TUBE

Plenty of shielding is used and the set is slipped into a tightly fitting copper case which forms all but the panel wall. This allows the set to be worked on without having to use a can-opener or oxy-acetylene torch.

fitting copper case that is mounted in a cabinet. The fact that it is a three-handed set has prevented it from replacing the regular set. It is used only on DX signals. At the time the photograph was taken it was not connected for use.

The B.C.L. set is a Kennedy, which also takes in the 600-meter band. This set and its two step are seen on the table behind the mill.

A monitor box similar to that described in *QST* many moons ago is used to check up on the transmitter. In the photograph of the general layout it is seen directly above the receiver on the shelf. The details of construction may be seen in the picture of the interior. Plug-in coils are again used. This unit is also equipped with a filament control jack. The circuit is shown in Figure 2. Note that the jack is grounded, which makes it possible to mount the jack right on the can, and prevents the phone cord from acting as an antenna. When this unit was first built, it was too sensitive, and the transmitter paralyzed it. This was overcome by increasing the size of the tickler coil.

On the shelf, to the left of the monitor

box may be seen the generator field rheostat. With this the voltage may be varied from 200 to 1000.

To the left of this is an Omnigraph, on which is a home made disc cut to send "Test test nu6CMQ". This is a great help when adjusting a transmitter, as it leaves both of the operator's hands free. The main objection to it is that every new visitor has to have it explained to him why the disc reads "Test" and not "CQ".

The telephone, seen at the right hand end of the shelf insures prompt delivery of local messages, and a constant source of QRM since it is an extension of the house phone and all phone conversations are R6 in the receiver.

At the extreme left of the shelf, in front of the filament transformer, is the proudest possession of the station. Some time ago the operator was complaining of the poor DX. Miss 6BXA suggested the use of a cat to improve this condition. (Ask TOM. No, not Tom cat.) It was explained that the cat had been tried, and while the DX certainly improved, the cat started to lose its fur. Two weeks later 6BXA made the station a present of "Felix" saying that he, she, or it, as the case may be, had been treated with an acid-proof paint and could well withstand the wear and tear that would be imposed on it. The Trans-pacific Test certificate above the monitor box speaks well for the results.

The station is kept within bands with a General Radio wavemeter. When an exact standard is wanted, a General Radio precision wavemeter is available. This is one of few compensations to ham radio resulting from a job as chief operator in a broadcasting station.

The station is owned by F. T. Swift, Jr., in Altadena, Calif. It boasts RCC, ORS, OWLS and RM standings. The operator is also Chairman of Communications for the well known Short-Wave Club of Pasadena.

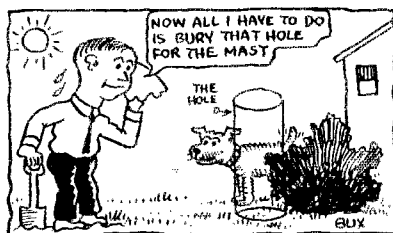

BELIEVE IT OR NOT

Another Part of the Family

EVERY once in a while someone sings us a sad tune to the effect that amateur radio is passing—the old timers are all (gulp) commercializing themselves. Well—why not? Rich American amateurs are scarce, therefore most of us must work at something and it might as well be something that we like. Instead of wailing at the fact that amateurs are doing things in commercial radio let's feel proud of the fact that one can't look into any branch of radio whatever—none whatever—without finding it thoroughly filled with A.R.R.L. men.

As an instance—did you happen to know that the *operating* staffs of American broadcasting stations are very largely amateur and ex-amateur? Did you suspect

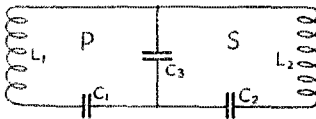

FIG 1

that in general the proportion is highest in the best stations? So it is—there is statistical proof; the broadcast-operating game (just like the ship-operating game and the manufacturing game and the business of radio engineering) is a thing this outfit has manifold personal connections with.

These A.R.R.L. broadcast operators do a lot of interesting things that the straight message-handling operator will need to have explained to him. You see it is a job that is made up of wire telegraphy, radio, telephony and music.

Do you wonder that this sort of a job produces a WCCO group that can handle the ticklish 9XL standard-freq. job as well? Do you wonder that a visit to any B.C. station is worth while? However, if you go, be sure to have time to get acquainted with the operating staff and to talk to them; they have ample material for conversation. The apparatus will look familiar—until you try to trace the details of its operation—then you go back to the chart class.

Come into this station and let's look around. Never mind the telegraph desk; those are the wires to the A. T. & T., W. U. and Postal. There's a wire to Springfield too and it is used—but that becomes complex and can't be told here.

The tall narrow framework cover there is a Western Electric r.f. amplifier of one

stage with a rated output of 5,000 watts. Being water-cooled the tubes stand in metal jackets supported by the little table with the porcelain pillar legs. Since the plate voltage is upward of 10,000 it is neces-

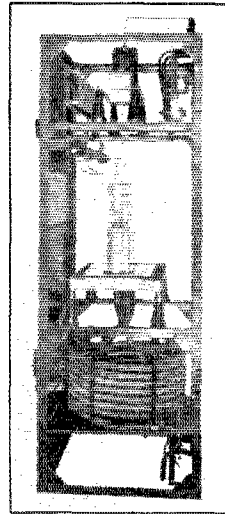

“—R.F. amplifier of one stage—”
Bell Tel. Labs.

sary to prevent leakage to the grounded water-supply pipe and the grounded drain pipe. This is done by interposing long pieces of rubber hose, the water column inside them being long and slim enough to offer a high resistance so that the leakage is not excessive. The two

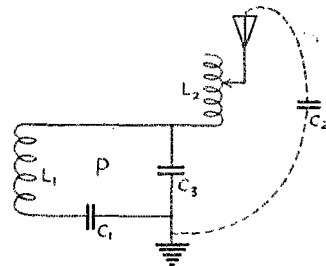

FIG 2

rubber tubes are coiled in the lower part of the frame and at the bottom of the coil there is a water-failure device which (if the flow of water stops) operates an electrical contact and thru apparatus on the lower portion of the instrument panel

gives an alarm and trips out the high-voltage supply, thereby preventing damage to the tubes.

In the upper level of the set there is another small insulated deck carrying the

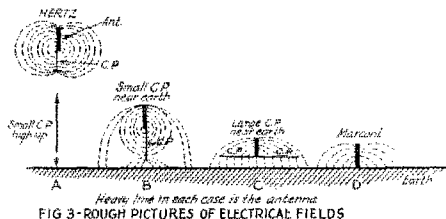
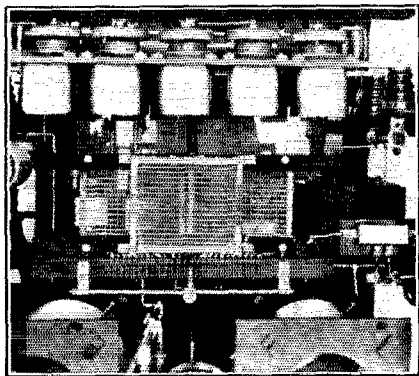

FIG. 3—ROUGH PICTURES OF ELECTRICAL FIELDS.

plate supply choke and the plate stopping condenser, from which a lead descends vertically to the plates.

Just behind the panel are the "ohmspun" resistors, also the chokes and condensers which have to do with the filament supply and the grid bias. On the rear of the same deck is a small vertical panel carrying filament fuses and cutoff.

The customary web of wire is gotten rid of by the good standard W. E. method—



"The central object—" Bell Tel. Labs.

cable all low voltage wires together and put them in the hollow of the nearest angle-bar. The "cable" is of the usual telephone sort—wires laid together and fastened with a length of twine that runs along the cable and is half-hitched around it every inch or so. Perhaps some telephone man can explain why the procedure is called "swing".

Take a look inside of this special 1-kilowatt job. The central object is a bachelite rack carrying "ohmspun" resistors which are tapped to the curious slider-switch just below, a construction that can be copied with advantage where it is necessary to have a variable voltage for grid bias or the like. The resistances shown are, by

the way, rather good at r.f. and a scheme of this sort has been used in at least one W. E. transmitter as a sort of r.f. voltage divider to supply adjustable feed to an amplifier.

The inductances below have treated maple rods slotted for the metal strip of which the coil is wound.

The condenser strip above is of the sort rather common in large W. E. sets and although its exact use in this case is not known there is a suspicion that it is part of a system of capacity-coupling to the antenna. By this is meant real capacity coupling and not the l-wire r.f. feeder system which is commonly mis-called by that name. Lend me your pencil John; may I

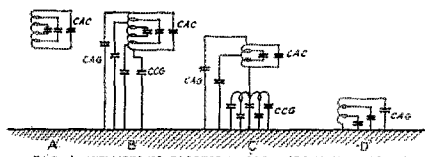

FIG. 4—ATTEMPTS TO REPRESENT CORRESPONDING CIRCUITS.

draw on the back of your message pad? The thing I mean is the arrangement in which we have such a connection as that of Fig. 1, where the primary circuit is $L_1 C_1 C_2$ and the secondary circuit is $L_2 C_2 C_3$. The capacity C_2 is the coupling capacity, being common to both circuits. If it is large as compared to C_1 and C_3 the voltage across it is small, therefore the power transferred is small, therefore the coupling is loose. If C_2 is of a size not large as compared to C_1 and C_3 then by a similar logic the coupling becomes close. By choosing the constants correctly the system can be made to reproduce the usual performance of the magnetic methods of coupling, with some advantages. Fig. 2 shows one practical form which explains itself. C_2 would be the mica condensers up there in the set.

Did you ever sketch out what happens when you try the same thing on an antenna which isn't grounded but uses a c.p. instead? (Note British effect obtained by referring to counterpoise by its initials.)

First of all, does it make any difference? Crazy enough it sometimes makes little difference in the operation but a considerable difference in the explanation of the operation. That probably does not sound rational—may not be rational—but is worth talking over. Cut off that monitor loudspeaker and we'll go over it. Perhaps some of you can make it clearer than I—I hope so.

First of all we will have to admit that the circuits of Figs. 1 and 2 are not very exact. They show the inductance of the antenna lumped in one place (L_2) and the capacity lumped in another (C_2) whereas

we know that even if there is a loading coil we still have inductance draped all along the antenna right out to the last centimeter. We really get a better idea of the actual situation by drawing a rough picture of the antenna field—meaning the electric or “static” field! (Incidentally, isn't it funny that we talk about a “static” field when the thing is collapsing and unfolding at the rate of ?????? cycles per second?)

To get on—in Fig. 3A we have a crude picture of the antenna taken at the moment when the electrical field is actually “static”, which is to say at the moment of peak voltage and no current. The field is the private property (comparatively) of the antenna by reasons of the fact (almost) that it all lights on the c.p., there being nothing else nearby. A sort of picture of the electrical circuit in terms of L and C would then look like A' in Figure 4.

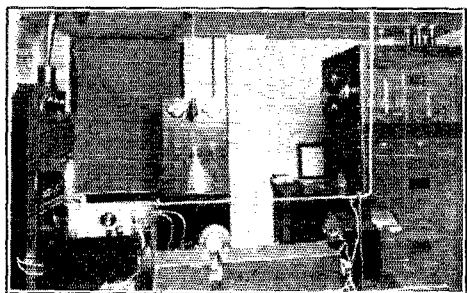

“—sits in the middle and has to watch all these things.”
Sweeney School and WHB.

When we drop the antenna-counterpoise system nearer the earth the picture becomes more complex for we add a material amount of capacity between c.p. and ground, also between antenna and ground, giving the distressingly complex picture of B and B'. If now we use a large c.p. and thereby get a lot of capacity between the c.p. and ground we modify the picture somewhat we have the things shown in C and C'. This makes the whole thing indecently complex and a fit subject for mathematical treatment instead of soldering copper engineering by the present meeting. It is therefore a relief to find that as soon as we finish the job and use a ground we have the simple picture of D and D'. I know—I know—we are getting ahead slowly, but then I have not Dr. Pickard's gift for saying much in a sentence. Bear with me.

If we hope to do any guessing on the coupling business we will need something simpler than Fig. 4. Going ahead we see that in each case we can group the ca-

pacities under headings as capacity between.

- Antenna & c.p. (C_{ac})
- Antenna & ground (C_{ag})
- C.p. and ground (C_{cg})

Without as much as a court order we will bunch the little distributed capacities that way and draw Figure 5. It is quite likely that someone will be able to lump them

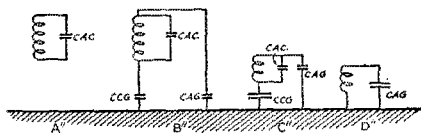

FIG. 5-DISTRIBUTED CAPACITIES LUMPED

more profitably, which will give us a good follow-up article. Having done this let's try to work our method of coupling and see what comes of it.

In Fig. 6A we have at the top a scheme that is certainly capacity coupling—but the set is up in the air too. That is a senseless procedure and we had better put it back down on the earth and feed the antenna by some sort of a feed line so it will not be necessary to chip ice off the helix or the tube before starting up. Of course if anyone wants to hang on an extra tuned circuit up there it is possible to leave L1 and C1 up there and feed them from the line. This will have the advantage that we can use the LC system as an impedance-matching transformer such as was described in the January issue of QST.

In B we have tried it on the linear antenna near the earth. The first thought was to use C_{cg} as a coupling capacity but it is very small and the voltage across it would be large, resulting in a large coupling, which isn't wanted. Therefore C3 has been connected across it and made large. The result is that we no longer have a Hertzian system—we simply have a Marconi antenna with a series condenser C3 in the ground lead. That changes the wavelength

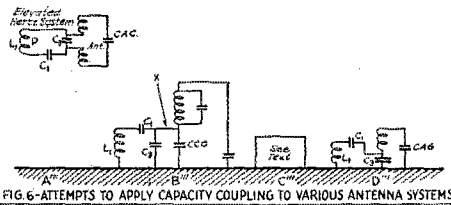
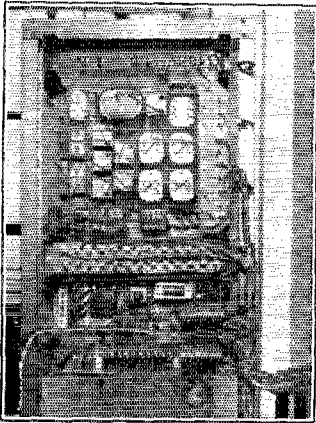

FIG. 6-ATTEMPTS TO APPLY CAPACITY COUPLING TO VARIOUS ANTENNA SYSTEMS

too much for now we have an antenna twice as long as before (the node has of course moved to the earth connection) and the thing isn't fitted for the wavelength we started with. Evidently this was a bad start and the way to do it is to put in a

reactance at the place X. This X had best be a choke coil such as is used over at WOAI in San Antonio. As I remember it that's a tapped coil of some 30 spaced turns on a 4" form. Then the primary circuit goes right along and the drop thru C3 is partly fed thru X to C_{cg} and excites the antenna. X acts as a coupling control, the more inductance it has the less the coupling. One can see offhand that this isn't true capacity coupling but some sort of a link arrangement. The wire between C3 and C_{cg} can be lengthened out more or less at will, as



“—try to trace the details of its operation—”

St. Louis Post Dispatch & KSD

long as it doesn't start to fall into tune with the working wave. The “limiting reactance” can be a condenser, in which case we have the the classic 8XK arrangement with the corresponding difficulty that the harmonics get thru to the antenna more easily than the fundamental. That's why Strobel first used the choke at KFKX. Before someone asks me to name this sort of coupling we will move on to C”, for which I've made no diagram, but which of course is the same thing as B” except that C_{cg} is large so that excessive coupling can be avoided by merely choosing the size of L₁ and C₁ so that the current thru the primary system is of the right size to give the desired coupling by reason of producing the right drop across C_{cg}. This wasn't possible in B” because we would have had to work with such a very small C₁ and such a very large L₁—and one hates to handle a 5-kilowatt Tesla coil surrounded by blue fire.

When we get to D” we have exactly what we started with, and that's as far as most radio discussions get. Let's drop it for this time; someone else will do a better job at the next session.

Did anyone of you fellows ever listen to the stuff from your own B.C. stations at

home? Clayt. Randall of WTIC uses a superhet with a meter in the last plate circuit, just to keep track of the modulation over the station. Eh? Oh no—there isn't any loudspeaker or headset—he just “listens” to the meter.

May we come over sometime and watch you make a line test? Good, I never did understand this audio oscillator test. Come over to 1MK sometime and watch the new Raytheon tubes. They are pretty good for—oh yes, that's right; we are not supposed to talk about them yet. Cut off the mike will you George?

—R. S. K.

Adapter for “852”

MANY of those folks who have sets employing 204-A tubes are probably very much interested in the UX-852 as a possibility for ultra high frequency work but have refrained from their use because they did not want to go to the trouble of installing new sockets which would not allow either tube to be used at will.

Such will be interested in the UX-852 adapter, a photo of which appears herewith. The insulating parts are of bakelite

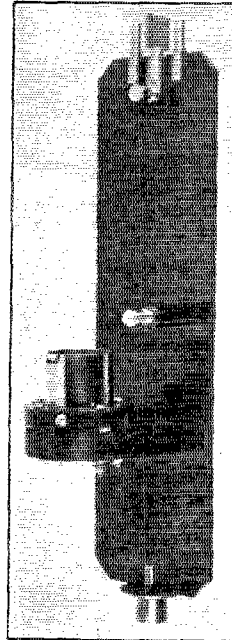

and the filament, grid and plate leads are run behind the long panel upon which the other equipment is mounted.

This adapter is a product of Heintz and Kaufman of 219 Natoma Street, San Francisco, Calif.

—H. P. W.

A Crystal Grinder

By H. F. Mason*

MR. WATTS' excellent article on page 27 of the January *QST* shows how simple it is to grind your own crystals; but it is a tiresome job, nevertheless, and requires a lot of patience. Probably the slowest part of grinding an 80-band crystal is in roughing down the blank to a few thousandths over the required thickness. A contraption as shown in Fig. 1 will save much elbow grease here. The idea is not mine; it is a take-off on a grinder used by one of those venerable amateur telescope makers back in Springfield, Vermont. The sketch is self-explanatory. Arm A is a maple stick having brass bushings pressed into holes in it for bearings. The grinding disc or "tool" is a piece of coarse grained cast iron. When it wears untrue it is merely removed chucked in a lathe, and a very fine facing cut taken off. This makes it sufficiently plane, as this grinder is used only for roughing anyway. The toothed wheel B is cut from galvanized iron. In operation the pulley P is run about 250 r.p.m. The hook H acts as a pawl and boosts ahead the toothed wheel and iron disc about $\frac{1}{2}$ -inch every revolution of P. Friction at D keeps the disc from moving otherwise. Before placing in the grinding rig the quartz blank is made approximately plane on both surfaces by hand grinding. No. 150 carborundum grains and water are carefully smoothed over the iron disc, the surplus wiped off, and the motor started. The center of the crystal will describe a path as in Fig. 2E.

In the semi-finals with No. 220 carborundum grains, as well as in the final grinding with No. 400 and then No. 600 carborundum, the planeness of the surface obtained depends a great deal upon the exact manner in which the crystal is steered over the plate glass. Fig. 2 attempts to show methods and the results. Method A will (unless something else is the matter) grind the center low while D will bring the corners low. B and C are intermediate. The exact method to use depends on the planeness of the plate glass on which you are grinding, the amount and grade of compound used, the thickness of the quartz, and the result of your last measurement

with the micrometers. If the plate glass has been used several times for fine grinding, or if there is too much carborundum, the corners will grind low. This can be partly corrected by using method A. If the crystal is of a thickness corresponding to about 90 meters or under, the pressure of your finger in its center while grinding will cause the crystal to bend, tending to

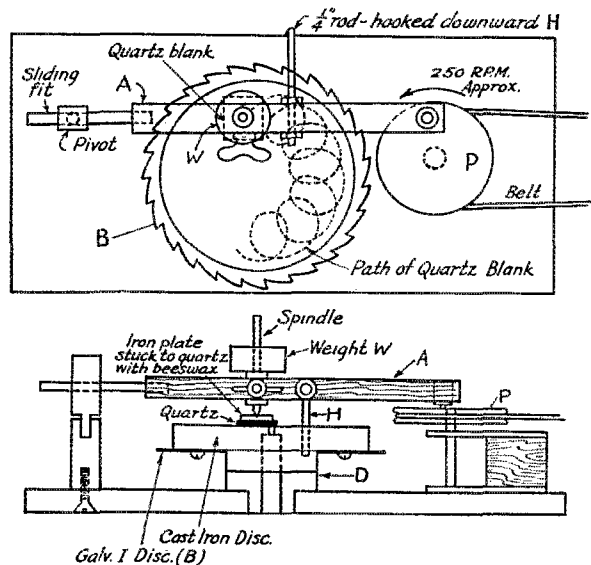

ROUGH GRINDER FOR HAM XTALS
FIG. 1

bring the center low. This can be corrected by using method D and very light pressure. Try and cover the plate glass completely or the glass will have its trueness destroyed and your crystal can never be ground true. Use too little rather than too much carborundum. The glass you are working on should appear like a piece of emery paper. Any surplus carborundum should be wiped off and should not be allowed to accumulate at the edges. If allowed to remain, this surplus will get under the edges of the crystals, as it is moved about, and will grind the corners and edges low. This of course is more pronounced with the coarser grains of carborundum. One "wet" of carborundum lasts from ten to fifteen minutes, after which it fails to cut and should be renewed.

Regarding holders, some have recommended top plates smaller in area than

*Seattle Radio Laboratory, 3335 33rd Ave., So. Seattle, Wash. "X" Section, also 7BU.

the crystal, or a circular top plate for a square crystal. A crystal afflicted with low edges or corners will give best output with

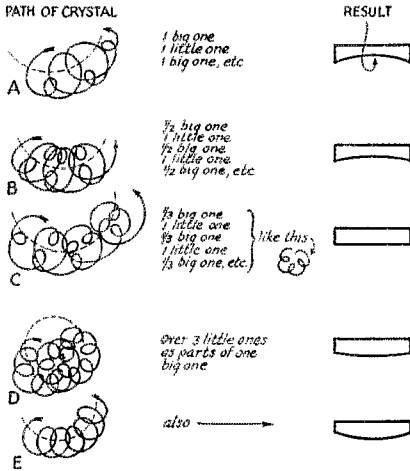

FIG 2

a top plate that does not cover those places where the crystal is thin. This is simple to explain; the corners simply do not wish to come along and oscillate at the frequency of the center because, being thinner, the corners want to oscillate at a higher frequency. It has been my experience that a crystal having corners the same thickness as the center will give best output with a top plate the same size as the crystal.

It is important, when making connections to the crystal holder, that the leads be short so as to minimize stray grid-filament capacity.

Audio oscillations or "singing" is most liable to occur if the electrode plates are not plane or if interposed dirt particles prevent even contact between the electrodes and quartz plate.

Much trouble and grief in finding the right value of radio frequency choke to use across the crystal can be eliminated by using a resistance instead of a choke. A 50,000 ohm metalized leak is a good value to start with, and of course a higher resistance will result in less plate current and a low resistance in more plate current.

The Twin City Vigilance Committee

(Continued from Page 26)

check-ups. The measures which the Twin City Radio Club have adopted for bringing about a readjustment of undesirable conditions (interference to broadcast reception included) have been very effective and there is no reason why similar methods can-

not be put into operation in other parts of the country."

The Twin City Committee tentatively consists, in addition to Mr. Kohler as chairman, of Messrs. J. C. Pehoushek, 9EFK, president of the club; P. R. Gould, 9DHP, publicity manager; W. L. Kinsell, 9CEV; R. W. Billett, 9BIS; R. S. Spooner, 9LW; D. F. Cottam, 9BYA; and the personnel at 9ABK.—Ed.

Atlantic Division Convention

June 14, 15, 16, State College, Pa.

HERE'S the announcement, fellows, of the 3rd annual Atlantic Division Convention to be held at State College, Pa., on June 14-15-16, sponsored by Director Woodruff and Section Manager Crossley in cooperation with the Pennsylvania State College, Department of Electrical Engineering.

The program is replete with good things and any one missing this convention will regret it. Miss Zandonini, 3CDQ, is to speak on crystal grinding and calibration; McAuly, 8CEO, on tube rectifiers and their characteristics; Dr. J. O. Perrine of the A. T. & T. will talk on transatlantic phone and will have tubes to show us.

The committee in charge has made arrangements to take care of the delegates in the college dormitories. The YL's and OW's have a special cottage reserved for them and the cost for the rooms will be only \$1.50 per night, 2 in a room.

Besides the good lectures there will be plenty of stunts, side trips and a general good time is guaranteed.

Convention cost is \$5.00 and SCM Crossley, who can be addressed in care of Pennsylvania State College, State College, Pa., will be more than glad if you write him to say that you will be there.

Strays

The Burgess Battery Company of Madison, Wisc., has recently supplied us with a copy of their Engineering Circular No. 15, under the title of, "Experimental High Frequency Radio for Aircraft". This is a most interesting thirty-page brochure which describes complete installations for both aircraft and ground stations. The set to be used aboard an airplane is designed for both key and voice modulation while the transmitter for the ground station is primarily constructed for telegraphic work. It can, however, be used for voice by the addition of another tube and some associated equipment which is described in the pamphlet. Copies of this circular may be obtained on request from the Burgess Battery Company.

A Combination Fieldmeter-Wavemeter-Voltmeter

By Eugene C. Woodruff*

NEVER put an ammeter into a "tank circuit". Don't use an ammeter in your antenna. Don't buy or make a wavemeter to be used with an ammeter or a small lamp as the indicating device.

Naturally the above "don'ts" must be qualified in the interests of both peace and accuracy. Don't "do any of these don'ts" unless you have very special reasons for each occasion, and unless you have money to spare. The apparatus about to be described will produce all the results the average constructor and operator will ever need, and that much more easily and cheaply. This device has stood the test of demonstration before several clubs in various cities. Invariably the fellows say, "I must make one like that," and "When will it appear in QST?"

Reference to the photos and diagram show the following parts:

L1. Wavemeter inductance on UX-tube base (for the 40-meter band 16 turns of No. 20 D. C.)

L2. Field-pickup coil. Suit yourself; almost anything from 1 turn an inch in diameter to 6 turns 2 inches in diameter.

C1. Wavemeter condenser. Cardwell Balancet or equivalent.

Ma. Milliammeter. First choice for range 0-1.5 though meters up to 0-10 give nearly equal satisfaction. (To have the

100,000 ohms for 150-volt range, 500,000 ohms for 750-volt range, both with above mentioned size of milliammeter. The "voltmeter" does very well for work with a "B" eliminator, as the load it puts on the eliminator will always be less than 1.5 milliamperes.

To use the device as a fieldmeter, remove the wavemeter plug-in coil L₂ and connect pickup coil L₂ to the Fahnestock terminal, place the pickup coil loosely coupled to the source of field (such as a tank circuit or antenna) and note behaviors of the mil-

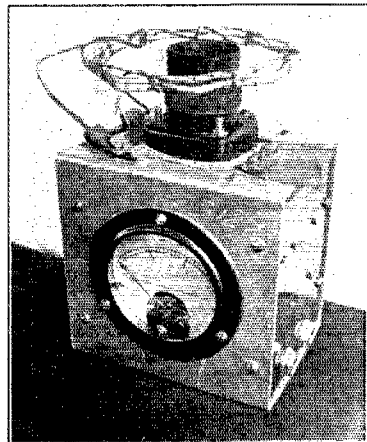

METER SIDE, SHOWING PICK-UP COIL L₂ IN PLACE, ALSO SHOWING VOLTMETER JACKS

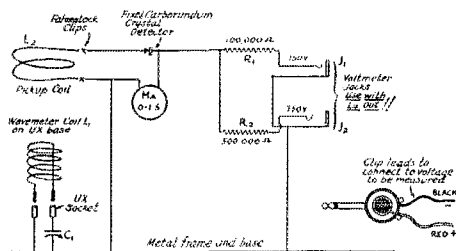

same voltmeter ranges with meters other than 0-1.5 the resistance shown must be changed.)

Det. Fixed Carborundum crystal detector with ample current-carrying capacity. Carborundum Co. type, or type that can be purchased at almost any "five and ten."

R₁ and R₂. Series resistances for voltmeter—Daven "high capacity" "Glastors;"

*234 West Fairmont Ave., State College, Pa. Director, Atlantic Division. A. R. R. L. SCMP.

liammeter and the adjustments of the oscillator are changed. With the fieldmeter coupled to the tank circuit you know when your outfit is oscillating, and can easily find the combination of adjustments that produces maximum effects. With it coupled to the antenna you know the antenna is radiating and can readily adjust the transmitter to get maximum radiation. Right here let me warn you. Don't let anyone scare you by asking how you know you are not getting "merely the effect of induction", whatever he may mean by that. Assuming we know what he has in mind, part of the answer is that this device shows stronger fields at the ends of a half-wave antenna than it does at the center. At a voltage node it did show nothing, though the current through said node was large and otherwise evident. The device also shows, when used with an antenna having a

thermo-ammeter in series, that maximum radiation and maximum antenna current do not always coincide. In any case this device affects the decrement of your oscillator less than other methods of indicating field, as it takes less energy therefrom. For examples, at 8CMP the fieldmeter is placed near the 20-meter Hertz antenna, away from the direct influence of the transmitter. Then the transmitter is adjusted until the meter shows maximum field radiated. *No other meter need be used in the transmitter assembly.* Again, at 8CMP, each stage of all crystal oscillator-power-amplifier systems is provided with one of these fieldmeters loosely coupled to the tank circuit, greatly increasing the ease and flexibility of adjustment, and with a considerable saving in cost over meters as ordinarily used.

To use as a wavemeter, plug in a suitable coil wound on the base of a tube and connected to the Fahnestock, loose couple to the antenna or oscillator and tune to maximum meter reading. The tuning is sharp and calibration is especially stable,

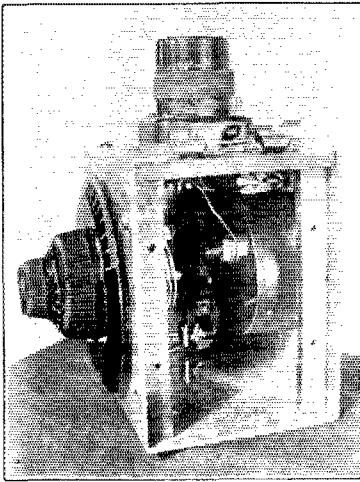

THE DEVICE AS A WAVEMETER

One end has been removed to show the interior arrangement.

even when the pick-up coil is varied widely in size or number of turns. Coupling should always be loose. The fieldmeter may also be used (with L_2 in and L_1 out) with any other wavemeter, as an indicator of resonance. In general it is more sensitive and affects the calibration of the wavemeter less than other methods of indication. For example, at 8CMP the fieldmeter is placed several feet from the five-meter antenna, for instance, then the General Radio wavemeter is placed between the fieldmeter and the antenna, perhaps 3'

from pick-up coil. Tuning, the wavemeter is accompanied by a very sharp and satisfactory response in the milliammeter. This use of the device, in all bands, is the most important one of all, at least at 8CMP.

To use as a voltmeter, simply plug voltmeter leads into the proper jack for the desired range, pick-up coil removed. In the interior view, one cover removed, the crystal may be seen just above the meter, and the high resistances and jacks just beyond.

Try this device, fellows, and let me know your troubles, successes, or criticisms, please.

Official Wavelength Stations

THE Official Wavelength System furnishes a service cooperative with, but differing from, that of the Standard Frequency Station 9XL, which is also operated in accordance with plans made with the O.W.L.S. Committee. Contact with the O.W.L.S. is through Mr. D. C. Wallace, 6AM, who is also chairman of the committee. Mr. Wallace is continuing the practice of checking up all O.W.L.S. to make sure that they are really indicating their wavelength (or frequency) at the end of each transmission—and are doing so with proper accuracy; which is to say 2%. They do this in the course of regular operation and do not send calibration schedules as do the S.F. stations.

The list is as follows:

NKF, 6ZV-6XAO, 6BQB, 7BU, 5MN, nc3FC, oz2AC, 2WC, 6AM, 9FF, 8GU-8XC, 9XI, 1CK, 1AWW, 3ZW-3BE, 8AA, 8EQ, 3APV, 4XE, 5ZAV, 9DXN, 9EGU, 6ZH, 2MU, 4BY, 9ZA, 7GE-7ZX, 5SP, 9EIB, 7GQ, 2DS, 1BZQ, 6BGM-6CVO, 2XI, 9IG, 7ACI, 1ZL-1AVW, 2CLA, 6ZE, 8GZ-8ZG, 9BGK, eg2NM, 6TI, nc3NI, nc9AL, 8APZ, 2SZ, 7QK-7MX, 6LJ, 5OX, 9BMR, 6BCP, 1AAC-1ZO, 8BZT, nc3CO, oa2CM, eg2OD, 6CAE, 5AGN, 9AXQ, 9CPM, 5EW, 5PH, 1AXA, 9BGH, eg2SZ, 1XM, 6BX, 6BB, nc1AE, eg5LF, 1KP, 8DAJ, 1BHW, 9AUG, nc2BE, 6AOL, 9CXU, 2BRB, 6CMM, nc4BT, oa5BG, 4LK, 2BO, Ireland 5NJ, 1CCW, 6DHL, 8BAU, 9XL, 6BVH, NRRL-9UZ, 2EF, 9WI, 7XF, 6AKW, 6CDY, 6AY, 6AYC, 6QL, 6BRO, 6CCR, 6BMW, 6CMQ, 4CK, 7AAT, 9AHQ, 9EFO, 6QL, 6BAJ, eg5YK, 6BZU, 1BD, 5NW.

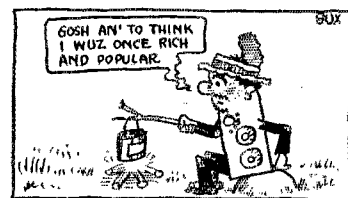

A BUM SET

Experimenters' Section Report

WITH this report the "X" Section goes into new hands. Having founded the Section and watched it through its various changes I naturally feel some regret at the parting, especially as many of our wishes and hopes have not been accomplished. We have never as we had hoped, acquired the complete time of one headquarters man to do for this Section what the Communications Manager and his assistants do for message handling. Neither have we been able to keep everyone supplied with outlines and reports as promptly as we desired, though in this regard very nice work has been done by Mr. Ross Hull.

However, the Section has done good work, and has much more than justified its existence and has made good its claim for those things which we have not been able to give it as yet.

In the last two years many of *QST's* best articles have been by "Member Experimenters' Section". No other group has made an equal showing. Several old and knotty questions of amateur radio have been given their first practical answers by the Experimenters' Section.

The Section is therefore turned over to Mr. Westman and his aides with some pride as to a good record left behind. To those who aided in the making of that record—goodbye and good luck!

Robert S. Kruse.

Mr. J. Stanton Chapman, "Neverland", P. O. Box 175, Sewanee, Tennessee, recently sent in a letter which deals with the intriguing subject of r.f. chokes. We are taking the liberty of publishing Mr. Chapman's letter below.

Use of a Non-Magnetic Meter for Testing R. F. Chokes

IN constructional descriptions of transmitting sets it has been standard practice, in the case of the Hartley circuit, to place one r.f. choke in the positive power lead. The question of the efficacy of this choke has been the cause of much grief, and most amateurs have at one time or another made and tested scads of the things.

F. A. Lidbury's excellent report in the October, 1927, *QST* gives much worthwhile information, but most of his work appears to have been confined to the antics of *one* choke, and this at all times in series with a milliammeter. This instrument was, presumably of the usual magnetic type.

Now, in the course of some rather haphazard choke tests; both before and after the appearance of Lidbury's report, I reached the conclusion that an ordinary milliammeter, having of necessity a coil in its innards, must itself act as a choke, and so affect the general efficiency of the circuit.

A simple proof of this is to tune the set for best output then short-circuit the m.a. and watch the aerial ammeter fall. Of course, slight re-tuning will restore the output, or perhaps not, but the point is that shorting the m.a. has made a change which should not have occurred. Evidently some form of non-magnetic meter is indicated for choke testing.

Well, it so happened, that a friend in Europe sent me a hot wire milliammeter. Now, I thought, this thing ought to show r.f. leakage past the choke, as well as indicate the plate current. It did.

I know that hot wire meters are not particularly accurate, also that they read effective values of current when using a.c., but for use in choke testing approximate values of current are near enough. The main thing is that a hot wire meter will give some surprising readings if it is substituted for a magnetic meter in an average set.

The main point of this letter has now been made; i.e., *use a non-magnetic milliammeter when testing r.f. chokes in a transmitting set.* Now you can skip the rest of this if you happen to have a date; but I will state a few findings and conclusions that might be worthwhile for someone to check up.

About that choke again. Friend Lidbury did not say just how he tested a choke in a transmitting circuit, and I do not know how other folks attack the business, so in order to make my following comments quite clear, this is how I do it: The output leads from the set (feeders, or ant. and c.p.) are disconnected, and various chokes are clipped in. The current shown on the m.a. is noted for each choke. The plate voltage, filament voltage and wavelength are kept constant. (Slight re-tuning of the primary condenser, is necessary in most cases to keep the wave the same.) The choke that allows the circuit to oscillate with the least plate current is termed the best one. A further test of this "best" choke is made by seeing how much closer the filament clip can be moved toward the grid end of the coil without stopping oscillation. The output leads are then re-connected and the difference noted in the output and input amps. as compared to the first readings. Al-

lowance is made, of course, for any change in the position of the filament clip.

We will suppose that in this test one choke was used in the positive lead and

the working wave. Lidbury's $\frac{1}{2}$ " x 2" choke is good at 40 meters when two are used, but even two of these appear too large on 20 meters. The size of the wire and the diameter of the form (up to 1") appear to be immaterial if the "fundamental" is about right; (3) one way to check the choke effect of a magnetic meter is to put a hot wire one in series with it, first on one side and then on the other. If there is r.f. current in the line the hot wire meter will read higher when it is between the magnetic meter and the set than when it is on the other side.

I have found that when two good chokes are used, the two meters will read nearly alike, whichever way they are put in the circuit, or in either power lead.

Considered purely from the standpoint of power output (provided that the closed and radiating circuits are reasonably loosely coupled) the difference between a pair of good chokes and a single poor choke with the m.a. doing half the work, is comparatively slight, unless the choke is so bad that the circuit oscillates unsteadily. Probably this is why we have been able to work for so long with any old choke in the set. There, is however, an actual gain in output amps. when using good chokes, and this, together with improved general efficiency not to mention steadier oscillation seems to warrant further work on the choke problem.

Most of the foregoing would seem to apply to chokes in a full wave self-rectifying circuit, as the hot wire meter shows that the two main chokes are critical until a third one is placed in the center tap lead from the transformer. When this is done the input mills drop and the output goes up as before.

However, I have had very little success when trying to use two ux-210 tubes in a full wave circuit on 20 meters. The difficulty is that I can only get a raw a.c. note. The tubes appear to oscillate at slightly different wavelengths, probably due to small differences of construction, but this is beside the point.

(1) If a single choke is used, its "fundamental" must be half, or a little less than half, the working wave to which the set is tuned. It is very critical as to the number of turns. Ten turns, more or less, will increase the m.a. reading, although the output may not change much; (2) Two chokes are the best bet—one in the positive and one in the negative lead. These are far less critical and need not even be the same size. The indications are that the "fundamental" of each should be below rather than above

In these full wave tests another choke problem was encountered. This time it was the beastly little inter-grid choke. I find that no closely wound choke is any good, whatever the size or number of turns used. Space wound chokes will work, but they must not be in inductive relation to each other. This is on 20 meters of course. On 40 meters 26 turns tapped in the center are all right; but on 20 meters the chokes

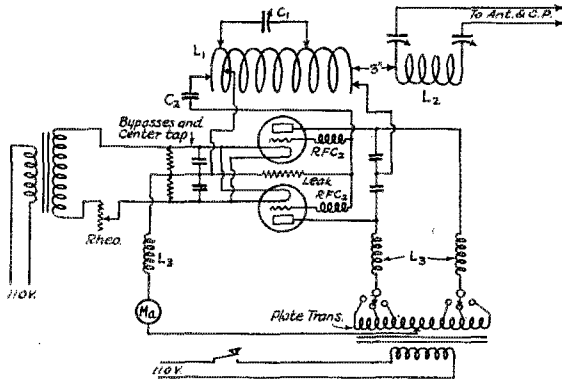

FIG. 1. CIRCUIT UNDER DISCUSSION

The circuit is normal and the constants also.

C1—.00025 ufd.

C2—.00025 ufd.

C3—.00025 ufd.

Leak—15,000 ohms.

L1—8 turns, $\frac{1}{4}$ " copper tubing.

L2—Antenna coupling coil.

L3—R.f. chokes under test $\frac{1}{2}$ " diameter, $1\frac{1}{4}$ " long, wound as explained in text.

L4—Grid chokes, 18 turns $\frac{1}{2}$ " diameter, space wound.

must not be wound on the same form. Also, the turns are critical.

I am enclosing a rough curve showing the effect on the plate current of the number of turns of wire on two $\frac{1}{2}$ " space wound grid chokes used in an unloaded Hartley circuit. I doubt whether this curve has much meaning for any other set, as I do not know how much the other constants; grid condenser, blocking condensers, etc., affect the situation, but I am sending it along in case it might be of interest.

In this case, high plate current is taken to mean that very high frequency oscillations between the tubes are using up the

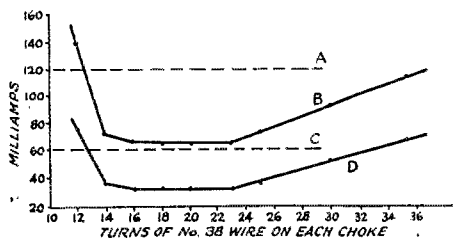

FIG. 2 CURVES OF CURRENT "BEHIND" THE R. F. CHOKE L OF FIG. 1, AS MEASURED BY A HOT WIRE MILLIAMMETER

The wavelength is 40 meters. One UX210 tube is used.

- A. Non oscillating—300 volts.
- B. Oscillating—300 volts.
- C. Non oscillating—500 volts.
- D. Oscillating—500 volts.

power so that the pair of chokes that cut the plate current to the lowest value are the best. If the chokes are too small, the tubes will pull more than the non-oscillating load. The curve shows this. Re: hot wire milliammeters. These things are not so exceedingly hard to make. An alarm clock makes a good case. The spindle and bearings for the pointer come, complete, out of the clock works, or from a dollar watch. Two brass angles (one made with a tongue for zero adjustment) are mounted on hard rubber or on paraffined wood cut to fit the case. A scrap of silk thread, a broom straw for a pointer, a small wire spring and you have everything for the meter except the wire. This can be obtained from the series resistance of a cheap voltmeter. Its diameter will be about .003". Rub two and a half inches of this wire between an oilstone and plate glass, with kerosene, till a mike says it is .0015" diam. This size will read from 40 to 160 mills. .002" wire will read from 60 to 220 mills; .003" wire from 100 to 400 mills. Readings are only approximate as wire and meter construction will vary. I have made several of these things that work quite well. They

can be shunted, of course, for use as aerial ammeters.

The dope here set forth may be all wrong, or otherwise not meet with your approval, but here it is for what it is worth.

A.R.R.L. Technical Information Service Rules

Please help us by observing the following rules:

1. Keep a copy of your questions and diagrams and mention that you did so.
2. Number the questions and make a paragraph of each one.
3. Make diagrams on separate sheets and fasten them to the letter.
4. Print your name and address (not merely your radio call) on your letter. Don't depend on the return address on the envelope as this is destroyed when the letter is opened.
5. Don't ask for a comparison of the various manufacturers' products.
6. Before writing, search your files of QST—the answer probably is there.
7. Address all questions to Information Service, American Radio Relay League, Inc., 1711 Park Street, Hartford, Conn.
8. It is not essential to enclose an envelope as long as you supply postage and PRINT CLEARLY your name and address on your letter.

OUR COVER

The photograph shows KDKA of the 62.5-meter wavelength with Mr. C. W. Horn, Supt. of the Radio Operations Department, Westinghouse Elect. & Mfg. Co., East Pittsburgh, Pa. "tuning up".

The radio frequency apparatus is of the crystal-controlled type. The crystal controls the frequency of a 5-watt tube and this is amplified through to a 250-watt stage, one 500-watt balanced stage, one 10-Kw. balanced stage and one 20-Kw. balanced stage. The modulation is accomplished by the constant current system. Coupling to the antenna is by means of a short transmission line, the antenna itself being of the grid vertical conductor type. Transmissions from KDKA on this wavelength have been successfully relayed in England, France, Germany, South Africa and Australia. The quartz crystal as a frequency stabilizer has gone a long way in improving the quality of transmissions at short wavelengths.

We reproduce this photograph through the courtesy of Mr. Horn and the Westinghouse Electric and Manufacturing Company.

Designing Small Transformers

By R. C. Hitchcock*

THREE factors used in transformer design can be given in a convenient form by a three column alignment chart.¹ These factors are flux density, core area, and turns per volt. The relation of these is:

$$\frac{N}{E} = \frac{10^8}{4.44 B A f}$$

- N = turns
- E = volts
- B = flux density per unit area
- A = area (same units as used for B)
- f = frequency in cycles per second

As an example to illustrate the use of the chart, suppose a transformer to be designed to use 4% silicon steel 1-1/4" wide, and stacked 1-1/4" deep. The area would be 1.25 x 1.25 = 1.56 square inches; this point is located on the second column. Suppose further that the flux density, shown in the first column, is to be 60 kilolines (thousand lines) per square inch. Lining up these two values, the turns per volt for 60 cycles are found to be 3.8. For a 110 volt 60 cycle supply, this transformer should have a primary of 3.8 x 110 = 418 turns, and the other windings are calculated in a similar manner. In the case of secondary windings where a definite voltage must be delivered, a few percent extra turns may be added to compensate for losses, this will be mentioned again later.

HEAT LOSSES

The allowable percentage losses for a small transformer are relatively greater than for a

large one. That is, a loss of 5 watts is not considered serious if the output is only 20 watts, whereas a large transformer delivering 20 kilowatts would never be designed to have as great a loss as 5 kilowatts. This is explained in part by the fact that the radiating surface increases as the square of the linear dimensions, while the volume increases

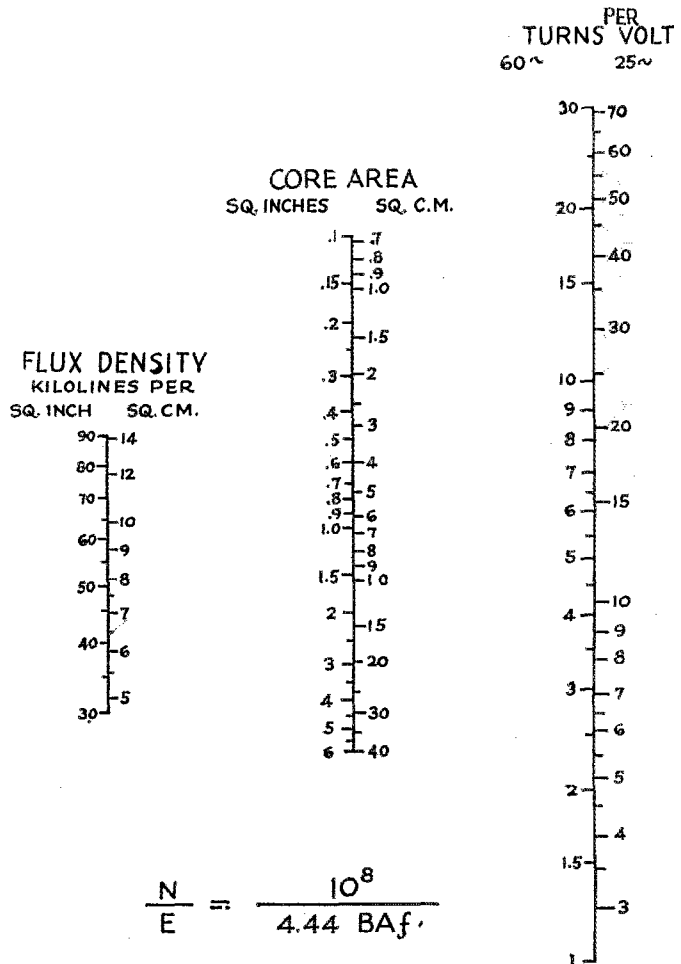

as the cube. A small transformer has a relatively larger surface to radiate heat, while for the same temperature rise a proportional amount of heat could not be radiated from a large transformer.

The losses in transformers are of two

*Research Department, Westinghouse E. & M. Co., East Pittsburgh, Pa.

1. A. H. Babcock, QST, Oct., 1926, page 29, gave the formula, and a short description of transformer design. It is believed that the present chart simplifies calculation.

kinds, copper and iron losses, the latter being due to eddy currents and hysteresis. The eddy current losses vary as the square of the product of the lamination thickness, induction, and the frequency; at both 25 and 60 cycles.³ The hysteresis loss varies as the frequency and as the 1.6 power of the induction.⁴

From the above it will be clear that thin laminations and low inductions are desirable to keep down the iron losses. For the small transformers which are considered in this article, accurate calculation of these losses is not absolutely necessary. As a matter of fact, in using a large core to reduce the iron losses by decreasing the induction, the copper losses are increased, due to the increased length of each wire turn. Copper losses can be calculated by I^2R as in regular direct current work. The calculation of the best balance between copper and iron losses is not a simple matter, and for small transformers it is considered to be too complicated for the slightly improved results which would occur. To allow for the iron and copper losses, a few extra turns should be added to secondary windings where a definite voltage is desired. These added turns seldom amount to as much as a 10% increase over the value calculated from the turns per volt multiplied by the desired volts, as already mentioned.

FLUX DENSITIES

For a 25-watt transformer a flux density of 60,000 lines per square inch is suggested. For transformers of higher power where the relative heat loss should be less, the lower flux density of 50,000 lines would be preferable. For small transformers supplying less than ten watts, as filament transformers for the new a.c. receiving tubes, a flux density as high as 70,000 lines would be possible. With the present grades of transformer iron, 80,000 lines per square inch is the upper limit, while for the poorer grades of iron a density of about 30,000 lines is the maximum without causing undue heating. All the flux densities suggested allow for a possible ten percent loss of space due to the inability of stacking the core iron tightly. On the chart, core area is given in both Metric and English units. The flux density is given in both systems of units. The third column of

turns per volt is given for both 60 and 25 cycles per second.

An effective shield² should surround transformers, especially those which are run at high flux densities. A complete shield of 1/16" iron is good, and is improved if an inner shield of 1/32" copper is also used. These precautions apply especially to transformers used near radio receiving sets, where the stray power field would cause an objectionable hum.

The chart is intended only to give a quick answer to the problem of the necessary turns per volt for various small sized cores, and for the usual flux densities. The calculations for losses have not been included, but may be found in handbooks.⁵ For constructional details, carrying capacities of wires, and turns per inch, the various engineering handbooks may be consulted.⁵

A Correction on the Double Detection Receiver

Through an error in drafting, the coil L6 in the diagram Fig. 1 on page 10 of the March issue was enclosed in the oscillator shield. This of course made it quite impossible for the coil to function as a "pick-up coil", feeding the oscillator output to the first detector. The corrected diagram

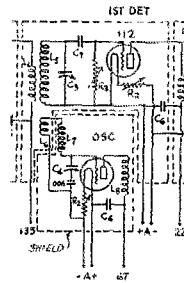

is shown herewith. Note that L6 is now in the same compartment with L4 and L5, which is as it should be.

Referring to the photograph and accompanying label on page 10 of the March issue (Below Fig. 1) will explain the corrections more fully.

Strays

For the benefit of those who may not know it, the word, "transceiver" used in the cut label on page 52 of the March, 1928, issue is a trade name coined to describe a combined transmitter-receiver as manufactured by the Chicago Radio Laboratory of Chicago, Ill., about eight years ago.

2. A thin and close-fitting shield may heat by reason of induced currents in it, therefore ample thickness and clearness are advisable. Any closed shield tends to reduce cooling, therefore it may be desirable to fill the shield with transformer oil or to omit it where strong fields can do no harm—that is to say where no tube or other circuits will be affected.
—Tech. Ed.

3. E. G. Reed, *Transformer Practice*, page 24.

4. E. G. Reed, *Transformer Practice*, page 32.

5. The Radio Amateur's Handbook also gives this material pp180-187.

The Communications Department

F. E. Handy, Communications Manager
1711 Park St., Hartford, Conn.



Santa Paula Flood Work

TO TWO amateurs in particular and amateur radio in general goes the honor for the speed and dispatch with which the Red Cross sent supplies and assistance to the survivors of the recent Santa Paula flood disaster in the San Francisco Valley.

The wall of water released when the dam broke, swept over the lower section of Santa Paula at 2:30 in the morning. Telegraph and telephone lines were torn down and communication with the outside world was cut off. It was imperative that Red Cross Headquarters in San Francisco be notified immediately so that supplies and equipment could be rushed into the stricken area. Officials approached C. A. Primmer, 17 year old owner of 6BYQ, a little doubtful if he could get the message through. It did not take them long to revise their opinions, after Primmer had sent a hurried CQ. W. A. Hammond, 6ALX, veteran Sixth District radio instructor, was at 6AUT, the Roosevelt High School station in Oakland, and hooked 6BYQ after his CQ. Primmer asked him if he had heard about the disaster. When 6ALX replied in the negative the other man had evidently rushed off in a hurry and forgot to come back. A little later 6BYQ came on the air again and CQ'd SOS, and was again hooked by 6ALX. 6BYQ shot through a message to the Red Cross Headquarters in San Francisco, which was immediately phoned by Hammond, and a message returned announcing that a trainload of workers and supplies would be on the way in a short time. 6ALX inquired after a Roosevelt school teacher at Santa Paula, and Primmer was able to give him the information as she was standing by his side at the time. Later 6BYQ hooked Whittier and Los Angeles, giving press to the latter, which was copied for San Francisco by 6ALX. Then 6BYQ switched back to 6ALX for direct press. The terrifically fast work was accomplished because both men were real operators.

No one shirked his job. Primmer was on at 4:30 AM and stayed at the key continuously until 5:00 PM. 6DCJ then relieved him for an hour, when 6BYQ went on again until 10:30 that night. The following three days BYQ stayed home from school in order to be on the air. The set used was a 7½ watt with 350 volts of "B's". The total of important messages handled was about 50,—not counting replies.

LeRoy Potter, 6AKW, let his work slide and got on the air on 40 meters. He tried to hook Santa Paula, Oxnard, and Ventura, but unfortunately was unable to establish communication.

6BLH of Los Angeles, notified a good many people of the disaster. The A.R.R.L. had done all over the United States by radio. 6ALZ took some messages for 6BYQ. From 10 PM on they were mostly personal messages. 37 out of 40 radiograms got through same day. All day there were many Los Angeles ops standing by, so there was no worry about delivery.

This whole thing was just another exhibition of the true amateur spirit, and his willingness to let everything slide when there is a possibility of his being of service in an emergency. Excellent work was done by many of our west coast fellows, and hearty congratulations go to them all.

—6CZR and 6AM.

Ten-Meter Results!

Within one month from the date of the opening of the new ten-meter band by the Federal Radio Commission, the enthusiasm of a number of individuals has led to real results which it is our pleasure to outline here for the information of other ten-meter experimenters.

The credit for the very first two-way ten-meter transcontinental work goes to Bill Eitel, 6UF, Knowles, Calif.; H. J. Bannon, 8EX, Cleveland, Ohio; J. E. Koski, 6DBO; Raymond, Calif., and Al Baling, 8ALY, Rochester, N. Y. We are going to let the principals responsible for the pioneering and results tell the story just as it happened.

"At 8:30 a.m. P.S.T. April 1, 1928, I was QSO nu8EX on ten meters. At 10:05 I worked 8ALY, the latter being at Rochester, N. Y. He was worked several times during the day and his signals were R7 at times. Nu6DBO worked 8ALY at 11:15 a.m. P.S.T. April 1. 6DBO was putting 165 watts on an 852 in a TP-TG circuit and using a vertical half-wave Zeppelin antenna system. I used a 7½-watt M.O. with about 15 watts input. This is amplified with an 852 with 90 watts input. I used a vertical quarter-wave aerial and a horizontal quarter-wave counterpoise. I find the M.O. and P.A. best for short waves because I get rid of grid troubles in the larger tubes. A 203-A will work nicely at 10 meters with a neutralized power amplifier."—Bill Eitel, 6UF, ex6ZAT

"Was QSO 6UF and 6DBO on 10 meters today (Sunday). Worked 6UF at 1:05 p.m. E.S.T., his sigs R5, mine R4 to 7. Worked him again at 3 p.m. E.S.T. 6UF coming through 6-7 and very steady. 6UF QSP'd 6DBO at 2:15 p. m. E.S.T. and I hooked him immediately. Equipment: 852 in series-feed Hartley circuit, 180 watts input and double-wave horizontal hertz antenna only 11 feet off the ground. Who said 10 meters was ND?"—Al Baling, 8ALY.

"Going down to the short waves my 50-watter let go in the base and turned violet around 12 meters. It promptly burned out. At present I have been listening around 10 meters at odd times Saturday and Sunday afternoons. Am using two seven watters self-rectification, inside Hertz antenna and 40 watts input. I was QSO nu6UF twice today (April 1.) He was R6 here at 11:30 a.m. and R5 two hours later. Sigs showed no inclination to swing or fade. His report on my sigs was R6 to R7. By next week I hope to have the 852's perking!"—H. J. Bannon, 8EX

"ON TEN METERS nu2JN has been received on several Sundays R2 to R7 and unusually easy to copy."—E. A. Dedman, ex2NH, New Malden, Surrey. oa6SA asks us by radio (through 9ECZ) to inform the gang of 10-meter men that he is running test transmissions on ten meters each Sunday at 0355 Greenwich and each weekday at 0030 Greenwich until further notice. Let him have a report via 8GZ.

Charles Smith, 3AKW, reports hearing 9DRD's 10-meter signals R7 and R8 on March 18. He succeeded in making a two-way 10-meter contact with 3JN on March 25. 9AIR (Sleepy Eye, Minn.) has a 10-meter station in action using a reflector system. Radiograms and cards indicate much more 10-meter activity than reported above. 9ALZ, 9KV, 9ZA, ex8PX, 1AAL, 3BJM, 3JM, 8AVL and oz2AC are among those interested.

Ten-Meter DX-Party Coming

Attention, experimenters! Get ready for the first QSO party to be held on the new ten-meter band.

The dates set for opening the new band by a test are May 19, May 20, May 26 and May 27. Mark them up on the calendar now and don't forget to be on deck. Messages have been sent to foreign amateur societies with the hope that amateurs everywhere will participate. Information on late developments will be sent out from Hq. through the Official Broadcasting Stations and 1MK.

Here's the information which tells how to participate. Just get on the air with a receiver that will cover the band between 9.99 meters (30,000 Kc.) and 10.71 meters (28,000 Kc.) and a transmitter working between the wavelengths stated. If you haven't a wavemeter for this order of wavelength measurement you can calibrate a condenser-coil combination roughly using a 20-meter oscillating receiver, a standard 20-meter wavemeter, and finding the 10-meter harmonic on the 10-meter tuner. The second harmonic of WIK (fundamental near the top of the 20-meter amateur band) is a great help in getting the receiver and transmitter properly adjusted, lacking equipment for accurate measurement. Many five-meter receivers have been described in *QST*. By following the principles mentioned in these articles really good 10-meter tuners can be built.

When on the air on the above dates log everything heard in the vicinity of ten metres and work stations heard if possible. Send this log to the Communications Manager promptly with your score on May 28. Count ONE in your score for each ten meter signal logged. Count FIVE for each station worked using ten meters. Be sure to give complete information on the audibility, note, and steadiness of the stations heard together with time and weather conditions. Describe transmitting antenna in full, giving tube rating and plate input power used as well as any other features that would be of interest. Scores and other information of general interest will be published as promptly as possible and the outstanding stations will be mentioned through the Official Broadcasts. If the stations taking part express a desire to have further tests of this nature, suggestions for the conducting of such tests will be welcomed with the reports of results of the DX-party.

Don't forget. See you on ten meters May 19, 20, 26, and 27.

Suggestions and Volunteers Wanted on 160 Meters

New and beginning hams often write that they find difficulty in getting in touch with other men who like themselves are starting in with amateur radio work. Sometimes they ask us for the calls and wavelengths of amateur stations sending at slow and medium speeds. This problem leads us to wonder if there is not a very definite way in which *QST* can help. A column in *QST* can be used to list the stations undertaking a program of transmissions of interest to new amateurs. The same department can put parties interested in corresponding with each other by letter and over the air in touch by letter or postal or perhaps directly through reports appearing the *QST* column.

The logical wavelength for this work is 150 to 200 meters which is a band less congested than our other wavelength territory. Stations working in this vicinity willing to help are asked to drop us a line stating how much time can be devoted to ten-word-per-minute transmissions and QSO's with interested new brasspounders. Let's hear what you think of the idea, OM. Your suggestions as to the best way in which this work may be handled will be appreciated.

New brasspounders: Please write us also and tell us just what you think of the proposal. Tell us what sort of transmissions would interest you most; the most convenient time and wavelength in the 150 to 200-meter band. If you need any information first to enable you to send and receive on this band just tell us all your needs and we will find a way to help.

Established 160-meter stations please volunteer your aid. New hams interested in increasing code speed and in making two-way radio contact and schedules with other new hams please let us have your name and address. Comments, suggestions, and questions on any phase of this work should be addressed to Communications Department, 160-Meter Transmissions, A.R.R.L., 1711 Park St., Hartford, Conn.

—F. E. H.

The times each day devoted to schedules and general operation on 41.93 meters (7150 Kc.) and 83.86 meters (3575 Kc.) by 1MK were given in full in these columns last month. The station is at all times ready for traffic for any individual or department at Headquarters or for QSR.

Many schedules are kept to facilitate the prompt handling of traffic with all parts of the country. The station has been kept very busy in the "general" operating periods as testified by the large number of QSO's shown in the log. It is suggested that when there is any delay in passing a message to 1MK in the "general" periods that messages be given to some of the stations with which 1MK has regular schedules. A list of 1MK-schedules follows, each station acting as a collection and distributing point for traffic: (time given E. S. T.)

1AHV (80)	Roslindale, Mass. Mon. and Fri. 7.30 p.m.
1APL (80)	Springfield, Mass. Sunday 7.00 p.m.
1BQD (80)	Newport, R. I. Mon. and Fri. 9.00 p.m.
1VB (80)	Newtown, Conn. Tues. and Fri. 7.45 p.m.
nc2BR (40)	Point Claire, Que. Sunday 9.45 p.m.
2CP (80)	Fords, N. J. Sunday and Thursday 11.45 p.m.
2GP (80)	Richmond Hill, L. I., N. Y. Mon. and Fri. 9.30 p.m.
3BWT (80)	Washington D. C. Mon. and Thurs. 7.15 p.m.
3QP (80)	Philadelphia, Pa. Mon. and Thurs. 7.00 p.m.
3ZS (80)	St. Davids, Pa. Mon. and Thurs. 7.45 p.m.
4IE (80)	Sarasota, Fla. Thurs. 11 p.m.
4XE (80)	Winter Park, Fla. Sunday 7.30 p.m.
4ZA (40)	Atlanta, Ga. Tuesday 11.00 p.m.
6NX (40)	San Jose, Calif. Monday 11.45 p.m.
8CJ (40)	Mancelona, Mich. Sunday 9.45 p.m.
8AYB (80)	Buffalo, N. Y. Tuesday 11.30 p.m.
8DED (80)	Holland, Mich. Tues. and Thurs. 9.30 p.m.
nc9AL (80)	Toronto, Ont. Canada Tues. and Fri. 7.15 p.m.
9APY (80)	Chicago, Ill. Tues. 9.00 p.m.
9DGA (40)	Galesburg, Ill. Fri. 11.45 p.m.
9DNG (40)	Lawrence, Kansas Mon. and Fri. 11 p.m.
9ENM (40)	Pueblo, Colo. Mon. and Fri. 11.15 p.m.
9OX (80)	Louisville, Ky. Sun. and Thurs. 11.30 p.m.
9XI (40)	Minneapolis, Minn. Mon. and Fri. 11.30 p.m.

Official Broadcasts to A.R.R.L. Members are sent from 1MK simultaneously on 41.93 and 83.86 meters. Sunday, Tuesday, and Thursday 8 p.m. and Midnight. Monday and Friday 8 p.m. and 10.00 p.m.

Philippine traffic is routed through 6AMM (via 6NX). Other foreign traffic is being cleared very efficiently through 9DNG. In this manner the greater portion of the operating time is available for work with A.R.R.L. members. It is possible that a period on Wednesday may be set aside for work with members outside the U. S. and Canada at a later date though the present arrangement is working out most satisfactorily.

The periods for schedules are completely filled. Additional requests from reliable stations will be held on a waiting list and added when opportunity offers due to changes in the present line-up.

Whenever you want to QSO A.R.R.L. Headquarters look for 1MK in the "general" operating periods (which were listed last month) and give us a call, OM.

—F. E. H.

OFFICIAL BROADCASTING STATIONS (Additions)

6AGR, 6BBJ, 6BRO, 6CHA-6DWN, 9AAO-9CFP, 9BQD, 9DNG, 9DUD, 9ENM.

Reporting a Boat Race

By J. E. Dadswell, 4FF

eb-4aa eb-4bc eb-4wx eg-5j eg-6ig eg-6jk eg-6xp
ei-1fp ek-4au ek-4oa rjc.
Forty meters: lod ek-4dbs. Au revoir,
—Cliff Himoe

AN unusual short wave and broadcast tie up was effected at Sarasota on March 9 and 10 during the American Motor Boat Association races in Sarasota Bay, Fla.

A portable short-wave transmitter was installed on the U. S. C. G. C. 181, in charge of 4AEL, who is commercial telegrapher at WJBB, Sarasota. The unit was a compact 18 pounder using an UX-352. Pure d.c. was furnished the plate with no filter, from a 1500-volt dynamotor. A 30-turn 12-inch inductance was used for antenna, and a wire dropped overboard for a ground. Wavelength was 82 meters.

On the roof of the municipal pier a Grebe CR18 was in charge of 4IE, who copied 4AEL all afternoon. On the roof of the same building was a remote control microphone pickup and line output unit of WJBB, in charge of 4FF, who is president of the corporation which owns the broadcasting station.

As the boat race entries took their places in each respective race, 4AEL, on the cutter, flashed the entries to 4IE, who handed them to the broadcast announcer. In the race results, the dope was handled in the same manner, and whenever an accident occurred the judges were the first to learn the official information on the trouble or damages, and these were flashed ashore from the cutter together with the race results and official time.

The entire project went off throughout the afternoon without a hitch, and the Sarasota *Morning Herald* the following day declared itself as a backer of short-wave telegraphy for transmission of "spot news" from points where telephone service is not available.

Tampa, Florida, on the evening of January 19th was the Mecca for naval reserve and A.R.R.L. men when Lieut.-Commander Wm. Justice Lee, 4XE, and his Staff made a formal inspection of the Tampa unit. Lieut. Houston Wall, who acted as host of the evening, A.R.R.L. members and radio amateurs were also given an opportunity to meet and hear A. A. Hebert, A.R.R.L. Treasurer, at the general meeting. It is needless to report that the 40 that were present had a most delightful evening. Not many naval units can boast of such fine headquarters as the one in Tampa.

On May 1, 2, and 3 the Shriners attend their convention at Miami. 4u4CK will be on 20, 40, and 80-meter bands with seven ops. The station will be on the air 18 hours each day and wants schedules with points all over the country. Please help in handling this traffic, everyone!

WNP

WNP (Rec'd via 1FL) nr. 577, March 29 To F. E. Handy, A.R.R.L. Hartford, Conn. Started to list all new stations worked this month but the list grew too long, nearly two-thirds of calls worked were new ones. March started out well with QSA signals on twenty meters. Then a gale hit us on the 3rd and a blizzard on 6th and 7th which kept the noise level about R6. The rest of the month has been filled with snow squalls and wind and a great deal of noise. Storms seemed general over the U.S.A. also and we've had the dickens of a time trying to find stations who could read our signals. 8BEN was quite consistent during periods when everyone else faded and was QRZ. Early morning schedules with 1S2, 9AFA and 9EFH also worked quite well although we've had some real fights with QSS. Signals from 1FL were as erratic as the rest but Dick has the trick of reading them anyway. 1FL again handled the largest portion of our traffic. A schedule with ei-1FP at 1930 GMT has worked nicely. Tomorrow, March 30, WNP closes down until April 10. Want to try my luck with dog team before ice breaks up. Am going into Nain twenty-five miles with one Eskimo driver to spend Easter week. Traffic totals March sent 117, received 116, total 233. Calls worked March—twenty meters 1adm 1abn 1akm 1asf 1avj 1awv 1azd 1bay 1ber 1bfz 1bms 1ciz 1ckb 1com 1cti 1fl 1ga 1mx 1ry 1sz 1no 1xm 1zac 2adl 2ank 2aon 2bco 2bki 2bvg 2elp 2kr 2ol 2ox 2uh 2vi 2xg 3btq 3jm 3 in 3oe 3ov 4ni 5avs 5aid 5aso 5avs 5axz 5ayu 5baf 5ben 5bgn 5hja 5brm 5hto 5ocl 5cnc 5ndj 5dhs 5dsv 5doa 5afa 5api 5bkc 5bnt 5cnd 5dhp 5efh 5dzt 5emb 5eyu 5es 5ez no-1by no-1cc no-1co no-2al no-2bw no-3fc

9DWN reports QSO with naKDZ, the Wilkins expedition, while at Fairbanks, Alaska, March 4. Maki was at key of KDZ, and 9DWN handled a message to the *San Francisco Examiner*.

The *Morrissey*, VOQ, will soon be under way again. Ed Manley will be the operator, as before, and the radio equipment has been considerably improved. In the way of transmitters there is a self-rectified job using two 204-A's, a crystal control unit using 210's in the crystal and first doubler stages with DC on plates, and 352's and 204A's in a self-rectified arrangement with 500 cycle AC on the plates, in the second doubler and PA stages, built by Manley. There is a portable "transceiver" with B Batteries for supply, and the receiving equipment consists of the faithful Clayton-Westman job, and REL superhet, a Grebe short wave set, and a Grebe Synchronphase BC receiver. VOQ will use waves of 20.1 and 82.3 meters, the former between 6PM and midnight EST, and the latter from midnight to 2AM EST. Manley hopes to have several good Pacific Coast contracts, but especially hopes that stations in eastern U. S. will try to QSO on 20.1 meters in evening EST.

nu8CFR has been keeping a schedule with sb1IB, and handling traffic for GMD, the Dyott Expedition. He reports that GMD has left for Sao Paulo, and from there they are going to Cuyaba in southern Brazil. From Cuyaba they will enter the wilderness. They expect to be on the air by the middle of the month. 2TY has been working on a nightly schedule with 8CFR, and handling messages and replies in New York. FB work!

A motor truck expedition, sponsored by General Motors South African, Ltd., recently left Capetown, So. Africa, en route to Cairo, Egypt. The truck carries radio equipment and an operator. A Mullard 200 watt tube, fed by a 1500 volt generator coupled to the engine of the car, is used in a flexible 20-40 meter transmitter. An auxiliary transmitter working from a dynamotor will also be carried, and on both sets, either telephony or telegraphy may be used at will. The call is ASM, and amateurs copying any messages from the expedition are asked to mail them to Mr. C. H. Getz, c/o General Motors Export Company, General Motors Bldg., N. Y. C.

ARMY AMATEUR NOTES

SECOND CORPS AREA—All the Radio Nets have been reorganized into State and County Nets, and a mimeographed bulletin containing details of the reorganization was distributed to the various members. Schedules are kept every Monday night, on the 75-78 meter band, and the increased interest of AA men has brought about a traffic total ten times greater than normal. There is still room for amateurs in New York, New Jersey, and Delaware. All interested should QSL to 2PF or to Signal Officer, Governor's Island, N. Y.

THIRD CORPS AREA—8GI, 8AGO, 8BPD, 8DNU, have been successful in every schedule with the N. C. S. New members are 3AIR, 3ADE, 3SN, the N. C. S. has been doing some excellent foreign work.

SIXTH CORPS AREA—AA Radio Net established contact at Springfield, Ill. Attempts have been made for a year to connect this city and the Governor's office with net. 9NI is handling the traffic.

SEVENTH CORPS AREA—9ESE designated as principal station of Hq. Battery and Combat Train, 1st Battalion, 161st FA., Kansas N. G., Burlington, Kansas. 9IL appointed as the principal station to serve all Nat'l. Guard Units in Minneapolis. 9DWN principal station of A. A. Secondary Radio Net at Pierre, S. Dak. 9DB principal station of A.A. Secondary Net at Milbank, S. Dak. 9NM principal station of A.A. Secondary Net at Quinn, S. Dak.

EIGHTH CORPS AREA—5AIN has been keeping schedules successfully with 2CXL. Two or three foreign QSL cards for 5AIN have been received.

20 METERS

cb4AU (Peruwelz Belgium), "20-meters is the thing today! In February we can again QSO in midafternoon on 20-meters, the best break for five months. I have a sked with foA3Z and was just QSO ac1AC in Hong Kong. Try and find that QSO on the other waves!"

eg2NH, (New Malden, Surrey, Eng.), "The expected spring change in 20-meter conditions came in early March. Nu stations which had been fading out at 5 pm EST suddenly broke through at a much later hour and in middle March they are audible as late as midnight EST. It is interesting to note that some East Coast stations are louder at midnight than at 7 pm EST whilst to other stations in the same district the exact opposite is the case probably due to differences in antennas affecting the propagation angle. West Coast stations heard but little during the winter are now GSA at about ten pm EST. The So. American stations that disappeared last September now come in well sh11B and sc2AS being especially consistent. WIK is audible throughout the 24 hours with minimum strength. R5 nu8AXA, nhCA and myself have had some FB 3-way chats. nu9EH has been worked at the following times: 0000, 0200, 0300, 0600, 1200, 1400, 1700, 1900 and 2200 GCT! Nu 20-meter phones are very poor here. Most of them seems to be trying to modulate a RAC carrier and expect us to understand the speech."

8AXA (Syracuse, N. Y.), "An excerpt from my log shows that 20-meters is a good band at nearly any time of day for reliable international contacts. The following stations were worked during March at the times indicated (EST): 7.30 am oa3GR, 9 am np4SA, 10 am eg5VL, 11 am nu6JU, noon to 7 pm it is easy to work eg, eb, ef, gw any week end, 6 pm nhCA and fmTUNZ, 8 pm x1HV (ship in Pacific), 9 pm 6's and 7's 10.15 pm oz2AC, 10.30 pm RJC (ship in Atlantic), 11.30 pm na7MN. The opening of the ten meter band is the starting of a new era. I would suggest that '20-meter reports' be changed to '10-meter reports'. Now we know that 20-meters is a wonderful band, one worthy of mention but one which has been thoroughly experimented with and whose possibilities are very well known."

As indicated by the reports this month, 20-meter conditions are excellent. Communication work on this band is progressing so well in fact that we believe this column has outlived its chief usefulness—an idea which is checked by one of the contributors. Interest in the new ten meter territory is on the increase. Therefore starting with June QST the column of 20-meter reports will be discontinued. In its place we shall welcome constructive reports and suggestions on 10-meter work. There are many things to be found out about the new band to make it increasingly useful for communication as well as experimentation. Probably investigation of different types of antenna systems will be a most fruitful field for experiment to determine what arrangement is best for moderate and extreme distance work for a good number of our operating hours. It is hoped that the new 10-meter band (2,000 kc wide) can be developed to become as useful as the present 20-meter band for our general work which will in a measure make up for the crowding that may be expected on other bands in 1929. Let's get busy on 10-meters!

* The following should have been included last month:—6BSN 17, 64, 125, 206; 9BCA 166, 6, 23, 200; SDSB 40, 11, 165, 216

9AIN wins the coveted honor position this month with 6AJM and 8AHC close contenders. These stations all have totals in excess of six hundred messages—mighty fine and consistent operating work. FB!

op1HR, 1MK, 6AMM, 9EK, 1BIG, and 1CRA all boast of more than 100 deliveries in the message month. Once again we can say that it is schedules—fine reliable schedules with places both far and near—that are responsible for the fine showing of all the stations making the B.P.L. this month. A total of 200 messages handled or just 50 deliveries will put you on the honor roll. Why not plan to be there next month, OM?

BRASS POUNDERS' LEAGUE

Call	Orig.	Del.	Rel.	Total
9AIN	234	78	378	690
6AJM	50	18	596	664
8AHC	156	8	454	618
8DBM	58	37	411	506
op1HR	154	117	234	505
1MK	161	121	195	477
9DLB	15	28	430	473
9EZ	68	52	326	446
8GT	8	14	418	440
8BYN	99	40	289	428
8BEV	73	27	317	417
op1AD	149	57	206	412
3AKB	16	35	355	406
1FL	44	38	314	396
8DED	82	42	268	392
9EJQ	20	20	299	339
9DZW	8	24	296	328
9BKV	37	18	272	327
3KU	13	14	298	325
8CFL	26	34	261	321
2CP	69	30	215	314
9AQA	23	51	238	312
8RN	64	60	184	308
6AMM	69	175	61	305
9AGA	42	27	230	299
8CNO	31	18	246	295
1BLS	26	20	240	286
9COS	99	62	124	285
3ZF	36	45	202	283
9AMO	6	14	260	280
9EK	120	150	10	280
3ZI	11	14	244	279
1BOD	11	1	266	278
9CZC	3	9	264	276
8EU	17	38	220	275
7AJR	254	8	2	264
9EAM	8	39	209	256
9PB	5	44	206	255
8DAQ	12	2	236	250
9DTR	84	58	106	248
8CVJ	172	22	48	242
8CGZ	7	19	214	240
1TT	52	35	152	239
9BBU	10	—	221	231
1BNS	40	28	162	230
9CRV	11	25	188	224
1AKS	53	22	146	221
8AVK	18	18	180	216
6AKQ	3	2	210	215
2AOP	60	75	80	215
7AKK	30	32	152	214
3CFG	32	42	140	214
9BZO	21	81	112	214
9ABV	40	24	148	212
9FQ	66	50	95	211
1BIG	80	110	20	210
9CMV	53	76	80	209
6ZBJ	21	22	166	209
9CS	54	11	142	207
9DNG	62	41	104	207
8BBR	8	40	158	206
8CDC	31	27	147	205
8ZF	169	12	23	204
9CUX	7	12	182	201
1LM	43	50	82	175
6AD	45	87	42	174
9BN	54	76	19	168
1IP	28	58	80	166
nc4AH	43	56	64	163
6BSN	19	50	90	159
9ENU	50	54	54	158
5JY	38	58	67	163
6CGM	27	55	72	154
1WV	37	74	40	151
9RR	32	53	66	151
3NF	25	82	43	150
6BZR	8	74	64	146
1CRA	20	271	53	144
9DKG	48	58	35	141
6AM	—	80	29	139
2ALP	15	58	62	135
op1DR	40	64	24	128
9ABM	8	69	48	125
op1DL	47	64	12	113
7DF	45	52	16	113
2MD	11	60	40	111
8DQP	28	53	22	103
1KY	20	53	28	101
9CBT	12	54	22	88
7BB	—	60	24	84
9EFK	9	50	6	65
1AYJ	3	54	6	63

ELECTION RESULTS

Valid nominating petitions for Section Managers in the Southern New Jersey Section of the Atlantic Division, in the Alaskan Section of the North-western Division, in the Alberta Section of the Vanalita Division, and in the Northern Texas Section of the West Gulf Division were filed, in each case, naming but one candidate for the office. As provided by our Constitution and By-Laws when but one candidate is named in one or more valid nominating petitions, that candidate shall be declared elected. Messrs. M. J. Lotysh (3CFG.) W. B. Wilson, E. J. Taylor (nc5HA) and J. H. Robinson, Jr. (5AKN) are herewith declared elected for the next two-year term of office in their respective Sections.

In the East Bay Section of the Pacific Division, Mr. J. Walter Frates, 6CZR and Mr. J. H. MacLafferty, Jr., 6RJD and Mr. C. B. Anderson, 6CDA were nominated. Mr. MacLafferty withdrew his name from the list of candidates. Petitions for other candidates were received but were found invalid because of an insufficient number of signers who were League members in good standing and because of late receipt of one nominating petition. Election results: Mr. Frates, 25; Mr. Anderson, 14. Mr. Frates has therefore been declared elected.

In the Eastern New York Section of the Hudson Division, Mr. F. M. Holbrook, 2CNS, and Mr. Lionel Samuel, Jr., 2AYK, were nominated. Election results: Mr. Holbrook, 39; Mr. Samuel, 14. Mr. Holbrook is herewith declared elected.

In the Eastern Pennsylvania Section of the Atlantic Division, Mr. J. B. Morgan, 2nd, 3QP, and Mr. D. H. Ammon, 3ADQ, were nominated. Election results: Mr. Morgan, 108; Mr. Ammon, 25. Mr. Morgan is herewith declared elected.

ELECTION NOTICES

To all A.R.R.L. Members residing in the Sections listed below: (The list gives the Sections, closing date for receipt of nominating petitions for Section Manager, the name of the present incumbent and the date of expiration of his term of office.)

Section	Closing date for petitions on noon of the present year on dates specified	Present SCM	Present term of office ends (1928)
Western N. Y.	May 28	C. S. Taylor	July 1
Western Penna.	May 28	G. L. Crossley	June 24
Illinois	May 28	W. E. Schretzler	July 1
Indiana	May 28	D. J. Anus	July 1
Kentucky	June 28	D. A. Downard	Aug. 2
Ohio	May 28	H. C. Storck	July 1
Wisconsin	May 28	C. N. Crapp	July 1
No. Dakota	May 28	Prof. H. M. L. Sheets, Act- ing SCM	Aug. 2
So. Dakota	June 28	F. L. Beck	Oct. 2
No. Minn.	Aug. 28	C. L. Barker	Oct. 2
Louisiana	Aug. 28	C. A. Freitag	Oct. 2
Mississippi	May 28	J. W. Gullett	July 1
Tennessee	Aug. 28	L. K. Rush	Oct. 2
N. E. C. & L. I.	June 28	F. H. Mardon	July 27
No. N. J.	June 28	A. G. Wester, Jr.	July 27
Kansas	May 28	P. S. McKeever	July 1
Missouri	May 28	L. B. Laizure	July 1
Nebraska	May 28	C. B. Diehl	July 1
Connecticut	May 28	H. E. Nichols	July 1
Maine	May 28	Frederick Best	July 1
Western Mass.	May 28	A. H. Carr	July 1
New Hampshire	May 28	V. W. Hodge	July 1
Rhode Island	June 28	D. B. Fancher	Aug. 2
Vermont	May 28	C. T. Kerr	July 1
Idaho	Aug. 28	Henry Fletcher	Oct. 2
Nevada	July 28	C. B. Newcombe	Sept. 15
Santa Clara Valley	Aug. 28	F. J. Quement	Aug. 2
No. Carolina	Aug. 28	R. S. Morris	Oct. 2
West Va.	June 28	C. S. Hoffman	Aug. 2
Colorado	Aug. 28	C. R. Stedman	Oct. 2
Alabama	May 28	A. D. Trum	July 1
Ga.-S. C.-Cuba-Isle	June 28	H. L. Reid	Aug. 2
of Pines-P. R.	May 28	K. L. Ehhret	July 1
Oklahoma	May 28	E. A. Sahn	July 1

Newfoundland and Canada

Newfoundland	May 28	Loyal Reid	July 13
New Brunswick	June 28	T. B. Lacey	Aug. 2
Nova Scotia	June 28	W. C. Borrett	Aug. 2
P. E. I.	June 28	F. W. Hyndman	Aug. 2
Ontario	Aug. 28	W. Y. Sloan	Oct. 2
Quebec	July 28	Alex Reid	Sept. 15

Nominating petitions for Section Managers in Newfoundland and Canada should be addressed to Canadian General Manager A. H. Keith Russell, 5 Mail Building, Toronto, Ont., Canada. To be valid,

petitions must be filed with him on or before the closing dates named.

Members of the A.R.R.L. in the Utah-Wyoming Section of the Rocky Mountain Division and in the Philippine Section of the Pacific Division have failed to take any action. As no valid nominating petitions have been received in response to our previous notice, the closing dates for receipt of nominating petitions are set ahead to the dates given herewith:

Utah-Wyoming Section May 28
Philippine Section July 28

1. You are hereby notified that an election for an A.R.R.L. Section Communications Manager, for the next two-year term of office is about to be held in each of these Sections in accordance with the provisions of By-laws 5, 6, 7 and 8.

2. The elections will take place in the different Sections immediately after the closing date for receipt of nominating petitions as given opposite the different Sections. The Ballots mailed from Headquarters will list the names of all eligible candidates nominated for the position by A.R.R.L. members residing in the Sections concerned.

3. Nominating petitions from the Sections named are hereby solicited. Five or more A.R.R.L. members residing in any Section have the privilege of nominating any member of the League in their Section as candidate for Section Manager. The following form for nomination is suggested:

(Place and date)

Communications Manager, A.R.R.L.
1711 Park St., Hartford, Conn.

We, the undersigned members of the A.R.R.L. residing in the.....Section of the.....

Division hereby nominate..... as candidate for Section Communications Manager for this Section for the next two-year term of office.

(Five or more signatures of A.R.R.L. members are required.)

The candidate and five or more signers must be League members in good standing or the petition will be thrown out as invalid. The complete name, address, and station call of the candidate should be included. All such petitions must be filed at the headquarters office of the League in Hartford, Conn., by noon of the closing date given for receipt of nominating petitions. There is no limit on the number of petitions that may be filed, but no member shall sign more than one such petition.

4. Members are urged to take initiative immediately, filing petitions for the officials of each Section listed above. This is your opportunity to put the man of your choice in office to carry on the work of the organization in your Section.

—F. E. Handy, Communications Manager.

Rotten QSR

SEVERAL times in the past three or four months, I have heard stations handling traffic addressed to me. I have copied the message and patiently waited for them to arrive by QSR or QSRM. I am still waiting for three such messages that I copied three months ago.

It is hard to see how some of the gang can be so careless. Perhaps a "lid" got these messages and garbled the address. There is no excuse for a message "dying" when there are stamps, envelopes and paper still on the market. Can any one tell me what happens to lots of traffic? I can tell you! It is copied by someone who takes it as code practice and throws it in the waste basket.

If the individuals responsible will accept their share of personal responsibility (1) refusing messages they have no intention of handling due to temporary operation of their station or similar good reasons, (2) passing on traffic promptly when it has been accepted for QSR, (3) and mailing to destination in accordance with the R. & R. when it is 48 hours old or when it is known that pressing business will prevent station operation for a few days, conditions will be greatly improved. When a message leaves a station, there is no reason in the world for its failure to be delivered, so remember that, gang, and do your share and we will all profit by it!

—O. W. Viers, 7AAT, SCM, Montana.

DIVISIONAL REPORTS

ATLANTIC DIVISION

EASTERN PENNSYLVANIA—Acting SCM, E. L. Maneval, 8EU—Well, fellows, this report winds up my career as SCM of the East. Pa. Section, and want to thank you all for your cooperation. I hope you'll all give 3QP your full support as he's a good man and will do the job right with your help. 3AKB threatens to knock 40 for a row. 3ZF bats them out. 8EU had a close call from going up in smoke from a short in his haywire. Hi. 3CGZ has moved back up to the upper deck and bid the scullery goodbye until next winter. 3AVK is planning a tour to the west coast with a YL in his Lizzy. 3NF wants an ORS appointment. 8RQ moved to 528 W. 7th St. 3QM did a hasty job on QSR. 8BYZ was married last July but we just found it out. Congrats. 8WJ is a member of the fold. 3ADE, poor Lew, sniff, sniff. 8CWO is a new boy in Scranton. 3LC is a quiet lad. 8ADQ is at last on 40. 8AVL QSYed to 5 meters. 3CDS still insists that we be on from 1 to 3 a. m. 3VF almost made the BPL. Hi. 3AWT reported and had 3 zeros on his card. 3BNU has worked gobs of DX and can QSR to points unknown. 3ZF, 3VF, 3BJM, 3EO and 9ADN visited the Williamsport gang.

Traffic: 8DHT 64, 3AKB 406, 3ZF 283, 8EU 275, 8CGZ 240, 3AVK 216, 3NF 150, 8RQ 141, 3QM 86, 8WJ 83, 3ADE 68, 8CWO 46, 3LC 39, 8ADQ 20, 8AVL 11, 3CDS 9, 3VF 3.

MARYLAND—Del-D. of C.—SCM, H. H. Layton, 3AIS—Del: 3AED is still very active. 3ALQ has his chem rectifier going at last. 3AJH reports BCL QRM again. 3WJ boasts the only CC set in Del. and is craving traffic. 3AIS is active on 38.5 meters and is anxious to QSO all active stations in the Section.

Maryland: 3APX is now using raw AC as one of their rectifiers went west. 3CFX desires to arrange a sked with some active D. of C. station as he has lots of traffic. 3BBW blew another tube and is off the air until a replacement arrives. 3CGC will soon be on the air again. 3AEI reports QRM from bad power leak preventing him from pounding brass.

Dist. of Columbia: 3BWT reports everything running smoothly at present but expects to QRT for the summer.

Traffic: Del: 3AED 7, 3ALQ 3, 3AJH 3, 3WJ 18, 3AIS 9. Md: 3APX 25, 3CFX 105, 3BBW, 3AEI 2, D. of C.: 3BWT 37.

SOUTHERN NEW JERSEY—Acting SCM, E. G. Raser, 3ZI—Nine stations reported to the acting SCM this month, seven of them being ORS. This is FR. Mr. Lotysh, 3CFG, has been elected your new SCM and will take office immediately so please report to him next month. 3ZI made the BPL at last after a long and hard struggle. 3CFG is leaning toward DX again. 3AOC is doing good work on low power and keeps skeds with 2PF and 3ZI. 3SJ complains of spring fever and says not much doing. 3BWJ is back from West Point and has been on the sick list. 3BSD raised a new 50 footer and is sure some happy now. 3IV of Burlington, and 3AIO of Riverside are two new stations reported this month. 3APB comes in good on the 80 band.

Traffic: 3ZI 279, 3CFG 214, 3AOC 138, 3IV 11, 3BSJ 3, 3BWJ 22, 3BSD 4.

WESTERN NEW YORK—SCM, C. S. Taylor, 8PJ—8ADE handled traffic and schedules. 8ADG works foreigners, etc. 8ABX blew his transformer and has been handling traffic at 8BDI. 8AFG wants traffic west on 40 and 80 meters. 8AHC received a box of candy for handling a WNP message to Curtis Candy Co., Chicago. 8AID has an ORS coming to him for working on 40. 8AKC is changing to 204s. 8AKZ has handled some traffic. 8ALB posted notices in all Frat houses and got lots of traffic. 8ANX is back on the air again. 8AYS has been doing good work with message traffic. 8AVW is off the air due to rebuilding transmitter. 8AWU is handling traffic. 8DNE is rebuilding again. 8DQP works French hams. 8DRJ has been experimenting with mercury arc. 9DSP handled a message to Pres. Coolidge from Spring-

field, Mass. 8AYU has been working many foreigners including Africa. 8DDL reports 11 new stations in his town. 8DFY has handled quite a bit of traffic on 40 and 80. 8DHX says spring fever has gotten him now. 8DME got the Narwhal tusk for his exceptionally good work in handling traffic with VOQ. 8BCM works west coast. 8BFG handled traffic from France from 6HP. 8BGN works west coast. 8BLI is rebuilding xmitter and is therefore inactive. 8BLP is at school but promise to be on in June. 8BMJ did little or nothing. 8BUJ is rebuilding the station. 8AAW has rejoined amateur radio after a four year lapse. 8BUP is keeping skeds with 5ARY and is fooling with 20 meters. 8BPZ is trying to catch up with expenses due to an accident. 8CDB works WNP. 8AXA works Alaskan 7MN. 8CDC keeps schedules with Cleveland and Elkhart, Ind. 8CHL has just started in with traffic. 8CNT works eg, et, en, eh, oh and ep. 8CNX says DX has been wonderful. 8CPC handled some very important messages to Bermuda, Vancouver, Portland and Seattle. 8CSW of Cook Academy is very active. 8CVJ made the BPL. 8FU worked ej-TDD. 8KS says portable 8ABO will be back for the summer. 8PI handled 2 mgs with eg-5BY. 8PJ has just installed 2000 volts of B bats for a 250-watt. 8TH has been handling boy scout traffic with N. Y. C. SOA handled traffic to Commandant of 3rd Naval District.

Traffic: 8ADE 3, 8AHC 618, 8AKC 109, 8AKZ 5, 8AFG 28, 8ALB 70, 8AWU 10, 8ANX 5, 8AYU 161, 8BCM 31, 8BFG 43, 8BGN 7, 8BQK 2, 8BUP 6, 8BUJ 1, 8BMJ 40, 8CDB 130, 8CDC 205, 8CHL 14, 8CNT 30, 8CNX 64, 8CPC 52, 8CSW 34, 8CVJ 242, 8DLL 12, 8DFY 28, 8DHX 38, 8DME 132, 8DNE 14, 8DQP 103, 8DRJ 64, 8DSP 155, 8KS 3, 8PI 9, 8PJ 15, 8OA 34.

WESTERN PENNSYLVANIA—SCM, G. L. Crossley, 8XE—8CNZ reports plenty of traffic but few southern and western stations to take it. 8BRB is still pounding brass at KDO and is now on the west coast. 8VE is very QRW with medical school but still does some work on 42 and 21 meters. 8EW handled some marine traffic with Nicaragua and is using both 80 and 40 to do it. 8DKS is building a new rectifier and is off the air while he is doing it. 8ARC is using 281s for rectifiers on 20. 8XAM is at radio school. 8CYP is using a 50 watt master oscillator. 8CES is having trouble with QRM and QRN. 8BRM has had pneumonia and mumps. 8AYH is still using 80 meters. 8GI says it is time to get out the nickle polish and polish up the antenna cause there is too much QRN. Hi. 8AMU worked the yacht Fortuna off Long Key, Fla. the other night. 8AGO is to be married on May 9. Congrats. 8DOQ is using 2-281s. 8CEO took press and messages from the New York American plane 2XKB. 8ABW is using an 8" with a Zep antenna. Most of 8CFR's traffic was originated with the Dyott Expedition GMD and came thru 5b-11B. 8GU is operating in Erie on 75 meters. 8BDJ has passed the first class tests and now holds that license. 8CAE is holding classes for Boy Scouts and they are getting along fine. 8BHN is using a 222 on 20 meters. 8LS has moved to Erie. 8VF is putting in an 852. 8CXG repairs BCL sets. 8XE is very busy on the convention. 8XE has a crystal oscillator with a frequency of 1000 kc. and any ORS in the section found off-wave will have the ORS cancelled.

Traffic: 8GI 440, 8CNZ 151, 8DOQ 146, 8EW 108, 8CEO 95, 8AMJ 94, 8CFR 84, 8XE 63, 8AEF 51, 8BGW 23, 8ABW 21, 8CAE 16, 8CYP 14, 8AJU 9, 8DKS 6, 8DYF 5, 8AGO 4, 8AYH 4, 8VE 4.

CENTRAL DIVISION

OHIO—SCM, H. C. Storek, 8BYN—8BEV had time for plenty of DX. 8CFL and 8CNO complain of too many rubber stamps. 8RN is leaving shortly for the summer. 8BBR a non-ORS made the BPL. 8GZ has been blowing condensers. 8DSY kicks about the QRN. 8DDK made the BPL. 8BAU is rebuilding. 8CAU is on 80. 8CXD is starting on xtal. 8CPQ says that 10 meters seems to be as good as 20 m. 8CMB is now Official Observer. 8SI

has been keeping in touch with 8CLE who is attending Ohio Wesleyan Univ. 8BAC is a coming ORS. 8AKO has nothing to say for himself. 8CQ has been having antenna trouble. 8CNU is rebuilding. 8DJV has had the DX but. 8DIA, 8BOR and 8AVX have been busy. 8CCS has been experimenting with antennas. 8DTN is keeping schedule with gi-A8. 8AVB says not much doing in traffic line. 8ALW is playing with fone. 8DNL, 8OQ and 8DHS have been on 20. 8PL is awaiting a new tube for a frequency doubler. 8BAH has nothing new to report. 8BBH has a 171 going. 8AMI says more traffic next month. 8CCG got on at end of month. 8AYO doing BCL service work. 8DQZ is planning a new transmitter. 8BKM has been blowing tubes. 8QV has a new TPTG transmitter. 8DMX is having antenna trouble. 8BSC has sold out but will be back this fall. 8AWX regrets lack of time. 8ADH is getting back soon. 8DO, 8CBP and 8BQJ combined, have a 500 watt station under construction.

Traffic: 8DBM 508, 8BYN 428, 8BEV 417, 8CPL 321, 8RN 808, 8CNO 295, 8BBR 206, 8GZ 178, 8DSY 148, 8DDK 142, 8BAU 122, 8CAU 107, 8CXD 78, 8CPQ 71, 8CMB 45, 8SI 88, 8BAC 80, 8BOR 25, 8AKO 25, 8C24, 8CNU 18, 8DJV 16, 8AVX 16, 8CCS 14, 8DTN 14, 8AVB 12, 8ALW 10, 8OQ 10, 8DHS 9, 8PL 3, 8BAH 8, 8DNL 7, 8BBH 7, 8DJG 6, 8AMI 6, 8CCG 6, 8AYO 6, 8AZO 6, 8CTD 4, 8DQZ 1, 8BKM 1, 8QV 1.

INDIANA—SCM, D. J. Angus, 9CYQ—9AIN runs off with the traffic total for the state again. 9EZ is trailing him close and 9CRV and 9CMV are trying to tie for third place. 9AIN does it with schedules. 9CSC is going to take commercial exam at Chicago. 9CRV is now on xtal control. 9EZ, Culver Military Academy station, works the whole world on 21 and 35.5. 9CMV is using mercury arc on 20, 40, and 80. 9DPJ is an old timer and is selling out. 9LR lost his pole trying to move it. 9AAL, 9AMZ, 9BIA, 9CVX and 9BVI have put in fone on 80 and it is part of the Fort Wayne Radio Club's program to have them report on its operation and whether anyone can understand them. 9AFT is rebuilding. 9EVA is going big on 7 1/2 watts. 9FCX is a new station in the South Bend Dist. 9ASX is on 20, 40, and 80. 9FGD is a small 5 watt portable at the Dodge school at Valparaiso operated by ex-9ARE. 9DBA was shut down most of the month till he earned 20c for his relay contacts. 9CJZ is going to be on 80 soon. 9ESH is a new one at Kishawaka. 9ABP is building a new 3000 volt transformer and will soon be on with 20 watts. The Richmond Amateur Radio Assn. is going strong. 9BZZ is putting in a 50 watter. 9BYI is on 20 all the time now. 9BKJ borrowed 9DPJ's xtal and will be FB on 80 till 9DPJ wants it back. 9DHJ will pound brass on the lakes on board the Alpena beginning this week. 9QS is going from 20 to 80 to get more of the traffic. 9ESH and 9ETJ are two new stations at Rockville. 9DBJ is building a new station.

Traffic: 9AIN 690, 9EZ 446, 9CRV 224, 9FQ 211, 9CMV 209, 9AG 10, 9FGD 6, 9CNC 9, 9DBA 28, 9CLO 28, 9DXH 17, 9CJZ 2, 9EVA 16, 9EKW 57, 9EEY 18, 9EGE 30, 9QS 15, 9DHJ 17, 9CBT 88, 9BKJ 20, 9CSP 5, 9DSC 20, 9APG 16, 9BYI 6, 9BZZ 20, 9AVB 14.

KENTUCKY—SCM, D. A. Downard, 9ARU—9OX leads the traffic totals again this month. 9ATV says "—blew up 2 203As, 2 grid leaks, 4 grid and plate condensers, 1 UX210, lost antenna and mast in recent storm, license expired and can't get a reply to the several letters written to the R.I. but everything else OK." Hi. 9BAZ lost his 250 watter but gets as good results with the old 50. 9AID worked three c's in one night. 9ENR says from his traffic figures he thinks he is in a dead spot. 9BWJ is fooling with self rectification. 9FBU is a new one in Louisville. 9MN has a new 45 foot conductor pipe mast. 9BAN says he gets R7 from the west coast with one 210 bottle. 9EKM reports a new station in Winchester but doesn't give call letters. 9ARU is WRW with work but gets on almost every night.

Traffic: 9OX 138, 9BAN 39, 9BAZ 35, 9ELL 29, 9EKM 25, 9ATV 16, 9MN 10, 9AID 7, 9BWJ 4, 9ARU 2, 9ENR 2.

ILLINOIS—SCM, W. E. Schweitzer, 9AAW—9BSH is keeping a schedule with oh-6CH. 9BTX is handling loads of traffic on 80 meters and is keeping schedules with 9AMA, 9BJL, 8DED and 9BPW. 9BVP is operating on 88 and 75 meters. 9BKB reports traffic coming along fine considering the weather. 9BZO had trouble hearing 9DLL until he discovered that 9DLL was on the dead spot of his receiver.

9CAR is operated by 9BDL, 9AYB and 9DXL who are taking the opportunity to operate while attending the university of Ill. 9CCR is using a TP-TG circuit on 80 meters. 9CCZ is QRMing the 80 meter band with phone. 9CIA is working fo, ef, ei, sb, su and other DX with his 250 watter. 9CEM built a new receiver and is helping another ham get started. 9CKZ and 9AVL report hearing eg-5SH every evening on their 24 meter broadcasts. 9GNB reported another tube gone west and he is now operating on 40 meters with a 201A. 9CNY reports 20 meters working great. 9CUH reports local QRN so bad he can't hear anything but R5 and R9 stations. 9CUO is energizing his tube with a new dynamotor and is operating on 20, 40 and 80 meters. 9CLZ says his MG is going so is using a dynamotor. He reports 9CUO is going after fone work. 9CZT is QRW with school work. 9DAF QSOd with GLY Mar. 8. 9DCK is operating on 20 meters. 9DGA blew his 50 so is using his 210 now. 9DKK says DX is FB with a 204A. 9DOX was keeping schedules with WRCA plane. 9DSC reports DX fair and traffic light. 9DSS is using a 210 with 500 volts on the plate. 9DSU worked oa-5JH with a five watter with 1000 volts on the plate. 9DWP is operating on 40 and 80 meters. 9DXG couldn't keep his schedules because his 203A went west. 9DXZ is keeping 6 schedules and reports everything still going along fine. 9DZT reports traffic picking up and has been advising the hams about the new 250 watt tubes. 9EAI is going to find time to organize an emergency route for the I.C. RR. 9EAJ burned out his 203A so bought a new 852. 9ECR reported for the first time. 9EGX has been sick but had the radio room decorated. 9EHK has had the call 9DJ issued to the Veterans' Hospital at Maywood and wants the gang to listen for it. 9EJO was sick with the grip but hopes to be feeling better soon. 9EPG was also laid up with an abscess in his ear. 9EPX will be moving to Wright City, Mo., about May 1st. 9ERH with a 250 and AC on the plate is pounding out signals to all the continents. 9EYA is reporting for the second time and says his traffic totals are increasing. 9EXH reported his tube went west so he is using a 201A. He is a new station on the air and is hearing lots of DX if not working it. 9FDE is another new station and is using a UX371 with 250 volts on the plate. 9FDJ is a new station using a Hartley circuit. 9FO is operating CC on 39.4 meters. 9GV located on the Edgewater Beach Hotel is being operated mostly in the early morning hours. 9JZ worked oa-3LP. 9KA was off the air all month because of moving. 9KB worked oa-5HG and is working oa's nearly every a.m. 9MI-PU is looking for a summer of real DX with his new 852 and mercury arc rectifier. 9NV was robbed again Feb. 22. 9QD reports things not at a standstill but nearly so. 9RK has spring fever but the 250 is still going strong. 9ZA is operated by Bill Conklin. 9AAW was on consistently mostly in the daytime during the past month. 9ACU was reported R5 from oa's and is now busy with farm work. 9AD is operating his 852 with 1500 DC. He reports two new amateurs. 9FGG and 9FHL operating in Plymouth. 9AEG is rebuilding his receiver. 9AFA is still the contact station with WNP. 9AFB got an R7 from sb-1BC and handled some Calif. flood msgs. 9AFF is using an 852 with an antenna and counterpoise. 9AFX with an MOPA transmitter worked eg-6HP. 9AGG reports his kenotrons took an AWOL. 9AHJ has worked all continents except S. A. 9CSW is on again with a 201A. 9AHK is still handling traffic. 9ALJ is operating on 40 and 80 meters. 9ALK's YL is still QRMing. 9ALZ worked EB and EG stations. 9ELN is going full blast with 2000 volts on his 852. 9DZM taught his OW the code and now when they come in too fast, he calls on her. 9AMA worked NQ and FO-ASV. 9AMN does not raise much traffic. 9AMO is keeping schedules on 83 meters. 9ANQ is now operating on the 20 meter band. 9APY is operating on 40 and 80 meters. 9AQA is keeping schedules with 9CS, 9FQ, 2BVH, etc. 9AQJ is a new station in Rockford. 9ASE worked oh-6DEY and is keeping four schedules. 9AWX and 9AJM are re-organizing the Joliet Radio Club. 9AYB is operating at 9CAR while attending the U. of Ill. 9BHM has been sick. 9RHT was not on much because of business. 9BLL is operating on 20 part of the time. 9BLS has been busy with school work so only open week ends. 9BNI is in the Army net and handled the Springfield end of the Governors Net. 9BRX is planning a new transmitter.

Traffic: 9BTX, 36; 9AQA, 299. 9AMO 280, 9BZO 214, 9DXZ 164, 9BNT 129, 9BXB 123, 9APY 119, 9CZL 105, 9ASE 102, 9BLL 98, 9CTA 86.

9DKK 71, 9CAR 48, 9FO 48, 9CNY 46, 9AFA 45, 9AHK 45, 9CNB 40, 9BSH 35, 9EAJ 38, 9AFB 32, 9AAW 31, 9DGA 30, 9DOX 29, 9CKM 28, 9AD 26, 9MI-PU 23, 9DZT 20, 9EYA 18, 9ERH 18, 9CUG 18, 9CZT 18, 9AQJ 17, 9EJO 17, 9DAF 16, 9AHJ 15, 9GV 14, 9AFZ 14, 9CUG 14, 9ECR 13, 9DSS 12, 9EPX 12, 9ANQ 12, 9AWX 12, 9AFV 11, 9ACU 11, 9ALK 10, 9BHT 10, 9BVP 10, 9KB 9, 9ARM 9, 9QD 8, 9AMN 8, 9BLS 7, 9DSU 7, 9EAI 7, 9EFG 6, 9BHM 6, 9RK 6, 9ZA 6, 9DCK 5, 9AGG 5, 9EGX 5, 9DXG 4, 9AEG 4, 9DSO 4, 9ALZ 3, 9CKZ 3, 9CCZ 3, 9IZ 3, 9NV 3, 9ALJ 3, 9EHK 2.

WISCONSIN—SCM, C. N. Crapo, 9VD — 9DLLD leads again with the largest total he has ever reported. 9EK are still busy with their airplane transmitters and receivers. 9DTK has two wave meters on hand—each one tuned to one of his transmitting waves. 9BPW is holding down four schedules on 80. 9EBO originates a flock every month but can't seem to get QSRs. 9ABM has schedules on both 40 and 80. 9DLLD reports good traffic and DX. 9SO is keeping three skeds and collects his share of traffic. 9DEK has a second hand Ford which accounts for the drop in t/c. 9DND says his station is putting out a decent signal and expects to boost his totals. 9EMD is keeping schedules with 9DLD, 9DEK and 9ASK. 9CDT took an unexpected drop but won't let it happen again. 9EEF gets a few messages occasionally on 42 meters. 9LV is still having trouble with the BCIs but hopes to eliminate it by getting down to 20 meters. 9AZN gives us a small total and is too busy to spend much time on the air. 9BWO is out for DX and naturally his msg totals have to suffer. 9AZY will be on the lakes all summer. 9FHS is building a new Aero Coil transmitter. 9EGW doesn't get much time to muss up the ether. 9BQQ is a new station at Argyle using 4 201As. 9BIB just bumps along merrily and plays with an RF amplifier. 9EBT says he picks up a few stray msgs. that wander up into the wilderness. 9EVE squeezes through a few messages between broadcasts. 9CVI is getting so he attends nearly all the club meetings now. 9EFC works both coasts with 2 201As on 20. 9ELD splits his traffic between his home and the Journal station. 9CFT has a little time for traffic but is very busy. 9AFZ was only on the air Sundays last month. 9BWZ had to cancel all his schedules. 9EYU worked WNP for 30 mins. and o-z-1FE.

Traffic: 9DLLD 473, 9EK 250, 9DTK 248, 9BPW 183, 9EBO 170, 9ABM 125, 9DLQ 118, 9SO 107, 9DEK 86, 9EMD 53, 9DND 52, 9CDT 25, 9EEF 24, 9LV 19, 9AZN 19, 9BWO 19, 9AZY 17, 9FHS 14, 9BQC 12, 9BIB 10, 9EVE 7, 9EBT 7, 9CVI 5, 9CFT 5, 9EFC 5, 9DCT 5, 9ELD 4, 9AFZ 3, 9BWZ 2, 9EYU 2, 9CJU 7.

MICHIGAN—SCM, Dallas Wise, 8CEP—8DED has the best record of any Michigan station and has a fine bunch of schedules. 9EAY reports the QRM getting bad up his way. 9AYR still works his daily sked with 8KJ. 8DKX says he just had the 20 meter fone working good when the ban came. 8AMS is re-building the set into a tuned plate—tuned grid outfit. 8AJL has been getting out well with the low power set. 8AHM is putting out a good signal on 40 with his 210. 8DJR is having trouble getting a good antenna system. 8AUB has been doing some testing with portable xmitter on moving autos. 9CSI now has the crystal working on 41.6. 8CJ is QRW with school work. 8RE has been on the sick list so hasn't been able to do much. 8KN now has two ops. 8CAT has good luck on 20 but blew his plate transformer. 8CU has been doing some fine low power work. 8DSF says he finds it hard to keep schedules. 8DIV will be out of the game for a few weeks. 8CKZ has been on quite regularly. 8AAF has been busy getting two new hams in the game. 8ZH has been QRW. 8DAQ is going to move and won't be back until next fall. 8ZF has the message box at the school keeping the four ops busy. 8CM has moved and is just getting the outfit in shape again. 8CYM is going to Detroit. 9CE is on regularly but says the DX tests reduced his traffic. 8ASO was QSO WNP and is now working 20 meters. 9BTQ has QRM from the YLs. 8CHT reported early on account of spring vacation. 8BS was silent most of the time due to the death of his brother, 8CYT and to his own illness.

Traffic: 9EAY 11, 9AYR 8, 8DKX 31, 8AJL 30, 8AHM 5, 8DJR 12, 8AUB 100, 9CSI 51, 8CJ 8, 8KN 1, 8CAT 3, 8CU 28, 8DSF 32, 8DIV 2, 8BRS 14, 8CKZ 3, 8AAF 25, 8DAQ 250, 9CEX 7, 8ZF 204, 9CM

4, 8CYM 27, 9CE 30, 8ZZ 16, 8CHT 23, 8ASO 14, 8EVQ 5, 8CEP 39, 8DED 1154.

DAKOTA DIVISION

SOUTHERN MINNESOTA—SCM, D. F. Cottam, 9BYA—9COS is on both 40 and 80 for fun. 9BN is keeping 6 skeds on 80 and with three ops is doing some very nice work. 9EFK is still doing his spectacular DX work and keeps a number of skeds. 9BTW is shoving 50 watts into a 310 and works oa. 9BKX keeps two skeds and will be on 80 most of the time except Sundays. 9XI is going once more and they will have xtal control soon. 9ELA says ND on the DX. 9EFO handled some important traffic from Washington to San Salvador and keeps on sked. 9BHZ may not be on for a time, spring weather gets his attention. 9DHP is mourning the loss of his new 852. 9DBW has enjoyed visits from 9DHP and 9CRW. 9DOP is changing location of his station. 9ERT is on with three good ops. 9AIR handled one business message that amounted to real money. 9GH is not on very much, too QRW. 9EYL, a new station here, is getting a nice start and hopes to be a real traffic station. 9DMA gets reports of R7 from Europe. 9DBC is at the A. T. and T. Co. school at Waukegan, Ill. 9DEQ has another fellow interested in ham work so we may have another station soon. 9DZA would like to hear from hams troubled with shifting to 20, also those trying 10 meters.

Traffic: 9COS 255, 9BN 168, 9EFK 65, 9BTW 55, 9BKX 23, 9XI 26, 9ELA 23, 9EYL 21, 9BHZ 20, 9DHP 10, 9DBW 10, 9DOP 9, 9ERT 8, 9AIR 8, 9GH 3, 9EYL 2, 9DMA 2, 9DBC 1.

NORTH DAKOTA—SCM, H. L. Sheets, 9DM—9EFN was forced to give up the SCM duties on account of illness and will not be on very much from now on. 9DM will carry out his duties. 9BJV has been doing some fone work but has decided to go back to 40 and 80. 9BRA is getting out consistently with his Colpitts layout. 9CDO is preparing for spring work and is not on much. 9BVF has been hitting the ball. 9CUT is QRW school work but expects to be on more as soon as the work eases up. 9DYA has been fooling with a fone on 180 for local work. 9DM has been off the air for about 2 weeks due to heavy school work. 9DYV put up a Zepp and manages to kick out. 9FCA at Aneta, 9IK, 9AQB and 9DXE have been reported to the SCM. That's the spirit, gang, let's have some more. The SCM thanks you fellows who responded to his letters so willingly.

Traffic: 9CUT 3, 9DYV 4, 9DYA 12, 9DM 23, 9BRR 62, 9BVF 141.

SOUTH DAKOTA—SCM, F. J. Beck, 9DB—9DIY has a fine 222 K.F. amplifier. 9AGL built a new receiver and received an A-A certificate. 9BOT is having farm QRM. 9DB changed from CC to TGTP circuit. 9BKB has a new 50 water and a new xmitter which works DX FB. He reports the Rapid City Radio Club's station is going FB. 9DNS and 9DES put over a quick QSR on Army-Amateur test messages. 9AJP's pet power leak took a rest. 9EUIH keeps a bunch of skeds. 9DES put in a big msg report without any skeds. HI. 9BOW-9BRI keeps a weekly sked with na-7MN on 20. 9ADQ worked gi-A8 and has applied for an ORS. 9DGR's new 852 works FB. 9DWN keeps an A-A sked with 9APV and says he is busy with skeds and YLs.

Traffic: 9DWN 139, 9DGR 129, 9ADQ 129, 9BOW 112, 9DES 81, 9EUIH 78, 9AJP 48, 9DNS 46, 9BKB 33, 9DB 32, 9BOT 4, 9AGL 4.

NORTHERN MINNESOTA—SCM, C. L. Barker, 9EGU—9ABV finally reached the BPL and leads the Section. 9EGF comes in second. 9AOK rates third place. 9EHO does not give any news to include in these reports. 9BAY is still doing Army-Amateur work. 9CWN works on 20 meters almost entirely and likes it better all the time. He assisted 9EGU in getting his crystal set going. 9KV is on 10 meters every Sunday. He says that 9BJD has cured the girlshyness with "KV" has been noted for. HI. 9DPB did some two-way 10 meter work with 6UF. 9GZ has started reporting again. 9EHL, a new ORS prospect, works on 20, 40 and 80 meters regularly. 9BRP is on again and sends in reports after 9EGF hounded him enough about it. 9CF reports bad QRM on 40. 9FDK is a new station working on the 40 meter band. 9BIW works on 20 all the time. 9BBT has been very busy with the seed business. 9CWA is still QRW with

9CIY. 9CTW celebrated the second anniversary of his station by QSOing on—his first on QSO. 9ADS perks right along with the rest. 9QT has been somewhat inactive, nearly all the traffic being handled through 9BAY. 9AKM says 20 and 80 are FB. 9BMX is also on 10 meters some in addition to his regular 20 meter wave. 9BMR is getting ready for an 852 soon. 9BVH is on 10.06 meters Saturdays and Sundays. 9DUV is still chasing around as relief operator. 9CIY says he will have to be put on inactive list for the summer. 9BJD also has to go on inactive list till fall. 9EGU has his QTX set ready, using a 210, cc, 203A frequency doubler, and 852 output tube.

Traffic: 9ABV 212, 9EGE 122, 9AOK 93, 9EHO 51, 9BAY 47, 9CWN 86, 9KV 31, 9DPB 29, 9GZ 27, 9EHI 25, 9BRP 18, 9CF 15, 9FDK 12, 9BIW 11, 9BBT 11, 2.

DELTA DIVISION

TENNESSEE—SCM, L. K. Rush, 4KM—This section is showing more actively at present than ever before. More good reports are coming in and it sure is good to see you fellows taking an interest. 4SP is laboring with xtal control and hopes to make it work. The Knoxville Radio Club is right on the job with many active members. 4ABZ is a new ORS and can shove over the traffic. 4FX reports thru 4SP. 4GL and most all the other stations in Knoxville have installed two line voltage feed Hertz antennas. 4HK is seeking that much desired 360 cycle note and is looking for a 6 phase mercury arc rectifier. 4ADI is rebuilding. 4ABR sends in an interesting letter and dope. 4LX still seeks elusive DX and traffic and gets it. 4KM lost 2nd op 4KX—he just dropped out of sight.

Traffic: 4ABZ 40, 4ABR 17, 4LX 14, 4SP 9, 4FX 8, 4ADI 2.

MISSISSIPPI—SCM, J. W. Gullett, 5AKP—5API is using phone altogether now on 175 meters. 5AYB says that he has been very busy trying to make a living this month. 5AGS has put in a chemical rectifier and it helps some. 5FQ gets mobs of good RAC reports although he is using raw AC. 5ANP reports that he has been off the air most of the month on account of sickness in his family. 5AJJ says that QRN has been terrible on the coast this month. 5AKP continues to work foreigners on 20 meters.

Traffic: 5AKP 80, 5AYB 32, 5FQ 20, 5API 14, 5ANP 6, 5AJJ 6, 5AGS 4.

ARKANSAS—SCM, W. L. Clippard, 5AIP—5ABI continues to lead the list. 5AQX is very active in Hot Springs and sends in his first report this month. FB. 5EP is back with us and 5ABD is on the air once more. 5AW moved again so will be inactive for a while. 5AUI quit radio and took up motion picture taking. 5ANN has a new 20 meter antenna and raised it up and down for night and day work. 5ER and 5AIP are getting ready to ship next June.

Traffic: 5ABI 50, 5CK 8, 5AQX 8, 5SS 6, 5JK 1.

LOUISIANA—SCM, C. A. Freitag, 5UK—5RD seems to be having a hard time establishing a QSO. 5PM was reported heard by 5PK off the coast of China and is now sending press to 5PK each night. 5NS has again changed his circuit to modified Colpitt's and reports better results. 5ANC reports 5KH and 5APA back in Shreveport. 5IE has been sick most of the month. 5HR still does fone work and says high frequency does not interest him very much. 5AAV, 5QJ, and 5UK in addition to working on short waves are also doing some fone work on the 150 meter band.

Traffic: 5PM 12, 5EB 10, 5LV 6, 5NS 5, 5ANC 4, 5UK 5.

HUDSON DIVISION

NEW YORK CITY & LONG ISLAND—Acting SCM, J. B. Kilpatrick, 2EV—Manhattan: 2BCB has been working nites. 2BOX is using a 204A now. 2KR has xtal going on 20, 40 and 80 meters now. 2OV has had consistent QSO with Portugal. 2BLA (ex8CZE) had some QRM with BLC and now uses a 50 watt. Bronx: 2AET is a new ORS and is jarring the ether with his new Vibplex. 2AHG's transformer went to sleep. 2ALP has

been on 10 meters. 2BAD is going strong on 20 meters now. 2BBX's low power fone on 20 meters has been QSO all USA and several foreign countries. 2CYX is back from Porto Rico now. 2JA is now on 10, 20, 40 and 80 meters.

Brooklyn: 2ABP had lots of hard luck with set and BCL and says he is on 80 meters from now on. 2ADZ has a 2nd op while he is away. 2AND is active in Army Net. 2ASB ex8BDG sends in first report. 2ATZ has been handling traffic for GMD. 2AVR is experimenting with low power portable. 2BAZ has had consistent QSO with DCZ. 2BDM is a new ORS and is QRV traffic. 2BRB is engaged to the YL now but is still experimenting with fone on 85 and 175 meters. 2CCD has been QRW with Law exams. 2CRB handled some important traffic with ns-1FMH. 2PF is building Airplane receiver for experimental tests. 2WC is going FB with xtal sets. 2WZ is using a 204A now and is QRW at 3AOC.

Long Island: 2AIZ is on 80 meters every night from 6 to 8. 2ALS is active in Army Net. 2AYS is working a Zepp antenna FB now. 2TY is waiting for his WAC certificate now.

Staten Island: 2ABO is a new ORS and is working fone FB now. 2AFV is going to sea and has resigned as RM for Staten Island. 2CPG the station of the Staten Island Radio Club is on 80 meters on Sun. and Fri. nights.

Traffic: Manhattan: 2BCB 26, 2BCU 5, 2BDJ 7, 2BOX 47, 2EV 54, 2KR 23, 2OV 5, Bronx: 2AET 8, 2AHG 11, 2ALP 135, 2AWU 33, 2BAD 57, 2BBX 35, 2CYX 118, 2JA 9, Brooklyn: 2ABP 19, 2ADZ 4, 2AND 26, 2APD 2, 2ASB 12, 2ATZ 21, 2AVR 110, 2BAZ 20, 2BDM 41, 2BRB 4, 2CCD 24, 2CRB 21, 2CTY 18, 2PF 28, 2WC 10, 2WZ 32. Long Island: 2AIZ 59, 2ALS 16, 2AYS 6, 2TY 63. Staten Island: 2ABO 42, 2AFV 20, 2CPG 13.

NORTHERN NEW JERSEY—SCM, A. G. Wester, 2WR—The ORS of 2BLM has been cancelled. 2BDF is a new ORS. 2AT, 2CP, 2MD, 2ADL and 2AOP make the BPL. All traffic is being handled on 80 meters. 2AT collected all traffic thru working schedules. 2CP has just lost his father. 2CW is too QRW with business to get on the air. 2WR is stepping out in all directions. 2DX is another having hard time getting on the air. 2EY is back on the air after the arrival of long-due licenses. 2JC is installing new MOPA transmitter. 2FC is out of work so has plenty of time to operate. 2KA was QSO a yacht KDWU off Miami, Fla. 2ASZ has a new transformer which puts him back on the air. 2CJD is bothered with YL QRM. 2BW has the misfortune of cracking three crystals. 2IE is learning to be an aviator. 2JG has a fine signal on 80 meters with good pep. 2AGN is disgusted with a chemical rectifier and is installing a mercury arc. 2ALI also is installing a mercury arc. 2MD is increasing power to 250 watts crystal controlled. 2CTQ has the misfortune of blowing up an 852. 2CJX expects to drop to 10 meters for experimental work. 2BY had receiver trouble which knocked out all her schedules. 2GV has installed a new mast and will be heard very shortly. 2BIR is the proud possessor of a WAC certificate. 2IS has just installed a new MG which will help him get on again. 2AVK is having fine QSO with all European countries. 2ADL is on another trip to the South. 2JX's oscillator works but has a hard time raising any stations. 2AOP works our RM every night on schedules which enabled him to make the BPL. 2BDF has had fine QSO with foreigners. 2ABE is still having trouble with the antenna coming down.

Traffic: 2WR 1, 2AT 192, 2CP 314, 2CW 8, 2DX 6, 2JC 4, 2FC 15, 2KA 2, 2ASZ 21, 2CJD 11, 2JG 17, 2AGN 9, 2MD 111, 2CTQ 1, 2CJX 28, 2BY 7, 2BIR 2, 2AVK 4, 2ADL 119, 2JX 1, 2AOP 215, 2BW 44, 2BDF 15, 2ATE 16.

MIDWEST DIVISION

NEBRASKA—SCM, C. B. Diehl, 9BYG—9CJT tinkers with 20 meters. 9ANZ can't find any traffic these days. 9QY is QRW planting his crops. 9EEW doesn't say a word. 9DFR has a new fifty and expects to bust some Chinaman's ears. 9DI is still away at school. 9BOQ is also planting his crops. 9CHB has been laid up with the flu but is improving now. 9DUH is experimenting with shielded grid tubes. 9BBS missed a tornado by inches the other day. 9CDB has a lot of work piled up and

can't find time to pound his key. 9EGJ has increased his power a bit and expects to go from here. 9CJI works overtime at the office but still finds time to radio some. 9DVR turns in high score this time and also applies for ORS. 9BYG is tinkering with xtal and expects to be on with it soon. 9AWS fell flat again this time.

Traffic: 9ANZ 26, 9QY 8, 9EEW 26, 9DFR 2, 9BYG 2, 9DI 2, 9BOQ 7, 9CHB 5, 9BBS 4, 9EGJ 22, 9CJI 43, 9DVR 76.

KANSAS—SCM, F. S. McKeever, 9DNG—Beginning now all ORS in Kansas must average at least ten messages per month. This is easily done, fellows. You can originate ten messages. The SCM put one over on the gang by winning the traffic contest with 468 messages. 9HL took second place and 9CFN third. 9CFN and 9HL have a swab of skeds. 9BGX with sick for a week. 8CKV, 9BPL and 9DNG—other side of Africa. 9DIH and 9CET were on with 9BPL worked So. Georgia Is. Which is on the other side of Africa. 9DIH and 9CET were on with low power this month. 9CCS is away at college and 3 YLs keep nightly skeds with him. 9CV and 9BHR are asleep it seems. 9CFW is putting in Rectobulbs. 9BII is in love with his new 852. 9BUY was among those with YLitis. 9LN is keeping a sked with oa-7LJ. Will all ORS send schedule dope to RM. 9BGX as soon as you can?

Traffic: 9DNG 207, 9CFN 170, 9BGX 122, 9HL 94, 9BHR 47, 9CKV 84, 9CFW 22, 9CXW 21, 9DIH 20, 9BII 16, 9BUY 13, 9CV 23, 9BPL 11, 9CET 9, 9LN 9BEM 8, 9COR 7, 9CPY 1.

IOWA—SCM, A. W. Kruse, 9BKV—9EJY and 9DZW kept a daily schedule beginning Nov. 26 and ending Mar. 26 and only missed once. 9BKV and 9CZC have made the BPL for six consecutive months and claim most traffic handled in Iowa during the winter season. 9PB has a new 50 watter perking in fine style. 9BBU rolled up a large total for the BPL. 9CS also made the BPL. 9CUX has a new receiver and is rebuilding his transmitter for 20. 9DRA is op at KWCR. 9CGY is pounding away on 40 and 80 and wants schedules 9BCA has lots of trouble with the BCLs. 9EHN has a modulated DC note that sounds good. 9EDW is an announcer at KWCR but it doesn't keep him from pounding the key. 9BWN is QRW with college. 9EHR works for the state highway commission. 9DEA has an awful wallop on 80. Illness and studies kept 9FTV off the air most of the month. 9EIW complains of the QRN. 9BAT will be going strong soon. 9CPI, 9DPL, and 9AYH keep plugging away.

Traffic: 9EJY 339, 9DZW 328, 9BKV 327, 9CZC 276, 9PB 255, 9BBU 231, 9CS 207, 9CUX 201, 9DRA 179, 9CGY 157, 9CA 141, 9EHN 127, 9EDW 93, 9RWN 78, 9EHR 67, 9DEA 58, 9EIV 52, 9EIW 31, 9BAT 13, 9CPI 6, 9DPL 4, 9AYH 1.

MISSOURI—SCM, L. B. Lazure, 9RR—9BEO. 9DUD, 9DOE, 9ZK and 9BEU were leading traffic handlers this month in St. Louis. 9BMU and 9AEX applied for ORS. 9AAO was appointed OBS. 9ZK visited in K.C. last of the month but unfortunately missed connections with most of the gang. 9DOE returned to commercial duty on WNX on the lakes and expects to be aboard by April 15th. 9BEU worked plenty of DX on 40, also kept skeds with 2CNS. 9DLB and 9DAE had to OSO skeds due to QRN. 9DUD kept sked with 4ADQ. 9DZN reports QRW with school and trying 10 meters. 9EUA sends his first report. 9FBO also is a first time reporter. 9ZK reports local OBP club giving ham talks weekly thru KMOX Sat. at 3 pm. 9DKG had a fine traffic month and excellent skeds with 9ENU. 9LI had too much school QRW to handle traffic. 9BQS says too busy with post office to be on much. 9LJ kept several skeds comprising 16 stations for relaying scores of national AAU basket ball tournament from Kansas City. 9DMT had his hours of employment changed and expects to do more hamming during April. 9CRM had a good month but QRN bothered continually. 9ARA put in two Rectobulbs and says they are great. 9CCQ had to QRT due to spring farm work. 9CDF kept daily skeds with 9ERR, operated by his father as per last month's report. 9ASV reports traffic good and three new stations, 9FCO, 9FEQ and 9FDA coming in on Joplin. 9EUB boosted his traffic total this month. 9FBF kept sked on 178 with 9ERX and had a write-up in *St. Louis Globe Democrat*. 9AJW and 9ERM got a good total from their 210 set at Fulton keeping two skeds. 9DQN hit his stride this month handling 143 messages. 9ACA is getting set for some

traffic. 9WV was on often and handled some traffic. 9AHZ and 9EMH handled traffic after testing QRW was over. 9RR had a fair month but QRN was a serious hindrance. 9ZK was out of town often which did not help his total any. 9DOJ was out of the city at report time hence no report. 9ENU and 9LD continued experimenting at 9FAU when possible. The SCM urgently requests all new stations to drop him a card with their correct QRA and reporting forms and instructions will be sent them.

Traffic: 9BEQ 89, 9BEU 31, 9BMU 14, 9DLB 10, 9DOE 49, 9DUD 60, 9ZK 42, 9EUA 5, 9DKG 141, 9DAE 166, 9LI 6, 9LJ 11, 9DMT 7, 9CRM 32, 9CDF 12, 9ASV 18, 9EUB 25, 9FBF 7, 9AJW-ERM 110, 9DQN 143, 9RR 151, 9ZD 5, 9WY 4, 9AHZ 4, 9EMH 4, 9DOJ 10, 9ENU 158.

NEW ENGLAND DIVISION

MAINE—SCM, Fred Best, 1BIG—A newcomer, 1BAY, of Portland, leads the list this time with a fine total. 1AYJ reports some very good work on the 20-meter band. 1AIT reports very poor conditions on 80 meters most of the month. 1ANH is being issued an ORS, which he has worked hard for and which he deserves. 1CDX still works his daily schedule with 1AWQ altho he was off for two weeks on account of burned-out field winding in his motor-generator. 1BFZ has been sojourning on 20 meters. 1ACV sends in a mighty fine report on conditions in his neck of the woods. Active stations in Houlton reported by 1ACV are 1BBE, 1BHA, 1AIE and 1CZ. 1AQL reports lots of new blood coming into the Queen City Radio Club. 1AUR worked Morocco. The SCM has just received a couple of cards from old 1BNL, formerly of Saco, but now of Brooklyn, N. Y. saying that he was married last November and that single life holds nothing more for him. Hi. 1HB sold everything on hand and is buying himself a new fifty watt outfit. 1KL is QRD Galapagos in the southern Pacific to be gone until June. 1ATV sends him the dope every Tues. Thurs. and Sunday. 1BIG is very much interested in the formation of at least three USNR Units in Maine to match the three already started in N. H. 1AJC reports an over-abundance of BCL interference. 1BUB reports another junior operator. Congrats, OM. 1COM has been getting out to eg, ef, ek and eb in fine style.

Traffic: 1BIG 210, 1BAY 166, 1AYJ 63, 1AIT 24, 1ANH 19, 1CDX 18, 1BFZ 16, 1ACV 14, 1AQL 10, 1AUR 8, 1AJC 44, 1BUB 28, 1COM 42.

NEW HAMPSHIRE—SCM, V. W. Hodge, 1ATJ—Our efficient RM, 1IP, leads this month. 1BFT reports a bunch of ops at NHU. 1AOQ handled his share thru had QRW from school. 1AEF is doing good DX and traffic with his 210. 1ANK is back on the air in Hampton. 1JN is QRV traffic at 9 pm daily. 1AVJ is trying for WAC and needs just S. America. 1ASR was QSO the Marines in Nicaragua. 1ANS reported his traffic but no news. A report was received from 1AFD. 1ATP who is op on the C. G. Cutter "Tuscarora" was the boy who answered the SOS from the *Robert E. Lee*, FR. OM. Some of the gang are getting Spring Fever and cancelling their schedules but most of the fellows will be on a few nights each week. The Jr. op at 1ATJ sends 73 to the gang.

Traffic: 1IP 166, 1BFT 127, 1ATJ 136, 1AOQ 78, 1AEF 70, 1ANK 19, 1ASR 17, 1JN 17, 1ANS 32.

VERMONT—SCM, C. T. Kerr, 1AJG—Is anyone to head off 1IT? He won a set of REL coils as they were donated by an interested OM for the station that handled the most msgs for February. 1BCK sure is getting out FB. 1AJG has his xmitter panel mounted and is QSO fone some. 1BJP is building over power supply to have MG, RAC, AC, DC. Hi. 1BEB is our NCS of Montpelier and sure doing the AA work to perfection. 1A00, a new ORS, reports on 20, 40 and 80. 1EZ is going to apply for an ORS. 1NH is using a 201A and is QSO 9s on fone. 1ATU is going to have more power. 1BD got his OWLS appointment and got a new 210. 1AD sure has a real fist and station. Listen for the SCM, 1AJG every Wed. night at 7 pm QST for Vt. hams.

Traffic: 1IT 239, 1BCK 91, 1AJG 65, 1BJP 47, 1BEB 43, 1A00 36, 1YD 30, 1EZ 9, 1ATU 7, 1BD 1, 1NH 2.

RHODE ISLAND—SCM, D. B. Fancher, 1BVB—Hereafter, all hams calling on 1BVB will find him located at 9½ Hobart St. instead of 22 Summer. 1MO says things haven't been so good with him this month. 1BAT hands us a good total. 1BIL is using a new UX250. 1AWE is still working the old DX. Hi. 1BDQ says FB on 40. 1AQP has been busy building a new transmitter. 1AAL is another with a dandy total. 1CKB hasn't had much time for radio this month. 1BVB started out OK but moving spoilt everything. 1BQD and 1BLS are the two star stations this month.

Traffic: 1BLS 236, 1BQD 273, 1BIL 91, 1BAT 82, 1AAL 67, 1BVB 44, 1AWE 15, 1AQP 11, 1MO 11, 1BDQ 9, 1CKB 1.

CONNECTICUT—SCM, H. E. Nichols, 1BM—1MK had a fine showing for the first month of operation with their new set. 1MY did a nice little piece of message delivery recently for an ex. 1CKP has finally come up to 80 meters. 1BNS made the BPL with his first report as an ORS. 1CTT's totals have suffered due to sickness of some of his star stations. 1VE, 1IM and 1BJK have been doing quite a little Army-Amateur work and report things fairly active in this line. 1AMG-1AUK handled some QRR traffic recently and was commended by the railroad folks for his service. 1AFB reports a QSO with a ship off the coast of China recently on 20 meters at 4 pm. 1ZL worked nc5AW at Whitehorse, Yukon thereby having worked every Canadian district. 1IV has made a new transmitter with Aero coils and a 210. 1BQH has received new call letters for his station at Boston and is all ready for traffic. See you at the N. E. Div. Convention, OMS.

Traffic: 1CKP 2, 1BLF 4, 1IV 4, 1OS 6, 1BWM 11, 1BQH 13, 1AMC 12, 1BGC 13, 1TD 23, 1ZL 25, 1IM 27, 1ASD 31, 1AMG 31, 1MY 47, 1AFB 52, 1BJK 55, 1PE 96, 1VB 108, 1ATG 108, 1ADW 112, 1VE 123, 1CTT 139, 1BNS 230, 1MK 477, 1VP 16.

EASTERN MASSACHUSETTS—SCM, E. L. Battey, 1UE—1NQ and 1AVY's ORS have been cancelled due to various reasons. 1CMZ is a new ORS. 1AKS, 1LM, 1CRA, 1KY and 1WV made the BPL. 1KY is doing nice work as RM. 1UE has been rebuilding. 1AGS is troubled with a mysterious power leak. 1ABA says not much doing after tests. 1BZQ is working nights so has only wee small hours for radio. 1ASI is working out a new with ORS in every state in N. E. DX is reported good on 80 by 1NV. 1NK handled a couple of death messages enabling the party to get to Boston in time for the funeral. 1ACH has been very busy with convention plans and Naval Reserve work. 1CRA has the measles. The new fone regulations enable 1APK and some of the other local boys to use fone again on 80. 1RY wants dope on key-click eliminator. "DM" of 1FL is now working at Headquarters in Hartford and except for intermittent operation by "DH". 1FL will be off the air until a new location in Hartford is secured. Navy traffic is helping 1LM's totals muchly. 1PB expects to be on more very shortly but he has not been at home. 1BMS is on again. A new car has made much YL QRM for 1AKS. Hi. 1CMZ will accept traffic for west coast for QSR same night as received. 1GP, 1RF and 1BDV are kept QRW with their lessons at school. 1BKV is busy repairing BCL receivers. 1WV made the BPL and worked a wonderful bunch of DX all in the same month. 1IF is starting up permanently with a fifty watter after five months of none too consistent operation. 1KH took a trip out west to Kansas City and Dallas and visited 9AHZ, 5RG, 5JX, 5AQ, 5AKN and 5JD en route.

Traffic: 1AKS 221, 1FL 396, 1LM 175, 1CRA 144, 1KY 101, 1WV 151, 1RY 86, 1ACH 63, 1CMZ 50, 1YC 37, 1AAW 30, 1ABA 28, 1AGS 26, 1UE 26, 1BMS 24, 1BZQ 21, 1ASI 18, 1NK 9, 1NV 9, 1APK 7, 1GP 4, 1KH 14, 1PB 15.

WESTERN MASSACHUSETTS—SCM, A. H. Carr, 1DH—1AAC is rebuilding his UX210 outfit again. 1AKZ QSO'd es-2NX and surprised him by speaking in his native tongue. 1ANZ will be on the air during his next vacation. 1ANI has kept a fine lot of schedules. 1APL says ham activity in Springfield is on a rapid increase. 1OH, 1CRG, 1KY, 1ACH and 1CRB visited him recently. 1AWW is on the air Sun. mornings. 1AZD has been keeping schedule with WNP. 1BKQ says that 1AOF paid them a visit and showed a fine new shielded receiver using new screen grid tube. 1BVR did a lot of DX work on his last

vacation. 1WQ is using a mercury arc rectifier. 1BVB have completed their 50 watt xmitter. 1BGM sends in a good report for a non-ORS.

Traffic: 1AAC 4, 1AKZ 10, 1ANI 101, 1APL 145, 1AWW 19, 1AZD 76, 1BIV 2, 1BKQ 11, 1BVR 1, 1EO 8, 1UM 5, 1WQ 25, 1BWW 8, 1BGM 18.

NORTHWESTERN DIVISION

OREGON—SCM, R. H. Wright, 7PP—7AKK makes the BPL this month, by 24 hour operation. 7AEC is out of commission on account of illness. 7AJR, the Ore. State College, uses 250 w. TGTP on 40 and Hartley on 80. 7PE is on occasionally as he is QRW with work. 7GQ owns a Ford now, hence more detraction from ham work. 7AHS is QRW but says that as soon as his junior op grows up, we will hear some real operating. 7AIX has returned to 40 with a 40 meter Hertz. 7ABH handled traffic for the Wilkins Expedition. 7PL is rebuilding for higher power. 7IQ has changed his QRA and is putting up a gutter pipe antenna. 7UN is a new ORS and a promising traffic station.

Traffic: 7AKK 214, 7AEC 145, 7FU 50, 7MH 45, 7WB 36, 7PE 29, 7EO 24, 7AHS 23, 7GQ 9, 7ACG 8, 7ABH 2, 7PL 2, 7AJR 264, 7UN 26.

MONTANA—SCM, O. W. Viers, 7AAT-QT—7HP kept his promise and sent in a report that made the SCM's eyes twinkle. 7HT who was appointed ORS the same time as 7HP, also turned in a dandy report for such a new ORS. 7EL pounds through five on 41.5 meters and gets a dandy ICW note from his dynamotor. 7FL says, "Spring is here and the junk is about due for the annual cleaning." 7ZU has been very QRW teaching college but he's going to surprise us some day with some real ham work. 7DD says his 50 watt crystal set receives R7-3 from OH, and the ¼ kw. only gets R3! 7AEP is very busy with his new electric shop but is making good. 7AHG used all his radio batteries in his fiver so now the station is one of the battery-less type. 7AAT-QT has lost a lot of hours due to bad receiving conditions. 7AAW has been in the hospital but is improving now. FB! The following stations are ORS: 7AJU, 7EL, 7ZU, 7FL, 7AFM, 7AAW, 7DD, 7HP, 7HT and 7AAT-QT. The OBS are 7FL, 7DD, 7AAW, 7AFM, 7HP and 7AAT-QT.

Traffic: 7HP 63, 7HT 60, 7AAT 41, 7DD 22, 7EL 7, 7FL 4.

WASHINGTON—SCM, Otto Johnson, 7FD—7DF has sold out and will be off the air because he's married. Seattle was favored by visits from 7VL and 7BM who are the newly appointed RMs for eastern and southeastern Wash. Circular letters are being sent out to all relay stations relative to the ORS, RM, SCM organizations and it is hoped that Wash. will once more take her place in the sun. All amateurs desiring schedules are invited to write 7VL, 7BM or 7FD and we'll attempt to line up good routes for you.

Traffic: 7DF 113, 7BB 84, 7QG 49, 7ACB 44, 7AEE 40, 7ACA 40, 7MX 29, 7LZ 26, 7ACS 18, 7BM 14, 7MP 9, 7NO 6, 7AFQ 4, 7VL 2, 7GW 8, 7FD 2, 7TX 2.

PACIFIC DIVISION

EAST BAY SECTION—SCM, J. Walter Frates, 6CZR—Due to discrepancies in the records, all OOS, OBS and RMS have been cancelled. 6IP has been appointed chief RM and is hard at work on schedules. Other RM appointments for various parts of the section will be announced shortly. 6CGM makes the BPL this month. 6RJ says the MOPA is FB and reports working GFAD, NIJN, WNP, op-1AD. 6ALX did wonderful work at 6AUT by taking the SOS messages from the Santa Paula flood disaster for the Red Cross in San Francisco. 6BB is knocking off the Chinese stations. 6BSB is playing with 10 meters. 6AMI has a new UX352 after selling his MG to 6AZU. 6BER is on every evening and hopes to become a competitor for the 5 watter next month. 6COL is working co-BAM and sa-FC6 on 40 and 20 meters. 6OT has been moved from the Hotel Leamington to old QRA at 1551 Alice St. 6SR reports the leak-in bow leak during a heavy rain and receive floated. 6CLZ on 20 meters keeps na-7AER in touch with relatives at home. 6BUX has an H tube

on 20 meters now. 6EY expects to depend on 80 for plenty of traffic work in future as too much QRM on 40 now. 6IT, reappointed an OO, has the main requisites of his work, a good receiver and wavemeter. Hi. 6CMG reports himself QRW with studies in college. 6ZX is making his 15 watts do trans-Pacific flights every am to op, aj and ac. 6BPC is off the air for a couple of weeks after strenuous work on International Tests. 6CKC is QRW with 1928 Pacific Div. convention work since his election as convention manager. 6RJ is devoting his time to the entertainment end of things. 6WW, is in the process of being rebuilt for extensive traffic work. 6CZR will be on with 50 watts, soon. 6ROY back from oa as op on the Sonoma. 6APA has moved to Marin County. 6DDA is back after a cruise on WKJ and reports the Pacific Ocean off Canal Zone great for listening. 6AYC is back on again and ready for OWLS work with 6BFU as second op. 6ALV reports DX R zero and power leak R12 in Alameda. 6DTM is a new ORS who has a sked with oh. 6BZU at Concord has a sked with Ukiah.

Traffic: 6CGM 154, 6RJ 73, 6BB 84, 6DTM 28, 6AUT 26, 6BSB 23, 6AMI 15, 6BER 13, 6CKC 12, 6COL 12, 6BZU 10, 6OT 10, 6ALV 9, 6SR 7, 6CLZ 5, 6BUX 2.

HAWAII—SCM, F. L. Fullaway, oh6CFQ—6BOE kept skeds with ac2AB, ac1CL, op1CW, nu6ABG and 6EM which accounts for his traffic. 6DEY has trouble with local QRM. 6DQQ asks all Honolulu stations to QSO as he always has traffic for Hu. 6ADH has a 50 with a zep antenna and keeps skeds with nu6ACZ and oh6DQQ. 6DJU is still getting out on 40 and 20. 6CLJ handled several tests messages in the contest. Has sked with nu6DBM. 6ALM has a sked with nu6BVM. 6DB has the new shielded grid receiver and reports that it is FB.

Traffic: 6BOE 72, 6DEY 63, 6DQQ 62, 6ADH 40, 6DJU 33, 6CLJ 24, 6ALM 17, 6DB 16, 6DLR 11, 6DCU 4, 6CFQ 23.

SAN DIEGO—SCM, G. A. Sears, 6BQ—6AJM leads in traffic and has 3 daily schedules. 6AKQ is a new ORS having daily schedules with oh. 6BAM finds plenty of traffic on the 80 meter band. 6BQ is now on 21 meters daily QRW traffic. 6EC still has a daily schedule with nn-1NIC. 6RYZ works daily schedules with op-3AC. 6BWI has daily schedules with 6DQQ, 6BWT, and NIJN. 6FP is on the air again with a brand new station. 6DGY is off temporarily until new power transformer is available. 6DNS just finished a new 50 watt TP and TG set. 6DCT says new ops at the High School keep him QRW. 6OX is on occasionally. 6DGW is a new convert to the TP-TG circuit. 6BAS is building over his crystal control set. 6QY has eliminated all interference and can be heard only on his own wave. 6CNK says his motor cycle keeps him off the air. 6BXI has been installing Vitaphone outfits. 6BFE is still QRW. 6AKZ has been on the air with his portable recently. Your SCM recently had letters from former San Diego amateurs, F. L. Hopkins now 90N and Jim Schrader 6CEV who send their 73 to the San Diego gang.

Traffic: 6AJM 664, 6AKQ 215, 6BAM 169, 6BQ 128, 6EC 73, 6BYZ 55, 6BWI 44, 6FP 38, 6DGY 34, 6DNS 28, 6DCT 12, 6OX 12, 6DGW 10, 6BAS 9, 6QY 8, 6CNK 5, 6BXI 4, 6BFE 3.

SANTA CLARA VALLEY—SCM, F. J. Quement, 6NX—6BHY and 6DRI are new ORS. 6AMM delivered 175 this month. 6BAX hooked 4 continents in 3½ hours. 6BMW turned in a large list of off-wave stations again this month. 6BYH tried 80 meters with good results. 6NX is again QRW for traffic on 41.2 meters. 6AOD was QSO China and handled important traffic. 6BNH is badly handicapped by poor location. 6CJD has been moved around so much that he has decided to get off the air until located permanently. 6MP is still QRW studies. 6BVY, 6CSX and 6AZS please report.

Traffic: 6AMM 305, 6BHY 61, 6BAX 40, 6BMW 27, 6BYH 19, 6NX 16, 6DRI 14, 6AOD 6, 6BNH 2.

LOS ANGELES—SCM, D. C. Wallace, 6AM—6BSN, 6ZBJ, 6BZR and 6AM make the BPL this month. 6ZBJ handled some traffic from the flood area during the San Francisco Dam break. 6BSN has only been reporting for a couple of months but has made the BPL for the past two months. 6BPO is keeping

three schedules and hopes to have even more next month. 6BZR worked a boat off the coast of "fo" using call of XIA. 6AM has a new National Pyrex insulated transmitting condenser. 6COT says that every time it rains the water soaks in thru the shack and causes the QSL cards to fold up. 6AHS is going to Alaska to operate in the canneries. 6APW handled some business messages to and from Shanghai. 6ALZ worked 5 continents in one week. 6BGR has pure DC again and no BCL QRM. 6DGT would like to get some good consistent skeds any evening after 10:30 pm. 6BJX reports that 6BEA, old timer of spark days, will soon be on the air again. 6BJX's old Ford gave up the ghost and he is waiting for a new one now. 6ABK took three messages from oa-4PN. 6DKX is increasing power supply here. 6QL has been QSO several South American stations on 20. 6CQP is with the Sheperd radio service in Hollywood while the studios are shut down. 6BZC says DX is good now but he has a bad power leak. 6BXD had a junior op arrive this month. 6BUM has some fine skeds and says more coming. 6ANN is one 10 every Sat. and Sun. and would like skeds there with anyone. 6DOW is going to move pretty soon. 6AKW did some double back relay from China to Philippines. 6CMQ is still QRW Cal. Tech. 6CHT is very busy at KFQZ and doesn't find much time for traffic. 6ALR has not been on very much lately, as he built a new shack and went into the radio business. 6DCH just moved to a new QRA. 6CUH had a FB time at the hamfest March 22 and is building a new receiver a la 6AM. 6DEG has two xmitters now, one on 40 and one on 80. 6BRO has been letting traffic slump in order to boost the ARRC, the new Los Angeles Radio Club. 6CQA is on regularly now. 6DPY got R7 from op-1AD using a 210. 6PY is in Ventura now for the Western Electric and is unable to be on at 6PY. 6DHU is looking for some skeds. 6CNJ has been very busy installing a Mercury arc rectifier. 6AIO reports that there are two new hams in Burbank. 6DZL and 6EAQ using low power. 6CQT would like a sked with Chicago on 20 meters. 6BHR, 6DPK, 6BVT, 6CLK and 6BGC send in reports as usual.

Traffic: 6ZBJ 209, 6BSN (Feb.) 206, 6BPO 196, 6BSN 159, 6BZR 146, 6AM 139, 6COT 66, 6AHS 63, 6APW 58, 6BFP 60, 6ALZ 49, 6AGR 48, 6DGT 43, 6BJX 38, 6ABK 36, 6DKX 35, 6QL 38, 6CQP 31, 6BZC 28, 6BXD 25, 6BUM 17, 6ANN 15, 6DOW 14, 6AKW 13, 6CMQ 11, 6CHT 10, 6ALR 9, 6DCH 9, 6CUH 9, 6DEG 8, 6BRO 7, 6CQA 7, 6DPY 6, 6PY 2, 6DHU 2, 6CNJ 2, 6AIO 1, 6BHR 1.

ARIZONA—SCM, D. B. Lamb, 6ANO—6CDU delivered a msg to a certain party and a few days later he received a pair of white gold engraved cuff links as appreciation of the msg. delivered from Hawaii. 6BWS is still going with his YL but says no serious intentions of getting married. 6CPX reports that of 17 msgs, sent, only 5 were delivered. 6AZM reports his Zep antenna didn't agree with March QST so he is changing over. 6DIB had trouble with transformer and will be off for a few days. 6CBJ is QRW school, KGAR and also working. 6BJF put up 20 meter Zep using 5 watt and homemade bug. 6BPL pounding from Roosevelt seems to be getting out OK. 6DWQ working schedule with 810 3 times a week. 6ANO is having trouble with BCLs within block from station. 6DCQ is QRW work but is on occasionally. 6CRA and 6BHC applied for an ORS.

Traffic: 6BJF 16, 6CBJ 27, 6AZM 4, 6CPX 48, 6BWS 54, 6CDU 38, 6ANO 54, 6DRH 32, 6DCQ 10.

SACRAMENTO VALLEY—SCM, C. F. Mason, 6CBS—6CSG is strong with low power. 6FH has been heard in England and regularly in Australia but has never been able to hook up with them due to interference around him. 6ER is putting 100 watts into a 210. 6DPR is still waiting for his 50 watt. 6ATQ is on the air sometimes but work interferes with hamming. 6DTK will be on the air again soon in a new location. 6AYI is now building a set for 40 meters. 6DQY is busy with school work. 6CDK is working schedules now with the Philippines on 40 meters. 6SG reports DX scarce. 6BBU is building a 7.5 watt Hartley. 6ABX reports completion on a 7.5 watt transmitter using Aero Coils.

Traffic: 6CIS 160, 6CDK 100.

PHILIPPINES — Acting SCM, J. E. Jimenez, op1AT—There was no written report sent in this month for P. L., nothing except traffic.

Traffic: op1DR 128, op1HR 505, op1DL 113, ap1GZ 9.

NEVADA—SCM, C. B. Newcombe, 6UO—6LB has added a UX210 to his set and is increasing power. 6CDZ worked 6DJJ who says that the air-mail op at Los Vegas is going on the air soon on 40 meters. 6ABM was off the air all month but expects to be back soon.

Traffic: 6CDZ 31, 6LB 37, 6UO 40, 6CHG 23.

ROANOKE DIVISION

VIRGINIA—SCM, J. P. Wohlford, 3CA—3CEB is off the air on account of blowing his fifty watters. 3ANB is off also due to QRM officers at fort. 3EC is using MG now. 3ARD is a new station at Norfolk. 3II is back on the air at his own station. 3KU seems to have jumped into the BPL at last. 3WM reported as working all continents. 3TN is going strong on 80 meters. 3JT is on at times. 3ASC is a new station at Hampton Roads. 3NM QSK all skeed account of QRM school work. 3ASE is a new station at Charlottesville. 3AG continues to climb for the WAC—has 21 countries to his credit. 3BGS expects to have his power by July 1st. 3BZ operates on 40 meters. 3AKM is an old timer back on the job. 3CKL continues to run his station with 210s. 3ANV continues to improve his station. 3API says his location is rotten. 3CEL handled one for Calcutta direct to France after six hour's trying. 3ASC and 3ALS are asking for ORS. Send in three consecutive reports, OMs. 3BDZ and CKL report a glorious time at the Charlotte meeting.

Traffic: 3CEB 22, 3KU 325, 3WM 20, 3TN 99, 3AG 6, 3BGS 9, 3BZ 1, 3AKM 8, 3CKL 42, 3ANV 13, 3CEL 7.

WEST VIRGINIA—SCM, C. S. Hoffman, 8HD—The best traffic this month was done by 8CNZ, SSP and 8ACZ. 8VZ operates at 8SP. 8ACZ did some good work by keeping eight schedules for traffic. 8AUL, 8DCM and 8DPO seem to be the DX hounds for the state. 8AUL and 8DCM worked five countries. 8DPO works oh-6ADH consistently. 8ED is putting in a big set. 8CLQ does some good work when not QRW school. 8DEW is doing some nice relaying and DX on low power. Glad to hear from 8CDV, 8BBM and 8BJB. The gang will be sorry to hear that 8CNZ is now an ORS in Pittsburgh. 8CYR, 8WK, 8DOI, 8BUB and 8CEK have been cancelled for various reasons. 8BPU 8CSR, 8BMR, 8JE, 8AFP, 8LI and 8DNM are doing good message handling work.

Traffic: 8CNZ 62, 8SP 55, 8ACZ 42, 8DCM 28, 8DPO 20, 8CLQ 4, 8DEW 16.

NORTH CAROLINA—SCM, R. S. Morris, 4JR—4AB, E. I. Smith of Greensboro has been appointed RM. Please give him your cooperation. 4SJ is back on the air after a long layoff. 4MI has been trying 20 and reports fair luck. 4HV has been using 20 but reports that it can't be depended on every night. 4AEH is doing well with a 112 in a TGTP set. 4AB reports less traffic due to failure of a favorite schedule. 4TS is back on with a MOPA set. 4OH says heavy QRM from tennis and dancing lessons. 4AFO is a new station at Washington. 4OC is experimenting on 20 and 80 with his crystal set. 4VH reports less traffic due to a little DX hunting before summer. 4ADJ put a message to New York City and got a reply in 15 minutes. 4AEW is a new station in High Point. 4ADQ is beginning to step out with his 210. 4UQ, the station of the Charlotte Amateur Radio Club, is going strong with fifty watts. 4JR has been working on 20 quite a bit due to heavy QRN on 40 and 80.

Traffic: 4AB 56, 4SJ 17, 4VH 14, 4OH 13, 4MI 9, 4JR 9, 4OC 8, 4ADJ 5.

ROCKY MOUNTAIN DIVISION

COLORADO—SCM, C. R. Stedman, 9CAA—9EAM carries off the honors again this month which makes the third month in succession this has happened. 9EJW is still holding his own. 9BYC still reports a fair total altho his ORS was cancelled at his request recently. 9CSR has applied for an ORS certificate. 9EUR at Pueblo wants an OBS. 9ERN sends in his first report and adds that at present his station is mostly community-owned but that the borrowed goods will soon be returned. 9DQD is thinking of putting in a filter. 9CAT wants an OBS also and says traffic is picking up some. 9ENM and 9CAW have a regular schedule and are handling gobs of traffic. 9CAW is putting in more power. The Commerce club at Pueblo has given the club there free use of their rooms. 9DRV, 9EXV, 9EVK, 9EOO

and 9FBE are all active Pueblo stations. 9FEM is the latest addition. 9ESA is a new Denver station. 9DKM blew up about \$25.00 worth of equipment trying to cure QRM to BCLs. 9CCM says this may be leap year but the fellows don't wait for her to act. 9CDE is much pleased with his latest DX and also likes the Zep antenna. 9CAA will have a mercury arc doing its stuff by the time this is in print. He is leaving the KFXF job the first of April. 9CTP is doing most of his work on 20 meters now. 9EEA lost a 96' tower in a high wind which recently visited Denver. 9BQO says he will be on as soon as he gets a job. The Associated Radio Operators of Denver are planning another trip to Pueblo for a joint club meeting again soon.

Traffic: 9EAM 256, 9EJW 24, 9BYC 24, 9CSR 21, 9ERN 6, 9DQD 91, 9CAT 8, 9ENM 105, 9CAW 51, 9CDE 8, 9CAA 83, 9CTP 17, 9CCM 7.

SOUTHEASTERN DIVISION

FLORIDA—SCM, C. E. Pfoolkes, 4LK—For the information of the new fellows, please list your traffic according to the type: originated, delivered, relayed and total. This will assist the SCM in giving you proper credit. 4BL will have a YL op very soon. FB. Sickness kept 4CK off the air some this month but still has a big traffic total. 4ADB pushes them out with a 201A and works Europe consistently. 4FM sure has a large total for one day's work on 80 meters. BCL sets keep 4IE on the go. 4TK is on the staff at WJAX now. Glad to see 4SD back on the air again. 400 with an 852 is putting St. Petersburg on the air. 4CH worked en-OGG and got 15 hour service on his traffic to Holland. A QST from 4NM helped to find a lost boy in Miami. The flu had 4BN down but not out, this mo. 4HY assisted the SCM with his 250. 4OB has had a lot of trouble with his mercury arc blowing his condensers. Glad to hear from 4AC who gave some quick service from oh to Ky. 4MS rebuilt his xmitter and put in a 250. 4ABJ also rebuilt this month. 4KC went fishing so not much traffic. Hi. 4NE went up for his commercial ticket. 4LK is still here.

Traffic: 4BL 65, 4CK 61, 4ADB 48, 4FM 45, 4IE 23, 4TK 21, 4SD 19, 400 12, 4CH 10, 4NM 8, 4BN 7, 4HY 6, 4OB 5, 4AC 5, 4MS 5, 4ABJ 3, 4KC 2, 4NE 2, 4LK 2.

ALABAMA—SCM, A. D. Trum, 5AJP—5AXN is busy these balmy days and gets little time to pound brass. 5AV has been on the air regularly and handles traffic in veteran style. 5BAB is a new ham. The gang of 5DJ, 5VX, 5BAB and 5AV visited Auburn recently and had a fine time with 5DI, 5OA, 5JP and the other fellows at 5YB. 5AYL was reported R-9 in eg for his first time. 5GP has moved from Auburn back to Anniston and promises some lively work there. 5AAD blew his H tube. 5UV is going strong. 5ATS is now working regularly. Bayne is one of Montgomery's consistent workers in ham radio. Gantt the old reliable has been sick. QRW with flu, but will be going strong again soon. 5JY just finished a high class low-wave receiver and is doing splendid work on the 40 band. 5ATJ is rebuilding trying to improve his xmitter and hopes to have a better and stronger note on the air next month. 5AJP is rebuilding and dormant. 5NL is in status quo now.

Traffic: 5JY 168, 5ATJ 4, 5ADA 14, 5ATS 15, 5UV 31, 5AAD 7, 5AYL 14, 5GP 20, 5AV 40, 5AX 46.

GA.-S. C. CUBA—SCM, H. L. Reid, 4KU—4ABS sends in a nice report. He has not done the work he is usually counted on for but has been on consistently. 4NQ-4FE and 4PA are all on and doing good work. 4KL is back on the traffic work after a delay. 4RN is getting the Blues. 4GY is on and can be counted on for the Atlanta traffic. 4KU sold his receiver to a BCL and is waiting the arrival of a new one.

Traffic: 4ABS 24, 5KL 12.

WEST GULF DIVISION

NORTHERN TEXAS—SCM, J. H. Robinson, Jr., 5AKN-BG—The Dallas gang is trying to corner the market on ham apparatus. 5ACL heads the traffic list, and is also the star DXer. 5HY handled a few. 5AKN-BG is handling traffic from 12 am to 5 am each morning. 5RG is still trying to make the northern hams think he's a cowboy. 5JD is using C. D. on 37.8. 1KH visited Dallas this month and gave us the lowdown on radio around Boston.

6BAM is getting lined up right. Old 5UD is back with us again. Fellows, there's a UX222 for the first northern Texas station getting in the BPL.

Traffic: 5ACL 17, 5HY 12, 5AKN-BG 10, 5AQ 7, 5RG 6, 5JD 5, 5JZ 4.

OKLAHOMA—SCM, K. M. Ehret, 5APG—5AXX reports for the first time. 5BAG of the Veterans Hospital at Muskogee also reports for the first time and managed to bag a few msgs. 5ANL still works skeds on 80 and reports a new sked with 6BAM two nights a week. 5ANL emphatically states that he has been married for 16 years and has a 12 year old daughter and that the printer of QST got balled up about him chasing YIs and says it's a good thing up the OW doesn't read QST. Hi. He reports 5ADO has blown up—another good man gone wrong. 5ADV has tested 'em all and says the old Hartley for him. 5AMO says calculus QRM fierce. 5VH reports sked with 3VR who is ex-5JT. 5AZG not doing much but fuses with BCL receivers. 5ANT also reports QSO with 3VR. 5AIR lost his 180 meter antenna in a big blow but says the 20 and 40 meter sets still going strong. 5AYO has also settled on the Hartley as his permanent love. 5BAE is a new ham in Okla. City. 5QL is still off the air building the big crystal set. 5SW worked a Belgian on 20 meters. 5AFX moved in his new home and is arranging for a pole raising bee. 5AAV lost his mast but has a better one and is doing good work. 5APG had good luck grinding a crystal but says his power amplifiers act more like power reducers. 5ARX reports QSO with a 1 on 180 meter fone.

Traffic: 5APG 23, 5AYO 13, 5AIR 16, 5SW 6, 5ANL 23, 5ANT 86, 5VH 15, 5AMO 181, 5ADV 4, 5BAG 16, 5AXX 14, 5AAV 8.

SOUTHERN TEXAS—SCM, E. A. Sahn, 5YK—Reports came in well this month. Everyone seems to be doing something worth while. We have a new station in 5ATM. 5LP is another new applicant for ORS. 5AHP wired his usual prompt report. He reports 5OX accidentally shot himself but is getting along nicely. 5HE is back on the air and will be on every day now. 5HS sends in a nice report and indicates there will be another Hamfest this year. 5AMG reports that he has not been on much due to being sick. 5OX reports that he delivered a msg from Antwerp. 5ALA says he has been off the air since the end of the Tests but is going on again soon. 5FW has been on 20 meters most of the time.

Traffic: 5EW 33, 5OX 6, 5HS 5, 5HE 9, 5ATM 73, 5AHP 4, 5LP 43, 5ABQ 82.

CANADA

ONTARIO DIVISION

ONTARIO—SCM, W. Y. Sloan, 9BJ—Eastern Dist: We are sorry to report that Mrs. Hewson, ne-3XW, who has been acting as representative and correspondent, has had to go to Montreal to join her husband. F. A. Goodier of ne-3XQ will carry on this work. 3XQ had an unfortunate accident in the blowing up of plate transformer, tubes, and nearly everything else in sight. 3XQ and 3MD are running an advertisement in a small local paper telling about the ARRL and its work. 3MD, using a five watter, has been QSO a good list of stations at considerable DX. 3KT is back on again now. 9CC is broadcasting time signals from the Ottawa Observatory on 52.5 meters each week day.

Central Dist: 3GM has done some excellent work this month on medium power. 3AI has been keeping schedules on 80 meters. 3BT has been using 20 and 80 meter bands. 3DY has been running a series of tests using odd antennas on 20 meters with excellent results. 3CJ worked all Canadian and all U. S. districts one evening in less than 4 hours on 40 and 52.5 meters. 3CJ and 3DY constructed a 2 meter beam transmitter at the Central Tech. 3MV's tube is developing senile paralysis but he has managed to keep some schedules anyway. 3EL leads the whole Section in DX this month, having worked a whole string of foreign stations. 3AZ is our star traffic station this month and he got it all by keeping schedules. 3AR and 3ET are on the air in Parry Sound. 3AR wants a schedule with some Toronto station. 3IN is on the air once more and using a 250 watter on 40 and 52.5 meters. 3BC is using 52.5 meters mostly and keeping schedules with 3DG in western Ontario. 9BJ packs a terrific wallop these days on 52.5 meters. 9AL still keeps several

schedules and works everything in sight on 52.54 meters (crystal controlled). 3DC is also crystal controlled on 52.6 meters and should be accepted as the upper boundary on this band. 3FC has been devoting his time to early morning operation on 19.8 meters. Southern Dist: 3CS still maintains his position as DX star in this district. 3IA is unfortunately retarded by sickness in his family. Sorry, OM. 3UD is again in operation. 3AQ is rebuilding and installing a MOPA transmitter as set forth in Feb. QST. 3CM is still having trouble with his transmitter so no operation at present. Northern Dist: 3HP is going strong as usual on 20, 40 and 52 but bewails the lack of traffic this month. 3AH is now on the air on 40 and 80 meters. 3NI, 3HE and 3VS are all on the air in the north on 32.5 meters.

Traffic: 9BJ 51, 3CS 41, 3AZ 38, 3CJ 36, 3DY 25, 3GN 30, 3MA 20, 3AI 14, 3BC 13, 9AL 23, 3FC 10, 3HP 9, 3CB 6, 3AQ 4, 3DG 3, 3EL 3, 3BT 3, 3AR 2, 3IN 2.

MARITIME DIVISION

PRINCE EDWARD ISLAND—SCM, F. W. Hyndman, 1BZ—1BZ has been on the air quite a bit lately. Let's see a little action from the rest of the fellows in the Section.

NEW BRUNSWICK—SCM, T. B. Lacey, 1E1—We understand that GO of ne1AD was seen one morning at three am with a shovel, broom and other hardware endeavoring to keep the snow clear of his radiating system. 1AD is star station this month. 1AX has done remarkable DX with his new tube and filter system and has been heard on various bands. 1AM has been dabbling with directional antenna lately. 1AK has worked many stations in eg, ef, Africa, and oz. 1AY has been with us for a month now and has visions of worldly contact. 1E1 has not been on much lately owing to the fact that he has been chasing ice off a local broadcasting antenna. It is noticed that numerous of the old hams in our gang are letting their subscriptions to QST lax. This won't do, fellows.

Traffic: 1AD 33, 1AX 21, 1AK 23, 1AY 2, 1AM 17.

QUEBEC DIVISION

QUEBEC—SCM, Alex Reid, 2BE—The largest Hamfest of all time was held on March 3rd at station 2BE. There were 24 present, 20 of whom were active hams. There was some real rag-chewing and a good time had by all. 2BR has added another 210 and has his set perking in fine shape. ne2BW is also stepping out these days and turns in a nice traffic total. 2AL worked fo-a9a on 20 meters at 3 pm March 10. 2BE has worked su-10A six times during the month and gets reports from R9 to R7. 2BB keeps good skeds and turns in a fine report. 2CA has rebuilt and made a wonderful job of it. 2AL and 2BE are keeping skeds with VCB on 52 meters Wednesday evenings. 2BG is doing his stuff as usual. 2HV is QRW with commercial work and is doing very little brass pounding. 2CW is down on 20 meters and getting out well. 2AX worked oz on 20. Altho 2AC's report is late, he more than makes up for it with a very fine report.

Traffic: 2BR 53, 2BW 41, 2BB 13, 2AL 13, 2BE 12, 2BG 8, 2AC 25.

VANALTA DIVISION

BRITISH COLUMBIA—SCM, E. S. Brooks, 5BJ—5CO has two Vanalta skeds. 5AR is convalescent and the guest of 5CO-5CC. 5AR uses a tube base set of coils and hears 'em all. 5AT was QSO ne5AJ who is in New Zealand. 5CJ is also building a 222 receiver. 5CT uses a break-in system and keeps regular skeds on 52 and 80. 5AD is all ready for traffic and has a brand new ORS. 5BR is a good traffic station and another new ORS.

Traffic: 5AC 65, 5BR 55, 5CO 28, 5CT 8, 5AD 2.

ALBERTA—SCM, A. H. Asmussen, 4GT—4AH has been on the job having the largest message total mostly due to making and keeping schedules. 4HM has worked New Zealand. 4CU has been away most of the month with the C.C. of S. at Victoria. 4BV may be moving to Edmonton. 4CL still operates a BCL station but says he will do more at the ham station later. 4FA sure has a nice pole and gets good results. 4BC likes his new job selling suites better than operating the Calder station.

Traffic: 4AH 163, 4HM 11, 4GT 3.

(Concluded on Page 86)

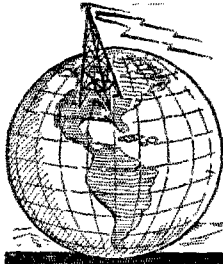

I.A.R.U. NEWS

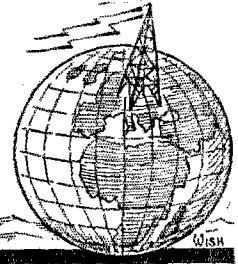

GERMANY

"Receiving conditions seem to have improved a good deal during the last month. European stations were heard with remarkable signal strength at times, as were more distant stations, particularly those in the U.S.A.

"Some tests on the transmission of pictures between southern and northern Germany gave fairly good results.

"Many of our amateurs are interested in investigating the relationship between reception conditions and the weather and should appreciate any coöperation which foreign amateurs may be able to lend. 4YAE and 4ACI have developed a device which gives very pure reproduction of phonograph records.

"Our Berlin amateurs are very pleased to have nu2BDQ among them. It is expected that he will be on the air under the call of ek4CJ in a few days time.

"Our next annual convention will very probably be held in Dresden during April or May. The exact date has not as yet been set."

—Curt Lamm.

HUNGARY

"We are extremely pleased to announce that on the second of January there was founded at Budapest, the Magyar Rovidhullamu Amateurok Egyesulete, or Hungarian Shortwave Amateur Society. The address of the Society which may also be used for the forwarding of QSL cards is: MRAE, Budapest, II, Buday Laszlo utca 5/c.

"At the general meeting at which our organization work was accomplished, the following officers were elected: President, Istvan Fodor; Vice President, Istvan Kemeny and Secretary, Kurt Nekolny.

"Up to this date there are but three licensed amateur transmitters. These are: ewH1, Kurt Nekolny, Engineer, Budapest, II, Buday Laszlo utca 5/c; ewH2, Istvan Kemeny, Engineer, Budapest, V, Szemelynok utca 21/23; ewH4, Denes Bibo, Enying, Hungary.

"There are about twenty unlicensed stations working at the present time whose calls may be recognized, as they all use the intermediate 'ew' followed by two addi-

tional letters; such as ewAA. There are about one hundred and forty short-wave listeners who are scattered all over the

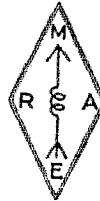

ANOTHER DIAMOND

This one is the insignia of the Magyar Rovidhullamu Amateurok Egyesulete or M.R.A.E.

country. Their calls start with the letter 'H' followed by three numbers; i.e., H091 (H zero 91). They are commonly referred to as 'H boys'.

"Our kindest greetings go to you all."

—J. Molnar.

JUGO-SLAVIA

"It has been impossible to get legal license to operate in our country, in spite of which we have been on the air for more than two years. However, just a few days ago our transmitting was stopped by the Government and for the moment we are silent. We are not giving up, though, but are resorting to legal measures by which it is hoped that we will be able to obtain licenses for our activities. It is not thought that this will be a difficult task and we are hoping to be back on the air again in a month or so. See you then!"

—U. J. R. A.

NORTHERN IRELAND

"At the time of writing this (early in March) conditions here have taken a decided turn for the better, at least as far as transatlantic work is concerned. Several of our low powered stations have 'sent across' during the last few weeks.

"6YW has worked several NU stations on both 23 and 32 meters in addition to working Iraq twice and being heard in India. All this with an input of about seven watts! 6WG and 5WD who are located in Coleraine and are using hand driven generators have worked many NU stations. They used the

(Continued on page 74)

Calls Heard



eg-2BQH, G. G. E. Bennett, 26 Blenheim Park Road, Croydon, Surrey, England

(During January, 1928)

(On 20 meters)

laac iaba laep iaab lafd laff lafl lah lajm
 lakd lale lans laqt larx lasf laek lasr lasu
 latj lawe laxa lbat lbhm lbeb lbkv lbus lbtq
 lbux lbvl lbw lbxy lbd lckp lcmf lcxm lcom
 lda lfl lga lho lla lid lij lkl lmf lnf lqp lry
 lsz lww lzz 2abe 2aen 2afr 2afx 2ahm 2aip 2aol
 2arp 2au 2awf 2bao 2baz 2bbx 2bg 2bge 2bgt
 2br 2blm 2bum 2ch 2es 2etf 2eug 2evj 2dp 2dr 2fn
 2gp 2jn 2md 2ob 2qu 2tp 2va 2vd 2vi 2ws 2xad
 2xbc 2xg 2adm 2ahr 2aib 2akv 2bms 2bwt 2caq
 2ce 2cec 2cee 2ekj 2eq 2jm 2qv 2vg 2dm 2hx 2am
 2ary 2ie 2adg 2afq 2agy 2ahc 2ail 2ake 2akn
 2aly 2amk 2ane 2arb 2aul 2aut 2axa 2ayu 2baz
 2bde 2bfa 2bhz 2bni 2cel 2cfd 2cgu 2cim 2cke
 2clp 2cmb 2cnh 2cnj 2cug 2ddn 2dhp 2dij 2did
 2dod 2don 2dsi 2dud 2hx 2kr 2xe 2xk 2acu 2aau
 2erd 2gjb 2ekw 9hm 9mb naa nvf waj wik wll
 wmfz wnp wnu wvy ai-2kt aq-11m as-ra03 fm-Brit
 fm-8ssr fo-a3z fo-a4f fo-a7n fo-a7u fo-lsr ne-lar
 ne-lbr ne-2al ne-2be ne-3cs ne-3mp ne-cf ne-8ae
 ne-8ca np-wgt np-4sa np-4xk np-2fg oa-2dy oa-3bd
 oa-3me oa-4nw oa-7cw oa-vip oa-viy od-ane od-and
 od-anf od-anh od-ank od-pkh oz-2bx sa-ip2 sa-lp3
 sb-spu sd-pjn sl-hjg sv-pjr.

(On 40 meters)

laac lach lage lahv lajd lajx lamj land lanx
 laqp lasi lask lasy laxx lbeg lbew lbje lbke
 lbqs lbqt lbu lbvb lbw lbwb lcax lccz lcd lckp
 lcmp lcxm lcpj leax letp lfl lfm lga lhg lkh
 lli lmo lmy loa lrp lsz lwl lxd 2ad 2adb 2add
 2afr 2afv 2afw 2age 2agf 2agn 2ags 2agw 2ahg
 2ajt 2ald 2als 2alu 2ama 2amg 2anf 2aon 2aow
 2aqq 2ari 2atq 2ats 2av 2avg 2avq 2az 2bce 2bck
 2bco 2bcq 2bda 2bdc 2bdh 2bek 2bew 2bgo 2bhf
 2bhr 2bi 2bit 2bit 2bme 2box 2bv 2bvh 2bvr 2ern
 2eua 2evj 2ewm 2exl 2fc 2fa 2jw 2ku 2lx 2md 2ov
 2rs 2tp 2tt 2uh 2uo 2vd 2vy 2wi 2xd 2xs 2aef 2afv
 2ag 2aib 2akv 2amw 2anh 2au 2av 2bhq 2bkw
 2bmv 2bnu 2bsh 2bsd 2buv 2bwt 2ceb 2ekj 2ein 2em
 2ee 2ev 2gi 2gt 2hf 2hg 2ht 2ld 2lo 2sp 2sr 2st
 2sm 2sz 2ue 2vx 2wm 2aef 4bl 4em 4dn 4ec 4ei
 4gq 4hx 4jr 4lk 4lx 4oh 4pa 4pd 4pi 4pu 4qz 4si 4to
 4ud 4ueb 4uej 4uke 4ua 4vg 4we 4yb 4bis 4don
 4hm 4xi 4aff 4akc 4akv 4ala 4amo 4ane 4ank 4arb
 4auc 4auq 4avs 4axz 4ayu 4bcm 4ben 4bev 4bhx
 4bja 4bni 4bor 4box 4bpq 4brh 4caw 4ccs 4cfn
 4cga 4cmz 4csl 4dal 4dhe 4dem 4dkk 4dki 4dne
 4dod 4don 4dpp 4drs 4dsa 4dsi 4dsy 4eq 4gl 4hx
 4im 4ji 4pi 4qr 4sv 4sx 4ack 4aem 4aok 4aue
 4auq 4bim 4bgr 4brr 4cjl 4cjm 4eph 4epv 4erd
 4eri 4eye 4dee 4doi 4dpv 4ds 4dws 4dy 4ecz 4ef
 4efk 4ez 4hb 4mz 4nr 4pr 4uk kel kez kzet naa
 npc wbu wiv wub ac-2ck ac-xom ai-hzal ai-2bg
 ai-2kt ai-2kw ai-2kx ai-2rx aq-bdl aq-lhf aq-11m
 aq-lmdz as-ra03 fe-f2 fe-suc2 fe-suw fi-ise fi-lita
 fm-al fm-8jo fm-8prsv fm-8ssr fo-a8m fo-a4l
 fo-aga nb-be3 ne-cg ne-lak ne-lap ne-2be ne-2bx
 ne-8ay ne-8nv np-4aan np-2ags nz-nba oa-2dy oa-2rx
 oa-2wc oa-3cp oa-3hl oa-3kw oa-4lo oa-3lp oa-8is
 oa-3ut oa-4go oa-4ws oa-5by oa-5hg oa-7ch oa-7cw
 oa-7lj oa-vis od-pmz od-ane od-anf oh-npp oi-npp
 op-lbd op-lcw op-lhr op-4aa op-nbo oz-lan oz-lfb
 oz-lfj oz-2ad oz-2at oz-2ay oz-2bp oz-2bx oz-2ga
 oz-2go oz-2xa oz-3an oz-3aj oz-3ar oz-3au oz-4aa
 oz-4ac oz-4ae oz-4am oz-4ao sa-irl sa-lpl sb-lao
 sb-law sb-lcl sb-lid sb-2ah sb-ptz sb-spw su-loa
 tel-arx tel-ardi tel-awl tel-aws xep-ima.

eg-2ZG, A. M. Houston Fergus, La Cotte, La Moye, Jersey, Channell Islands

(20 meters between Feb. 19 and 26th)

lahx latv lawe laxa lbat lbhm lbk lbxl lbsq
 lcd lcmp lod lry lsw 2an 2bev 2bg 2bum 4bl 8ben
 8baf 8cfe 8pi ne-lar ne-2ax fm-8vx fo-a4e fo-a2a
 op-lbx wnp.

(Heard on 20 meters from Feb. 7 to 13)

laba ladm lakz lair laxa lbat lber lbhs lcic
 lco lll lfs lij lld lxii 2afx 2gp 2tp 2va 2bzz 3lw
 3nr 4xk 8adg 8ayu 8bct 8ben 8btt 8cim 8csl 8cug
 9eku fm-8rit fm-8ssr fo-a3z ne-lar wnp.

eg-6CJ, F. Charman, 76 Salisbury St., Bedford, England

(Heard during January, 1928)

labd laet iadm labb lafl lage lagi lags laic
 lajd lajl lajm lajx lamj lakz lamv laqp larv
 larx lasf lask latr lavj laxa lazk lbac lbba lbcb
 lbg lbqg lbjc lbjk lbke lbkp lbob lbom lbw lbvy
 lecp lejc lekp lda ldp lge lgn lhm lij lka lkk
 lkw llt llx lmv lnh lom lqf lry lsz lwi lvw
 lzz lzz 2acd 2aer 2afz 2agr 2agv 2agw 2ahm
 2ain 2ald 2alk 2alu 2ani 2anp 2anv 2aol 2aow 2aqd
 2ats 2aun 2awu 2ayb 2ayk 2bac 2baz 2bbf 2bcv 2bcw
 2bdf 2bek 2bew 2bfq 2bgo 2bhq 2bir 2bke 2bqh 2bqt
 2bvd 2bxu 2cgj 2cjb 2ckg 2cuf 2cuq 2evj 2ewm 2et
 2ev 2gp 2kx 2md 2mk 2pv 2qr 2qu 2rs 2sb 2sz
 2tp 2tt 2tu 2vg 2vi 2wi 2zu 2aw 2afw 2afx 2agp
 2ahp 2aib 2aid 2ajd 2alq 2amx 2anh 2apx 2auo 2av
 2bmv 2bnu 2bsh 2bvd 2bwt 2ceb 2ekj 2ein 2em
 2ee 2ev 2gi 2gt 2hf 2hg 2ht 2ld 2lo 2sp 2sr 2st
 2sm 2sz 2ue 2vx 2wm 2aef 4bl 4em 4dn 4ec 4ei
 4gq 4hx 4jr 4lk 4lx 4oh 4pa 4pd 4pi 4pu 4qz 4si 4to
 4ud 4ueb 4uej 4uke 4ua 4vg 4we 4yb 4bis 4don
 4hm 4xi 4aff 4akc 4akv 4ala 4amo 4ane 4ank 4arb
 4auc 4auq 4avs 4axz 4ayu 4bcm 4ben 4bev 4bhx
 4bja 4bni 4bor 4box 4bpq 4brh 4caw 4ccs 4cfn
 4cga 4cmz 4csl 4dal 4dhe 4dem 4dkk 4dki 4dne
 4dod 4don 4dpp 4drs 4dsa 4dsi 4dsy 4eq 4gl 4hx
 4im 4ji 4pi 4qr 4sv 4sx 4ack 4aem 4aok 4aue
 4auq 4bim 4bgr 4brr 4cjl 4cjm 4eph 4epv 4erd
 4eri 4eye 4dee 4doi 4dpv 4ds 4dws 4dy 4ecz 4ef
 4efk 4ez 4hb 4mz 4nr 4pr 4uk kel kez kzet naa
 npc wbu wiv wub ac-2ck ac-xom ai-hzal ai-2bg
 ai-2kt ai-2kw ai-2kx ai-2rx aq-bdl aq-lhf aq-11m
 aq-lmdz as-ra03 fe-f2 fe-suc2 fe-suw fi-ise fi-lita
 fm-al fm-8jo fm-8prsv fm-8ssr fo-a8m fo-a4l
 fo-aga nb-be3 ne-cg ne-lak ne-lap ne-2be ne-2bx
 ne-8ay ne-8nv np-4aan np-2ags nz-nba oa-2dy oa-2rx
 oa-2wc oa-3cp oa-3hl oa-3kw oa-4lo oa-3lp oa-8is
 oa-3ut oa-4go oa-4ws oa-5by oa-5hg oa-7ch oa-7cw
 oa-7lj oa-vis od-pmz od-ane od-anf oh-npp oi-npp
 op-lbd op-lcw op-lhr op-4aa op-nbo oz-lan oz-lfb
 oz-lfj oz-2ad oz-2at oz-2ay oz-2bp oz-2bx oz-2ga
 oz-2go oz-2xa oz-3an oz-3aj oz-3ar oz-3au oz-4aa
 oz-4ac oz-4ae oz-4am oz-4ao sa-irl sa-lpl sb-lao
 sb-law sb-lcl sb-lid sb-2ah sb-ptz sb-spw su-loa
 tel-arx tel-ardi tel-awl tel-aws xep-ima.

eg6YL, Miss B. Dunn, Stock, Essex, England

(Heard during January and February)

(20 meters)

ladm lasf lasu laxa lbvl lfs lie lpm lzd 2awq
 2bum 2com 2eug 2gp 2md 2tp 2apx 2hf 4bl 4we
 nc-lad np-4sa eg-5by eg-5hs eg-6ut wnp.

(40 meters)

laln lanz laqt lasf laxa lazd lbhs lbke lbhm
 lbqt lcdi lcmp lic lli lkk lmv lrp lzs 2alu 2apv
 2apy 2ase 2awa 2awi 2baz 2bg 2bkh 2cla 2erb 2eug
 2cvj 2cx 2cxl 2dr 2izz 2ng 2rs 2tp 2uo 2vm 2xad
 2xaf 2adp 2aib 2anh 2apz 2aqz 2aua 2bel 2bms
 2bnu 2cfd 2hf 2mi 2qe 2av 2bl 2ec 2ej 2hx 2lk
 2oc 2oh 2si 2to 2we 2adg 2drj 2yx 2yz ne-2bg
 ne-8ae ni-2sh np-4aa nx-1xl sb-lao sb-law sb-lom
 sb-lid sb-2ag sc-lah se-2as se-3hd sv-lxc sh-9xc
 xem-shm xen-0cp er-5aa eu-15ra eu-20ra eu-23ra
 eu-27ra eu-89ra eu-42ra eu-43ra eu-49ra eu-68ra
 eu-05ra eu-4k60 eu-3wk xey-8pnt ac-xom af-hzal
 ag-67ra fa-lita fe-lies fi-lita fm-al fm-8prsv

(Continued on page 80)

Correspondence

The Publishers of QST assume no responsibility for statements made herein by correspondents.



Radio Frequency Chokes

Room No. 3006,
Bureau of Eng.,
Navy Dept.,
Wash., D. C.

Editor, QST:

There has been much said and written on the subject of r.f. choke coils. Some of the dope was good as far as it went and some was not so good.

I have long hesitated about "breaking into print" but Mr. Binneweg's article on page 46 of the November QST was the last straw that crippled the proverbial camel.

The formula for inductive reactance is: $X = 2\pi f l$ where 2π is a numeral constant, f is the frequency in cycles and l is the inductance in henries. The resultant X is the reactance in ohms of the subject inductance to the passage of current of the frequency f , through that inductance.

Theoretically, we should use a choke which has an infinite inductance, hence an infinite inductive reactance in ohms, which would pass zero r.f. current. Unfortunately, we run into difficulties; namely, the ohmic resistance of the wire and the distributed capacity of the windings, that is, the capacity between turns. The detrimental effect of the ohmic resistance of the wire is self evident. The distributed capacity of the windings results in a parallel tuned circuit, just as if we had an inductance having no distributed capacity and shunted it with a condenser. This is just what Mr. Binneweg suggests and as he says, we can resonate the choke-condenser circuit to the frequency we wish to prevent from passing through, or we can build our choke so that its distributed capacity equals the capacity of an external condenser and it will resonate at the frequency we wish to prevent from passing through; the result is the same.

The impedance of such a parallel tuned circuit from the plate of the tube to the source of power is theoretically infinite, granted, but the impedance of the same series circuit, that is, the circuit from the inductance through the condenser and back to the inductance is nearly zero and results

in power losses due to the high circulating current in this circuit.

Mr. Binneweg's "tuned" r.f. choke is really a tank circuit from which plenty of power could be taken to drive an antenna or what have you, and the resultant circuit is a combination Hartley and tuned plate-tuned grid.

Likewise, the recently published articles which give detailed instructions for making choke coils which have "a natural period equal to the frequency of your transmitter" are all wet. We don't want any distributed capacity in a choke coil, but if some is there by necessity, we want it as small as possible and we, above all, don't want that distributed capacity to be such that in conjunction with the inductance of the coil it will resonate at the transmitter frequency and serve as a tank for our precious power to "chase itself around in a circle".

The reference article reported that resonating this tuned choke "noticeably reduced" the harmonics. Certainly it did and it also reduced the fundamental about fifty percent. Half of the available power was playing merry-go-round in the "tuned choke" and was being dissipated therein in the form of heat.

R.f. chokes should be made to incorporate maximum inductance and minimum capacity and with minimum Ohmic resistance. To accomplish this, they should be wound on small diameter forms and the wire spaced one diameter. An even better method is to use tiny duo-lateral wound coils, pancake shaped about an inch in diameter and mounted on a quarter-inch bakelite rod. Three or four of these coils should be mounted on such a rod, connected in series and spaced about an inch from each other.

I repeat again; the distributed capacity of r.f. choke coils should be kept at the smallest possible minimum and above all, neither the whole choke nor any part of it should resonate at the transmitting frequency.

—E. N. Dingley, Jr.,
Associate Radio Engineer, Bureau of
Engineering, Navy Department.

VOLTAGE SURGES

*Deadly as a
Serpent's
Fangs!*



Play Safe With **PARVOLTS!**

VOLTAGE Surges in electric-powered radio strike at filter condensers with the lightning speed and deadly power of a venomous snake.

Imperfect condensers, improperly rated condensers, non-uniform condensers—all break down sooner or later under the destructive action of voltage overloads. Blown condensers usually mean blown tubes, burned out transformers and chokes and even the destruction of speaker units.

Why take chances with ordinary condensers when ACME PARVOLTS give you positive protection?

These condensers are made only

from highest grade insulation papers and special foils. Every detail of manufacture is under the constant supervision

of experts who have devoted many years to the manufacture of condensers for heavy and continuous industrial duty.

Every PARVOLT is tested to R.M.A. and N.E.M.A. standards and can be relied upon for accuracy and CONTINUOUS DUTY. Sold by leading jobbers and dealers.

Made by THE ACME WIRE CO., New Haven, Conn., manufacturers of magnet and enameled wire, varnished insulations, coil windings, insulated tubing and radio cables.



ACME PARVOLT FILTER CONDENSERS are supplied in all standard mfd. capacities for 200, 400, 500, 800, 1000, and 1500 Vols. D.C. requirements. Uniform bright and smooth for easy stacking. Supplied singly or in complete housed blocks for the important power supply units such as Thordarson, Samson and others.

ACME PARVOLT BY-PASS CONDENSERS are supplied in all standard mfd. capacities and for all required voltages.

ACME PARVOLT CONDENSERS *Made by the Manufacturers of* ACME CELATSITE HOOK-UP WIRE

ENAMELED AERIAL WIRE

Enameled copper wire in both stranded and solid types. Also Acme Lead-ins, Battery Cables, Indoor and Loop Aerial Wires.

CELATSITE FLEXIBLE and SOLID

For all types of radio wiring. High insulation value; non-inflammable. 10 colors.

ACME SPAGHETTI

A superior cambric tubing for all practical radio and other electrical requirements. Supplied in 10 colors.



Announcing...

Dongan By-Pass and Filter Type Condensers

With the acquisition of the business and equipment of the Electrical Specialties Mfg. Company, Inc., Dongan now offers the manufacturers of radio receivers a line of fixed condensers comparable in quality and ingenuity of design to Dongan Radio Transformers.

Mr. C. Ringwald, an authority on condenser design and construction, will direct the condenser division of the Dongan radio line.

Just as Dongan has pioneered in transformer development so will the Dongan laboratories strive to maintain front rank in fixed condenser design. Thus the radio industry is assured additional permanency in the approved parts field.

Dongan will continue its policy as an exclusive source to set manufacturers.

—another Transformer Success

To meet the increased capacity of the new UX 250 power amplifier tube Dongan engineers have perfected two new Output Transformers. No. 1176 is Push Pull type, No. 1177 a straight power amplifier type.

A Popular A C Transformer

No. 6512. This is one of the best-liked A C transformers on the market. It is designed to operate with 4 UX 226, 1UX 227 and 1UX 171 power amplifier tubes. Mounted substantially in crystallized lacquered case, equipped with lamp cord and plug outlet for B-eliminator, also tap for control switch. \$5.75.

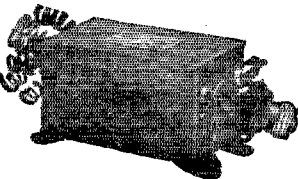

Set Manufacturers and Custom Set Builders

will be furnished with any desired information and engineering data on request.

Dongan Electric Manufacturing Co.

2999-3001 Franklin St., Detroit, Mich.

TRANSFORMERS of MERIT for FIFTEEN YEARS

524 Fairbanks Avenue,
Oakland, Calif.

Editor, *QST*:

Mr. E. N. Dingley, Jr., in his letter to *QST* is simply repeating what we already know of the parallel-resonance circuit. It was stated that this arrangement as used, functioned as a wavetrapp.

Certain factors in design which limit the losses and certain practical considerations have evidently been overlooked by Mr. Dingley in his letter. These will be considered later.

The simple formula for inductive reactance unfortunately does not hold at all at the short waves. It will be necessary to use some mathematics to show that a "properly-designed and properly-operated" (as stated in the contribution to the Experimenters' Section) choke isn't so very "wet" (to quote his letter) after all.

Starting with a parallel circuit consisting of a condenser, with comparatively negligible resistance, in parallel with a coil having appreciable resistance, it can easily be shown mathematically that the loss in a tuned circuit of this nature is given approximately by:

$$E^2 \left(\frac{C}{L} \right) R$$

where E is the voltage across this circuit, R is the resistance of the inductance and C and L are the capacity and inductance of the parallel arrangement. For a given resonant condition, the loss may be decreased by increasing the LC ratio; the resistance of the coil increases as its inductance increases but not in the same proportion. By using a large LC ratio the circulating current may be reduced. We do not want a "power tank" for this purpose.

In a parallel circuit, the higher the LC ratio for a given resonant condition, the broader the tuning, aside from the increase of resistance, so that the trap does not tune so sharply as was explained in the contribution to the Experimenters' Section. Such a circuit, moreover, may be tuned as near the resonance condition on either side as may be desirable; an adjustable choke is convenient.

Several Pacific coast amateur stations have tried out such a parallel circuit and in each and every case, troublesome local interference was entirely eliminated. Such an arrangement may not be the only solution but it is something that furnishes a practical need; nothing else in a transmitter is at present more of a guess-work proposition than the choke. Until something arrives which will "always work" (and at widely different frequencies) or, preferably, more circuits are designed where chokes are unnecessary, or may be placed at positions of low potential, the tuned trap will serve well for many installations, and the losses, in general, will be less than those occurring by the use of

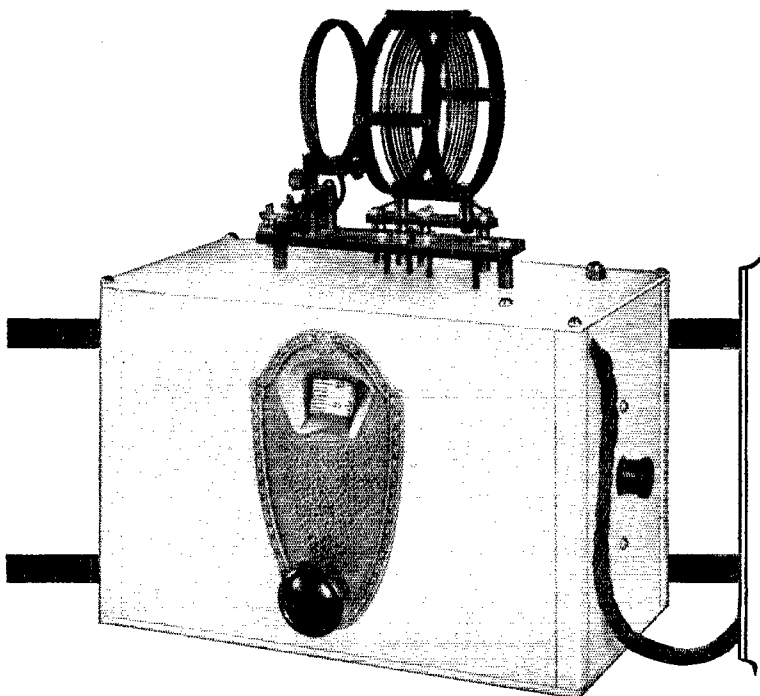

Standard Aluminum Box Shield housing a new 30-110 meter Short Wave Adapter. This unit combines a cabinet, a substantial structure for mounting apparatus and complete electrical shielding. An illustration of the wide range of uses to which these shields are adapted.

FOR IMPROVED RECEPTION

LEADING radio designers have chosen Aluminum Box Shields because *Aluminum Shielding* most efficiently performs the following functions, all of which make for better quality, greater selectivity, closer tuning—finer reception in multi-stage receivers:

1. Reduction of interference.
2. Elimination of electrostatic and electro-magnetic interaction between various stages of radio-frequency amplification.
3. Elimination of "hand capacity" on tuning dials.
4. Elimination of modulation of radio-frequency stages by feedback from audio-frequency amplifier.

Aluminum Company of America's standard box shields, designed especially for amateur sets, are made of heavy Alcoa Aluminum with satin-dip finish, size 5 in. x 9 in. x 6 in. high. They are easy to assemble, require no soldering and are permanent and attractive in appearance.

If your dealer cannot furnish you with Standard Aluminum Box Shields write us and we will see that you are supplied.

Send for free copy of the book, "Aluminum for Radio."

ALUMINUM COMPANY OF AMERICA

ALUMINUM IN EVERY

COMMERCIAL FORM

2439 Oliver Building



Pittsburgh, Pa.

**ALUMINUM
SHIELDING**
for Improved Reception



Cunningham RADIO TUBES

*The Name Means
Everything*

STRICT vigilance guards the acknowledged high standards of these tubes with an ever-increasing efficiency of performance.

Old or inferior tubes should be replaced at least once a year with correct new ones.

E. T. CUNNINGHAM, Inc.
NEW YORK CHICAGO SAN FRANCISCO



an average choke, and these losses will occur at the set and not at the expense of neighbors. Perhaps, now, it is understood what is meant. The statement that the "fundamental was reduced 50%" is entirely erroneous as is evident from the preceding.

All data recently published in *QST* for transmitter chokes, evidently also makes use of parallel resonance, since a one-half inch coil, one inch long, for instance, has a rather small reactance even at 30 meters, considering it as a pure inductance; such a choke serves very well, however. The resistance of coils like this may be found to be considerable due to bad form factor, et cetera. It would seem that chokes should be designed for *voltage*.

The choke mentioned by Mr. Dingley is another good guess. None of us know enough about it to state definitely what choke is best. All we can hope to do is give results of experiments and some day combine the entire available results into a choke, designed for a particular set of conditions. This choke might be a correct guess, in the light of Lidbury's paper, although no frequency range for effective operation is given.

Some chokes consist simply of parallel resonance circuits coupled together by mutual inductance and the "hollows" as shown so well by Mr. Lidbury's experimental results, are due to "series resonance" effects; one or more of the distributed capacities is in series with an inductance, the combination being resonant at the particular frequency. In one of his chokes, these hollows are greatly reduced by winding the choke in sections, that is reducing the mutual inductance between sections by separating them. It was pointed out in our contribution, that the unused turns in the "tuning coil" should be kept small otherwise there would arise a "coupled circuit" effect.

It seems to be the order of the day to make guesses as to a possible solution of the transmitter choke problem, therefore our guess is the choke shown in Figure 1, which will be called a "crankshaft" choke.

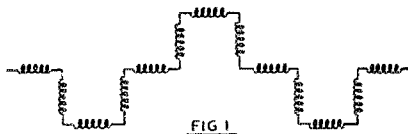

Starting with, say, 40 turns of fine wire, each other section added should have an additional ten turns or so; the idea is to have an arrangement doing some business at almost any frequency. Possibly someone will furnish some measurements.

Mr. Dingley states that a good procedure would be to space the turns about one wire diameter apart and wind them on a small diameter tube. The inductance

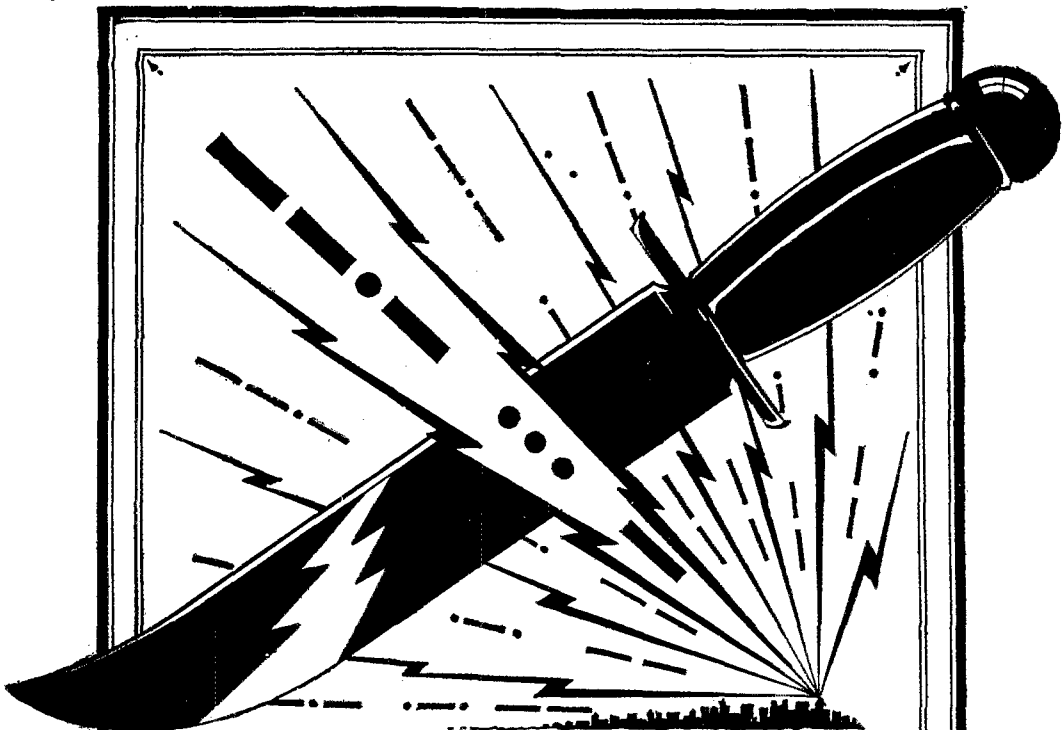

KNIFELIKE SELECTIVITY

CUT THRU THE QRM ON THE NEW NARROW WAVE BANDS with a receiver equipped with **CARDWELL TYPE "E" Tapered Plate Condensers**. Heavy, rigid, cast plates cannot vibrate, eliminating signal wobble from this source.

PIERCE THE FOG OF INTERFERENCE WITH **CARDWELL HEAVY DUTY TRANSMITTING CONDENSERS**. Thicker, sturdy plates, polished and buffed, are always in adjustment, have maximum breakdown limit, and are considered First Essentials in the Efficient Transmitter.

For the Short Wave Receiver

Type 167E00015 Mfd. \$4.00
 Type 168E00025 Mfd. 4.00

For the Transmitter

Type 164B . .00025 Mfd. . For 50 Watters \$7.00
 Type T199 . .0003. Mfd. . For UX-352's 10.00
 Type T183 . .00011 Mfd. . For powers up to 1/4 K. W. 10.00

FOR MAXIMUM EFFICIENCY
 CARDWELL FOR CONDENSERS

The Allen D. Cardwell Mfg. Corp.
 81 PROSPECT STREET BROOKLYN, NEW YORK

"THE STANDARD OF COMPARISON"

Get into the COMMERCIAL RADIO FIELD where the MONEY IS

We've had hundreds tell us that they knew radio backwards and forwards. Yet they enrolled in our courses. And a few weeks after they started to learn radio the RIGHT way these same men told us that they never realized how much they had been missing right along.

Maybe you too have sufficient radio knowledge to build a few radio circuits. That isn't enough to make a real commercial success. What you really need is a course that takes you from the first elements of radio right through the most complex stages and gives you the practical knowledge you need for commercial work.

RADIO INSTITUTE SPONSORED BY RCA, G-E AND WESTINGHOUSE

The Radio Institute of America is the world's oldest radio school, giving the finest and most comprehensive instruction obtainable. Our graduates are making real money—we'll send you copies of some of the letters they write us about their successes.

STUDY AT HOME

Another feature of this course is that you can study at home—when you please and as long as you please. No need to give up your present employment. No time lost traveling back and forth to classes. Our new booklet tells how others—just like yourself—have won success in radio, and how you too can make this profession of fascinating brain-work your life career. You owe it to yourself to read this book through. If you will clip and mail the coupon, we'll send the book to you.



RADIO INSTITUTE OF AMERICA Dept. D-5
326 Broadway, New York City

Please send me your booklet.

Name

Address

.....

of a spaced winding is unfortunately rather low and a spaced winding is difficult of construction when there is a lot of it and fine wire.

The contribution besides suggesting a practical solution is evidently bringing to light, as it were, men who are interested in the same problem. May we have some comment, possibly in the form of an article, in the near future from Mr. Dingley and others?

The problem, as all problems appearing in the Experimenters' Section of the magazine, is merely off to a good start and is far from solved; there are many angles. There is no doubt that a "properly operated and designed" tuned choke has many advantages.

—A. Binneweg, Jr.

33 Sugar Street,
Niagara Falls, New York.

Editor, *QST*:

I have just received this morning from Mr. Binneweg, Mr. E. N. Dingley, Jr.'s letter of November 1st, 1927, on the subject of r.f. chokes.

I don't know whether the seventh paragraph of Mr. Dingley's letter has reference to my report in *QST*, October, 1927, page 27. Practically, Mr. Dingley's conclusions are the same as mine (loc. cit., page 29, numbered paragraph 2). He is, however, very indignant at the idea of using such a choke at its natural frequency; on the other hand my measurements indicated clearly that such chokes worked best at and near that frequency.

Perhaps we mean different things by the term "natural frequency". I was careful to define it as the frequency "at which the choke has no effect when shunted across the tuning condenser of an oscillating receiver". I am inclined to think however, that we mean the same thing.

If we do, I should like to ask Mr. Dingley whether he considers that such chokes should be worked above or below their natural frequency; and whether he can adduce any experimental evidence to back up his opinion.

My guess is that he got a little confused, and can't see the wood of impedance because he has got his eye glued exclusively on the tree of circulating current losses. After all, however much damage Mr. Binneweg's condenser may do, his inductances would not be very efficient r.f. stoppers by themselves!

In any event, the question of the efficiency of chokes around their "natural period" is fortunately susceptible of determination by measurement. An abstract of the experimental evidence indicating efficient operation around this point was published in the article above referred to; and I shall await with interest any experimental results which Mr. Dingley can adduce which indicate the contrary.

—F. A. Lidbury, 8BAG.

Let us Send You This Book!

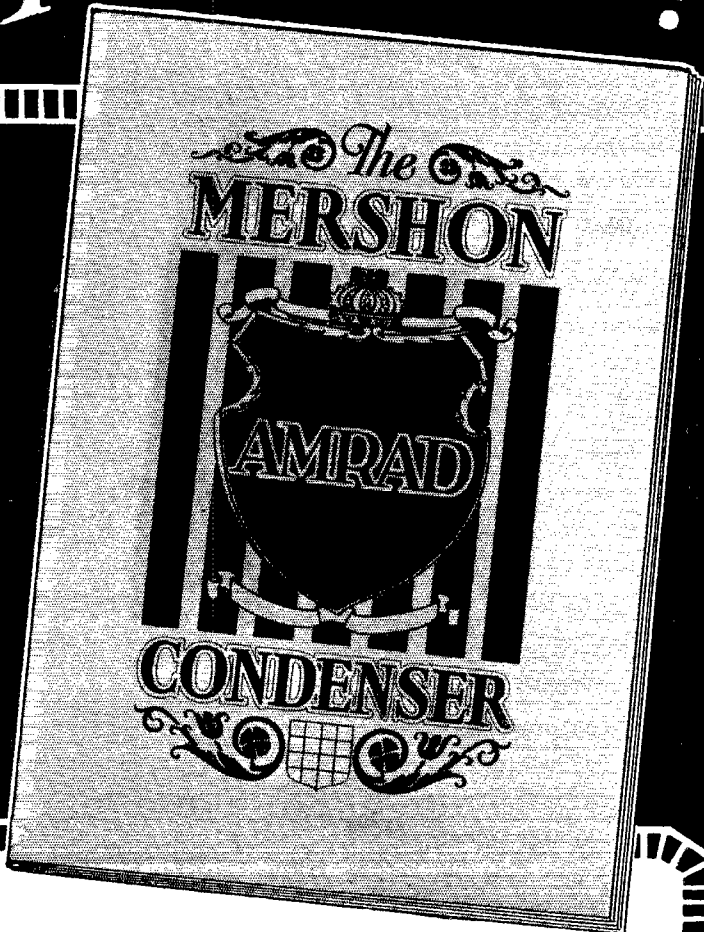

For "B" Eliminators, Power Supply and Filter Circuits, nothing compares to the Amrad Mershon Condenser, which is self-healing, absolutely unaffected by weather conditions, and has extremely high capacity in extremely small space.

Let us send our new book, showing hook-ups
and explaining the many uses of Mershon.
Address Department 28

The AMRAD Corporation
Medford Hillside, Mass.

J. E. HAHN,
President

POWEL CROSLY, JR.
Chairman of the Board

Repairing Tubes

would not pay unless the design and structure of tube were changed so as to make them function on short waves. In every repair job we make the tube conform to best modern practice—and we guarantee satisfactory operation.

Our 50-Watt Tube

Type 203—using Tungsten Filament at 10 volts and handling 150 mils at 1500 volts is low priced at \$20.

Our Rectobulb

For Hi-Voltage Rectification—handles power up to 250-watt tubes—will carry 250 mils at 3000 volts—easily filtered to pure DC. Price each \$15.

For Small Rectifiers

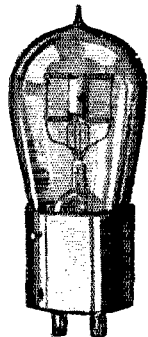

A limited number of tubes—TB-1 Kenotrons—made for U. S. Army—in original cartons with standard bases—will handle 750 volts and pass 50 mils—filament volts 8-10. FB for that 210 Xmitter and also for B Eliminators. Price \$1.00 each.

Inductions

For 20-40-80 meter bands \$2.50.

We Repair

UV-203 at \$15.00 UV-204 at \$50.00
UV-203A (Tungsten Fil) \$19.00
UV-204A (Tungsten Fil) \$50.00

Water cooled Tubes and Rectifiers: ask for prices All work Guaranteed against defects. No charge for Crates when cash accompanies order.

National Radio Tube Co.

(6EX) 3420 18th St., San Francisco. Cal.
(A Ham Institution)

More on Rubber Stamps

431 East Willow Grove Ave.,
Chestnut Hill, Philadelphia, Penna.

Editor, *QST*:

On page 68 of the February, 1928 number of *QST* there is a letter from Mr. Theo. R. Lowenthal, of Chicago, under the heading of "Rubber Stamp" which, to me, deals with a subject worthy of consideration and careful analysis.

Two or three stations in this vicinity who are O. R. S. and, therefore, pledged to forward all messages received within forty-eight hours have become very fussy on the subject of so-called rubber stamp messages. Their attitude, I gather, is that if a message looks to them to be one of this class, then it automatically drops off the table into the wastepaper basket, so that their hands won't be soiled thereby. Incidentally, these stations are the poorest local traffic handlers, and couldn't be paid to run a daily schedule for even one month.

While my sentiments are the same as those of Mr. Lowenthal, I want to emphasize one point more strongly: Messages moving by amateur radio are definite communications from one person to another. How well the sender knows the addressee is not known to any station handling that message, nor can these stations be aware of any special significance of any of these messages, which, actually, are private and personal missives.

Who, then, is so highly informed that he can be the censor of ideas passing between two persons? Who is so intellectually perfect that he can read the full meaning from the words of a passing message and, being one of this higher type of beings cast this message aside as containing some inferior idea?

If we were all perfect message writers, a millennium would have been reached, but we're not. You know how sore it would make you if some crank filed one of your messages in the trash. Be reasonable and helpful instead of short-sighted and watch the gang follow a good example.

—John B. Morgan, 2d, 3 QP.

Budget

109 West Third Street,
Long Beach, Calif.

Editor, *QST*:

It seems to me that a good many amateurs do not have a definite policy as to their plans and actions with regard to amateur radio. Certain plans and procedures have been worked out for station 6AM which may prove of interest to others.

First, a definite sum or budget is set aside each month to spend on the radio set. Originally, this sum was five dollars a month, and with five dollars a month station 9DR was built. Later, it was changed to ten dollars a month and with this amount radio station 9ZT came into prominence. The amount has now been raised to twenty-five dollars per month and 6AM is the result.

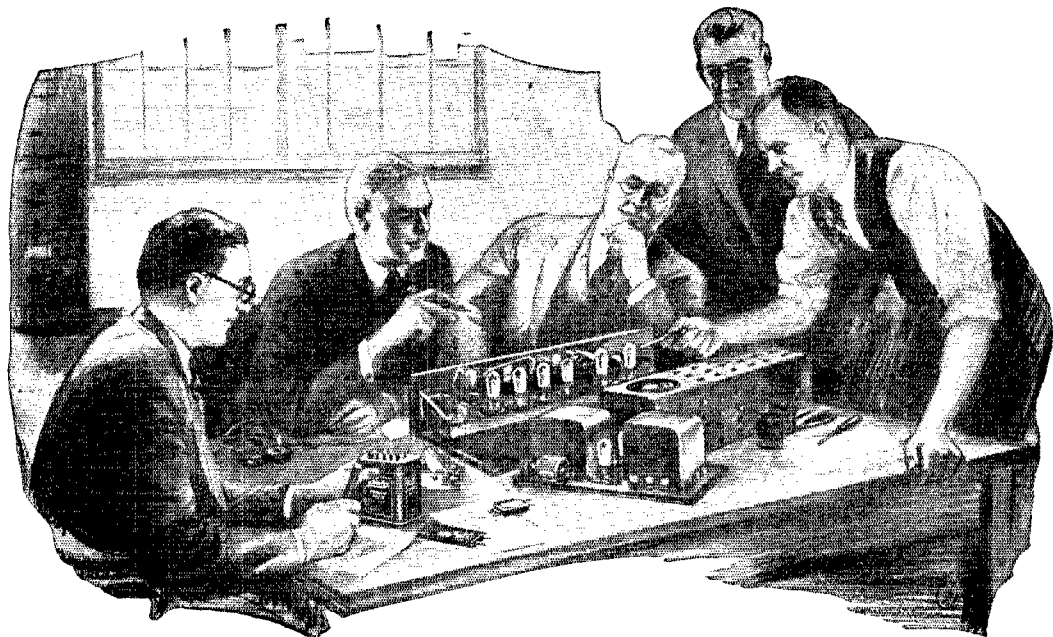

When Advanced Sets are Planned

Whenever and wherever new models or improved specifications are under discussion, the use of Faradon Capacitors occasions favorable comment.

There are more than 200 types of Faradon Capacitors ready for prompt delivery. If your needs cover special requirements not met by regular stock, our engineering department stands ready to serve you in every way.

WIRELESS SPECIALTY APPARATUS COMPANY
Jamaica Plain *Established 1907* Boston, Mass., U.S.A.

Faradon

Electrostatic Condensers for All Purposes

Say You Saw It In QST—It Identifies You and Helps QST

NATIONAL

VELVET VERNIER DRUM DIAL TYPE F

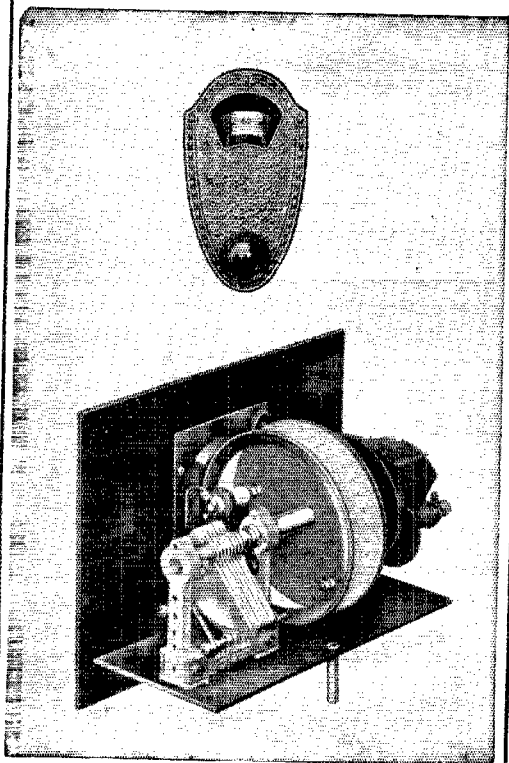

NEW in design, but with the familiar NATIONAL Velvet-Vernier Tuning. Made to USE and to last. Full 360 degree motion.

Visible portion of dial inclined upward for easier reading. Easily attached. Ask for Type F.— Price \$4. Type 28 Illuminator 50¢.

Send for Bulletin 121-Q

NATIONAL COMPANY INC.
MALDEN, MASS. W. A. READY, PRESIDENT

NATIONAL RADIO PRODUCTS

All of this has worked out far better than trying to spend a certain definite sum without the intention of spending more from time to time. A certain amount spent each month for radio rather than for other things in the entertainment line will be conducive to further interest inasmuch as one who has it, can always think ahead a little bit and know just how he is going to spend that money to best advantage. The main thing is to spend it after the budget has been fixed. What has been the problem here for the most part is to determine just where the money should be spent, inasmuch as the set is rather complete at all times.

Certain other definite policies should be incorporated into the play of the station. For those who have other interests besides amateur radio, a definite time to stop amateur radio is necessary. The stopping of all amateur interests at 8 p. m. works very well for a married man, we find. Just about that time, Mrs. 6AM gets through washing the dishes and then we have the evening free. It does not interfere in the slightest with the operation of the station and, in fact, merely whets the appetite for further operation at other times.

Usually by getting up half an hour early in the morning, several foreigners may be worked before breakfast. This also does not interfere with the household arrangements. One night a week is set aside for all-night operation. This naturally falls on Saturday night here, and thus can be counted on. With one night a week all-night operation, maximum interest and results are assured. A few hours on 20 meters on Sundays rounds out the week in fine shape.

We all know how amateur radio gets the best of all of us at some time, and some amateurs have found it necessary to discontinue their amateur sets altogether because of the fact that they could not attend to their business or school work or whatever else they had to do because of the over enthusiasm shown in their amateur work. A suitable compromise such as outlined above will solve this and still keep the station in active operation.

It is a well known fact that every man should have a hobby and amateur radio is, without a doubt, the best hobby possible. A few rules of good sense as applied to the particular individual making them, will make that hobby even more interesting and useful.

—Don C. Wallace, 6AM.

Correction

Editor, QST:

Houston, Texas.

In my paper published in the March issue of QST entitled *Radio Applied to Petroleum Prospecting*, I gave the impression that time measurements accurate to one fifth of one second were sufficient for correct interpretation of records. As a matter of fact, this is not exactly correct, and I should like to amend it. In actual practice, an accuracy within .01 of a second is usual. This, of course, in no way affects the principle of operation as outlined, but is a technicality which should be corrected.

—Gerald R. Chinski.

POWER SUPPLY For TRANSMITTERS

Complete Rectifier Units Supplying Plate and Filament Voltages

OUTPUT RATINGS

Plate Supply - - 2000
Volts D. C. at - - 300
Watts (150 Mils)

Filament Supply - - 10
Volts A. C. at - - 80
Watts (8 Amps)

Employs Standard
UX-852 Tube.



A COMPLETE power supply for the medium power Amateur Transmitters using either telephone or telegraph. Ready for immediate use. Plugs into the ordinary light socket. Operates from 110 volt, 50 to 60 cycle, single phase alternating current power source, supplies sufficient power for operating either one or two UX-852 tubes or one UV-204A tube or any other tubes having similar characteristics.

COMPRISES Plate Transformer—Separate Filament Transformer—Two 30 Henry Filter Choke Coils—Three 2 Mfd. 2000 Volt Filter Condensers—One UX-852 Tube Holder—Pilot Light Control Switch—8-Foot Connecting Cord and Plug—Housed in heavily constructed metal case which is finished in black crystalline lacquer—Plainly marked Terminal Panel—Employs One Standard UX-852 Tube in a Conventional Half Wave Rectifier Circuit.

Dimensions—20 in x 9½ in. front x 13 in. deep—Weight 40 pounds net.

Rectifier Unit—Cat. 172—Price \$85.00.

Price does not include UX-852 Tube.

POWER SUPPLY FOR LOW POWERED TRANSMITTERS

General design similar to Cat. No. 172 except smaller dimensions—Output Plate Supply 400 Volts D. C. at 40 Watts (100 Mils)—Filament Supply 7.5 Volts at 2.5 Amps—Sufficient Power to operate two UX-210 Tubes—Employs one UX-281 Rectifier Tube.

Rectifier Unit—Cat. 185—Price \$38.00.

Price does not include UX-281 Tube.

REL owns and operates experimental Station NU2XV on 15.1, 30.2, and 60.4 meters

Radio Engineering Laboratories



100 Wilbur Avenue, Long Island City, N. Y.



30,000 COPIES

AND NOW THE

5th PRINTING OF THE

Radio Amateur's Handbook

THE RADIO AMATEUR'S HANDBOOK first appeared less than a year and a half ago. Our expectations, based on the sales of other Radio books, were greatly exceeded. No other book was ever received with such acclaim by the radio world. The result has been that printing after printing has been rushed off the presses to supply the demand.

Thirty Thousand Copies are Now in Use

We believe that The Radio Amateur's Handbook, by F. E. Handy, Communications Manager, A.R.R.L. is the most valuable book which any amateur or experimenter could own. Its chapter headings will give an idea of the thoroughness with which the subject is covered. They are "What Is An Amateur?", "Getting Started", "Fundamentals", "How Radio Signals Are Sent and Received", "Building a Station—The Receiver", "The Transmitter", "Power Supply, Keying and Interference Elimination", "Antennas", "The Wavemeter—Radio Measurements", "The A.R.R.L. Communications Department", "Operating a Station", "The Experimenter".

These chapters each occupy from ten to forty pages—indicating that each subject is treated in a thorough manner. In addition there is an appendix containing a fund of useful data. Then there is an index, occupying six pages, by which the valuable information contained in the book is made available. This is a particularly important point and has been compiled and cross-indexed with great care and thought. Altogether the book contains 256 pages of the most valuable radio information ever found between two covers.

The Radio Amateur's Handbook starts at the beginning and tells what an amateur is, what the League is, what amateur radio is, how to become an amateur, how to learn the code, how to understand what you hear, how to get your licenses, how to build a simple station, how to build a better station, how to operate your station, how the A.R.R.L. works, how to handle traffic, how to conduct experiments and make measurements, and a multitude of other things too numerous to mention.

Anyone who is at all interested in the technical side of radio can ill afford to be without The Radio Amateur's Handbook.

*If you haven't
a copy of The Radio
Amateur's Handbook you
are missing the largest dollar's
worth in radio today.*

**DO IT →
NOW**

AMERICAN RADIO RELAY LEAGUE,
HARTFORD, CONN.

Dear Sirs:

Enclosed find my dollar. Please send postpaid (anywhere in the world) my copy of the Handbook.

Name

Address

.....

YAXLEY

APPROVED RADIO PRODUCTS

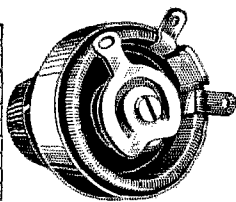
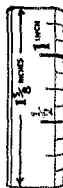

Junior Rheostat

A Junior Rheostat made to a standard. The most rugged and dependable design and material. Large radiating surface. Smooth operation. Furnished in all sizes in both rheostat and potentiometer.

Rheostats 75c each
 Potentiometers to 400 ohms \$1.00 each
 Switches, furnished separately, fit all Yaxley Junior Rheostats and Potentiometers 40c each

At Your Dealer's
Yaxley Mfg. Company
 Dept. Q, 9 So. Clinton St. Chicago, Ill.

- Italy—Associations Radiotecnica Italiana, Viale Bianca Maria 224, Milano.
- Jugo-Slavia—U. J. R. A., Zagreb, Tuskanac 15B-22, Jugo-Slavia. (Under cover)
- Great Britain—Radio Society of Great Britain, QSL Section, 53 Victoria St., Westminster, London S.W.1, England.
- Netherlands—I.A.R.U., Hoogduin, Noordwijk, a/2, Netherlands.
- New Zealand—New Zealand Association Radio Transmitters, P.O. Box 779, Auckland.
- Poland—QSL Section, J. Ziembicki, Manager, Lwow, Bielowskiego 6, Poland.
- Portugal—Rede Emissors Portugezes, Tenente Eugenio de Avillez, 15 Costa do Costello, Lisbon, Portugal.
- Spain—Association EAR, Mejia Lequerica 4, Madrid, Spain.
- Suomi—See Finland.
- Sweden—Foreningen Sveriges Sandaramatorer SSA, Svenska Radeaoklubben, Hamngatan 1 A, 3 tr., Stockholm, Sweden.
- Uruguay—Casilla de Correo 37, Montevideo, Uruguay.

STATIONS WORKING BELOW 100 METERS

- 10. 1RG, "Radiogiornale", Lake Como, Italy.
- 11. AGK, Nauen, Germany.
- 12.25 AGA, Nauen, Germany.
- 13.5 POF, Nauen, Germany.
- 13.5 AGA, Nauen, Germany.
- 13.88 WND, Ocean Township, N. J.
- 14. KDKA, East Pittsburgh, Pa.
- 14.08 KWE-KEWE, Bolinas, Calif.
- 14.09 2XBC-WBU, Rocky Point, N. Y.
- 14.1 KEL, Bolinas, Calif.
- 14.13 WQA-WEQA, Rocky Point.
- 14.25 AGA, Nauen, Germany.
- 14.28 FW, Sainte Assise, France.
- 14.29 KMM-KEMM, Bolinas, Calif.
- 14.4 KSS-KESS, Bolinas, Calif.
- 14.8 WGG, New York.
- 14.8 WQQ, Rocky Point.
- 14.85 WQX-WEQX, Rocky Point.
- 14.91 WQY-WEQY, Rocky Point.
- 14.93 2XS, Rocky Point.
- 14.95 AGA, Nauen, Ger.
- 15. GLS, Ongar, England.
- 15. eg2BR, Chelmsford, England.
- 15. 2XAW, Schenectady, N. Y.
- 15. CH, Quilicura, Chile.
- 15. PUC, Curacao.
- 15.08 YNB, Capetown, S. Africa.
- 15.5 SPU, Rio de Janeiro, Brazil.
- 15.576 SPU, Santa Cruz, Brazil. (Beam)
- 15.641 PQW, Alfragide, Lisbon, Portugal. (Beam)
- 15.7 WFX-WEFX, Rocky Point.
- 15.707 GLW, Dorchester, England. (Beam)
- 15.707 GLG, Royal Air Force, Henlow, Eng.
- 15.740 GLG, Royal Air Force Henlow, Eng.
- 15.86 WDS-WEDS, Rocky Point.
- 15.93 WHR-WEHR, Rocky Point.
- 16. AGA, Nauen, Ger.
- 16. WSS, Rocky Point.



with

2CNM

for HAM PARTS

Pilot Short Wave Plug-in Coils

Range 20 to 200 meters

Coils are wound with No. 16 wire spaced the diameter of the wire and wound on a thin celluloid form. The form touches the wire only at the extreme bottom insuring firm support and low dielectric losses.

QSO

Coils with mounting and hook up ready to use \$4.25

QSB FLETHEIM FILTER CONDENSERS

Equipped with porcelain insulated terminals.

	Working Volts	650	1500	2500
1 mfd.		\$1.69	\$2.39	\$4.39
2 mfd.		2.59	4.09	7.49
4 mfd.		4.19	6.59	12.98

Write for catalogue. All condensers guaranteed against breakdown.

SANGAMO

.002 Mfd. 5000 volt Blocking Condenser	\$1.49
AERO SHORT WAVE TRANSMITTING INDUCTANCES	
20-40-80 Meter Coil Kits	\$8.85
R.E.L. Transmitting Inductances	3.50
Amertran Choke No. 709 120 MA 20 Henry	4.45

ELECTRAD WIRE WOUND RESISTANCES

	25 Watt	50 Watt	75 Watt
5,000 Ohms \$.69	\$1.19	\$1.39	\$....
10,000 Ohms .85	1.39	1.59
20,000 Ohms	1.49	1.69

Resistances with center tap 10c extra. All resistances in stock including 75 watt type. These resistances are for Gridleaks. 20% discount on all sizes.

Acme No. 12 solid copper enameled wire. Most efficient for shortwave antennas \$.69

Cunningham Tubes OX 310 6.29
 CX 381 5.29

Hot Centralign Condensers .00015 1.95
 .00025 1.10

EVERYTHING IN HAM PARTS. Full line Weston DC and AC Meters, 10% to 20% discount. Mail orders given immediate attention. Money order or certified check must accompany all orders. No C. O. D.

Write or QSO 2CNM on 40M for a catalogue and prices.

FANMILL

FANMILL RADIO CO. INC.

62 CORTLAND ST.

A Safe Place to Buy Radio

VITROHM Transmitting Grid Leaks and Rheostats now cover the entire line of transmitting tube circuits. ¶The prices on these amateur products are reduced materially. ¶Your dealer should stock Vitrohm Transmitting Products. ¶If you have difficulty in obtaining them, write us direct.

CATALOGUE NUMBER	PRODUCT	RESISTANCE	DISSIPATION	CURRENT	MAX. TUBE RATING	PRICE
507-2	Grid Leak*	5000 ohms	44 watts	90 m.a.	100 watts	\$2.00
507-3	Grid Leak*	5000 ohms	200 watts	200 m.a.	1000 watts	2.80
507-4	Grid Leak†	50,000 ohms	200 watts	60 m.a.	1000 watts	6.50
507-5	Grid Leak†	20,000 ohms	200 watts	100 m.a.	1000 watts	4.25
507-51	Grid Leak*	10,000 ohms	200 watts	135 m.a.	1000 watts	4.00
507-66	Grid Leak**	15,000 ohms	200 watts	120 m.a.	1000 watts	6.00
507-63	Rheostat†*	50 ohms	50 watts	1 amp.		5.50
507-59	Rheostat**†	20 ohms	80 watts	2 amp.		5.50
507-83	Rheostat**†	12.5 ohms	60 watts	2.2 amp.		5.50

* Center-tapped
 † DeForest P or R. C. A. 852 Tube
 De Forest H Tube

** Steps at 5M—10M—15M
 for R. C. A. 852 or DeForest P Tube
 †† For Primary Control
 *† Filament and Primary Control

Ward Leonard Electric Company

37-41 South Street

Mount Vernon, N. Y.

60

MICROFARADS

FOR \$4.⁰⁰

GENUINE AMRAD MERSHON CONDENSER

Type S 60-Glass Jar-60 Microfarad-200 Volts

The only type of condenser which automatically repairs itself if accidentally punctured by too high voltage.

The Type S-60, Glass Jar Mershon Condenser has a capacity of 60 µfd. and will operate on voltages up to 200. Two may be connected in series for operation at 400 volts, giving a capacity of 30 µfd. With such large capacity it is necessary to use only a very small choke and some sort of rectifier to obtain beautiful d.c. for a 210 tube.

It will improve any 'B' Eliminator by taking out a.c. hum and improving quality.

Booklet giving diagrams and full instructions packed with each condenser. Shipped same day order is received. \$4.00 each, postpaid. Cash with order. List price, \$8.00. Reference: Industrial Bank and Trust Co., Boston.

GORDON R. BADGER, Inc., 40 Court St., Boston, Mass.



Amateurs-- Experimenters

WIRELESS EGERT has served amateurs faithfully for the past eight years. Let us serve you. We can supply you with any amateur material at a real price.

We carry a complete line of

**General Radio, Acme, Parvolt,
Flechtheim, R.E.L., Faradon, Thordar-
son, Signal, Weston, Amertran, etc.**

A set of real Short Wave Coils using Hammarlund D. S. Coil and G. R. Plugs. Incl. Pri., Ruse, 20, 30, 50
Meter Coil \$3.00
Extra Coils 2.95

The Real Resistor

A resistor for every need. We carry a complete line of Ward-Leonard products.

	44 W. 200 W.	
5,000 Ohm	\$1.60	\$2.24
10,000 Ohms	1.80	3.20
15,000 Ohms	1.95	4.80
20,000 Ohms for		
U.X. 352	3.40	
50,000 Ohms for		
De Forest P		
Tube	5.20	

Transmitting Inductance 10cturn.

Every Type of Power Trans-
former Available. Thordar-
son T2098 with 550V full
wave with 2-7½V. windings. \$13.75

Acme 200 Watt for a 210
transmitter with 350-750V.
full wave windings. and 2-
7½V. windings \$16.75. Also
Condensers, Transmitting
tubes, chokes.

FREE: Short wave and transmitting catalogue plus our dis-
count sheet. Mail Orders promptly filled. Include postage.

WIRELESS EGERT

179 Greenwich St.

New York City

- 16. NKF, Rocky Point.
- 16. JPP, JYB, JYZ, Tokyo, Japan.
- 16.02 WTT, Rocky Point.
- 16.02 2XG, Rocky Point.
- 16.077 VNB, Klipheval, S. Africa.
(Beam)
- 16.146 GBJ, Bodmin, England. (Beam)
- 16.17 2XT, Rocky Point.
- 16.216 GB1, Grimsby, England. (Beam)
- 16.286 VWZ, Kirkee, Bombay. (Beam)
- 16.3 VWZ, Poona, India.
- 16.35 WND, Ocean Township, N. Y.
- 16.41 WEM-WEEM, Rocky Point.
- 16.49 WLL-WELL, Rocky Point.
- 16.49 NPG, San Francisco, Calif.
- 16.501 CG, Drummondville, Montreal.
(Beam)
- 16.574 GBK, Bodinin, Eng. (Beam)
- 16.6 WLL, Rocky Point.
- 16.7 KNW, Palo Alto, Calif.
- 16.71 WBQ-WEBQ, Rocky Point.
- 16.78 WQC-WEQC, Rocky Point.
- 16.93 KUN-KEUN, Bolinas, Calif.
- 17. SPI, Rio de Janeiro, Brazil.
- 17. cg2BR, Chelmsford, England.
- 17. 2BR, Chelmsford, England.
- 17. NKF, Bellevue Anacostia D.C.
- 17. PCG, Malabar, Java.
- 17. KFUM, SS Idalia.
- 17. KKC, Palo Alto, Calif.
- 17. KNW, Palo Alto, Calif.
- 17.2 KNN, Honolulu, T. H.
- 17.2 AGC, Nauen, Ger.
- 17.3 WKI, Newark, N. J.
- 17.4 ANE, Bandoeng, Java.
- 17.4 ANH, Malabar, Java.
- 17.5 WKC, Newark, N. J.
- 17.5 GBL, Leafield, England.
- 17.5 GBM, Leafield, England.
- 17.5 GBO, Leafield, England.
- 17.7 KFD, Denver, Colo.
- 18. POF, Nauen, Ger.
- 18. PCL, Kootwijk, Holland.
- 18. 1RG, "Radiogiornale", Lake Como,
Italy.
- 18. KTA, Guam.
- 18. ICC, Coltano, Italy.
- 18.094 CRHB, Praia, Cape Verde Island.
- 18.1 CRHC, Loanda, Angola, W. Africa.
- 18.17 WJZ, Bound Brook, N. J.
- 18.182 CRNC, Loanda, Angola, W. Africa.
- 18.27 PQS, Alfragidi, Lisbon, Portugal.
(Beam)
- 18.3 WBQ, Schenectady, N. Y.
- 18.3-18.7 2XAP, New York.
- 18.3-18.7 4XK, San Juan, P. R.
- 18.36 CRHA, Lourenco Marques, Portu-
guese E. Africa.
- 18.62 KEB, Oakland, Calif.
- 18.7 2XAP, New York.
- 18.7 4XK, San Juan, P. R.
- 18.8 AND, Tjililin, Java.
- 19. OLQ, SS Slamet.
- 19.4 ANK, Malabar, Java.

Reached Half Way Around the World!

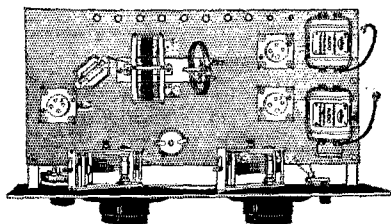

KARAS 3-Tube Short Wave Kit

USES famous KARAS parts! KARAS
Micrometric Dials—smooth, even tuning—
free from backlash—made of Bakelite. No
drilling; only 1 set screw; 2 knobs, rough tun-
ing and vernier. Also KARAS Orthometric
Variable Condensers, built of finest materials—
under precision standards. Greater separation—
broader tuning range! Get complete kit at
dealers (only \$58.95) or write to

KARAS ELECTRIC COMPANY
4030E-N. Rockwell Street Chicago, Ill.
SEND FOR FREE LITERATURE



Permanent Insulating Qualities!

UNAFFECTED by smoke, salt fogs and fumes, constant in their electrical and physical characteristics, *PYREX Radio Insulators give *permanent* insulation for all radio work. They represent the true fusion of materials resulting in a homogeneous, non-porous insulator, uniform throughout its structure—high in dielectric strength—low in power loss.

Dust and dirt cannot accumulate on their original diamond hard and

super-smooth surface. There is no "glaze" to check or craze.

Made in several styles and in various sizes: antenna, lead-in, stand-off bus-bar, inductance shapes, bushings, rods and cylinders.

A treatise on the unique chemical, physical and electrical properties of the special glasses from which these high-test insulators are made will be sent on request. Write for "PYREX Industrial Glass Products".

CORNING GLASS WORKS

Industrial and Laboratory Division, Dept. Q-2

CORNING, NEW YORK

*Trade-mark Reg. U. S. Pat. Off.

To Our Readers Who Are Not A. R. R. L. Members

Wouldn't you like to become a member of the American Radio Relay League? We need you in this big organization of radio amateurs, the only amateur association that does things. From your reading of QST you have gained a knowledge of the nature of the League and what it does, and you have read its purposes as set forth on page 6 of every issue. We would like to have you become a full-fledged member and add your strength to ours in the things we are undertaking for Amateur Radio, and incidentally you will have the membership edition of QST delivered at your door each month. A convenient application form is printed below—clip it out and mail it today.

.....1928

American Radio Relay League,
Hartford, Conn., U. S. A.

Being genuinely interested in Amateur Radio, I hereby apply for membership in the American Radio Relay League, and enclose \$2.50 (\$3 in foreign countries) in payment of one year's dues. This entitles me to receive QST for the same period. Please

begin my subscription with the issue. Mail my Certificate of Membership and send QST to the following name and address.

.....
.....

Station call, if any

Grade Operator's license, if any

Radio Clubs of which a member

Do you know a friend who is also interested in Amateur Radio, whose name you might give us so we may send him a sample copy of QST?.....

..... Thanks!



The NEW CHI-RAD Short Wave Coils
20—40—80 Meter Band

Designed by Chi-Rad engineers to meet the demands for an extremely efficient short wave coil. Complete with mounting, hardware and three interchangeable plug-in coils to cover 20, 40 and 80 meter wave bands. These coils are noteworthy for their convenience in design, neatness in appearance and sturdiness in construction. All plugs give positive contact.

Chi-Rad Short Wave Coils Complete for 20, 40 and 80 meter band Net Price \$7.50
Extra coil for broadcast band Net Price \$2.45
Dealers and Set-builders—write for further details and discounts.

Chicago Radio Apparatus Co.
415 South Dearborn St. Chicago, Ill.

Calls Heard

(Continued from page 81)

fm-8sar fm-8vx oa-2rc od-anc od-anf oz-2bg oz-3au
oz-4am op-kzet uw-8ay nem abl nujj suc vlk amc
glw fnj2 fmb hbc hjg oxx pie pii soua shln sqcl trl
8vay.

(80 meters)

1bjk 1byc 1pe 1wf lybc 2cxl 2dv 2jn 2mzw 4pac 8xe
nc-1bh ea-ohk2.

**BR8-26, A. S. Williamson, 106 Rushdale Road, Meers-
brook, Sheffield, England**

(Heard during February)

(80-Meter Band)

lid lkv 1vw 1sw 1jc 1mr 1fr 1sl 1ad 1mk 1pi 1yb
1adw 1cdd 1cmd 1cmi 1acm 1bub 1bck 1caa 1ctj 1axa
1ajg 1asi 1api 1crx 1ajp 1aef 1ahk 1aur 1aur 1ajt
1bjk 1aom 1asi 1apk 1bpw 1era 1asd 1aif 1ane 2aif
2bfp 2bgm 2bfi 2aiz 2ayg 2hfd 2aoo 2bnv 2ezr 2ebp
2elf 2bop 2cxl 2cin 2epd 2afv 2arv 2ac 2jn 2tt 2cp
2ts 2sn 3jn 3uz 3ca 3am 3ru 3cah 3ca 3ade 3adm
3afa 3bfp 3aau 3awu 3bit 3aqi 3akv 3acu 3bwt 4acd
4zf 4vr 4sp 8br 8br 8at 8bc 8cds 8bcm 8bcz 8bha
8bas 8cnz 8dmz 8doz 8vz 8vk 9dbl 9elk 9kix 9ym 9ox.

(20-Meter Band)

lfa 1bw 1cd lar 1gp 1fl 1sw 1sz 1vs 1fn 1pm 1vc 1zz
1ry 1hw 1ic 1qp 1vh 1lh 1my 1rp 1lj 1cx 1xy 1od 1pe
1zt 1jl 1ka 1nf 1bhs 1aep 1bfg 1cmf 1cmp 1aqt 1aff
1bbr 1axa 1atj 1cje 1cbh 1afz 1onp 1ber 1aur 1aba
1bhm 1asu 1cmj 1aef 1afj 1alr 1arf 1bed 1bad 1bat
1ako 1bvm 1aqa 1adl 1ajl 1akz 1aao 1adm 1ds 1akm
1axx 2tp 2va 2vi 2gp 2bg 2at 2jn 2nx 2ol 2dr 2ch
2mt 2aol 2bay 2xad 2avs 2akz 2chi 2adk 2afv 2xc
2abr 2afa 2eug 2bgt 2amg 2bum 2acn 2awf 2bnc
2bha 2bvg 2hf 2sh 2hw 2za 2xp 2wr 2nr 2hi 2dg 2bbz
2cec 2apx 2adm 2bod 2bl 2xk 2co 2sb 2hn 2ba 2xe 2vg
2xg 2gz 2eug 2cuj 2ahc 2box 2axz 2bn 2ad 2adm
2den 2adg 2chi 2bhv 2bet 2axa 2cbi 2dix 2bau 2cnh
2ext 2dsa 2agv 2ad 2dij 2cil 2elp 2air 2ary 2ek 2ez
2emp 2ayp 2c-ar 2c-lam 2c-lap 2c-lad 2c-2be
fm-8rit af-1b wnp hjp spj pn wl gkt gky.

(40-Meter Band)

lfi 1fr 1jk 1kk 1sz 1ga 1dl 1ja 1br 1cx 1om 1gr
1mo 1li 1ic 1kh 1wl 1kg 1bw 2vr 1qc 1lx 1rp 1gh 1mx
1ad 1ad 1pe 1cd 1lh 1rf 1ok 1ye 1no 1yc 1id 1vl 1rw
1qf 1ix 1sx 1yb 1ex 1nq 1nt 1rz 1cmi 1bhs 1caa 1bux
1beb 1amd 1bxi 1aaw 1cjc 1cmx 1afz 1avj 1aba 1bqk
1amj 1adz 1bqt 1cpb 1bvi 1ach 1agp 1ahw 1ass 1atz
1emp 1adb 1air 1adm 1ary 1ast 1aqt 1afr 1axx 1cjk
1acv 1cfp 1bw 1akz 1bda 1cek 1awe 1enz 1asy 1aku
1air 1akd 1com 1cex 1bke 1btq 1akm 1apk 1bgq 1bqs
1anz 1acm 1awm 1epd 1ani 1ayg 1ack 1btf 1akx 1bvg
1arv 1bils 1clv 1bvr 1ane 1ajx 1chg 1ate 1bbe 1cbb
1ass 1gw 1ho 2akc 2bdc 2axz 2alu 2ags 2asz 2afv
2bcw 2ang 2biv 2evj 2aut 2buo 2ezr 2aol 2bme 2arl
2aou 2erb 2ayd 2aad 2cuq 2ayn 2adl 2bev 2bbx 2avn
2cxl 2aol 2cty 2baa 2bad 2hov 2bkh 2bhr 2bhd 2auh
2atk 2xaf 2ase 2ava 2beo 2bdf 2bfn 2avb 2bfg 2bda
2agh 2bbe 2bvr 2aon 2afs 2amt 2atp 2awz 2apy 2blx
2bdx 2ani 2ain 2xhc 2alp 2axt 2bek 2aw 2abo 2agd
2ekl 2afo 2box 2aut 2bst 2ary 2alo 2aou 2atq 2anu
2bc 2cmu 2bgt 2ats 2fs 2ef 2rt 2md 2tp 2xs 2wb
2zp 2dh 2ax 2ov 2uo 2kr 2ih 2rs 2dx 2km 2ks 2uy
2zk 2ty 2rg 2za 2wc 2vc 2di 2og 2ja 2zy 2ew 2cfl
2aib 2buv 2add 2anh 2adz 2ani 2afw 2ckj 2big 2caq
2bnz 2dew 2afa 2adp 2bnu 2aed 2cfc 2ais 2bns 2bei
2acm 2caw 2agm 2abo 2awf 2agp 2cfn 2aih 2aig
2auv 2aef 2anb 2bms 2apx 2avk 2alg 2abv 2afx 2adq
2bqp 2amb 2aps 2bpb 2bor 2bwt 2cha 2amw 2bel
2cdq 2ct 2ee 2af 2hf 2rt 2jb 2th 2uh 2im 2hh 2be
2io 2bl 2im 2sh 2uc 2bw 2hw 2vj 2sz 2fz 2jg 2ec 2qt
2bq 2ua 2gl 2acv 2acz 2axz 2axz 2abl 2pac 2aef 2aw
2aep 2ad 2acu 2auo 2db 2nh 2qg 2oh 2qz 2ob 2ax 2ch
2fs 2oo 2st 2ta 2ac 2ci 2at 2si 2bi 2wv 2oc 2lk 2fu
2cj 2ac 2rr 2iz 2nt 2qy 2ea 2dy 2hx 2sv 2ec 2gw
2pu 2il 2nq 2rf 2ft 2ach 2age 2oa 2we 2kg 2ja 2axa
2cnh 2drj 2avw 2dhw 2adk 2ayn 2dne 2bhz 2asg 2sar
2ben 2dei 2dod 2hub 2bdc 2cau 2an 2dne 2dpa 2bdk
2dcm 2vxx 2eft 2sch 2bct 2hou 2don 2dun 2dme 2ams
2btq 2aff 2atv 2axz 2esw 2dps 2bvy 2bbs 2ctx
2ecr 2li 2hx 2nn 2gz 2pl 2ri 2ke 2sz 2lu 2rh 2uj 2im
2jc 2eq 2crj 2cgv 2adk 2axa 2cm 2ndg 2ara 2enk
2bqe 2alm 2grj 2btq 2gpc 2ez 2nt 2dh 2hg 2pd 2bl
nc-lar nc-lad nc-lam nc-lbr nc-2be nc-2bg nc-9bz
nn-1nc np-4sa np-4ac np-3pq np-3ig np-2it np-2ef
ng-2ro ng-2cu ng-6by nr-2fg nr-2to sb-1ah sb-1ak
sb-1aw sb-1ib sb-1ld sb-1cm sb-1hd sb-1bl sb-1bg
sb-1cl sb-1bo sb-2oa sb-2ax sb-2ad sb-2ag sb-2ay
sb-2az su-1wa su-1oa oa-1ah oa-2tm oa-2iu oa-2dy
oa-2sh oa-2yi oa-3ls oa-3ks oa-3kb oa-3ds oa-3cp
oa-3wm oa-3ab oa-3wh oa-3ot oa-3hl oa-3ar oa-3vc
oa-5kr oa-5gh oa-5fk oa-5hb oa-5rj oa-5by oa-7cw
oa-7cx oa-7ch oz-1fk oz-2bg oz-2at oz-2pb oz-2ac
oz-2xa oz-3au oz-3ar oz-3vg oz-3uf oz-3af oz-3az

FROST-RADIO FROST-RADIO FROST-RADIO FROST-RADIO FROST-

FROST-RADIO

ANNOUNCEMENT

At the Radio Trade Show in Chicago the week of June 11 Frost-Radio will announce a new and improved line of Quality Parts. This new line will be well worth waiting for. Descriptive literature will be ready for release on or before the opening of the Show. Have us place your name on our list to receive this literature. Write us about it today, using coupon below. Our two famous booklets, "What Set Shall I Build?" and "For Better Reception" will be sent you immediately. the other literature to follow.

HERBERT H. FROST, Inc.
Main Offices and Factory,
Elkhart, Indiana

Chicago New York City

HERBERT H. FROST, Inc.
160 North La Salle Street, Chicago

Please send me at once your two free booklets "What Set Shall I Build?" and "For Better Reception," and also place my name on your mailing list to receive your new literature when ready.

Name

Street Address

City

FROST-RADIO FROST-RADIO FROST-RADIO FROST-RADIO FROST-



High Resistance Voltmeter

(For the Set Owner)

In the adjustment of his B-eliminator voltages the set owner has been at a disadvantage because of the excessive cost of reliable testing instrument of sufficient sensitivity to give accurate results. This disadvantage has been recently eliminated by the introduction of the Jewell Pattern No. 139 high resistance voltmeter.

Although the price of this instrument is low, it is of the D'Arsonval or moving coil type with the movement swung between genuine sapphire jewels. The full scale value is 300 volts, the scale having 30 divisions. Movement parts are silvered and the scale is silver etched with black characters. The series resistance is wound with fine wire and accurately adjusted to give correct readings at all times. The instrument throughout is of the very highest grade of workmanship.

Dealers carry this instrument in stock, or a descriptive circular No. 1103 may be obtained by writing us direct. Ask for a copy.

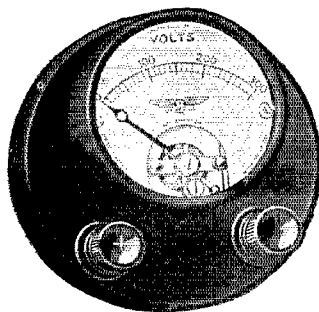

Pattern No. 139

Jewell Electrical Instrument Co.

1650 Walnut St., Chicago

"28 YEARS MAKING GOOD INSTRUMENTS"

Master the Code

Wireless or Morse quickly at home with the

TELEPLEX

Code Instructor



Silent Phonograph Motor

words as any other instrument. Tapes cannot be memorized. Last indefinitely. Avail yourself of the TELEPLEX for a quick mastery of the code. Write for booklet RL.

TELEPLEX CO., 76 Cortlandt St., New York

No better method for self-instruction exists. Quick - Easy - Thorough. Endorsed by U. S. Navy and leading Technical and Telegraph Schools. The only instrument that **REPRODUCES** actual sending of expert operators. Sends messages, radiograms, etc. Any speed. Complete course (6 tapes) **FREE. 30 times as many**

Here's a Handy Dooflicker!

TABLE TYPE CLAROSTAT

REG. U.S.

PAT. OFF.

Just the thing for that short-wave receiver, especially on very short stuff. Gives you remote control of plate voltage, regeneration or stabilization. In fact, you can use it wherever you require variable high resistance of limited current-handling capacity. Just as your broadcast friends use it to control loud-speaker tone and volume from table, easy-chair, davenport or elsewhere.

Finished in statuary bronze and nickel. Felt bottom. Bakelite knob. Two conductor cords and connecting block, for series or shunt resistance. Resistance range of practically zero to 500,000 ohms, in several turns of knob. Micrometric adjustment. Stays put. 7-watt rating. Yours for \$2.50, complete.

Ask your dealer to show you the Table Type, Volume Control, Standard and Power Clarostats—resistance for all your requirements. Or write us direct for the dope.

AMERICAN MECHANICAL LABORATORIES, Inc.

Specialists in Variable Resistors

285-7 North Sixth St. Brooklyn, N. Y.

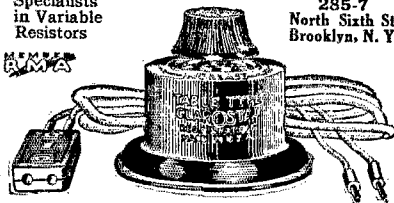

FREE Wholesale Radio Catalog

Our new 1928 catalog is jammed full of the newest offerings of nationally known radio parts, kits, sets, accessories, table and console cabinets, etc. Whatever your radio need may be it's in our 1928 catalog. Also contains *Short Wave Section* showing the finest receiving and transmitting apparatus. Write for this big catalog—and for our confidential discount sheet—but write immediately.

SHURE RADIO CO., 351-H West Madison St. Chicago, Ill.



PRECISION!

Sangamo engineering of Audio Apparatus is followed up by precision production methods gained in nearly 30 years' precision instrument manufacturing. In Sangamo Transformers and Impedances the set builder and manufacturer is thus assured of that precise matching of each unit to the designated tube so necessary for superior tone quality.

The "Yellow Spot"
Designates the Sangamo Type "A" Audio Transformer used for cascade amplification. This transformer has the flattest curve (most uniform amplification at all audible frequencies) available in any transformer at the present time. Look for the transformer with the yellow spot.

"Light Blue"
The Light Blue Spot identifies the Sangamo In-put Transformer for push-pull amplification. Has high inductance primary to secure high amplification on low frequencies. Accurately divided secondary gives almost identical frequency characteristic curve on each half. "Type B" — known by the light blue spot.

"Dark Blue"
Output Transformer for push-pull amplifier having an impedance to match UX-210 (CX-310) and UX-112 (CX-112) tubes. Maximum transference of energy on low end of the musical scale.

All makers of Sangamo Mica Condensers, moulded in Bakelite—made accurate and stay accurate.

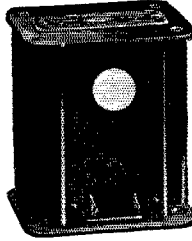

"Green"
Same as above except Impedance matches UX-171 and CX-371 tubes.

"Red"
The Red Spot designates the Sangamo Type "E" Output Impedance. Keeps heavy D. C. "B" current from loudspeaker windings. Tap provided for matching impedance to UX-171 (CX-371) or UX-210 (CX-310) tubes, also UX-112 (CX-112).

"Orange"
Used for impedance coupled amplification, auto-transformer coupled amplification, or as impedance in plate circuit of detector tube to prevent feedback, oscillation or "motor-boating" in transformer coupled amplifier.

oz-3aa oz-3ag oz-3ae oz-4ae oz-4aa oz-4ao oz-4am
oz-4ai ac-ley al-2kx aq-1mdz anf gilky kga kgaa naa
ocdb waoj xda.

BRS-79, D. J. Beattie, 399 Manchester Rd., Burnley, England

(Heard between Jan. 1 and Feb. 15)

ladw lafl lags lamj lata latj latr laxf laxq laxx
lbat lbed lbis lbqs lbqt lbw lcax lcd lcfc lenz lcom lcx
ldc lfo lgh lgw lih lkh lrn lsw lwaq zabb zabz
Zafr Zags Zagw Zang Zaib Zang Zano Zaoj Zard Zavq
Zawu Zaxp Zbac Zbaz Zbck Zbec Zbdu Zbf Zbvf Zbox
Zcgl Zco Zcxl Zfs Zjc Zje Zog Zpv Zqv Ztp Ztv
Zxbc Zxcg Zxib Zxjs Zxk Zxk 3ckj 3gt 3gt 3ss
4bl 4ei 4hx 4rg 8ajt 8avw 8awu 8aya 8bto 8cfa 8dne
8gz 8pl 9caj nc-lav ne-lbr nc-lda nc-2bj ne-8ae
nx-1xl.

F. Pemberton, 115 Cambridge Road, Wimbledon, London S. W. 20, England

(80 meters between Nov. 22, 1927 and Feb. 8, 1928)

labz lafb laig lajt laib lanh lasd lasu lavk lbfz
lbhm lbi lbjk lbhh lbvl lbwm lccw lcdb lced lefy
ldr lgg lbb llj lin ljn lmr lpe lsl ltd lyl lww Zagn
Zagq Zail Zayr Zbfd Zbfj Zbgm Zbif Zbac Zcep Zcp
Zcpd Zctm Zcvf Zcxj Zdv Zev Zgx Zae
Zwz Zade Zafw Zajw Zale Zaob Zaqi Zawu Zbit Zbns
Zbss Zbcg Zuz Zzf Zaan Zacd Zff Zfx Zpac Zqy Zrn
Zwc Zwd Zxe Zacz Zajk Zake Zald Zalu Zapb Zaxr
Zatq Zatr Zayu Zbcm Zbcj Zbec Zbfm Zbgd Zbts Zbyn
Zcfl Zchy Zcmw Zcng Zcns Zcrl Zcdc Zdkx Zdme Zds
Zey Zjb Zkr Zmm Zpt Zain Zbav Zbaw Zbec Zbdt Zbhc
Zbwj Zcpr Zerm Zdae Zdgw Zebso Zhh nc-3dv.

R. A. Rowden, 12 Pennsylvania Road, Exeter, England.

lawe laxa lbss lomp lic Zalu Zbav Zbbx Ztp Zaed
Zagz Zayg Znr Zadz Zagt 4fu 4fr 4rn 4wa 8ahc
Satv Sben Sbox Scnc Scen Scfl Sdal Sdkt Sdmn Sdrp
9arr 9eia 9ejw 9dng 9eco nc-lar nl-gren nr-2ea oa-2dy
oa-4pn oa-5hg oz-3au vpg.

eg-6LI, A. E. Livesey, 15 rue d'Orleans, Pau, B. P. France

(20 meters on March 4, 1928)

laep lbc lber luo Zao Zaal Zdr Zhi Zkw Zbl Zft 4xi
5aq 7az 8adm 8ago 8ak 8apn 8asf 8btr 8ax 8cfr 8cp
9as 9dng 9dpp 9ch 9evh 9hm 9xi.

ef-8FT, R. et A. Aronssohn, 2 bis rue J. Deville—Colombes (Seine) France

(Heard during February)

laac labv laim lakd lakm larv lasf latv laxx
lbbe lbke lbrv lclv lenz ler ldl lex lig lia lkh lwl
lad Zaho Zang Zawi Zaz Zbir Zbox Zcfl Zcvi Zra Ztc
Zty Zue Zur Zvp Zvy Zanh Zaqz Zbnu Zckj Zdh Zhg
Zpf Zqe Zqt Zact Zaez 4ch 4ea 4ft 4fx 4k 4ob 4pe 4pt
Sadg Salu Sbet Sbl Sbm Sck Sdg Sdh Sef Sdkx Skg Szg
9ajt 9baz 9bmw np-4pq np-4sa sb-law sb-2ag sb-5aa
nl-5aa sc-2as fo-pm oa-3ls nk-5cx wnp avw.

ef-RO91, C. Conte, 24, Allee du Rocher, Clichy-sous-Bois (S-e-t) France

(Heard during February)

lajc lakm lamd laoc laqt lauc laaf lbvr lbd0 1als
ledi lemf lctp lex ldl lgh lic lkk llf lmx lrp lwl Zagy
Zard Zate Zass Zaz Zayj Zaxk Zbbr Zbhr Zbp Zcf Zfs
Zhc Zjn Ztp Zty Zwc Zwy Zaaw Zamb Zann Zaq Zbl
Zbgg Zbms Zcfn Zcfn Zckg Zdg Zhf Zpf Zqw Zql
Zsf Zac 4aar 4aep 4acv 4ab 4bl 4cf 4cj 4ei 4gy 4ok
4pe 4we 4wm 5aq 5kg 5oa 5yb 7ek 8adg 8ahc 8asf
8auc 8avd 8ava 8aks 8bjx 8byn 8bwz 8bbs 8cc 8xi
8cjl 8cnx 8cpd 8cgl 8dng 8dme 8dpa 8dps 8hc 8he
9bbw 9ef 9efe 9efo 9eln 9crl 9gj 9beu 9bqe nc-lar wnp.

ex-3ON, Roger Soucasse, c/o R. C. A. 35 S. 3rd St., Phila, Pa.

On board S. S. Ontario, KQO from Boston to Phila. last week of February.

5amm 5aqe 5ayl 5gc 5px 5yb 6ajr 6apd 6bak 6dfv
6eio 7id 7ok 7sj 8agk 8aid 8alo 8cxa 8ane 8anz
8dbh 8vd 8wt 9aj 9bwk 9bhg 9eyp 9drd 9dxx 9eaj
9eht 9pg 9so nc-2be nc-2cz nc-2bb nc-2br nc-3ml nc-3es
nc-4ar nc-4lv nk-5by nk-5ev nk-5qn nk-5ll nk-5wv
gbwz rio apw ir-l glq gby nni nkk nudrd es-1 ad-4
aq deg joek.

5PK, J. F. De Bardeleben, KDOF, S. S. Bessemer City, Isthmian S. S. Lines, 50 Trinity Place, New York City (Heard between Yokohama, Japan and Iloilo, P. I. January 1928)

laek Zuo 5mx 4qr 6avl 8cp 9ehm 9ck 9eun 9ack
o-lmo op-1gz op-lrc op-lad op-3ac op-4aa oa-3lp
oa-3kr oa-3xx oa-4cr oa-4dp oa-5wh nm-56ax aj-4zz
af-lb oz-4aa oz-3nc kzpl kzpe jyb jbk jaa jan jph jes

SANGAMO ELECTRIC CO. SPRINGFIELD, ILLINOIS

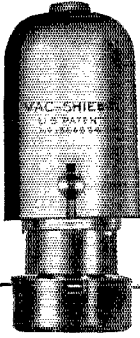

**To Make Your Set 100% Efficient
You Should Use
Patented Non-Magnetic "VAC-SHIELD"
on Your Radio Tubes**

They prevent interstage coupling, eliminate stray capacities, stop tubes from vibrating and howling and increase distance.

"Vac-Shield" are adaptable to any socket and fit all type -01A and the New Type -22 Shielded Grid Tubes.

"Vac-Shield" are adjustable, made of heavy gauge metal fitting tubes snugly, found by laboratory test to be most efficient.

Work wonders with Supers and Short Wave Sets.

Order Today by Mail Post Paid \$1.00 or sent C.O.D. \$1.15. Agents wanted.

**ORANGE RESEARCH LABORATORIES
250 McKinley Ave. East Orange, N.J.**

DODGE RADIO SHORTKUT

With Appendix and Hints for Better Key Work. Fixes Signals in mind to stick—Kills Hesitation, Cultivates Speed and Good List—Produces Results. Slow Hams raise speed to 25 per in few evenings. Previous Failures qualify and pass exam quickly. Beginners master code and pass in ten days.

DODGE HIGH SPEED METHOD
(Intensive Speed Practice)
Quickly puts 25 per Hams in 25-40 per class. Five Hams report made this gain in few evenings. One of them by 75 minutes total practice only.

DODGE MORSE SHORTKUT
Easily mastered by Radio Ops—Kills tendency to mixup or confusion. Either code used as desired.

REPORTS FROM USERS

Tell the complete story—Mailed on request. Radio \$2.50. High Speed \$2.50. Morse \$2.50. Money order. None C. O. D. Foreign add 50 cents.

C. K. DODGE, MAMARONECK, NEW YORK.

For your new Frequency Meter

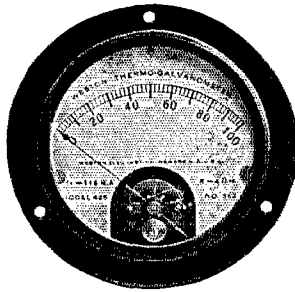

—to meet the
1929
requirements

GET your house in order!
Make your plans now for building the new frequency meter for 1929 which you will need in conforming with the Radio Commission's ruling to keep within the narrower transmission band.

Your frequency meter should be equipped with a Weston Thermo-Galvanometer because its low internal resistance is absolutely independent of frequency; and its overload capacity of 500 milliamperes gives protection against meter

burn-outs caused by excessive momentary overloads—due to too close coupling.

Weston Thermo-Galvanometers are made in two sizes—of the usual inimitable Weston quality in design and construction. These Galvanometers—Model 425, 3 1/4 in. diam. and Model 507, 2 in. diam. are made in flush type, finished in dull japan with silver etched scales. The electrical characteristics of these instruments are identical and their resistance is 5.2 ohms.

WESTON ELECTRICAL INSTRUMENT CORPORATION
602 Frelinghuysen Avenue, Newark, N. J.

Model 425—
3 1/4 in. diam.
\$15.00

WESTON RADIO INSTRUMENTS

Model 507—
2 in. diam.
\$14.00

Model "N"
Vario Densers

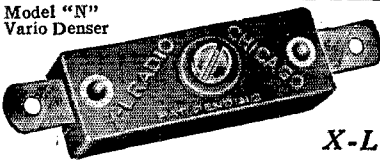

*Pep Up
Your Set
With
X-L Products*

Tune quickly—adjust accurately—eliminate distracting noises—get correct tube oscillation—with X-L VARIO DENSTERS in your circuit. Designers of all latest and best circuits specify and endorse.

MODEL "N"—Micrometer adjustment easily made, assures exact oscillation control in all tuned radio frequency circuits, Neutrodyne Roberts 2-tube, Browning-Drake, Silver's Knockout. Capacity range 1.8 to 20 Mfd. Price \$1.00.

MODEL "G"—Obtains the proper grid capacity on Cockaday circuits filter and intermediate frequency tuning in super-heterodyne and positive grid bias in all sets. Capacity range, Model G-1 .00002 to .0001 Mfd. Model G-5 .0001 to .0005 Mfd. Model G-10 .0003 to .001 Mfd. Price each with grid clips \$1.50.

X-L PUSH POST—NEW! Bakelite Insulated. Push it down with your thumb, insert wire, remove pressure, wire is firmly held. Vibrations will not loosen, releases instantly. Price each 15c.

FREE—New up-to-date book of wiring diagrams, showing use of X-L units in all popular hookups, also the Goodwin Aperiodic Detector Circuit, applicable to any set; adds a stage without added tuning controls. Write today.



**X-L PUSH
POST**

X-L RADIO LABORATORIES,
Dept. D, 1224 Belmont Ave.,
Chicago, Illinois

Signal Corps, Aero Radio Transmitter type AR 8, Maker General Radio Co. easily converted to CW for \$21.00; Mica Transmitting condensers, oak case .002 M. P. 1/4 Kil. rating, for \$3.50. Marconi Transformer 1, 500 cycle, type GM 432. Pri. volts 160. Sec. volts 11,300. 1 KW with reactance for \$12.50; U. S. Navy type CN 239. Receiving Set, 1000-10,000 meters. A-1 condition. Mkr. Ntl. Elec. Sup. Co. Complete without tube cabinet, for \$40.00. Largest stock of Government Radio Transmitting and Receiving material in U. S. Send 2c stamp for our new and latest reduced price list. Ship anywhere. **WELL'S CURIOSITY SHOP**, 20 South 2nd St., Philadelphia, Pa.

THE Great New **VIBROPLEX**

Reg. Trade-Mark: Vibroplex-Bug-Lighting Bug

No. 6

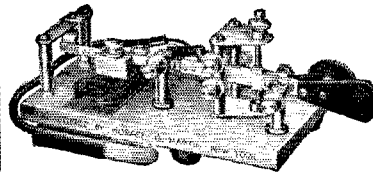

Japanned Base \$17
Nickel-Plated 19

Here's the Bug you want! Slow or fast — it sends smoothly, accurately and with amazing ease. 10 Great New Features New design.

More beautiful. More efficient. A great bug! Hundreds already sold.

Famous Improved Vibroplex

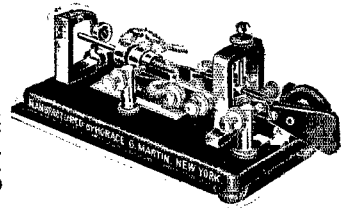

Used the world over because of its ease and perfection of sending. Over 100,000 users.

Special Radio Bug

Japanned Base \$15
Nickel-Plated 19

Equipped with extra large, specially constructed contact points to break high current without use of relay **\$25**

Remit by Money Order or Registered Mail.

THE VIBROPLEX CO., Inc.
825 Broadway NEW YORK
Cable Address: "VIBROPLEX" New York

New!

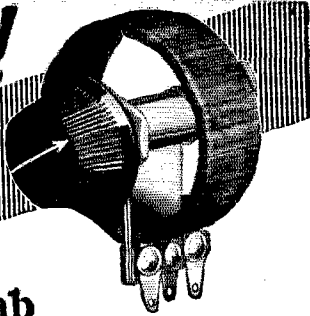

Centralab Power Rheostat

This new unit is a knock-out for warp-proof, heat-proof performance. Its construction permits continuous operation at temperatures of 482° F. and beyond. Resistance wire is wound on metal core, asbestos-insulated; core expands with wire, insuring smooth action. Narrow resistance strips give small resistance jumps per turn, further assurance of even regulation. Compact 2" diameter. Ohms—500, 250, 150, 50, 15, 6, 3, 2, .5—price \$1.25. Can also be furnished as a potentiometer. At dealer's, or C. O. D. You need this new Power Rheostat. Send postal for new circuit literature.

CENTRAL RADIO LABORATORIES
20 Keefe Avenue Milwaukee, Wis.

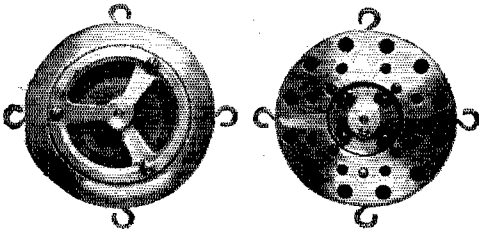

AT LAST! A real, honest-to-goodness broadcast "mike" at a reasonable price. A genuine two button stretched diaphragm type, already in use in many broadcast stations, but selling at a price within reach of the amateur—only \$40.00.
E. F. JOHNSON COMPANY WASECA, MINNESOTA

Genuine Bakelite Panels

3/16" Thick, Color Black

38x43" reg. price \$29.00, Special at \$9.75 per panel
30x38" reg. price \$21.00, Special at \$7.25 per panel
American Sales Co., 19-21 Warren St., N. Y. City

ROBERT S. KRUSE

Consultant and Technical Writer

103 Meadowbrook Road,
West Hartford, Conn.

Telephone Hartford 45327

jhl joat jmo xow xom xpi xn2 xn6 xn7 xo2 hva gbe
vpa xri ffz r6c vmb rot msh cet ips nigu.

R. Dezerville, 46 rue St. Laurent, Lagny, S. et M.,
France

(Heard between Oct. 1927 and Feb. 1928)

laaw laba labd laeq lage laik laka lanx latg
latu laus lavk lawm laxa lxxx lbbl lbdq lbfl
lbis lbna lbns lbqs lbw lbcm lbmt lbnc lbpd
lfl lfm lgh lic lih lja lkk lno lnx lqb lro lsw lwl
lwy lzy lzg lzga lzgp z2ab z2am z2ad z2ang z2ap
z2aq z2ap z2ats z2avz z2ayj z2axp z2bck z2bcv z2bds z2bfq
z2br 2bme z2bnu z2bvz z2ca z2cdr z2chi z2cua z2cuq z2cvj
z2xl z2et z2fd z2fp z2gm z2md z2mi z2ov z2ou z2rs z2t z2y
z2up z2vm z2xad z2abe z2abo z2ag z2aid z2ajh z2acm z2afw
z2ahp z2aim z2amx z2aoc z2apn z2auv z2bkw z2b3m z2b3z z2bnu
z2buv z2cc z2cfb z2cfc z2dqt z2ec z2ft z2gt z2t z2kbc z2ku
z2nr z2oq z2pf z2pr z2qe z2qm z2qu z2st z2aba z2acd z2ck z2ccn
z2ob 4ob 4oo 4qy 4si 5ayl 5oa 5rg 5yb 5abx 5ahc 5baz 5bhx
5bpa 5bpq 5cau 5evs 5exi 5dud 5dsa 5et 5eej 5erg
5dpy 5eaj 5b-be3 5c-lap 5c-lak 5c-lal 5c-lbr 5c-lam
5c-zfn 5c-nb 5c-8wg 5c-2ac 5c-2ar 5c-2aa 5c-2ab 5c-2bc
5c-2ad 5c-2ba 5c-2ac 5c-2me 5c-2mt 5c-4am 5c-4ac.

ec-2UN, near Brno Moravia, Czechoslovakia

laem laim lavl lem1 leue ldm lli lro lsz zagn
zaf1 zbr zeu z2t z2u z2o z2bq z2bl z2t z2bo z2cm z2tu
z4w z4g z4y z4p z4m z4e z4o z4n z4r z4s z4t z4b z4c z4d z4e z4f z4g z4h z4i z4j z4k z4l z4m z4n z4o z4p z4q z4r z4s z4t z4u z4v z4w z4x z4y z4z
fm-8ya fm-8ip fm-8rit fm-8sar fm-8al 5c-lad 5c-lar
5c-2fn 5c-nb 5c-8wg 5c-2ac 5c-2ar 5c-2aa 5c-2ab 5c-2bc
5c-2ad 5c-2ba 5c-2ac 5c-2me 5c-2mt 5c-4am 5c-4ac.

Olois Weirouch, Mestec, Kralove, Czechoslovakia

lakm lagi lahv laq lavj laxa lbhs lbk lbkc lck
lcnz ldl lgh lghj lgw lka lkk lmv lna lrf lsz
lxi lxx zacc zang zagn z2lv z2dq z2ayj z2br z2br
z2rb z2r z2ov z2ow z2o z2t z2w z2es z2ed z2ib z2ni z2pb
z2bz z2c z2ck z2dv z2f z2h z2s z2t z2ab z2ac z2ad z2ae z2af z2ag z2ah z2ai z2aj z2ak z2al z2am z2an z2ao z2ap z2aq z2ar z2as z2at z2au z2av z2aw z2ax z2ay z2az z2ba z2bb z2bc z2bd z2be z2bf z2bg z2bh z2bi z2bj z2bk z2bl z2bm z2bn z2bo z2bp z2bq z2br z2bs z2bt z2bu z2bv z2bw z2bx z2by z2bz z2ca z2cb z2cc z2cd z2ce z2cf z2cg z2ch z2ci z2cj z2ck z2cl z2cm z2cn z2co z2cp z2cq z2cr z2cs z2ct z2cu z2cv z2cw z2cx z2cy z2cz z2da z2db z2dc z2dd z2de z2df z2dg z2dh z2di z2dj z2dk z2dl z2dm z2dn z2do z2dp z2dq z2dr z2ds z2dt z2du z2dv z2dw z2dx z2dy z2dz z2ea z2eb z2ec z2ed z2ee z2ef z2eg z2eh z2ei z2ej z2ek z2el z2em z2en z2eo z2ep z2eq z2er z2es z2et z2eu z2ev z2ew z2ex z2ey z2ez z2fa z2fb z2fc z2fd z2fe z2ff z2fg z2fh z2fi z2fj z2fk z2fl z2fm z2fn z2fo z2fp z2fq z2fr z2fs z2ft z2fu z2fv z2fw z2fx z2fy z2fz z2ga z2gb z2gc z2gd z2ge z2gf z2gg z2gh z2gi z2gj z2gk z2gl z2gm z2gn z2go z2gp z2gq z2gr z2gs z2gt z2gu z2gv z2gw z2gx z2gy z2gz z2ha z2hb z2hc z2hd z2he z2hf z2hg z2hi z2hj z2hk z2hl z2hm z2hn z2ho z2hp z2hq z2hr z2hs z2ht z2hu z2hv z2hw z2hx z2hy z2hz z2ia z2ib z2ic z2id z2ie z2if z2ig z2ih z2ii z2ij z2ik z2il z2im z2in z2io z2ip z2iq z2ir z2is z2it z2iu z2iv z2iw z2ix z2iy z2iz z2ja z2jb z2jc z2jd z2je z2jf z2jg z2jh z2ji z2jj z2jk z2jl z2jm z2jn z2jo z2jp z2jq z2jr z2js z2jt z2ju z2jv z2jw z2jx z2jy z2jz z2ka z2kb z2kc z2kd z2ke z2kf z2kg z2kh z2ki z2kj z2kl z2km z2kn z2ko z2kp z2kq z2kr z2ks z2kt z2ku z2kv z2kw z2kx z2ky z2kz z2la z2lb z2lc z2ld z2le z2lf z2lg z2lh z2li z2lj z2lk z2ll z2lm z2ln z2lo z2lp z2lq z2lr z2ls z2lt z2lu z2lv z2lw z2lx z2ly z2lz z2ma z2mb z2mc z2md z2me z2mf z2mg z2mh z2mi z2mj z2mk z2ml z2mn z2mo z2mp z2mq z2mr z2ms z2mt z2mu z2mv z2mw z2mx z2my z2mz z2na z2nb z2nc z2nd z2ne z2nf z2ng z2nh z2ni z2nj z2nk z2nl z2nm z2no z2np z2nq z2nr z2ns z2nt z2nu z2nv z2nw z2nx z2ny z2nz z2oa z2ob z2oc z2od z2oe z2of z2og z2oh z2oi z2oj z2ok z2ol z2om z2on z2oo z2op z2oq z2or z2os z2ot z2ou z2ov z2ow z2ox z2oy z2oz z2pa z2pb z2pc z2pd z2pe z2pf z2pg z2ph z2pi z2pj z2pk z2pl z2pm z2pn z2po z2pp z2pq z2pr z2ps z2pt z2pu z2pv z2pw z2px z2py z2pz z2qa z2qb z2qc z2qd z2qe z2qf z2qg z2qh z2qi z2qj z2qk z2ql z2qm z2qn z2qo z2qp z2qq z2qr z2qs z2qt z2qu z2qv z2qw z2qx z2qy z2qz z2ra z2rb z2rc z2rd z2re z2rf z2rg z2rh z2ri z2rj z2rk z2rl z2rm z2rn z2ro z2rp z2rq z2rr z2rs z2rt z2ru z2rv z2rw z2rx z2ry z2rz z2sa z2sb z2sc z2sd z2se z2sf z2sg z2sh z2si z2sj z2sk z2sl z2sm z2sn z2so z2sp z2sq z2sr z2ss z2st z2su z2sv z2sw z2sx z2sy z2sz z2ta z2tb z2tc z2td z2te z2tf z2tg z2th z2ti z2tj z2tk z2tl z2tm z2tn z2to z2tp z2tq z2tr z2ts z2tt z2tu z2tv z2tw z2tx z2ty z2tz z2ua z2ub z2uc z2ud z2ue z2uf z2ug z2uh z2ui z2uj z2uk z2ul z2um z2un z2uo z2up z2uq z2ur z2us z2ut z2uu z2uv z2uw z2ux z2uy z2uz z2va z2vb z2vc z2vd z2ve z2vf z2vg z2vh z2vi z2vj z2vk z2vl z2vm z2vn z2vo z2vp z2vq z2vr z2vs z2vt z2vu z2vv z2vw z2vx z2vy z2vz z2wa z2wb z2wc z2wd z2we z2wf z2wg z2wh z2wi z2wj z2wk z2wl z2wm z2wn z2wo z2wp z2wq z2wr z2ws z2wt z2wu z2wv z2ww z2wx z2wy z2wz z2xa z2xb z2xc z2xd z2xe z2xf z2xg z2xh z2xi z2xj z2xk z2xl z2xm z2xn z2xo z2xp z2xq z2xr z2xs z2xt z2xu z2xv z2xw z2xx z2xy z2xz z2ya z2yb z2yc z2yd z2ye z2yf z2yg z2yh z2yi z2yj z2yk z2yl z2ym z2yn z2yo z2yp z2yq z2yr z2ys z2yt z2yu z2yv z2yw z2yx z2yy z2yz z2za z2zb z2zc z2zd z2ze z2zf z2zg z2zh z2zi z2zj z2zk z2zl z2zm z2zn z2zo z2zp z2zq z2zr z2zs z2zt z2zu z2zv z2zw z2zx z2zy z2zz

cl-1CR, Ing. Vincenzo Quasimodo, Gorizia, Italy

lchr laez lbux lbax lcax lmo lctp lajx lerb
lavj lomp lkk lamu laxa lmv lbcn lage laff luv
lpy lbvz lry lawe lvw lawy lbzi lxy lsz lcpb
lda ladw lbhm lakm ladm lic lmv lbhs laaw lals
lcje lcmx lfl lasy lwl lacm lacd lajm lbw lbvl
lbiv lbcn laao laxx lccz laiql lia lbqs lz1 lbke lcmf
ldf layz lafr laqt lli lasu lfd lcjs luf lxx lbek lkl
l1jk l1k l1q l1xaw l1u l2g l2d l2agn l2avb l2um
l2sg l2bbc l2ad1 l2asr l2kl l2gp l2aef l2r l2avz l2sx l2ang
l2tp l2bbe l2ch l2ejd l2bd l2alm l2erb l2amd l2og l2ane l2hc
l2ahg l2bac l2atk l2ass l2ags l2ahm l2nm l2ty l2azk l2ab
l2abf l2bcp l2atq l2bad l2bum l2afs l2box l2kw l2hg
l2anh l2aef l2age l2rb l2tn l2ld l2nr l2jo l2nb l2add l2xan
l2ql l2jq l2ix l2ld l2akw l2alq l2wf l2cge l2hf l2mw l2bo
l2qe l2z l2mv l2qt l2kj l2ckj l2caq l2amx l2gp l2auv
l2bgo l2bl l2px l2qz l2rn l2si l2ip l2rm l2kl l2tu l2ob l2ft
l2avs l2la l2agz l2bf l2mx l2afz l2yb l2im l2dea l2bto
l2don l2aj l2cnh l2ayu l2bhx l2br l2adg l2boc l2cil l2ve
l2dhx l2cip l2hev l2dod l2aja l2bto l2cdd l2dia l2br l2aiv
l2cfr l2bod l2ddn l2lld l2ces l2ac l2ben l2dax l2che l2ccq
l2eld l2erd l2bay l2db l2ark l2ey l2cil l2jkl l2cmv l2ed
l2adn l2cn l2aic l2cva l2ef l2bz l2avj l2bu l2w l2dke l2afa
l2dws l2avp l2ez l2c-lbr l2c-lap l2c-lbt l2c-ldm l2c-lar
l2c-lco l2c-2bg l2c-2al l2c-2bj l2c-2bc l2c-2fo l2c-3im
l2c-3ag l2c-3pz l2c-3at l2c-3sa l2c-3ez l2c-3th l2c-3xi
l2c-3m l2c-3n l2c-3w l2c-3x l2c-3z l2c-3j l2c-3k l2c-3l l2c-3m
l2c-3n l2c-3o l2c-3p l2c-3q l2c-3r l2c-3s l2c-3t l2c-3u l2c-3v l2c-3w l2c-3x l2c-3y l2c-3z l2c-3a l2c-3b l2c-3c l2c-3d l2c-3e l2c-3f l2c-3g l2c-3h l2c-3i l2c-3j l2c-3k l2c-3l l2c-3m l2c-3n l2c-3o l2c-3p l2c-3q l2c-3r l2c-3s l2c-3t l2c-3u l2c-3v l2c-3w l2c-3x l2c-3y l2c-3z l2c-3aa l2c-3ab l2c-3ac l2c-3ad l2c-3ae l2c-3af l2c-3ag l2c-3ah l2c-3ai l2c-3aj l2c-3ak l2c-3al l2c-3am l2c-3an l2c-3ao l2c-3ap l2c-3aq l2c-3ar l2c-3as l2c-3at l2c-3au l2c-3av l2c-3aw l2c-3ax l2c-3ay l2c-3az l2c-3ba l2c-3bb l2c-3bc l2c-3bd l2c-3be l2c-3bf l2c-3bg l2c-3bh l2c-3bi l2c-3bj l2c-3bk l2c-3bl l2c-3bm l2c-3bn l2c-3bo l2c-3bp l2c-3bq l2c-3br l2c-3bs l2c-3bt l2c-3bu l2c-3bv l2c-3bw l2c-3bx l2c-3by l2c-3bz l2c-3ca l2c-3cb l2c-3cc l2c-3cd l2c-3ce l2c-3cf l2c-3cg l2c-3ch l2c-3ci l2c-3cj l2c-3ck l2c-3cl l2c-3cm l2c-3cn l2c-3co l2c-3cp l2c-3cq l2c-3cr l2c-3cs l2c-3ct l2c-3cu l2c-3cv l2c-3cw l2c-3cx l2c-3cy l2c-3cz l2c-3da l2c-3db l2c-3dc l2c-3dd l2c-3de l2c-3df l2c-3dg l2c-3dh l2c-3di l2c-3dj l2c-3dk l2c-3dl l2c-3dm l2c-3dn l2c-3do l2c-3dp l2c-3dq l2c-3dr l2c-3ds l2c-3dt l2c-3du l2c-3dv l2c-3dw l2c-3dx l2c-3dy l2c-3dz l2c-3ea l2c-3eb l2c-3ec l2c-3ed l2c-3ee l2c-3ef l2c-3eg l2c-3eh l2c-3ei l2c-3ej l2c-3ek l2c-3el l2c-3em l2c-3en l2c-3eo l2c-3ep l2c-3eq l2c-3er l2c-3es l2c-3et l2c-3eu l2c-3ev l2c-3ew l2c-3ex l2c-3ey l2c-3ez l2c-3fa l2c-3fb l2c-3fc l2c-3fd l2c-3fe l2c-3ff l2c-3fg l2c-3fh l2c-3fi l2c-3fj l2c-3fk l2c-3fl l2c-3fm l2c-3fn l2c-3fo l2c-3fp l2c-3fq l2c-3fr l2c-3fs l2c-3ft l2c-3fu l2c-3fv l2c-3fw l2c-3fx l2c-3fy l2c-3fz l2c-3ga l2c-3gb l2c-3gc l2c-3gd l2c-3ge l2c-3gf l2c-3gg l2c-3gh l2c-3gi l2c-3gj l2c-3gk l2c-3gl l2c-3gm l2c-3gn l2c-3go l2c-3gp l2c-3gq l2c-3gr l2c-3gs l2c-3gt l2c-3gu l2c-3gv l2c-3gw l2c-3gx l2c-3gy l2c-3gz l2c-3ha l2c-3hb l2c-3hc l2c-3hd l2c-3he l2c-3hf l2c-3hg l2c-3hi l2c-3hj l2c-3hk l2c-3hl l2c-3hm l2c-3hn l2c-3ho l2c-3hp l2c-3hq l2c-3hr l2c-3hs l2c-3ht l2c-3hu l2c-3hv l2c-3hw l2c-3hx l2c-3hy l2c-3hz l2c-3ia l2c-3ib l2c-3ic l2c-3id l2c-3ie l2c-3if l2c-3ig l2c-3ih l2c-3ii l2c-3ij l2c-3ik l2c-3il l2c-3im l2c-3in l2c-3io l2c-3ip l2c-3iq l2c-3ir l2c-3is l2c-3it l2c-3iu l2c-3iv l2c-3iw l2c-3ix l2c-3iy l2c-3iz l2c-3ja l2c-3jb l2c-3jc l2c-3jd l2c-3je l2c-3jf l2c-3jg l2c-3jh l2c-3ji l2c-3jj l2c-3jk l2c-3jl l2c-3jm l2c-3jn l2c-3jo l2c-3jp l2c-3jq l2c-3jr l2c-3js l2c-3jt l2c-3ju l2c-3jv l2c-3jw l2c-3jx l2c-3jy l2c-3jz l2c-3ka l2c-3kb l2c-3kc l2c-3kd l2c-3ke l2c-3kf l2c-3kg l2c-3kh l2c-3ki l2c-3kj l2c-3kl l2c-3km l2c-3kn l2c-3ko l2c-3kp l2c-3kq l2c-3kr l2c-3ks l2c-3kt l2c-3ku l2c-3kv l2c-3kw l2c-3kx l2c-3ky l2c-3kz l2c-3la l2c-3lb l2c-3lc l2c-3ld l2c-3le l2c-3lf l2c-3lg l2c-3lh l2c-3li l2c-3lj l2c-3lk l2c-3ll l2c-3lm l2c-3ln l2c-3lo l2c-3lp l2c-3lq l2c-3lr l2c-3ls l2c-3lt l2c-3lu l2c-3lv l2c-3lw l2c-3lx l2c-3ly l2c-3lz l2c-3ma l2c-3mb l2c-3mc l2c-3md l2c-3me l2c-3mf l2c-3mg l2c-3mh l2c-3mi l2c-3mj l2c-3mk l2c-3ml l2c-3mn l2c-3mo l2c-3mp l2c-3mq l2c-3mr l2c-3ms l2c-3mt l2c-3mu l2c-3mv l2c-3mw l2c-3mx l2c-3my l2c-3mz l2c-3na l2c-3nb l2c-3nc l2c-3nd l2c-3ne l2c-3nf l2c-3ng l2c-3nh l2c-3ni l2c-3nj l2c-3nk l2c-3nl l2c-3nm l2c-3no l2c-3np l2c-3nq l2c-3nr l2c-3ns l2c-3nt l2c-3nu l2c-3nv l2c-3nw l2c-3nx l2c-3ny l2c-3nz l2c-3oa l2c-3ob l2c-3oc l2c-3od l2c-3oe l2c-3of l2c-3og l2c-3oh l2c-3oi l2c-3oj l2c-3ok l2c-3ol l2c-3om l2c-3on l2c-3oo l2c-3op l2c-3oq l2c-3or l2c-3os l2c-3ot l2c-3ou l2c-3ov l2c-3ow l2c-3ox l2c-3oy l2c-3oz l2c-3pa l2c-3pb l2c-3pc l2c-3pd l2c-3pe l2c-3pf l2c-3pg l2c-3ph l2c-3pi l2c-3pj l2c-3pk l2c-3pl l2c-3pm l2c-3pn l2c-3po l2c-3pp l2c-3pq l2c-3pr l2c-3ps l2c-3pt l2c-3pu l2c-3pv l2c-3pw l2c-3px l2c-3py l2c-3pz l2c-3qa l2c-3qb l2c-3qc l2c-3qd l2c-3qe l2c-3qf l2c-3qg l2c-3qh l2c-3qi l2c-3qj l2c-3qk l2c-3ql l2c-3qm l2c-3qn l2c-3qo l2c-3qp l2c-3qq l2c-3qr l2c-3qs l2c-3qt l2c-3qu l2c-3qv l2c-3qw l2c-3qx l2c-3qy l2c-3qz l2c-3ra l2c-3rb l2c-3rc l2c-3rd l2c-3re l2c-3rf l2c-3rg l2c-3rh l2c-3ri l2c-3rj l2c-3rk l2c-3rl l2c-3rm l2c-3rn l2c-3ro l2c-3rp l2c-3rq l2c-3rr l2c-3rs l2c-3rt l2c-3ru l2c-3rv l2c-3rw l2c-3rx l2c-3ry l2c-3rz l2c-3sa l2c-3sb l2c-3sc l2c-3sd l2c-3se l2c-3sf l2c-3sg l2c-3sh l2c-3si l2c-3sj l2c-3sk l2c-3sl l2c-3sm l2c-3sn l2c-3so l2c-3sp l2c-3sq l2c-3sr l2c-3ss l2c-3st l2c-3su l2c-3sv l2c-3sw l2c-3sx l2c-3sy l2c-3sz l2c-3ta l2c-3tb l2c-3tc l2c-3td l2c-3te l2c-3tf l2c-3tg l2c-3th l2c-3ti l2c-3tj l2c-3tk l2c-3tl l2c-3tm l2c-3tn l2c-3to l2c-3tp l2c-3tq l2c-3tr l2c-3ts l2c-3tt l2c-3tu l2c-3tv l2c-3tw l2c-3tx l2c-3ty l2c-3tz l2c-3ua l2c-3ub l2c-3uc l2c-3ud l2c-3ue l2c-3uf l2c-3ug l2c-3uh l2c-3ui l2c-3uj l2c-3uk l2c-3ul l2c-3um l2c-3un l2c-3uo l2c-3up l2c-3uq l2c-3ur l2c-3us l2c-3ut l2c-3uu l2c-3uv l2c-3uw l2c-3ux l2c-3uy l2c-3uz l2c-3va l2c-3vb l2c-3vc l2c-3vd l2c-3ve l2c-3vf l2c-3vg l2c-3vh l2c-3vi l2c-3vj l2c-3vk l2c-3vl l2c-3vm l2c-3vn l2c-3vo l2c-3vp l2c-3vq l2c-3vr l2c-3vs l2c-3vt l2c-3vu l2c-3vv l2c-3vw l2c-3vx l2c-3vy l2c-3vz l2c-3wa l2c-3wb l2c-3wc l2c-3wd l2c-3we l2c-3wf l2c-3wg l2c-3wh l2c-3wi l2c-3wj l2c-3wk l2c-3wl l2c-3wm l2c-3wn l2c-3wo l2c-3wp l2c-3wq l2c-3wr l2c-3ws l2c-3wt l2c-3wu l2c-3wv l2c-3ww l2c-3wx l2c-3wy l2c-3wz l2c-3xa l2c-3xb l2c-3xc l2c-3xd l2c-3xe l2c-3xf l2c-3xg l2c-3xh l2c-3xi l2c-3xj l2c-3xk l2c-3xl l2c-3xm l2c-3xn l2c-3xo l2c-3xp l2c-3xq l2c-3xr l2c-3xs l2c-3xt l2c-3xu l2c-3xv l2c-3xw l2c-3xx l2c-3xy l2c-3xz l2c-3ya l2c-3yb l2c-3yc l2c-3yd l2c-3ye l2c-3yf l2c-3yg l2c-3yh l2c-3yi l2c-3yj l2c-3yk l2c-3yl l2c-3ym l2c-3yn l2c-3yo l2c-3yp l2c-3yq l2c-3yr l2c-3ys l2c-3yt l2c-3yu l2c-3yv l2c-3yw l2c-3yx l2c-3yy l2c-3yz l2c-3za l2c-3zb l2c-3zc l2c-3zd l2c-3ze l2c-3zf l2c-3zg l2c-3zh l2c-3zi l2c-3zj l2c-3zk l2c-3zl l2c-3zm l2c-3zn l2c-3zo l2c-3zp l2c-3zq l2c-3zr l2c-3zs l2c-3zt l2c-3zu l2c-3zv l2c-3zw l2c-3zx l2c-3zy l2c-3zz

oz-2BJ, A. Evans, 269 Taranaki St., Wellington, N.Z.
(Heard during January)

laqp laaf lavl lbop lej lgz lxx lzn zagn zalu
z2bj z2o z2a z2t z2u z2s z2ak z2ax z2ain z2aky
z2aq z2az z2bc z2bd z2be z2bf z2bg z2bh z2bi z2bj z2bk z2bl z2bm z2bn z2bo z2bp z2bq z2br z2bs z2bt z2bu z2bv z2bw z2bx z2by z2bz z2ca z2cb z2cc z2cd z2ce z2cf z2cg z2ch z2ci z2cj z2ck z2cl z2cm z2cn z2co z2cp z2cq z2cr z2cs z2ct z2cu z2cv z2cw z2cx z2cy z2cz z2da z2db z2dc z2dd z2de z2df z2dg z2dh z2di z2dj z2dk z2dl z2dm z2dn z2do z2dp z2dq z2dr z2ds z2dt z2du z2dv z2dw z2dx z2dy z2dz z2ea z2eb z2ec z2ed z2ee z2ef z2eg z2eh z2ei z2ej z2ek z2el z2em z2en z2eo z2ep z2eq z2er z2es z2et z2eu z2ev z2ew z2ex z2ey z2ez z2fa z2fb z2fc z2fd z2fe z2ff z2fg z2fh z2fi z2fj z2fk z2fl z2fm z2fn z2fo z2fp z2fq z2fr z2fs z2ft z2fu z2fv z2fw z2fx z2fy z2fz z2ga z2gb z2gc z2gd z2ge z2gf z2gg z2gh z2gi z2gj z2gk z2gl z2gm z2gn z2go z2gp z2gq z2gr z2gs z2gt z2gu z2gv z2gw z2gx z2gy z2gz z2ha z2hb z2hc z2hd z2he z2hf z2hg z2hi z2hj z2hk z2hl z2hm z2hn z2ho z2hp z2hq z2hr z2hs z2ht z2hu z2hv z2hw z2hx z2hy z2hz z2ia z2ib z2ic z2id z2ie z2if z2ig z2ih z2ii z2ij z2ik z2il z2im z2in z2io z2ip z2iq z2ir z2is z2it z2iu z2iv z2iw z2ix z2iy z2iz z2ja z2jb z2jc z2jd z2je z2jf z2jg z2jh z2ji z2jj z2jk z2jl z2jm z2jn z2jo z2jp z2jq z2jr z2js z2jt z2ju z2jv z2jw z2jx z2jy z2jz z2ka z2kb z2kc z2kd z2ke z2kf z2kg z2kh z2ki z2kj z2kl z2km z2kn z2ko z2kp z2kq z2kr z2ks z2kt z2ku z2kv z2kw z2kx z2ky z2kz z2la z2lb z2lc z2ld z2le z2lf z2lg z2lh z2li z2lj z2lk z2ll z2lm z2ln z2lo z2lp z2lq z2lr z2ls z2lt z2lu z2lv z2lw z2lx z2ly z2lz z2ma z2mb z2mc z2md z2me z2mf z2mg z2mh z2mi z2mj z2mk z2ml z2mn z2mo z2mp z2mq z2mr z2ms z2mt z2mu z2mv z2mw z2mx z2my z2mz z2na z2nb z2nc z2nd z2ne z2nf z2ng z2nh z2ni z2nj z2nk z2nl z2nm z2no z2np z2nq z2nr z2ns z2nt z2nu z2nv z2nw z2nx z2ny z2nz z2oa z2ob z2oc z2od z2oe z2of z2og z2oh z2oi z2oj z2ok z2ol z2om z2on z2oo z2op z2oq z2or z2os z2ot z2ou z2ov z2ow z2ox z2oy z2oz z2pa z2pb z2pc z2pd z2pe z2pf z2pg z2ph z2pi z2pj z2pk z2pl z2pm z2pn z2po z2pp z2pq z2pr z2ps z2pt z2pu z2pv z2pw z2px z2py z2pz z2qa z2qb z2qc z2qd z2qe z2qf z2qg z2qh z2qi z2qj z2qk z2ql z2qm z2qn z2qo z2qp z2qq z2qr z2qs z2qt z2qu z2qv z2qw z2qx z2qy z2qz z2ra z2rb z2rc z2rd z2re z2rf z2rg z2rh z2ri z2rj z2rk z2rl z2rm z2rn z2ro z2rp z2rq z2rr z2rs z2rt z2ru z2rv z2rw z2rx z2ry z2rz z2sa z2sb z2sc z2sd z2se z2sf z2sg z2sh z2si z2sj z2sk z2sl z2sm z2sn z2so z2sp z2sq z2sr z2ss z2st z2su z2sv z2sw z2sx z2sy z2sz z2ta z2tb z2tc z2td z2te z2tf z2tg z2th z2ti z2tj z2tk z2tl z2tm z2tn z2to z2tp z2tq z2tr z2ts z2tt z2tu z2tv z2tw z2tx z2ty z2tz z2ua z2ub z2uc z2ud z2ue z2uf z2ug z2uh z2ui z2uj z2uk z2ul z2um z2un z2uo z2up z2uq z2ur z2us z2ut z2uu z2uv z2uw z2ux z2uy z2uz z2va z2vb z2vc z2vd z2ve z2vf z2vg z2vh z2vi z2vj z2vk z2vl z2vm z2vn z2vo z2vp z2vq z2vr z2vs z2vt z2vu z2vv z2vw z2vx z2vy z2vz z2wa z2wb z2wc z2wd z2we z2wf z2wg z2wh z2wi z2wj z2wk z2wl z2wm z2wn z2wo z2wp z2wq z2wr z2ws z2wt z2wu z2wv z2ww z2wx z2wy z2wz z2xa z2xb z2xc z2xd z2xe z2xf z2xg z2xh z2xi z2xj z2xk z2xl z2xm z2xn z2xo z2xp z2xq z2xr z2xs z2xt z2xu z2xv z2xw z2xx z2xy z2xz z2ya z2yb z2yc z2yd z2ye z2yf z2yg z2yh z2yi z2yj z2yk z2yl z2ym z2yn z2yo z2yp z2yq z2yr z2ys z2yt z2yu z2yv z2yw z2yx z2yy z2yz z2za z2zb z2zc z2zd z2ze z2zf z2zg z2zh z2zi z2zj z2zk z2zl z2zm z2zn z2zo z2zp z2zq z2zr z2zs z2zt z2zu z2zv z2zw z2zx z2zy z2zz



THE NATIONAL CYCLE COMPANY
 605 EAST 4TH STREET

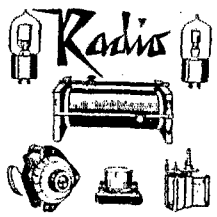

EVERYTHING FOR THE BICYCLE

AMARILLO TEXAS July 18 1927

192

Electric Specialty Co.,
 225 South Street
 Stamford, Conn.

Gentlemen:-

This will acknowledge receipt of yours 15th inst and we are pleased to say that the ESCO motor-generator sets used by us at WDAG, our broadcasting station, have given the best of service.

While we have never attempted to overload any of our apparatus we find that the ESCO machines working right at their limit have given excellent satisfaction and take pleasure in recommending them to anyone in need of such machines.

Trusting we will find it possible to assist you in placing machines in the future, we are

Yours truly

THE NATIONAL CYCLE COMPANY
 By *J. Martin*
 Radio operator and engineer of WDAG

You Can Quickly Become An EXPERT RADIO OPERATOR

The Candler System of Training in High-Speed Telegraphing Shows How

Theo. McElroy, World's Champion Radio Operator, endorses no other system. Read what he says—"At the Pageant of Progress, Chicago, I copied 56 words per minute for 5 minutes, establishing a new radio record, which I still hold. I owe my Skill, Speed and Steady Nerve both in sending and receiving to The Candler System." What this system has done for McElroy and thousands of others—it will do for YOU.

FREE Booklet explains system fully. Send for it **TO-DAY.** A post card will do. **Send Now!**

THE CANDLER SYSTEM CO., Dept. AR
 6348 So. Kedzie Ave., CHICAGO, ILL.

Power Transformers

Guaranteed—Mounted—Complete

1 Kw.-2000-2400 v. each side	\$30.00
1 Kw.-2500-3000 each side	35.00
600 watt 1000-1500 v. each side	14.00
600 watt 2000-2500 each side	21.00
250 watt 550- 700 each side	10.50
250 watt 25 cycle 550- 700 v.	14.00
700 watt 25 cycle 2000-2500	28.00

Add \$2.00 for fil winding.

9CES F. GREBEN

1927 S Peoria St., Pilsen Station, Chicago, Ill.

and Now

FANSTEEL

Balkite RADIO

Watch for complete

ANNOUNCEMENT

Fansteel Products Company, Inc.

NORTH CHICAGO, ILL.

YOU'VE THERE WITH A CROSLLEY



NEW CROSLLEY JEWEL BOX

Genuine neotrodyne AC receiver. 130 volts on plate of last tube gives full natural tone. Very sharp and selective. Write Dept. 18 for information.

THE CROSLLEY RADIO CORPORATION
 Powell Crosley, Jr., Pres. Cincinnati, Ohio

Licensed only for Radio Amateur, Experimental and Broadcast Reception.

Prices slightly higher in far western states.

Battery Type Bandbox, \$55
 Dry Cell Bandbox, Jr., \$35

\$95.00

PACENT DUO-LATERAL COILS

FOR laboratories, experimenters, engineers and for special circuits, Pacent Duo-Lateral Coils are the accepted standard.

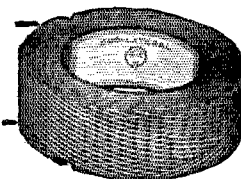

A complete line of all standard turn ratios are always in stock.

Write for information and prices

Pacent Electric Co., Inc.
 91 Seventh Avenue, New York

RADIO SCHOOL

Send for Catalogue

**MASSACHUSETTS RADIO and
 TELEGRAPH SCHOOL**

18 Boylston St. Boston, Mass.

Tafz Tgz 7hd 7gj 8evq 9ara 9arn 9bnb 9bwm 9cjh
 9erj 9dws 9dih 9efk 9ez 9nr ac-1a ac-2ak ac-2ff
 ac-4dx ai-2kt ai-2kw aj-4dx aj-4zz eb-4au eb-4bc
 ef-8eo ef-8fd ef-8xo em-sf4 ne-2bg oh-6avl oh-6bh
 oh-6boe oh-6dlr oh-6dqq oh-6xk oo-bam oo-dgk
 op-4sn sa-8en sb-lah vq-laj.

Radio SMZF, Vigge, Sweden

(Heard between January 11 and February 11)

1vc 1moa 1gh 1abd 1bke 1bqd 2adb 2afr 2agn 2as
 2dp 2ahg 2tp 2bfy 2bbc 2bfo 2ais 2mew 2aj 5kc
 6amn 8dcw 8ee.

eu-05ra, V. Vostrakov, U. S. S. R. Moscow 6, Mal.
 Dmitrova 10 hv 2

1my 1akz 1chs 1mx 2uo 2exl 2amc 2eda 3cgg 3ebc
 3eag 9fo.

Communications Department

(Continued from Page 58)

PRAIRIE DIVISION

MANITOBA—SCM, D. B. Sinclair, 4FV—Nine new stations have appeared on the air since last month. 4DU continued his DX tho spending little time on the air. 4DP, 4DW and 4EY have left town. 4GG is going fine and has applied for OBS and ORS. 4GQ and 4GG are putting Winnipeg on the map in fine shape. 4DY and 4BP have decided to quit and sell out. 4CT is in the throes of moving so had little time for radio. 4BT will be home this week. 4EK had a 50 wattter on the air for a while but got better results with a 210 so is now using the little tube. 4FV's 210 pushed an R6 signal into eg5BY. 4FS and 4AR have schedules with local stations and are received regularly here.

Traffic: 4FV 51, 4GG 8.

SASKATCHEWAN—SCM, W. J. Pickering, 4FC—4BM has been QSO the Canadian 6th Dist. and is trying to hook the 1st now. 4HH is getting out better with his 7 1/2 wattter than he did with his 250 wattter and he sends in a photo of his layout and includes his face. 4IH turns in a very nice message total and reports being mostly on 20 which he says is fine for traffic. 4AC has been handling traffic with KL at the Gold Lake mines. 4HS is back on again but is having trouble with his MG. 4FC has been keeping a schedule with VBY at Fort Churchill. Both ops at 4CK have their 1st class tickets now.

Traffic: 4IH 46, 4HS 35, 4AC 25, 4HH 24, 4BM 16, 4CK 6, 4FC 3.

ADDITIONAL AND LATE REPORTS

9ENU reports a new ham in Kansas City, Mo., 9FIO. op1AD sends in a fine total this month. 6BJX is up on 80 meters now. 1BCK is a prospective ORS. 2BOW reports a new ham, 2BKN, coming in on Dobbs Ferry. 2ABY visited OIK, the SS Lituania and had a chat with the chief op. 2CNS wins the election in Eastern N. Y. nc4FF sold his 500 volt generator so is on 200 volts and 2 UX201A tubes now. 8AYH is going to put up a new Zeppelin antenna. 8SR is pleased to announce the arrival of a new YL operator, Lucille Amelia Fiteh on March 16. Congrats to you and Mrs. 8SR, OM. 6CQP is doing radio service work now. 6BVO reports a fine schedule to Arizona working now. 6AD sends in a good report this month. 5DG writes us that 5OX accidentally shot himself on Mar. 23 while cleaning his gun but is recovering. 1AHV reported direct this month as he forgot it until too late to send to his SCM. 7AJU is now closed down and is leaving for Los Angeles soon. 3CNK reports that there are two operators at his station and hope to be an ORS soon.

Traffic: 9ENU 158, op1AD 412, 6BTX 22, 1BCK 91, 2BOW 25, 2ABY 20, nc4FF 17, 2CNS 14, 6CQP 54, 6BVO 48, 1AHV 41, 7AJU 16, 6AD 174.

THAT'S WHAT THEY ALL SAY

Rectifier Engineering Service, Cleveland, Ohio

Laramie, Wyo., 3-6-'28

Gentlemen:—
 Just a few lines to express my appreciation of your Arc outfit. It's sure great, and I don't believe any other kind of rectifier can begin to compare with it. I wouldn't be without one if its cost were several times as great. I can recommend it to any ham who wants a first class rectifier, and also want to thank you for your prompt shipment and service. I am sure a booster for it, OM, because for a rectifier nothing on the market can begin to compare with it. Just as soon as I can get 5 phase current in will be ready for your 6 phase Arc outfit.

R. W. WALTON TAIL

In charge Vocational Elec. Dept. Laramie High School Laramie, Wyo.

The Mercury Arc has your rectifier problems solved. Data sheets describe latest developments. Low loss keep alive, 6 phase arcs.

RECTIFIER ENGINEERING SERVICE,
 RADIO 8ML

CLEVELAND, OHIO

4837 ROCKWOOD

Say You Saw It In QST—It Identifies You and Helps QST

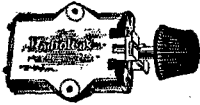

Bradley Leak, 2.95
absolutely noiseless and stepless, 2000 to 30,000 ohm resistance. List \$5, special \$2.95.

No. 12 Enameled copper wire, any length, ft.\$.01
No. 10 Enameled copper wire, any length, ft.01½
Genuine Bakelite Panel 10x14¼1.50
Teco—50 Watt Socket1.45
Myers \$5 ½ volt Det. or Amp tube, complete with mounting clips95
Belden braid ¼ inch wide, ft. .06
Neon tube, type B, ultra sensitive. Has sealed in electrodes, positive contacts. Best indicator for wavemeter 1.50

Thordarson Power Transformer
\$13 list—T-125, cap. 100 watt, secondary each side of neutral 350 and 550 volts, \$9.85.
\$18 list—T-126, cap. 450 watt, secondary each side of neutral 1000 and 1500 volts, \$13.95.
\$30 list—T-127, cap. 900 watt, secondary each side of neutral 1000 and 1500 volts, \$22.50.

LEEDS

The Home of RADIO
45 VESEY STREET
NEW YORK

New York's Headquarters for Transmitting Apparatus
When in Town Visit Our Store

Full Line of Acme -- Thordarson -- Jewell -- Flechtheim -- General Radio -- Signal -- Bradley

SPECIALS

Dubilier Mica Condenser .002 cap. 6,000 working volt 1.95
General Radio 247D .001 cond. plain or with vernier 1.75
Dubilier cond. 1.7 mfd. 1,000v D.C. test; 650v. working voltage 1.35
Dubilier cond. .5 mfd. 1,000v D.C. working voltage .85
R.C.A.—U.V. 1716 Super Het. transformer 1.45
Dubilier Duration R. F. transformer 2.95
Ward Leonard Resistances; fits standard base receptacles; sizes 300—600—900—1200 and 2000 ohms .95
\$15. Imported German head sets; very sensitive 3.45
Honeycomb Coils unmounted, all sizes in stock at ½ price.
\$8 Signal Corp adjustable arm micro-transmitter for panel mounting 2.45
Heath condenser double spaced for transmitting .00025 cap 2.45
Dubilier buffer condenser .1 mfd. 400 v. D.C. each .50
Bristol 50 Henry choke 2.75
6.50 Acme .0005 enclosed condenser .95

Pyrex Low-loss V.T. sockets, each 39c.

Flechtheim Condensers, all types 35% off list.

MAIL ORDERS FILLED SAME DAY
10% Must Accompany All Orders

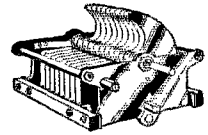

Cardwell condensers, double spaced for transmitting, .00025 cap. 3.45

Electrad Wire Fixed Resistance, type B, 25 watts, 2" long 5,000 ohm, centre tapped \$.95
10,000 ohms, centre tapped 1.10
Type C, 50 watts, 4" long 5,000 ohm, centre tapped 1.45
10,000 ohm, centre tapped 1.75
Type D, 75 watts 20,000 ohm, centre tapped 2.25



Ward Leonard Resistance
\$4.75 list—6½ inch long—800-1000-1200-3000-6000-8000-11000 ohms; can be used for 2-50 watt tubes or less. \$1.45

Acme C. W. 30 Henry Choke
\$18 list—150 M.A. single, \$14.40, also other sizes at special prices.

QST Oscillating Crystals

New Prices Effective April First, 1928
AMATEUR BANDS

Prices for grinding crystals at random frequencies which fall within the bands described below are as follows:

1715 Kcs. to 1825 Kcs. \$15.00.
1828 Kcs. to 2000 Kcs. \$13.00.
2500 Kcs. to 3550 Kcs. \$25.00.
3851 Kcs. to 4000 Kcs. \$22.00.
7000 Kcs. to 7300 Kcs. \$40.00.

The frequency of the crystal will be given accurate to better than a tenth of one per-cent. Immediate deliveries.

BROADCAST BAND

Prices for grinding crystals to your assigned frequency accurate to plus or minus 500 cycles are: \$15.00 unmounted, \$35.00 mounted. Three day shipment, and all crystals guaranteed. This crystal is our usual POWER type. Crystals ground to any frequency between 40 and 10,000 Kcs. Let us quote prices for your particular requirement.

SCIENTIFIC RADIO SERVICE

"THE CRYSTAL SPECIALISTS"

P. O. Box 86 Dept. W Mount Rainier, Maryland



Completely wired Push-Pull Power Stage

HANDLES ample power to faithfully reproduce full frequency range without tube overloading. Eliminates hum caused by raw AC on filaments of Power Tubes. Increases clarity, reality and volume.

AmerTran gives you a unit in 4 types designed for practically any combination of speakers [including the new dynamic types], and power tubes. For complete information see any authorized AmerTran dealer or write to us direct, mentioning the speaker and tubes you intend using.

Price completely wired and ready to install in set \$36.00 without tubes.

Licensed under Patents owned or controlled by R. C. A. and may be bought with tubes

AMERICAN TRANSFORMER COMPANY
Transformer Builders for more than 28 Years
190 Emmet Street, Newark, N. J.



GRIDLEAKS

15,000 ohm, tapped at 5,000 and 10,000 ohms with 85 watt capacity Price, \$1.50
20,000 ohms, 85 watt for UX852 1.50
5,000 ohms, 85 watts 1.00
5,000 ohms, 20 watt for one UX21075

Postpaid

UTILITY RADIO CO.

80 LESLIE STREET EAST ORANGE, N. J.

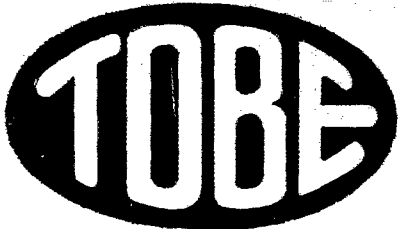

A-FILTER

A new and different dry condenser of 3600 Mfd. cased with chokes of proper size, to supply humless A-current to any set when connected to proper type of standard battery charging rectifier. Condenser is sold separately. Send in coupon today.

Tobe Deutschmann Co.,
11 Windsor Street, Cambridge, Mass.
Please send me Pamphlet Q5 on your New A Filter and A Condenser and your Set Builders Proposition.

Name.....

Address.....

BECOME A RADIO OPERATOR

See the World. Earn a Good Income
Duties Light and Fascinating.

LEARN IN THE SECOND PORT U.S.A.

Radio Inspector located here. New Orleans supplies operators for the various Gulf ports. Most logical location in the U.S.A. to come to for training.

Nearly 100% of radio operators graduating on the Gulf during the past five years trained by Mr. Clemmons, Supervisor of Instruction. Start training now for summer and fall runs.

Member of the A.R.R.L.—Call "5 G R"

Day and Night Classes—Enroll anytime—Write for circular.

GULF RADIO SCHOOL

844 Howard Ave. New Orleans, La.

AMAZING VALUE at Bargain Prices. A.B. Socket Power Units for any five to seven tube set. Latest model. Exceptional power. Two rate bulb type charger and bulb type four tap eliminator with automatic control switch and six volt storage battery. Every one a genuine bargain. Write today for folder and prices.

THE ACME ELECTRIC & MFG. CO.,
1652 Rockwell Avenue CLEVELAND, O.

RADIO THEORY AND OPERATING

3rd Edition, Revised—886 Pages—700 Illustrations—Price \$3.50

By Mary Texanna Loomis

President Loomis Radio College; Member Institute of Radio Engineers.

America's standard radio book. Used by Dept. of Commerce, U. S. Radio Schools, practically all Radio Schools throughout U. S. and Canada, Universities, Colleges and High Schools. Buy of your bookstore or order direct. Postage paid.

LOOMIS PUBLISHING CO.,
Dept. T-405 9th St., Washington, D. C.

STATEMENT OF THE OWNERSHIP, MANAGEMENT, CIRCULATION, ETC., REQUIRED BY THE ACT OF CONGRESS OF AUGUST 24, 1912.

Of QST, published monthly at Hartford, Conn., for April 1, 1928.

State of Connecticut ss:
County of Hartford

Before me, a Notary Public in and for the State and county aforesaid, personally appeared K. B. Warner, who, having been duly sworn according to law, deposes and says that he is the business manager of QST and that the following is, to the best of his knowledge and belief, a true statement of the ownership, management (and if a daily paper, the circulation), etc., of the aforesaid publication for the date shown in the above caption, required by the Act of August 24, 1912, embodied in section 411, Postal Laws and Regulations, printed on the reverse of this form, to wit:

1. That the names and addresses of the publisher, editor, managing editor, and business managers are: Publisher, The American Radio Relay League, Inc., Hartford, Conn.; Editor, Kenneth B. Warner, Hartford, Conn.; Managing Editor, F. Cheyney Beekley, Hartford, Conn.; Business Manager, Kenneth B. Warner, Hartford, Conn.

2. That the owners are: (Give names and addresses of the individual owners, or if a corporation, give its name and the names and addresses of stockholders owning or holding 1 per cent. or more of the total amount of stock) The American Radio Relay League, Inc., an association without capital stock, incorporated under the laws of the State of Connecticut. President, Hiram Percy Maxim, Hartford, Conn.; Vice-President, Chas. H. Stewart, St. David's, Pa.; Treasurer, A. A. Hebert, Hartford, Conn.; Communications Manager, F. E. Handy, Hartford, Conn.; Secretary, K. B. Warner, Hartford, Conn.

3. That the known bondholders, mortgagees, and other security holders owning or holding 1 per cent. or more of total amount of bonds, mortgages, or other securities are: (If there are none, so state.) None.

4. That the two paragraphs next above, giving the names of the owners, stockholders, and security holders, if any, contain not only the list of stockholders and security holders as they appear on the books of the company but also, in cases where the stockholder or security holder appears upon the books of the company as trustee or in any other fiduciary relation, the name of the person or corporation for whom such trustee is acting, is given; also that the said two paragraphs contain statements, embracing affiant's full knowledge and belief as to the circumstances and conditions under which stockholders and security holders who do not appear upon the books of the company as trustees, hold stock and securities in a capacity other than that of a bona fide owner; and this affiant has no reason to believe that any other person, association or corporation has any interest direct, or indirect in the said stock, bonds, or other securities than as so stated by him.

5. That the average number of copies of each issue of this publication, sold or distributed, through the mails or otherwise, to paid subscribers during the six months preceding the date shown above is (This information is required from daily publications only.)

K. B. WARNER.

Sworn to and subscribed before me this 3d day of April, 1928.

Caroline S. Crisman,

(My commission expires February, 1931.)

QUARTZ OSCILLATING CRYSTALS

Unconditionally Guaranteed

1 in. sections ground to 1% of your specified frequency at these prices:

40-75 meters	\$25.00
75-100 meters	17.50
100-200 meters	19.00
200-600 meters	15.00
Tested blanks, 2 to 5 mm thick	5.00

Sections of any practicable dimensions made to order.

Prompt Delivery

J. T. Rooney, E. Sc., 31 Calumet Bldg., Buffalo, N. Y.
"Ten years crystallographic experience"

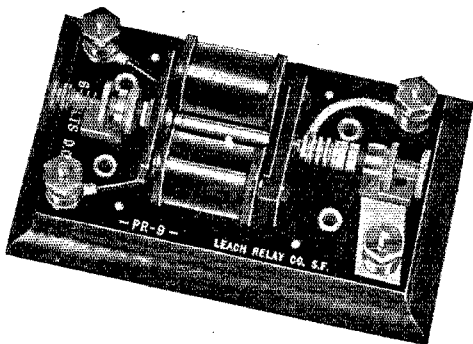
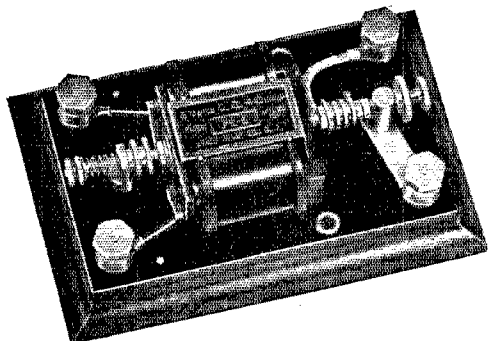

NEW RELAYS for your Transmitter

PR-5

Operates on 6 volts D.C. adjustable to all positions. $\frac{1}{4}$ " pure silver contacts. Lacquered brass finish. $3 \times 5\frac{1}{4}$ " x $\frac{1}{4}$ " Bakelite base. Maple sub-base. Recommended for 250 watts or less.

PRICE \$9.00

PR-9

Operates on 6 volts D.C. Adjustable to all positions. $\frac{3}{8}$ " pure silver contacts. Highly polished nickel finish. Engraved Bakelite base. Maple sub-base. Recommended for 250 watts or over.

PRICE \$12.00

THESE RELAYS ARE EXTREMELY FAST. THEY DO NOT LAG NOR DRAG.
MADE BY MAKERS OF THE FAMOUS "LEACH BREAK-IN RELAY"

LEACH RELAY COMPANY

693 MISSION STREET

SAN FRANCISCO, CALIFORNIA

BOUND VOLUME XI of Q S T

WE have now a limited number of copies of Bound Volume XI of QST. Vol. XI comprises the entire 1927 series of QST. This volume is made up of two books or sections, each containing six issues of QST. This volume is handsomely bound in red cloth and with gold imprint.

The complete volume is priced at \$5.00 postpaid. Better act quickly—only a few copies available.

Q S T

1711 Park St.

Hartford, Ct.

Engineers, Amateurs, Operators, Are You Interested in Separating Signals That Are Only 100 Cycles Apart, and Eliminating 75% of Static, if so, Enclose Postage to P. O. Box 1116, Riverhead, N. Y.

Power Tube Work

REPAIRING AND REXHAUSTING OF ALL SIZE TRANSMITTING TUBES
PRICES UPON APPLICATION

Glenwood Laboratories

142 Market St.

Newark, N. J.

WHOLESALE PRICES

On New Transmitting Apparatus

FLECHTHEIM GUARANTEED TRANSMITTING FILTER CONDENSERS

2 MFD 1000 v. TEST-800 v. WORKING	\$ 2.59
4 MFD 1000 v. TEST-800 v. WORKING	4.59
1 MFD 2000 v. TEST-1500 v. WORKING	2.59
2 MFD 2000 v. TEST-1500 v. WORKING	4.29
4 MFD 2000 v. TEST-1500 v. WORKING	6.89
1 MFD 5000 v. TEST-2500 v. WORKING	4.29
2 MFD 5000 v. TEST-2500 v. WORKING	6.89
4 MFD 5000 v. TEST-2500 v. WORKING	12.89
SANGAMO .0001, .001, .002 MFD 5000 volt	\$1.69
DUBILIER .002 6000 volt	1.95

THORDARSON
ELECTRIC MFG. CO.

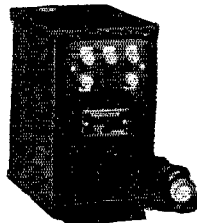

New type transmitting transformers special for this month only—Mounted type special combined plate & filament transformer, 550 volt plate winding—Two $7\frac{1}{2}$ volt filament windings with center-taps. Only \$6.89
 $7\frac{1}{2}$ volt filament transformers, \$8.10
100 Watt, 550 & 750 with mid-tap, plate transformer Special \$12.90
500 Watt Plate Transformer (as per illustration) 1500 & 2000 volts either side of mid-tap, extra special for this month \$22.45

All Merchandise Under 2 M A Guarantee—Money Back if You're Not Satisfied.

Jewell 3 in. Flush Mounting Voltmeters & Milliammeters, any scale reading. List \$7.50. Special for \$5.89
Jewell Thermo-Ammeters, any scale reading \$9.59

RADIO 2MA CO.

168 Washington St.
NEW YORK

The Roanoke Division Convention (North Carolina Section)

Here's How to Check Up On Its True Worth

When you want to know just how good a resistor is, without having to check up on its characteristics in your laboratory, find out who uses it.

Here are a few of the more prominent manufacturers now using Har-field Resistors in large quantities. We recommend that you write for their opinion of Har-field Resistors.

Stromberg-Carlson Telephone Mfg. Co.	Western Union Telegraph Co.
Crosley Radio Corporation	Sonora Phonograph Co.
American Transformer Co.	Conner-Crouse Corp.
Fansteel Products Co.	Magnavox Corporation
Martin Copeland Co.	Electrical Research Laboratories
Splittdorf Electric Co.	Samson Electric Co.

Har-field Resistors are available in various capacities up to 50,000 ohms at 10 or 20 volts. Tell us about the resistor you want, and let us make up a sample for you with prices.

HARDWICK, FIELD, INC.

SALES OFFICE
100 Fifth Ave.
New York City



FACTORY
215 Emmet St.
Newark, N. J.

RADIO OPERATORS WANTED

THE EASTERN RADIO INSTITUTE can train you quickly and thoroughly because:

MODERN AND EFFICIENT METHODS
THOROUGH INSTRUCTION under staff of
LICENSED COMMERCIAL OPERATORS
MODERN APPARATUS including SHORT WAVE
TRANSMITTER

FIFTEEN years a RADIO SCHOOL
THE OLDEST, LARGEST and MOST SUCCESSFUL
school in New England. RECOMMENDED BY THE
A. R. R. L.

Day or Evening Classes Start Every Monday.

SPECIAL CODE CLASSES

Write for Illustrated Prospectus

EASTERN RADIO INSTITUTE

899 BOYLSTON STREET BOSTON, MASS.

Transformers

and
Chokes



Of course Acme builds them
Acme products are nationally
known.

Furnish us with your blue
prints and specifications for
prices.

We invite your inquiries.

Member R.M.A.

The Acme Electric & Mfg. Co.

Established in 1917

1653 Rockwell Ave., Cleveland, Ohio.

A GAIN, the Charlotte Amateur Radio Association did itself "proud" by staging the second annual North Carolina convention on March 2nd and 3rd. The Division had for its guest of honor Secretary-Editor K. B. Warner of the A.R.R.L. who spoke at length on legislative problems and gave a good talk on the technical difficulties with which the amateurs will be confronted when the new narrowed bands go into effect.

E. J. Gluck, 4CQ, also engineer of WBT, had charge of the technical meetings and saw to it that everything moved properly. The gang learned a great deal about meters from the good talk given by Mr. Pollard of the Weston Electrical Instrument Co. Inspection trips were made to the Western Union Telegraph relay office, American Telephone & Telegraph Co. and the Broadcasting Station WBT.

Saturday was, of course, the day of days with contests of all kinds and where clever jokes were played on a number of the gang. 40C, having succeeded in getting 40 watts output from his crystal controlled set with an input of only 20 was arrested for breaking Ohm's law. Director Gravely almost cried when they discovered he had a bottle of Castoria in his pocket. Perkins, 4VQ, impersonated Prof. Taurenwerfer and his paper on Beam Transmitters showed that the editors of *QST* will not have to worry in the future for articles.

The banquet which was held in the Chamber of Commerce brought out some real good eats after which G. D. Bruns, President of the C.A.R.A., spoke on the history of the club and a good talk was given by Joe Garibaldi, a newcomer who donated the use of the land on which the club house is located, on wonders of amateur radio. The good friends who advertise in *QST* were most generous in the donation of prizes for various competitions. The Charlotte Amateur Radio Association wishes to publicly express its appreciation to the manufacturers whose contributions helped make the convention so successful. After the distribution of prizes the fellows did not seem to want to get away and real "rag chewing" continued until long after midnight. We express sympathy to those who could not attend the Roanoke Division Convention.

—R. S. M.

Laboratory Product

**CRESCENT
LAVITE
RESISTANCES**

for Distortionless Amplification

Dual resistance for DeForest "H" tube \$3.50.
Consists of two units mounted on bakelite and connected in parallel. Please specify if your "H" tube requires 50,000 ohms or 20,000 ohms. All amateur apparatus in stock. Let us drill and engrave your panels.

Cresradio Corp., 166-32 Jamaica Ave., Jamaica, N. Y.

HAM-ADS

NOTICE

The "Ham Ad" Department is conducted strictly as a service to the members of the American Radio Relay League, and advertisements will be accepted under the following conditions.

(1) "Ham Ad" advertising will be accepted only from members of the American Radio Relay League.

(2) The signature of the advertisement must be the name of the individual member or his officially assigned call.

(3) Only one advertisement from an individual can be accepted for any issue of QST, and the advertisement must not exceed 100 words.

(4) Advertising shall be of a nature of interest to radio amateurs or experimenters in their pursuance of the art.

(5) No display of any character will be accepted, nor can any typographical arrangement, such as all or part capital letters, be used which would tend to make one advertisement stand out from the others.

(6) The "Ham Ad" rate is 7c per word. Remittance for full amount must accompany copy.

(7) Closing date: the 25th of second month preceding publication date.

THE life blood of your set—plate power. Powerful permanent, infinitely superior to dry cells, lead-acid, Bs, B eliminators, Trouble-free, rugged, abuse proof, that's an Edison Steel-Alkaline Storage, B-battery. Upset electrically welded pure nickel connectors insure absolute quiet. Lithium-Potassium solution (that's no lye). Complete, knock-down kits, parts, chargers. Glass tubes, shock-proof jars, peppy elements, pure nickel, anything you need. No. 12 solid copper enameled permanently perfect aerial wire \$1.00, 100 ft. Silicon steel laminations for that transformer 15c lb. Details, full price list. Frank Murphy, Radio 8ML, 4837 Rockwood Rd., Cleveland, Ohio.

HAWLEY Edison element battery and parts standard for over five years. Look at our patent pending connector—no thin wire to drop off—contains 20 times more metal than regularly used. Heavy shock proof, cells, fibre holders, etc. Everything for a rapid-fire "B" supply. Complete assembled 100 volt "B" \$10.00. Knock-down kits at still lower prices. Chargers that will charge in series up to 160 volts \$2.75 to \$4.00. Trickle B Charger for 90 to 150 volt "B" \$3.75. Special transmitter "B" batteries up to 6,000 milli-amp capacity, any voltage. Write for interesting literature, testimonials, etc. B. Hawley Smith, 360 Washington Ave., Danbury, Conn.

PURE aluminum and lead rectifier elements holes drilled brass screws and nuts, pair 1"x4" 13c, 1"x6" 15c, 1 1/2"x6" 17c, 1 1/2"x6" 19c. Sheet aluminum 1/16" \$1.00, lead \$1.00 square foot prepaid, \$1.00 or more. Silicon transformer steel cut to order .014" 10 lb. 25c, 5 lb. 30c, less than 5 lbs. 55c lb. .022" 5c less per lb. Not cut 2-7" wide 15c lb., minimum 10 lb. postage extra. Edge-wise wound copper ribbon 7 sizes see January QST. Air pocket and stand off insulators 25c each. 4 for \$1.00. Glazed porcelain 5 and 6 1/2" long period on 4. Electrolytic condenser parts, \$1.50 prepaid. Geo. Schulz, Calumet, Michigan.

LICENSED amateurs only—prepaid in U. S.—Aero low wave tuner, \$7.70, transmitting kit, \$7.55, Brielle 36 inch cone \$19.75 kit, \$12.62, Nathaniel Baldwin C headsets, \$5.80. SP122 shielded grid tubes, \$4.75. Power Charostats, \$2.31. Sangamo .001 or .002 5000 volt condensers, \$1.31. Discounts on Cardwell, Formica, Samson, Jewell or Weston (transmitting meters, 25%) 35%. On Sangamo, Daven Karas, Tobe, Amoco, Carter, Ferranti, Yaxley, Hammarlund, Silver Marshall, Bodine, CeCo, Raytheon, 40% REL items, 25%. Weekly experimenters-builders data sheets, 20 weeks, \$1.00, 52 weeks, \$2.50. Over two pounds catalog, data circuits, etc., 25c. Fred Luther Kline, Established 1920, Kent, Ohio.

EDISON element rechargeable "B" batteries deliver pure direct current of low internal resistance. Rechargeable hundreds of times. 100 volt, 3000 milli-ampere battery complete in metal case, wired and assembled \$12.50.

140 volt, \$16.00, 100 volt 1500 milli-ampere complete kit \$8.00. 140 volt \$11.00, 180 volt \$14.00. Complete "B" charger \$2.00. Type "A" elements with welded connector 5c per pair. Type 3-G, 6c. Type 5-G, 9c, 3000 milli-ampere. Prices include separators, Potassium-lithium for 5 lbs. Edison electrolyte 85c. Edison "A" batteries 6 volt, 112 1/2 ampere, \$16.00. Shipped fully charged. J. Zied, 834 North Randolph St., Phila., Pa.

BULLETIN 66-E Lists the Ensall Radio Laboratory receivers, transmitters, wavemeters, etc., Item No. 69 and 68-A type receivers are the most modern types for amateur reception. Four and eight tubes respectively. We also make all types of apparatus for any radio purpose, including inductances, power transformers, rectifier units, filter chokes, high voltage variable condensers, plate reactors, etc. We build to order any apparatus using your parts if desired. Kit and blue print service on any power amateur station. Write for copy of Bulletin 66-E. Thos. Ensall, 1208 Grandview Ave., Warren, Ohio, 8BDN.

USED vacuum cleaner motors 1/2 h.p. 110 volt A.C. or D.C. \$2 each. Ed. Lear, 1574 Fullerton, Detroit.

OMNIGRAPHS, Teleplexes, transmitters, receivers, chokes, meters, transformers, 50 watters, S tubes, motor generators, portable loop receivers, Vibroplexes bought, sold and exchanged. L. J. Ryan, Hannibal, Mo. 9CNS.

ESCO motor generator, latest type, 1500 v. 400 watt \$125.00. Escoc motor generator 1500 v. 600 watt \$100. Both in excellent condition. Aume big 30 Henry double choke 0.3 amps, \$12. Leach Relay, model 18, type S1, \$15.00. 20 Ohm Relay \$3.00. Crystal controlled transmitter 3 stages, in mahogany framed cabinet, entirely copper shielded, contains 8 meters, Cardwell condensers, resistances, etc. 2nd power amplifier, UV203A. Tubes and power supply not included. \$85. Fotos on request. Assortment of Jewell and Weston meters at half price. R. A. Donnelly, 2CPD, Brielle, N. J.

LIBERAL discount on tubes, condensers, short wave coils. Write your wants. Goods shipped C. O. D. Edson Travis, Schenevus, N. Y.

GET QSO with us on Pyrex sockets 35c, UX sockets 15c, Brandes fones \$2.25, telegraph keys \$1.25. Hammarlund condensers \$1.00. Mountford resistances 25c, R.C.A. 2 mfd. condensers 60c, R.C.A. power rheostats 40c. J. W. Gibbons, 2TL, 46 Front St., Port Jervis, N. Y.

TELEVISION tubes for receiving televised pictures by radio \$6.00 each also photo electric cells for television use \$15.00 write about your television requirements Richard X. Daly 2114-29th street, Astoria, Long Island, New York, former radio 1BPP.

QSL cards, plain \$1.00 per hundred. Government cards \$1.85 per hundred. Prompt service. 9BEU, 9032 Windom, St. Johns Sta., St. Louis, Mo.

TUBES, meters, Omnigraphs, etc. bought, sold, exchanged. What have you for sale? What do you need? 0-10 volt a.c. meters \$1.60. Postpaid. Stamp for list. Howard McIntyre, 1218 Tanglewood, Memphis, Tennessee.

SELLING out. Complete fifty watt set and parts. Write for list. 50N, Box 205, Montgomery, Ala.

WRITE for list. Radio parts. 4ABR, Greenville, Tenn.

WILL SELL several Western Electric CW926B speech amplifiers, good condition. Also have large assortment parts Western Electric CW938A combination receivers and transmitters. First reasonable offers accepted. Dwight L. Supernaw, 1159 W. Flagler St., Miami, Fla.

HAM specials—transmitting tubes, 5 watt W. E. V. T. 2, \$6.00. V. T. 14, \$3.50. Kenotrons \$1.50. R.C.A. loops made for Victor Talking Machine Company, \$1.25. And many others. Send for list. Mac, Box 21, Seaford, N. Y.

HAMS—Here's what you are looking for. Tubes, without bases, that are quiet and unusually good oscillators for short wave receivers. Have extra high vacuum. Filament volts, 5; filament amperes, .25; plate volts 22 1/2 to 135. Price \$1.10 each, including postage. Cash with order Duane Hadley, Shelby, Ohio, 8CTD.

WILL sell cheap—t.p.t.g. 40-180 meter transmitter with volt and milliammeter, \$40. Colpits 40 meter transmitter, \$20. Speech amplifier, two stages \$20. 0-250 milliammeter \$3.00. 2 mikes \$2. each. 202, \$2.50. Lots of other parts. Write, Roger H. Hertel, 9CHB, Clay Center, Nebr.

BARGAIN famous DeForest S transmitting tubes excellent oscillators and modulators, filament 10 volts, plate 500. Price \$4.00. New. Include postage. Roger Ayers, 52 Orient Way, Rutherford, N. J.

FOR sale—Thordarson $\frac{1}{2}$ k.w. 10,000-volt transformer, \$6. F.O.B. 3NM, 1111 Jefferson St., Charlottesville, Va. SEND for list of transmitting and receiving parts. I will sell or trade. What have you that you are not using? What do you want to trade them for? Lowell Ecker, Sedan, Kansas.

AERO shortwave receiver. One stage. Coast to coast reception. Quote your offer. Howard Wacker, No. 1 Wood St., Pittsburgh, Penn.

FOR sale—Emerson motor-generator, 1000 volts, 400 watts. Motor 110 volts 60 cycle. Excellent condition, \$78. William Mayer, 58 W. 40th St., New York City.

SELL new Kellogg broadcast microphone. Never used. \$65. John Haren, Schuylerville, N. Y.

SELLING out. My stock of radio parts, including Western Electric IOD and other speakers, cheap. Write for list. W. T. E. Moore, Adairville, Ky.

WESTERN Electric VTI tubes, \$1.00; Bristol single stage power amplifier, \$5.00; Halldorson copper shielded audio transformers, \$1.25. All items postpaid. Write for list. Wm. Wagner, 819 De Kalb Ave., Brooklyn, N. Y.

UV203A used 30 hours at normal load \$20.00. R.C.A. socket, \$1.00. Will trade for other equipment. Rufus Jones, Jr., 1525 N. 15th St., Birmingham, Ala.

SELL—new UP1016, cash, \$15. 1AMC, 35 Munson Ave., Torrington, Conn.

QSL cards two colors, government post cards \$1.90 per hundred, white cards \$1.00. Real ham stationery at \$1.40 per hundred sheets and envelopes, pad form. Postage 10c. Free samples. SDTY, 257 Parker Ave., Buffalo, N. Y.

2500 Volt 150 Watt generator connected to 110 Volt motor \$145.00. 2000 Volt 1000 Watt generator connected to 3 phase 220 Volt motor with separate field exciter \$275.00. 1000 Volt 200 Watt generator connected to 110 Volt motor \$75.00. 750 Volt 300 Watt generator with 110 Volt motor \$65.00. 10 Volt 8 Ampere generator \$12.00. $\frac{1}{4}$ Horsepower 110 Volt motors 1750 speed \$6.50. 3450 speed \$8.50. 1000 Volt generator with 10 Volt filament supply connected to 32 Volt motor \$150.00. Converters 110 DC to 75 AC 200 Watt \$9.50. 300 Watt \$12.50. James Smat, 1734 Grand Ave., Chicago, Ill.

QSL cards: 100 plain cards, 95c; 150, \$1.20; 150 Govt. cards \$2.50. Radiogram blanks, one and two color stationery. H. M. Seiden, Cranseville, Penn.

WESTERN Elec. Condensers tested 440 volts AC, 2-mfd. 40c. 1-mfd, 35c. 1000 volt 1-mfd. \$1. Standard Desk Telephone, without receiver, \$2.50. Telephone Set, 2 transmitters, 2 induction coils, 2 receivers, 2 magnetos, 2 ringers, all standard apparatus, \$5.95. Transmitter button, 55c. G. E. Mercury arc, \$15. 1000 ohm resistance spool, 15c. 12000 ohm Lavite, 85c. 48000 ohm, \$1. Used, but like new. See ad in March issue. B. B. Sadt, 3114 Euclid Ave., Berwyn, Ill.

REAL bargains: 1 new Esco 800 volt 250 watt 110-60 cycle ring oiled motor generator cost 105, sell 49.00 1-80.3 meter SRS crystal guaranteed perfect 15.00. 1—75 watt panel mounted transmitter with 3 Jewell meters keying relay Thordarson filament and plate transformers Dubilier and Cardwell condensers beautifully wired copper tubing including new UX852 tube 85.00 deposit, balance COD. money refunded if not satisfactory. George Nothnagle, Bridgeport, Conn. IXF

FOR sale: My Experimenters Information Service Model "C" Super-Heterodyne complete with tubes, engraved panel, Weston meters, geared vernier attachment, etc. Slightly used. Material cost \$188.00. Will sell \$150.00. NP-4ACF, Aubrey Cecil Levi, St. Thomas, Virgin Islands of United States.

MOTOR repulsion induction General Electric 110-220 single phase 60 cycle A.C. 2hp. with pulley. Guarantee-factory condition. \$55.00. 3FD, Philadelphia, Penn.

THE response to our last hamad was simply overwhelming. We had a hard time keeping up with the demand. And why not? Look at this complete line of meters for you. Milliameters: 0-10, 0-25, 0-50, 0-100, 0-300, 0-400 only \$1.80 each. AC voltmeters: 0-6 or 0-10, \$2.25. 0-15, \$2.75. Line meter 0-150, \$4.75. DC voltmeters 0-100, \$1.00. 0-300, \$4.50. 0-500, \$4.75. Cooper Hewitt Neon lamps. The perfect Neon lamp equipped with a standard base, yet small in size glows a very brilliant red. Worthy to be put in the best of frequency or wave meters. Unconditionally guaranteed, for 3000 hours, \$1.50 each. C.O.D. on request. E. P. Hufnagel, 879 S. 18th St., Newark, N. J.

25 WATTERS! The new type 250. A big special at \$10.00, list \$12.00. Standard make—no bootlegs—absolutely guaranteed. Any tube proving defective will be replaced, as long as filament lights. William Galvin, Greenfield, Mass.

SELL—New "H" tube, \$10.00. Set of Aero coils, new, \$7.00. See last month's ad. 9EYT.

WESTINGHOUSE MG 110 AC 500 DC \$25.00. Dynamotor 6 volts 400 D.C. \$15.00. 1 K. M. 2 Park Ave., Malden, Mass.

SELL—Weston 0.500 milliammeter \$4.00. Jewell 0-15 A.C. voltmeter, \$4.00, 150 watt Acme filament transformer, \$9.00. R.C.A. 75 watt filament transformer, Cardwell double spaced variable condenser. .00025, \$2.75. .0005, \$3.50. R.C.A. filament rheostat PT537, \$3.00. Manhattan Jr. speaker, \$2.75. Complete 7.5 watt transmitter. Harold Campbell, 66 Vine St., Bridgeport, Conn.

TO trade—complete parts for 4 tube shield grid receiver for transmitting tubes or parts. Also Grebe Synchrophase five with battery base; used as demonstrator. \$65.00. Kenneth Alley, Carthage, Ill.

POSTPAID and guaranteed brand new. Readrite panel mounting, flush type, Milliammeters. Your choice of either 0-300 or 0-400 range, \$1.00. Readrite 0-15 A.C. Voltmeters, flush type, \$3.00. R.E.L. 2000 volt working voltage filter condensers, 1 mfd., \$3.10; 2 mfd., \$5.50. Sangamo .002 Mfd. condensers, 5000 volt tested, \$1.75. General Electric 5000 ohm Heavy Duty Grid leaks, \$1.25. General Radio Wavemeters, Type 358, \$19.25. Write for other prices. G. F. Hall, 535 West Hortter St., Philadelphia, Pa.

CURTIS-Griffith 250-watt power-filament transformers 350-550 each side \$10.50. Thordarson 650-volt power-filament for 7.5-watters \$6.90. New Thordarson power-filament transformer 550-volts, two $\frac{7}{8}$ watt filaments \$20.00. Thordarson power transformers 550-750 each side \$16.00; 1000-1500 each side \$22.00. Aluminum square foot 85c; Lead square foot 85c. Potter 2-mfd 1000-volt condensers \$2.75. ARRL Handbooks \$1.00. Amateur Callbooks \$1.00. New "Ham-List" 4c. James Radio Curtis, 5-A-Q-C, 1109 Eighth Avenue, Fort Worth, Texas.

HEADQUARTERS for hams:—Mueller 150-watt input tubes \$15.00. UV202 5-watters \$3.15. Complete 5-watt transmitters:—tubes, transformer, rectifier, key, etc. for 20-40 meters, each \$35.00. 20-40 meter receiver and one step \$17.50. Aerovox 1000-volt tested 1-mfd condensers \$1.75. Potter 2000-volt tested 1-mfd \$2.50; 2500-volt 1-mfd \$3.25. "Ham-List" 4c. Robert Curtis, 1109 Eighth Avenue, Fort Worth, Texas.

HERE'S the bargain you've been looking for; Readrite panel mounting meters, 0-15 A.C. voltmeters \$2.00; 0-100, 0-400 milliammeters 90c. R.C.A. 5 watters \$2.20. Used scientific books $\frac{1}{2}$ off. Postage 15c. Write for "Ham-sheet." Kenneth Hanifan, Waterville, Ohio.

BANKRUPT stock: New transmitters and receivers 8 to 75 watt, built for service at WRB, WRP and WFV, and \$1000 worth parts for sale below cost. Lists and photos on request. Cardwell 17 plate \$1.40. Marco illuminated controls, \$1.75. Federal jacks 15c. All original cartons. Quarter kilowatt 500 cycle generators \$20. With 110 volt DC drive \$27.50. Dynamotor 12/750. In shielded case, \$35. Suresync, \$30. No. 38 and No. 40 DSC wire, for RF chokes 10c per 100'. C.O.D.'s. E. G. Watts, Jr., 1024 Southwest Ninth St., Miami, Fla.

TELEPLEX, for sale with 6 rolls of tape. Almost new and in good condition. \$10. takes it. M. R. Gonzuler, Box 345, Blythe, Calif.

WANTED—G. E. 203A in good condition. Write radio 5AQT, 1504 Crockett St., Marshall, Tex.

TRANSFORMERS—325-325 filament $7\frac{1}{2}$ and $7\frac{1}{2}$, \$6.00. 325-325- $7\frac{1}{2}$ \$5.50. 275-275-5 \$4.00. 100 watt for any filament \$5.00. Knockdown with primary only 100 watt \$3.00. 50 watt \$2.50. 100 or 50 watt specials made to order. Chokes—30H 100MA, \$2.00; 30H 60 MA \$1.50, 3H 1 ampere \$3.25. 100 watt core \$2.00. Adjustable core 160 MA choke, 30 to 150H \$5.00. One Westinghouse D'Arsonval shielded galvanometer 0-100 microamperes, \$15.00. All parts for "BC" eliminator 180V \$17.75, 425V \$25.75. A.B.C. eliminator parts 180V with all filament supplies, \$19.75. Diagrams and lists on request. M. Leitch, Park Drive, W. Orange, N. J.

GENERAL Electric 12-350 volt .143 ampere \$18. Westinghouse 10-350 volt .08 ampere \$20. $\frac{1}{2}$ KW 500 cycle transformers good for any voltage \$12.50. 500 cycle generators and gasoline engine power units. New SE1012 receivers no condensers \$20. Henry Kienzle 501 East 84th Street New York.

7PT O'Reilly reports "Long time anchored at 5 per. Two evenings with your Shortkut raised to 12 and in one week was copying 20 per". Any key and buzzer failure may profit by experience of 7PT and make the grade. See display ad this magazine. C. K. Dodge, Mamaroneck, N. Y.

7DF selling out. 1/4 k.w. and 75 watt transmitters, two mercury arc rectifiers, wavemeter and receivers. Will sell in parts. Write for list and price. Chas. Nagata, Box 815, Auburn, Wash.

TWO RCA 1626, 25 Henry 160 mil. choke coils, \$8. each. Want good 203A or 852. State your proposition. SANC. Charleroi, Penn.

ATTENTION Hams! How would you like to spend your vacation up here where Lake Michigan breezes fan you all summer and at the same time prepare yourself for a Commercial ticket? 8LA is running a special course exclusively for licensed amateurs during July and August. For detailed information write—C. O. Slyfield, 8LA, Frankfort, Michigan.

FOR sale: one Amrad antenna switch, \$1; one 1 HP General Electric 110 volt motor, \$25; one 500 cycle motor generator set, 110 volt DC motor, 250 volt 1/2 KW generator \$25; two Fleron pillar insulators, \$1 each; 1 Jewell pattern 74 0-10 AC voltmeter, \$9; one Jewell pattern 64 0-3 thermoammeter, \$9; one forty watt UX280 B eliminator transformer, \$5; one sixty watt UX 216B half wave B eliminator transformer, \$6; Western Electric 294W microphones and stands, \$4; RCA UL1655 radio frequency chokes, \$1; two hundred watt UX 216B full wave transmitting transformers, \$12.50; fifty henry 100 milliamperer transmitting chokes, \$5.50. Wm. M. Derrick, 80 Leslie Street, East Orange, N. J.

SELL fifteen G. E. transformers, 1100-2200 each side tap, carry 1000W continuously. Guaranteed. 110-220 primary mounted on marble for wall inside. \$12.00. F. O. B. Detroit. F. G. Dawson, 5740 Woodrow Ave., Detroit, Mich.

FOR sale: New 204 tube, 250 watts, \$40. Guaranteed O. K. No. 2 Jr. Omnigraph; extra set dials, A1 condition \$15. Vibroplex \$25. Radio model, new, only \$12. Western Electric desk microphone No. 284, \$5. H. C. Wing, Greenfield, Mass.

NEW Morton Electric Company motor generator sets 1000V, 200W, \$50.00. 750V, 200W, \$45.00. *F. O. B. Chicago. 110V, 60 cycle single phase motor drive wick-offed 4 bearing units. All sets guaranteed. A. Forbes, 4832 Rice St., Chicago, Ill.

DILETTANTES—Obtain your radio apparatus here. Unapproachable equipment. Power Radio Wavemeters, 17-160 Meters—\$5.00. Plate Filament transformers; for UX210s—\$6.25; For fifties—\$9.00. Transmitting tubes; fifty watts—\$9.00, ten watts—\$4.90, seven watts—\$4.00. UX852s—\$32.00. Panel-mount milliameters: 0-10—\$3.00; 0-100, 0-300, 0-400—\$2.00. AC Voltmeters: 0-10, 0-15—\$2.00. Fada Power rheostats—45c. Standoff insulators—20c. 10" insulators—65c. General Radio Wavemeters—\$18.50. RFL Transmitting inductances—\$3.50, REL Receiving coil sets—\$3.00. Rectifier elements, aluminum, lead paired: 1"x4"—7c, 1"x6"—10c. QSL cards, two colours, \$1.00 per 100. Free Radio Catalogue and QSL samples. William Green, 207 Cathedral Parkway, N. Y. City.

SELL or trade: Nearly new Advance sync, 80 meter crystal, 9CVY, Butler, Mo.

THE ideal rectifier, Rectobulbs. Order them and National transmitting tubes from us. Burnt out tubes repaired. We have a new line of guaranteed crystals. One in the 80 meter band \$17.50. Other frequencies can be furnished. Flechtheim filter condensers 35% off. We have a complete stock of transmitting apparatus and we are a reliable supply house not a cut-rate concern. Write us for our prices and for anything you need. R. E. Henry, 9ARA, Butler, Mo.

MOTOR generator bargains almost new 750 Volt 200 Watt Robbins and Myers direct connected on iron base to 110 Volt 60 cycle single phase alternating motor \$45.00. 400 Volt 100 watt direct connected to 110 Volt 60 Cycle motor \$32.50. Five 400 Volt 150 watt 3500 Speed Emerson generators only with field resistance each \$9.50. Three 110 Volt 3500 speed alternating current motors with coupling to direct connect to above generators or any machine having a 1/2 inch shaft 1/3 H.P. each \$11.00, also a few larger generators and motor generators. George H. Harris, 1911 Chicago Av., Chicago, Ill.

POWER transformers—250 watt 550-700 each side, \$10.50, 500 watt 2000-2500 each side, \$18.00. Look for our dis-

play ad in this QST. \$2.00 extra for filament winding. 9CES, 1927 S. Peoria St., Chicago, Ill.

QUALITY rectifier elements, heavy chemically-pure machine cut lead and aluminum, strongly bolted, perfect connections; Pair 1"x4" 15c; 1"x6" 18c; 1 1/2"x6" 20c. Amateur receivers made of standard parts, REL, Bremer-Tully, General Radio etc, 15-100 meters; Two tube \$20, Three tube \$27. All above brand new. Also slightly used Acme 600 Watt trans, 1,000 1,500 volt & fl windings. \$28. Transmitter 7 1/2 watts \$25. Relay \$5. REL No. 130 receiver complete \$25. William C. Uzzell, 85-12 165th St., Jamaica, N. Y.

WANTED—Navy standard receivers: SE143, SE1220, SE1420, IP500, IP501 State exactly condition and price. For sale: Navy standard spark transmitters of all kinds. Dubilier condensers 12,500 volts .004 \$22.00. Half kilowatt 120 volt DC; 500 cycle AC motor generators \$40.00; New CN113A receivers 250 to 2500 meters, \$15.00; SE-1012 receivers almost new 50-1000 meters, \$30.00 Transformers 500 cycle, easily mid-tapped \$15.00 Weston 301 0-1000 DC voltmeter new \$17.00; Weston meters Models 156 and 24 \$10.00 or what do you want? Paul Trautwein, 17 Albany Street, New York.

THE new, improved Master Radio Wavemeter is now available. Send for description and price. Also send for details of free wavemeter offer. Specials: Fada 3 1/2 amp. power rheostats, 45c, Marco 4" Bakelite Vernier dials \$1.25, Brandes phones \$2.25. DeForest 201As, 90c, Dubilier .002, 6000 volt mica condensers \$1.80. Copper tubing inductance and pure rectifier elements in stock. During the past few months our triple policy of "Quick Service," "Quality Merchandise" and "Lowest Prices" has won us hundreds of new customers. Try us and notice the difference. Send for free catalog. Prices f.o.b. N. Y. William Harrison, 35 Ft. Washington Ave., New York City.

HELLO hams! Here are some more of Ben's real buys. High pitch buzzers, (adjustable) \$1.00, Screen grid R.C.A. tubes, \$5.50, four slide tuner coils, 75c, General Radio .0025 mfd. condensers, \$1.00, Aerial lightning switches, SPDT, 50c, Signal change-over switches, \$2.25, .001-1000 volt fixed condensers, 49c. A few left, telegraph keys @ 75c, Cootie keys, \$5.50, honey-comb 3 coil mountings, \$3.25, honey-comb coils 35c and up, Aeroplane cloth speaker kit, \$11.50, Pyrex glass, 7 1/2 watt socket, 45c, anti-capacity Federal switches, \$1.50 and up. Free with each \$2.00 order—one Eaton Oscillator, P. P. and express extra. Ben Wolf, 223 Tremont St., Boston, Mass.

Q R A SECTION

50c straight with copy in following address form only:

1AVU—Harry O. Barschdorf, 171 N. Summer St., Adams, Mass.

1CSX—R. O. Mortenson, 171 Cherry St., Malden, Mass.

1WV—Miles W. Weeks, 40 Norfolk Road, Chestnut Hill, Brookline, Mass.

2ANS—Harold H. Deeves, 22 Lafayette St., New Rochelle, N. Y.

2AQL—Robert C. Allison, No. 6 Mitchell Ave., Yonkers, N. Y.

2BHI—Walter E. de Banke, 9415-214 St., Queens Village, L. I. N. Y.

2BUO—Werner H. Olpe, 14 Brooklyn Ave., Jamaica, Long Island, N. Y.

4AFC—Ralph Hollis, Box 2184 Sta. A., Headquarters Fire Department, Palm Beach, Fla.

6DZL—Richard Mead, 814 Orange Grove Ave., Burbank, Calif.

60T—Oakland Radio Club, Hotel Leamington, Oakland, Calif.

7ABD—Geo. F. Peckham, Jr., P. O. Box 458, Medford, Oregon.

sb2IA—Ruben Simas, Rua Riachuelo 19, Curitiba, Brazil.

xenOCP—Dutch Section I.A.R.U., Hoogduin, Noordwyk aan Zee, Holland.

The following stations belong to members of the A.R.R.L. Headquarters gang. Mail for them should be addressed care A.R.R.L., Hartford, Conn. When operating 1MK they use personal sines as indicated.

1MK Headquarters, Chief 1RTZ C. C. Rodimon "rod"

Operator, R. B. Parmenter 1BUD A. L. Budlong "bud"

"mp" 1ES A. A. Hebert "ah"

1AL H. P. Westman "ws" 1KP F. C. Beckley "beek"

1BDI F. E. Handy "fh" 1FL G. D. Meserve "dm"

1BHW K. B. Warner "kb" 1SZ C. C. Rodimon "rod"

How to be a commercial radio operator

A practical book that should enable anyone of average intelligence to pass the Government's theoretical examination given to applicants for a Commercial Radio Operator's License.

NEW! Nilson and Hornung's PRACTICAL RADIO TELEGRAPHY

380 pages, 5x8, 223 illustrations
\$3.00 net, postpaid

The book covers in detail the theory and practical operation of every type of modern, 1928, commercial arc, spark, and vacuum tube transmitter. It furnishes complete data on commercial vacuum tube receivers. It covers everything from elementary electricity to the practical operation of radio compasses.

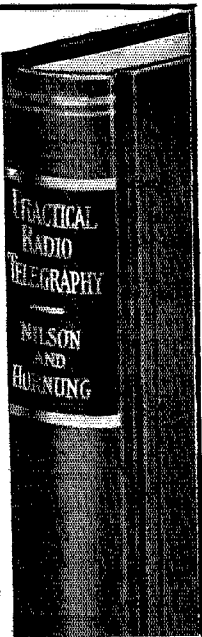

8 good reasons why you will want to examine this book for 10 days FREE

- 1—almost no mathematics. The use of mathematics is limited to a few simple equations;
- 2—the discussion opens with a thorough but clear presentation of the principles of elementary electricity.
- 3—the book covers in detail spark, arc, and vacuum tube transmitters in use today;
- 4—every chapter ends with a stimulating set of self-examination questions covering all points;
- 5—all theory is presented as simply as is consistent with rigid accuracy;
- 6—contains wiring diagrams of modern commercial radio telegraph transmitters and receivers of all types;
- 7—it is indispensable to men intending to take the Government Radio Operator's License examination;
- 8—the labelled illustrations are invaluable for reference purposes to practicing operators;

The book answers such questions as:

- what kind of vapor is emitted between the electrodes of an arc transmitter?
- how would you proceed to operate an R. C. A. 500-Watt Tube Transmitter?
- how would you place the Independent Arc Transmitter into operation?
- how would you proceed to ascertain your ship's position with a Kolster Radio Compass?
- Etc., etc., etc., etc.

McGraw-Hill FREE EXAMINATION COUPON

McGraw-Hill Book Co., Inc.,
370 Seventh Avenue,
New York, N. Y.

You may send me Nilson and Hornung's PRACTICAL RADIO TELEGRAPHY, \$3.00 net, postpaid. I will either return the book, postage prepaid, in 10 days, or remit for it at that time.

Name
St. & No.
City
State
Name of Employer
Official Position
(Books sent on approval in the U.S. and Canada only)
QST 5-1-28

FOR YOUR CONVENIENCE QST'S INDEX OF ADVERTISERS IN THIS ISSUE

Acme Elec. & Mfg Company	32, 90
Acme Wire Company	63
Aero Products, Inc.	3rd cover
Aerovox Wireless Corp.	96
Aluminum Company of America	65
American Mechanical Labs.	81
American Sales Company	84, 95
American Transformer Company	87
Amrad Corporation	69
Auriema, Inc., Ad.	74
A. R. R. L. Application Blank	79
A. B. R. L. Handbook	75
Badger, Inc., Gordon R.	77
Burgess Battery Company	4th cover
Candler System Company	85
Cardwell Mfg. Corp., Allen D.	67
Central Radio Labs.	84
Chicago Radio Apparatus Company	80
Corning Glass Works	79
Cresradio Corporation	90
Crosley Radio Corporation	86
Cunningham, Inc., E. T.	66
Deutschmann Company, Tohe	88
Dodge, C. K.	82
Doogan Elec. Mfg. Company	64
Eastern Radio Institute	90
East Sales Company	78
Electric Specialty Company	85
Fanmill Radio Company, Inc.	76
Fanstel Products Company	83
Frost, Inc., Herbert H.	80
General Radio Company	2nd cover
Glenwood Laboratories	89
Grebe & Company, A. H.	4
Greben, F.	87
Gulf Radio School	88
Hardwick, Field, Inc.	90
Jewell Electrical Instrument Co.	81
Johnson Company, E. F.	84
Karas Electric Company	78
Kruse, Robert S.	84
Leach Relay Company	89
Leeds Radio Company	87
Loomis Publishing Company	88
Massachusetts Radio & Telegraph School	86
McGraw-Hill Book Company	94
National Company, Inc.	72
National Radio Tube Co.	70
Orange Research Labs.	82
Patent Electric Company	86
Photo Electric Devices, Inc.	74
QST Bound Volumes	89
Radio ZMA Company	89
Radio Engineering Labs.	75
Radio Institute of America	68
Rectifier Engineering Service	86
Rooney, J. T.	88
Sangamo Electric Company	82
Scientific Radio Service	87
Shure Radio Company	81
Stromberg-Carlson Telephone Mfg. Co.	2
Telex Company	81
Thordarson Electric Mfg. Company	1
Utility Radio Company	87
Vibroplex Company	85
Ward Leonard Elec. Co.	77
Well's Curiosity Shop	83
Weston Electrical Instrument Corp.	83
Wireless Specialty Apparatus Co.	72
X-L Radio Labs.	88
Yaxley Mfg. Company	76



UNI-RECTRON POWER AMPLIFIERS



MODEL AP-935

As the Uni-Rectron stands it is a super power amplifier, which can be used in connection with any radio set and loud speaker. Binding posts are provided for input to the Uni-Rectron and output to the speaker. Requires no batteries for its operation. It obtains its power from the 110 Volt, 60 Cycle alternating current lighting circuit of your house.

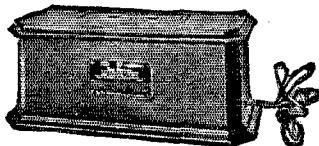

The UX-210 super power amplifying tube and the UX-216B or 281 rectifying tube are used with this amplifier, which cannot overload. From the faintest whisper to the loudest crash of sound—R.C.A. Uni-Rectron amplifies each note at its true value. High and low notes are all treated alike.

The volume and quality delivered will be a revelation.

Also by removing the input and output transformers it can be used as a source of power for an oscillating or transmitting tube, furnishing power for all circuits, grid, plate and filament and is the cheapest form of Power Supply for Amateur Transmitting purposes ever offered. New.

LIST PRICE \$88.50
(Without Tubes)

SPECIAL at \$19.⁷⁵ EA.

JEWELL HIGH-RESISTANCE VOLTMETER

0-250 VOLTS D. C. (3 Readings)

A high grade, accurate, reliable instrument.

Just what you want for checking the true operation of your "B" Eliminator or any source of plate voltage which cannot be obtained from ordinary low resistance type meters.

Can be permanently placed in the set which will enable the user to apply desired plate voltage accurately to each circuit of his receiver. By means of the front switch three readings can be obtained without disconnecting any wires, namely; the detector circuit, the radio frequency or intermediate circuit,

and the maximum or output circuit including last audio tube. Requires little current to operate due to its high internal resistance. Flush Panel Mounting. Zero Adjuster. *New and packed in original cartons.*

List \$22.00 Ea. SPECIAL at \$4.⁷⁵ EA.

HIGH VOLTAGE FILTER CONDENSERS

Manufactured by Dubilier Condenser & Radio Corp.

1 3/4 mfd. 1000 volts rated D. C. Working Voltage Extra Special at **\$1.35** each

7 mfd. 600 volts rated D. C. Working Voltage Extra Special at **\$3.50** each

Manufactured by Stromberg-Carlson Tel. Mfg. Co.

3 1/2 mfd. 600 volts rated D. C. Working Voltage Extra Special at **\$1.75** each

Manufactured by Radio Corp. of America

2 mfd. 300 volts rated D. C. Working Voltage Extra Special at **65c** each

(Used but guaranteed as rated)

All of these High Quality Filter Condensers are new unless otherwise specified. They are excellent for use in your Transmitter, Eliminator or Experimental Work.

KENOTRON RECTIFYING TUBES

(TYPE T. B. 1)

MFD. BY GENERAL ELEC. CO.

These rectifying tubes operate on a filament voltage from 8 to 10 Volts and draw 1 1/2 amps. They will safely stand an A.C. input voltage up to 750 Volts and pass plenty of current and voltage for the plate of the Transmitting Tubes.

They are also very efficient rectifiers for use in "B" Battery Eliminators.

STANDARD BASE
NEW IN ORIGINAL CARTONS

PRICE ONLY \$1.²⁵ EA.

LAST MINUTE SPECIALS

Earo BRADLEYSTATS, list \$4.00

MESCO Wireless Keys, list \$2.00

U. S. ARMY Aeroplane Spark Transmitters, Gov. cost \$47 each

Our Price **\$1.60** ea.

Our Price **95c** ea.

Our Price **\$4.75** ea.

AMERICAN SALES CO., 19-21 Warren St., New York City

PYROHM

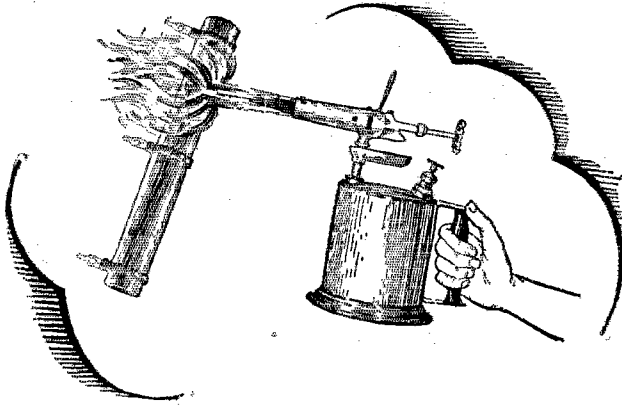

The Resistance You Can't Burn Out

Unless you abuse it with a blowtorch or a tremendous and continuous overload.

Aerovox Pyrohms (Vitreous enamelled resistors) are unaffected by atmospheric conditions, will not oxidize, will last longer and give better all around satisfaction.

The "Aerovox Research Worker" contains much useful operating information. Send your QRA for a copy.

We will gladly submit samples of Pyrohms built to any manufacturer's specifications

AEROVOX

"Built Better"

70 Washington St., Brooklyn, N. Y.

AERO COIL

SUPER-SENSITIVE INDUCTANCE UNITS

The Perfect Inductances for All Low Wave Work

**FOR
RECEIVING**

AERO LOW WAVE TUNER KIT

Price \$12.50

Completely interchangeable. Adopted by experts and amateurs everywhere. Range 15 to 130 meters. Includes 3 coils and base mounting, covering U.S. bands, 20, 40 and 80 meters. You can increase or decrease the range of this

short wave tuner by securing the AERO Interchangeable Coils described below. All coils fit the same base and use the same condensers. Use Code No. INT-125 in ordering.

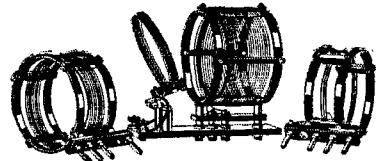

PRICE \$12.50

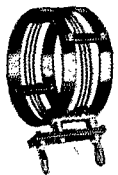

INTERCHANGEABLE Coil No. 0

Range 13 to 29.4 meters. This is the most efficient inductance for this low band. Code number INT-0.

Price \$4.00

INTERCHANGEABLE Coil No. 4

Range 125 to 250 meters. Fits same base supplied with low tuner kit. Code number INT-No. 4.

Price \$4.00

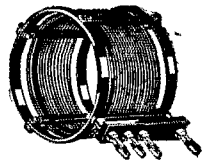

THE NEW AERO INTERCHANGEABLE COIL No. 5

Normal range 235 to 550 meters. However, by using .0001 Sangamo fixed condenser across the rotor and stator of the .00014 variable condenser, the maximum wave band of this coil is increased to 725 meters. This gives you coverage of the following bands: Airplane to Airplane, Land to Airplane, Ship to Shore (Great Lakes) Ship to Shore (Atlantic and Pacific Oceans). Code number INT-No. 5.

Price \$4.00

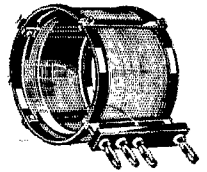

NOTE This new Aero Short Wave Kit is wound with No. 16 wire on secondary, making it even stronger, and cutting down the resistance appreciably,

**FOR
TRANSMIT-
TING**

KEY 2040 KIT

Price \$12.00

Kit contains 2 AERO Coils, 17 to 50 meters each, 1 AERO Antenna Coil Mounting Base, 1 AERO Grid Coil Mounting Base, 2 AERO Essential Choke Coils.

KEY 4080 KIT

Price \$12.00

Kit contains 2 AERO Coils, 36 to 90 meters each, 1 AERO Antenna Coil Mounting Base, 1 AERO Grid Coil Mounting Base, 2 AERO Essential Choke Coils.

KEY 9018 KIT

Price \$12.00

Completely interchangeable with either of above kits. Range 90 to 180 meters. Contains 2 coils and mounting base.

COMPLETE AERO TRANSMITTER KITS

Complete Aero Transmitting Coils for the 20-40 and 40-80 bands, \$20.00. Complete for 20-40, 40-80, and 90-180 bands, \$28.00.

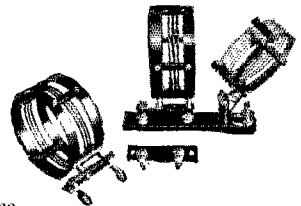
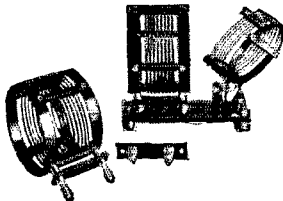

AERO PARTS

Transmitter coils (17 to 50 meters, Key 2040C, 36 to 90 meters, Key 4080C and 90 to 180 meters, Key 9018C) \$4.00 ea.
Antenna Base, Key PRI-300, \$3.00 ea.
Grid Coil Base, Key GRID-100, \$1.00 ea.
Choke Coils, \$1.50 ea.



PLAN FOR D. X. RECORDS NOW!

Order these coils direct from us if your dealer hasn't them and start now for wonderful records. Specify code or key numbers when ordering. Or write at once for complete descriptive literature.

AERO PRODUCTS, Inc.

Dept. 16

1772 WILSON AVE., CHICAGO, ILL.

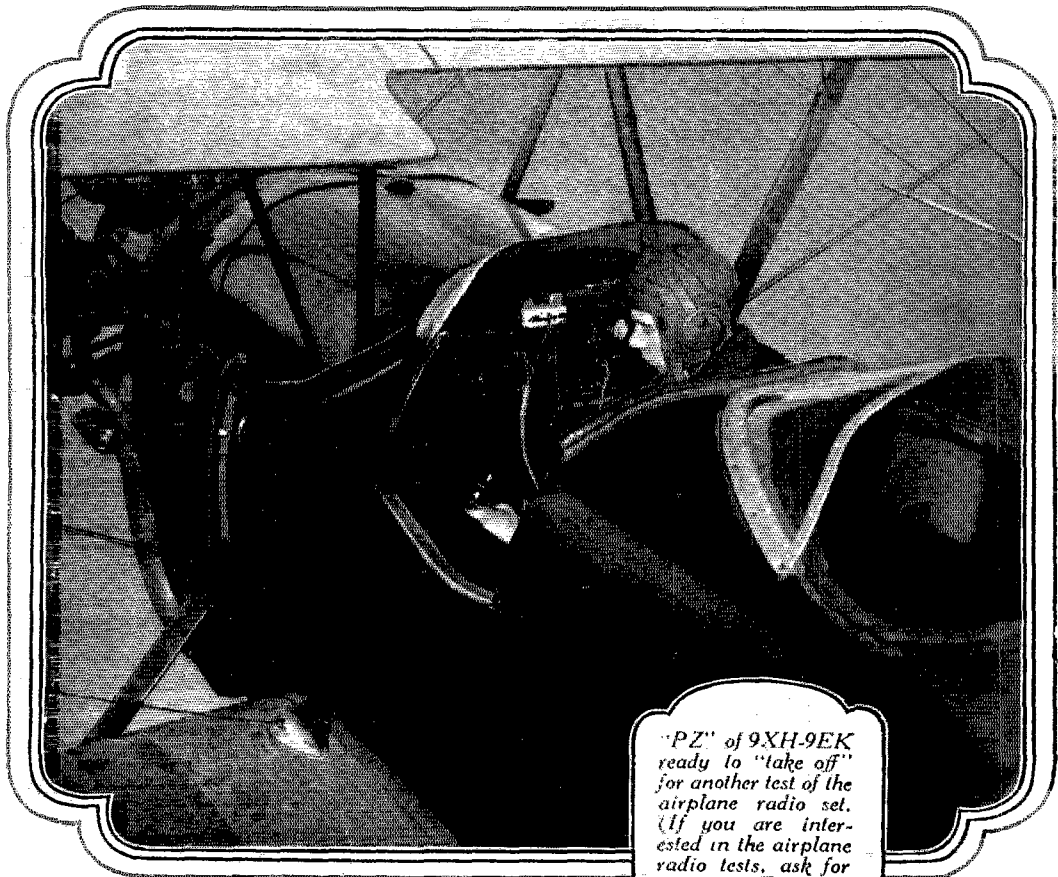

"PZ" of 9XH-9EK
 ready to "take off"
 for another test of the
 airplane radio set.
 (If you are inter-
 ested in the airplane
 radio tests, ask for
 a copy of Engineer-
 ing Circular No. 15.)

FOR years the Burgess Organiza-
 tions have been doing a great
 deal of experimental and research
 work looking toward the advance-
 ment of radio art. The aircraft radio
 communication tests on high fre-
 quency, recently conducted by
 9XH-9EK, while somewhat spec-
 tacular brought out some hereto-
 fore unknown phe-
 nomena. All of this
 information as well
 as the results of
 many other experi-
 ments of interest

"Ask Any

and value have been made avail-
 able, in the form of Burgess Engi-
 neering Circulars distributed freely,
 to those who are interested in ex-
 perimentation.

We feel that some of this work has
 resulted in real benefit to radio in
 general and to the radio amateur in
 particular and what-
 ever measure of suc-
 cess our work has
 had is a spur to re-
 newed efforts along
 these lines.

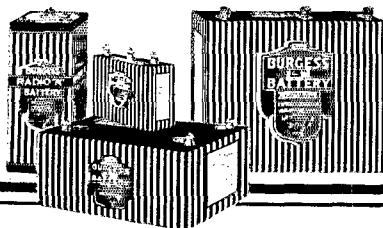

Radio Engineer"

BURGESS BATTERY COMPANY

MADISON,

WISCONSIN