

# QST

march, 1935

25 cents

devoted entirely to

# amateur radio

*In this Issue—*

**Special  
Articles on  
Modulation  
Systems**

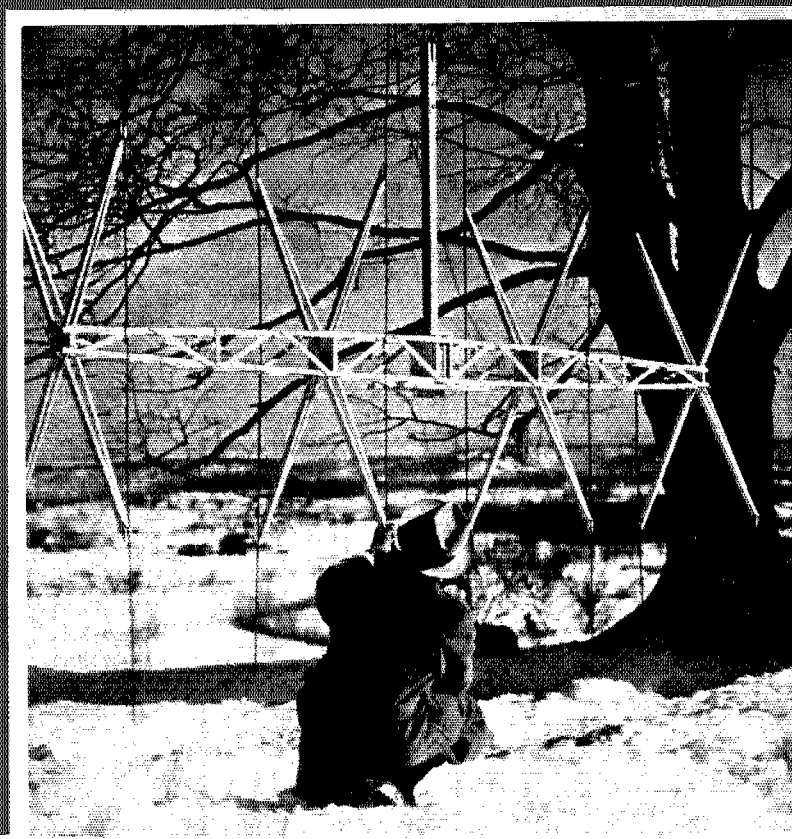

# Superlatives May Sell Soap . . .

**But** the reason for the increasing popularity of COLLINS RADIO Type 30-FXB Transmitter is due to a few simple facts. It is capable of putting 100 watts of useful energy into any standard amateur antenna, either on CW or Phone . . . It has a speech amplifier really flat from 30 to 10,000 cycles . . . A modulation system actually capable of 100% modulation with less than 5% distortion . . . An antenna matching network which makes for maximum transfer of energy and proper attenuation of harmonics . . . A neutralizing system that's fixed at the factory (changes from one band to another can be made without tinkering

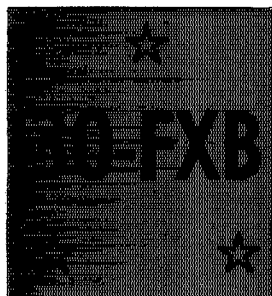

with a ticklish neutralizing condenser) . . . A power supply with decent regulation and the same kind of sound construction and painstaking care which went into those COLLINS transmitters which are perking along on the tough communication jobs the world over. *That's what sells COLLINS transmitters . . . not superlatives . . . and that's why more and more amateurs are ordering Type 30-FXB Transmitters.* Mail COLLINS RADIO a card and complete data on this moderately priced transmitter will be sent to you.

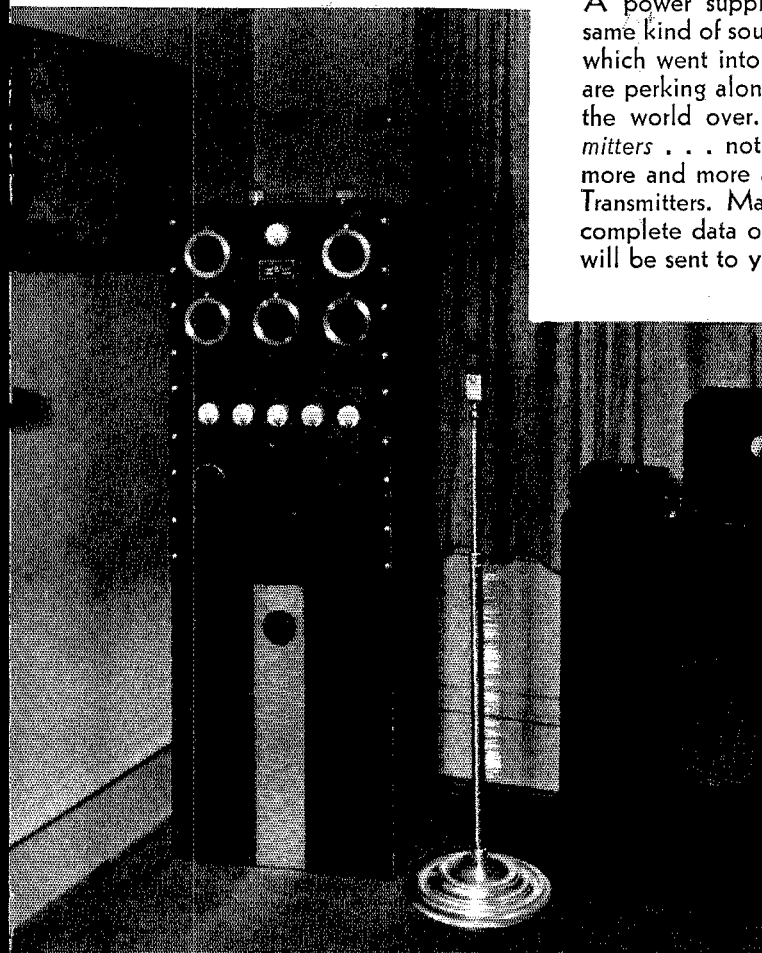

*Here is shown a typical Type 30-FXB Installation in the home of a well-known amateur — note its pleasing lines and the ease with which it fits into the well-appointed home.*



**COLLINS RADIO COMPANY**

CEDAR RAPIDS  IOWA, U.S.A.

New York Office: 11 West 42nd Street

# Variable I.F. COUPLING

*provides SELECTIVITY or FIDELITY, as you choose*

HAMMARLUND

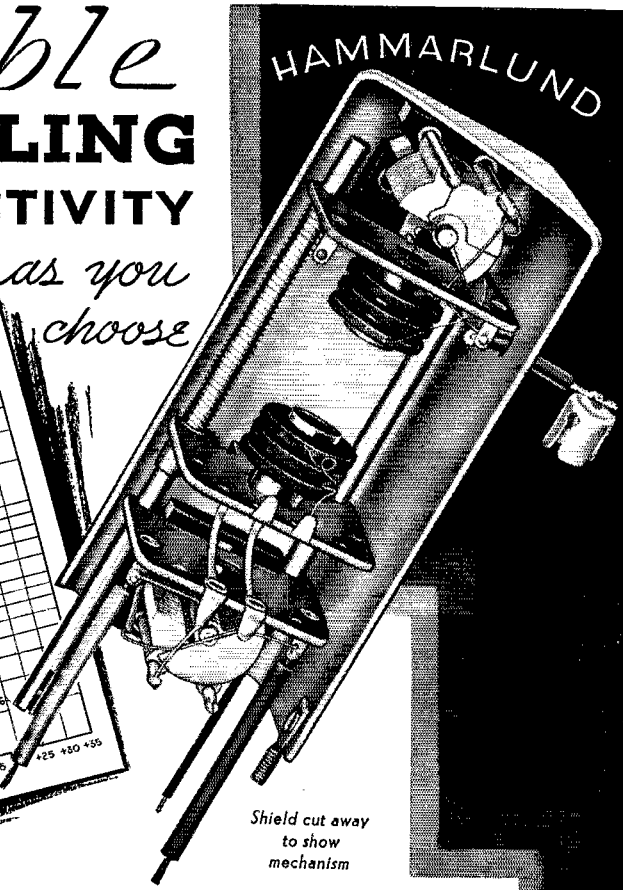
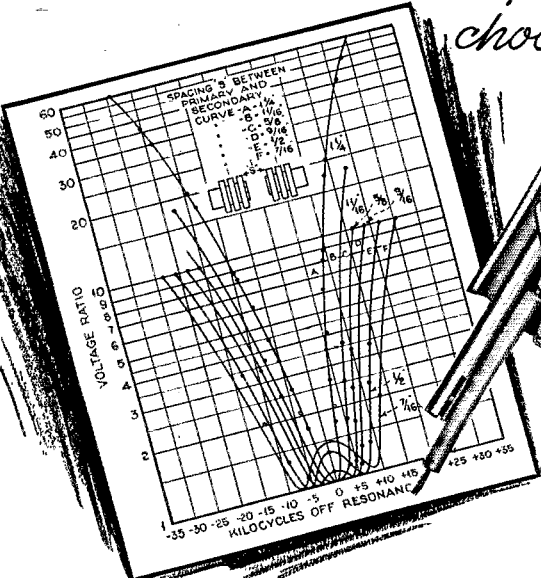

Shield cut away to show mechanism

**N**OW, the greatest single improvement in receiver flexibility in recent years.

**CONTINUOUSLY VARIABLE SELECTIVITY**, from a needle-sharp peak to the flat top required for fidelity — *without affecting tuning.*

The transformer, basically, is the time-tested Hammarlund I.F.T. design, with new triple-type, pie-wound Litz coils and air-dielectric condensers. Plus the startling feature of *continuously variable coupling between the coils.*

Adjustment of coupling in each

transformer may be fixed at any point, or continuously varied by panel-control, either individually or ganged in groups, according to selectivity desired. The diagram shows the variable selectivity characteristics of a single transformer only.

Designed primarily for use in the new COMET Super-"PRO" Receiver, soon to be announced, these transformers may easily be adapted to other superheterodynes.

Code No. VT-465 (465 kc.). List price, \$5.50 each, less 40% to experimenters.



Canadian Office:  
41 West Ave. North,  
Hamilton, Ontario

For Better Radio  
**Hammarlund**  
PRECISION  
PRODUCTS

HAMMARLUND MANUFACTURING CO.  
424-438 W. 33rd St., New York

Check here for details of new Variable-Coupling I.F. Transformer.

Check here for 1935 General Catalog.

Name.....

Address.....

..... Q-3

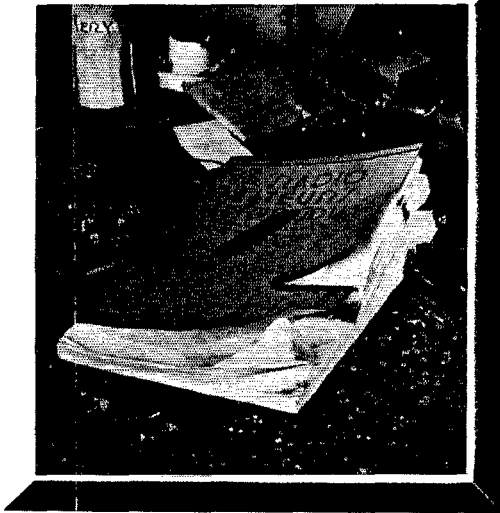

DOES YOUR  
HANDBOOK  
LOOK LIKE  
THIS?  
OR . . .

# HAVE YOU A BRAND NEW 1935 TWELFTH EDITION HANDBOOK

*With the sweeping changes in short-wave radio technique that have been made since publication of the 1934 eleventh edition?*

The chapters devoted to apparatus design and construction have been re-written all through, with new illustrations and new circuit diagrams. Needless to say, the new methods and technique which have so recently almost revolutionized ultra-high frequency work have been treated in full detail.

*Nothing in the book that does not represent the very latest practice*

268 pages—237 illustrations, postpaid \$1  
(Buckram bound, \$2)

AMERICAN RADIO RELAY LEAGUE, INC.  
WEST HARTFORD, CONNECTICUT

# QST

Published monthly, as its official organ, by the American Radio Relay League, Inc., at West Hartford, Conn., U. S. A.; Official Organ of the International Amateur Radio Union

devoted entirely to

# AMATEUR RADIO

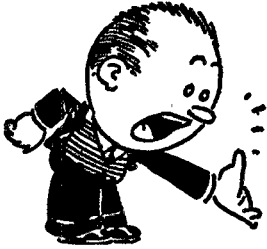

Editorials	9
Amateur Radio Around the World	Robert F. Wilson, W1FJ-W2EBM 11
Five-Hundred Dollar Amateur Competition	15
Hartford-Boston Link Established on 2 1/2 Meters	Rosa A. Hull 16
Grid-Bias Modulation for General Purpose Transmitter	George Grammer 17
A Simple Photographic Recorder for the Experimenter	Rosa A. Hull 27
Grid-Bias Modulation for the 100-Watt Transmitter	Walter H. Wirkler and Arthur A. Collins, W9CXX 29
More Audio Watts from a Single Type '10	Robert McConnell and August Raspet 32
Neutralizing the Class-B Modulator for Greater Fidelity	F. J. Burris, W8KGG 34
More Effective Pre-Selectors for Our Receivers	35
Screen-Grid Supply with Suppressor-Grid Modulation	38
The Old-Timer Learns About Modern Dress	E. A. Hubbell, W9ERU 39
Navy Day — 1934	E. L. Battey, W1UE 40
"One-Spot" Net Operation	C. S. Hoffman, Jr. 42
What the League Is Doing	44
A High-Efficiency High-Gain Audio Power Amplifier	O. H. Brewster, W1BMT and Lew Bellem, W1BES 45
A Space-Saving Antenna	R. N. Eubank, W3AAJ 48
The Seventh International Relay Competition	50
R. F. Return Circuit in Interstage Coupling	A. W. Friend, W8DSJ 50
Hamdom	52
With the Affiliated Clubs	53
Experimenters' Section	'PHONE MONITOR AND MODULATION METER— CRYSTAL-LOCKED HARTLEY OSCILLATOR—MORE ON ELIMINATING THUMPS —KEYING—RELAY CIRCUIT CLICKS—MONITORING WITHOUT A MONITOR —INEXPENSIVE FEEDER SEPARATORS—SAFE STARTING AND EXCITATION FAILURE PROTECTION 54
Amateur Radio Stations	W7BJS, W2HCP, W8EDR, W8BYK 54
I. A. R. U. News	59
Calls Heard	61
Operating Notes	63
Correspondence Department	75
Silent Keys	82
Vitreous R. F. Chokes	82
A. R. R. L. QSL Bureaus	84
Standard Frequency Transmissions	86
Schedules for WWV	88
Rotary Polarity-Reversing Switch	88
Ham-ads	106
QST's Index of Advertisers	110

MARCH  
1935

VOLUME XIX  
NUMBER 3

Kenneth B. Warner (Secretary, A.R.R.L.), *Editor-in-Chief and Business Manager*; Rosa A. Hull, *Associate Editor*; James J. Lamb, *Technical Editor*; George Grammer, *Assistant Technical Editor*; Clark C. Rodimon, *Managing Editor*; David H. Houghton, *Circulation Manager*; F. Cheynev Beekley, *Advertising Manager*; Ursula M. Chamberlain, *Assistant Advertising Manager*.

Editorial and Advertising Offices  
38 La Salle Road, West Hartford, Conn.

Subscription rate in United States and Possessions and Canada, \$2.50 per year, postpaid; all other countries, \$3.00 per year, postpaid. Single copies, 25 cents. Foreign remittances should be by international postal or express money order or bank draft negotiable in the U. S. and for an equivalent amount in U. S. funds.

Entered as second-class matter May 29, 1919, at the post office at Hartford, Connecticut, under the Act of March 3, 1879. Acceptance for mailing at special rate of postage provided for in section 1103, Act of October 3, 1917, authorized September 9, 1922. Additional entry at Concord, N. H., authorized February 21, 1929, under the Act of February 28, 1925.

Additional second-class entries pending to cover sectional editions, February 4, 1935

Copyright 1935 by the American Radio Relay League, Inc.  
Title registered at United States Patent Office.

# SPRING SALE — BE AMONG THE MAN

## FILAMENT TRANSFORMER FOR BRIDGE RECTIFIERS

Using 83 tubes 5 v-5 v-5 at 3 amps C.T.  
 — 3000 v insulation. . . . . \$2.15  
 For 866 tubes 2 1/2 v-2 1/2 v-2 1/2 v C.T.  
 — 10,000 volt insulation. . . . . \$4.40

## GROSS CASSED POWER TRANSFORMERS

650 v ea. side C.T. 350 ma. fila. 2-7 1/2 v C.T. and 1-5 v will give 500 v with choke input using 83 or 5Z3 tubes. You can run your entire R.F. and class B off this trans. . . . . \$5.25  
 750 v ea. side C.T. 300 ma. fila. 2-7 1/2 v C.T. and 1-5 v. . . . . \$5.50  
 750-1000 v ea. side of C.T. 300 watts. . . . . \$6.40  
 850-1350-1500 v. ea. side of C.T. 400 watts. . . . . \$8.50  
 (the ideal job to give 750-1000-1250 v D.C. with choke input)  
 850-1350-1500 v ea. side of C.T. 550 ma. . . . . \$12.25  
 1500-2000 v ea. side of C.T. 800 watts. . . . . \$11.45

## EXTRA SPECIAL MOUNTED, UNCASSED TRANSFORMERS

500-750-1000 volt each side of C.T. 300 watts. . . . . \$5.25  
 400-800 volts each side of C.T. 160 ma. . . . . \$3.15

## MOUNTED CENTER TAPPED FILAMENT TRANSFORMERS

2 1/2 v 8 a — 2 1/2 v 3 a — 5 v 3 a. . . . . \$1.25  
 2 1/2 v 4 a — 7 1/2 v 2 1/2 a — 7 1/2 v 2 1/2 a. . . . . \$1.25  
 2 1/2 v 4 a — 5 v 3 a — 7 1/2 v 2 1/2 a. . . . . 1.25  
 5 v 3 a — 7 1/2 v 2 1/2 a — 7 1/2 v 2 1/2 a. . . . . 1.25  
 2 1/2 v 6 a — CT (midget). . . . . .70  
 5 v 3 a — CT (midget). . . . . .70  
 6.3 v 1.5 a — CT (midget). . . . . .65  
 7 1/2 v 3 a — CT (midget). . . . . .80

## FILAMENT TRANSFORMERS shielded in metal cases, center tapped secondaries

2.5 Volt 10 amperes for 866's. . . . . \$2.15  
 10 to 12 Volts at 8 amperes . . . . . 2.15

## Special 10-12 Volt 7.5 ampere filament transformer, extra special. . . . . \$1.10

## Cased Combination Filament Transformer

2 1/2 V. C.T. 10 amps for 866's.  
 10 V. C.T. 7 amps for '50's or '52's.  
 10,000 Volt Insulation. . . . . \$3.15

## NEW!! RAYTHEON RK-23

The new small edition of the RK-20 (in stock). . . . . \$5.95

## RAYTHEON RK-20

The New RF Pentode Power Amplifier Tube in stock. . . . . \$15.00  
 (see page 14 June QST)

## Nickel Silver Name Plates

Black background with silver letters and border. Size 1/2" x 1 1/4". Following markings:  
 Gain Speech Doubler  
 Buffer Modulator Class-B  
 Amplifier Class C Filaments  
 Stand-By Plates Grid  
 Oscillator Neutralizer Crystal  
 Microphone Antenna Plate  
 10c each 6 for 50c

## EXTRA SPECIAL!!!

GROSS CASSED 20 H. 350 MA CHOKE  
 Limited quantity, special price. . . . \$3.95

Thord. Choke 15 H 250 MA. . . . . \$2.95  
 Gross Cased Choke 30 H 125 MA. . . . .88  
 Gross Cased Choke 30 H 200 MA. . . . . 1.94

## UNIVERSAL ANTENNA COUPLING SYSTEM INDUCTANCES

Wound on threaded double X natural bakelite tubing, can easily be tapped, with clip supplied, ea. . . . . \$1.50  
 (Use one coil for single-wire feed and two coils for two-wire systems)

## Low C 80-160 Meter Amplifier Coils

(See transmitter by GRAMMER page 46 May QST) Plug-in, wound on threaded natural bakelite tubing, will tune with 50 or 60 mmf. condenser, any size, each. . . . . \$1.50  
 40-Meter Type. . . . . 1.00

## 200 WATT VITREOUS RESISTORS With Variable Sliders

1000 ohms. . . . . \$ .99  
 2500 ohms. . . . . 1.05  
 5000 ohms. . . . . 1.05  
 10000 ohms. . . . . 1.11  
 15000 ohms. . . . . 1.20  
 25000 ohms. . . . . 1.29  
 35000 ohms. . . . . 1.35  
 50000 ohms. . . . . 1.44  
 60000 ohms. . . . . 1.49  
 80000 ohms. . . . . 1.59  
 100000 ohms. . . . . 1.65

Johnson Airplane Strain Insulators \$ .05  
 White or black 1/4" and 1" Standoffs, doz. . . . . \$ .50  
 White or Brown Beehive Ins., doz. . . . . .45

## EIMAC TUBES

Performance — Ruggedness — Power — Price  
 50-T Output 75 to 250 watts. . . . \$13.50  
 150-T Output 150 to 450 watts. . . 24.50

## FILAMENT TRANSFORMERS FOR EIMAC TUBES

Cased 5 volts CT 12 Amps. . . . . \$2.95  
 Cased 5 volts CT 20 Amps. . . . . 5.95

## RCA CATHODE RAY OSCILLOGRAPH

Complete with RCA tubes. . . . . \$84  
 (Literature on request)

## NOW! RCA-De Forest

801 Transmitting tube. . . . . \$4  
 802 Pentode tube. . . . . 3

## BARR LEAD-IN BOWLS

(see page 74, Feb. QST)

## PORCELAIN BASE 50-WATT SOCKETS (Side wiping contacts). . . . . \$

## CONTINENTAL MIKE — Stretch diaphragm — 24 K. gold spot Doubl. Button. Spec. . . . . \$3.

Midget Double Spaced 50 mmf ne cond. . . . . \$

Midget Double Spaced 35 mmf ne cond. . . . . \$.

## THE MAC-KEY

The perfect semi-Automatic and Straight Key. . . . . \$10.  
 (Circular on request)

## NEW!!

Martin Vibroplex Jr. . . . . \$10.

## GO-DEVIL AUTOMATIC KEY . . . \$6.

BLILEY BC2 Crystal Holders, Now \$1.40-40-M BC3 Mounted Crystals. . . 3.40 (stock or within 10 KC)

## General Electric Pyranols

We have been appointed distributors of this famous commercial line of capacitors now for the first time available to the amateur.

	1000 V. D.C.	1500 V. D.C.	2000 V. D.C.
1 mfd. . . . .	\$1.78	\$2.23	\$3.11
2 mfd. . . . .	2.67	3.71	4.77
4 mfd. . . . .	4.16	5.35	6.53

## BLANK CHASSIS

Ideal for mounting power supplies, R units, etc. 18-gauge metal — welded corners — black telephone finish inside and out. Complete with bottom dust cover  
 8" x 3" x 3 1/2". . . . . \$6.  
 10" x 3" x 8 1/2". . . . . 7.  
 17" x 3" x 4". . . . . 8.  
 17" x 3" x 8". . . . . 11.  
 17" x 3" x 10". . . . . 13.



## Hoyt Antenna Meter

Hot wire antenna meters. 2 1/4" mounting hole, flange 3" diameter, supplied in 1 1/2, 3 and 5 ampere ranges. Why worry without antenna meters when you can buy them at this special price? . . . . . \$2.75

## Hoyt Milliammeters and Voltmeters

Perfectly damped meters at a price. These are not to be confused with the usual inexpensive meters. 2" mounting hole, flange 2 1/4" diameter, supplied in the following sizes: 10 ma, 25 ma, 50 ma, 100 ma, 150 ma, 250 ma, 300 ma, 4 V. AC, 10 V. AC, 15 V. AC, 10 V. DC. Price each \$1.30, 3 for \$3.60.

## OUTSTANDING!!

## Gross Crystal Holder

WHITE CERAMIC commercial type crystal holder — priced at less than ordinary holders. Adjustable pressure, dust proof, no tools required to open. Takes crystal to 1 1/4" square. Plug standard 1/4" spacing. Most efficient job yet. 90c

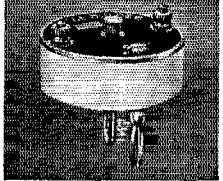

20% DEPOSIT WITH ALL C. O. D. ORDERS

REMIT BY M. O. INCLUDE POSTAGE

Cable Address: GROSSINC

GROSS RADIO, INC., 51 VESEY STREET, NEW YORK CITY

# WHO LOOK FORWARD TO THIS EVENT

## 866 TUBES 99c

Insulantite tops — Heavy duty rectifiers.

A SPECIAL buy makes it possible for us to give you at this price, the same tube we previously sold for \$2.15. These also carry our full guarantee.

Take Advantage — Positively the Last Month

### THORDARSON CASED TRANSFORMER

600 volts each side of C.T. 200 MA 2 1/2 V. 10 amps. C.T., 5 V. 3 amps., 7 1/2 V. 3 amps. C.T.

**\$2.45**

THORD. CHOKE 12 H 250 MA..... \$1.85

### CASED FILTER CONDENSERS

OIL IMMERSSED silver cased filter condensers with stand off insulators.

Close Out Prices. We Expect These to Go Fast, So, When Ordering State Second Choice

Quantity	Cap.	D.C. Volt	Price
200	2 mfd.	1000	\$1.45
75	4 mfd.	1000	2.45
88	1 mfd.	1500	1.25
17	4 mfd.	1500	2.85
20	1 mfd.	2000	1.65
40	2 mfd.	2000	2.25
4	4 mfd.	2000	3.95
37	1 mfd.	2500	4.60

### TYPE EO-1 LOW-LOSS 72 OHM TWISTED PAIR FEEDER CABLE

(Designed by Robert C. Graham, E.E., W8LUQ, and fully described by him, page 22, January QST)

FOR TRANSMITTING ANTENNAE—MAY BE OF ANY DESIRED LENGTH

Up to 50 feet.....	7c per foot
51 to 100 feet.....	6 1/2c per foot
101 to 500 feet.....	6c per foot
501 ft. and over.....	5 3/4c per foot

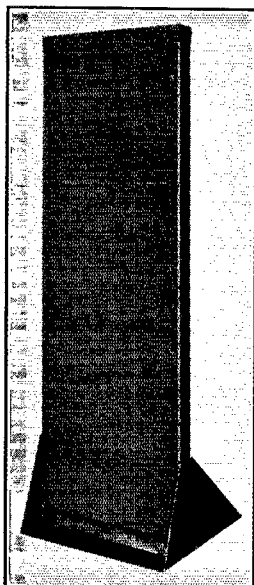

Compare Them with RACKS Selling at Any Price

Constructed of very heavy gauge steel (about 1/4" thick). Finished thruout in black Shrivel Lacquer — Complete with all panels. Panels 1/8" thick. Made in two sizes.

Type R7: — with 7 panels 8 3/4" x 19". Overall size 21 1/2" wide, 66" high. Price..... \$14.75

Type R4: — with 4 panels 8 3/4" x 19". Overall size 21 1/2" wide, 39" high. Price..... \$10.45

#### RELAY RACK PANELS

19" x 3 1/2".....	\$1.20
19" x 7".....	1.30
19" x 8 3/4".....	1.45
19" x 14".....	1.70

#### GROSS TRANSMITTING R.F. CHOKES

4 1/2 MH — D.C. Res. 12 1/2 ohms current capacity 650 MA. Special..... \$1.79c

THIS MONTH ONLY — X cut 80-160 M Crystals..... \$1.95

#### SOFT-DRAWN TINNED COPPER COIL WIRE

Prices per 100 ft. More in proportion

No. 16.....	30c	No. 12.....	55c
No. 14.....	35c	No. 10.....	90c

#### HARD-DRAWN TINNED COPPER ANTENNA WIRE

No. 12.....	55c	No. 14.....	35c
-------------	-----	-------------	-----

### The "EAGLE" Three-Tube Short-Wave Receiver

"Band Spread" over any portion of the tuning range — only finest material used thruout. Employs one '32 R.F., one '32 detector and one '33 Pentode Audio — 15 to 200 meters — four coils, supplied. The "EAGLE" is economical — two dry cells will operate the filaments. See March or April 1933 QST for full description of this most excellent value in short-wave receivers.

"Eagle" completely wired and tested.. \$11.95 Three tubes tested in your receiver.. \$3.00

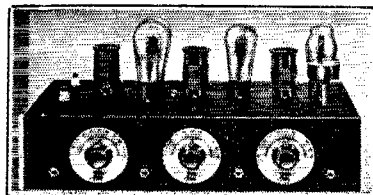

### GROSS C C TRANSMITTER—OUTPUT 25-30 WATTS

The "CW-25" transmitter kit due to its low cost makes it possible for anyone to own a modern crystal controlled station. A schematic hook-up and parts layout sheet as well as tuning instructions are furnished, thus enabling the most inexperienced operator to wire and put the set on the air, for real results. The "CW-25" is supplied with a shrivel finished sturdy metal chassis under which all parts are mounted, making the wiring and components dust-proof. A plug-in crystal holder is furnished with the kit. Only one milliammeter is required for tuning the transmitter and each stage is provided with a jack for this purpose. The "CW-25" uses one '47

as crystal oscillator, one '46 as buffer or doubler and two '46's in the amplifier stage, set of three coils supplied with kit for 20, 40, 80 or 160 band. Additional coils 75c each. Complete kit, less tubes and crystal..... \$13.95

20% DEPOSIT WITH ALL C. O. D. ORDERS

REMIT BY M. O. INCLUDE POSTAGE

Cable Address: GROSSINC

**GROSS RADIO, INC., 51 VESEY STREET, NEW YORK CITY**



*Flawless Operation* ON  
**THE CRILLON GLACIER!**

Photo shows Richard Goldthwait and the geophysical instruments used by the 1934 Harvard-Dartmouth Crillon Expedition to measure the depth of ice in the South Crillon Glacier in Alaska. Mount Crillon in the background is 12,000 feet high. The glacier ice in the foreground, incidentally, was found to be more than 1,000 feet in depth! "BURGESS Batteries were used constantly to run the delicate oscillograph : : : their operation was flawless regardless of extreme cold, hard usage and heavy rains." No wonder great explorers—and thousands of radio-amateurs who know batteries—use only BURGESS!  
BURGESS BATTERY COMPANY, Freeport, Illinois.

**BURGESS**



## Section Communications Managers of the A.R.R.L. Communications Department

All appointments in the League's field organization are made by the proper S.C.M., elected by members in each Section listed. Mail your S.C.M. (on the 16th of each month) a postal covering your radio activities for the previous 30 days. Tell him your DX, plans for experimenting, results in phone and traffic. He is interested, whether you are an A.R.R.L. member or get your QST at the newsstands; he wants a report from every active ham. If interested and qualified for O.R.S., O.P.S. or other appointments he can tell you about them, too.

Eastern Pennsylvania Maryland-Delaware-District of Columbia Southern New Jersey* Western New York Western Pennsylvania	W3GS  W3BAK W3ZX W8DSP W8CUG	<b>ATLANTIC DIVISION</b> Jack Wagenseller  Edgar L. Hudson Carroll D. Kentner Don Farrell C. H. Grossarth	26 Meadowbrook Ave.  1107 Park Ave. 213 Hickock Ave. R. F. D. 3, Elcher Rd.	Lianerch, Upper Darby Laurel, Delaware Collingswood Syracuse Emsworth, Bellevue, Pa.
Illinois Indiana Kentucky Michigan Ohio Wisconsin	W9WR W9TE W9AUH W8DYH W8CIO W9FSS	<b>CENTRAL DIVISION</b> Fred J. Hinds Arthur L. Braun G. W. Mossbarger Kenneth F. Conroy Robert P. Irvine Harold H. Kurth	6618 West 34th St. 5211 Brookville Rd. Box 177 7538 E. Robinwood Ave. 5508 Northcliffe Ave. 9 South Randall Ave.	Berwyn Indianapolis Camp Taylor Detroit Cleveland Madison
North Dakota South Dakota Northern Minnesota Southern Minnesota	W9JVP W9PFI W9JIE W9DEI	<b>DAKOTA DIVISION</b> Fred J. Wells Mike G. Strahon Robert C. Harshberger Francis C. Kramer	1022 11th St., S. 601 S. Grange Ave. 1200 Paugquier St. W. Bluff St.	Fargo Sioux Falls St. Paul St. Charles
Arkansas Louisiana Mississippi Tennessee	W5ABI W5DWW W5CWO W4BBT	<b>DELTA DIVISION</b> H. E. Veite W. J. Wilkinson, Jr. J. H. Weems, Jr. Merrill B. Parker, Jr.	2918 West 15th St. 1624 Allen Ave. P. O. Box 244 1912 Oak St.	Little Rock Shreveport State College Chattanooga
Eastern New York N. Y. C. & Long Island Northern New Jersey*	W2LU W2AZY W2FOP	<b>HUDSON DIVISION</b> Robert E. Haight E. L. Baunach Charles J. Hammersen	1080 Helderberg Ave. 7823 10th Ave. 92 Claremont Ave.	Schenectady Brooklyn Verona
Iowa Kansas Missouri Nebraska	W9LEZ W9FLG W9EYG-JPT W9FAM	<b>MIDWEST DIVISION</b> Phil D. Boardman O. J. Spetter C. R. Cannady Samuel C. Wallace	325 Kirkwood Blvd. 305 Western Ave. Broadway at Ninth Green St.	Davenport Topeka Monett Clarks
Connecticut Maine Eastern Massachusetts Western Massachusetts New Hampshire* Rhode Island Vermont	W1CTI W1CDX W1ASI W1BVR W1AVJ W1QR W1ATF	<b>NEW ENGLAND DIVISION</b> Frederick Ellis, Jr. John W. Singleton Joseph A. Mullen Percy C. Noble Robert Byron Albert J. King Harry Page	19 Merrill Rd. 10 High Street 218 Jamaica Ave. Westfield 17 Humphrey St. 127 Metropolitan Park Dr. R. 1	Norwalk Wilton Jamaica Plain Westfield Concord East Providence Hinesburg
Alaska Idaho* Montana Oregon Washington	K7PO W1NH W7AAT W7AMF W7AYO	<b>NORTHWESTERN DIVISION</b> Richard J. Fox Nellie H. Hart O. W. Viers Frank L. Black Stanley J. Belliveau	Box 301 Box 6 Box 265 1502 McPherson St. Route 7, Box 387	Ketchikan Twin Falls Red Lodge North Bend Yakima
Hawaii Nevada Los Angeles Santa Clara Valley East Bay San Francisco Sacramento Valley Arizona Philippines San Diego San Joaquin Valley	K6EWO W6EAD W6BPU W6BMW W6ZX W6SKY W6DVE W6JF-WGQC K41XA W6EOP W6FFP	<b>PACIFIC DIVISION</b> Atlas O. Adams Keston L. Ramsay Howell C. Brown Charles J. Camp P. W. Dann Alan D. Whitaker, Jr. Geo. L. Woodington Ernest Mendoza Newton E. Thompson Harry A. Ambler Clyde C. Anderson	21st Infantry Brigade 1151 Buena Vista Ave. 120 N. El Molino Ave. 318 Hawthorne Ave. 1821 Chestnut St. 78 Elton Ave. 716 Redwood Ave. 1434 East Madison St. P. O. Box 849 4101 Hamilton St. 931 Orange Ave.	Schofield Barracks Reno Pasadena Palo Alto Berkeley Mill Valley North Sacramento Phoenix Manila, P. I. San Diego Fresno
North Carolina* Virginia West Virginia	W4EG W3BRY W8HD	<b>ROANOKE DIVISION</b> N. M. Patterson Neil E. Henry C. S. Hoffmann, Jr.	2804 Hillsboro St. 1017 Knight St. 100 20th St.	Raleigh Lynchburg Warwood, Wheeling
Colorado Utah-Wyoming	W9FA W6GQC	<b>ROCKY MOUNTAIN DIVISION</b> Glen Glasscock Arty W. Clark	1171 Detroit St. 260 So. 9th West	Denver Salt Lake City, Utah
Alabama Eastern Florida Western Florida Georgia-So. Carolina-Cuba- Isle-of-Pines-Porto Rico- Virgin Islands	W4KP W4BCZ W4MS  W4CE	<b>SOUTHEASTERN DIVISION</b> L. D. Elwell Philip A. McMasters Edward J. Collins  Bannie L. Stewart	1066 Waverly St. 212 9th St., North 1517 East Brainerd St.  310 Orange St.	Tarrant St. Petersburg Pensacola  Georgetown, S. C.
Northern Texas Oklahoma Southern Texas New Mexico*	W5AUL W3CEZ W5ADZ W5AOP	<b>WEST GULF DIVISION</b> Glen E. Talbutt Carter L. Simpson Bradfield A. Beard Robert Shadden	1133 Amarillo St. 2010 So. 4th St. 2030 Quenby Road 611 W. Marquette Ave.	Abilene Panca City Houston Albuquerque
Maritime	VE1DQ	<b>MARITIME DIVISION</b> A. M. Crowell	69 Dublin St.	Halifax, N. S.
Ontario	VE3GT	<b>ONTARIO DIVISION</b> S. B. Trainer, Jr.	4 Shorncliffe Ave.	Toronto
Quebec	VE2EE	<b>QUEBEC DIVISION</b> Stan Comach	780 Brault Ave.	Verdun, P. Q.
Alberta British Columbia	VE4GD VE5AC	<b>VANALTA DIVISION</b> J. Smalley, Jr. R. K. Town	611 1st Ave., N. W. 1754 Graveley St.	Calgary Vancouver
Manitoba Saskatchewan	VE4BG VE4EL	<b>PRAIRIE DIVISION</b> A. J. R. Simpson Wilfred Skaffe	71 Thelma Mansions 2040 McTavish St.	Winnipeg Regina

\* Officials appointed to act until the membership of the Section choose permanent S.C.M.'s by nomination and election.

# The American Radio Relay League



• **T**HE AMERICAN RADIO RELAY LEAGUE, INC., is a non-commercial association of radio amateurs, bonded for the promotion of interest in amateur radio communication and experimentation, for the relaying of messages by radio, for the advancement of the radio art and of the public welfare, for the representation of the radio amateur in legislative matters, and for the maintenance of fraternalism and a high standard of conduct.

It is an incorporated association without capital stock, chartered under the laws of Connecticut. Its affairs are governed by a Board of Directors, elected every two years by the general membership. The officers are elected or appointed by the Directors. The League is non-commercial and no one commercially engaged in the manufacture, sale or rental of radio apparatus is eligible to membership on its board.

"Of, by and for the amateur," it numbers within its ranks practically every worth-while amateur in the world and has a history of glorious achievement as the standard-bearer in amateur affairs.

Inquiries regarding membership are solicited. A bona fide interest in amateur radio is the only essential qualification; ownership of a transmitting station and knowledge of the code are not prerequisite. Correspondence should be addressed to the Secretary.

## DIRECTORS

*President*  
HIRAM PERCY MAXIM.....W1AW  
Box 216, Hartford, Conn.

*Vice-President*  
CHARLES H. STEWART.....W3ZS  
St. David's, Pa.

*Canadian General Manager*  
ALEX REID.....VE2BE  
169 Logan Ave., St. Lambert, P. Q.

*Atlantic Division*  
EUGENE C. WOODRUFF.....W8CMP  
234 W. Fairmount Ave., State College, Pa.

*Central Division*  
EDWARD A. ROBERTS.....W8HC  
2699 Endicott Rd., Shaker Heights, Cleveland

*Dakota Division*  
CARL L. JABS.....W9BVH  
1822 James St., St. Paul, Minn.

*Delta Division*  
M. M. HILL.....W5EB  
P. O. Box 274, Natchitoches, La.

*Hudson Division*  
KENNETH T. HILL.....W2AHC  
115 Willow St., Douglaston, L. I., N. Y.

*Midwest Division*  
H. W. KERR.....W9DZW-W9GP  
Little Sioux, Iowa

*New England Division*  
G. W. BAILEY.....W1KIH  
74 Webster Road, Weston, Mass.

*Northwestern Division*  
RALPH J. GIBBONS, JR.....W7KV-W7BIX  
3933 N. E. 76th Ave., Portland, Ore.

*Pacific Division*  
S. G. CULVER.....W6AN  
2962 Russell St., Berkeley, Calif.

*Roanoke Division*  
H. L. CAVENESS.....W4DW  
State College Station, Raleigh, N. C.

*Rocky Mountain Division*  
RUSSELL J. ANDREWS.....W9AAB  
1867 So. Lafayette St., Denver, Colo.

*Southeastern Division*  
BENNETT R. ADAMS, JR.....W4APU  
1512 Grove Place, Homewood, Ala.

*West Gulf Division*  
WAYLAND M. GROVES.....W5NW  
c/o Humble Pipe Line Co., Neches, Texas

## OFFICERS

*President*.....HIRAM PERCY MAXIM, W1AW  
Hartford, Connecticut

*Vice-President*.....CHARLES H. STEWART, W3ZS  
St. David's, Pennsylvania

*Secretary*.....KENNETH B. WARNER, W1EH  
West Hartford, Connecticut

*Treasurer*.....ARTHUR A. HEBERT, W1ES  
West Hartford, Connecticut

*Communications Mgr.*...F. EDWARD HANDY, W1BDI  
West Hartford, Connecticut

*General Counsel*.....PAUL M. SEGAL, W3EEA  
1010 Shoreham Building, Washington, D. C.

Address all general correspondence to the executive headquarters at West Hartford, Connecticut



# THE EDITOR'S MILL

FREQUENTLY upon this page we have dwelt upon the common pride that we radio amateurs can find in the splendid structure of amateur radio that we have reared upon this continent. When we think of our humble beginnings and of the dark days before we found each other and organized the American Radio Relay League, it seems almost impossible to believe that we could have come this far in setting up amateur radio as the complete American institution which it is to-day. Through coöperation and fair play and mutual interest in a peculiar combination of science and hobby, we have found the paths that have led to reasonable success and stability, and we are entitled to be proud of what we have done through our A.R.R.L.

We have just finished reading an exceedingly interesting hundred-thousand-word thesis submitted last year by a candidate for the degree of Doctor of Philosophy. It is a genetic study of institutional growth and cultural diffusion in contemporary American civilization. The author decided first to prepare a careful descriptive analysis of the development and spread of a twentieth-century American social institution and then to utilize this descriptive analysis to clarify and redefine certain social concepts for the purpose of testing existing hypotheses and developing new ones. For his twentieth-century American institution he chose amateur radio! It suited his purposes admirably because here, within the lifetime of the researcher, an institution had risen from nothing to a position of dignity, with a background of habits and ethics and even with its own traditions and mythology! Although not himself a radio amateur he has collected and analyzed the literature of amateur radio, particularly including a thoroughgoing dissecting of a complete file of *QST*'s, and he obtained the coöperation of hundreds of amateurs who filled out and returned questionnaires for him. Under the skillful dissecting knife and powerful microscope of this sociologist, we amateurs are examined, catalogued and analyzed. It has been a weird experience to read of ourselves in the specialized nomenclature of sociology, for this writer was not interested in amateur radio as are we fellows but rather regarded us as the exhibit in his study of a contemporary American institution. We have never thought of ourselves in terms of nuclear complexes, sufficient and necessary causal factors

and culture patterns, but we are pleased to see that the gentleman, by his choice of amateur radio as his raw material, agrees with us that we have succeeded in some measure in making a notable contribution to American life.

In the course of his thesis the author asks himself the question, "What are the elements of this core complex in the amateur radio institution?" His answer shows how surely he has uncovered the secret of that which binds us:

"The central trait is the means of communication with others on equal terms, of finding friendship, adventure and prestige while seated at one's own fireside. In picking his human contacts out of the air the amateur is not seen by them. . . . He is not known by the company he keeps nor by the clothes he wears but by the signals he emits. He enters a new world whose qualifications for success are within his reach. A good home-made set gives him more prestige than a commercially-manufactured one. There are no century-old class prejudices to impede his progress. He enters a thoroughly democratic world where he rises or falls by his own efforts. When he is W9XYZ, a beginner, the radio elders help him willingly, and when he becomes W9XYZ the record-breaker and efficient traffic handler, he willingly helps the younger generation. Without a pedigree, a chauffeur, or an old master decorating his living room he can become a prince—of the air. At the close of the day, filled with the monotonous routine of the machine age, he can find adventure, vicarious travel, prestige and friendship by throwing in the switch and pounding his signals into the air."

Did you ever hear the lure of amateur radio better expressed in one brief paragraph? It is unfortunate that this complete document is not available in print. If ever it so becomes, the fact will be mentioned in our columns, for a radio amateur would enjoy perusing this evidence of the part he is playing in the changing cultural pattern of America.

WHY is it, we wonder, that old-timers in any field of endeavor speak so yearningly of the "good old days"? Were they actually better, we ask ourselves? And if they were, why can't something be done to preserve the conditions of those early days that cause such sweeping surges of nostalgia in the memory of our pioneers?

The answer, we're afraid, is that some such loss of romantic intangibles is inevitable in exchange for the benefits of progress. The old-time miners used to tell with gusto of the good old days in the mining camps, when raw red liquor flowed and tin-pan dance halls enlivened the scene; when comradeship, and a grubstake, and a chance to prospect were all a man asked. Those were their good old days. Then came modern engineering and scientific stamping mills and smelters with electrical precipitators to recapture precious metal even from the smoke of the mills! Again, we remember the fun we used to have as a boy collecting postage stamps. With utter sacrilege we handled stamps with our fingers, pasted them down hard in a cheap album, violated all of to-day's rules—but had an awfully good time. The modern philatelist works under a bright light with a magnifying glass painstakingly searching for die varieties, comparing shades with a color chart, consulting textbooks, and laboriously writing long spiels about his finds. It is harder work because this is the age of specialization, knowledge has increased, and one must keep abreast of it. With delicious pain we remember the early days of amateur radio, the rare perfect night punctuated by the whining notes of rotaries while with trembling fingers we moved the loose-coupler just a little to get the last faint measure of adjustment to bring in that distant whisper of a fellow all of 200 miles away! Those were the real days, we sometimes say—when apparatus was simple and we were unencumbered with too much knowledge, when there was nothing to do but operate and expand our interests in each other.

But were they? Old-time journalists recall with sorrow the grand dead days when Park Row was the home of great editors and newspaper reporting a profession; they grumble about to-day's deterioration when, to hear them talk, it is only necessary to send kids to offices for "hand-outs." But surely to-day's newspapers, in their primary function of reporting the news, with all their modern technological aids of communication, are vastly more creditable products than their predecessors. It seems to us inevitable that in any walk of life those who pioneered will always,

by some quirk of human nature, remember with longing the glamour and romance of the early days in which they took a part. Any American institution will be found to have gone through a youthful period when individuality was supreme, the glorious confusion of its formative days. Then there follows organization and expansion and a certain measure of orderliness, existence becomes more certain and stable, recognition accrues, and finally it has arrived as a more or less dignified American institution.

It seems to us that it has been that way with amateur radio. Can we go back? Do we want to? No, of course not. We cannot get along without coöperation, we would not tolerate for an instant the insufficiencies of our apparatus of those early days. True, we must pay a price for this progress: we obligate ourselves to keep abreast of an art that becomes increasingly complex, that demands more and more skill of us. But we are our own masters. There is no reason why we may not and should not continue to concentrate upon the things that we have found desirable in the pursuit of our hobby: the companionship and camaraderie, the joyous feeling of mutual interdependence as we jointly tackle one problem after another in the fashion that has always brought us good results. We can think of the traditions and codes of ethics we have established for ourselves as the result of hard experience and we can teach these to the youngsters in the game. We are doing a million times more useful work than ever before and we may find pride in having licked the many dark problems that barred our way to that estate. The *spirit* of amateur radio is of our own making. Arrival and security and recognition do not imply senescence, stagnation, the end of glamour, romance and friendship. They offer us all the more opportunity to expand these precious attributes.

As we deal with the modern complexities of multi-stage transmitters and receivers and fume about frequency stability in crowded bands, let us never lose sight of the fact that we're in this game because it's fun to us, a deep and satisfying experience in life, based primarily upon our contacts with fellow amateurs.

K. B. W.

## Strays

A variant on the old copper-tubing joke: W3ESY, walking down the main street of his town with a lot of tubing soon to be wound into a 160-meter tank, was accosted by a stranger who asked, very confidentially, "Say, brother, what do you use to take the copper taste out of the stuff?"!

-----  
W8BKE revives a suggestion which may not have come to the attention of the newer members.

He uses cardboard tabs glued to the last page of each district section in the call book, projecting about a half inch from the pages, to help in locating quickly the section of the book in which the call is to be found.

Index tabs made for the purpose can be purchased at any stationery store.

-----  
A catalogue clipping from W8FU advertises a super aerial eliminator "resigned" for use with any ground connection. No doubt!

# Amateurs Around the World by Plane

By Robert F. Wilson,\* W1FJ, W2EBM

When Dr. Richard U. Light, amateur airplane pilot, and Bob Wilson, amateur radio operator and navigator, recently completed their around-the-world tour which included 30,000 miles of flying in the doctor's private plane, several records unique in the realms of radio and aviation were established. That the flight was privately financed, completely without commercial sponsorship and the ballyhoo of hired press agency, in itself is outstanding; and, that continuous radio communication was maintained in flying over the Atlantic, across Europe, over the jungles and seas of the Far East, and that the whole trip was unmarred by any mishap—not even so much as a forced landing—are without precedent in the realm of aviation, professional and commercial included. Because of Bob Wilson's affiliation with amateur radio and Dr. Light's amateur standing in his field, the job done is one of which all amateurs can be proud. Bob gives the story from the radio amateur's angle in this article.—EDITOR.

**H**OPPING off from New Haven, Conn., on August 20th after many last-minute delays KHMZA, with Pilot Dr. Richard U. Light and myself as radio op-navigator, began a long flight which we hoped would not stop until we had circled the globe.

The craft was a Bellanca six-place cabin plane with a 420-horsepower Pratt and Whitney Wasp engine, equipped with Edo floats in place of wheels. By the time it was made ready for the trip, a baggage compartment, radio gear, spare oil tank and other extra equipment, reduced it to a carrier for three, and those three not too comfortable. Two could just about exist within the cabin without getting tangled up with each other and the various gadgets.

## THE GEAR

For reception we had an all-wave Lear superhet with band switching. The transmitter was a Westinghouse type CH aircraft telegraph set built when America's aircraft were using radiotelegraph for some of their domestic communication. A single 210 Hartley oscillator controlled and excited four more 210's in a push-pull, paralleled power amplifier arrangement. Up to eighty watts could be fed to the trailing-wire antenna

\*261 Sickles Avenue, New Rochelle, N. Y. W1YU until graduation, '34.

from it. A reel not unlike the kind used for tarpon fishing had plenty of wire on it and a two-pound sinker (what somebody started calling a "fish") was secured to the end of the wire that led through a fairlead in the floor of the plane. For short-wave communication enough wire for a three-quarter wavelength antenna was let out, and for long waves a loading coil provided for enough effective length so that Sparks would not have to wind all day to get his three-quarters of nine hundred meters out! In addition to the trailing wire antenna for use while in flight, the ship is equipped with a fixed antenna running from the wings to the tail. With this sky wire readable signals have been sent 200 miles on 8340 kc., and with the aid of eight feet more of vertical antenna tacked on to it an R9 signal was put into West Hartford from North Carolina early one evening.

The set was equipped to work on several different channels, each one of which proved to have a definite use. 3105 kc. is the "stand-by" frequency for the U. S. Department of Commerce airways stations, and upon request they will guard that frequency for itinerant fliers. 5515 kc. is one of the marine high frequency bands and it gives good results for daylight work up to 500 miles. 8340 kc. and 12,480 kc. are two more marine channels assigned and they are both watched by coast stations. On 8340 solid contact

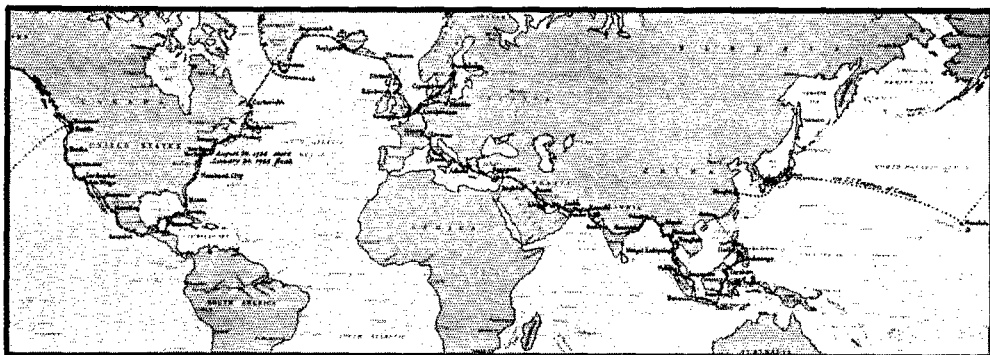

ROUTE FOLLOWED BY KHMZA

© Yale Alumni Weekly

throughout the day was had over distances up to 2000 miles. 12,480 proved a good frequency for daylight work, but the signal from this type of transmitter is not pure and steady enough for

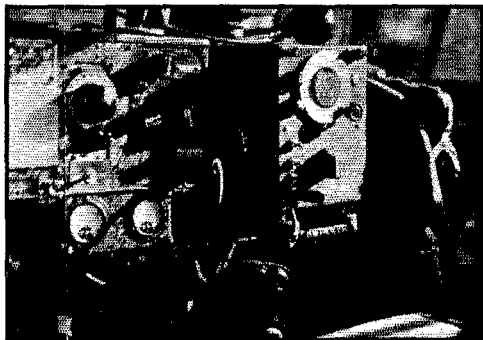

**RADIO EQUIPMENT ON KHMZA**

*Transmitter is at the left and receiver at the right, directly in back of pilot's seat. Trailing antenna reel may be seen at front center. Operator's position is across aisle from the equipment.*

reliable work. It might be said here that the set was originally designed for use on 3105 kc. and that the higher frequencies were added later.

The low frequencies of 333 and 500 kc. were the ones to take the bulk of the work throughout the trip. Every ham knows that almost in any spot in the world where ships are likely to go there are stations standing watch on 500 kc. They are all eager to help airplanes and we had invaluable help from them. Outside the United States the bulk of aeronautical radio is done by means of radiotelegraph and practically all of it is done on 333 kc. Ground stations well experienced with working aircraft are stationed every few hundred miles along the Amsterdam to Batavia (Java) airplane route which is used in whole or in part by the Royal Dutch Air Lines (KLM), Britain's Imperial Airways, and Air France. These stations have reliable weather data and stand continuous watch for planes when any are in the air within range of them.

#### HOPPING TO ICELAND

Our first leg was up the Maine coast to Nova Scotia and Cartwright, Labrador, where we awaited favorable weather reports before hopping to Greenland. Along this route notifications of arrival were sent to the Canadian officials on 600 meters and it was a hard fight for our 75 watts to break through on this frequency as it surely is "hot" around the Gulf of St. Lawrence. The Canadian coast stations

VAR and VCO cooperated admirably, and VCO in Sydney, C. B., kept a steady watch for us as we crossed the Cabot Strait to Newfoundland that afternoon.

As we went up the Newfoundland west coast, crossed Belle Isle Strait to Labrador and followed it in to Cartwright the Canadian and Newfoundland stations along the route all opened up to give us weather reports and to keep track of our progress.

Cartwright's population of 72 did not even look up when we arrived there. That spot has been a stopping place for several airplane flights including the Lindberghs' recent one and Balbo's fleet of flying boats. We stayed at the so-called "Snake Hotel" (so named because there were no snakes, although you could find everything else without looking very far). We were the next names on the register after Balbo's men in this place which was really a rest house for visiting Hudson Bay Company's people. Now 1100 miles from West Hartford, the contacts were not so good. Until we left Labrador we had good radio communication with W1SZ and Dr. Light's father in Kalamazoo, Michigan, via W8GUC who was always on tap for relays. The weather bureau in Washington cooperated with weather reports which were forwarded by amateur radio until we left Labrador.

On the night of August 24 (our last night in Labrador) we tried to make contact with W1SZ, but could just faintly hear the strongest commercials on high frequencies. There was no more QRN than usual, but the signals were just not there. Low-frequency signals did not seem to be affected. After trying for an hour to get through in vain, we went ashore. Upon leaving the cabin of the ship the most magnificent sight imaginable greeted us; the whole sky in all quarters was

brilliantly lighted, streamers swept back and forth, then a great banner containing all the colors of the rainbow, it seemed, was waved back and forth by some invisible giant. It was awe-inspiring to see this magnificent display of the Aurora-Borealis, the first we saw on the trip which had been a week in progress. Notwithstanding reports from other northern observers, we can not help seeing a correlation between the failure of

the high-frequency signals and this display. Not having instruments or time to investigate further we could make no definite conclusions. It is known, however, that short-wave misbehaviour accompanies magnetic storms and the Aurora also comes out to show itself at the same time.

Next day we took off for Julianehaab, Greenland, and as soon as we were in the air we were in

#### Performance of KHMZA

1. 600 miles on 600 meters in north over water.
2. 450 miles on 900 meters in tropics over water.
3. 300 miles on 600 meters in tropics over land.
4. 2500 miles still going strong 36 meters in south.
5. 1100 miles fixed antenna over land 36 meters.
6. Up to 30 miles with fixed antenna on 600 meters.

contact with VOK, Cartwright; VAW, 600 miles to the north on little Resolution Island in the Davis Strait, and OXF, Julianehaab also 600 miles away. This demonstrated the effectiveness of the transmitter as all the work was done on 600 meters. On the trip across which lasted seven hours before landing, navigation duties in addition to the radio work on 600 meters kept us both so busy that there was only time for a few short attempts to contact amateurs on our 36-meter wave. These proved to be ineffective, and it was the end of ham QSO's with KHMZA for a while.

After Julianehaab, on to Angmagsalik on the east coast 450 miles north of Cape Farvel. These are larger Eskimo settlements each numbering several hundred with a few Danes who were there for purposes of administration, medical aid and maintenance of radio stations. OZL at Angmagsalik was a quaint spark transmitter. OXF was a modern station capable of simultaneous operation on several frequencies ranging from about 100 kc. to 16,000. Its chief function is to furnish communication with Denmark.

On August 31st we reached Reykjavik, Iceland, after being forced back the day before by an unpredicted storm. TFA at Reykjavik is a modern station with an able staff. Point-to-point work, regular 600-meter ship-to-shore operation and radiophone contact on about 188 meters with the many fishing trawlers in Iceland waters is done by this station. From an unlicensed amateur here who was the helper of a painter who did some work on the ship I heard of the difficulties of amateur operation in Iceland. Equipment is expensive and hard to obtain, and licenses are also hard to get. There were no really active amateurs in the city although several were listed as being licensed in the call book. Contrary to the general belief Iceland has about as much ice as Greenland has green. Someone long ago must have mixed up the names, and they have never been able to straighten themselves out. In answer to a question of mine regarding how soon in the fall the country froze up they answered that they seldom had any snow that stayed on the ground for even a full day in Reykjavik. A year-round temperature of about 40 to 60 with many overcast days seemed to be their fare for a climate.

#### ON TO EUROPE AND EASTWARD

Thorshavn, Faroes, and Kirkwall, Orkneys were the stops made before reaching

Edinburgh. In Edinburgh a telephone call from G2TM announced that he was QSO W1SZ and a subsequent schedule with the "home folks" was



THE AUTHOR

arranged. Meeting Millar and spending a few hours at his shack with some other Edinburgh hams was no less pleasant than renewing contact with America. In London, G2BM and G2ZQ provided several very pleasant visits to British ham shacks, although the latter had me baffled a bit when he announced himself over the telephone as G-2-zed-Q. At his house a short but concentrated hamfest was had when, together with a ham from VK, I called one evening. At G2BM's (the world-famous father and son station) several excellent contacts were had with the U. S. gang.

As soon as Europe was entered we shifted to 333 kc., the international aircraft wave. Air transportation in Europe is very highly developed and there are a great many planes in the air at once. Each one that is radio-equipped operates on 333 kc. with telegraph with the exception of a very few using 'phone on another intermediate frequency. The bedlam on this wave, then, is easily imaginable when so many planes within radio range of each other and the several hundred land stations all operate at once on the same channel. Weather re-

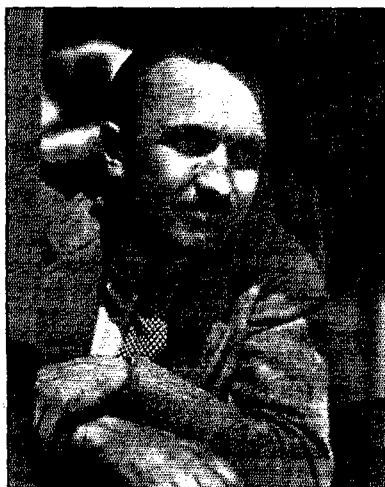

DR. RICHARD U. LIGHT

ports, arrival and departure reports, position reports, private traffic, and official messages all seem to get through, however, but it was a relief to leave Europe, as far as radio went, when Athens slipped by on October 15. We had a very pleasant tour with stops at Rochester, Amsterdam, Copenhagen, Stockholm, Stettin, Geneva, Nyon, Locarno, Ostia (Rome) and Phaleron in Greece. In Berlin a visit to the DASD developed into a pleasant evening with D4BUF and D4CCF after meeting D4BPF in the afternoon. I will always regret not having had a chance to look up more European hams.

Athens to Cyprus was a rough day as we bucked an electric storm which paralyzed the radio. A two-inch spark could be drawn from the antenna.

It was a thrill to be working calls like ZFE and YIA as we made our way into Iraq later. Baghdad was an interesting stop in itself, but on October 20 we stayed up all night to see five of the Melbourne race craft come through. Basra at the head of the Persian gulf was the next stop and we stayed over a day while the Royal Air Force, in Iraq for patrol purposes, helped us with a motor check on the Wasp. It was there that YI7NN, one of the air force radiomen, had a shack in a large packing van and a station composed of pick-up parts. SU's and U's seemed to cover the band as W's do at home.

After exchanging yarns and hearing about radio in Iraq from YI7NN, I went to an early bed in preparation for the flight down the Persian Gulf the next day. Lingeh and Jask were stops in Persia, and we wasted no time in leaving them, interesting as they were. At Gwadur, a free port controlled by a sheikh of Oman, we stayed with Mr. Thompson the man in charge of the radio station in that forsaken spot. Next day to Karachi, and the following one to Bombay. At Bombay we had a forced stay because of weather, but the Royal Indian Navy entertained us and made it quite pleasant in spite of the depressing climate. The enlisted men in the navy are all Indians and when new recruits come to the training station they are all put through tests which are intended to determine their possibilities as radio operators. The job of radio man is greatly desired by the Indians and in this way the ones most likely to succeed are chosen. From Bombay we went due east overland to Cocanada, probably not the best procedure for a sea-plane, but far better than trying to buck the monsoon which had set in around the southern coast which we otherwise would have followed. On the trip across we worked the Navy station at Bombay up to 400 miles away as we were no

longer within range of the stations along the air route to Singapore.

After Cocanada we went to Calcutta, thence to Akyab and Moulmein in Burma. As we crossed the jungle from Akyab to Rangoon, VTR at Rangoon gave us radio bearings obtained from our regular communication signals without even our request. From Moulmein we made another trans-jungle hop across the tiger and elephant country—without seeing any of them. Bangkok, Siam, was our destination and here we found an interesting contrast of the ancient and the modern.

From Bangkok the west coast of the Malay peninsula was followed to Singapore after a crossing near Mergui and stops at Victoria Point and Penang. From Singapore we went south, crossing the equator while being buffeted by a tropical storm on the way to Batavia, Java, where we met the U.S.S. *Augusta*, flagship of the Asiatic fleet. Thanksgiving day was spent with them, and the old institution was kept on American "soil" after all! Reluctantly we went on to Surabaya and Bali after a good visit. At a hill station in Bali we had the first bearable climate for a long time and our intended one-day stop developed into a six-days' stay. From Bali we went north to Borneo, following its east coast to Tarakan. A stop was made at Balikpapan, the great oil station. During this trip we were out of range of regular 600-meter coast stations and worked the *Augusta* and KUH, Manila, on short wave. From Tarakan we went to Zamboanga, the southernmost establishment in the Philippines, and from there proceeded to Manila after a refueling stop at Iloilo. One hundred miles south of Manila we were met by Lt. Straubel of the Army Air Corps, who escorted us in to the capital of the Philippines.

The wings were removed hurriedly and the ship loaded on the *Empress of Canada*. We sailed from Manila on December 10th after a very busy two days in the city that did not afford a chance to look up any of the KA's. Our next stop was at Hong Kong where, strangely enough, *QST* seemed to be available on every newsstand. Coffee at eleven in the morning according to the Hong Kong custom with VS6AG and a fleeting visit with VS6AF constituted the regrettably short opportunity to know these fellows before we sailed

at noon from the Kowloon wharf. The closest I came to ham contact during the voyage was a telephone conversation with K6CIB in Honolulu just before the ship sailed from that port. At Vancouver the plane was re-assembled and we

(Continued on page 80)



ON THE TIGRIS AT BAGHDAD



# Five-Hundred-Dollar Amateur Competition

## William C. Grunow Offers Awards for Ultra-High-Frequency Development

**T**O ACCELERATE technical development by amateurs and to encourage amateur activity on the ultra-high radio frequencies, William C. Grunow, radio manufacturing executive, is personally sponsoring a strictly non-commercial competition open to every licensed amateur operator in the world, excepting A.R.R.L. headquarters employees. Cash awards totaling \$500 and three all-wave receivers will go to the winners. The editors of *QST* have been designated to manage the competition and to judge the entries.

### RULES FOR THE COMPETITION

The rules are as follows:

1. All licensed amateur radio operators in the world, excepting A.R.R.L. headquarters employees, are eligible to compete.

2. The first award is \$300 in cash and one Grunow all-wave receiver for the entry giving the complete description and proof of the practical technical development or method which most increases the effectiveness of amateur communication on frequencies above 110 megacycles (wavelengths below 2.727 meters).

A second award of \$150 in cash and one Grunow all-wave receiver will be given for the next best entry, and a third award of \$50 in cash and one Grunow all-wave receiver for the third best.

Where two or more individuals collaborate on a winning entry, the award will be pro-rated among the collaborators as they shall agree.

3. The editors of *QST* are the judges of the competition. The decisions of the judges will be final.

4. No preliminary notice of entry is required. The entry itself shall consist of a complete written description of the equipment and the results obtained with it, accompanied by necessary diagrams, drawings and photographs. A statement of proof also shall be attached certifying that the equipment was built and operated as described, which statement should be signed by the individual entrant or collaborating entrants, and two technically competent witnesses. If deemed necessary, the judges shall have the right to require additional proof in such form as they may consider advisable. The description shall be in the English language, on one side of the paper, typewritten or handwritten with double spacing between lines. Diagrams and drawings should be on separate sheets and may be penciled but must be neat and legible. Photographs should be "sharp," preferably of post-card size or larger.

5. All manuscripts, photographs and drawings submitted become the exclusive property of A.R.R.L. for publication purposes. Publication of the material submitted, in whole or in part, in any other medium prior to its publication in *QST*, shall make the entry ineligible for award.

6. The competition begins March 1 and closes August 31, 1935, at midnight. The judges have the right, however, to declare "no competition" or to extend the period of the competition if, in their opinion, no entries of sufficient merit are received between the above specified dates.

7. All entries should be addressed to: The Grunow Competition, *QST*, 38 La Salle Road, West Hartford, Conn.

\* \* \* \* \*

Study Rule 2 carefully. Note especially that it specifies, "practical"—which means that untried and purely theoretical ideas, or things unfeasible for amateur application, will not be considered. Note also that "technical development or method" is specified—not only permitting something radically different (such as a new basic transmitting or receiving circuit, a different antenna system to give trick polarization, or the like), but also permitting more effective combinations of circuits and methods now in use. Note further the specification, "which most increases the effectiveness of amateur communication"—meaning that simple duplication of distance ranges previously achieved on these frequencies, repetition of existing equipment designs, etc., are not intended. And note finally that the frequency range specified is "above 110 megacycles (wavelengths below 2.727 meters)"—meaning that the work actually must be done on these frequencies and proof submitted that it was not done on lower frequencies.

So up and at it, gang. Don't let these fine awards go begging for winners.

# Hartford-Boston Link Established on Two and one-half Meters

Performance Over 90-Mile Path Upsets Expectations

By Ross A. Hull\*

**N**EW news of the month is the establishment of reliable contact over a 90-mile indirect path on 112 mc.—2½ meters. There is no denying that things have been popping hot and heavy on the ultra-high frequencies since last August and that ultra-high-frequency workers have had the lion's share of the thrills in the ham game. This work, though, was the thrill of all thrills.

Such 2½-meter working actually holds more significance, we believe, than the simple exchange of signals might indicate. It has given us all a particularly severe jolt because it happened at a time when we were on the verge of concluding that the frequencies higher than 60 mc. were destined to prove a grand and glorious disappointment. Now that 2½-meter signals have been pushed through from Hartford to Boston, morning, noon and night for a week of schedules, we are obliged to do some swift back-peddaling and to revise earlier views. The new evidence points definitely toward a marvelous future for the ultra-ultra-highs.

## HOW IT STARTED

The experimental work at West Hartford had been enlarged in scope to such an extent during the last few months that new and more comprehensive plans had to be made. Mr. L. M. Webb, W1HBD, took over the actual station operation, the combined equipment of W1AL and W1HBD being put in commission under the latter call.

For several months this station has been maintaining several schedules a day with W1XW (at the Blue Hill Observatory, Milton, Mass.) and with W1FQV (Cruft Laboratories, Harvard University). In addition to the routine procedure of making signal measurements on 56 mc., these schedules also included tests on the still higher frequencies. Innumerable problems were faced in the design and construction of transmitters, receivers and antennas for these frequencies and it is only recently that the various operators have been able to express some degree of satisfaction with their equipment. Failure to get any signals whatever on the very high frequencies gradually began to tell on the morale of the participants—until any one of them would have been prepared to admit that the ultra-ultra-high-frequency picture was a rather black one.

\* Associate Editor, QST.

And then it happened!

During an impromptu test between W1HBD and W1XW a week ago, the Hartford signals broke up the Boston peace and quiet. From that moment on, nothing else mattered. Eating and sleeping for the participants was entirely beside the point. Here were signals on 120 mc. which had all the earmarks of a superior product to those on 60 mc.! Nothing could be allowed to interfere with the business of discovering the ultimate truth. "To the devil," yelled the operators, "with everything else."

## ACCUMULATING EVIDENCE

This being a practical sort of world, it has not been possible, at this writing, to reach that final conclusion. All available spare moments have been devoted to the work, however, and we are slowly gathering evidence of importance. Both 60 and 120 mc. are influenced profoundly by the lower atmosphere and both are subject to a similar type of fading resulting, it appears, from the movements of air masses. Some particular type of atmospheric conditions would seem to favor 60 mc.; other types to favor 120 mc. The one thing that we can definitely state is that 120 mc. is not likely to prove much inferior to 60 mc. for this type of DX working.

The comparison has been made difficult by the problem of obtaining directive antennas of similar effectiveness on both bands. The first 120-mc. antenna used at W1AL was a single curtain of 8 antennas suspended about 12 feet above ground and about 3 feet above a metal veranda roof. Obviously, it was an inferior antenna to that used on 60 mc. Work was therefore started on an antenna system more nearly the equivalent of the 60-mc. affair. The result is the creation shown on the cover of this issue—a rigid structure carrying 8 antennas and 8 reflectors. This antenna has resulted in a splendid gain in signal strength but its present location still prevents an accurate comparison with the 60-mc. array. A somewhat similar state of affairs exists at W1XW where two separate receivers are used for the two bands, both operating with "singlet" receiving antennas. Measurements are still to be made of the relative effectiveness of these receivers. These matters are of tremendous importance to the observers participating because the signals on the two

(Continued on page 98)

# Grid-Bias Modulation for the General Purpose Transmitter

A Review of Operating Principles—Practical Construction and Adjustment Data

By George Grammer\*

JUDGED purely on technical merit, grid-bias modulation undoubtedly suffers by comparison with the familiar plate modulation system, not only because of its inherently greater possibilities of distortion, but also because the power output from a given tube capacity is considerably lower than that obtainable with plate modulation. Nevertheless, the lower cost and relative simplicity of the modulating equipment unquestionably are attractive features to many amateurs, especially those who already have c.w. transmitters which, if it were not for the expense of a power modulator, could occasionally be used on 'phone. If one is willing to accept the limitations of the system, however, particularly the reduction in output power, and can make the necessary adjustments intelligently, quite good results can be obtained.

Because of increasing amateur interest in the system, an investigation of the modulation capabilities and modulator requirements of the general-purpose transmitter described in January *QST*<sup>1</sup> was undertaken. The modulator built as a result of the data obtained is described in this article, together with an adjustment procedure which, in the absence of modulation-checking devices such as the cathode-ray oscilloscope, should prove to be wholly reliable. In general, the same modulator and method of adjustment also can be applied to other transmitters using similar tubes in the modulated stage. The adjustment procedure could be used with higher power tubes having different modulator requirements.

\* Assistant Technical Editor, *QST*.

<sup>1</sup> Grammer, "A General Purpose 50-Watt Transmitter," *QST*, January, 1935.

## OPERATING PRINCIPLES

Without a great deal more luck than most hams have in tuning up transmitters, a grid-bias modulated 'phone cannot be adjusted for proper modulation unless the operator has some understanding of the principles upon which the system works. Before getting down to tubes and volts, therefore, a review of the system should be beneficial.

The grid-bias modulated amplifier closely resembles the Class-B audio amplifier with which

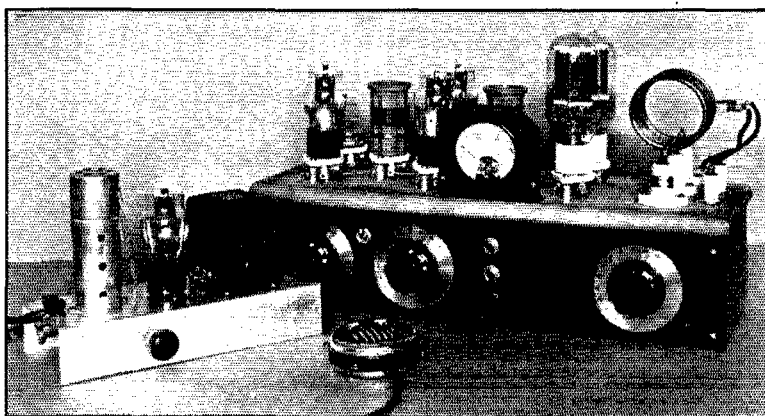

THE TRANSMITTER AND GRID-BIAS MODULATOR

The small knob on the front of the modulator chassis is the gain control. The 57 speech amplifier tube and its grid lead should be shielded.

The transmitter itself has been provided with the new G.R. Type 712 dials to facilitate re-setting of tuning condensers.

most amateurs are familiar. That is, the output load current should be proportional to the grid excitation voltage, which is simply another way of stating that the power output varies as the square of the exciting voltage. In the Class-B audio amplifier, the grid bias is adjusted to plate-current cut-off and the exciting grid voltage swing is limited to the straight portion of the dynamic grid-voltage plate-current curve; the tube draws plate current (assuming an ideal characteristic) only when a signal is applied to the grid.<sup>2</sup> Since the

<sup>2</sup> Readers who wish to refresh their memories on Class-B audio amplifier operation are referred to Barton, "The Class-B Push-Pull Modulator," *QST*, November, 1931.

output current is in half-cycles, two tubes in push-pull must be used to supply a complete undistorted wave form.

The Class-B linear r.f. amplifier differs from the Class-B audio amplifier in one fundamental respect. Since modulation as ordinarily practiced involves changing the power output both up and down from a mean or *carrier* value, the tube always draws plate current even when no modulation is taking place. This plate current, in fact, is just half the plate current drawn on the modulation peaks. When complete modulation is applied to the exciting signal, the plate current (and output current as well) varies both upward and downward from the unmodulated value, reaching twice the unmodulated value on the peaks and zero in the valleys. Since, if the amplifier is truly linear, the upward plate current swing is always exactly equal to the downward swing, the plate current as read by the d.c. meter in the circuit will not change from the unmodulated value so long as the modulation percentage does not exceed 100%.

The grid-bias modulated amplifier is closely equivalent to the linear r.f. amplifier, but with this difference—the variation in exciting voltage is obtained not from modulation in the preceding stage but by fixing the r.f. grid voltage in value and then changing the amount of it applied to the grid of the amplifier by varying the amplifier bias. The operation is shown graphically in Fig. 1.<sup>3</sup> An assumed dynamic grid-voltage plate-current curve is shown, the point "A" representing the upper limit of the straight portion of the curve and the point "C" the plate-current cut-off point. The point "B", in the middle of the straight portion, represents the r.f. operating point; with the grid biased somewhat beyond the cut-off value as at "O", the r.f. exciting voltage is adjusted so that the positive peaks cause a maximum instantaneous plate current represented by the value at point "A". If an audio voltage of suitable value is now superimposed on the fixed bias, as shown by the heavy line in the drawing, the r.f. exciting voltage will be swung back and forth, its peak reaching point "A" on the positive audio peak, and reaching the cut-off point on the negative audio peak. The plate current pulses

vary accordingly, and are shown to the right of the characteristic. The envelope of the plate current pulses has the same shape as the audio modulating voltage.

Although at first glance it might seem that the grid-bias modulated amplifier is working in exactly the same fashion as the linear r.f. amplifier, further consideration will show that because of the varying bias the shape of the plate current pulse under conditions of maximum output is not the same as under carrier conditions, and is different from either of these when the output is near zero. Assuming that the r.f. excitation wave is of sine shape, and taking the operating conditions shown in Fig. 1, the maximum plate current pulse is a half sine wave since the instantaneous grid bias reaches the cut-off value at the instant of maximum output. Under carrier conditions, however, the plate current pulse is less than a half sine wave, because plate current does not start to flow until the instantaneous r.f. voltage reaches the cut-off point; in the illustration this is half the peak value. Similarly,

near the maximum negative audio peak only the tip of the r.f. excitation voltage wave causes plate current to flow, so that the current pulse represents only a very small fraction of a cycle. Plate current pulses in the linear amplifier, on the other hand, always are actual half sine waves, since the amplifier bias is fixed at the cut-off point and the amplitude of the exciting voltage is varied. The part of the exciting cycle during which plate current flows—usually called the operating angle—is therefore constant in the Class-B linear r.f. amplifier but is always varying in the grid-bias modulated amplifier. The variation in operating angle is a factor which increases distortion in the grid-bias modulated amplifier over that normally expected in a Class-B linear amplifier.<sup>4</sup>

To keep the variations within reason, the angle under peak conditions should not exceed 180 degrees; that is, the plate current pulse should not occupy more time than that required for a half cycle. This means that the operating bias, "O", should be set beyond the cut-off point by an amount at least equal to the grid voltage required

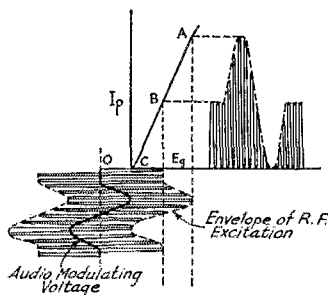

FIG. 1—IDEAL GRID-BIAS MODULATION CHARACTERISTIC, SHOWING INSTANTANEOUS VALUES

The r.f. excitation, which is fixed in amplitude, is swung at an audio rate about the fixed grid bias as an axis, the operating conditions being chosen so that the plate current and r.f. output current (not shown) follow the audio signal.

<sup>3</sup> Kishpaugh and Coram, "Low Power Radio Transmitters for Broadcasting," *Proc. I.R.E.*, February, 1933. This paper describes grid-bias modulation as used in Western Electric broadcast transmitters, the design being such that the requisite output is secured without running into the positive grid region in the modulated stage. This is not a fixed limitation on the grid-bias modulation system as such, however.

<sup>4</sup> An amplifier having constant operating angle even when biased beyond cut-off has been designed by Everitt and called by him "Class B Prime." See Everitt, "Operation of Class-C Amplifiers," *Proc. I.R.E.*, February, 1934. The Class-B amplifier operates with a combination of fixed bias and a self-biasing cathode resistor, requiring considerably more plate voltage than is necessary for ordinary operation without the cathode resistor.

to swing the plate current from "C" to "B". In other words, the positive peak of the audio voltage swing should not go more positive than the cut-off bias point. Some improvement in operation will result if the maximum angle is made smaller by increasing the operating bias still farther—that is, moving it to the left in Fig. 1—and increasing the r.f. exciting voltage so that its peak again reaches "B" under carrier or unmodulated conditions. While this process improves the linearity of the amplifier, it does not affect the amplitude of the audio modulating voltage required, this being the same in either case.

#### EFFICIENCY AND TUBE CAPACITY

Since for complete modulation the output current peak amplitude must be twice the carrier amplitude, thus imposing the requirement that the peak output power be four times the carrier power, the amplifier's efficiency must vary over the modulating cycle. Although the peak plate current is twice the average or carrier plate current, the plate voltage remains fixed; therefore the peak plate input is only twice the carrier input. To make up the difference in output power necessary to fulfill the requirements for proper modulation, the amplifier plate efficiency at the modulation peak must be twice the efficiency under carrier conditions. With double the plate input and double the efficiency, the output power is increased four times.

This gives us a clue to the carrier output power that can be expected from any given type of tube. In practice the maximum efficiency actually obtainable from a Class-B amplifier is in the neighborhood of 60%, although the theoretical efficiency is considerably higher. Since the 60% figure represents peak conditions, and is twice the carrier efficiency, the carrier efficiency at best will be something like 30%. The carrier output that can be expected from a given tube therefore will be the difference between its plate dissipation rating and that same rating divided by 0.7. In round figures, the carrier output can be considered to be equal to half the plate dissipation rating. Whether or not this figure is realized depends upon the choice of operating conditions and upon the efficiency of the apparatus in the tank circuit.

A wide variety of operating conditions—grid bias, excitation voltage, load resistance—can be used, all being capable of giving proper modulation. Only one load resistance will give optimum carrier output, however. To determine satisfactory operating conditions for the final amplifier in the general purpose transmitter, a series of test runs was made using three different types of tubes. The optimum operation characteristics obtained from these data are shown in Figs. 2, 3 and 4, for 801, 10, and 830 tubes respectively.

The curves of Figs. 2, 3 and 4 do not correspond to the characteristic shown in Fig. 1, but show the

average value of plate current (the d.c. meter reading) and the effective r.f. current in a resistance load, plotted against grid bias, with the r.f. excitation voltage constant.<sup>5</sup> The theoretical curve of Fig. 1, on the other hand, shows instantaneous values. The average type curve is more useful for practical work, since from it the selection of the proper operating point for 100% modulation and determination of the audio grid swing required are quite easy.

The proper operating grid bias will be the value read from the center of the straight portion of the r.f. load current curve. Curvature in the r.f. characteristic represents audio distortion, but the distortion will be well within tolerable limits on all three curves even if the whole characteristic shown is used. The fixed grid bias then will be simply that value which results in an r.f. current

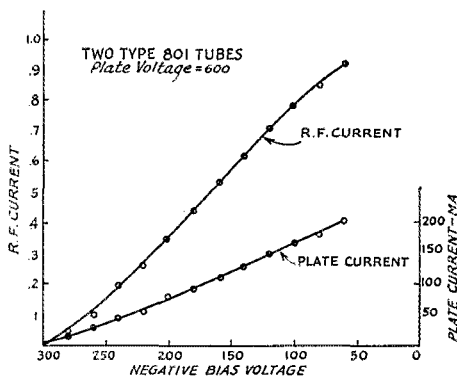

FIG. 2—TYPICAL GRID-BIAS MODULATION CHARACTERISTIC FOR A PAIR OF TYPE 801 TUBES

The r.f. current readings were taken in a resistance load and do not necessarily represent the magnitude of current that would flow in an antenna or feeder. If only one tube were used, the bias scale would remain the same while the r.f. current and plate current readings would be halved. The grid bias and audio peak swing required for complete modulation are functions of the type of tube used and not the number of tubes.

of half the maximum. The corresponding plate current can be found from the second curve. With the two 801 tubes, for example, the maximum r.f. current is about 0.9 amp.; the grid bias necessary to give a current of 0.45 amp. is 175 volts. The plate current under these conditions is about 95 milliamperes.

To give 100% modulation on the upward peak, it is necessary for the grid bias to swing from minus 175 volts to minus 60 volts as shown by the curve, a peak swing of 115 volts. The same swing in negative direction will reduce the output very nearly to zero. Similarly, the two Type 10

<sup>5</sup> Berejkoff and Fick, "Modern Radio Equipment for Air Mail and Transport Use," *Proc. I.R.E.*, August, 1932. This type of characteristic is shown for grid-bias modulation in comparing different systems as to their suitability for air-plane phone sets.

tubes at 500 volts plate require a fixed bias of 190 volts and should draw 85 ma., the peak audio swing required being 90 volts. For the particular curves shown, the 830's at 1000 volts would require a fixed bias of 210 volts and a peak audio swing of approximately 90 volts.

The curves for the 801 and 830 tubes represent

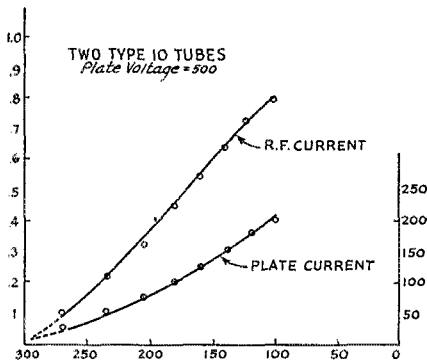

FIG. 3—TYPICAL GRID-BIAS MODULATION CHARACTERISTIC FOR A PAIR OF TYPE 10 TUBES WITH 500 VOLTS ON THE PLATES

the maximum usable operating angle, the peak audio grid swing coming just to the cut-off point at the particular plate voltage used. If a greater initial bias had been used, both the r.f. and plate-current curves would be moved further to the left, assuming that the excitation was increased to give the same plate current peak. While such operation is beneficial from the standpoint of linearity, more excitation voltage and more fixed grid bias are required. The curves for the Type 10 tubes illustrate this type of operation, since the peak plate current of 200 ma. is reached at a bias of 100 volts, whereas the actual cut-off at 500 volts plate is approximately 60 volts. The operating fixed bias as taken from the curves, 190 volts, therefore could be decreased by 40 volts, with a corresponding decrease in r.f. excitation, without making any considerable difference in the operation of the amplifier. The peak audio grid swing required for complete modulation would be just the same as already deduced from the curves.

From this it should be apparent that the actual fixed bias used with the grid-modulated amplifier is not by any means a critical value so long as it is high enough. The minimum satisfactory value is the cut-off bias plus the peak audio grid swing, both of which will vary with the type of tube used. It may be as much higher than the minimum value as the available excitation will permit. The really critical adjustments are those of loading and excitation, particularly the former, since the excitation always can be adjusted to fit a given load value.

#### PROPER AND IMPROPER MODULATION

With four variables—grid bias, r.f. excitation

voltage, loading, and audio grid swing—a change in any one of which is likely to affect the optimum value of the other, adjustment of a grid-bias modulated stage for the least modulation distortion and greatest carrier power output is not exactly easy. By contrast the adjustment of a Class-C plate-modulated amplifier, with its simple rules for determining plate voltage and plate current for use with a given modulator, is child's play. The oscilloscope is an extremely useful device in the adjustment of the grid-bias modulated stage, and a great deal can be learned from its use. In working with the transmitter and modulator illustrated, considerable time was spent in working out an adjustment technique by which oscilloscope patterns could be translated into meter readings so that the amateur without elaborate measuring equipment could at least approximate the conditions of optimum power output and proper modulation. The adjustment procedure recommended will be outlined later.

A number of typical oscilloscope patterns representing correct and incorrect operating conditions are shown in Fig. 5. For the benefit of those not familiar with the modulation "wedge"—which incidentally is the most useful form of pattern for checking modulation—it should be pointed out that the unmodulated carrier, when coupled to one set of the cathode-ray deflecting plates, will be seen on the fluorescent screen as a solid stationary line, represented by the dotted line in the three patterns shown.<sup>6</sup> When the carrier is modulated and the audio signal is simultaneously applied to the other set of deflecting plates, the solid carrier line is replaced by a wedge-shaped pattern of the type shown at A. The diagonal outlines of the wedge represent the actual modulation characteristic of the amplifier; that is, either outline corresponds to the r.f. current curves in Figs. 2, 3, and 4. With an ideal modulation characteristic the outlines would be perfectly straight lines, and at 100% modulation the lower ends on one side of the carrier would meet at exactly the same instant that the vertical distance between the outer corners of the wedge on the other side becomes twice the length of the carrier line. The Class-C amplifier closely approximates the ideal. The grid-bias modulated amplifier, however, has a "tailing" characteristic; that is, the r.f. current does not decrease uniformly with increasing negative bias but tends to be slow in reaching the cut-off point. In other words, if a positive audio swing of 100 volts, using arbitrary figures, causes the r.f. current to double, a negative swing of 100 volts will not cause the r.f. current to be zero, as it would be if the modulation characteristic were really linear. Complete cut-off might not be reached until the negative swing reached 120 or

<sup>6</sup> Waller, "A Practical Cathode-Ray Oscillograph for the Amateur Station," *QST*, March, 1934; Millen and Bacon, "A Simple Cathode-Ray Oscilloscope," *QST*, April, 1934.

130 volts. When this modulating voltage is used, however, the upward swing obviously will cause more than double the carrier current to flow on the peak. For this reason it is impossible to speak of a certain "percentage of modulation" with an amplifier of this type unless it is specified whether upward or downward modulation is meant.<sup>7</sup> For example, in "A", Fig. 5, which represents as nearly proper modulation as can be obtained with a system of this sort, the audio grid swing limits shown (equal excursions on each side of the carrier) give 100% upward modulation but less than 100% downward modulation. With a linear sweep circuit the oscilloscope would give a pattern like that at the right. The difference between modulation percentages on the upward and downward peaks is a measure of the distortion present.

If the load resistance is raised or lowered—by decreasing or increasing the coupling to the antenna, respectively—the point at which the r.f. current curves start to bend over at the top will be affected. This bending is just perceptible in Figs. 2 and 3. The higher the load resistance the lower the r.f. current at which the bending starts. The effect of using too high a load resistance is illustrated by the pattern shown at Fig. 5B. The pronounced bending as soon as the modulation swings upward causes the upward peaks to be flattened off. The particular wave shown is modulated 100% in the downward direction and only about 30% in the upward direction. Operation of this type is accompanied by a downward shift in plate current with modulation, and of course gives rise to considerable distortion. The remedy is to decrease the excitation until the unmodulated carrier line moves to the left, becoming smaller as it does so, until it is placed at the middle of the straight part of the characteristic; or else to decrease the load resistance by increasing the coupling to the antenna. Although a decrease in load resistance always is accompanied by an improvement in the linearity of the amplifier, it is also accompanied by a reduction in efficiency and probably by a decrease in output. The hardest adjustment to make to the grid-modulated stage is that of finding the load resistance, or antenna coupling, which gives the greatest carrier output and best linearity with 100% modulation. As a general rule it is necessary to use more coupling than that which gives maximum antenna current, assuming that the plate current is held constant at the figure predetermined from the efficiency rule. The important thing is to get the tube plate efficiency in the vicinity of 30%, which generally means a deliberate reduction in output.

The condition shown at "B" also represents a type of operation likely to result when the r.f.

<sup>7</sup> Gaudernack, "Some Notes on the Practical Measurement of the Degree of Amplitude Modulation," *Proc. I.E.E.*, July, 1934.

voltage regulation of the driver stage is poor. Since the load on the driver varies with modulation just as it does with the Class-B linear amplifier, the driver should have an excess of output power available. The driver also can be loaded to improve the regulation, duplicating the conditions found in linear amplifiers.<sup>8</sup>

One point in favor of the grid-bias modulated amplifier is that slight overmodulation in the upward direction in a properly adjusted amplifier can be tolerated before 100% downward modulation is reached. This reduces the tendency toward cutting off part of the audio cycle on the downward peaks, and thereby helps to prevent some of the interference caused by those virulent transients which arise as the result of "breaking off" of the carrier. This is not to say, however, that overmodulation is something to be practiced deliberately—quite the reverse—but simply that there is a little in reserve to handle those unexpected peaks which always accompany voice transmission. Bad overmodulation is very easy to get with grid-bias modulation, by the simple process of using too much audio gain. The sort

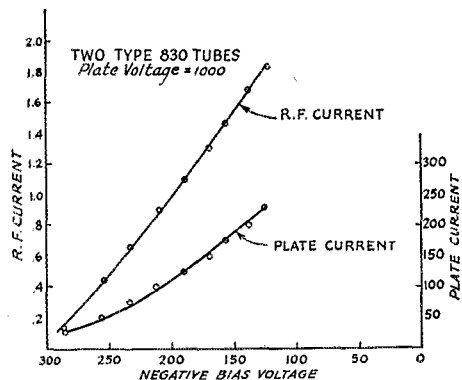

FIG. 4—TYPICAL GRID-BIAS MODULATION CHARACTERISTIC FOR A PAIR OF TYPE 830 TUBES WITH 1000 VOLTS ON THE PLATES

of pattern at "C", Fig. 5, is a picture of it. It does not, however, show how broad the signal is. The most unfortunate part of the story is that, our ears being very tolerant organs, such a signal still sounds pretty good and undoubtedly is louder than a properly modulated signal having the same strength—but its elbows stick out unduly into adjacent channels. All of which helps to account for the fact that, as modulation is practiced in the amateur 'phone bands, three 'phones have difficulty in working where six should get through with ease.

#### AUDIO REQUIREMENTS

As previously explained, the audio voltage

<sup>8</sup> See Winkler and Collins, "Grid Bias Modulation of the 100-Watt Type Power Amplifier," elsewhere in this issue.

swing needed for complete modulation of any of the three types of tubes under consideration is of the order of 100 volts, well within the capabilities of an audio tube operating at 250 volts or less. The audio power required depends somewhat upon the operating bias, r.f. voltage swing and load resistance, but is small in any case. Since the modulator load resistance, represented by the grid-circuit resistance of the amplifier, varies during the modulation cycle because of varying flow of grid current, it is desirable that the modulator have an excess of audio power and also that it be pre-loaded to some extent. The best type of modulator for this system is one using a tube of low plate resistance, such as the 45 or 2A3, or a pair of them in push-pull, coupled into the grid circuit through a transformer having a low-resistance secondary. Transformers designed to couple

only because the power output undoubtedly is ample, but also because a fairly high voltage gain can be obtained in the power stage and at least one stage of speech amplification could be eliminated as a result. Although admittedly less satisfactory with respect to varying load resistance than triodes, actual use of pentodes has shown that they do an excellent job as modulators in the grid-bias system. Lest some purists raise holy hands in horror over the "distortion" that pentodes give, let us point out first that they are universally used in speech amplifiers (the 57, no less) and as output tubes in most ham-band receivers, and nobody cavils at their employment in those capacities; and secondly, that far more distortion is put into amateur 'phone signals by overmodulation and unintelligent operation than ever could result from the inherent characteristics of one lone tube in the transmitter. It would take a nice ear indeed to pick out pentode distortion in the average ham 'phone signal received on the average ham 'phone receiver. Hence the modulator suggested in the photographs and diagrams uses a 2A5 output tube.

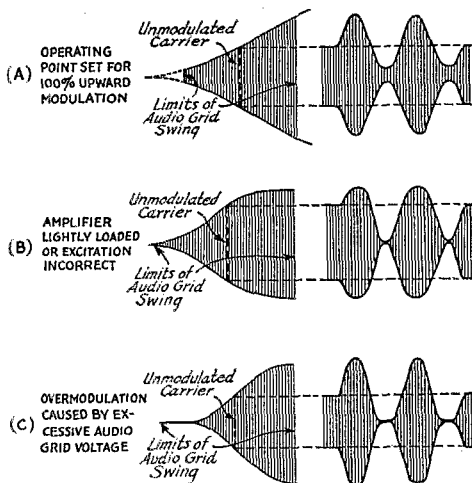

FIG. 5—OSCILLOSCOPE PATTERNS REPRESENTING PROPER AND IMPROPER MODULATION

The pattern obtained with a correctly adjusted grid-bias modulated amplifier is shown at A. The other two drawings indicate non-linear modulation, accompanied by distortion and a broad signal.

a driver to a Class-B audio stage are quite satisfactory.

Although low plate resistance triodes, which have a broad output characteristic with respect to load resistance, are the most suitable type of tube for the modulator, their use ordinarily will mean that a fair-sized speech amplifier is necessary because such tubes have very low voltage gain. If a speech amplifier and modulator comparable to the speech-amplifier and driver of a good Class-B modulator system is necessary, the attractive simplicity and economy of the grid-bias system of modulation begin to look, to our minds at least, a bit tarnished. For that reason first consideration was given to the use of a pentode-type power tube as the modulator, not

#### A PRACTICAL MODULATOR

The business of selecting a speech amplifier lineup for a modulator always is something of a problem when one of the known conditions is that probably no two amateurs who build it will use the same type of microphone. About all it is possible to do is to specify the audio voltage required at the modulator grid—in this case about 10 volts peak—and remark that sufficient speech amplification must be provided to bring the output of the particular microphone used up to that level. In our case a sort of compromise has been effected by providing one high-gain stage which can be used with any type of microphone having, either with or without a suitable transformer, an output of about a tenth of a volt. The input of the unit can be coupled directly to a crystal microphone, as indicated in Fig. 6, the circuit diagram, or to a microphone transformer. With the Turner Type G microphone, shown in the photograph of the set, complete modulation of the transmitter is easily possible when the microphone is spoken into in a normal tone of voice at a distance of two or three inches. Since crystal microphones vary in sensitivity it may be found necessary to use a second speech amplifier stage—a 56 resistance- or transformer-coupled is suggested—if the particular unit used is found to have insufficient sensitivity.

Different arrangements may be required for other types of microphones. The condenser, ribbon and dynamic types should be provided with pre-amplifiers which will bring the voltage up to 0.1 volt at the input terminals of the unit diagrammed in Fig. 6. The double-button carbon microphone can be used simply with its transformer connected to the input terminals, as



indicated in Fig. 7. If a single-button microphone is used, a 56 is recommended for the first stage, replacing the 57, since the high gain of the latter will not be required. With some single-button microphones it is possible to dispense with the pre-stage altogether, using only the 2A5 modulator working out of the microphone transformer.

The wiring of the modulator unit as shown by Fig. 6 is the usual resistance-coupled arrangement up to the plate circuit of the 2A5. The audio voltage applied to the grid of the 57 is regulated by the potentiometer  $R_1$ . The 57's cathode resistor,  $R_3$ , is shunted by  $C_1$  and  $R_2$  to prevent degenerative effects. The resistors  $R_4$  and  $R_9$  compose the voltage divider for the screen of the 57. The screen voltage must not be too high if distortion is to be avoided.  $C_2$  and  $C_3$  are the plate and screen by-pass condensers, respectively;  $R_5$  is the 57's plate load resistor,  $C_4$  the audio coupling condenser, and  $R_6$  the 2A5's grid resistor. The 2A5's cathode resistor  $R_7$  is shunted by  $C_6$ , an electrolytic condenser of at least 10  $\mu\text{f.}$  capacity. The larger the capacity the better the low-frequency amplification.  $C_5$  is the usual plate by-pass.

The transformer  $T$  is a Class-B input transformer connected so that the turns ratio is 1:1. In transformers intended for coupling a push-pull driver to the Class-B grids this means that the outside terminals of the windings should be used, the centertaps on both primary and secondary being unused. Some Class-B input transformers have a total-primary to total-secondary turns ratio of slightly more than 1:1, which correspondingly reduces the output voltage. This reduction will not generally be great enough to have any serious effect, however, so long as the ratio is approximately 1-to-1. The transformer primary is shunted by the load resistor  $R_8$ , which keeps the plate load at about the right value for the 2A5. This resistor is an important factor in the operation of the modulator. It should have the value shown and must be capable of dissipating about 3 watts, the maximum output of the tube.

One advantage of having few stages is that feedback troubles are practically nil. Without shielding other than that shown, no feedback troubles of either audio or radio origin were encountered in operation, although in the experimental layout the connecting leads were quite long and draped indiscriminately around the apparatus, as they are likely to be in such work. If the microphone has a shielded lead the shield should of course be connected to the lower input terminal in Fig. 6. The polarity of the output connections will not matter ordinarily, although it will do no harm to try reversing the connections to find if there is any difference in the performance under operating conditions.

#### PUTTING THE SYSTEM TO WORK

In the original wiring diagram of the general-purpose transmitter the amplifier was wholly leak-biased, the grid leak being connected between the center-tap of  $L_4$ ,<sup>9</sup> the amplifier grid coil, and the junction of the amplifier filament by-pass condensers. To use the amplifier for grid-bias modulation it is necessary to disconnect the grid leak and run a separate lead out from the center-tap of  $L_4$ . This lead connects to one output terminal on the modulator, preferably through an r.f. choke, as shown in Fig. 8. The other out-

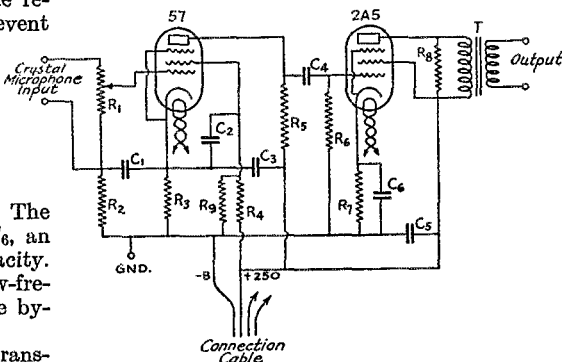

FIG. 6—CIRCUIT DIAGRAM OF THE MODULATOR SHOWN IN THE PHOTOGRAPHS

- $C_1$ —1  $\mu\text{f.}$
  - $C_2, C_3, C_6$ —2- $\mu\text{f.}$  electrolytic, 450-volt rating
  - $C_4$ —1  $\mu\text{f.}$ , 500-volt rating
  - $C_5$ —10  $\mu\text{f.}$ , 50-volt rating
  - $R_1$ —500,000-ohm potentiometer
  - $R_2$ —100,000 ohms,  $\frac{1}{2}$  watt
  - $R_3$ —3500 ohms,  $\frac{1}{2}$  watt
  - $R_4$ —100,000 ohms,  $\frac{1}{2}$  watt
  - $R_5$ —250,000 ohms,  $\frac{1}{2}$  watt
  - $R_6$ —500,000 ohms,  $\frac{1}{2}$  watt
  - $R_7$ —400 ohms, 2 watt
  - $R_8$ —7500 ohms, 5 watt
  - $R_9$ —50,000 ohms,  $\frac{1}{2}$  watt
  - $T$ —Class-B input transformer, ratio approximately 1:1
- A power supply furnishing 2.5 volts at 3 amperes and 180 to 250 volts at 40 milliamperes is required.

put connection goes to the negative terminal of the grid bias source, the positive grid-bias connection being returned to the filament center-tap. No other changes need be made in the transmitter itself.

Batteries are unquestionably the most satisfactory type of grid-bias supply for this system of modulation, because of their low resistance. If a power pack is used, the grid bias may not stay constant with modulation, since the normal increase in grid current on the modulation peaks causes a greater voltage drop across the bleeder of the power pack and thereby causes the operating point to shift. The effect is the same as though the carrier power were suddenly reduced whenever modulation is applied. With a heavy-duty power pack having a large by-pass condenser (8  $\mu\text{f.}$  or more) across the part of the bleeder in use, and also having a bleeder resistance of not

<sup>9</sup> Fig. 1, page 17, January, 1935, QST.

more than a few thousand ohms, the shift in grid bias is not objectionable, and the use of such a power pack as a bias supply is thoroughly practical. With suitable precautions as to insulation between oscillator-buffer and amplifier plate supplies, if two are used, the oscillator-buffer plate supply can be used to provide the necessary grid bias for the amplifier,<sup>10</sup> thus obviating the necessity for a separate source of grid bias. In any case, it is desirable that the bias be readily adjustable; if not continuously variable, at least variable in steps of 25 volts or so.

In the absence of a cathode-ray oscilloscope, the most satisfactory way of determining the optimum operating conditions would be for the operator to run a series of curves such as those



RESISTORS AND CONDENSERS ARE PUT IN THE MOST CONVENIENT LOCATIONS UNDERNEATH THE MODULATOR CHASSIS

The ground binding post is fastened on the rear side. A six-wire cable, two pairs of wires being paralleled for heater connections, is used to bring in plate and filament power. The aluminum chassis is 9½ inches long, 4 inches wide, and 1¾ inches deep, formed from one sheet with the sides bent down. The input and output terminals are double binding post assemblies.

given in Figs. 2, 3 and 4, using a number of different load resistances. Unfortunately, however, few power supplies can maintain constant plate voltage over so wide a range of plate current, and if the curves are to give a true picture of the operation of the amplifier it is essential that the plate voltage be fixed at a constant value. Furthermore, running curves of this type toward the maximum values causes considerable strain on the tubes. The following rule-of-thumb adjustment procedure has therefore been worked out to give correct modulation and to approximate, at least, the optimum output conditions.

1. Determine the operating plate current. To do this it is necessary to know the plate dissipation rating of the tube and to have some idea of the voltage regulation of the power supply. Using the efficiency rule given earlier, the output to be expected will be about equal to half the total plate dissipation rating of the amplifier. In the case of two Type 10 tubes, for example, the

total plate dissipation will be 30 watts, since each tube is rated at 15 watts. An output of about 15 watts therefore can be expected from the two tubes. The total plate input will be the output plus the plate losses, or 45 watts. If the plate voltage is 500, the plate current will be 45 divided by 500, or 90 milliamperes. The voltage regulation of the power supply must be taken into account here, since it is necessary to know that the voltage actually is 500 at a current of 90 ma. Although the plate dissipation rating can be exceeded without damage for intermittent work, as in keying, it is highly desirable to keep within the ratings when the amplifier operates continuously at low efficiency. If the plate supply has the poor regulation usual with condenser-input filters, it is necessary to find a combination of plate voltage and load current which gives an input of 45 watts. If no high-voltage voltmeter is available a milliammeter can be put in series with the plate-supply bleeder temporarily and the voltage determined approximately by applying Ohm's Law. (Voltage equals bleeder resistance in ohms multiplied by bleeder current in amperes.)

2. Having determined the operating plate current and plate voltage, set the bias at or slightly beyond the cut-off value for that particular plate voltage. The cut-off bias had best be taken from the published characteristic curves of the tube or tubes used, particularly if the plate supply has poor regulation, rather than by increasing the bias until plate current flow ceases.

3. Apply all the excitation available and adjust the load on the amplifier to give maximum antenna or load current. Pay no attention to the plate current, which undoubtedly will be greater than the value determined by Paragraph 1. This does not mean to adjust for maximum efficiency but maximum output. It may take a 100% increase in plate current to give a 10% increase in antenna current, but nevertheless the extra 10% in antenna current is important. Get every bit of output there is to get.

4. Leaving all other adjustments alone, increase the negative bias until the plate current drops to the operating value determined from Paragraph 1.

5. With the audio gain at full, speak into the microphone. The antenna current should increase with modulation and the plate current should rise. Now reduce the gain until the plate current shows only an occasional slight upward flicker and the amplifier will be properly modulated, hitting the 100% mark only on the peaks, as it should. There should not be a definite upward shift in plate current with voice modulation, but only an occasional flicker at the most. On the other hand, the amplifier is not operating properly unless it is possible to get the upward shift,

<sup>10</sup> This arrangement for biasing a final stage was used in the transmitter described in May, 1934, *QST*, in the diagram given on page 50.

which simply shows that the upward modulation peaks are not being flattened off in the fashion shown at Fig. 5B. With speech, the antenna current should show maximum increase of about 5%.

This operating procedure should result in optimum power output in almost every case, although conditions peculiar to a particular transmitter may result in a departure from the normal when the final step in the chain is reached. The behavior of the plate milliammeter gives a quite good indication of the conditions existing in the amplifier in case it does not perform as stated in Paragraph 5. If the plate current cannot be made to change with modulation, two things are possible—either the speech amplifier does not have enough gain for the particular type of microphone used, or the modulation characteristic is flattening off on the upward swings just as much as it tails off on the downward swings. Although this latter is a special case, it is not an unusual one to realize in practice. To locate the trouble, decrease the

antenna coupling, retune the circuits, and reduce the grid bias until the plate current is the same as before; this procedure probably will result in a higher antenna current. Now apply modulation; if there is still no change in plate current the speech-amplifier gain is insufficient. If the modulating voltage is high enough, however, the plate current will shift downward, indicating the sort of performance pictured at Fig. 5B. It then becomes necessary to increase the antenna coupling a little at a time, readjusting the grid bias to give the same plate current as each coupling change is made, until the plate current shows a definite upward shift with modulation. The audio gain then should be reduced for normal operation. This same process should be gone through if the plate current shift is downward instead of upward when the stage of Paragraph 5 is reached.

It is evident that the load resistance adjustment is extremely important. The amplifier cannot simply be adjusted for maximum output at the given plate current, since the efficiency usually is too high under those conditions. It is necessary to find the load resistance or antenna coupling which, while giving linear modulation, also results in the greatest carrier output. The five steps outlined above are a practical means of reaching that end.

#### ADDITIONAL POINTERS

Since modulation is taking place in the grid circuit of the amplifier, it is necessary, if the

hum-on-carrier level is to be kept low, that the plate supply for the oscillator and buffer stages be well filtered. Ripple in the output of the buffer will modulate the amplifier output equally as well as the intended modulation. The same thing is true if a power pack is used as the bias supply for the amplifier. The system is very much less tolerant in this respect than the Class-C plate-modulated amplifier, since grid saturation in the

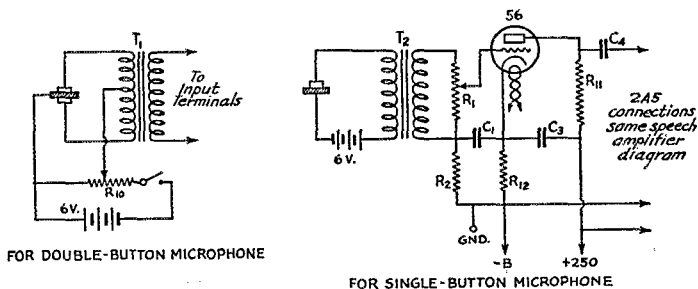

FIG. 7—ALTERNATIVE INPUT CONNECTIONS FOR DOUBLE- AND SINGLE-BUTTON CARBON MICROPHONES

In the double-button microphone diagram,  $R_{10}$  is a 200-ohm wire-wound potentiometer and  $T_1$  a double-button microphone transformer. For a single-button microphone it is suggested that a 56 replace the 57 since the gain required is small.  $T_2$  is a single-button microphone transformer,  $R_{12}$  a 5000-ohm,  $\frac{1}{2}$  watt resistor, and  $R_{11}$  a 50,000-ohm  $\frac{1}{2}$  watt resistor. Other values are identical with those given in Fig. 6.

latter tends to wash out low-amplitude modulation on the buffer output.

So far nothing has been said about grid current, since grid current flow in itself is not a limiting factor in the operation of the amplifier. It has, nevertheless, an effect on the operation of the system because of the loading effect on both the r.f. driver stage and the modulator. The actual grid currents under carrier conditions with the three types of tubes are quite low, being approximately 2 ma. with the pair of 10's, 5–6 ma. with the pair of 801's, and 3–4 ma. with the pair of 830's. The grid current swings upward slightly with modulation, the variations being appreciable before the plate current shows a similar shift. This is perfectly normal. The buffer stage in the transmitter has ample r.f. output for driving all three types of tubes as grid-bias modulated amplifiers, a 400-volt supply for the oscillator and buffer being sufficient.

The discussion in this article has been confined to the three types of tubes under consideration, all three of them being readily usable in the general-purpose transmitter. Also, all three are triodes of the same general character; that is, they have amplification factors in the vicinity of 8. A little consideration will indicate that tubes having medium  $\mu$ 's are in general better fitted to grid-bias modulation than either high- or low- $\mu$  tubes. Regardless of the type of tube, the fixed grid bias should at least equal the sum of the peak audio grid swing required for complete modulation plus

the cut-off bias of the tube. Tubes of the same general type but having different amplification factors (such as the 203-A, 211, 845 group) all will require about the same audio grid swing for complete modulation, so that not much is gained with respect to bias supply by using a high- $\mu$  tube.

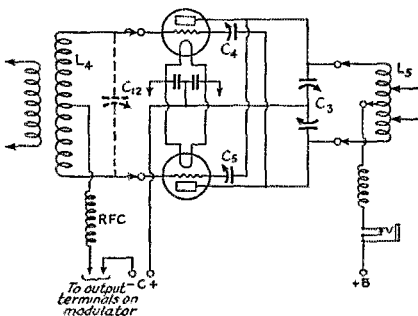

FIG. 8—GRID CIRCUIT CHANGES IN THE FINAL AMPLIFIER OF THE GENERAL-PURPOSE TRANSMITTER TO FIT IT FOR GRID-BIAS MODULATION  
Legends on components are the same as those given in January QST.

On the other hand, the high- $\mu$  tubes take considerably more grid current than those having medium  $\mu$ 's, which increases the loading on the modulator. Conversely, a low- $\mu$  tube, because of the large grid bias needed to cut off plate current, makes a high-voltage bias supply necessary and at the same time requires a rather high r.f. excitation voltage. For these reasons tubes having amplification factors of 8 or 10 are to be preferred.

Summing up, the grid-bias modulated amplifier offers a means of obtaining 'phone operation with a minimum of additional equipment over that required for the usual c.w. transmitter, and when properly handled is capable of giving results which cannot be called other than entirely satisfactory. Against these are the comparatively low plate efficiency and the greater care and skill needed in adjustment. Proper adjustment is everything. The method we happened to overhear being advocated on the air—"quite simple, old man; I just tune her up the same as for c.w., raise the bias a bit and then modulate"—simply will not work, and that particular 'phone was mighty good proof of it. 'Phone operation is a long way from being as easy as that.

## Strays

Add to odd coincidences: First station worked by VE3AAY after a layoff of several years was W3AAY!

A note from W6ASQ brings up a point about eliminating broadcast interference which is not

likely to occur to the harassed ham. In investigating a receiver on which his 3500-ke. 'phone caused interference, cleaning up a doubtful-looking splice in the antenna lead-in to the receiver completely wiped out the 'phone signal, which had been riding in on top of the local b.c. station. His explanation, which seems reasonable, is that the poor splice probably was acting as a copper-oxide rectifier and giving cross modulation.

-----  
Would-be hams in Chicago will be interested to know that a course in amateur radio is offered at the Crane Evening School. The dope comes from W9SFR.

-----  
We neglected to mention, in the stray which caused all the rumpus resulting in "Shootin' the Works" in the January issue, that the air rifle used should be a high-power affair like the Benjamin. Our contributor, now W2HBX, also writes that when the gun is a .22 the long-rifle cartridge should be used. We repeat, don't forget the backstop!

-----  
The boys on the five-meter band in greater Boston were rudely awakened the other night from their matter-of-fact QSO's when a QRR rang out in their loud speakers. The resulting traffic tied up the low-frequency end of the band for about an hour, and the rest of the band was nearly dead while the fellows followed the course of the traffic.

The emergency came about as follows: W1INE was working W1DBM who was mobile, with W1BR riding with him. While W1DBM was driving and talking, his car was struck by a hit-and-run driver skidding on the icy pavement. The front end and wheels were crushed and W1BR was stunned when his head hit the windshield. The five-meter signals stopped and W1INE sensed that something was wrong. He got in touch with W1HOM, who was also mobile in that vicinity, and started looking for the car. Meanwhile W1DBM in the wrecked car was unable to raise anyone with his set and started out on foot for help. W1BR then took over the transmitter in the car and started calling QRR. This was picked up by W1FQV who got W1HOM on the trail, and he soon found the boys who were in trouble. On account of his high power and favorable receiving position W1FQV was the only one able to hear and work all the stations concerned, so he acted as control station for the traffic and relayed messages from the wreck to W1INE who put them on the 'phone. Relatives were sent out to collect the two unfortunate hams and a wrecker was sent for the wreckage. After about an hour all was normal on the band again, but those who handled the traffic had a thrill they will remember for some time, and amateur radio had once more proved its usefulness in an emergency.

# A Simple Photographic Recorder for the Experimenter

The Design of an Instrument Suited for Signal-Measurement Work

By Ross A. Hull\*

ONE of the many things we have long wished for is a recording meter of some kind: a gadget which could be hitched to a receiver, power line or other source of changing voltage and left to itself to make a picture of everything that happens. Such a recorder could have been purchased. Certainly, we would have followed that admirable course of procedure if we had had the necessary few hundred dollars on tap. They never were.

Our hankering after a recorder came to a head recently, when we realized the absolute necessity of getting a continuous observation of diurnal and day-to-day variations in 56-mc. signals over the Hartford-Boston path. We had to do something about it.

Our first would-be recorder was built around a dynamic speaker, the moving coil being coupled to a lever mechanism carrying a pen riding on a paper-covered drum. The rig failed because of lost motion in the drive mechanism and general irregularity of operation resulting chiefly from the load offered by the pen running on the paper. The second recorder (which only reached the design stage) was to have used a cathode-ray tube arranged so that its spot made the record on a moving strip of sensitive paper. The scheme was turned down because of the probability that the very slow moving spot would burn a track in the fluorescent coating. There was also an obvious problem in the maintenance of accurate calibration.

The recorder we needed was one which would be absolutely reliable in almost continuous operation; which would maintain its calibration without attention; which could be controlled with an absolute minimum of power and which could be modified to allow simultaneous recording of the output of several receivers or other instruments. The thing also had to be inexpensive and simple to build.

The outcome of all this cogitation and

experiment is the recorder illustrated. Since it complies with all the above requirements and since it has proved completely practical in prolonged operation, we present it as a piece of equipment of probable value to anyone engaged in signal observation work.

This final recorder was evolved from the thought that the most desirable possible basis for the instrument would be an ordinary standard meter operating under normal conditions. The job of transferring the movements of the meter needle to paper would have to be done photographically but this, we thought, did not present insuperable problems. Much paper and many pencils were burned up in reducing the possible schemes to the very simple one shown in Fig. 1. In this arrangement, the face of the meter is illuminated by two 10-watt lamps. An image of the meter face is then thrown, by means of an ordinary camera lens, onto the side of a drum carrying sensitive paper. A slit is then arranged immediately in front of the drum so that every-

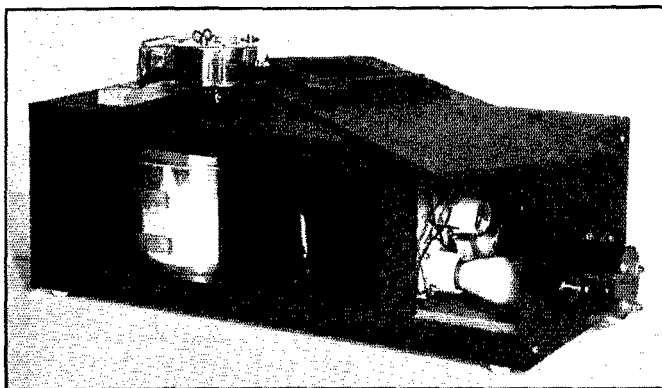

THE "HOME-BREW" SIGNAL RECORDER USED AT WIAL TO KEEP TRACK OF SIGNAL VARIATIONS ON THE ULTRA-HIGH FREQUENCIES OVER LONG INDIRECT PATHS

*Recorders built according to this very simple scheme might well be widely used by experimentally inclined amateurs interested in observation work.*

thing on the meter face is eliminated except an extremely small slice of the calibration marks and the needle. Then, as the drum rotates, the calibration marks record as straight lines while the needle produces a "trace" corresponding to its movement.

\* Associate Editor, QST.

It is futile to attempt to describe in detail the construction of this particular recorder. Dimensions will all vary in accordance with the focal length of the lens used, the size of drum available and the desired size of the recorded image. Then, most workers will have their own opinions with respect to constructional methods. It might be well, though, to cover some of the more important

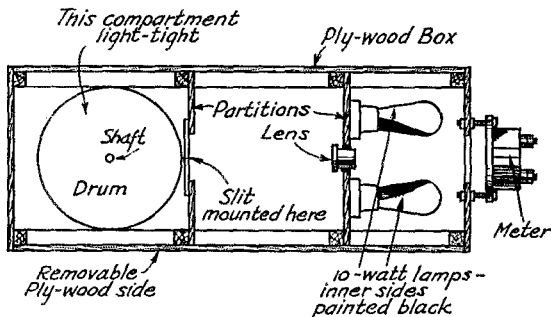

FIG. 1.—A SECTIONAL VIEW OF THE RECORDER SHOWING THE ARRANGEMENT OF THE DRUM WITH RESPECT TO THE LENS AND METER

basic requirements.

In this design, it was considered that a paper speed of two inches an hour would take care of the slow signal variations found on the ultra-high frequencies. Search was therefore made for a drum having a circumference of about 24 inches. An aluminum saucepan with vertical sides proved to be ideal for the job. The next item was the lens. An old  $f$  4.5 anastigmat of 3-inch focal length was located and set up experimentally to determine the necessary spacings between the meter face, lens and drum. This was facilitated by using the torn edge of a piece of paper, well illuminated, in place of the meter. In this instance, the drum, lens and meter were so arranged that the image of the meter was exactly the same size as the meter itself. In this way, the preparation of the slit was facilitated. Any cheap lens from a drugstore box camera could be used instead of the anastigmat providing the illumination is increased suitably.

With the main dimensions available, construction of the box was begun, its length being such that the meter could be mounted an inch or so away from the box end. By doing this, provision was made for accurate focussing and also for visual examination of the meter dial with the aid of a "dentist's mirror." Ply-wood was used throughout for the box, corner pieces being fitted to simplify construction and to avoid light leaks. The whole of one side was made removable so that the drum could be loaded conveniently and so that the lens or lamps could be adjusted or replaced.

After locating accurately the center of the saucepan lid and bottom, a  $\frac{3}{16}$ -inch tapped brass rod was fitted for a shaft. Its lower end was made conical and supported in the end bearing of an old Cardwell condenser. The upper end of the shaft was connected with an ordinary flexible coupling to the hour-hand shaft of the clock. The paper clips on the drum were made from two pieces of thin brass rivetted at their centers to the drum wall.

Construction of the slit was simplified by using a piece of glass painted with Duco "Flat Black." The slit was then scratched with a pair of dividers set to the same radius as that of the meter calibration. The precise location of this slit is, of course, of prime importance. In our recorder it was set so that only the dial divisions representing tens of units crossed it. The meter used, incidentally, is a rectifier type a.c. instrument connected across the secondary of a transformer in the output circuit of the receiver.

A satisfactory sensitive paper for this work is known as "P.M.C. Bromide No. 1 Contrast." It may be developed with "Nepera Solution," or any of the scores of other paper developers available, and fixed in the usual acid fixer. The procedure is extremely simple and occupies but a few minutes.

Many possible changes in this design suggest themselves immediately. A more elaborate recorder we are now planning will have, for instance, a larger drum permitting a paper speed of

(Continued on page 100)

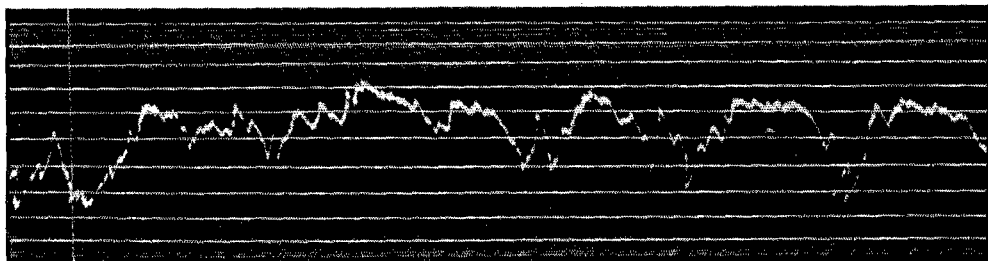

A SAMPLE RECORD OF THE CONTINUOUS TONE SIGNAL OF W1XAV AT SQUANTUM, NEAR BOSTON TAKEN AT W1AL

The full-scale reading of the meter, connected across an output choke on the receiver, is 100 volts

# Grid-Bias Modulation of the 100-Watt Type Power Amplifier

Operating Characteristics and Comparison with Other Systems

By Walter H. Wirkler and Arthur A. Collins,\* W9CXX

MODERN control-grid modulation is handicapped by some very questionable ancestry, one of the earliest attempts consisting of inserting a microphone in series with the grid leak of a triode oscillator. This and other early arrangements were characterized by a low modulation percentage and a just as low order of intelligibility. Fortunately, scientific treatment has eliminated such hereditary throwbacks and within the past few years high-quality grid modulation has been successfully applied to broadcast transmitters.<sup>1</sup> However, these transmitters operated the grid-modulated amplifier entirely in the negative grid region so that the plate efficiency was limited to about 20% and the ratio of carrier output to tube rating was very low. The type of control-grid modulation now under discussion involves the use of a. f. and r. f. drivers with good regulation so that the grid may be driven positive without distortion of the grid voltage. The resulting higher output makes this arrangement comparable in performance to a Class-B linear amplifier using the same tubes. While no particular novelty is claimed for the circuit or principles involved, data have been obtained which permit a rational method of design.

The table compares the advantages and disadvantages of control-grid modulation with three other leading systems of modulation, the comparison indicating this system as advantageous for certain types of transmitters. The data in the table are based on the use of air-cooled tubes of the 211, 830-B and RK-20 types but are more or less applicable to larger and smaller tubes. It will be seen that Class-B plate modulation still compares favorably with the other systems, retaining the advantages of low tube cost, low distortion and simple operating equipment.

The newer r. f. pentode amplifier with suppressor-grid modulation is also easy to adjust

and no neutralization or intermediate amplifiers are required. These features recommend this tube especially for use in light-weight transmitters where a simple frequency shift system must be used and where these advantages off-set the somewhat higher tube cost. The r. f. power pentode is a relatively new development and the ultimate limitations of suppressor modulation cannot be definitely stated until further tube developments can be made.

The Class-B linear amplifier is practically ruled out for general purpose use because of the additional buffer stage required and because adjustment is so complicated that it can scarcely be made without the aid of an oscilloscope.

Control-grid modulation overcomes these disadvantages of the linear amplifier. The tube

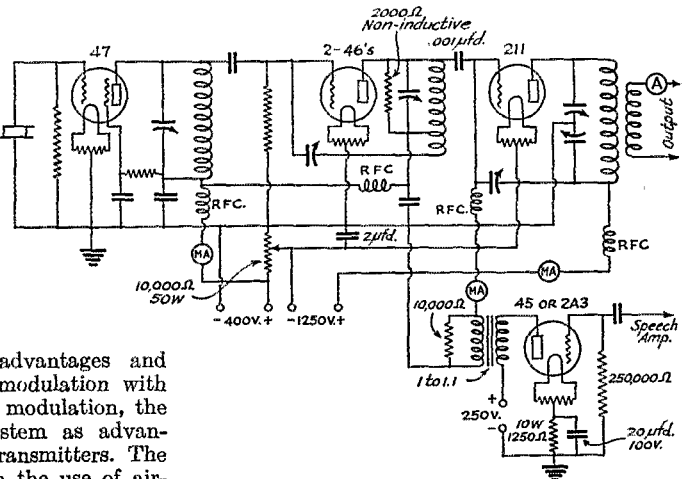

FIG. 1—SIMPLIFIED SCHEMATIC OF THE GRID-BIAS MODULATED TRANSMITTER

cost per carrier watt approaches the low figure for Class-B plate modulation and there is only one additional operating adjustment—that of grid bias. A control-grid modulated transmitter is particularly desirable where the full tube capacity may be used for c. w. telegraph operation so that the c. w. power is two or three times that of the 'phone power. Likewise, Class-B plate modulators may be added without modifying the r. f. line-up when it is desired to increase the 'phone power of the transmitter.

\* Collins Radio Co., Cedar Rapids, Ia.

<sup>1</sup> This type was described in the article, "Making Practical Use of Grid-Bias Modulation," by R. A. Isberg, *QST*, Aug., 1932.—EDITOR.

Fig. 1 shows the simplified circuit of the grid-modulated transmitter. It will be noted that the audio modulating voltage is applied to the grid of the final amplifier in series with the adjustable d.c. bias voltage. The audio driving tube has a low plate impedance and it is coupled to the transmitter by a transformer and resistor combination so that the audio voltage is not distorted by the flow of grid current. Relatively high values of d.c. bias voltage are necessary. Therefore, the low voltage power supply in the transmitter is arranged to furnish bias voltage to the last stage, adjustable by means of a potentiometer. The grid current is quite low so that a small bleeder current is sufficient to maintain the bias voltage

substantially constant at varying levels of modulation. Good r.f. driver regulation is accomplished by using a low plate voltage intermediate amplifier with a loaded tank circuit directly coupled to the grid of the modulated stage, as with a Class-B linear amplifier.

Fig. 2 shows a series of modulation curves indicating how the r.f. output varies with the grid bias. Any convenient value of r.f. excitation voltage may be used although slightly higher plate efficiency is obtained with higher values of r.f. grid voltage and correspondingly greater negative bias. It is usually not desirable to have the operating angle exceed 180° at the most positive point on the a.f.

TABLE OF COMPARISON

Points of Comparison	Class C Amp. with Class-B Plate Modulation	R.F. Pentode with Suppressor-Grid Modulation	Class-B Linear R.F. Amplifier	Control-Grid Modulated Amplifier
1. Approx. carrier plate efficiency	60%	25%	30%	30%
2. Approx. tube cost per carrier watt (incl. only tubes in modulated stage and Class-B Modulators)	\$0.35*	\$1.00	\$0.45	\$0.45
3. C.w. Power compared to phone Power	Same	Two or three times greater	Two or three times greater	Two or three times greater
4. Can carrier power be increased by applying plate modulation?	..	If one of grids also is modulated	Yes	Yes
5. Number of intermediate r.f. stages necessary	One	None	Two	One
6. Neutralization	Yes	No	Yes	Yes
7. Relative audio driving power required**	(Modulator Grids) 0.03	(Suppressor) .05	(Plate modulation of r.f. driver) 0.10	(Control grid) 0.05
8. Relative r.f. driving power required**	.10	.05	.10	.10
9. Necessary operating adjustments	1. Plate loading 2. Audio gain	1. Plate loading 2. Audio gain	1. Plate loading 2. Plate loading low-level stage 3. Grid bias 4. R.f. excitation 5. Audio gain	1. Plate loading 2. Grid bias 3. Audio gain

\*In comparing initial cost, the cost of the modulation transformer should also be considered in Class-B plate modulation.

\*\*Figured as ratio of grid input to carrier output.



cycle.<sup>2</sup> The curves in Fig. 2 are calculated point-by-point by the method given by Everitt.<sup>3</sup> Constant r.f. excitation voltage is presupposed.

angle of 180°, the tube would function at peak output exactly as if it were a Class-B linear amplifier.

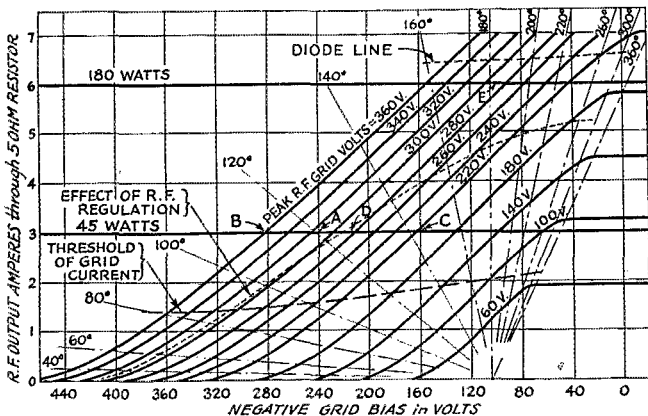

FIG. 2—CALCULATED GRID-BIAS MODULATION CHARACTERISTICS FOR A 211 TUBE

Showing the effect of r.f. grid excitation. Plate load resistance,  $R_L$ , 2500 ohms; plate voltage  $E_b$ , 1250 volts.

If r.f. regulation is such that the r.f. voltage increases as the grid swings negative, the modulation characteristic will swing from one to another of the curves as indicated by the dotted line. This r.f. regulation will therefore necessitate a greater a.f. swing for complete modulation and may introduce distortion because of non-linear grid impedance. The r.f. regulation can be made negligible by proper artificial loading of the driver stage.

Typical operating conditions for a 211 operated as a grid modulated amplifier are given on page 62.

These conditions of operation are represented by the operating point, "A", in Fig. 2. As previously explained, any other operating point, such as "B" or "C", may be chosen with only slightly different performance. It is interesting to observe that if the excitation and bias were adjusted to correspond to the operating point "D", and so that peak output occurs at "E" with an operating

<sup>2</sup> The "operating angle" indicates the portion of the r.f. cycle during which plate current flows, a full half-cycle being 180 degrees. See, "Vacuum Tubes As Power Oscillators", by D. C. Prince, *Proc. I.R.E.*, June, Aug. and Oct., 1923; also the paper referred to in the next footnote.—**ERROR.**

<sup>3</sup> W. L. Everitt, "Optimum Operation Conditions for Class-C Amplifiers", *Proc. I.R.E.*, Feb., 1934.

The plate load resistance should be as high as possible consistent with obtaining the required peak output before approaching the "diode point" or the point at which the instantaneous plate voltage approaches the most positive grid voltage. The effect of using different load resistances with a given value of r.f. excitation is shown in Fig. 3. A load impedance of 2500 ohms is about the optimum value for a 211 operated under the conditions specified. Lighter loading reduces the peak power output and heavier loading increases the plate loss. The d.c. plate current

is also shown on Fig. 3 and it will be noted that there is considerable upward curvature. This curvature is evidenced in actual operation by the d.c. plate current "talking up" slightly under complete modulation.

The discussion of adjustment thus far has dealt with such intangible quantities as load impedance, operating angle, etc., and it is now desirable to see how a specific transmitter may be tuned up without thinking about anything

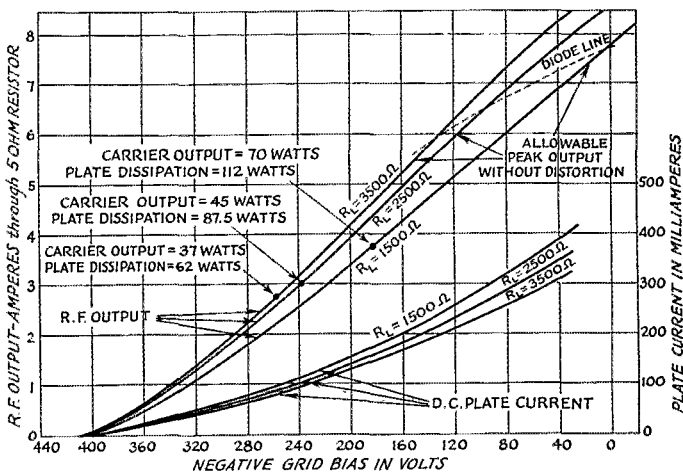

FIG. 3—CALCULATED GRID-BIAS MODULATION CHARACTERISTICS FOR A SINGLE 211 TUBE

Showing the effect of changing plate loading.  $R_L$  Peak r.f. grid excitation, 310 volts; plate voltage, 1250 volts.

other than meter readings. The transmitter is first adjusted for c.w. operation with the buffer plate coil unloaded and with the 211 operating as a Class-C amplifier. The bias potentiometer is

(Continued on page 68)

# More Audio Watts from a Single Type 10

An Audio System Adapted to Modulator Use

By Robert McConnell,\* W8FJ, and August Rspet\*\*

THE following are the results of some rather cursory experiments using a Type 10 in an unconventional, but simple, compensated Class-AB circuit. The hookup used is that of the Type 95 (Triple-Twin) tube—really two triodes in a single envelope. At the appearance of this tube several years ago it occurred to the authors that it should be possible, using the special 95 circuit, to accomplish much the same results by combining two of the “standard” tube types, choosing from those available and of convenient power rating.

This has been done, as shown in Fig. 1. Circuit constants are given but because the optimum values for some of these constants depend upon individual experimental conditions and because some amateurs may wish to try the hookup with other tubes, a general explanation of the operation of the circuit will be helpful.

First, however, let us relate what the 10 can do in this circuit. Using a 500-volt plate supply, 7 watts of audio were obtained at what was esti-

form could have been called passable. All of this, be it noted, was obtained with a 45 driver and a single 10, without expensive audio transformers, using only several quite ordinary chokes.

The 45 driver stage operates Class-A. The proper bias for the 45 is supplied by the drop in  $R_3$  caused by the total plate current of both tubes, plus the drop in  $L_1$  due to the d.c. resistance of the choke and the plate current of the 45.

The plate load for the 45 is  $R_1$ , diminished somewhat by being paralleled by the filament-grid circuit of the 10 (as will be explained later). This placing of the plate load in the filament return instead of the B-plus circuit is a procedure not entirely strange to the ham, having been done occasionally in receivers and almost always in heterodyne monitors.

In order to supply the bias to the 45, the grid return must be at the d.c. potential of ground. But in order to swing the grid of the 45 properly, the grid return must be also at an audio frequency potential equal to that of the 45 filament. By means of the condenser,  $C_1$ , the audio voltage on the grid return is by-passed to the filament of the 45. By means of the de-coupling resistor,  $R_4$ , the 45 grid is tied to ground. Resistor  $R_4$ , while fixing the d.c. potential of the grid (no d.c. current flowing), prevents the short-circuiting of the plate load resistor  $R_1$ .

The Type 10 operates in what might be called a sort of a Class-AB service. The potential drop across  $R_2$  is sufficient, not only to overcome the positive bias that would otherwise be placed on the grid of the 10 (owing to the plate current of the 45 flowing through the d.c. resistance of  $L_1$ ), but also to give some negative bias to the 10 grid. It can be seen, therefore, that the proper value of  $R_2$  will depend upon the d.c. resistance of  $L_1$ . The grid voltage for the 10 is of course developed across the 45 plate load,  $R_1$ .

The plate circuit of the 10 is conventional.  $L_2$  feeds the d.c., and  $C_2$  is a load coupling condenser. With 50 ma. at 500 (total) volts on the 10, a load resistance of 6000 ohms was found convenient but not at all critical. (With the 95 a 4000-ohm load is recommended.) An output transformer could, no doubt, be used to advantage in the 10 plate circuit. And  $C_3$  and  $C_4$  provide audio by-passes for the bias resistors.

## WHY IT WORKS

Now for the explanation and excuse for all of this circuit rearranging. The circuit permits the

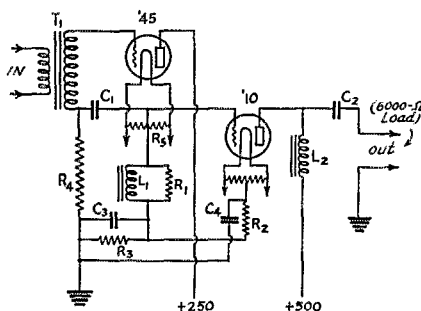

FIG. 1—THE TWO-TUBE TRIPLE-TWIN CIRCUIT

- $R_1$ —5000-ohm 2-watt
- $R_2$ —600-ohm 2-watt
- $R_3$ —300-ohm 2-watt
- $R_4$ —200,000 ohms
- $R_5$ ,  $R_6$ —40-ohm filament c.t. resistor.
- $L_1$ —20- or 30-henry 40-ma.
- $L_2$ —20- or 30-henry 60-ma.
- $C_1$ —2- $\mu$ fd. or more
- $C_2$ —2- $\mu$ fd. or more, 1000-volt
- $C_3$ ,  $C_4$ —2- $\mu$ fd.
- $T_1$ —Audio transformer.

mated less than 5% distortion. Plate efficiency was between 25 and 30%. Upon raising the plate supply to 600 volts with 53 ma. through the 10 (the craving for power having somewhat dulled our critical sensibilities) an output of 13.7 watts at 43% plate efficiency was obtained. The wave

\* 151 Center Ave., Emsworth, Pa.

\*\* R. D. No. 2, Export, Pa.

combining of two forms of distortion of such type and in such phase that the resultant output level can be raised quite high before the allowable harmonic distortion limit is exceeded. The grid of the 10, as was hinted previously, is swung into the positive grid region on the peaks. When the grid becomes positive there are two causes which, combined, tend to give an output wave shape like that shown in Fig. 2.

The first of the causes for the first type of distortion is the failure of the driver stage to maintain a sinusoidal signal on the grid of the Class-AB stage, when the grid of such a stage goes positive. As long as no current flows from filament to grid of the driven stage, the driver supplies only the losses of the coupling arrangement. But when the grid of the driven stage goes positive, the driver must supply current as well as voltage for a portion of the cycle, and unless the output of the

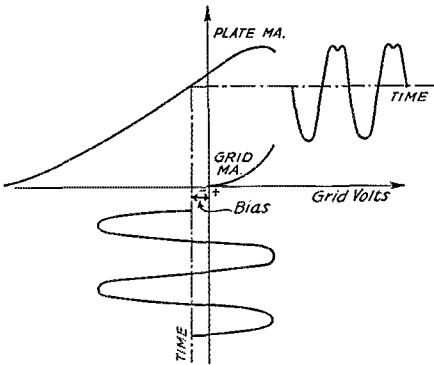

FIG. 2—DYNAMIC CHARACTERISTIC OF THE TYPE 10 CLASS-AB STAGE

This simplified graph, neglecting variable bias, shows the two causes of the first type of distortion. (See text.)

driver is ample and the regulation of the transformer good, the voltage drop from filament to grid of the driven stage will be less on the positive peaks than on the negative.

The second cause for the first type of distortion lies in the occurrence of secondary emission from the plate. This causes the dynamic characteristic to droop in the positive grid region as shown in Fig. 2.

The effect, then, of poor driver regulation and of secondary emission is to give an output wave that will tend to look like that of Fig. 2; a plate current wave flattened on the peaks.

The second type of distortion, which is purposely introduced, and which at least partly compensates for the distortion previously described, occurs because the grid of the 10 is placed across the plate load,  $R_1$ , of the 45 driver. The effect of this is shown in Fig. 3. When the grid of the 10 goes positive and draws current, the grid impedance drops from near infinity to a value comparable with that of the resistor,  $R_1$ .

Being in parallel with  $R_1$ , the 10 grid causes the plate load on the 45 to drop on the positive peaks. Since the dynamic characteristic of a tube varies with the plate load on the tube—the lower the

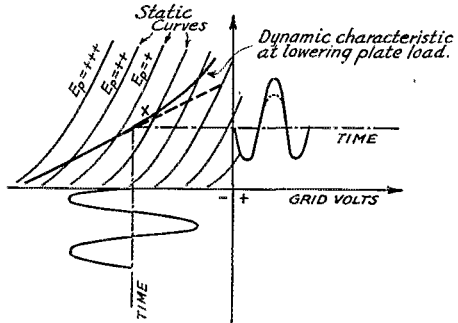

FIG. 3—DRIVER STAGE CHARACTERISTIC SHOWING THE SECOND TYPE OF DISTORTION

"X" marks the point at which the grid of the Type 10 goes positive.

load, the steeper the characteristic—the result is to lift the dynamic characteristic of the 45 at the peak plate current end. It follows that the output wave is raised on the peaks. Since, as may be readily shown, the phase angles of these two types of distortion are in proper relation, they tend to annul one another and permit a high output.

In all probability the original type 95 was designed mathematically to give little distortion. The authors' method in using the 10, however, was to "cut and try." An audio signal was obtained from a variable frequency oscillator specially designed to give a nearly sinusoidal signal, and wave shapes were observed on a 5-inch oscilloscope. This equipment was supplied by Carnegie Tech.

This circuit lends itself admirably to a push-pull arrangement, but a little consideration will show that the p.p. input transformer inconveniently must have two entirely separate secondaries. An output transformer must be used, of course, or else the audio system must be floated above ground.

As a suggestion: The use of tubes of the low- $\mu$  class to replace the 10 in the Class-AB stage is thought inadvisable.

No doubt there will be those sticklers for perfection who will frown upon this device as being a compromise. What merit the circuit may have must lie in its simplicity and low cost.

## **Strays**

Some of those long CQ's might be understood (if not appreciated) if the listener would only realize that the CQ'er is either reading a book or eating while he's pounding away at the key.

—W4BMC

# Neutralizing the Class-B Modulator for Greater Fidelity

By F. J. Burris, W6KGG\*

IT IS often found that, after adding a high-power Class-B modulator to an existent audio amplifier, the quality of reproduction has been dealt a severe loss. This fault is due in general to three factors, only two of which are accorded much attention. In this discussion it will be assumed that these latter two have been adequately taken care of; that is, stable excitation, and good plate-power supply and grid-bias voltage regulation (with suitable r.f. chokes in all mercury-vapor rectifier plate connections).

The third factor with which we may be concerned is that of neutralizing the Class-B audio amplifier. This does not imply that the amplifier may have been unstable or was liable to crack into parasitic oscillations on excitation peaks, etc. Neither is the amplifier apt to go into sustained oscillation, because of circuit losses and loading. The author has never had to resort to stabilizing resistors in order to control an efficient amplifier either in broadcast or amateur work, and therefore thinks their use an unnecessary evil.

In general, phase-shift distortion increases with frequency in any audio transformer. The transformer may actually tune at some particular point in the audio range without a pronounced peak, below which frequency it will present an

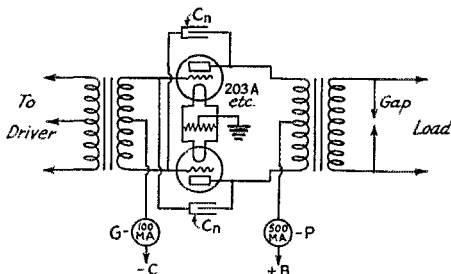

FIG. 1—DIAGRAM OF THE NEUTRALIZED CLASS-B MODULATOR STAGE

inductive reactance and above which point it will have a slight capacitive reactance. It may also be said that the plate circuit load must be inductive at the frequency for which there is regeneration; hence it may be considered that the higher the audio frequency, the higher the amount of degeneration and thus the greater the loss of high-frequency amplification.

With present-day receiver equipment adequate

\*1205½ El Centro Ave., Hollywood, Calif.

high audio-frequency reproduction may well be tolerated in the transmitter. This will enhance the sibilance and therefore the intelligibility of the conversation, besides adding the valuable personality touch to the speaker's voice which is so

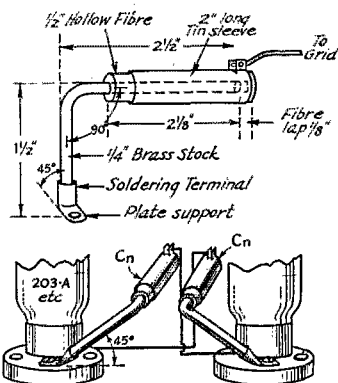

FIG. 2—DETAILS OF THE NEUTRALIZING CONDENSERS

appreciated when the listener knows the speaker directly. There is thus an actual gain to be realized, however small, in neutralizing any transformer-coupled amplifier. Several db of high-frequency response may be recovered thusly from the pyramidal losses of several stages.

With the neutralizing condensers  $C_n$  connected as shown in Fig. 1, the modulator may be balanced with the plate voltage off as in the case of a radio-frequency amplifier, the null being found with a pair of headphones connected across the output while a suitable steady frequency is applied in excitation. If this balance cannot be attained completely over the audible band, due to the difference in characteristics of the input and output transformers, it is best to adjust it at the highest range of frequencies it is desired to preserve.

A very suitable neutralizing condenser may be made as shown in Fig. 2, which is sufficient in dimensions for any tube including the 203-A. It should be correspondingly longer for an 849 or any tube having greater plate-to-grid capacity. A soldering lug of the variety used in connecting motors, etc., forms the support which is fastened directly to the tube socket terminal. Into this is soldered the L-shaped length of brass welding stock of quarter-inch diameter, this forming the

(Continued on page 108)

# More Effective Pre-Selectors for Our Receivers

## Converting Tuned R.F. Receivers Into Two-Stage Units—A Tuned-Grid Tuned-Plate Design—Adding Regeneration to the Single Stage

WITH the present trend of manufactured superhets toward increased input selectivity well under way, and with effective ready-made two-stage pre-selector units making their appearance on the market, many of the fellows owning last year's super are casting an inquisitive eye at some of the still older receiving equipment and speculating on how it might be put to work in bringing that FB Pro, Comet 7X or home-built Sniggle-Sniggle up to the modern standard set by the two-stage input jobs. Typical examples illustrating how this modernization already has been made are described herewith by a group of amateur contributors. Needless to say, the design fitting in best with what you have available will prove worth following.

### Converting the SW-3

By Henry F. Kroupa, \*W2AND

IN FOLLOWING the trend of the up-to-date amateur radiophone stations, a superheterodyne receiver was installed at W2AND. It was found, under actual operating conditions, that the one fly in the ointment was insufficient pre-selection in the high-frequency circuits. This condition is of vast importance in the congested bands allotted to 'phone operation.

The idea came to mind of applying a stage or two of pre-selection for reducing image response to a minimum. The primary consideration was a pre-selector that could be applied at the least expense, which indicated use of any existing equipment already available at the station.

An ACSW-3 was idle except for monitoring of 'phone transmissions. Why not convert this into a pre-selector?

Fig. 1 shows the original schematic of this unit, while Fig. 2 gives the circuit after conversion to the pre-selector. The numerals inserted at the points of various connections indicate the five major changes necessary for the conversion. Let's enumerate and explain them individually. Referring to the figures:

\*Box 53, Bohemia, L. I., N. Y.

1. Insert a 300-ohm resistor for cathode bias.
2. Open lead at plate of second tube, formerly the detector.
3. Remove condenser lead from cathode of audio tube and place in shunt with 300-ohm resistor, leaving ground connection intact.
4. Remove lead from plate of audio tube, and connect to the plate of second tube. This provides a direct connection from binding post to plate of second tube.
5. Remove grid leak and condenser of detector and make a direct connection to the grid of tube from the variable condenser.

The two-stage pre-selector unit is now ready for application to the particular receiver in use. It may be adapted to any short wave superheterodyne receiver in the ham station, regardless of whether or not it is already equipped with pre-selection. If the receiver is already equipped with a stage of pre-selection, it will certainly be a revelation to the operator when he once uses this unit in addition. The r.f. gain will be tre-

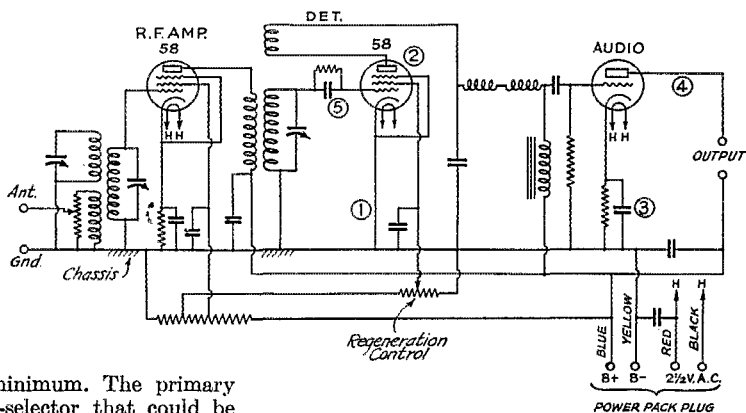

FIG. 1

mendous and the selectivity will be to the  $n$ th degree. The application to a receiver not already equipped with pre-selection will put that receiver in the class of the finest short-wave super now available.

The usual input circuit of the FB type superheterodyne has a series fixed condenser in the antenna lead circuit within the receiver. This must be either removed or shorted out. Also, the ground terminal is bonded to the chassis. This bonding must be removed to prevent shorting the plate supply of the second r.f. tube. The output terminals of the pre-selector now will

be merely direct connections to the input of the super.

The next step is the method of coupling. The pre-selector unit output terminals are connected with shielded wire to the antenna and ground terminals of the superheterodyne. This shielding

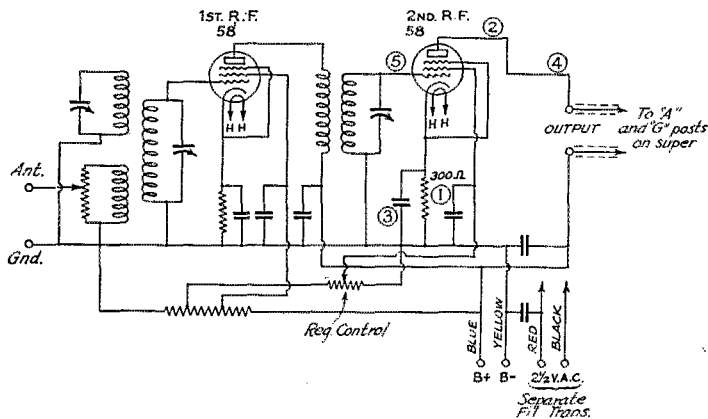

FIG. 2

may or may not be grounded, depending entirely on the local condition of image frequency response. This condition would arise from the proximity of a high-power short- or intermediate-frequency transmitter. When grounding the shielding, a decrease in gain was observed which had to be compensated by the gain control on the receiver. It must be borne in mind that the gain obtained with the pre-selector is of such tremendous proportions that the slight decrease (on the order of S-1) can be taken care of by the receiver. Since the leads are individually shielded, two are required.

#### POWER SUPPLY

The final connections may now be made; which are, of course, the necessary plate and filament supplies for operation of the pre-selector unit. Since the set-up at this station may apply to numerous others, it will be described first; and then other possible layouts will be explained.

When the receiver was purchased (FB-7A), it was found that the available power pack was suitable for the receiver's demands. This pack is the one used formerly with the SW-3, namely a National 5880-AB. It was necessary to secure a separate filament transformer for the pre-selector, but it was still possible to use the plate supply of the 5880-AB. This necessitated the removal of the four-prong plug on the pre-selector (SW-3) unit and connecting its red and black (filament) wires to the separate filament transformer. The blue and yellow wires were connected direct to the B+ and B- of the 5880-AB unit.

In the event that an operator has the larger power pack designed for the FB-7A, the situation

becomes simpler. The four leads from the pre-selector would be connected in parallel with the superheterodyne's power leads—keeping in mind, of course, that the proper terminals are connected at the pack plug.

The final case is where the operator has other than an FB-7A and the power pack is already installed within the receiver. This will necessitate either tapping the contained power unit or using the standard unit that is manufactured for the SW-3. The use of the separate pack for the SW-3 is very simple, and means merely plugging into the pack in the usual manner and connecting its "B" to that of the receiver pack.

The conversion is now complete and the receiver may be placed in operation. The extra tuning control, which the pre-selector itself introduces, is not as much a handicap as it might be thought. After the operator has once used this unit, he finds that it is only necessary to "track" the pre-selector dial with the super's tuning. Either band-spread or regular coils can be used. The antenna trimmer dial is adjusted only once in the initial installation of the unit, to set the first and second r.f. circuits in resonance. The receiver's r.f. gain control is set on whatever point the operator finds comfortable to the ears, the "R-9" point (minimum gain) being used exclusively at this station. The gain can also be controlled by the operation of the former regeneration knob, which now governs only the gain of the second r.f. tube. This can be disconnected from the circuit if desired, as can any other component parts of the unit which are not being used. All has been left intact in this station since an emergency may arise requiring the original SW-3 for service. It would be very simple to reconvert back to the original circuit.

In conclusion, it might be mentioned that the FB-7 is given as an example because this was the equipment available at this station. The combination is one which is common in a great many ham stations, however; and where a different receiver may be in use, a little thought devoted to the problem will bring results up to the par achieved here. This set-up at the writer's station has been giving excellent results for many months.

\* \* \* \* \*

A circuit somewhat different from that described by W2AND, also adaptable to the SW-3, is shown in Fig. 3. Here regeneration is used to full advantage in the first stage and the output

is choke-capacity coupled to the input of the super. The increased gain and selectivity provided by regeneration in the first stage effectively improve the signal-noise ratio, of course. The regenerative first stage is less likely to overload than a regenerative second stage, since it works at a smaller signal input voltage. As a further refinement, to give a separate control of gain ahead of the first detector, a variable cathode resistor might be used in the second stage.

It will be noted that the usual antenna coil is used as the tickler and that a separate winding is shown for antenna coupling. This may be a fixed coil of somewhat larger diameter than the plug-in form, mounted permanently on the coil socket; or it may be fitted over an electro-static shield as described further on by W2AOE. In arriving at the proper size tickler for each plug-in coil (ticklers may be somewhat smaller than usual) turns should be removed until the circuit just breaks into oscillation with the regeneration control set near maximum screen voltage. The circuit should never be allowed to oscillate in operation, however.

#### SINGLE-TUBE REGENERATIVE PRE-SELECTORS

Fig. 4 shows a tuned-grid tuned-plate stage used by OA1B, designed and built especially for 14-mc. 'phone reception by the late Mr. J. L. Stauff shortly before his tragic death. The circuit and physical arrangement are shown in Fig. 4. This unit also was designed to be used with an FB-type receiver and employs SW-3 type coils with the primary windings removed. As indicated, the plate and grid circuits are coupled through a 3-plate variable condenser, which serves as the

receiver. The point just below oscillation gives the maximum selectivity and gain. Under these conditions the signal strength is tremendously

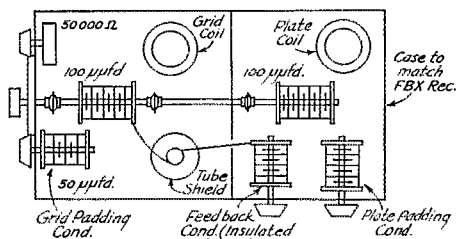
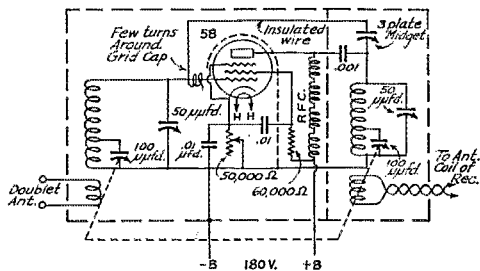

FIG. 4

increased with a considerable reduction in background noise, the calibrated volume control of the FBX being kept down between "R6" and "R9" at all times—indicating no small improvement in useful sensitivity.

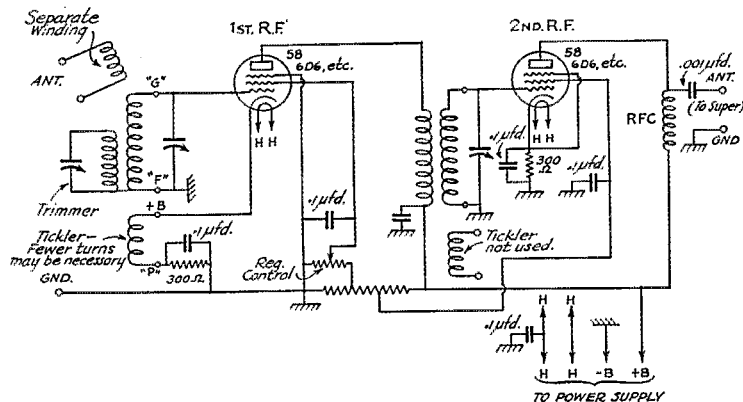

FIG. 3

regeneration control in conjunction with the high-resistance variable cathode resistor. In operation, the feed-back control condenser is adjusted so that the tube breaks into oscillation with a few hundred ohms of cathode resistance in circuit. Hence, this cathode resistor "handles" much like the regeneration control of a t.r.f.

The problem was to do this job easily and quickly without adding more controls to the receiver. I did this by using the antenna coupling coil as a regenerative winding located in the cathode of the r.f. tube. In my receiver I had a cathode filament control operating on the first r.f. and detector stages. I cut the detector out of this

\* \* \* \* \*

Still another regenerative single-stage arrangement, used by W2AOE in his Single-Signal superhet, is shown in Fig. 5. Quoting from his short description:

"In the original design, some image trouble was encountered on 14 mc. I finally decided to add regeneration to the r.f. stage to eliminate this difficulty and, at the same time, to increase the sensitivity.

circuit so that it is working at full gain and, at the same time, removed the a.g.c. from both tubes.

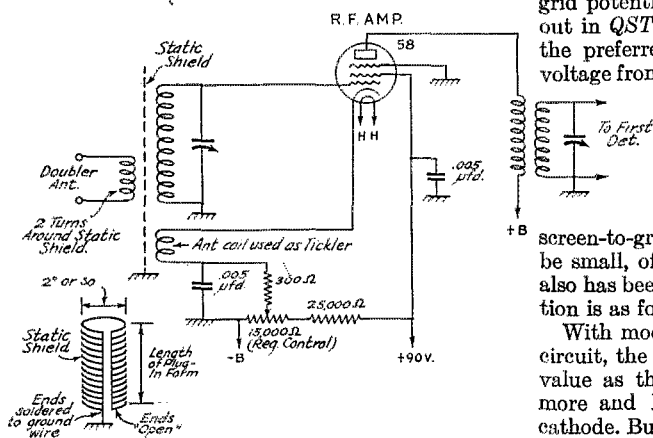

FIG. 5

"Coupling to the antenna is now made with a two-turn coil wound on the outside of a Faraday (static) shield which fits over the coil socket so that the regular National coil (SW-3 type) may be plugged into the socket inside of the shield without difficulty. I made this shield from some "air-wound" inductance similar to the sort of coil George Grammer made for his transmitter, described in *QST* for last May, except that the material available was close-wound. No alteration was necessary in the former antenna coupling coils to secure regeneration on all bands.

"In operation, the receiver now works very smoothly, image response is completely eliminated, and a healthy increase in gain is obtained. With the r.f. gain control turned up and the i.f. gain control turned down, considerably less set noise results.

"Undoubtedly the boys who have built their own Single-Signal receivers would like to make the change. It certainly is a great improvement."

—J. J. L.

## Screen-Grid Supply with Suppressor-Grid Modulation

IN APPLYING suppressor-grid modulation to the r.f. stage using a tube such as the RK-20 in circuits such as that shown in Fig. 1, there is

one particular feature that deserves special mention. This is the method of obtaining the screen-grid potential. As has been previously pointed out in *QST*,<sup>1</sup> for best linearity of modulation the preferred method is to tap off the screen voltage from a voltage divider across the high-voltage plate supply, with the simpler method of using a series dropping resistor as second choice. Supply from a separate source of fair to good regulation is highly undesirable. Further than this, the screen-to-ground by-pass capacitance should be small, of the order of 0.002  $\mu$ f. or less, as also has been specified previously. The explanation is as follows:

With modulation applied to the suppressor circuit, the plate current varies about its mean value as the suppressor is swung alternately more and less negative with respect to the cathode. But the screen-grid current also tends to vary as the suppressor voltage changes, and its variations are opposite in sense to the plate current. Therefore, when the plate current becomes minimum, on the most negative suppressor

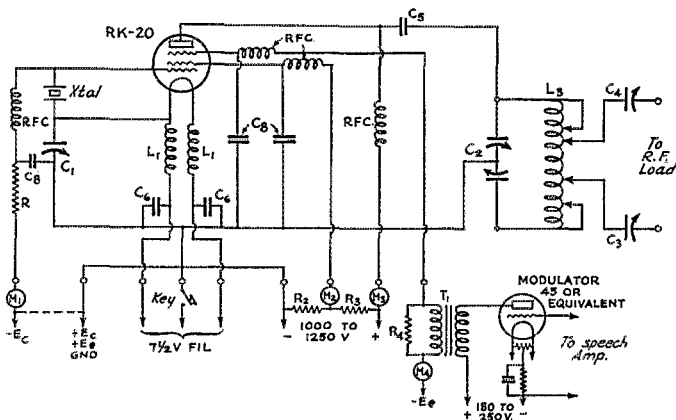

FIG. 1—TRI-TET OSCILLATOR CIRCUIT FOR SUPPRESSOR-GRID MODULATION, REPRODUCED FROM JUNE, 1934 *QST*

The r.f. amplifier circuit is identical so far as the screen, suppressor and plate are concerned. The following values are suggested for the components discussed in this article:

$C_5$ —0.002- $\mu$ f. 1000-volt mica fixed condensers.

$R_2$ —20,000-ohm 50-watt for one or two RK-20's.

$R_1$ —17,000-ohm 100-watt for one RK-20; 10,000-ohm 100-watt for two RK-20's.

swing, the screen current becomes maximum. Now if the screen voltage is maintained constant throughout the audio cycle (as it would be with screen supply of good voltage regulation), the modulation characteristic on the negative half cycle tends to tail off toward the zero line and make the "down" and "up" modulation unequal; that is, distortion

(Continued on page 51)

<sup>1</sup>J. J. Lamb, "Practical Transmitting Circuits for Suppressor-Type Screen-Grid Tubes," *QST*, June, 1934.



# The Old-Timer Learns About Modern Dress

By Eugene A. Hubbell,\* W9ERU

THE door of the shack was quietly opened, and a tall, bronzed visitor tiptoed quickly across the room and brought his hand down with a resounding slap on the back of the intently listening operator.

"What the— Why Ed, where in the world did you come from?" The slender youth sprang up, overturning his chair in his hurry, and began shaking hands, a wide grin matching that of the incomer. "Am I glad to see you! Why didn't you write? When did you get in? And—"

"Hold it, hold it, how do you expect me to answer when you don't QRX? I'm just back from the South American jungles. You knew I was to build a bridge down there? But let's talk about that later. I want to know what you've been doing while I've been gone." Ed threw off a heavy overcoat and looked about the room. "Well, for the love of— Would you look at the fellow, gone commercial! I thought you always built your own equipment."

Lee righted the overturned chair and sat down. "What do you mean, I've gone commercial? I built the equipment here and it's all strictly amateur."

"Don't make me laugh. I know what a commercial rack and panel job looks like, even if I haven't seen a QST for two years. You never built that transmitter." Ed waved his hand toward the rack in the corner, then walked over for a closer examination. "Crackle finish panel, chromium-plated hardware, black satin finished metal work all over where it isn't plated, the rack itself finished aluminum, and standoff insulators galore. Who did build it?"

Lee laughed. "Well, I suppose it does look strange to anyone out of touch with amateur radio for a year or so, but I built every bit of that outfit. I didn't plate the hardware, or finish the metal, but I cut and drilled and tapped it all, put on the parts and wired it, if that counts for anything."

Ed shook his head in amazement. "I know you used to build swell stuff, but I never thought I'd see anything like this in an amateur's shack. Why everything was still breadboard when I left two years ago to take that job down south. And now this looks like a section of a BC transmitter. Suppose you give me the lowdown on it. I'm going to build some equipment of my own."

"Why, it's simple. Put this down on the pad there on the desk, if you want to keep it straight for future use. You know, in a city of any size, a great many metal working industries gather. I suppose almost any place of twenty-five thousand

or over has a plant or two carrying a stock of steel beams. That rack is made of channel iron from a local company, the base angles were salvaged from a junk yard, and the top straps were purchased from a job shop making ornamental iron work."

"Oh, yes, I can see where you got that stuff. But how about the nice finish on it? That aluminum makes the black panels look just that much better, by contrast." Ed ran a finger up and down the back of the channel iron side of the rack. "And the finish doesn't seem to come off at all."

"Cheap aluminum paint from the variety store, that's all it is. Maybe it dries better than any you used to get. And, because it's on a rather rough surface, it looks OK. On a smooth panel brush marks show up in it, but on structural iron like that the finish is good. Let me get on with the story." Lee thought a minute and continued.

"If you just think over the metal articles in common use that have a baked enamel finish, you can think of dozens of places to get plain black done. Such things as vacuum cleaners, gas stoves, sewing machines, steel furniture, and all sorts of metal boxes, such as tool boxes, lunch boxes, those made for cupboard storage, and so on, usually have smooth baked finishes. And where that work is done, ham transmitting parts can be finished nicely.

"Crackle finishes are used on many products, health scales, hot-water heaters for automobiles, as well as on many radio products. So if you just think over the possibilities, you can see possible places to get the work done. As for the chromium plating, probably some manufacturer in town chromium plates levers, knobs or some other parts for his finished product. And nickel plating could be done at home, although the buffing might be hard. A few minutes spent thinking over the chromium plated things in the house may give you a lead."

"Do you mean to tell me you got all this done here in town?" Ed demanded with a frown. "I should think manufacturers would be difficult to approach on the subject of doing a special job like that."

Lee smiled. "It isn't hard to get them to see the light, especially if you have a friend working in the plant; and checking over the local amateurs, I found three different places to get crackle finishing done, five where plain black finishes could be put on, and two where chromium plating was done. So that gives a good idea of where this work was put through, doesn't it?"

"I get it. It would have been tough if no hams

\*227 No. 4th St., Rockford, Ill.

worked there, though, I'll bet." Ed began playing with the bug on the desk.

"No, you're wrong there. That bug you are fooling with has a base I had finished with four coats of black baked on, and it cost me only two bits to get it done. I just walked in and asked the information girl if I could get a little job done. She called up a fellow, I gave him the piece and told him what I wanted, and it was done without any fuss. That happened to be a place where they made automobile fenders. And I had all the screws on that panel plated for about thirty-five cents at a cabinet hardware manufacturer by just the same procedure."

Ed examined the base with interest. "Is the bug all home-made? It looks just like a manufactured one. Nice job, too."

"Yes, I cut out the pieces, drilled the base, and so forth. Then one of the local fellows put the springs in and polished it up some, and another amateur got it plated for me. Total cost was forty cents and one used 210! It's a perfect copy of the No. 6 Vibroplex, too."

"That a commercial-built receiver?" Ed demanded as he pointed to the large static-box on the desk.

"No, I built it, too, and got the panel done the same place where the transmitter panel was finished. It's an eight-tube job, and—"

\* \* \* \* \*

We'll leave Ed and Lee here and skip the technical details. Many amateurs hesitate to build transmitters, receivers, frequency meters, and other amateur equipment from any metal but aluminum, because of the difficulty of getting a nicely finished job. Aluminum is costly and

hard to work, scratches easily and is hard to obtain. Steel, however, works nicely, gives excellent shielding even at house-current frequencies, and is cheap and easily obtainable. The sheet material known as "automobile body metal" is the best variety the writer has found for panels, sub-panels and shielding.

After assembly of all parts, when all holes for wiring have been put in, it will be necessary to pull the equipment down and have the finishing done at some plant equipped to do a good job. Even the smallest towns usually have someone equipped to do auto refinishing, and the black lacquer they can put on presents an excellent appearance. If possible, however, a baked finish should be secured. Crackle finish paints are now on the market for home use, and although here again a baked finish should prove superior, a little experimenting with the home prepared variety may bring excellent results.

At least one local amateur secured an extremely attractive finish resembling bakelite by using a cheap black enamel, letting it dry well, and rubbing the surface with powdered pumice-stone and oil. Care should be taken to see that the metal is absolutely clean of oil and grease before painting, carbon tetrachloride (Carbena) being an excellent grease removing agent.

The combination of aluminum-finished rack, crackle-finished front panel with bakelite cased meters, chromium-plated switch plates and screw heads, aluminum scales with bakelite pointer handles for tuning, and black satin-finished sub-panel construction in the rear, produces a transmitter resembling the best of commercial construction.

## Navy Day—1934

By E. L. Battey,\* WIUE

**F**OR ten years radio amateurs of the United States have participated in the celebration of Navy Day (October 27th) by taking part in a receiving competition held each year on that date by the A.R.R.L. The competition consists of copying a message from the Secretary of the Navy. Secretary Swanson's 1934 message was transmitted from NAA (Arlington) at 9:00 p.m. E.S.T. and from NPG (San Francisco) at 7:05 p.m. P.S.T.

426 amateurs submitted 470 copies of the message; 47 operators copied both stations, 257 copied NAA only, 119 copied NPG only, making 304 copies of NAA and 166 copies of NPG.

A check of the tapes used at NAA and NPG indicates that the message was transmitted "error-free" from both stations. There were no

\* Assistant Communications Manager, A.R.R.L.

"catch" words; everything was in plain English and spelled correctly. Radio amateurs in forty states, the District of Columbia and Hawaii reported reception of the message. No copies were received from Alabama, Arizona, Louisiana, Maryland, Montana, North Carolina, Oregon and Rhode Island.

The twenty-five letters of commendation offered by the Secretary of the Navy to the operators having the best copies are distributed throughout the various Naval Districts in approximate proportion to the number of participants in each District. The Sixth and Fourteenth Districts each had but four participants. Such a low percentage of the total participants made it impossible to award any letters to these Districts. However, it is being suggested to the Navy Department that special awards be made to the

operators in these Districts who made the best copies: R. R. Brewin, W4GY, in the Sixth, and L. D. Paulson, Honolulu, in the Fourteenth.

The twenty-five high are listed first on the Honor Roll alphabetically and numerically by calls. All other contestants are listed by Naval Districts in order of their accomplishments as compared to other contestants in their district only. Special mention is deserved by the few operators who made perfect copy of both NAA and NPG: W6UY, W9CFL, W9FYX, W9IPM, W9TEL.

Of interest to Naval Reservists will be the fact that approximately 75% of all contestants are members of the U.S.N.R. Likewise, the total number of Reservists participating in each Naval District (as nearly accurate as is possible to ascertain from the reports submitted) will interest all N.C.R. members: In the First Naval District, 11; Third, 63; Fourth, 15; Fifth, 4; Sixth, 3; Seventh, 35; Eighth, 5; Ninth, 61; Eleventh, 29; Twelfth, 75; Thirteenth, 9; Fourteenth, 4. The Twelfth Naval District, with 75 Reservists submitting copies, rates highest and leads this factor of the annual National U.S.N.R. Competition. All contestants in the Seventh and Fourteenth Districts were Reservists!

The total number of operators participating in each Naval District (including both Reservists and non-Reservists): First, 27; Third, 78; Fourth, 23; Fifth, 8; Sixth, 4; Seventh, 35; Eighth, 12; Ninth, 90; Eleventh, 36; Twelfth, 85; Thirteenth, 19; Fourteenth, 4. The Ninth had the greatest "total participation."

A few notes of interest: W9TEL used "split-phones" for copying NPG, one ear tuned to 4385, the other to 8770. . . . Twenty-one of the twenty-five "winners" are N.C.R. members! W2BJX, W3ADE, W5BMI and W7LD are the non-N.C.R. victors. . . . W2BPJ, W3BPJ and W8BPJ each copied the message . . . ditto W1GWO-W2GWO; W1NK-W6NK; W1DJQ-W6DJQ; W4AOZ-W6AOZ; W5AAX-W6AAX!! Those particular letter combinations must be attracted by Navy doings. . . . W4CA/W8UC, operating portable at Pecos, New Mexico, celebrated his fifteenth year on the air by copying the Navy Day message. . . . W3EQP's receiver tuned only to the edge on 4205 kcs., so he put a few pennies in the detector coil . . . he says it's a handy way to shift the tuning range slightly "in a pinch" and, furthermore, it proves that fuses aren't the only things pennies are good for. . . . It would have been better for some contestants to have sent their "original" copies for checking . . . somehow errors creep in when we "re-copy"! . . . F. A. T. Bearse, radio operator on the *Harboe Jensen*, Unifruit ship, copied the message from NAA while abeam Castle Island, Windward Passage. . . . No copies of NPG were made in the First, Third or Sixth Naval District. . . . No copies of NAA from the

Thirteenth or Fourteenth District. . . . The speed of transmission was approximately 15 w.p.m. . . .

### 1934 Navy Day Message

#### To All Radio Operators of the United States and Insular Possessions:

It has been the privilege of the Secretary of the Navy for many years on Navy Day to extend the good wishes of the Navy to all radio operators of our country. A receiving competition has been conducted each year in which amateur and commercial operators have taken part. Likewise our Naval Communication Reserve officers and men have contributed their share to the success of Navy Day by assisting local celebrations and also participating in this receiving competition. Our Naval Communication Reserve continues to increase in numbers, in efficiency and value to the Naval Service in case of future necessity. I urge again all qualified young men to consider the advantages of becoming members of this organization whose training activities are entirely voluntary.

C. A. SWANSON, Secretary of the Navy

(This message transmitted from NPG; the message from NAA was a paraphrase of NPG's text. The above is not for checking purposes.)

## 1934 Navy Day Honor Roll

### The Twenty-Five High

- W1APP, Howard J. Gourley, Springfield, Massachusetts  
 W1DMD, Carl B. Evans, Concord, New Hampshire  
 W2AA, Harold Bunker, Merrick, New York  
 W2BJX, Donald P. Love, Poughkeepsie, New York  
 W3ADE, Lewis E. Elicker, Jr., Penbrook, Pennsylvania  
 W3EWP, L. M. Rundlett, Norfolk, Virginia  
 W4AVU, George H. Schlegel, St. Petersburg, Florida  
 W4BLS, Joseph B. Kuehl, Jacksonville, Florida  
 W5BMI, E. F. Henning, Little Rock, Arkansas  
 W6ALO, Tom Jentges, Santa Ana, California  
 W6BJM, Ludlum Smith, San Anselmo, California  
 W6KE, Irvin E. Dickinson, Bakersfield, California  
 W6UY, M. J. Campbell, Orange, California  
 W7LD, Niilo Koski, Seattle, Washington  
 W8ABX, John J. Long, Jr., Brighton, New York  
 W8DZU, Robert W. Percy, Rochester, New York  
 W8KRT, L. T. Bourland, Pittsburgh, Pennsylvania  
 W9BEZ, William Obrist, Wichita, Kansas  
 W9CFL, A. W. Hodge, Kansas City, Missouri  
 W9FYG, Bernard M. McAtee, Jr., Denver, Colorado  
 W9FYX, Clifford E. Lien, Sioux City, Iowa

W9GSF, Verne B. Morrison, Kansas City, Missouri  
 W9IPM, R. W. Caldwell, Kansas City, Kansas  
 W9LZA, Robert S. Ayres, Durango, Colorado  
 W9TEL, John R. Kennedy, Pueblo, Colorado

The remaining 401 participants on the Honor Roll follow. They are classified by Naval Districts and are listed under their respective districts in the order of rating. Where calls or names are connected by dashes, it indicates that these participants have equal ratings and are listed in a group, alphabetically:

*First Naval District:* W1BB-W1BZO W1ABG-W1ATF-W1CHF-W1DGN-W1DJQ-W1EPC W1BPN-W1BYF-W1FBZ W1AYG-Earl V. Cahoon W1HYR W1DUK-W1KH W1NK W1MT-J. E. Vermeiren W1HKY W1EVA-W1GAE Francis A. T. Bearse W1EVW W1ACH. *Third Naval District:* W2ATM-W2BZJ-W8PK-Hedley B. Morris W2CJX W2ALL-W2BJK-W2CBN-W2DQH-W2GWO-W8EWP W2ALL-W2AOV-W2BFA-W2DLI-W2EGE-W2ENV-W2FFL-W2FWC-W2US-W8BSL-W8GHZ-W8KMC-J. W. Ashmore-Wilbrod J. LePine W2DXW-W8KEK W1ASP-W2BLL-W2BYL-W2EWG-W3SW-W8BPJ-W8CUU-W8FYF-W2BPJ-W2DPF-W2FIP-W2TX-W3ZI-W8EOE W2EKM W2ADW-W2BWZ-W2GXW-W8DHU-W. W. Voorhees W2FLD-W2LC-W8EMW W2DNE W2FKL W1BDI-W1GWO-W8AIE-W8DME W2AUP W1FNM-W8JK W1GME-W2BPV W2CHZ W1DMK-W2FAR W1DWB W8IQ W2HEB W2HEG W2FDD W1FOB W2BAI W2FPK W2CJI W8JGN. *Fourth Naval District:* W3AKB W8ASE W3CL-W8KRG-Wm. T. Betts, Jr. W3BAK-W3FY-W8GDS W3BPJ-W81OI-W8KD W3EJN W8DY W3WT-W8IUW W8CTT-James H. Daddysman, Jr. W8FDA W8JIA W8GUF Guy S. Craig George R. Boardman W8KER W3COY W8EJG W8RQ. *Fifth Naval District:* W3EEN-W3HN W3CMV W3DML W3RT W3EQP W8HD. *Sixth Naval District:* W4GY W4AAR W4CFD W4CIR. *Seventh Naval District:* W4AS W4BSP-W4CSH-Joseph E. Johnson W4CIF W4AHZ-W4AOZ-W4CBK-W4HC-W4HZ-D. S. Griffin-Wayne Mason W4AOV-W4AWY-W8BCJ-W4BFR-W4NKF-Draper Bartlett, Jr. W4BEQ-W4OZ

K. C. Burt John D. Rankin W4CCC W4JO Arnold C. Ewert W4QG W4BPS W4BUM W4OY L. W. Ahrens Earl W. Tonjes O. E. Woodward Geo. D. Barton. *Eighth Naval District:* W5IQ W5BII-W5CEZ-W5TR W4RO W5DWN W5BRQ W5ASQ-W5JA W5AUL W5BAM. *Ninth Naval District:* Emmett J. Jacobson-W. V. O'Neal W8ATG-W8CGP-W8EGX-W8WB-W9GWF-W9LEO-W. J. Wagner W9FFD W8BKM W9ANV W9CGP W9JDN W9FNQ W8EJ-W8HSW-W9BQM-W9DJA-W9GMQ-W9HHD-W9NR-Richard Brewer W8HS W9FX W9JAF W9BP W9DXI W8AXV-W8PH-W8SS-W9BXT-W9DEA-W9ELL-W9IV-W9LLD-R. C. Berry W9AHH W8BAH-W8CPY-W8HDJ-W8JTK-W8NC-W9AKT-W9DNU-Robert H. Clarke W9CKV W9DEB Loren V. Burns W9DGS W9DNY W8IFQ-W9AQL-W9HF-W9KSF-W9LGR-W9PLJ-W9STE W9DBO-W9LNI W8BON-W8LL-W9CGS-F. D. Schunck W8AYO W8ARR-W9LQW Willis Hudgins (W9BNT) W8IDW-W9AQX W8LZE W9GWT W8IKZ W9EO W8MHM W9KPF W9CFP W8CQ W9MCD W9PFI W9HVJ W8BRN W9NUN W9HUV W9OMW. *Eleventh Naval District:* W8BMC-W8BYZ W5AAX W8EC W4CA/W8UC/5 W6CLY W6ALR W6DTY-W6DQN-W6ESK-W6FM-W6HD-W6HOS-W6QA W6IZ-W6KHI-W6TW-R. E. Hall W6EYL W6CMT W8KRO W6VO W6BNO-W6DSN W6LDX-Albert Furrer W6LGI W6AE W6IAH W6VBD Don Lee McCune R. B. Walling W6BQP W6FGT. *Twelfth Naval District:* W6AHK-W6ATT-W6CP-W6FFP-W6INZ-W6NK-W6WU-W6ZJ-Graham Allen W6GQC-W6FYR W6ADB W6DGR-W9RTQ-Arthur Clare Adams-Clyde Barnhard W6AK-W6BI-Frederick F. Devia W6BAE W6AV-W6CTX-W6DJQ-W6LBL-Virgil U. Buck-Charles E. Sibley W6AHJ-W6BER-W6BMK-W6NZ W6AOZ-W6CXM-Wilfred Munter W6DEC-W6JDY-W6NV-W6VS W9DBM W6AFN W6CUZ-W6DRU-W6JZ-W6NN-W9MOC-W9PIH W6EDL W6CUL-John A. Rugar, Jr. Leo. J. Ohman W6FJY W6FPW W6FRN W6LZR W6JNI W6ENA W6FLP Robert F. Herbig W6IDB Ted R. Souza W8AAX W9NLD E6GUK-W6LLG-Oren T. Holmes W6IBU-George Herr W6ZAG W6ANR W6BVY Leland Tull W6SM W6DWE W6EJE W6AMI D. L. Burk-John H. Wright Henry Walters W6FBQ W6KEZ-Chas. J. Piccone. *Thirteenth Naval District:* W7BHH-W7BZ-W7NO W7CZY-W7WY W7AZI-W7AZY-Hans Koski (W7LD) W7BBZ W7AMG W7AND W7TK W7COH W7AVP-W7HB W7CNC W7EW W7BIR. *Fourteenth Naval District:* L. D. Paulson James G. Alverson-G. W. Clark-R. C. Sergeant.

## "One-Spot" Net Operation

By C. S. Hoffman, Jr.\*

MUCH has been said as to speeding up, and facilitating the handling of traffic. Some things are being done in West Virginia, which may be of interest to that group of amateurs whose special interest is this branch of operating. Most of the ideas to be related have been in operation for at least their second year, and therefore are entirely practical.

The most reliable stations interested in traffic handling form the "West Virginia AARS Net," which not only functions on the regular A.A.R.S. Net schedules each Monday, but every evening at 6:30 p.m. (E.S.T.) the time best found to avoid skip. Through the generosity of W8OK, State

\*SCM West Virginia, W8ED-WLHF, W8NS 100-20th Street, Warwood, Wheeling, West Virginia.

NCS, crystals have been ground and provided free, and each station has lent his ideas for the betterment of the net, as operating conditions warranted a change.

The net prides itself with being the first "one-spot" crystal-controlled net in ham radio; three years have passed since it's going on 3700 kcs. as a unit. The roll is called every night (alphabetically by calls) by the Net Control Station. Each station answers, stating the traffic he has, and its direction. The calls have been cut to a minimum by using Army abbreviations.

When the roll call is completed, the control station has made note of which stations have traffic, and the destination of such traffic. The stations that have reported "no traffic" are ex-

cused by the appropriate signal and drop out of the net. Traffic is then routed; the control station directing a particular station to clear with a second station, for which it has messages. All stations working on the same frequency facilitates fast operation and complete understanding by every participating operator.

In much the same way, traffic is relayed when skip shuts out one station. In our mountainous state, even the distance between WSHWT and W8HD, in the same city, sometimes makes reception of a particular station impossible. In such circumstances W8HD simply asks the fading station to relay its traffic to WSHWT. WSHWT copies same, and relays it to W8HD, saving perhaps a day or two, and much exerted effort in copying repeats through QRM-QSC. This is not only the case with stations in the same city, but when different sections of the state are blocked off by a certain more general "skip" characteristic. Our distribution geographically is wide enough so that a station in the area not being blocked out, can practically always relay.

The "one-spot" idea also comes in handy when a special message having the same text is addressed to a half-dozen cities within the state, as for example, the current Red Cross Roll Call messages. The stations receiving these (usually W8EIK or W8HD) announce on roll call the number of messages and their destinations. The message is sent "as a book," with the text first, and the list of addresses and message numbers. Each station copies, and accepts the proper one for his city. Each OK's or asks for repeats in turn.

What is done if the control station does not show up on a certain evening? Easy! W8ELJ and W8KKG are acting NCS and Alternate NCS respectively (both also are A.R.R.L. RMs). If they both do not show up then, the next following station on the official A.A.R.S. roll for W. Va. takes the Net, until the place is filled.

As to an outlet for traffic outside of W. Va., several of our stations contact the larger cities. The bulk of traffic is handled via W8HD-WLHF and W8EIK-WLHG via the Army net. Outlets are open to the Canal Zone, Hawaii, P. I., China, and as well as every state in the U. S., with marvelous speed.

Beginning this fall season, a movement by W8OK was begun to get as many as possible of the stations to use break-in transmission and reception, thus even speeding up to a greater extent the relaying of traffic. So far this is accomplished at six of the stations, *by keying in the crystal stage!*<sup>1</sup>

Only a few days ago, W8ELJ made the newest suggestion of how to take care of traffic within the state from non Net members. After roll is called each evening, the control station calls "CQWVA." All the net stations listen-in over

<sup>1</sup>See "Another Simple Solution of Break-In" by W6BJM, page 16, September 1934 QST.

the entire band, and especially in the vicinity of 3700 kcs. The beauty of a "one-spot" net again comes to the foreground, as any member can answer a calling station who might be inaudible (due to skip) to any of the others! If any station picks up a call (and this happens frequently) the rest of the net stands by. If two stations pick up stations calling, the control station directs one of the stations to clear traffic first, since every one listens on 3700 kcs. after contacting the non-member station, and before accepting traffic.

The West Virginia A.A.R.S. Net has in all evidence caused wide-spread attention and enthusiasm for "one-spot" operation efficiently done, if inquiries that have been received are a means of signification. Both the A.A.R.S. and U.S.N.R. are organized for "one-spot" operation. "One-spot" nets are already in operation in Western Pennsylvania, Ohio, Michigan and several western states. It is the purpose of this article to present the principles underlying the W. Va. Net to those who have listened in on the Net in the past, with the hope that the suggestions may benefit the amateurs interested in speeding up round-table QSO's and moving traffic.

It is the highest form of pleasure to work a net of this kind. The fellows all have become personally acquainted, and are glad to withhold "chatter" until hooks are clear. The bunch has had hamfests and meetings, bringing their wives, and foregoing other pleasures rather than miss the regular evening schedules at 6:30 p.m. The individuals making up this net have received numerous compliments. Good fists predominate, and transmissions are from 18 to 35 w.p.m.

Besides coöperating with the A.R.R.L., and stimulating the highest type of operating, this net is doing the government a service by establishing a more perfect system of lines for emergency communication. The experience obtained enhances one's ability to handle such trunks in both local or a national emergency, when the government will look to us for an immediate helping hand. The majority of our net stations are ORS, the two NCS' are A.R.R.L. RMs, and one of the Army Alternate State Control Stations, providing an out-of-state outlet is SCM.

Members of the net taking part each evening at this time are: W8BDD, W8EIK/WLHG, W8ELJ, W8EZR, W8HD/WLHF, W8HWT, W8KDP, W8KKG, W8LJX. Stations participating on Mondays and frequently during the week are: W8AFB, W8CMJ, W8DMF, W8FVU, W8HUK, W8IKN, W8MAO, W8OK/WLHB.

## Strays

A neat and inexpensive call sign can be made by using the wooden letters and numerals available at nominal prices from many five-and-ten-cent stores. Two sizes usually are available.

—W9AAH

# What the League Is Doing

League Activities, Washington Notes, Board Actions—For Your Information

## What the League Is Doing

**Election Results** As the result of a special election held in the Southeastern Division, Mr. Bennett R. Adams, Jr., W4APU of Homewood, Alabama, has been chosen director for the unexpired remainder of the term of former director J. C. Hagler, Jr., resigned. The count was as follows:

Bennett R. Adams, Jr. ....	130
Orville Cheatham .....	105
R. R. Brewin .....	44

Director Adams, a graduate of Georgia Tech, is by vocation a transmission engineer in the toll test department of A. T. & T. He is president of the Birmingham Amateur Radio Club and holds A.R.R.L. appointments as O.R.S., O.B.S. and Route Manager. He is a member of the Army-Amateur Radio System and a first lieutenant in the Signal Reserve. The uncompleted term for which he was elected expires the end of this year; that is to say, there will be a regular election in the Southeastern Division this autumn.

Members will be interested in an analysis the headquarters made of the basis upon which Southeastern Division members had the right to vote in this election: Possession of station license, 247; possession of operator license only, 2; membership in League prior to May 15th last, 30. Licensed amateurs, 89.3%; relying upon prior membership, 10.7%.

**'Phone Harmonics** Popular interest in short-wave broadcast reception is resulting in a new brand of interference reports against amateurs. The present crop consists of complaints against amateur 'phones operating between 3900 and 3967 kc. which have third harmonics creating interference between 11,700 and 11,900 kc. The latter is part of the most popular short-wave broadcast band, the so-called 25-meter band. The BCL's of course easily identify the voice transmissions. In some cases strong harmonics have been reported at a distance of many miles. For the most part these seem to be justifiable complaints, for no station is entitled to radiate bothersome harmonics and emissions are required by regulations to be as free therefrom as practicably possible. 'Phone operators in this band would be well advised to check their outputs and make sure they are not radiating harmonics.

**A.A.R.S.** A couple of letters received at headquarters recently speak of the Army-Amateur Radio System as a sort of military institution. This is incorrect; the Naval Reserve of course is, but not the A.A.R.S. The latter is confined strictly to peacetime emergency communication. The Army has another constitutional duty in addition to its military end: it is expected to aid the people whenever an emergency arises with which the civil authority is unable to cope. The Army-Amateur System was created to aid the Army in that second duty and not in the first. As is well known, many amateurs are enlisted in the Naval Reserve in an arrangement where they will have to serve with the Navy in wartime, yet are members of the Army-Amateur System, standing by to aid the Army in peacetime emergencies that have nothing to do with warfare.

**Licenses** Don't waste time bombarding the F.C.C. for a special call. Such requests are regularly denied.

Don't get excited about losing your call because you did not apply for renewal in time. The Commission holds such calls unassigned for some months and gives the same letters to the applicant when he obtains a new license. In fact their policy is such as completely to defeat the amateur who deliberately permits his license to expire because he does not like his call, hoping to get one he will like better if he applies after a few months; he does not—he gets the old one back.

The proof of use necessary to renew a station license (Rule 402) may be established any time within ninety days of applying for renewal, yet the station of course may be operated right up to the day its license expires. As a result, applications for renewal, showing "proof of use," may be filed up to ninety days after the expiration of the license and still be considered as for renewal, not for a new license. The only penalty for not filing sixty days before expiration is the probability that the renewal will not be received by the expiration date and the amateur must go off the air until the new license arrives.

Let us repeat an important statement: Only the new-style "card" licenses cover simultaneous operator and station authorizations. The old-form licenses are separate for station and operator and expire separately. A number of amateurs have made the mistake, despite all that has been

(Continued on page 108)

# A New High-Efficiency High-Gain Audio Power Amplifier

A 203-A Class-B Modulator With 6B5 Driver

By O. H. Brewster,\* WIBMT and Lew Bellem,\*\* WIBES

**A**LTHOUGH an avalanche of new tube types has been released for commercial broadcast receiver service during the past few years, no audio type (with the possible exception of the 2B6) has offered low cost, high efficiency and low distortion in basic amateur service. In the 6B5 these features are realized to a considerable extent. This, combined with its novel design and excellent characteristics, makes it of interest to the amateur fraternity.

## FUNDAMENTALS OF THE NEW TUBE

The basic principles of the 6B5 are indeed simple, but a description of the applications of the tube to an amplifier would be a bit confusing without a brief discussion of the working of the tube itself.

Class-A amplifier tubes in general are very inefficient because of the relatively high plate input necessary to obtain large plate current swings which necessarily must be restricted to the negative region of the  $E_p-I_p$  curves. Pentodes have the advantage of higher efficiency than triodes but are inherently weak sisters when harmonic distortion is considered. The Triadyne (6B5) incorporates the advantages of Class-A and Class-B since it is a tube in which the output section operates with a positive-biased output grid, the cathode of the driver being tied within

Fig. 1 and a voltage  $E_g$  is applied between grid and cathode. The voltage developed across the cathode resistor is shown by the non-linear curve  $CD$ . But if the voltage is applied between grid and ground, then the voltage across the cathode resistor varies as shown by curve  $AB$ . It will be noted that a considerable portion of the non-linearity has disappeared. This increase in linearity is due to the degenerative action brought about by the fact that the developed voltage

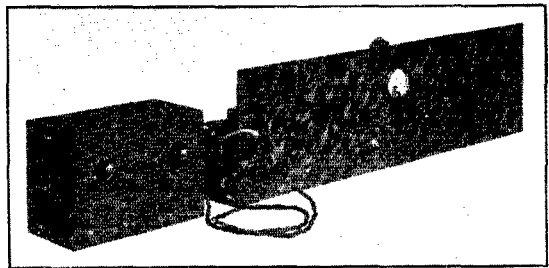

PANEL VIEW OF THE DRIVER-MODULATOR UNIT (RIGHT) AND TWO-STAGE PRE-AMPLIFIER (LEFT)

The overall gain is more than sufficient for full 203-A modulator output with crystal-microphone input.

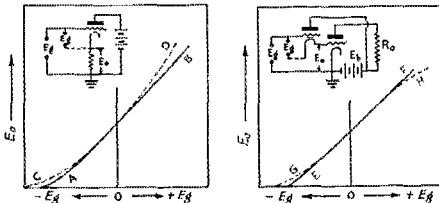

FIG. 1.—CATHODE VOLTAGE VS. GRID VOLTAGE CHARACTERISTICS OF A TRIODE

FIG. 2.—CHARACTERISTICS WITH THE INPUT OF A POWER TUBE SUBSTITUTED FOR THE CATHODE RESISTOR

the tube to the output grid. A brief explanation of what happens in this case is as follows:

Suppose a triode driver tube is set up as in

across the resistor appears as part of the input circuit voltage and both voltages are in phase with respect to ground.

If a grid-cathode load such as a power tube with a positive grid bias is substituted for the resistor as shown in Fig. 2, and if  $E_g$  is applied as before between input grid and input cathode, then as before the voltage appearing on the output grid is non-linear as shown by curve  $GH$ . If, however, the voltage is applied between the input grid and ground, a practically linear relation, as shown by curve  $EF$ , exists between input voltage and the voltage on the grid of the output tube; hence we have a perfect driver. Since a linear relation exists between input voltage and output grid voltage, and the output plate current is linear with respect to output grid voltage, it follows that the output plate current will be linear with respect to input grid voltage, within the limits of the tube's rating. Such is the 6B5, whose ratings are as follows:

### TRIADYNE AMPLIFIER RATINGS

Filament voltage, $E_f$ .....	6.3 volts
Filament current, $I_f$ .....	0.8 amp.

\* Triad Mfg. Co., Pawtucket, R. I.

\*\* Coto Coil Co., Providence, R. I.

Bulb, ST-14 .....  
 Base, 6-prong medium.....

**NOMINAL RATING**

Grid bias,  $E_g$  ..... 0 volts  
 Plate voltage,  $E_b$  ..... 300 volts  
 First plate current,  $I_{p1}$  ..... 5.5 ma.  
 Second plate current,  $I_{p2}$  ..... 45 ma.  
 Load resistance,  $Z_o$ , Single ..... 7000 ohms  
 Push-pull ..... 10,000 ohms  
 (plate-to-plate)  
 Signal ..... 15 volts, r.m.s.  
 Power Output,\* Single ..... 4 watts  
 Push-pull ..... 10 watts

**HI-E RATING, PUSH-PULL**

Grid bias,  $E_g$  ..... 13 volts  
 Plate voltage,  $E_b$  ..... 400 volts  
 First plate current,  $I_{p1}$  ..... 4 ma. per plate  
 Second plate current,  $I_{p2}$  ..... 45 ma. per plate  
 Load resistance,  $Z_o$  ..... 10,000 ohms  
 (plate-to-plate)  
 Signal ..... 60 volts, r.m.s.  
 (grid-to-grid)  
 Output\* ..... 20 watts

**PRACTICAL APPLICATIONS**

The principles involved in the design of the Triadyne can be applied to solution of many problems involving the power driving of the larger output tubes with minimum power consumption at low distortion.

However, to get back to the more specific business at hand of putting the 6B5 to work in amateur equipment, we find upon examining Fig. 3 that a pair of 6B5's in the Hi-E (high-efficiency) circuit with 400-volt plate supply will give a power output of about 20 watts at 5%

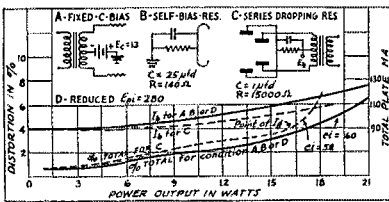

**FIG. 3—HIGH-EFFICIENCY PUSH-PULL CONNECTIONS AND OPERATING CHARACTERISTICS FOR 6B5'S**

Plate supply voltage,  $E_b$ , 400 volts; no-signal current per tube, first plate,  $I_{p1}$ , 4 ma.; second plate,  $I_{p2}$ , 40 ma. Load resistance, 10,000 ohms, plate-to-plate.

distortion—a nice little low cost modulator for a 210 Class-C r.f. amplifier. Four tubes in push-pull similarly would serve as modulators for a pair of 210's Class-C, with Class-A modulator quality.

The Hi-E circuit mentioned above simply consists of the use of 400-volt plate supply as contrasted with the nominal rating of 300 volts. When a 400-volt supply is used, the driver plate current must be reduced proportionally by any one of the methods shown in A, B and C of Fig. 3. That is, by a fixed bias between the grid return

\* 5% harmonic distortion.

and ground or by a 140-ohm automatic bias resistor by-passed by 25- $\mu\text{fd}$ . low-voltage condenser, or by a current-limiting resistor of 15,000 ohms in the plate feed circuit. An examination of the load output characteristic (Fig. 4), led to the use of a pair of 6B5's in Hi-E as drivers for a pair of 203-A's in Class-B. The features of the 6B5 which warrant its use in such a power driver are as follows:

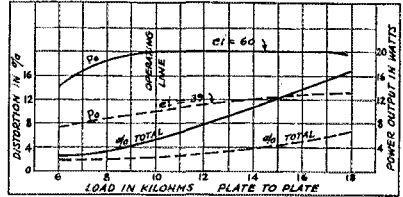

**FIG. 4—LOAD CHARACTERISTICS FOR HIGH-EFFICIENCY CIRCUITS OF FIG. 3, PLATE VOLTAGE AND CURRENT VALUES BEING AS GIVEN FOR THAT FIGURE**

1. Flat power output vs. load characteristic, which is important when driving a variable load such as 203-A's Class-B.
2. Low distortion rise with load resistance increase.
3. Comparatively high power-sensitivity.
4. Effectively automatic negative-bias input, which can work direct out of a voltage amplifier tube.

**AMPLIFIER DESIGN**

The driver-modulator shown in the accompanying photographs and diagrammed in Fig. 5 is constructed on a base board 10 by 32 inches with controls and a meter for reading both driver and Class-B plate current, mounted on a crystal finished Masonite panel 10 by 32 by  $\frac{1}{4}$  inches. A 400-volt power supply is built on the same base board with the amplifier, the component parts being arranged to give minimum hum pick-up. The input transformer is mounted directly in back of the input terminals, and feeds directly to the 6B5 grids. A conventional power supply is used with no particularly drastic filtering necessary, because the 6B5 plates are fed push-pull and also because the plate current of the 6B5's in the Hi-E connection "talks up" only about 25 ma. at full output. All voltages for the power supply, as well as the filament voltage for the 6B5's and the 6.3 volts for the pre-amplifier stages, are obtained from a single transformer.

The coupling transformer from the output of the driver to the grids of the 203-A's is a rather husky affair designed to reflect back the proper load from the grids of the 203-A's to the plates of the Triadynes. The output transformer can be any standard transformer designed to reflect the proper Class-C load to the plates of the 203-A's.



A rather neat feature of the entire modulator unit is the simple pre-amplifier which can be used. As mentioned before, Triadynes have the characteristics of a Class-A tube, insofar as the input is concerned; that is, no power need be supplied to the grid. For this reason, a 6C6 pentode feeding a second 6C6 connected as a triode supplies more than sufficient voltage gain to operate out of a crystal microphone. For instance, with a model D-104 Astatic microphone the gain control is run about  $\frac{2}{3}$  open for full output.

The pre-amplifier is mounted in a standard shield cabinet with gain and tone controls on the front panel. A pilot light, connected across the 6.3-volt supply for the filaments, indicates when the modulator unit is on. The filament and plate supplies are brought to the pre-amplifier by a four-wire cable from the modulator unit, minimizing magnetic pick-up within the pre-amplifier.

For the further reduction of hum a small choke,  $L_3$ , is located on the modulator unit in the positive lead to the pre-amplifier and an 8- $\mu$ d. electrolytic is across the supply within the pre-amplifier. Also, a 50,000-ohm filter resistor with a 0.5  $\mu$ d. condenser is used in the plate lead of the high-gain 6C6. In the complete job, from the microphone stage to the output tubes, there is no detectable hum.

At W1BMT this unit is used to modulate 100% a single 242-A run as a Class-C amplifier with about 250 mils at 1000 volts on the plate. Both the modulator and the Class-C amplifier are supplied from the same power supply. This is a rather conservative use, as the latest output ratings of 203-A tubes in Class-B with

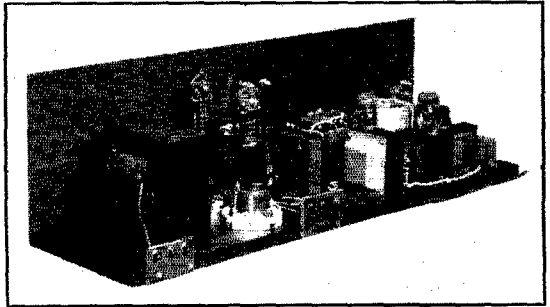

THE WORKS BEHIND THE PANEL OF THE DRIVER-MODULATOR UNIT

The Triad 6B5 driver tubes are at the extreme right, the rectifier of the 400-volt driver and pre-amplifier supply towards the center, and the 203-A Class-B stage at the left. Although the equipment appears crowded, hum and feed-back troubles are prevented by careful arrangement.

1000-volt supply is 200 watts audio, or 260 watts with a 1250-volt supply. This amount of power

(Continued on page 84)

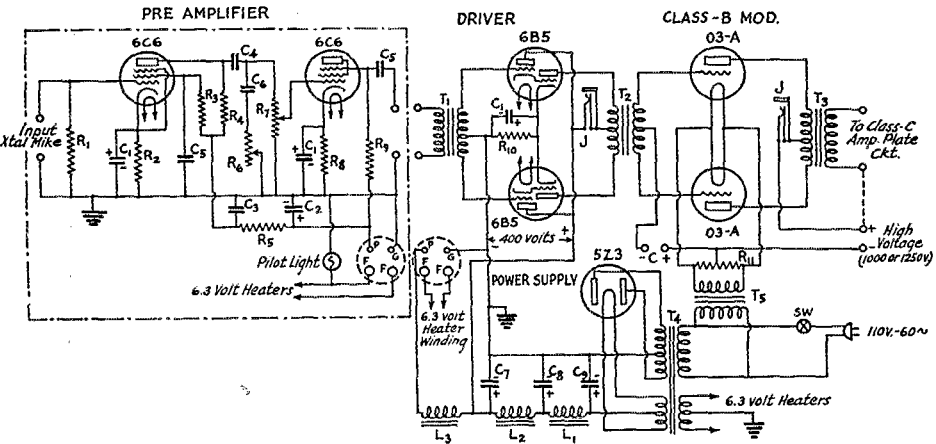

FIG. 5—COMPLETE CIRCUIT OF THE DRIVER-MODULATOR AND PRE-AMPLIFIER UNITS

- R<sub>1</sub>—4 megohms.
- R<sub>2</sub>—1000 ohms.
- R<sub>3</sub>—2 megohms.
- R<sub>4</sub>—500,000 ohms.
- R<sub>5</sub>—50,000 ohms.
- R<sub>6</sub>—500,000-ohm tone control.
- R<sub>7</sub>—500,000-ohm volume control.
- R<sub>8</sub>—1000 ohms.
- R<sub>9</sub>—100,000 ohms.
- R<sub>10</sub>—140 ohms.
- R<sub>11</sub>—60-ohm center-tapped.
- C<sub>1</sub>—20- $\mu$ d. low-voltage electrolytic.
- C<sub>2</sub>—8- $\mu$ d. electrolytic.
- C<sub>3</sub>—0.5  $\mu$ d.

- C<sub>4</sub>—0.02  $\mu$ d.
- C<sub>5</sub>—0.1  $\mu$ d.
- C<sub>6</sub>—0.005  $\mu$ d.
- C<sub>7</sub>, C<sub>8</sub>, C<sub>9</sub>—Three-section electrolytic.
- L<sub>1</sub>, L<sub>2</sub>—100-ma. filter chokes.
- L<sub>3</sub>—20 ma. filter choke.
- T<sub>1</sub>—Any good audio step-up transformer, about 3-1 turns ratio.
- T<sub>2</sub>—Coto C I 402 Triadyne output transformer.
- T<sub>3</sub>—Coto C I 403 Class-B output transformer.
- T<sub>4</sub>—Power transformer.
- T<sub>5</sub>—203-A filament transformer.
- J—Plate meter jacks.

# A Space-Saving Adjustable Antenna

By R. N. Eubank, W3AAJ\*

**T**HE problem of getting a 132-foot antenna of the familiar horizontal Zepp type in a lot which couldn't be stretched beyond a mere hundred feet probably has bothered many amateurs besides this writer. After having faced it in several different locations, some thought was given to ways and means of putting up a radiator which would be at least equally effective as the Zepp but still would require only inconsiderable ground space. The result was the decision to give the quarter-wave vertical-type antenna a trial, since this type readily can be mounted on a pole 50 or 60 feet high. Further planning also led to the installation of a quick means of varying the antenna length—from the ground—to permit adjustment of its natural period for most effective operation in various parts of the band.

In actual work the new antenna has proved itself to be not only as good but actually a better radiator than the horizontal Zepp. This is not surprising since it is pretty generally conceded that the radiation from a vertical antenna takes place at angles more favorable to long distance propagation than that from a horizontal wire.<sup>1</sup> It has worked out so well, in fact, that a number of other amateurs have changed over to the new arrangement. The demand for practical dope from fellows interested in the antenna has prompted the writing of this description.

The essential mechanical features of the antenna at W3AAJ are shown in Figs. 1 and 2. The main part of the antenna consists of a No. 12 or No. 14 wire mounted on 5-inch stand-off insulators suitably spaced along the pole. At the top is a length of half-inch brass pipe arranged to slide in the end holes in stand-offs mounted as shown in Fig. 2. These two insulators are spaced on the pole at a distance equal to half the length of the pipe. A shorter stand-off is fastened to the pipe near its center, the length-adjusting rope being tied through the eye in this insulator. The rope passes through a pulley suspended from the uppermost insulator on the pole; both ends of the rope extend down to the ground so the pipe can be hauled up or down to change the antenna length. A spring contact fastened to the lower insulator in Fig. 2, connected to the antenna wire, provides contact with the sliding rod. Adjusting the antenna length to the proper value becomes simply a matter of a few minutes work from the ground.

The antenna-wire length and rod length needed

\* Transmitter Chief, WRVA, Richmond, Va.

<sup>1</sup> Goodell, "Getting Cooperation into the Antenna System," February, 1935, QST.—Editor.

will of course depend upon the band for which the antenna is built. An antenna designed for quarter-wave operation in the 3500- to 4000-ke. band should have an antenna wire 52 feet long and a rod or pipe 15 feet long. These dimensions will permit adjusting the length to be resonant over the whole band. The pole height required is about

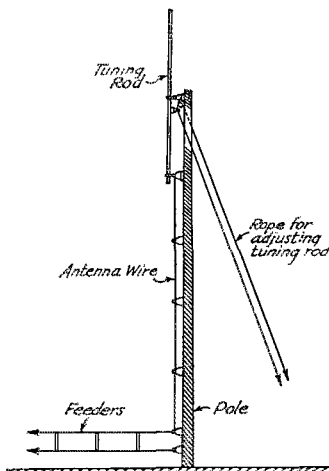

THE "SLIDING ROD" VERTICAL ANTENNA AT W3AAJ

The length of the radiator readily can be adjusted for operating in different portions of a band. In practice this type of antenna has proved to be more effective than the usual horizontal half-wave antenna even when only a quarter wave in length. It requires very little ground space.

60 feet, although a somewhat shorter pole may be used and the antenna wire run off at an angle from the upper part of the pole if necessary. This same antenna can be used as a half-wave radiator on 7 mc. and a full-wave radiator on 14 mc., being readily adjustable as to length on these bands also.

For operation on 7 mc. and higher frequencies only a 30-foot pole is needed. In this case the wire length is 26 feet and the rod length 10 feet, the antenna acting as a quarter-wave radiator on 7 mc. and a half-wave radiator on 14 mc. The quarter-wave system may even be used on 14 mc., with a 13-foot wire and 5-foot rod on a 15-foot pole, although in most locations it would be more desirable to use the half-wave system if the pole is mounted on the ground. The 15-foot pole could be mounted on the roof just as readily, however.

In practice it may be found that the wire lengths needed will vary somewhat, since the

presence of nearby wiring and other objects acts to change the natural period of the antenna. Although lengthening rarely will be found necessary, it may develop that the antenna length is too great, in which case it is an easy matter to clip off a bit at a time at the lower end until the system tunes properly.

#### MECHANICAL POINTERS

Half-inch brass pipe has been found to be most suitable for the sliding portion of the antenna, especially in the longer lengths, since it possesses sufficient strength to keep its shape in a high wind. It can also be purchased in 15- or 20-foot lengths, which is not the case in the smaller sizes. For the shorter rods, quarter-inch solid brass rod

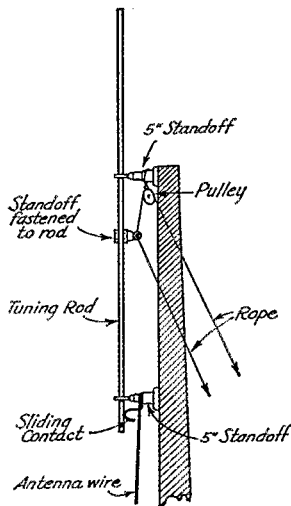

#### DETAILS OF THE SLIDING ROD

The rod can be pulled up or down from the ground by means of the rope, thus changing the antenna length.

can be used; it can be obtained in three-foot lengths at auto welding shops, and two or three lengths can be welded together.

The slider should be free to move easily through the holes in the insulators, otherwise it will bind and break the porcelain. Knox 5-inch stand-offs were used in the W3AAJ installation. If insulators with end holes are not readily obtainable, the type provided with a machine-screw terminal may be used and fitted out with a guide or bearing made from strap brass.

The stand-offs should be mounted on rubber to prevent cracking; pieces cut from old inner tubes will do nicely. The pull rope should be "straddled" around the pole so it will not kink.

The pole should be of wood and preferably painted with asphaltum paint. Lead paint is not recommended. The Sherwin-Williams people have a creosote-base paint called "Ebonol" which

is inexpensive and is an excellent wood-preservative for outdoor work. A gallon is ample to give a 60-foot pole two coats. The pole at W3AAJ is of poplar, a tree which grows pretty straight up to heights of 75 feet, and which, in this part of the country at least, can be sought out in the woods and bought very reasonably from the owner of the land. After cutting, trimming and skinning off the bark, the pole should be allowed to dry (in a position that will keep it straight) for a few weeks, as this reduces the weight considerably. Although poplar will crack on drying, the paint will cover the cracks. Any type of wood pole can be used, of course.

The guy wires should be broken up with insulators at frequent intervals.

#### TUNING

The drawing of Fig. 1 shows spaced feeders of the Zepp type feeding the antenna at the lower end. If the antenna length at the frequency in use is a half-wave or full-wave, Zepp feeders will have the lengths and tuning arrangements recommended in the *Handbook*. When the antenna is a quarter wave in length it may be operated against ground or with feeders of length sufficient to make up the other quarter wave needed for resonance. Feeders approximately 35 feet long, used with series tuning, will meet this condition for a 3.5-mc. quarter-wave antenna. Under these conditions the fields about each feeder will not cancel each other completely, with the result that the feeder will radiate. Since there is some cancellation, however, the greater part of the power fed to the system will be radiated by the vertical wire.

When the antenna length is a multiple of a half-wave any of the feeder systems—doublet, single-wire, twisted-pair—can be used. The same rules as to adjustment apply. It is also possible to use the top loading suggested by R. B. Dome<sup>2</sup> to increase the effective length of the antenna, in which case the sliding rod can be installed at the lower end of the pole.

Antennas of this type are now in use at a number of stations, all owners are highly enthusiastic about it, reporting results far above expectations. Field measurements about the antenna at W3AAJ showed approximately twice the field strength with the new antenna compared to similar measurements made on a horizontal half-wave Zepp installed at the same location. Although the measurements were of necessity made near the ground, where an increase in strength would naturally be expected from the vertical antenna over the horizontal type, reports from distant stations have borne out the improvement indicated by the measurements.

<sup>2</sup> Dome, "Increased Radiating Efficiency for Short Antennas," September, 1934, *QST*.

# The Seventh International Relay Competition

March 9th—17th Inclusive

ALL Hams, the world around, are invited to take part in A.R.R.L.'s Annual DX Contest. The four major features of contest operation are:

- (1) The exchange of a six figure serial number group, between W/VE and DX stations, counting both parties to the QSO three points if an exchange is completed in both directions.
- (2) A multiplier for the total of points made through such exchanges by either the number of countries (by I.A.R.U. prefix list) or the number of W and VE licensing areas with which successful exchanges have been made.
- (3) A total time of operation period—90 hours at any time in the nine-day contest period with no penalty. (A contestant can work as many additional hours as he pleases in the nine days, but scores are reduced in proportion to the *excess* hours for all time over 90 hours.)
- (4) A bonus to be added to the score as obtained by 1-2! This is 500, 1000, 2000, 4000, or 8000 points depending on a showing of at least one confirmed exchange of serial number on 1, 2, 3, 4, or 5 *different frequency bands*.

See February QST for rules and announcement in full detail, with which various suggestions to assist in successful and pleasurable DX operation have been incorporated. Mark your calendar now and plan to take part with amateur operators everywhere in . . . The Seventh International Relay Competition.

## R.F. Return Circuit in Interstage Coupling\*

A Common Source of Poor Transmitter Operation

By A. W. Friend, \*\* W8DSJ-W8KIU-W8XAW

IF YOU operate a transmitter with any type of interstage coupling other than the "link" type, this may apply to your case. With the high frequencies which amateurs use, the leads from one stage to the next may offer so much impedance as to give insufficient excitation, make neutralization impossible, and detract seriously from the proper operation of the entire transmitter. The outfit mounted one stage above the other, in a rack, is the most susceptible to this type of trouble.

Normally the coupling leads connected to the "hot" ends of the coils will be found to be short and direct, and they should always be thus. Where the trouble is to be found is in the return or common grounding leads. We are prone to forget that a return path must be supplied for the

coupling current to circulate back to the source. It seems to be a quite common practice to run a single ground lead up one leg of the rack and then to connect each stage to this lead where it passes by the shelf.

In revamping a transmitter, recently, I encountered a striking example of even worse practice than this. There were three shelves. The lower one contained the crystal and doubler stages; and each of the other two shelves contained an amplifier stage. One ground wire was run from the left side to the right side of the lower shelf, thence up a leg of the rack to the right side of the second shelf and across that shelf to the left side. Thus the coupling between these two stages contained a loop of the dimensions shown in Fig. 1. Calculations<sup>1</sup> show that the inductive reactance of this loop at 14 mc. is equal to 74.0 ohms. (The inductance is 0.841 microhenrys.)

\* Publication No. 100, Division of Industrial Arts and Sciences, West Virginia University.

\*\* Physics Department, West Virginia University, Morgantown, W. Va.

<sup>1</sup> From Bureau of Standards Circular No. 74.

Now if normal excitation was obtained with an r.f. grid current of five amperes, neglecting the relatively small resistance, the reactance of the feed wire and the return lead would give rise to a voltage drop of

$$E = IX_1 = 5 \times 74 = 370 \text{ volts}$$

Perhaps three hundred volts of this reactance drop would then be applied between the filament ends of the two tubes because of the long return wire.

The excitation obtained in the upper stage was practically zero on 14 mc., although it was satisfactory on 7 mc. and lower frequencies. But by simply connecting a jumper as shown by the dotted line (Fig. 1), the excitation immediately became normal; and several r.f. chokes, which had previously seemed to be no good at all, were found to be functioning perfectly. The whole trouble was that the impedance of the long return "ground" wire had caused the filament circuit of the upper stage to be raised to an appreciable r.f. potential—considerably "above ground."

Next, the return circuit from the final stage was found to be in an even worse condition. The ground lead from it was run down the left side of the rack entirely to the bottom shelf. The return path led from the top shelf to the bottom one, across this shelf from left to right, then up the right side of the rack to the middle shelf, and finally across this to the left side. The total length of this path was 160 centimeters. This condition was cured by connecting the down lead from the top shelf to the ground lead of the middle shelf where they passed not more than two inches apart. Again, the results were excellent.

The rule to follow is to make the lead from the common ground point of the filament and the by-pass condensers of one stage as short and as

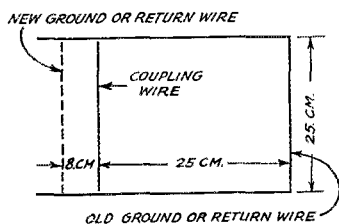

FIG. 1

direct as possible to the corresponding point on the next stage, even if good looks have to be sacrificed.

By the use of a resonant circuit such as a wavemeter, containing a resonance indicating flashlight lamp or thermo-ammeter, it is easy to trace the path which the return current is following, to see if it is the right track. The procedure is first to tune the wavemeter to resonance with the frequency of the current in the return lead by resonating it with the tank circuit of the preced-

ing stage. Next, place the coil of the wavemeter in inductive relation to the lead which should be carrying the current. (See Fig. 2.) If any appreciable amount of r.f. current is flowing in this lead, the indicator on the wavemeter will show

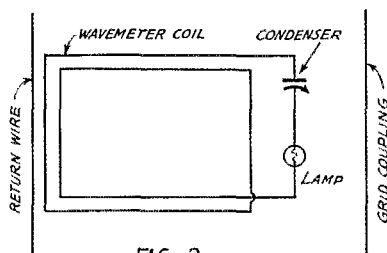

FIG. 2

it. Other supposedly "dead" leads (plate and filament supply, etc.) also may be tested in this manner to see whether they are carrying large amounts of r.f. current—which they should not.

### Screen-Grid Supply with Suppressor-Grid Modulation

(Continued from page 38)

occurs with deep modulation. But with series resistance effective at audio frequency, the screen-grid voltage falls as the suppressor swings more negative (because the screen current is increasing), and the modulation characteristic straightens out nicely toward zero. If the by-pass across the series resistance is too large (1  $\mu\text{fd.}$  or so) this linearity would not occur, of course, since the filter effect of the resistance-capacitance combination would maintain the screen voltage nearly constant. Hence the necessity for screen-grid by-pass capacitance sufficiently small to be negligibly effective at audio frequency while adequately large to be effective at radio frequency. The previously specified value of 0.002  $\mu\text{fd.}$  is generally satisfactory for this by-pass.

Resistance values for the voltage divider are not particularly critical, those specified with the figure being representative. For the less preferable method using a simple series resistor between the positive side of the plate supply and the screen, a value of approximately 15,000 ohms (50-watt) for one tube or of 8000 ohms (100-watt) for two tubes will serve. It is recommended that the change be made to the divider method in transmitters where fixed screen-voltage supply is now in use.

— J. J. L.

### Strays

Here's one for the book: Reading his local newspaper, W9GGZ ran across a reference to a chap by the name of Guy Wire!

# H A M D O M



*Hamdom greets three new A.R.R.L. Directors in the Central, Hudson, and West Gulf Divisions.*

FROM the Central Division there comes to the A.R.R.L. Board this year a man of mature years and judgment. Edward A. Roberts, W8HC, is a retired business executive and former owner



EXECUTIVE

of department stores, and has had years of experience as executive and director in business enterprises. A former trustee of Des Moines University, at 62 years he has been active in Baptist religious organizations, president of the Miami (Fla.) Chamber of Commerce, and is a 32nd Degree Mason and a Shriner. In amateur radio he is an old timer, O.P.S. and R.M., and is active on both c.w. and 'phone with three complete 'phone rigs and two c.w. outfits, including a kilowatt on 7 mc. and 400 watts on 2 mc. 'phone. W8HC is located in three large rooms at his home in Cleveland, one containing the transmitters, oscilloscope, frequency measuring equipment, etc.; one a workshop with power saws and lathe; and one a reception room and library used for radio club meetings, informal amateur movies, and similar activities. Amateur photography shares place with amateur radio as a hobby; W8HC has a splendid Bell and Howell 70/D professional camera and projector, with which he takes movies of convention gatherings and has established a complete Central Division ham film library.

KENNETH T. HILL, W2AHC, newly elected director of the Hudson Division, divides his existence between the A. T. & T. and ham radio. Loose couplers and spark coils started him off at Great Neck, Long Island, in 1914; these were later necessarily abandoned at Amherst College except for spasmodic raids on the physics lab. He served with the 324th Field Signal Battalion during the war, never quite effecting that wished-for transfer to the radio company because of his value in telephone work. Marriage, after the war, offered

an excuse to get back into ham radio with 2CLG. A telephone repeater tube was replaced by a 203A; as an O.R.S., traffic and DX flourished until 1926. Then ensued three years of gypsy life, travelling about the country. In 1929 he settled down again, with W2AHC. Since then he has been consistently found on 7 and 14 mc. and, for the past year or two, 56 mc. In 1933 he was president of the Decibel Radio Club, composed of the Bell System's radio bugs, and is now president of the Northern Nassau Wireless Association. His job is supervising all cable and conduit construction in the eastern area of the A. T. & T. Long Lines department.

THE West Gulf Division breaks a precedent of eighteen years in sending a new man to the Board this year. He is Wayland M. Groves, W5NW, of Neches, Texas. An amateur since 1923, he opened up with a quarter kilowatt spark, running the gamut through a 202 and other rigs to the present pair of 852's in push-pull operated at 1 kw. input. Always a DX man, he started out by working New Zealand and Australia on 80 meters in 1924 with that lone 202—thus laying the ground for the present WAC certificate. An O.R.S. continuously since 1923, traffic handling, especially with foreign countries, shares place with DX and rag-chewing as his enthusiasms. He has won several code copying contests and



TELEPHONE MAN

was one of eight to qualify for the finals in the world's championship contest at Chicago in 1933. When radio fails to enthrall, he turns to quail hunting as the sport that thrills him most. He is now chief clerk and telegraph operator for the Humble Pipe Line Co., at Neches; formerly he served as seismographer for the same firm both in Texas and in the Orient—better known as "Soupy" to his friends and QST readers as a character in yarns perpetrated by W5LS.

His wife, W5DUR, has been a licensed amateur for over a year and is an enthusiastic brass-pounder.



SEISMOGRAPHER

# With the Affiliated Clubs

**T**HIS month we are happy to introduce six societies, affiliated with A.R.R.L. on February 1, 1935:

Amateur Radio Transmitting Society, Louisville, Ky.

Genesee County Radio Club, Flint, Mich.

Grand Rapids Amateur Radio Association, Grand Rapids, Mich.

The Cambridge Radio Club, Cambridge, Ohio.

Wausau Radio Operators Club, Wausau, Wis.

Western Amateur Club, Cordell, Okla.

## Meet the Gang!

Several hamfests are scheduled for the month of March, as follows:

### March 2d, Wilmington, Del.

All amateurs are invited to the Second Annual Banquet/Hamfest of the Delaware Amateur Radio Club to be held in the Gold Ball Room of the Hotel duPont, Wilmington, Del., on Saturday evening, March 2d. The banquet will start promptly at 6:30 p.m. E.S.T. The affair will be a purely social one. No speakers are listed on the program. An excellent program of entertainment by professional artists will follow the dinner; dancing will start about 10:30 p.m. Many valuable prizes will be awarded, including several receivers. Tickets, \$2.50 per person. Special price of \$2.00 for tickets purchased in advance. For further details QSO W3DQ, W3AIS, W3DNI or any member of the D.A.R.C.

### March 9th, Port Richmond, S. I., N. Y.

The Staten Island Amateur Radio Association announces a Hamfest (Stag!) to be held Saturday, March 9th, at 7:30 p.m. E.S.T. at the Veterans of Foreign Wars Hall, 51 Cottage Place, Port Richmond, S. I. Tickets, 50 cents. Doings: Contests, eats, prizes, talks, demonstrations.

### March 24th, Detroit, Mich.

The Motor City Radio Club will hold a Hamfest in the K. of C. Club House, Woodward and Forest Avenues, Detroit, Mich., on Sunday, March 24th.

### March 30th, Chicago, Ill.

Radio amateurs of the Chicago Area will participate in their second annual Spring Dance and Hamfest on March 30th. Program includes prizes, dancing and entertainment. Prizes will range from fifty-watters to complete sets! Admission: 50 cents. The place: Gold Room, Congress

Hotel, Chicago. Any further details may be obtained from S.C.M. Hinds, W9APY/WR.

## Old-Timers' Reunion

The January meeting of the Chattanooga (Tenn.) Amateur Radio Club featured an "old-timers' reunion." There was an excellent turn-out and the meeting was one of the most enjoyable in months. Many names familiar to old timers everywhere are found on the list of those present: Fred Painter, ex-5ZE, former director Delta Division A.R.R.L.; H. R. Grimshaw, ex-2 (of 1913); Buck Taylor, W4LU, ex-3HX; Bill Van Dyke, W4IB, ex-5HL; W. O. Horner, ex-ZH; M. M. Roddey, W4AM, ex-5AMF; Bill McCord, W4BOZ, ex-5ABX; Ward Buhrman, W4CBS, ex-4QT; Joe Eiselein, W4FR, ex-3LF; W. F. Gamble, W4AHW, ex-5AAE; L. B. Murray, ex-5ANT; W. J. Coffey, W4CJI, ex-5AOL; Powell May, W4FX; R. O. Hardin, W4EP and Dr. H. L. Kitts, W4HK. W4FX, W4EP and W4HK represented the Knoxville Club. W. O. Horner was adjudged the "oldest old-timer" present. W4FX displayed the oldest QSL; he had telegraphic confirmation of QSO efforts in 1910, and of successful QSO in 1911. There was an elaborate display of old newspaper clippings, photos and equipment, including a complete rotary spark transmitter. W4LU showed a copy of the first QST printed. W4FX had a very old map with wording and dates, which he says proves that the A.R.R.L. was started even before the date it claims!! Talks by several of the "pioneers" made the meeting complete.

The Hartford County Amateur Radio Association (Conn.) held a very successful Old-Timers' Night on the evening of January 30th. After an excellent chicken dinner, the evening was given over to reminiscing. A good number were in attendance, and as each "old-timer" elucidated the big thrills he had received during early amateur experiences, the "young squirts" found much that was interesting and amusing. "AH" of W1ES was the oldest old-timer in attendance, followed in turn by W1QP (JL), W1EAO (RW) and Dave Moore.

For clubs looking for something different in the way of meetings, an "old-timers' night" offers possibilities!

## The New Orleans Radio Club

The New Orleans Radio Club, organized in 1932, is now located in its own club rooms at 1720 Poydras St., New Orleans, La., where the club station W5DYR is on the air regularly. The

(Continued on page 90)



## 'Phone Monitor and Modulation Meter

THE circuit diagram of the modulation meter and audio monitor used by R.C.A. in their one-kilowatt broadcast transmitters, shown in Fig. 1, should be of interest to 'phone men, since the apparatus is quite simple and inexpensive—exclusive of meters it can be built for less than five dollars. It uses two Type 80 tubes, one as an audio rectifier and the other as a modified form of volume-level indicator. The circuit constants are given under the diagram.

To put the unit into operation, couple the pickup coil  $L_1$  to the final amplifier tank, adjusting the coupling until a reading of 26 milliamperes is obtained on  $M_1$ . The exact value of current is

and made readily portable. The terminals marked "oscilloscope sweep" may be connected to that part of an oscilloscope if one is available. If not, the s.p.d.t. switch may be omitted.

—J. E. Pitts, Jr., W6CQK

**EDITOR'S NOTE.**—As a modulation-percentage indicator, this type of instrument is subject to the defect that its readings are dependent upon the average amplitude of the modulation envelope, whereas the *peak* amplitude is the important quantity in modulation depth measurements. The relation between the reading of  $M_2$  and the modulation percentage will hold only when the modulation envelope is a sine wave. If harmonics are present or the modulation is complex, as with voice input, the meter reading may indicate either a higher or lower percentage of modulation than the actual. The same applies to volume-level indicators whose readings are proportional to r.m.s. values, such as current-squared galvanometers.

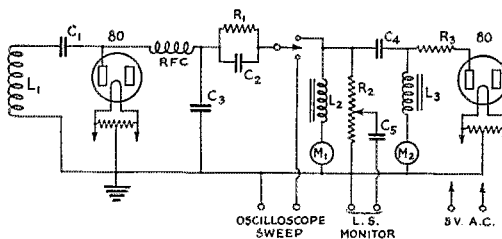

FIG. 1—MODULATION METER AND AUDIO MONITOR

Only one plate used in each Type 80 tube.

- $L_1$ —Pickup coil.
- $C_1$ —.002  $\mu$ f.
- $C_2$ —.05  $\mu$ f.
- $C_3$ —.001  $\mu$ f.
- $C_4$ —2  $\mu$ f.
- $C_5$ —1  $\mu$ f.
- $R_1$ —350 ohms, 3-watt.
- $R_2$ —10,000-ohm potentiometer.
- $R_3$ —2500 ohms, 3-watt.
- $L_2, L_3$ —30-henry chokes.
- R.F.C.—Short-wave choke.
- $M_1$ —0.50 d.c. milliammeter.
- $M_2$ —0.5 d.c. milliammeter.

important and must be observed if the modulation percentage is to be read correctly on  $M_2$ . At 100% modulation (steady state conditions, constant tone input)  $M_2$  will read 5 milliamperes. This meter can be calibrated directly in percentage modulation, since its reading is proportional to the amplitude of the audio-frequency carrier variations.

The size of the pickup coil is not critical. Anything will do so long as the rectified current as read by  $M_1$  can be set to the correct value. The whole instrument may be built into a small box

## Crystal-Locked Hartley Oscillator

IN RECENT issues of *QST* I have noticed several references to the Goyder Lock system, or oscillating amplifier. All have asserted that the Hartley circuit would not work satisfactorily, and for that reason I made several attempts to get my old 852 Hartley rig to work that way before changing it into a neutralized amplifier. I hit upon one scheme which worked perfectly and actually gave 15% more antenna current for the same input of 180 watts than with the straight Hartley.

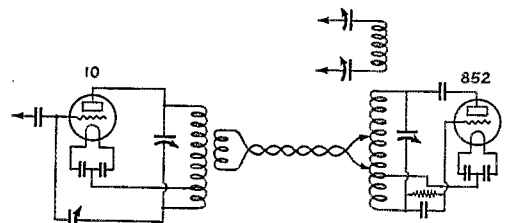

FIG. 2—CRYSTAL-LOCKED HARTLEY OSCILLATOR

The method is to use link coupling to the tank of the exciting amplifier and direct coupling to the amplifier, as shown in Fig. 2. I used a three-turn pickup on the exciter end and tapped about one-third of a turn at the amplifier end on a 7-turn coil.

The low power stages are the same as used in the present arrangement. A 59 Tri-tet doubling to



7-mc., a 46 buffer, and a 10 with 820 volts on plate and 200 volts bias, running cold, as the exciter to the 852. With straight crystal control, the 852 as a neutralized amplifier now takes 260 watts at 1800 volts compared with the 180-watt maximum as an oscillating amplifier.

—Will A. Shaw, W5ARV

## More on Eliminating Thumps

THE following note from William Hall, W5ASG, offers a keying suggestion which may prove as effective for other amateurs as it did for him:

"I have been reading all the various suggestions given in the Experimenters' Section for key click elimination, and thought that perhaps the arrangement I am using here might be useful to some one. I was bothered a lot with BCL complaints and this little trick completely eliminated the clicks, while for simplicity and low cost I don't believe it can be beaten. I merely insert a high value of resistance, in this case five one-meg. carbon resistors, in series with the bias batteries and bias resistors and hook the key directly across the resistors, as shown in Fig. 3. This eliminates the clicks and also the sparking at the key contacts. It has been used with up to 300

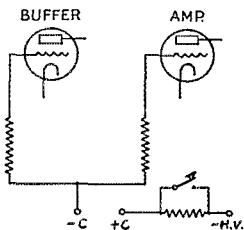

FIG. 3—GRID KEYING CIRCUIT TO PREVENT THUMPS

watts input to the final stage, using a 203-A. Both the final stage and the driver are keyed, with a complete cutoff of current to the final and almost complete to the driver."

## Keying-Relay Circuit Clicks

ANOTHER note on the old problem of clicks is sounded in the following letter from A. J. Thompkins, W6FBE:

"Am running a 650-watt c.w. job, crystal-controlled, on 7280 kc. in a full apartment building. As the rig is in a Westinghouse cabinet, the possibilities of slipping it into the building unnoticed were about as remote as bringing in a refrigerator under my vest. As a result I was blamed for all the radio interference in the place. That was not

strange since I was causing a lot of it, especially in one museum piece.

"The problem was one of either changing my keying system or making it noiseless. This rig is keyed in the primary of the plate transformer which supplies the two final stages. By-passing the 110-volt line strangely did not end the difficulty, though it did stop blanketing. Tests showed that the arc at the key which in turn actuated the relay was causing the grief.

"A good friend who knows his engineering better than I made the remark that in the keying

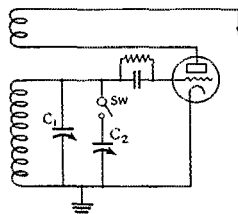

FIG. 4—AN AUXILIARY TUNING CONDENSER AND SWITCH ADDED TO THE REGENERATIVE DETECTOR MAKE MONITORING OF TRANSMITTED SIGNALS POSSIBLE

circuit I had introduced a lot of inductance, the coil of the relay. The good book tells us that this condition causes a current lag. Also if the voltage and current are out of phase there is more spark on the make and break of the key than if we have unity power factor. 'Well,' says the friend, 'put some capacity across the coil of your relay and balance up the circuit.' He suggested placing an a.c. milliammeter in the key-to-relay circuit and substituting condensers until a minimum reading was attained, which would indicate unity power factor. However, not having the prescribed meter, I took a chance on putting a mike of capacity across the coil. That must have been about what the doctor ordered, as the spark is cut to nearly no spark at all and now it is possible for me to run my broadcast receiver without interruption, and it is only about three feet from the transmitter and key.

"It may be argued that the trouble was coming from the arc on the relay but that was not the case as the interference was experienced when the relay was operated whether the transmitter was running or cold."

## Monitoring Without a Monitor

HAMS using regenerative receivers have right at hand a means of monitoring their transmissions without providing any auxiliary apparatus except a tuning condenser and a switch. It can be done quite easily by following the diagram of Fig. 4, suggested and used by Dougall Whitburn, VK5BY. In this circuit—a regenerative circuit

can be used instead of the tickler arrangement shown—the regular tuning condenser is represented by  $C_1$  and the auxiliary condenser by  $C_2$ . For reception, switch  $Sw$  is open, cutting  $C_2$  out of the circuit. When transmitting,  $Sw$  is closed, connecting  $C_2$  in parallel with  $C_1$ , and the circuit is then tuned by means of  $C_2$  to half the transmitter frequency so that the transmitted signal can be picked up on the second harmonic of the oscillating detector. Since the setting of  $C_1$  is not disturbed, opening  $Sw$  again for reception leaves the receiver tuned to the station being worked.

The capacity required at  $C_2$  will depend upon the constants of the tuned circuit. If  $C_1$  is very small, a 150- $\mu$ fd. condenser at  $C_2$  will be large enough to give the requisite tuning range. If the actual capacity used at  $C_1$  to tune about to the center of a band is fairly large—say 50 or 100  $\mu$ fd.— $C_2$  should have a maximum capacity of three or four times the  $C_1$  capacity in use.

### Inexpensive Feeder Separators

**A** FEW ideas for easily-made and inexpensive feeder separators are suggested in Fig. 5. The upper drawing shows the type of spreader used by Earle J. Lander, W7AHN, for which he claims the advantages of light weight, strength,

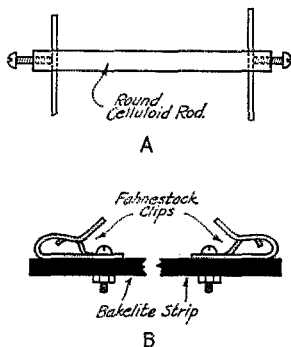

FIG. 5—FEEDER SPACER SUGGESTIONS

and the ability to “stay put” when once installed on the feeder. It is made from five-eighths inch round celluloid rod, obtainable from small “fixit” shops at a great deal less cost than the bakelite rod often used. Holes are drilled near the ends perpendicular to the axis of the rod to pass the feeder wires, and a second pair of holes drilled in from the ends to meet the first pair. The axial holes are threaded to take whatever size machine screw is used to hold the wires tight.

A second type, suggested by E. M. Gillespie, W2EAF, uses half-inch strips of appropriate length cut from junked bakelite panels, fitted out

with Fahnstock clips at each end as shown in the lower drawing. This type will stay in place without special fastening, and can be readily slipped along the feeder wires if it should be necessary. J. B. Abernathy, W6FII, uses the Fahnstock clip idea with spreaders made from half-inch dowels boiled in paraffin.

### Safe Starting and Excitation-Failure Protection

Many arrangements have been devised to prevent the careless operator from switching the plate and filament transformers on simultaneously. All that have come to our attention have some shortcoming footnoted. The arrangement used at W6EZY not only protects cold filaments but cuts the plate voltage if anything goes wrong back of the final amplifier. The foundation

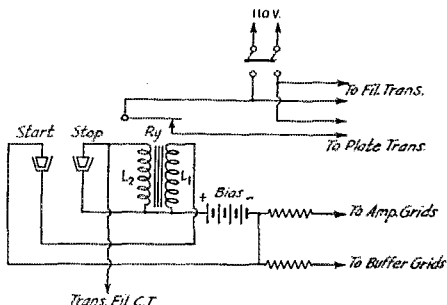

FIG. 6—PROTECTIVE CIRCUIT FOR PREVENTING TUBE DAMAGE IN CASE OF EXCITATION FAILURE

is the famous Philco AB relay switch rewind, hooked up as shown in Fig. 6. The holding coil,  $L_2$ , has 600 turns of No. 28 wire and is designed to release at 100 mils.  $L_1$  is the starting coil, an audio transformer primary, which operates the relay snappily on 45 volts.

To operate, push the start button. If the main-line switch is closed the filaments will be hot, and grid current through  $L_2$  will hold the relay. Anything that interrupts the flow of grid current through  $L_1$  will release the armature. Shorting  $L_2$  with the stop button does likewise.  $L_1$  and  $L_2$  are of course wound to assist.

Since the contacts on the Philco switch are not intended for heavy loads, they should be replaced by heavier silver contacts, depending upon the plate-transformer load. The resistors in series with the amplifier and buffer grid leads are the usual grid leaks to provide additional bias under operating conditions.

—L. M. Turner, W6EZY

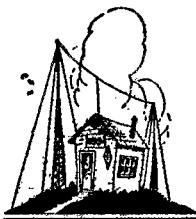

# Amateur Radio STATIONS



## W7BJS, Rock Springs, Wyo.

PROBABLY environment accounts for the appearance of the transmitter at W7BJS, shown in the accompanying photograph—the OM, George D. Johnson, of Rock Springs, Wyo., is connected with the telephone company.

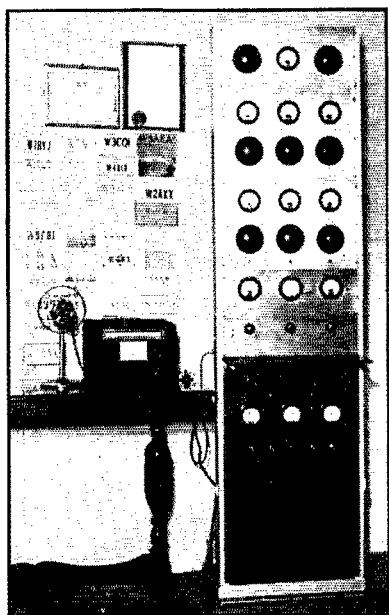

W7BJS

Hence the Western Electric rack and the typical rack-type construction.

The history of W7BJS dates to November, 1929, when activity started with a 205-D in the Hartley circuit; with this outfit 47 states and 6 countries were worked. Various other rigs made their appearance, one of the most successful being the popular 47-46-2 46's combination modulated by a pair of 46's in Class-B. Before being dismantled to make way for the transmitter illustrated, this set accounted for all states on the 75-meter band.

The rack-mounted transmitter now in use consists of a series of easily-removable units, each with its own panel and sub-panel (shelf) assem-

bly. Binding posts at the rear of each unit furnish readily-accessible connection terminals, with inter-unit wiring all cabled and laced. The r.f. section comprises a 59 which may be operated either as a Tri-tet or as an electron-coupled oscillator, a 46 buffer, a second buffer stage with an 800, and finally a pair of 800's in push-pull. The input to the last stage is approximately 200 watts.

The audio section includes a speech amplifier having two 56's and a 53 in cascade to swing the grids of a pair of 2A3's in push-pull. The latter tubes drive a pair of 800's in Class-B. An Ellis Type 30N microphone is used for most work, with a crystal mike taking its turn occasionally.

Power supplies are built on  $9 \times 12 \times 1$  inch pans and occupy the lower portion of the rack. Each supply unit has its output terminals brought to binding posts at the rear and is equipped with a short 110-volt cord which plugs into a receptacle. Each unit is thus quickly removable by taking off a few connections and pulling out the power plug.

The receiver is a National FB7A. Although not visible in the photograph, there is also a National oscilloscope for checking modulation. W7BJS usually works on 3629 and 7258 kc. for c.w., and on 3929 and 14,170 kc. for 'phone. A "push-to-talk" arrangement is used for 'phone work.

W7BJS holds appointment as Official 'Phone Station.

## W2HCP, Albany, N. Y.

THE neat low-power station in the accompanying photograph is that of A. P. Blosser, W2HCP, of Albany, N. Y. W2HCP is a new-

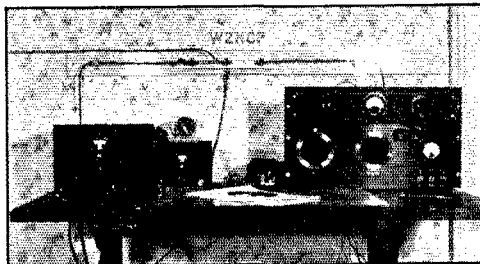

W2HCP

comer at the game, having been on for less than a year, with previous experience confined to building broadcast sets.

The transmitter shown is a Collins Type 4A, using a 47 crystal oscillator and a pair of 46's in the amplifier. To this has been added a home-made antenna-tuning filter of the type described by Collins in February, 1934 *QST*. At the left of the operating table is a National SW3 receiver, and beside it a monitor. A useful stunt in the station is the use of a large calibration chart, for both monitor and receiver, as a desk pad.

W2HCP uses a 67-foot antenna for 3.5-mc. work with very satisfactory results.

### W8EDR, Toledo, Ohio

**A**LTHOUGH the activities of W8EDR started in 1931, its owner, W. O. Beck, 1439 Chester St., Toledo, has been a member of A.R.R.L. since 1927. The first operation was carried on with a Type 10 tube on 80-meter c.w. In the spring of 1934 a 'phone outfit with a pair

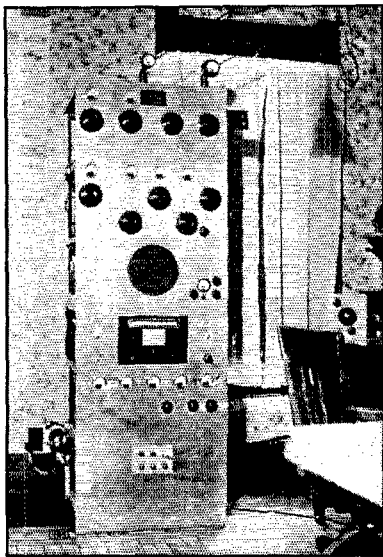

W8EDR

of 800's in the final was constructed, but it was only on the air a week when an accident put the operator in the hospital for four months. As a result the station has been on 'phone only since last fall, mostly in the early evening hours.

The transmitter now in use, illustrated in the photograph, has an r.f. line-up consisting of a 59 Tri-tet oscillator, 59 buffer, 800 second buffer, and a 203-A final amplifier. The input to the last stage is 200 watts. Speech equipment includes a double-button microphone, 56 first speech ampli-

fier resistance-coupled to a second 56 which excites a pair of 2A3's in push-pull. The latter tubes drive a pair of 800's as Class-B modulators. Power supplies for the transmitter include a 300-volt supply for the oscillator, a combined 500- and 1000-volt supply for the first and second buffers, and a 1000-volt supply which handles the



W3BYK

final stage and the Class-B modulator. A fourth power supply delivers 350 volts for the speech amplifier and driver.

The receiver, a National FB7, is mounted in one of the panels on the transmitting rack, with the loud-speaker on the panel just above it. The station is operated chiefly in the 160-meter 'phone band, using a four-wire flat-top antenna 60 feet long, with a counterpoise of the same dimensions underneath.

W8EDR also uses 56 mc. occasionally, having a transceiver with two-volt tubes for that purpose, but since the location is at low altitude ultra-high frequency work has been rather poor.

### W3BYK, Camden, N. J.

**I**N COMMON with many other stations which I have gotten out of the 210 class, W3BYK, owned by Stanley M. Ladage, of Camden, N. J., has a transmitter consisting of a 47 oscillator, 10 buffer-doubler, and a 203-A final amplifier. Most of W3BYK's operation is carried on in the 7-mc. band, crystal frequencies being available at both ends, with a plate input of 400 watts to the final. The receiver is a superhet.

A 66-foot antenna with 33-foot Zepp feeders takes care of the radiating. Several continents have been worked, as well as all U. S. and Canadian districts.

## *Strays*

Shure Technical Bulletins Nos. 11 and 12, on "Amateur Radiophone Transmitters," contain a readable and informative discussion of the various technical aspects of amateur 'phone design, and should be found of interest by 'phone operators. Copies of the bulletins will be furnished free to amateurs. Address Shure Brothers Company, 215 W. Huron St., Chicago.

# ● I. A. R. U. NEWS ●

Devoted to the Interests and activities of the

## INTERNATIONAL AMATEUR RADIO UNION

President: H. P. MAXIM

Vice-President: C. H. STEWART

Secretary: K. B. WARNER

Headquarters Society: THE AMERICAN RADIO RELAY LEAGUE, West Hartford, Conn.

### MEMBER SOCIETIES

American Radio Relay League  
Associazione Radiotecnica Italiana  
Canadian Section, A.R.R.L.  
Ceskoslovenski Amatérni Vysilacel  
Deutscher Amateur Sende-und-Empfangs  
Dienst  
Experimenterende Danske Radioamatører  
Irish Radio Transmitters Society  
日本アマチュア無線聯盟  
Liga Colombiana de Radio Aficionados

Liga Mexicana de Radio Experimentadores  
Nederlandsche Vereeniging voor Internationaal Radioamateurisme  
Nederlandsch-Indische Vereeniging Voor Internationaal Radioamateurisme  
New Zealand Association of Radio Transmitters  
Norsk Radio Relæ Liga  
Polski Związek Krotkofalowcow  
Radio Society of Great Britain

Rede dos Emissores Portugueses  
Reseau Belge  
Reseau des Emetteurs Français  
South African Radio Relay League  
Suomen Radioamatööriilitto r.y.  
Sveriges Sandareamatörer  
Unión de Radioemisores Españoles  
Union Schweiz Kurzwellen Amateure  
Wireless Institute of Australia

Conducted by Clinton B. DeSoto

### Current:

W3CRM, W2MO, W3EXC, W2FLO, W1BQK and W1WX on 'phone, W2GJC, W1HLV, W2CEN, W2GCE and W1EFN on c.w., were heard on 1.7 mc. by Victor J. Bartlett, G5BI. The receiver used consisted of a regenerative detector and one audio stage. The stations were heard between 0030 and 0515 G.T., the reports running from QSA4 to 5 and R3 to R5.

14 mc. blossomed forth into night-time splendor over the turn of the year along the U. S. Atlantic east coast. Yardley Beers, W3AWH, reports hearing and working VK's and ZL's from 1645 to 2100 one night, an unprecedented occurrence. And 3.5 mc.! All the active A.R.R.L. headquarters stations have been working Europeans from 6 p.m. on, as have dozens of other eastern U. S. stations. 7 mc. has lost face as a DX band hereabouts at the moment.

The Fullerton Radio Club, through VK5ZQ, has inaugurated the first standard frequency schedules to be attempted in Australia. The frequency transmitted at present is 7 mc., according to D. H. Greenlees, VK5FR, but plans are being made to transit on 3.5 and 14 mc. and, later, 3650 and 7300, as well. Transmissions commence at 1100 G.T. on Tuesdays, consisting of the following standard message: "CQ CQ CQ HR ST FR 7000 KC DE VK5ZQ," and continue for 15 minutes. Accuracy is within 0.1%, although this is not guaranteed. The service is being conducted for the benefit of amateurs throughout Australasia.

There's always something new. The newest thing to reach our ears is the three-way WAC of John Grinan, VP5PZ, and Frank Lucas, W8CRA. During the last nine months of 1934 three-way

QSO's were held between these stations and other stations in each of the six continents. The first stations contacted in each case were VK2XU, W6BIP, J2GX, G6TT, HC2MO, and SU6HL . . . . W8CRA also claims to have estab-

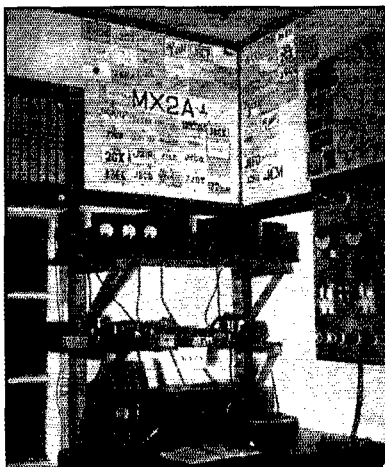

FIRST LICENSED AMATEUR STATION IN MANCHURIA (MANCHUOKUO)

MX2A, owned by T. Kawamura, 32 Shunshanzu, Pensihi, Fengtien-sheng, Manchukuo. A pair of 211's with 400 watts input follow a 202A and 2A5. The receiver uses two r.f. stages—58, 58, 57, 2A5.

lished the record for individual WACing, having worked them all 77 times. This represents contacts with nearly 1100 different foreign stations in 106 countries.

Next month: Complete revised and up-to-date list of the QSL Bureaus of the world.

## WAC:

The following were issued WAC certificates during 1934:

Marcus S. Moore, W4BG4; J. Smith, ZL4BA; S. A. Rance, YI2DB; Winsor B. Meals, W6AZK-W6PFE; Rudolph Archmann, OK1PK; Frantisek Werner, OK1WF; J. F. Lategan, Z84U; T. Shibata, J1EK; H. W. Hamblin, Y16IT; William L. Rogers, W9BMD; Frank E. Dalley, W9CKQ; Eddie Collins, W4MS; Joseph P. Gur, W4CKM; W. J. Kempton, G2AI; A. van der Voort, PA0XOK; E. N. Adcock, Z2DV; M. O. Okochi, J1FP; S. Mortimo, J1FT; H. Hodgens, E1SF; John D. Kraus, W8JK; Dan G. Bardin, W6PH; Thomas G. Hall, Jr., W3ZJ; Joseph L. Mullins, VE1DR; E. F. Henning, W5BMT; Louis R. Clements, W9BLG; Francis M. Melcher, W9DFT; P. van den Berg, PA0VB; C. H. L. Ashham, G6TT; C. L. Ward, G8NF; Le Roy Moffatt, W9JL; John F. Dognola, W9GDH; E. E. Gillman, W4CRO; Louisiana State University, W5YW; C. W. Parton, ZL3CP; L. C. Hunter, ZL8BJ; B. A. Lubbers, PA0ZZ; Josef Sotinik, SP1AT; W. P. Andrew, VE3WA; C. J. Bradstock, W2CJM; M. Fraiken, ON4EN; Lieut. E. S. Cole, SUIEC; A. Vergou, PA0CE; Charles G. Myers, W6CCF; Theo. F. Kinn, W1CC; Francis J. Walczak, W8DWW; H. J. Prata, X1UA; Kurt Illing, D4BAU; Yosajiro Hashizume, J3DP; L. Wilson Rancey, W4SW; A. R. Schlosnauer, D4BJP; Richard Henry Lee, W5ASX; R. M. Vickary, VK4RV; Francisco Pereira Viana, CT1G; A. A. Zeller, Z86AA; A. M. Clark, Z8GC; L. Walker, W5LY; B. W. Benning, W4C8Y; George Edward Bull, G6BU; H. E. Jacobs, PA0AZ; J. W. Gill, G6OS; R. A. Andrews, ZL3GM; C. Harling, ZT6D; Albert Farrenkopf, H8WBW; Taki Ko, J1GI; Ernest Kahler, W2BHZ; H. J. Tulin, PA0DC; H. A. Veringa, PA0LL; Ernest Günther, D4BJ; Georges Bedu, F8EB; B. G. Norton, G5DP; F. Weingärtner, D4BER; Guy Janssen, ON4BZ (phone); Paul Malsel, D4BDR; Kuno Shiba, J1EG; William Hall, W5ASG; R. W. Collins, W8EUU; Carl W. Luhn, W8BTI; G. Vandekamp, NY1AB; Charles G. Myers, W5CCF (phone).

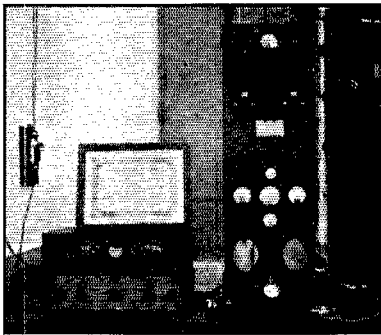

PY8LA, OWNED BY A. LOCKMANN, CAIXA POSTAL 17, ESTADO DE MATTO GROSSO, BRAZIL

A 3.55-mc. crystal controls a '45, '10, and final 830, Class B modulated.

Charles E. Stuart, W6GRL; Alexander Gressens, W8ANQ; Warner Hobby, W6MW; E. G. Squires, W9BRX; J. E. Hill, SU0HL (phone); I. E. Hill, SU0EL; I. E. Hill, ST2D; William Obrist, W9BEZ; Frank E. Wadman, G2GK; A. E. Brookes, G6VK; G. Featherby, G5FB; W. H. Lister, Z86AF; L. O. Rogers, G2HX; Harry M. Harvey, W2BKW; R. D. Hoffman, W7DL; William F. Worell, W5AQD; George A. Tebolt, W2BT; Oscar L. Frennell, Jr., W8BCT; Avery LaMont, W8BYC; Charles Melten, W1FH; Wilbur A. Craig, W9FLH; George J. Gabert, W9JM; Bradford A. Beard, W5ADZ; John P. Kieselbach, W9CPQ; Vyntanas Vanasas, LY1AA; G. Kikuchi, J3CG; Virgil R. Beck, W9GVR; Leo W. Honea, W5BSG; Gotthold Danzke, D4BDL; Dr. Hans C. Deckel, D4UAG; E. J. Kehr, G6XK; E. Robinson, G6XT; A. C. Emdrecht, ON4ACE; William WOOT; W. P. Ingersoll, W8ZTV (phone); James W. Shaw, W8EJE; Jesse A. Kimble, W9JTD; P. B. Littlefield, Jr., W1DUK; Gerhard B4z, D4BBL; Kurt Bretschneider, D4BLU; Harry M. Stevenson, W1CUN; P. Jastrzebskas, LY1J; Stanley Johnson, W4ZH; Alva Parham, W4MR; Glenn R. Thayer, W8TGC; Andrs Auger, F8EF; Jean Lory, F8DS; Henry W. Gould, W8BS.

Frank J. Platner, Jr., W8FVG; Walter J. Rabe, W9AOL; M. Oshima, J2IW; Rensselaer Polytechnic Institute Radio Club, W8EJ; H. van Breen, PA0FX; Sture Astedt, SM7YN; Charles G. Myers, W381; F. E. Baldwin, W1ZW; Oscar Waggener, W8BTE; Frank Gow, W1AF; Ross J. Artick, W4DPO; Rex H. Kundinger, W9CCI; Robert A. Lundstrom, W9FUR; H. Chadwick, VE2CH; D. M. Davis, W5CV; Dr. A. Kornlewski, W2AMM; Tatsuo Takeuchi, J3DQ; L. Wickham, ZL3FG; A.

Stevens, ZL2HR; H. Beaumont, G5YV; Julio Prieto, X1AA; R. O. Davidson, VQ4CRL; J. A. Sutter, FK1B; Kaj. Stockfleth Groot, OZ7KG; Joseph Grbec, YU7GL; Stephen Liebermann, YU7UU; Hans Bühler, HB9AA; Charles Miller, W8DK; G. G. W. Mossbacher, W9AUH; Francis Dr. W6DVI; Richard Brown, W6GSZ; Orville M. West, W9CVV; Harold Bicket, W6AND; Raymond Farwell, W2BJ; Wilson B. Scofield, W2DTB; Forrest T. Walker, W9GUB; Lieut. D. C. Redgrave, KA1NA; Charles Arnold, W4ZP; Lester E. Fry, W6CLP; E. J. Dunkley, YU2JL; Paul W. Mark, W9CVN; Melvin J. Vory, W8EHL; T. S. Garrard, G6GJ; John Braun, HB9AQ; M. E. Tanson, G6P; A. Pollard, G2BN; Alfred A. Barrett, G5UF; Wilhelm Helmeke, D4BNK; Ivar J. Wethe, LA3R; F. Herwig, D4CET; W. H. Baum, PA0PS; Hermann Halsek, D4BPI; Albert Noel Jackson Ley, G5DM; Gerhard Bussler, YM6ZO.

F. J. Marco and E. H. Conklin, W9FM; J. Stufkens, PA0JK; F. C. Whitmore, ZE1JL; D. A. Griffin, W2AOE; James G. Stradling, Jr., W3CKT; Lee Roy Scott, W5BOW; Leslie M. DeVoe, W9LU; Frank H. Pettif, SU18Q; Carl J. Madsen, W1ZB; Werner K. Sauber, W8KC; Andrew C. Thompson, W8DQW; Albert E. Scarlett, Jr., W2CC; Dr. Frank E. Breen, W6FQY; Charles A. Bailey, Jr., W6BXL; T. J. Dama, Y1DT; Harry G. Burnett, W1LZ; Harry D. Rohman, W2BLV; Clarence Falstrom, W9KM; Shelley Trotter, W6BAM; James A. F. Birchard, VE3GH; Charles W. Hines, W8FNN; Lloyd A. Fisher, W9CYA; Ade F. Renner, W8DVX; John W. Lamey, W8DQW; Thomas S. Thompson, W8FDE; J. Frank E. Stanslaway Houli, SP1DE; Charles Vohalsky, YU7VY; Barbara Mary Dunn, G6YL; John C. G. Kealy, G6IH; Santigo Maymi, EA3AS; Julio Lopez Morales, EA4BM; Enrique Ricart, EA3AN; Alberto Mariotti, EA1BC; Vicente Garcia Romero, EA5BQ; Willie Dell Nelson (Mrs.), W5ZW; Elmer Burdman, W5AAK; Will A. Shaw, W5A8Y; Theodore Chemlin, W8HFN; William W. Phippen, W9JFB; Vincent S. Roddy, W8PI; W. A. Duffield, VE4DU; Johan Rosenlund, LA3G; G. W. Bergstrand, LA2N; A. M. Holtzhaus, ZT6N; W. G. Pyke, G6PK; Alberto Barata Pereira, CT1AZ; Yoshio Otsuka, J3EH; Dr. S. Mori, J3EM; F. J. Ferguson, ZG6EP; Mrs. E. Luciano, Y1GDM; J. Frank V. Vary, VE3ZE; Elmer D. Smith, W1BWA; Merrill Eldson, W5AMK; John O. Trotter, W6BVX; Vernon D. Penner, W2EQU; John E. Preston, W2GOX; Harvey C. Kelsner, K6BFI; R. G. Newland, G5ND; J. N. Roe, G2VV; H. V. Herschel, K4UK; G. W. Reid, K3FZ; J. J. Mc. Math, VE3JJ; F. L. Krever, PA0XG; Katsuhisa T. J. J. Oosterlaan, PA1JMW; OK1OM; Jaroslav Chmel, OK1BC; Valgard Christensen, OZ7CV; H. W. Sadler, G2XS; George E. Thell, W8ILL; L. Parrott, G6PF; Mellen T. Gulesian, W1DZE; Albert E. Good-year, W8ERT; Onne L. Santu, W8DEC; H. Loring Meester, W8EIM; James M. Kane, KA1NE; Dr. K. Baumann, H8BB; Wolfgang Frey, HB9AC; Alex. Schmidt, D4CAT; Hobart J. Bell, W8ZF; D. M. Erikson, W9FQU; Wilbur A. Craig, W9BLD; Donald J. Henrie, W8BBN; Porter W. Stannard, W1EWA; L. W. Ballard, W8BVN; C. C. Clemans, W9COG; George W. Bailey, W1KH; Miles W. Weeks, W1WV; Raoul Soule, F8FK; M. B. Gorter, PA0UM; T. W. A. Oosterlaan, PA1JMW; Henry Larsen, OZ7HL; W. F. Meyer, ZU6P; W. H. Browning, ZU6E; G. H. Joffe, V87G; Hans Bauer, D4BAR; N. McNaughton, VK2ZH; Bell Moore, VK2JZ; L. J. Kermond, VK3DX; R. L. Belstead, VK4EI; L. Mario Frascino, PY2CD; Harold Swanson, W3DRN; Carlos Reitelordt, D4CPI; Victor Derlin, ON4HBP; B. A. Chapman, WK2BA; C. W. Leeds, Jr. W3AIU; C. R. Stegall, ON4CSL; George Brown, G6BJ (phone); Lowell E. Norton, W9BTW; Clyde F. Norton, W9ELA; C. V. N. Steffen, W6ZAE; Robert Wallace, W2EGW; Jerry E. Gorman, W8JLU; Melvin E. Chu, W1G; Gordon W. Henderson, W8AOF; Louis L. Clements, W2HH; W. L. Hinton, W9ABE; H. M. Buroker, W7QC; Robert H. Bechtold, W8SF; Roden J. Rogers, W8EPC; J. Duchene, ON4DX; Robert Holmes, G6RH; William C. Mingus, Jr., W5AUJ; Jesse A. Marco, W5CYI; Kenneth J. Hase, W8NZB; Karl E. Pierson, W8EGH; G. W. Leeds, Jr., W3AIU; Edward E. Squier, W6AZC; Harris Fachsenstock, Jr., W1ZI; C. E. Arnold, W8KJR; F. Kerhof, PA0KT; H. J. M. Kunnen, PA000; G. H. Boit, PA0GH; J. Macintosh, V82AF; T. C. Wood, Jr., W4AH; Mario De Mattia Carbonini, I1MD; Egil Berg, LA2U; Fernand Clouet, F8DA; E. A. Coombe-Davis, Z82D; Rex Bosman, Z82X; L. H. Nijhoff, PA0FLX; F. E. Frame, ZL4BQ; D. Brown, ZL1HY; S. G. Walte, ZL1AB; L. M. Mellars, ZL1AR; L. Young, ZL2KX; R. H. King, ZL2KI; Rudolf Burian, OK2AT; Charles Dillenberger, OK3ID; M. Pluener, ON4MY; Harry Roberts, VK5MY; Norman Blackburne, G2AX; M. Okada, J6CE; Ervin Rasmussen, W9FAV; Marvin E. Juza, W9FYU; Theodore L. Carnes, W9GMV; and R. H. Hoffman, W9AGO.

Congratulations, OM's!



## Ode to a 210

When the earth's last callbook is printed  
And the tubes are twisted and fried,  
When the loudest Aussie has faded  
And the weakest signal has died,  
Ye shall rest, and faith ye shall need it;  
Shut down for an ion or two  
Till the master of all brasspounders  
Shall put you to work anew.

—W8HG



# CALLS HEARD

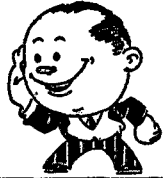

**K6JPT, William H. Stull, Kilavea Military Camp, Hawaii, T. H.**

(7-mc. band)

cr7ae u9ay plk1r cx1bu ce4cd lu1ep lu1za lu7az lu5cz ze1jm ze1jo zs6a zslh zszx vq3bal zusy j7cd j2hs j6db j2ka j2kn j2kp

**Albert Lower, U.S.S. Augusta, 200 Miles East of Guam, M. I.**

(7-mc. band)

ac8jq flrm j2kn j2gx j5cx kalan kal1r pk4pa pk3st vk2fm vk2as vk2vo vk2ep vk2dl vk3ng vk3gq vk3gu vk3pq vk4ko vk4le vk4en vk2uy vk5my vk5wr w5eiw w6gpb w6h1w w6fac w6kwa w6jzd w6bbn w6dhs w6c1i w6ft w6hzt w6jwl w6ldq w6ct1 w6ljs w6dvi w6pdp w7uj w9mzf w9rgh z12as z13pf z14ai

**BRS 1333, Donald W. Morgan, 15 Grange Rd., Kenton, Middlesex, England**

(14-mc. 'phones)

cm2an cm2ws hi7g k4sa ve2ee ve3jv ve2dx velbv ve2ca ilki ilxx ct1by ct1bg oh2ne la1q w10xda fm4aa w1wj w1die w1gpe w1bic w1cgy w1ahi w1dbm w1caa w1afa w1kj w1axa w1bnm w2akk w2evi w2aog w2fwk w2aow w2hfs w2byt w2goq w2oa w2dw w2ate w2ce w2dul w2de w2gx w2and w2aal w2bro w2tk w2by w2coj w3md w3cqm w3awt w3vth w3ddo w3zx w3nk w3auc w8ldd w8cpc w8gly w8ach w8pk w8cyt w8dfu w8htx w8aku w9far w9wl w9dku w9brx w9das w9pz w9eic w9bht

**Thomas A. Cirno, 1012 Morris St., Utica, N. Y.**

(14-mc. 'phone)

cm2se cm2wz cm2sc cm6xs cm2ri hi6f hi7g hi8x lulcb t1ba ti2rc ti3at ti3wd w10xda x1br x1f x1p x2n hi5abg x1aa

**K6CGK, K. Nose, 3903 Old Pali Rd., Upper Nuwahu Valley, Honolulu, Hawaii**

cr7ad cr7ae cr7af cr7am cr7aw u9az v3ab v3ac v8af v8ag vq3bal vq4cl v5aac vs7ai vu2by vu2dj vu2fy vu7kh zslh zslz zso5 zsxz zso6a zso6f zso6h zso6l zso6m zso6d zso6m zso6r zso6y zt6k zt6t zt6x zt6y zu5u zu6ac zu6a zu6b zu6e zu6p ze1jb ze1je ze1jn

**W8LDA, Robert Grant, 3 McMaster St., Auburn, N. Y.**

(7-mc. band)

cm2bf cm2fa cm2fc, cm2ho cm2jq cm2jt cm2mg cm2pw cm6gt cm6sg cm7jp cm8pq cm8ri cm8mn ct1ed cx1bu e4ab ea5bs ea7be ea8f ei5f f3cx f8g f8pim f8vp fm8bg g5fa g6nj hb9aq hj3aih k4brn k5am k5ay k7git ny1ab ny2ab pa8rp, pylaw py2bn splar ti2ft vk2ae vk2as vk2dl vk2fe vk2eq vk2zw vk3cs vk3tm vk3wc vk3xq vk5go vk5mk vk5hr vk5xu vp4af vp4jr vp5pa vp7nb z12ld z12mm z13gr z13jn z14ek

(14-mc.band)

d4bau d4bbn d4bec d4bga d4cjp ea3by ea3eg f8ea f8fx f8fe f8ij f8ru fm8se g2av g2bh g2bm g2gf g2km g2rq g2sx g2wq g5sr g5wy g5yh g6dh g6hp g6jq g6py g6qp g6sz g15qx haf3h he2jm hi7g hi8x hpl1a k4sa k5af k5aj k6baz kw1ab lu2fe lu8dj lu9du oh3np ok2op on4au on4dx on4ij on4rx

on4zq pa8ce pa8ke pa8ll pa8mr pylif py2bx ti2fg ti2tao ti3wd vk3mr vp5jb vp6yb vq2mv x1ay x1bb x1w

**W9CFB, Gerald Tipton, 406 E. 1st St., Moulton, Iowa**

cx1bu cx2cx d4bbn g2bj g2by g2oi g5by g5nj g6vp hk3aih hk1lh hp1a j2hg k6hip lu2as lu6ap lu7ef oh3oj oh4csl py2bk py2qc u3bi u3ci vk2ba vk3mr zsl1a zso6v

**G6YL, Miss B. Dunn, Felton, Northumberland, England**

(7000-kc. band)

w2eyv w3hn w4ctz hc1jw k4brn lu1ad lu2eg lu5dj lu6ax velbv vp4tc vp5pa py9ah vk2da vk2dr vk2er vk2fy vk2kb vk2mr vk2vg vk2xu vk3gu vk3gq vk3hl vk3jq vk3lq vk3mr vk3ox vk4ju vk4ry vk7bj vk7rc vk7rt z12ab z12as z12fr z13dx z13gw z14ai zso2a zso3a vks zxl1b zxn2b zxn2c

(14,000-kc. band)

w4bbp w4ix w4mr w4zh w5bf1 w5bmm w5cvj w6adp w6aha w6byu w6byw w6clp w6cnp w6cxw w6fzl w6cvv w6dyu w6fay w6grx w6hjt w6kql w6ldq w6lfl w6qd w6ud w6uf w6yb w7amx w7avl w7ayq w7qc w9ach w9aav w9cog w9flh w9gmv w9gyk (fone) w9mv w9ooo w9pch w9pov fbae f4c1j on4csl oz7esk j2iw lu3de pk1xb pk2ko pk4az pylaw sx3a ve2bb ve2ca ve2ee ve2ew ve2fi ve3er ve3gh ve3go ve3jz ve3lu ve3qh ve3tv ve3wa ve4ae ve4bq ve4du ve4jv ve4ku ve4ox ve5ws vk2ba vk2cy vk2ev vk2hy vk2ls vk2no vk2rk vk2wj vk2xu vk2yv vk3bj vk3bw vk3cp vk3ht vk3jvk3ml vk3mr vk3wc vk4levk6gw vk5wg vk6mn vk7ck vp4aa vp5jb vp5pz vq4cl vq4crp vq8a vu2bl vu2bm vu2bn vu2bv vu2bx vu2ja vu2ls yv3la x2l zelij zelij zslh zslp zso2a zso4u zso6l zt6a zt6j zt6m zt6n zt6s zt6w zu6p vpy7 zxn2b zxn2c

(28,000-kc. band)

d4blt g5qy fm5er

**G6ZU, R. H. Jackson, 54 Prince's St., Stockport, England**

(14-mc. band)

w6adp w6ayq w6bip w6bvz w6byu w6fzl w6cxw w6gox w6grx w6hjt w6rz w7rz pylaw py2bk py2cd py1dj lu6ap lu7ef lu9bv vk2ls vk3mr vk4ei vk4bb z14ck

**W2GFF, Dick Peacock, 81 Westville Ave., Caldwell, N. J.**

(14-mc. band c.w.)

st8d sulsg sulmo sulch vq4crp vq4cl ce4aa on4csl lulej lu3dh cx2am

(14-mc. 'phone)

k4sa cm2wz cm6xz hi8x la1q w10xda hi7g x1g cm6xs

(7-mc. band)

vp1am zso6b zu6b zu6p

**W9BXX, M. F. Whitton, Burlington, Wis.**

(7-mc. band)

cm2af cm2jg cm2rl cm2wd cm8fa cm8pq k4cqv k5ac k5ag ny1aa ny1ab ti2ae x1aa x1bc x1e x1t x2h z13ax z13hk z14bq

(14-mc. band)

f8ex f8if f8fc fmdaa fm8bg g2nh g2pl g6nj g6yl g6ga hb9aq hc1jw hc2hp cx2am on4au on4dx on4c1j on4csl py2bx ti2fg ti3ab vp4aa vp5pz x1am x1b x1de x1g zt2f

Louis White, 207 Prospect Ave., Long Beach, Calif.

(160-meter 'phone)

w3uva w5cue w5kyx w7eon w6iwy

(75-meter 'phone)

w1bes w1cwh w2edw x1ai x2ak ve4hq ve4nc ve5ef ve5er ve5hy ve5jb ve3ji k7aoc z11bq x2ak w9lye

(20-meter 'phone)

k6omc x1g x1ai x1u x2ak x2n cm2ra vp5po ve4ea ve4ff ve4hm ve5ak w1cnd hi7g w2tp

Charles Miller, 309 View Place, Covington, Ky.

(7-mc. c.w.)

pa0kw pa0zj lu6ax cx1bu ea7be vk2fk vk2xz vk3dp vk3ty vk3zf ct1aa ct2ag z12cy z1zge z1zkk k4brn g2z

(14-mc. c.w.)

vq4clr vq4crp fm4aa fm8bg on4cl on4mad on4gw on4vc on4my on4rx on4ou on4ba pa0ll pa0kg pa0vb pa0pa pa0ax pa0xf hc2ev hcljw hc2jm oa4j hb9j hb9ao hb9aq ct1ec d4bbk d4bqo ea1ba ea1as ea3eg pa0rp f8plm f8vp on4gu hj3ajh ok1lf ok1ln

(14-mc. 'phone)

x1g k4sa k6baz hi7g hi8x cm6xa w1oxda g5ah (?)

J2HG, K. Nakamu, a 131 Kamifujimae, Hongo, Tokyo, Japan

(14-mc. c.w. band)

ve2ax ve2bb ve2be ve2ca ve3qh w1bpx w1dhd w1fne w1dhe w1lqk w1aqq w1oun w1bei w1lz w1dln w1bxc w1gdy w1htp w1gjq w1hnp w2bar w2epa w2aif w2gox w3bbb w3dsy w3che w3cgk w3btu w3bd w3euy w3dvs w3eyw w3cxo w3fkg w3bsf w3aaw w3lea w3bfg w3jk w3iinq w3btk w3era w9fso w9ka w9ico w9dru w9geh w9bmx

W1GSB, E. S. Sunderland, 279 Indiana Ave., Providence, R. I.

(14-mc. band—Jan. 1st-18th)

vk3mr vk7kw xoh3ng vu2jp

H. N. Walker, South Pine Rd., Enoggera, Brisbane, Queensland, Australia

(3900-kc. 'phones heard during 1934)

w1bes w1cwh w2goq w2aw w3cf w3bms w3axr w3avi w3blz w4aad w4aby w4oa w4lf w5atf w6bq w6fed w6zah w6cwh w6ax w6fuo w6hxf w6bqa w6jbi w6ka w6bqt w6eah w6eou w6dda w6abf w6axt w6alk w6dja w6iqe w6axq w6ezy w6fbl w6agg w6ky w6ecj w6fbn w6dgi w6goy w6fdv w6cix w6but w6gmp w6yak w6cjk w6ene w6cz w6ep w7apd w7aqx w7buf w7aol w7bec w7md w8akw w9aqi w9dxi w9ji w9edw w9mbg w9bhu w9cou w9kws ve5er x1g x2ah k6cib k6cwr k6cmc k7aot

(14-mc. 'phones heard during 1934)

w2eug w2tp w2goq w2czo w2haf w3qv w5aot w5yww w5ccb w5bat w5ecm w5bdb w5bq w5zh w6cin w6ene w6ig w6cz w6giq w6buw w6fbl w6elr w6arl w6ifn w6abf w6cqq w6da w6aqk w6uf w6dho w6elm w6ahz w6dja w6cbr w6ftu w6fg w6cle w6aby w6dlh w6ftu w6bj w6eip w6dhz w6gg w6cif w6ibf w6rp w6bli w6ut w6goy w6and w6cqs w6fdm w6hoy w6pxy w6aar w6km w6oi w7bke w7bfc w7qc w7fhe w8dl d w8gy w8bz w9ld w9bht w9ji w9bpm w9gdy w9dn w9gvk w9tv w9dum w9qz w9usa w9job w9exj k4sa k6fj k6baz k6cmc k6bwq x1g

R. D. Everard, 11 Lindsey Terrace, Standon, Nr Ware, Herts, England

(14-mc. 'phones)

w7ark w7qc w7daa w9jgf w9jga w9dhk w9dwl w9dro w9gxl w9dku w9rv w9dz w9fdo w9nno w9fge w9gyk w9hbh w9bj w9jos w9cca w9kfa w9fn w9boz w9fzl w10xda

k4sa cm6xa cm2ra cm2se cm2an vp6mr lu8dr py2ak hel1g hl7g hl8x w5ahk w5bcq w5awu w5yh w5yw velx ve3gk ve3tw ve3jv ve3mp ok2hm fm4aa oh5ng oh2ne la1g

(3.9-mc. 'phones)

velei w9bbu w9mm wbes wldr w2goq w2edw veldq w2nz w2au w2aga w2coj w3dq w3bms w3ahr w3pb w3is w3aec w4pw w8xbx

W9GDB, B. H. Hansen, Milford, Nebr.

(7-mc. during January)

ce2bo ce3el hel1g hc2mo j2kj j2kp j3aw kalfs kalax kalus pk1bo vq2ph xu2as xu7lf yv5pl

## Grid-Bias Modulation

(Continued from page 31)

set at the proper point for Class-C operation (twice cut-off bias) and the oscillator and buffer stages tuned for maximum excitation to the final amplifier. The antenna is coupled to the final amplifier so that the plate current is 175 ma.

The transmitter can then be readjusted for 'phone operation as follows:

1. Increase antenna coupling until final amplifier plate current is 250 ma. Note the antenna current under this condition.

2. Remove the unloaded buffer tank coil and insert the buffer coil which is fitted with a shunt load resistor.

3. Increase the setting of the bias potentiometer until the antenna current is reduced to exactly one-half of the value obtained under "1".

Operating Conditions of 211	Theoretical	Observed
Plate voltage, $E_b$	1250 v.	1250 v.
D. C. plate current, $I_b$	106 ma.	110 ma.
Carrier power	45 w.	43 w.
Peak power	180 w.	172 w.
Plate dissipation	87.5 w.	94.5 w.
Plate efficiency	33.8%	32%
Amplification factor, $\mu$	12	—
Plate impedance, $R_p$	3400 ohms	—
Load impedance, $R_L$	2500 ohms	2500 ohms
D.c. grid bias	-240 v.	-240 v.
A.f. grid voltage (100% mod.)	86 v. (r.m.s.)	86 v. (r.m.s.)
R.f. grid volts	310 v. (peak)	—
D.c. current (unmod.)	—	2-3 ma.

The transmitter is then ready for use. With a constant pure tone signal, 100% modulation is indicated by a rise in the amplifier plate current of approximately 12 ma. With speech, however, the rise is only about 6 ma.

Of course, the procedure given above is not necessarily applicable to every other set because the first adjustment for proper load impedance is affected by power supply regulation, etc., and is consistent for a single design only.<sup>4</sup> Proper adjustment of another grid modulated transmitter of different construction really would require the use of an oscilloscope and an output measuring device for the initial determinations. If some other design is to be used, it is well to choose an amplifier tube with adequate plate dissipation capability and a medium or low amplification factor.

<sup>4</sup> George Grammer's article elsewhere in this issue describes methods for lower-powered transmitters.—EDROR.





# OPERATING NEWS



Conducted by the Communications Department

F. E. Handy, Communications Manager

E. L. Battey, Asst. Communications Manager

**S**TATION ACTIVITIES have appeared as a basic part of *QST* from the early days. The grouping of station activity reports comprises a summary of the individual radio activities (all varieties of amateur communication) of a large number of our licensed stations that do things worth reporting. Your elected Section administrative official, the S.C.M., prepares the summary, and the goal of each S.C.M. is "a report from every active ham" each month. The summaries constitute a running history of amateur activity. The reports you send your S.C.M. (address on page 5, *QST*) on February 18th will appear as a part of the permanent record of amateur radio in April *QST*. Since early 1933 the thousands of independent activity reports have created a considerable problem in editing, to enable your S.C.M. and Hq. to present these reports concisely and still keep them interesting. Starting this month a new plan is being tried to make it possible to expand the text of reports somewhat, thus increasing their interest and value. The different A.R.R.L. Divisions will be grouped into four main regions. Instead of your *QST* carrying every report for the whole country, you will receive an enlarged report for your particular region, and Sections adjacent to yours, but a new department of "national highlights" will summarize the more important events taking place in the distant parts of the country. It is expected that this will make possible better reports, and we hope the change meets with your approval.

## REGISTER YOUR USE OF AMATEUR RADIO

Elsewhere in these pages of operating matters we are printing a return coupon. Please make use of this form (or jot down the essential facts requested on a postal) to give us your views on certain problems and to enable a compilation of "vital statistics" to be made, so that we, in turn, may pass the accumulated data over to your Division Director. It matters not whether you work 160-meter fone, or 20-meter DX or whether the whole of your amateur existence is wrapped up in traffic handling or 5-meters. As we look at it, all of the frequencies permitted to us amateurs by international regulation are ours to use. One cannot propose to change any regulation or to revise any part without effecting the interests and rights available to all of us. So it is important that every one "register" his individual interest in amateur radio, and as accurately as can be determined, his individual use of the different amateur frequency bands, so that this may be taken into consideration when our Directors endeavor to determine what action to take on any problem "for the greatest good of the greatest number" in amateur radio. If you think that your part in amateur radio is worth consideration, by all means we urge you to use the coupon or a postal or by some means (for the information of your Director) **INDICATE YOUR USE OF THE AMATEUR BANDS!**

--F. E. H.

The following contribution by Robert Dutton, W8FDY, wins C.D. article contest prize. Your articles on any phase of amateur communication activity are likewise solicited and may win you a bound Handbook, six logs, or equivalent credit applied toward other A.R.R.L. supplies. Let us have your article, and mark it "for the C.D. Contest," please.—F. E. H.

## Breaking into Traffic

By Robert Dutton, W8FDY \*

**N**O FIELD in the hobby of amateur radio offers more enjoyment than good traffic handling. I believe that thousands more fellows would take advantage of this fact if they knew how to break into the game easily and correctly. Perhaps a few personal experiences and viewpoints of a ham, who doesn't claim to be an old-timer or expert, but who has arrived at the stage of operation with some fine operators, would assist some of these men.

The traffic game is just like any other. The better one plays, the more enjoyment one is going to get out of it. If you don't want to improve your operating, if you don't want to be habitual and systematic in the pursuit of your hobby, stay out of the traffic game. You wouldn't enjoy yourself, and the other operators wouldn't enjoy it either!

A primary requisite of the traffic operator is good equipment. We need a sturdy operating desk or table with plenty of elbow room and a good surface, filing systems for correspondence and traffic, message blanks, stationery, a log system containing the essential features and providing for the maximum information with the minimum of effort on the operator's part, a callbook (not more than two years old, hi), some sort of map or atlas showing at a glance the location of every town and hamlet in the U. S., some means of determining frequencies with a reasonable degree of accuracy, a crystal-controlled (or other stable, easily shifted) transmitter with a clean, steady note and minimum control. Power is a convenience, but not a necessity. One of the most important needs of all is a certain amount of "horse sense."

Our first move is to work up our code speed to at least 15 w.p.m. The fastest, most effective method to improve copying ability is to copy (write down) every word we hear on the air. Paper is cheap and, by writing down everything we hear, rapid progress will be made. We must constantly strive to improve our sending, and make calls short and snappy. Having speeded up our code, we thoroughly study all references on "good operating." We learn a few "Q" signals used especially in traffic work, such as QSG, QSZ, QTA, QTC, etc. Once we begin to use these they stick in our memory. The same goes for the important, time-saving abbreviations, like AB, AA, GBA, BQ, RQ, etc. One point to be especially stressed is the importance of using a standard message form. The A.R.R.L. form is simple and covers everything. It is considered the standard form for amateur work by the best operators. We must have some method of numbering our originated traffic. Excellent printed number sheets are available on request from A.R.R.L. Headquarters.

Now that we are prepared for traffic we naturally want

\*117 E. Bacon Street, Waterville, N. Y.

to handle some. We turn on the receiver and proceed to look for some; we get the "listening habit." We hear chaps operating at about our speed, who appear to be good, steady operators. We get together a little circle of these fellows. Schedules are what do the trick. Two or three short daily schedules. Soon we begin to pick up traffic and relay it. We originate good traffic, always with complete addresses. We receive a message for our city or a neighboring town, which we deliver.

After we have become fairly proficient in traffic work at a 15-w.p.m. speed, we may apply to our A.R.R.L. Section Communications Manager for O.R.S. (Official Relay Station) appointment. If we pass the "quiz" and "test," we become what all good traffic men aim at—O.R.S. O.R.S. receive four bulletins from the League Headquarters each year, and may participate in the enjoyable O.R.S. parties.

Now we're ready for an important step. We take the latest QST, and in the Station Activity report for our own or neighboring sections we select two or three operators with fairly good totals. We should look for an O.R.S., R.M., or Trunk Line Station. No doubt we have already heard our choice on the air. We admire his operating technique. We now either work him or write him,

explaining that we are anxious to improve our operating, and would appreciate a short daily schedule. If at all possible, he will gladly give us a schedule and help us all he can. Then we're in with someone who can pass us some good traffic, give us new ideas, correct poor technique, and keep us on our toes for code speed. We solicit his constructive criticism. We ask him to keep just a little above our comfortable code speed. Before many moons we are copying his traffic solid at good speeds with no extra effort. We now look around for more good operators, and schedule as many of them as our time allows.

Soon we are working with Trunk Lines, and other nets which handle good traffic in a snappy and business-like way. We can call our "schedules," raise them on time, and work them in a short time. We can say "R" to a fast message, and mean it. We feel a thrill which comes only with a good job well done. We're learning something! Doing something! Doing something worthwhile with our time on the air!

It's great stuff. One letter from a pleased and grateful person means as much to us who have delivered or relayed their message as a huge stack of QSL cards, or a dozen ragchews. Maybe it isn't natural, but anyway, we're not alone in our opinion!

## DX Notes

IT SEEMS there is always some new thrill awaiting the DX hound .. even though he gets the coveted WAC ticket he still is faced by the "worked all countries" angle .. Foremost in the minds of DXers at the moment is the Seventh International Relay Competition .. reach for your February QST (page 34) and line up for the fun .. there are several new features this year, which should make things even more interesting .. the "band credit," mounting rapidly with the number of bands used offers great possibilities .. this season the 3500-kc. band has opened up for real DX, recalling its 1924-1925 trans-ocean value .. with scores of foreigners working 3500 kc. don't overlook that band in the contest .. You old-time DX men, remember that an elusive country you have long been laying for may pop up in the "Seventh International" .. Says W6CUU: OM1TB uses a self-excited transmitter and will usually be found in the vicinity of 7100 kc. .. VQ4CRL is heard daily with T8 signal on 14,145 kc. .. W1AHK reports that SX3A, Athens, Greece, has moved into the 7 mc. and works on about 7060 kc. with 500-cycle note .. W1AHK worked him January 9th at 4:45 p.m. E.S.T. .. he says CT1ZZ and SX3A are "side-by-side" .. W1FH, W1CMX, W1EWD report FB8C, Madagascar, coming through on about 14,300 kc. with chirpy d.c. note .. A card from FB8C tells that he has been on the air since April 2, 1934 .. he uses only 8 to 10 watts input on 7 and 14 mc. .. and maybe he doesn't get the DX!! .. full QRA: F. P. Bour, Faravohitra, Tananarive, Madagascar .. For a guide on "when to work 'em" as an aid in the coming tests we refer you to the DX Time-Table, page 12, March, 1934, QST .. being a year old this may not be strictly accurate, but it certainly should prove a valuable supplement to the knowledge you already have .. ON4AU and CT1BY are on 28 mc. daily looking for contacts .. W6CXW has WAC'ed 230 times from January to December .. that sounds like a record .. CXW avows that ON4CSL in Belgian Congo can be heard around 14,390 kc., near d.c. or d.c., almost any day .. ON4CJW breaks through with consistency on 14,400 kc., T9 signal .. VQ8A with chirpy d.c. comes through nicely about 14,300 kc. .. near him VQ4CRP can be heard T9 .. ZD2C in Nigeria comes through plenty loud about 14,310 kc. with p.d.c. signals .. For those W6's interested in South African QSOs a few ZE's and ZS' are coming through .. ZE1JB, ZE1JF, ZE1JJ, between 14,250 to 14,300 kc. .. Most ZS', ZT's and ZU's come through about this same frequency .. all the aforementioned break through around 11:30 a.m. P.S.T.

and continue until past 1:00 p.m. .. Thanks for all this FB dope, W6CXW .. W7BB schedules ZS2X daily .. On Sunday, January 20th, W2BSR hooked Andorra, between Spain and France, PX1AA, who is the only ham there .. 14-mc. band, and a.c. note.

## Melbourne Centenary DX Contest

The following scores of Australian participants in the Centenary DX Contest, held during October, 1934, were received by radio at W9DMA, Caledonia, Minnesota, from VK2EL at 3:50 a.m. C.S.T., January 24th: VK3MR 100,320, VK3GQ 97,218, VK3JQ 56,666, VE4BB 53,097, VK2LZ 48,488, VK7RC 43,076 VK3KX 43,010, VK3HL 40,181, VK4EI 37,980, VK2ZC 32,004, VK3HK 26,163, VK3JJ 23,809, VK3ER 17,157, VK7JB 16,860, VK2HY 15,050, VK6SA 14,475, VK2OJ 11,074, VK5WJ 10,548, VK3BQ 10,222. There are other scores, all under 10,000, which still remain to be checked. Amateurs in 45 countries are known to have participated in this contest. Logs have been received from about 30 countries so far. VK3HL is winner of the special Handicap Prize, points per watt—40,181 points, 23 watts. The prizes: VK3MR, one 852; VK3GQ, set of Siemens meters; VK3JQ, one 800; VK3HL, range Philips tubes.

From the "Amachewer," paper of the British Columbia Amateur Radio Association: Two Vancouver hams went WAC in December when VE5HC hooked ZS2X about 9:00 a.m. one morning, and VE5BI snagged the same lad 24 hours later .. this to the best of our knowledge makes three VE5's WAC, VE5AW having attained his some years ago .. South Africans are coming through regularly on 14 mc. around 2:00 p.m. E.S.T. .. Occasionally "J's" are worked from the East coast about 8:00 a.m. E.S.T. .. From November to January W1GF, W1AJA, W1CH and W8CJJ each worked J2JJ between 4:00 and 5:00 p.m. E.S.T. .. J2JJ's frequency is about 7145 kc. .. Numerous contacts between Japan and the East coast are taking place from about 4:00 to 6:00 p.m. E.S.T. on 14 mc. .. In early February W1EWD worked J2HG at 6:00 p.m., the J being on about 14,350 kc. .. W1AVJ reports hearing J2JM at 4:00 p.m. on about 14,075 kc. .. See "Calls Heard" for a list of stations worked by J2HG .. his rig uses a 210 final with about 20 watts input; antenna is a 30-foot Hertz; his receiver is a homemade 8-tube super .. J2GX, J2HJ, J2GW and J2JJ, classed as "high power" by J2HG, are all located within about one mile of him .. result—QRM! ..

W1BPX and W8CRA have been two of the most consistent stations heard by J2HG ..

### 1935 R.E.F. Cup Contest

Refer to February *QST* (page 47) for complete details on the international contest announced by the "Reseau des Emetteurs Francais" on the occasion of the 10th anniversary of that society. This contest starts at 0000 Greenwich, March 24th, concluding at 2400 Greenwich, March 31st. Points will be scored for each contact established with an amateur station located in France, its colonies or its protectorates (all F and CN prefixes), only one contact permitted with a given station. An award will be made to the highest scorer in each country.

### 3500 kc.

The 3500-kc. band is commanding much of the DX interest at this writing, both c.w. and 'phone .. W1BES worked PA0ASD on 3990-kc. 'phone, January 26th, at midnight, E.S.T. .. F8VP has a 'phone on the band and is attempting two-way 'phone contact .. W9OAG, Leavenworth, Kansas, heard SU1AQ, Egypt, at 9:17 p.m. C.S.T., January 16th .. that tells its own story about "30-meters" .. Via W1TS comes word that D4BAR has QSO'ed all continents but South America on 3.5 .. K6DV (crystal d.c.) has been coming through on 3750 kc. at 6:00 to 8:00 a.m. E.S.T.—W8EUI worked him .. so did W5BDX .. Palestine reports once more Myron Goldstein of Tel Aviv, Palestine, reports via letter to WIDTJ on results he is having in logging 'phones on the 3.9-mc. band .. on December 9th he logged W2AGA and W9MM .. on December 24th he heard W1BR, W2MO, W1BES, W1AJZ, W8KIR, W3DQ and W4LU .. all these stations were heard around 11:00 p.m. E.S.T. .. W1AFO has also been heard in Palestine on 3.9-mc. 'phone .. Re list of foreigners getting across the pond (page 49, Feb. *QST*) add: D4CAF, F8ZZ, ON4VO, OK2PH, OK2HX .. Add "W-VE" c.w. gang working Europeans on 3.5: W1KU (12 watts input!), W1COI, W1FFK, W1QV, W1ERQ, W1DUB, W1BKG, W1BVR, W2UL, W3GS, VE1EP, W3BWT, W8AQE, W8EOA, W8FIP, W8ECR (11 watts!) .. G2NM says when conditions improve enough he is going to give the gang a chance to work a "G" 'phone .. W1SZ has worked G6RB as early as 6:30 p.m. E.S.T., and maintained a regular early evening schedule during January with G6RB and G2NM .. From December 9th to January 9th, G6RB had completed over 100 contacts across the pond .. Heard on 3500 kc. on the Yucatan coast by Bob Wilson, W1YU/KHMZA, on January 19th between 7:00 and 9:00 p.m.: W5BMI, W4WA, W9AUH, W8AQ, W4AEP, W9PUP, W9BLZ, W9IU, W4NC, W8KKG, W8EUY, W1QP, W9BAZ (R9 and best of bunch!), W1MK, W3ANT, W1HEX, W9ARH, W8ELO, W1BVR, W8LTD, W1FL, W9JRK, W2EYQ, W4BOU, W1SM, VE2AX, W9LLE, VE2BU, W4AG, W8E2T, W9EIO, W4APU, W2JB, W5ARV, W1ALG, W3SN, W4AEBY, W9IUW, W1TS, W2EYS, W9LGR, W8DMF, W9TGT, W5KC, W3BAI, W9DAZ, W9QX, W8MOI, W9MN .. this dope came via radio, KHMZA to W1SZ.

1.75-mc. DX tests with Great Britain continue through March. United States and Canadian hams transmit on the hour and half hour for a fifteen-minute period calling "CQ-G," beginning at midnight and ending at 2:00 a.m. E.S.T., Saturday and Sunday mornings. The British stations will transmit during our listening periods, or from the quarter hour to the half and from the three-quarter to the hour. British stations call "Test USA" and will be found between 1715 and 1800 kcs. More "Gs" will be found on the air for the Sunday morning schedules than for Saturday morning.

## BRASS POUNDERS' LEAGUE

(Dec. 16th-Jan. 15th)

Call	Orig.	Del.	Rel.	Total
W6EPL	289	311	1164	1764
W6BMC	9	36	1670	1715
W9ILH	15	114	1568	1697
W3ANT	228	1152	312	1692
W9RYD	139	243	1230	1612
W2BCX	136	90	1347	1573
W6JK	49	52	1442	1543
W7BB	374	446	361	1181
W8GUF	33	35	1092	1160
W9IQI	396	143	585	1124
OM1TB	250	117	751	1118
W3SN	229	119	762	1110
W3ESA	122	172	792	1086
W8JTT	73	74	928	1075
W5CEZ	127	178	762	1067
W5MN	41	152	818	1011
W9KJY	70	147	760	977
AC2RT	367	203	360	930
W3BND	59	739	116	914
W2DQH	28	32	304	864
K6LBB	815	8	18	841
K6JFT	520	42	278	840
W6GQC	69	50	716	835
KA1LO	468	342	360	810
W8FLG	37	50	720	807
W5BMI	20	84	684	788
W9MZZ	52	21	712	785
W8KWA	9	45	706	760
W6CXK	214	524	758	758
W3OK	342	36	514	692
K8FAB	249	23	418	690
W9IOL	31	41	596	668
W8KGO	20	77	568	665
W7WY	14	50	569	633
OM2RX	139	101	589	629
W8AEQ	75	45	495	615
W8PFA	17	21	576	614
W6LFG	155	173	256	584
W9RIZ	53	52	476	581
W6CVF	87	435	32	554
W6LIE	39	86	427	554
W3ADM	12	35	487	534
W9IEL	63	56	412	531
W7UJ	25	150	353	528
W9JID	28	236	258	522
W9DI	33	28	458	519
W9BMA	117	166	228	511
W9FWW	37	64	426	511
KA1SX	215	180	114	509
W9QOV	156	60	293	509
W9DMY	239	221	48	508
W3BWT	119	92	294	505

### MORE-THAN-ONE-OPERATOR STATIONS

K6EWQ	257	230	2117	2604
KAIHR	1132	602	624	2358
W9BNT	642	658	910	2209
W6ZG	633	1108	338	2079
W3CXL	218	127	1284	1829
W9OW	110	422	542	1075
W7LD	45	35	681	761

These stations "make" the B.P.L. with totals of 500 or over. Many "rate" extra credit for one hundred or more deliveries. The following one-operator stations make the B.P.L. for delivering 100 or more messages; the number of deliveries is as follows: Deliveries count!

W6EFK, 172	W9RQY, 125	W1MK, 103
W6BPU, 171	W9RQE, 121	W6CII, 101
W6EDW, 138	W6LBE, 117	A.A.R.S.
W9HMM, 136	W8CIO, 110	WZAL (K5AF), 160
	W9GNK, 108	

### A.A.R.S. STATIONS

Call	Orig.	Del.	Rel.	Total
WLMG (W2BZZ)	30	9	1728	1767
WLH (W4KV)	35	137	842	1014
WLME (W9RYD)	99	45	682	826
WLNF (W2BCX)	29	39	508	576

### MORE-THAN-ONE-OPERATOR STATIONS

WLM (W3CXL)	469	448	4126	5043
WVQB (K6EWQ)	689	275	1301	2265
WLIV (W8ZG)	218	334	294	846

A total of 500 or more, or just 100 or more deliveries will put you in line for a place in the B.P.L.

## O.B.S.

The following is a supplement to the list of A.R.R.L. Official Broadcasting Stations in October *QST* (page 49): W2BNJ, W3EEY, W4ASR, W4BBV, W5AEH, W6AM, W8AQ, W8HMS, W9QH.

# B. C. Hams Prove Their Mettle

THE heavy snowstorm of January 20th and 21st, brought to British Columbia hams one of the greatest opportunities to prove themselves, that has ever been placed before any section. Between the afternoon of January 20th and early morning of January 21st more than two feet of snow fell over the Pacific Coast. This was followed by a week of continued rain and sleet storms. By noon of January 21st, Vancouver was isolated and had only one power line to supply electricity. All railway lines into Vancouver were completely blocked and remained so for nine days.

An emergency existed—and how! Due to the lack of local transportation, a good many hams, unable to get to their work, went on the air Monday afternoon. The extent of the disaster soon became apparent when QRR's were heard from all over the province.

From Prince George, B. C., VE5FG was urgently trying to get information regarding a plane on a mercy flight. Caught in the storm it was overdue and great anxiety was felt for those on board. VE5HC contacted him and from then on maintained a daily schedule with VE5FG taking and giving information for the rescue planes. At the same time railways without communications, called on the hams to get information regarding overdue trains; papers without news asked amateur aid; brokers frantic for news of eastern markets, begged for quotations; and the general public, anxious for news of relatives and friends added their bit to the avalanche of calls.

B. C. hams responded with vim. At first contacts were made with Seattle and other points in Washington. The boys on 1.75-mc. 'phone, contacted Vernon and Pentiction. Due to skip distance Vancouver stations VE5FN and VE5AS contacted VE5BL, Parksville and VE5BR, Savary Island, who relayed to VE5KN, Vernon and VE5DC, Pentiction.

In the evening of the 21st the Island Net on 1.75 mc. was having its usual nightly session when it was advised that CJOR, a broadcast station was making an appeal for the police station in Kamloops to get into immediate contact with the Vancouver police station. VE5BR, using his official police call, CZC, contacted CZF at Pt. Grey and learned that lines were down and that communication with Kamloops was urgently needed to locate some lost trains. CZF was requested to 'phone the contents of the message to VE5FN, who was in the 1.75-mc. net. VE5FN passed the message along to the net members, who succeeded in raising VE5KN; VE5KN put the message on the wires for Kamloops and had a reply in less than half an hour. A bit later VE5DC came on with another message, which was shot into Vancouver via the trunk line, VE5BL and VE5FN, and a reply message secured. Messages flowed incessantly over the 1.75-mc. net every night for a week, more stations joining nightly. The following cooperated in handling messages on 1.75 mc. VE5BL, VE5AS, VE5FN, VE5KN, VE5DC, VE5EK, VE5DE, VE5MK, VE5HY, VE5BY, VE5HU, VE5FL, VE4DC, VE4OF, VE5FT, VE5DO and W7CMB. VE5BL, VE5AS and VE5FM acted as a continuous chain between VE5BR and Vancouver. VE5BR acted as a connection between 3.5 and 1.75 mc. The VE5BL-VE5AS or VE5BL-VE5FN tie-up operated continuously from 9:00 a.m. until long after midnight practically every day. On the 23rd VE5DE opened a circuit to Seattle via W7CMB and W7CXR, and much traffic was handled.

Tuesday, January 22nd, A.R.R.L. S.C.M. Town, VE5AC, got busy and lined the boys up. Schedules were reported to him and railway and telegraph officials put in touch with the proper stations. His own station, VE5AC, went on at 8:30 a.m., contacting VE5NK, and VE5FT of Vernon. Schedules were maintained handling urgent railway traffic until skip distance put an end to them in the early evening. Further schedules, however, were arranged for the next day. In the meantime 3.5-mc. 'phones were busy handling urgent orders for supplies and getting more train information. VE5JB, Jack Bain, engineer of the Sound Department of Northern Electric Company, relayed important traffic to VE5GT at Prince Rupert via VE5DO at Pentiction.

VE5BY, Alberni; VE5BK, North Vancouver; VE5BJ, Vancouver; VE5BR, Savary Island and others all did yeoman service in relaying urgent orders and messages. On 7 mc. VE5HC and VE5EU were contacting Calgary, passing urgent telegrams and railway messages to VE4LX and VE4FI. Later in the week they handled stock quotations. VE5GF operated by VE5EP of Vancouver, maintained a schedule with VE4HM at Edmonton, handling urgent messages and stock quotations.

Wednesday, January 23rd, saw no let-up in the conditions. Rain continued, turning snow into ice and slush. Huge rotary snowplows worked hard to get to marooned trains. Wire communication was impossible as slide after slide carried away temporary lines and the last vestige of remaining wires. VE5AC put in fourteen hours with VE5NK at Pentiction and VE5FT at Vernon handling urgent traffic which dispatched food to snowbound trains via plane. VE5FM of Vancouver handled press dispatches to Seattle for the Canadian Press. VE5KU was handling urgent traffic with Washington stations. Further details on December and January work of B. C. amateurs in emergencies next month.

## Operator License Exams

The Inspector in Charge of the F.C.C. office at Dallas, Texas, announces that during the first half of the year 1935, examinations for operator licenses will be held beginning at 9:00 a.m., C.S.T., on the dates shown at the following points: Dallas, Texas: 464 Federal Building. Examination days—Every Tuesday and Friday (national holidays excepted).

Oklahoma City, Okla.: Civil Service Room, Post Office Bldg. Commercial exams—May 10th. Amateur exams—May 11th.

San Antonio, Texas: Civil Service Room, Post Office Bldg. Commercial exams—March 8th, June 7th. Amateur exams—March 9th, June 8th.

Applicants are requested to notify the Dallas office in advance of the place and date of the examination at which they expect to appear.

## China's Domestic Regulations Prohibit Traffic

China is now enforcing regulations prohibiting the handling of either domestic or international third party traffic. The following information was received by radio from XU2RT via W6CUU under date of February 2nd: "CHINESE GOVERNMENT ENFORCING REGS PROHIBITING HAMS HANDLING THIRD PARTY TRAFFIC PLEASE NOTIFY ALL INTERESTED PARTIES NO CHINA TRAFFIC CAN BE ACCEPTED BY XU2RT FROM NOW ON STOP THIS REGULATION IS NOT ONLY CONCERNED WITH INTERNATIONAL BUT INCLUDES DOMESTIC ACTIVITIES ALSO STOP WE SHALL STAY ON THE AIR AND HOPE TO QSO ONLY FOR RAG CHEW BEST 73 REGRETFULLY—GANG XU2RT." China has never ratified the Madrid treaty. This gives us the right to handle all the traffic we want with China. But now China's domestic regulations stand in our way. XU2RT has been particularly outstanding in message work during the past couple of years, providing an excellent service for Americans in China.

The Annual Hamfest of Kalamazoo Amateur Radio Club will be held March 2nd in the Physic's Building at Western State Teachers College, Kalamazoo, Mich. Attendance is expected to be well in the hundreds. There will be demonstrations, movies, lectures, refreshments and plenty of prizes. There will be everything that goes with a real hamfest and *there is no registration fee!* Now can you miss it!

W8CGU, President of the Oneida (N. Y.) Amateur Radio Transmitting Association, is sending code practice on 1847 kc. at 9:00 p.m. EST, every Monday.

## VO Calls Changed

For licensing purposes Newfoundland and Labrador is now divided into six districts. Call letters have been changed in line with the new districts. In the following list of licensed stations, the old call is given in parenthesis:

VO1B (old VO8B), VO1H (VO8H), VO1P (VO8HK), VO1W (VO8W), VO1X (VO8X), VO2J (VO8AW), VO2O (VO8O), VO2S (VO8S), VO2Z (VO8Z), VO3R (VO8AE), VO4K (VO8K), VO4Y (VO8Y), VO6Q (VO8WG).

# Attention All! The Board Meets! Facts and Figures and Your Opinions . . . Please

THE next meeting of your A.R.R.L. Board takes place in May. Each Director wants to hear from *all members* in his Division, on *every* subject of concern to members in the pursuit and enjoyment of amateur radio. This is necessary so he can best represent the wishes of the majority in all things considered at the meeting.

At the last Board meeting instructions were given to conduct a survey of operation on all amateur bands. During late 1934, 150 A.R.R.L. Official Observers accordingly conducted a station distribution survey; just as in 1931 when a similar "census" was taken to determine actual operating conditions. The population of each band as to the total number of stations observed, a "counting of noses" ('phone-c.w. occupancy) and the relative congestion index for each band were determined. Following the previous survey, every amateur was asked to "register" his use of amateur radio, at the same time giving his Director his opinions and requests, by means of a QST questionnaire.

This season it is planned to do the same thing

to help secure nation-wide and Division-wide data for your Director. It is impossible for us to anticipate *all* the things you will ask your Director to bring up—when you write him. The best we can do at this writing is to ask you to *register your use* of the amateur bands, by pasting the coupon on a postal card (or jotting down your "vote" on each point on a postal), and mailing same to A.R.R.L. Communications Department, West Hartford, Conn., so our survey may be tabulated by Divisions to show a cross-section of actual amateur operating needs.

*How can your Director do what YOU want unless he knows your particular operating interest, and unless you give him a full expression of your wishes and opinions? Write your Director fully before the Board meeting. RETURN THE INFORMATION ASKED BELOW RIGHT AWAY WITH ANY OTHER COMMENTS OR EXPRESSION YOU WISH BROUGHT TO THE ATTENTION OF YOUR DIRECTOR.*

Address to  
A.R.R.L., 38 La Salle Rd., West Hartford, Conn.

Call signal. . . . . City and State. . . . .  
I am estimating below as nearly as possible my PERCENT OPERATING TIME on one or more of the amateur bands, as indicated below:

- |                           |   |  |
|---------------------------|---|--|
| 160 -meter 'phone . . . % | A.R.R.L. Member <input type="checkbox"/>  | N.C.R. Member <input type="checkbox"/>   |
| 160 -meter c.w. . . . %   | Newsstand Reader <input type="checkbox"/> | A.A.R.S. Member <input type="checkbox"/> |
| 80-meter 'phone . . . %   |   |  |
| 80-meter c.w. . . . %     |   |  |
| 40-meter c.w. . . . %     |   |  |
| 20-meter 'phone . . . %   |   |  |
| 20-meter c.w. . . . %     |   |  |
| 10-meter 'phone . . . %   |   |  |
| 10-meter c.w. . . . %     |   |  |
| 5-meter 'phone . . . %    |   |  |
| 5-meter m.c.w. . . . %    |   |  |
| 2½-meter 'phone . . . %   |   |  |
| 2½-meter m.c.w. . . . %   |   |  |
| 1¼-meter 'phone . . . %   |   |  |
| 1¼-meter m.c.w. . . . %   |   |  |

Total 100%

I am checking additional information to indicate my interest and views:

(Supplement by further written expressions where necessary)

1. Regarding moving the U. S. A. 14,150-14,250-kc. 'phone band to either end of this amateur band, I am  
In favor   
Opposed
2. IF IN FAVOR (Q1), this change should be made  
At Once   
Only when the Canadian 14-mc. 'phone band can be changed at the same time
3. IF IN FAVOR (Q1), I would prefer the new 'phone allocation to start at  
The 14,000-kc. end   
The 14,400-kc. end
4. Regarding more frequencies for 80-meter 'phone, I am  
In favor   
Opposed
5. Regarding opening a portion of the 40-meter DX band to 'phone, I am  
In favor   
Opposed
6. IF IN FAVOR, which portion (kcs)? . . . . .
7. IF IN FAVOR (Q's 4 and/or 5), where would you put stations thus displaced? . . . . .

## O.R.S. Break Records in January Party

The quarterly Official Relay Station QSO Contest (Jan. 19/20) proved a record breaker in many respects. Conditions well nigh perfect, practically all O.R.S. on the job! In addition to the O.R.S. Trophy Cup, a milliammeter (any range) was offered as second prize and in addition there were Section prizes in Virginia, West Virginia and Kentucky, all contributed by O.R.S. and for O.R.S.

The W9AUH Trophy cup will be given permanently to any O.R.S. winning it three times. The cup was well defined by John Huntoon, W9KJY, who was first to get his call inscribed under the title—but the new winner is R. C. Berry of W9MN. In 30 hours he made 147 O.R.S. contacts in 51 different A.R.R.L. Sections netting him 37,128 points. Thus the second call to be engraved on the Cup was decided. See photo of this beautiful trophy, page 55, December QST. The next O.R.S. Contest will be held April 27/28, and all are eligible who have qualified as O.R.S. (S.C.M.s whose addresses are given on page 5 make these appointments in each Section) before the contest dates. E. F. Henning, W5MBI, gave Berry his toughest competition in the race for leadership, and W5BMI wins the milliammeter prize with 152 QSOs in 49 A.R.R.L. Sections (36,701 points)!

The "high ten" and, in fact, all scores above 15,000 are of special interest, all representing very outstanding operating work. In the group Kentucky has five stations (she was out for all ten high places!), Connecticut four, Illinois three, and Arkansas, Indiana, Michigan and W. Penna two stations each. Here are the leaders—look 'em over.

Call	ORS QSOs	Sections	Hrd.	Score	Power
W9MN	147	51	101	37,077	450
W9AUH*	154	51	80	36,822*	990
W5BMI	152	49	114	36,701	200
W4NC (A1)	157	48	47	33,696	500
W1MK*	160**	46	53	33,120*	900
W9IU	136	49	79	32,144	80
W9ILH	137	47	35	30,986	400
W9ETT	128	46	80	29,210	700
W9AZ	132	43	79	27,305	900
W8NF	138	43	54	27,176	250

Call	QSOs—Pwr.	Score	Call	QSOs—Pwr.	Score		
W8SN	140	26,334	W5BED	99	120	20,319	
W9KJY	118	50	25,327	W8DWB	113	82	20,017
W9OX	120	100	24,026	W1TS*	104	700/150	19,639
W8AQ	105	180	22,140	W9EMN	102	90	19,475
W1DMD	107	200	22,074	W8GUF	99	50	19,305
W4BOU	120	80	22,017	W8EET	99	60	19,071
W9JRK	107	63	21,645	W5CPB	74	125	17,985
W1UE*	115	105	21,096	W8FYF	80	100	17,380

W5AJF	103	100	20,988	W4AGS	85	60	16,020
W8HUD	109	35	20,664	W3ADE	78	100	15,552
W8KKG	105	200	20,514	W1EWD	101	150	15,330

## O.P.S. Shatter Previous Scores

Also in January, the activities of the Official 'Phone Station group reached new high levels. V. L. Madill, W9HSF, Muncie, Ind., has the distinction of being "QSO King" through his station performance. 25 QSO's, with stations in 16 different A.R.R.L. Sections, brought him the "new high" score of 2032 points, more than twice that which W8IKZ (Michigan 'Phone Activities Manager) made in the previous quarterly A.R.R.L. national 'phone activities.

The record made by leading stations is of interest and is as follows:

Call	QSOs	Section	Hrd.	Score	Section
W9HSF	25	16	2	2032	Ind.
W9AED	19	12	7	1308	Iowa
W3BIG	18	9	17	1296	Va.
W8IKZ	23	10	4	1230	Mich.
W9ACU	14	10	15	950	Ill.
W9WC	14	9	8	774	Ill.
W9LIV	8	7	13	492	Ind.
W3CNY	9	7	10	455	Va.
W8ICF	9	7	10	455	Ohio
W9ITA	9	7	10	455	Ill.
W8CSX	9	7	2	343	Mich.
W9LXN	8	5	9	290	Ky.
W8FYF	6	5	11	260	Neb.
W8FEE	8	6	1	252	Mich.
W2DC	8	6	4	248	E. N. Y.
W1IDY	8	4	6	208	N. H.
W8AYA	6	5	2	170	Penna.
W7ARK	6	5	..	150	Utah-Wyo.

\* Not eligible for O.R.S. Trophy Cup.

\*\* Most QSOs in contest.

## Briefs

W6GXM has presented a complete outline of amateur radio service available to the Los Angeles Police Department. In offering the services of amateurs, W6GXM said, "Objects in view are to supply police information on wanted persons, criminal and missing, and other matters which are not of a secret nature to the various cities and towns which are not connected with teletype systems. Also in time of disaster or extreme emergency to offer the services to replace wire service."

Add father-and-son schedules: W8BRJ (father), "YB," Sgt. Beatty, W3CXL, son.

You  
are urged  
to register your  
use of amateur radio  
and to  
express your opinions.  
Clip the  
coupon (over). Paste  
it on a postal card or  
copy on a postal (numbering  
replies) and mail AT ONCE  
to A.R.R.L., West Hartford, Conn.

## Station Activities ATLANTIC DIVISION

**EASTERN PENNSYLVANIA**—SCM, Jack Wagenseller, W3GS—RM 3EZ 3OK and ADM make B.P.L. CL reports ECI and EZX on Naval Reserve cruise. CIQ is back on the air after a long silent period. 8LYH is at C.C.C. under WVHT call. 3ADE reports radio club being organized in Harrisburg. EZ, CL and BY8 are working on a State Traffic Net. 8EU is back on again and has taken his O.R.S. out of cold storage. ASW is in the new daytime Army Net. 3EDA, ECD, and 8DIG report via radiogram. 3EPJ joined the A.A.R.S. BY8 has been appointed O.O. EEY and BET have been appointed O.B.S. 8FKO was heard in Europe on 3.5 mc. with '46 final. 3AQN has new rig with '03A final. MG is lined up for O.P.S. 8LWF is stepping out with new schedules. Traffic handled by Beacon Club members: 3BGD, CCD, DLY, VF, BUK and DYL was reported by traffic mgr., EER. EOP has new antenna. 8LRI has 56-mc. receiver but is too far away to hear anything. 3AKB phoned report and delivered OK's and 8DIG's. 3VR reports via radiogram. AMD is head man in the new daytime Army Net just organized in this Section. ACF and GS are working very successfully on 112 mc. GS worked D4BAR and D4BDR on 3.5 mc. Announcing a new and FB club, the Delmont High Frequency Club. Quota 25 members, all 56 mc. men from Delaware and Montgomery counties; meetings every other Friday and over the air on in-between Fridays. EGA plans 35-foot tower for roof. DYX got R5 from a W7 on 3.5 mc. with 9 watts input. Due to misplacement of telephoned reports, 3AKB's total of 293 and 3OK's total of 636 were unintentionally omitted from last month's report.

Traffic: W3OK 692 ADM 534 AKB 484 EJZ 304 CL 272 ECD 163 BY8 129 EOP 86 7G 73 EPJ 69 EDA 53 CIQ (VR 29) 21 ADE 7 BGD 7 MQ 4 EER 4 CCD 2 DLY 2 VF 1 BUK 1 DYL 1. W8PLA 139 1WT 98 FKO 71 DIG 55 LYH 23 BFF 34 LRI 4 EU 3 ASW 3.

**MARYLAND-DELAWARE-DISTRICT OF COLUMBIA**—SCM, Edgar L. Hudson, W3BAK—3CXL, 3CQS, R.M.'s; 3BWT, Chief R.M. On March 2nd the second annual hamfest of the Delaware Amateur Radio Club will be held in Wilmington, Del., in the Gold Ball Room of the duPont Hotel. A gala affair is planned. A thousand dollars' worth of prizes. Dancing. No speeches in the evening. Afternoon program. Tickets, \$2.50. Special price of \$2.00 if tickets ordered in advance. CXL has nice totals due to Christmas rush. BWT worked ON4DG and F8ZZ on 3.5 mc. CMS worked all dists. with '45 in final on 3.5 mc. ABA is working west coast on 3.5 mc. EOG wants more schedules. BKZ has worked 47 states. BAK handled emergency traffic during sleet and wind storm on Jan. 23rd. CDG using '52 now. OZ/EHW is working plenty DX. EYX has lots of B.C.L. trouble. DRE built a 224-mc. transmitter and receiver which works. CDQ spent two weeks in Cuba and Fla. BHE is having bum luck with 28-mc. receiver. ECP is back in hospital. CTD is in Balto Hospital.

Traffic: W3CXL 1629 (WLM 5043) SN 1110 BND 914 BWT 505 ASO 307 CMS 145 ABA 131 CIZ 117 EOG 59 BKZ 58 BAK 33 DUK 27 DML 19 CDG 17 EDS 13 OZ/EHW 11 EYX 4 DRE 2.

**SOUTHERN NEW JERSEY**—SCM, Gedney Rigor, W3QL—NF plugged hard in new O.R.S. contest. CYI received his O.R.S.; he and R.M. APV did good work for the Good Will fliers, who were forced down in Santo Domingo on the 18th of November. APV reports that the Atlantic Radio Club is preparing for big hamfest at Boardwalk Hotel in March. ZI's signals came through FB on 3.5 mc. down to Port Arthur and back again. EDP worked his fiftieth country and has been on the air only a year. DNU reports new ham FDO, in town, and is working across the country with ease. AEJ finally went 56-mc. 'phone, nertz. ENB sends in a fine first traffic report from Atlantic City. DBD is building a low-powered e.c. portable for section operation. BVE is now W.A.C. EYH applied for O.R.S. ticket. QL has new MacKey. BEI

has new QRA and will be on regularly again. VE has moved to new QRA. DQO wins his O.R.S. ticket from Millville. The Greater Camden Radio Ass'n elected officers Dec. 11th: DAJ, pres.; DEK, vice-pres.; CMR, cor. secy.; BPH, rec. secy.; BYK, sgt.-at-arms; directors: AYZ, AAY, CLO, BCW, TR, BDF and ASG. Anyone in the Section interested, write to CMR. The S.C.M. must with regret leave his duties as the top dog. I thank each and every one of you fellows for your loyal support and hearty cooperation; without your support and help, the S.C.M. couldn't do a thing. 3ZX has taken over the reins until the election of a new S.C.M. The reason that QL resigns is because of being EDP.

Traffic: W3NF 30 CYI 37 APV 204 ZI 101 EADP-QL 2 DNU 39 AEJ 1 ENB 19 BEI 6 VE 89 DQO 6.

**WESTERN NEW YORK**—SCM, Don Farrell, W8DSP—JTT carries eleven schedules and is high traffic man! DSS is doing FB work as Chief R.M. KMC is busy with U.S.N.R.—A.A.R.S.; he has new bug. DBX is active on trunk line "G." KBS reports MXC-MUQ hams in Elmira. GWY has some nice schedules. AQE worked some fine DX on 3.5-mc. low power. FYF is 100% A.A.R.S. AYD runs a '52 with 540 watts output. CDK will be O.R.S. soon. CJJ still needs Asia for W.A.C. EBR's new rig is perking FB. GZM keeps A.A.R.S. schedules weekly. MBY wants O.R.S. KGM is rebuilding to rack and panel job. FTB is on daily for O.R.S. traffic. MLM says DX is very good on 1.75-mc. band. BWY is on daily for traffic on 3780 kc. LCT reports traffic for first time. AWX heard ON4AU on 28 mc. BQJ wonders why no traffic on 7 mc. EOA worked F8UT on 3.5 mc. DZF has a net working very FB on 3980 kc. LUJ wants more schedules and traffic. LIJ is handling traffic with K5AG. GWT reports S.T.T.A. is holding QSO contest. HWR is overhauling transmitter; he works on 56 mc. FME is on 3973-kc. 'phone with 200 watts. AXE has new 250-watt rig on the air. LUO reports for first time; likes traffic work. DWJ is operating as portable at Boonville. BGN is busy at WHAM. BEN is on with new RK-20 rig. LGV reports for first time. BJO is with Armstrong Cork Company in Fulton. ERU has 56-mc. beam antenna; he wants schedules. JQV is rebuilding again. MIU and NBJ are new hams in Seneca Falls. KJW can use more good schedules. JLG is still busy building new rig. JTH's traffic was handled on 'phone. MQX and KXA want portable 'phone on 1.75 mc. AOR is operating portable at Plattsburg. MUI works plenty of DX on 14 mc. DCX is active on 7 and 14 mc. GWW is on 7 mc. DEJ is on every afternoon on 3.5-mc. c.w. DSA, HB and Portable 1DZQ are doing very nice work on 56 mc. at Saranac. MAH is back on after month vacation. ELU is busy with A.A.R.S. GPX is on 1.75-mc. 'phone. LKL has new Tritet transmitter. EXT is building new 56-mc. rig. LUZ and IFF were home for Christmas holidays. GWP and MVJ are on 56-mc. 'phone. BR has charge of 75 boys in Rifle Class. The Fort Stanwix Radio Club had a fine banquet on Dec. 23rd and installed new officers. The Mohawk Valley Radio Club will have their new station on the air as soon as their license arrives from F.C.C. Don't forget the Atlantic Division Convention at Syracuse in June, gang. Make your reservations early.

Traffic: W8JTT 1075 DSS 277 KMC 129 DBX 107 KBS 43 GWY 37 AQE 35 FYF 35 AYD 33 CDK 31 CJJ 28 EBR 18 GZM 27 MBY 25 KGM 20 FTB 19 MLM 15 BWY 14 LCT 10 AWX 8 BQJ 7 EJA 7 DZF 5 FMX-LUJ-BEK 4 LIJ 16 GWT-HWR 2 KOW 19 KXA 2. W8JTH 47.

**WESTERN PENNSYLVANIA**—SCM, C. H. Grosarth, W8CUG—GUF has his A.A.R.S. Net working nicely. If you want traffic deliveries in W. Pa., put it on Trunks "A" or "M." KWA makes the B.P.L. at last! Nice work, "Wik." CUG pounded a lot of brass during the last O.R.S. party. KNB has a new universal exciter unit working; welcome to the O.R.S. ranks, OM. ADY has Penna. District 5 working nicely in the A.A.R.S. EZT makes a nice total for a new O.R.S. UK is looking forward to an O.R.S. appointment. AXD suggests FFD for O.R.S. Let's have some reports, FFD. LOQ has a job

which keeps him pretty busy. CMP says he is going to send more traffic thru CUG. JZZ is working A.A.R.S. schedules. CQA says ESR and KYW are rebuilding. 56 mc. looks good up in Warren. KQQ gets R8 and R9 reports in Europe. KOB wants a bigger total next time; give him some traffic, boys; he's a new O.R.S. MOT is another newcomer into the O.R.S. gang. PX works them all on 1.75-mc. 'phone. LIG says DZD works W8' with his 14-mc. receiver and reports a new ham, NBD. FKV worked his first W6 on 7 mc. IOH reports for JZR and INE. KSG is busy with A.A.R.S. and N.C.R. IZD is rebuilding and wants to become an O.R.S. AYA is busy on 3.9-mc. 'phone. GJM says FIP worked Germany on 3.5-mc. c.w. KEW took the Class A exam. The New Year's Eve party held by the S.H.B.P. & M. was attended by 76 hams, etc. IOI has worked all districts on 3.5 mc. JAW thinks 3.5 mc. is the best band. LEE reports these activities in Beaver Valley: JPN and GMG are transceiving on 56 mc. HXZ is having fun on 1.75-mc. 'phone. BPA has an SW3. LEE is using low power on 1.75-mc. 'phone. GKH worked a W4 on 1.75 mc. with 10 watts input. IUY thinks the A.A.R.S. is FB. GSH is going to get some more filter. MEE is going after an O.R.S. appointment. ABS, our able P.A.M., is looking for prospects. FIP worked D4BAR on 3.5 mc. at 10 p.m. FB.

Traffic: W8GUF 1160 KWA 760 CUG 230 KNB 194 ADY 374 EZT 317 YZ (WLMA 267) 112 UK 57 AXD 47 LOQ 36 CMP 31 JZZ 20 CQA 18 MOT 17 KQQ-KOB 18 PX 14 LIG 12 FKV 10 IOH 9 JZR 22 KSG-GSH 8 INE 7 IZD 6 AYA 2 IOI 3 IUY 124 MHE 41.

#### HUDSON DIVISION

**E**ASTERN NEW YORK—SCM, Robert E. Haight, W2LU—BZZ and EGF are our strongest traffic pushers. LU desires QSO's with E.N.Y. hams on 3660 kc. FQG scored "high man" last O.R.S. party. BJA reports young twerps bootleg-operating in Albany. ESO burned out '46-'47-'10 and bleeder. FPH enjoys college life. GTW was visited by 3NF and 3EOP at Tri-States Radio Club. ATM reports FKL and HAN interested in traffic. GPB is on 56-mc. 'phone. HCM scrapped his '45's. UL had F.B. DX QSO's on 3.5 mc.: G6RB, HB9Y, D4BAR. CLL uses 211 final. Christmas tree lights steal r.f. from CC's transmitter, 10 ft. away from set. GNI needs Asia for W.A.C. G2KB listens to his own signals coming from England via W2DC! SZ is on 3.5 mc. for first time in five years. 1GPW works portable at R.P.I. FPP, BKW, and BR5 use 56 mc. HJX was visited by 8MMZ, Poland, Ohio. BC sets out on eight months' cruise. ESO reports QN, HFS, BFB on 14-mc. 'phone. Westchester Radio Club (2GAZ) Hamfest was attended by ICBA, 1APZ, 1HYF, 2AJN, 2GMM, 2CSM, 2FEQ, 2ESO. FEQ sports new Comet Pro crystal filter. DVY leaves 1.75-mc. 'phone for 3.5 c.w. OA on 7 mc. reports HTH and HUE new hams. BLL is back after 25 days' quarantine for scarlet fever . . . his YL had it. Hi. GGP confines activities to A.A.R.S. and N.G. Net. CBN hears plenty European DX. CJS got the gripe. HAN uses 59-'10 amp., 15 watts, 3630 kcs. HMU is on sick list. GTC is back on 3.5 mc. for traffic. Any ham having stamp collection for sale or swap QCO CDD or KW. EHN says police pup causes leakage around transmitter (and not R.F. hi). CJP says ice cuts 3.5-mc. skywire into 7 mc. ACB uses 56 mc. for timing ski races. QY awaits PR12. EGE-GRY is sewed up in exams. Schenectady 56-mc. activities take place 7 p.m. daily, Sat. and Sun., 11 a.m., 3 p.m., 7 p.m.

Traffic: W2EGF 402 LU 225 BZZ 183 (WLMG 1767) FQG 174 BJX 42 BJA 34 ESO 32 FPH 23 GTW 18 ATM 11 GPB-HCM 10 UL-CLL 9 CC 6 GNI 3 DC 2 SZ-BRS 1.

**NEW YORK CITY AND LONG ISLAND**—SCM, E. L. Baunach, W2AZV—DRG operates DSA at N.Y.U. GYV sends first report. HNJ first went on the air Christmas night and is 14 years old. EUZ has s.s. super and Tri-tet. GOW is now O.P.S. EKD has YLitis. AYJ has been rebuilding high-power rig. ATB is QRIL watchmaking. GNO has 50-watt rig. GMI has new SW 3. HGN is doing F.B. with Class B job on 1.75 mc. HXC is new

member of Crystal Wireless League. HWV has 7-mc. rig perking F.B. GEI got the c.w. bug again. CHK has new FBXA. BGO works DX on 3.5 mc. DBQ is making new AT cut crystals. BNJ has 242A final. CDJ reports for Harlem Radio Club. DUP has been organizing a Break-in Club on the air; anybody interested should get in touch with him. AZV's antenna blew down in snowstorm. EYS is getting active on 56 mc. CSO has '03A final on 'phone, 3992 kc. PF is building 56-mc. rig for Brooklyn Polytechnic College. FF is now P.A.M. for this Section. HKO, new O.R.S., is installing facilities for quick band changing. DXO reports N.N.W.A. held annual dinner to install new officers. GAS sends first report. CCD is in the market for U. S. and foreign stamps. AHC, our new Director, received O.R.S. appointment. HYL is new station at 27th Division air service N.Y.N.G. at Miller Field, Staten Island. GES is new Brooklyn station. HBO worked first W4 on 3.5 mc. HHW is rebuilding. GDF revamped rig using link coupling. EZB sends first report in two years. HJK has new rig in bookcase with panels on front. ERH reports for Lenox Short Wave Club, station FPU. FDU is on 56 mc. EFB and GUA hold commercial tickets. FLW's new QRA: St. Albans. FIK is building "Bugs." ARG christened new rig. BXO is out for O.P.S. BNY is building Banehawk receiver. HQB gets out F.B. on 3940 kc. KI operates on 3831 kc. HHD is back on 7 mc. after trying 1.75-mc. 'phone. EVA reports new officers for the Astoria Radio Club for 1935: BTE, pres.; EVA, secy.-treas.; VA, vice-pres.

Traffic: W2CHK 350 BGO 223 DBQ 103 (WLNB 70) BNJ 80 ESK-DUP 41 AZV 36 EYS 32 CSO 24 PF 23 FF-HKO 20 DXO 19 GAS 31 CCD 18 AHC 16 BPJ-BYL 14 ADW 10 BKP 11 WK-CIT 9 GZ 8 ALZ 10 HYL 6 FLD 7 GES-HBO-GNX-GDF-BIK 5 ATU 7 EZB 4 LC 5 HJK 4 ERH 2 EDZ 3 EQU 4 GEI 3 HHD-EVA 1 BII 2 AGC-ASG-BVT 3 EAR 4.

**NORTHERN NEW JERSEY**—SCM, Charles J. Ham-mersen, W2FOP—BCX is high traffic man for second month. DQH is new traffic hound in N.N.J. 3ETX operates 2HXU at C.C.C. camp at Hackettstown. GNK is new A.A.R.S., O.R.S., O.B.S. LK is active on 3528 kc. GGW reports plenty of DX on 3.5 mc. GGE operates on 3.5 mc. with '10s final. DCP would appreciate reports on official broadcasts which he sends Mon., Wed. and Fri. at 10 p.m. GVZ has 400-watt rig on 7 mc. FOP has new job with Public Service. 3EWH has new link-coupling arrangement which gives more r.f. output. 2GWJ is new A.R.R.L. member. CLM has new automatic CQ sender. ECO wants O.P.S. HRN reached 150th QSO. HTZ is ex-3MIA. CTT attends Rutgers Univ. GWJ, ETX, HXU want O.R.S. GUQ, HVH, GJQ, HNX, HED, GFW, report for first time. ABS worked three South Africans on 14 mc. BXM, GNW: On 56 mc. HNX is on 1.75-mc. 'phone. HVH spends most of his time at sea with Merchant Marine. GQX and HSA have tube oscillating on 112 mc. CQX and GNK were visited by 3DOR and 3EXU. GNK, new O.R.S., has nine daily schedules. GJQ met GCG at firemen's ball in New Brunswick. 2HSC of N. Plainfield now has the call 3FBG. Eric Crusier, secretary of Ocean County Radio Assn., Lakehurst, reports for members of that club: FLO chews the rag on 1.75 mc. HHM has new 75-foot tower! HFT pounds brass on 3.5 and 7 mc. Ex-DZW is back after being in Florida. BQV has been experimenting on ultra-highs. AFU needs one more continent for W.A.C. DDV had the gripe. BYM is getting closer to his ambition; he has 750 watts input and only needs 250 more. DYR works 'phone on 1.4, 3.9 and 1.75 mc.

Traffic: W2BCX 1573 (WLNF 576) DQH 864 GNK 196 LK 163 GGW 131 GGE 51 DCP 45 GVZ 19 CJX 26 FOP 23 GFW 13 GWJ 12 GMM 8 CLM 6 ECO-HRN 4 HED 2 HTZ-CIT 1. W3ETX 313 EWI 16.

#### NEW ENGLAND DIVISION

**C**ONNECTICUT—SCM, Frederick Ellis, Jr., W1CTI —MK worked Germany and England on 3.5 mc. GME retains Conn. Banner. DOW keeps Trunk "C" schedules FB. HYF is working on a 2 p.m. State Net. BDI installed circuit breaker. GKM hooks into Ca-



nadian Trunk. DBU schedules Ellsworth Expedition in Antarctic. 8DHU-1 will soon be using his W1 call—W1AMZ. IQV worked D4CAF on 14, 7 and 3.5 mc. CJD was laid up with gripe. TD rebuilt feeders. DEP will have crystal soon. TS worked D, G, F, OK, HB, ON on 3.5 mc. APW was QSO ZTIR ('phone-c.w.). GTW is on 7018 kc.-2A5-'46-RK-20. CEJ was QSO G6RB and HB9V on 3.5 mc. DLX reports AFG in Good-year, Conn. BFS is back on the air after long lay-off. IIS sends in first report. BNB is experimenting. IKE expects to burn the pants off birds on his antenna with new rig. HTS applied for O.R.S. HKF sends in dope on the Wallingford gang. All O.R.S. receive a copy of each issue of the new Conn. Bulletin—"Contact."

Traffic: W1MK 452 GME 368 UE 268 (WLG 7) CVL 242 (WLG 110) DOW 104 HYF 84 HLMN 69 BDI 68 BHM 63 AMG 61 GKM 41 DBU 32 APZ 31 HPI 17 QV-CTI 14 CJD 12 TD 10 DEP 9 TS-APW 5 EWD-GTW 3 CEJ-DLX 2. W8DHU-1 22.

MAINE—SCM, John W. Singleton, W1CDX—BTG is having great results on 56 mc. CRP would like reliable schedule with Boston and New York. OR handles traffic on schedule with U. S. possessions. TE has daily schedule with NYIAB. EZR plans to give 7 and 14 mc. a try. DEX is in line for O.R.S. BNC keeps six schedules per week. FJP has nice 1.75-mc. 'phone. FQU wants some morning schedules. GHK reports for the first time. IJF's new transmitter is now completed. IBM has been appointed O.R.S. CDX has 150 watts on 3882 kc. HUX has new crystal rig on 3562 kc.

Traffic: W1BTG 134 CRP 119 OR 79 TE 57 EZR 39 DEX 36 BNC 35 HSE 34 FJP 27 FQU-DHH 13 AQW 11 GHK 8 IJF 5 IBM 3 FXA 1 CDX 57 HUX 1.

EASTERN MASSACHUSETTS—SCM, Joseph A. Mullen, W1ASI—ASI's work is confined to 56 mc. ABG copped another O.R.S. party. KH visited five clubs and two 'fests during the month. WV completed his 9000th QSO. AGA is keeping schedules with BMW. EVJ lost his antenna in recent storm. BMW's 40-footer blew down in gale. DFS expects to have 1 k.w. at Filene's soon. RE is looking for schedules. BZO is active A.A.R.S. man. FPO is handling T.L. "C." GCL is headed for 56 mc. FRO is still renovating shack. CEL left for the south. LM's working hours won't allow schedules. HKY has new rack job working. SW shut down for school holidays. FNZ and ESI have applied for O.R.S. FKO renovating shack and recd crd fm P.R. as being hrd there on 1.75. FWT has his sister's code coming along FB. DIU is now Chief Op at WMP, State Police station at Framingham. ZK expects to change QRA soon.

Traffic: W1ASI 44 ABG 42 WV 9 AGA 20 EVJ 26 BMW 21 DFS 29 RE 2 BZO 100 FRO 93 FPO 3 LM 13 HKY 17 FMP 9.

WESTERN MASSACHUSETTS—SCM, Percy C. Noble, W1BVR—DLH is stepping right out of this traffic-handing business. BVR got out a West. Mass. Bulletin this month. GZL takes in all the hamfests. APL has been blowing up his new transmitter. ZB is preparing for commercial ticket. FFJ worked D4BBN. IJR is after O.R.S. and A.A.R.S. appointments. BIV, an old O.R.S., is back with us again. ARE is handling nice bunch of schedules. DIE is at C.C.C. camp in Chester. BAP is on 56 mc. five nights a week. GUO is going crystal control. BNL will have a 'phone soon. CTK wants schedules and lots of activity. COI and FFK worked G6RB on 3.5 mc. DVW, chief R.M., has rebuilt transmitter. ADF's first code practice report came from Ohio. BKQ, Worcester Radio Club, invites all interested to its meetings Wednesday nights. CCH is now N.C.R. Liaison R.M. DUZ has a new portable 56-mc. transmitter and receiver. FDB is working the world on 14 mc. HJR, who is now on 7 mc. is planning 1.75-mc. 'phone. IIP has low-power 3.5-mc. rig. EBU keeps daily schedule with 9AWH, Clinton, Iowa, on 3.5-mc. c.w.

Traffic: W1DLH 290 BVR 95 (WLG 441) GZL 90 APL 22 AWW 16 ZB 14 FFJ 13 IJR 12 BIV 10 ARH-DIE 5 BAP-GUO 4 AJD-BNL-CTK 2 COI-DVW 1.

NEW HAMPSHIRE—Acting SCM, Robert V. Byron,

W1AVJ—Due to an active increase in business and therefore a lack of time, APK has to resign as S.C.M. and AVJ, Bob Byron, is now acting as S.C.M. Until further notice send your reports to him at 12 Humphrey Street, Concord. I want to thank the gang for their fine co-operation since I have been in office. Keep the good work up.—Basil, APK. "Doc" BST is now on 1.75-mc. 'phone. ERQ, our R.M., is working DX on 3.5 mc. FFZ reports GPN is building O3A rig. ANS is sticking close to the fire. UN is still handling weather traffic. FCI will be M.O.P.A. soon. HJI, new O.R.S., is back on 'phone. IP has new rig. DMD says RK-23 crystal osc. is very fine. FPL has some reliable schedules now. GEY has winter sports QRM. ILK, St. Paul's School, is on 7 mc. and 3.5 mc. with four ops. AUY is having great time conducting round-table chats of N. E. Division Radio 'Phone Association, Sundays. Keep it up, Henry. IMB is new station at Gleneliff. GKE is putting 1000 volts on pair of '46s (page Mr. Ripley). AVL has YL QRM. CCM reports his YXL now on the air with IQT call. More O.P.S., O.R.S. and O.B.S. wanted. Any good, reliable stations, send your application to AVJ. He will do the rest. ERQ worked D4BAR, DUB worked D4BAR, D4BDR and OK2PH, all on 3.5 mc.

Traffic: W1ERQ 475 UN 122 FFL 116 DMD 80 LGB 72 SK 67 FCI 46 GHT 32 FFZ 28 IJB 21 IDY 10 HJI 9 GEY 8 IP 7.

RHODE ISLAND—SCM, Albert J. King, W1QR—AFO was heard in Palestine on 3.9-mc. 'phone. DTZ has new crystal. GVH has received new "N" call. GOG worked D4BAR on 3.5 mc. WLGK has been assigned to IEG. HRC schedules 2CYX and 1CVL. GTN is rebuilding rig for quick QSY. IMY and IAV want O.R.S. DBF says Zepp antenna is the berries. BES is new P.A.M. Prov. Radio Ass'n has new transmitter, call INM. Traffic: W1HRC 55 GTN 42 GOG 8 IMY 6.

VERMONT—SCM, Harry Page, W1ATF—Watch for the new hams, EKU, Vern Hook in Barre, Vt., and IQG, Alonzo Phillips in Glover, Vt. R.M. BJP entertained VE2EE and VE2FE. AXN/WLGN was an 801 in his final stage and a "split stator" condenser adds the finishing touch to his FB signal. GNF is wrestling with a new "Bug." GAE visited AAJ, AYP, FSV, FSW, and GAZ New Year's Eve. EFC wants O.P.S.; Mac has a new '03A and made a New Year's resolution to increase Vt. activity. DQK sez "all quiet on the border." BD rumbles in his shack! Let's all join EFC in his resolution.

Traffic: W1AXN 54 BJP 34 ATF 25 DQK 20 CGV 10 EFC-GNF 5 GXP 4.

#### ROANOKE DIVISION

NORTH CAROLINA—Acting SCM, N. M. Patterson, W4EG—Greensboro: ZH's long list of DX includes QQ, V1, V3, ZD, ZE, ZS, ZT, ZU, FB, SM and ON! Tarboro: CCH has his rig really squirting juice now. ALK is doing good work as usual on 3.5-mc. c.w. Graham: AEH has new All-Star. CYN is DXing on 7 mc. COC is preparing to build a 1.75-mc. 'phone. CJP is at Wake Forest College. AYA is going steadily. DCU is new ham. CYE, the Club Station, wants to get in 1.75-mc. N.C. 'Phone Net. Concord: DCR gets up at 1 a.m. trying to hook VK. TJ's suppressor grid 'phone has been heard in England and Scotland. Gastonia: CPV says new Tri-tet is working up a storm. Wilmington: BJV leads with traffic total of 198. F.B., O.M. CSA is doing fine work. BPL is trying to hook Germany. FT has QSO'd 63 countries. BKS has been trying to find J2GX, who is reported on 7 mc. The Club Station is now in the N.C. 3.9-mc. 'Phone Net every Sunday morning. ATY joined Coast Guard. VW needs an automatic antenna putter-upper to get his F.B. rig on the air. Raleigh: The Club has new set of officers: ANU, pres.; AOA, vice-pres.; JB, treas.; BRT, secy.

Traffic: W4BJV 198 DW 72 BRK 35 BRT 33 ALK 17 BYA 11 CZD 8 CSA 7 BPL 3 ZH 2 EG 15.

VIRGINIA—SCM, Neil E. Henry, W3BRY—BZE has very F.B. YL!! FJ works hard with A.A.R.S. CA operates 100% C.W. in three bands. CNY has swell 'phone on 3973 kc. CPN likes 56 mc. ECQ is new D.N.C.S.—

VG4-A.A.R.S. GY has new All-Star. UVA has great time on 14 mc. EBD, APU, EVN, EUL and DCU are active A.A.R.S. AAF says all members of Bluefield Club belong to A.R.R.L. DEH has 212D final on 7 mc. WM is building c.c. rig. DVP recently annexed YF. CHE worked Japan four times! ELA is building portable rig. EGD blew power transformer. ELJ has 830 amp. AOT wants O.B.S. BXP works DX on 7 mc. EXQ is new Phoebus station. EPK, DZW, GE, BTR, and CGR are rebuilding. BAN and DQB have new c.c. rigs. EDG worked all W sections on 3.5 mc. twice. ANT says Christmas traffic kept him hopping. BSB wrote S.C.M. FB letter about activity. FBL is building All-Star. BIG wants some 'phone O.O.'s in state. AAJ is building new antenna at WRVA. All O.P.S. should write P.A.M. 3BIG stationing time and freq. they would like for Sunday O.P.S. party. BAD has swell signal on 3788 kc. AVR wants O.P.S. CYW has 800 with 150 watts input. EBM is 200 percent C.W. Hi. BRY has been QRL audit at office. BZ has plenty street-car QRM. DWE was sick with cold. CYM passed Class "A." EZJ is QRL school. BDZ has new 'phone on 3921 kc. AIJ wants afternoon 1.75 mc. 'phone schedules. DWP's new freq.: 7287 kc. BFW is moving station. EVO is on 14 mc. EMX pounds C.W. on 1.75 mc. DAM worked W7. EEL is secy. Lynchburg Club. MQ is on 3595 kc.

Traffic: W3BZE 2 FJ 84 CA 1 CNY 20 CFV-CPN 4 EQ 32 GY 9 UVA 1 EBD 113 AAF 3 DEH 9 BEB 23 WM 5 DCU 17 DVP 1 CHE 138 EEN 19 ELA 24 EGD-ELJ 9 AOT-APU 12 EVN 18 BXP 12 AHQ 42 EXQ 2 EPH 3 EPK 7 DPV 35 BAN 1 EDG 11 DQB 13 ANT 1692 BSB 4 EUL 43 FBL 1 BIG 4 ADJ 3 AAJ 6.

WEST VIRGINIA—SCM, C. S. Hoffmann, Jr., W8HD—Following O.R.S. endorsed for another year: CDV, DPO, ELJ, ELO, HD, OK, TI. ANU and CDV have been ill. BTV operates at LT at college. ELO is installing 800's P.P. P.A. HWT has receiver trouble. DPO is B.C.L.ing on short waves! MCL applies for O.R.S. HD is QRL schedules. EIK's antenna blew down. OK promises A.A.R.S. gang photo of WLHB. TI operates KTU at W.V.U. JM is operator and announcer at police station WPHJ. KXC has gone to Denver. BOK got Class A license. Mountaineer Amateur Radio Assn. meets in Fairmont every second Friday. KIU worked four ZL's and five VK's in one morning! CMJ is on 3700 kcs. DMF was heard in Germany and Austria on 3.5 mc. KWL finds "bugs" in his antenna with 400-ft. feeders. MLX uses '45s P.P. LTC and LTD visited KDP, MSI, KHB and ELJ. ELJ visited MSI. KDP and MCR visited EIK. 4BPC visited MCL. EWM reports "Prof" Andrews having the call, NAU! ELJ schedules 9BWJ and 3CIZ. LTD joined A.A.R.S. LSJ is rebuilding 'phone. MCR is new O.R.S. MZT is new Huntington station. GAD, JWL, MOL use 1.75-mc. 'phone. KSJ uses 3.9-mc. 'phone. The S.C.M. suggests all W. Va. stations send 8GER, A.R.R.L. QSL Mgr., a stamped envelope for returning any QSLs he might have for them. KKG worked HB9Y, OK2RR, D4BAR, D4BDR and ON4VO, all on 3.5 mc! GDF operates XM-8, N.G. station at Terra Alta. KWI QSO's the R.I.! MZI wants to know what country uses the "N" prefix. Hi! JM is building srech amplifier. Hi!

Traffic: W8HWT 22 DPO 10 HD 98 (WLFH 84) EIK 12 (WLHG 15) OK 69 CMJ 3 DMF 6 ELJ 15 KDP 34 LTC 5 EWM 1 LTD 13 KWL 1 LSJ 8 MCR 19.

## National Highlights

**T**HIS through emergency work and worthwhile steps that make us "prepared" to serve that amateur radio continues to highly fulfill the phrase "in the public interest. . . ." As will be recounted elsewhere, with all wires down in the blizzard that struck the Eastern Shore (Maryland) on January 23rd, amateurs stepped into the gap. From then until Monday, January 28th W3DTO (Lewes, Del.) handled all W.U. and press dispatches, and for two days, all maritime traffic and government weather. '47-45—and a pair of '10s did the job! Skeds with other O.R.S. (W3DUK, W3AEJ) and fine work by W3EGN and W3DQG put over a real job. At Salisbury, Md., W3VJ clicked with NDK and W3SN. W3EWP W3AUG W3BTQ W3BKZ W3HC W3ELZ W3SN's staff and a large number of NCR-amateurs at NDK took traffic and stood watches for *four days* following W3CQS's QRR and handling *thousands of words* with VJ. The participating stations are all in line for the A.R.R.L. Public Service Certificate Award.

A Pennsylvania Traffic Net is being organized by W3EZ, W3CL and W3BYS. Likewise W3AMD of Norristown is starting a *daytime* 3rd Corps Area A.A.R.S. Net. Hams in Delaware and Montgomery counties who work on u.h.f. will be interested in joining the new Delmont High Frequency Club. At Wilmington, Del. (DuPont Hotel), the Delaware Amateur Radio Club will hold its second annual hamfest on March 2nd—\$2.50. No evening speeches. Prizes! From Southern New Jersey also comes word that the Atlantic Radio Club will invite all hams to a big hamfest (Boardwalk Hotel) in March. W3APV did good work for the Goodwill fliers until they were forced down in San Domingo. The Boston, Mass., to Portland, Ore., trunk line (A.R.R.L. T.L. G) is working well. W3JTT and W8DBX will be glad to get W.N.Y. traffic for the trunk. Many clubs are putting in club stations. . . . the Mohawk Valley Radio Club just got its license from F.C.C. All eastern amateurs are looking forward to the annual Atlantic Division Convention. This year it is slated for Syracuse and comes in June, as usual. W8LUJ is much interested in the O.R.S.—Police Radio

Net, and will cover Glens Falls.

Western Penna. activities are well organized on all fronts. W8GUF and W8KWA can put your traffic on Trunks A (New York to Seattle) and M (W3CWL-W3BND-W8KWA-W8HCS-VE3TM-W8AEQ-W9PDE-W9IQW). W8ABS, 'Phone Activities Manager, is getting new O.P.S. lined up so a 'phone round table can be scheduled. Illinois Hams should all take part in the QSO Party scheduled 6 a.m. to midnight, March 24th (Sunday). Two points for each QSO (4 points for ORS QSOs, and 10 points for working SCM, RM or PAM). A prize will be given for high score. Mail scores to W9WR before April 1st. Indiana has designated Sunday a.m. "rag-chew time" on 1.75 mc. W9TE, the Indiana A.R.R.L. S.C.M., wants to send reporting cards to all new hams in the Section. Write him. W9JRK reports the Indiana A.A.R.S. Net working on 3638 kc. (one spot net). The Amateur Radio Transmitter's Association (Louisville, Ky.) is now affiliated with the League. A special meeting was arranged with a good turnout when Secretary Warner was able to stop off on a recent trip. In Michigan all hams are interested in the election for S.C.M. now in progress. W8DYH, W9HK, and W8DED are candidates for this A.R.R.L. office. The Motor City Radio Club will stage a hamfest March 24th. Register 10 a.m. (50¢) K. of C. Club, Woodward St., Detroit. Prizes. New operators are wanted in Michigan's O.R.S. and O.P.S. organizations. Drop a line to W8DYH for blanks.

Ohio schedules a "get acquainted" QSO Party on the first Sunday of every month. S.C.M. W8CIO tells us it will be called the "Ohio Grab Bag Party" with a prize to the fellow working most Ohio stations. The Milwaukee Radio Amateurs' Club will hold its annual QSO Party either May 11th or 18th. W8HTZ is the editor of "QRZ" which covers Dakota and Central Division interests. Ask him about it, last copy we saw was swell. North and South Dakota are well covered in the A.R.R.L. T.L. system. Route traffic for T.L. H and G through W9OEL, W9OQV and W9BLZ. The Arrowhead Radio Amateurs held a very fine Christmas party at W9DOQ. The next

big A.R.R.L. Dakota Division Convention will be held May 3rd-4th-5th at Hotel West, Minneapolis.

All Arkansas hams that report activities to S.C.M. Velte, W5ABI receive a copy of the "Arkansas Bull." Report, and have your name added to the mailing list. The Tennessee S.C.M. has accepted Arkansas' challenge to a traffic-handling contest which will not end until April 15th. Plans are being made for an Arkansas hamfest! W5KC is doing great work on T.L. H and crystals are now definitely promised this A.R.R.L. Trunk by February 10. W5CWQ and W5DEJ uphold T.Ls D and H for Mississippi.

Tennessee, Arkansas and Mississippi suffered flood conditions in late January. On the 21st W4AEP reported flood conditions to W4IR. A.A.R.S. Hq. and the Red Cross were kept fully informed by a series of messages. W4KV (Ripley), W4RO (Morristown) and W4BBT (Chattanooga) stood by in case anything happened to the skeds kept by W4AFM-AEP-IR. Fine work, and all in readiness for handling whatever conditions obtain in the Mississippi valley. Aspirants for 56-mc. DX will be interested to know that at Schenectady the gang plan to be on that band daily at 7 p.m. E.S.T., and Saturdays and Sundays, 11 a.m., 3 p.m. and 7 p.m. W2DUP has been organizing a club of BREAK-IN operators on the air; anybody interested, who can qualify by using break-in (see Lud Smith, W6BJM, article in recent QST), write him. In the Northern N. J. Section great interest is being evidenced in the election for A.R.R.L. S.C.M. that is now in progress. Candidates are W2BPY and W2FOP, and as we write this the votes are "neck-and-neck" with the outcome yet to be decided.

The Northeastern Iowa Ham Club is holding a 3.5-mc. DX Contest; the club station is off due to loss of antenna towers. Iowa stations having Trunk G traffic should give this to W9ACL. In Missouri W9LHQ copied Amelia Earhart's QSTs on about 7050 kc. A Missouri State Convention is being planned. The Ozark Amateurs (Joplin) and the S.M.A.R.A. met February 17th to further these plans. W9RIZ (Agra, Kansas) is working closely with the local police department, and favors A.R.R.L. organization of a net to handle intelligence (nationwide) for police. Nebraska is well organized with S.C.M. Wallace, W9FAM, at the helm.

Connecticut's S.C.M. held a Section meeting to start off the active season. The latest development adding to interest and activities is the issuance by Route Manager W1CJD (Gil) of a new bulletin, "Contact," to all Conn. O.R.S. All hams in the Section are invited to send news and reports (and postage) for a copy and details of O.R.S. appointment. 1375 hams attended the Eastern Mass. Hamfest put on by the South Shore Amateur Radio Club and the E.M.A.R.A. on February 2nd. Prizes galore were distributed. One T. R. McElroy, for many years speed champ, using his new MacKey put on a public demonstration of "code as she should be sent."

In Western Mass. W1CCH is now A.R.R.L.-N.C.R. Liaison Route Manager. Individuals in a position to act as local "liaison" official of A.R.R.L. with A.A.R.S. and N.C.R. are requested to get in touch with S.C.M.s wherever a vacancy exists in such appointment. Until an A.A.R.L. election is completed, all New Hampshire hams should report to Acting Section Manager Byron, W1AVJ. His plans for the Section should put N. H. on the map, and he will be glad to get your applications for O.P.S. or O.R.S. posts in the Section organization. W1BES has accepted appointment as Rhode Island's 'Phone Activities Manager, and we now look to Rhody for more O.P.S. and perhaps a special fone net or on-the-air club under his capable guidance. Give him your ideas. Vermont activity shows promise with a number of new hams, and the Maine S.C.M. is also looking for new men to hold up the Pine Tree State with the rest.

Alaskan stations report fine totals. More information from Alaska (or the Pacific Northwest) is requested on schedules in effect for handling Alaskan traffic with the states so we can assist routings by giving the information in these columns. In Oregon, an excellent section

paper is edited, and mailed to all hams who send a monthly report to the Oregon S.C.M. . . . a mighty good idea hams in all sections will agree. Chess and checker games hams? W7AVP will be glad to hear from you. Montana's live-wire S.C.M. W7AAT does his part on Trunk A. 'Phone Activities Manager W7AEZ has all Oregon O.P.S. organized and keeping regular skeds together 100%. State Convention soon in Oregon. The Valley Radio Club arranged a winter sports outing (Jan. 27th) in the Cascades. W7AYO keeps everything humming in Washington. Regular QSO Parties arranged this year are proving mighty popular. Note the date, March 30th! An A.R.R.L. Section meeting will be held in conjunction with the Central Washington Hamfest.

Los Angeles Section totals lead the Pacific Division. Late information on trans-pacific schedules is requested. China is now enforcing a ban on handling either domestic or international third party traffic, so XU2RT informs us (by radio of Feb. 2nd). Under the present state of international radio law China has never ratified the Madrid Treaty. This gives us the right to handle all we want with China. But now China's domestic supervisory action stands in our way. 523 attended the recent quarterly A.R.R.L. banquet in L. A. W6HEW solicits your messages for handling east via T.L. "L." Another club station active . . . at Stanford Univ. 600 watts on a poor lil 852. W6EJA (East Bay) keeps skeds with KA1CO three times a week. W6ZX is doing his part to organize the transcon lines. Don Draper, W6GXM, has addressed the L. A. Police Department relative to amateur communication service to points not covered by teletype and relative to emergency coverage and assistance. With such reliables as Don on the job, amateur radio really receives favorable public attention. The idea of a police radio net has been advanced by all O.R.S. who have interested themselves in the matter. A.R.R.L. will welcome information from amateurs in a position to give local police practical assistance in handling communications of a non-secret or emergency nature when transmission to special cities (or general QSTs) are desired supplementing existing means. *Ham Flashes*, the paper of the S.F. Associated Radio Amateurs is edited by W6JAL, W6DZQ, W6CAL, W6GIS and W6HJP. The January issue has 8 pages covering all sides of ham radio. This paper is a potent factor in uniting San Francisco amateurs and helping in the excellent activity showing that the S.C.M. (W6CAL) and R.M. (W6JAL) have made. Send reports to Alan Whittaker, W6SG, Elinor Ave., Mill Valley, Calif., newly elected S.C.M. San Francisco. San Diego has blossomed forth with an unprecedented volume of 56-mc. operation. The Third Quarterly Banquet of the Federation of Radio Clubs of Southern California will be held at S. D. in July. In the San Joaquin Valley the Tulare gang held a successful hamfest, Feb. 2nd. S.C.M. Anderson, W6FFP, turns in a fine report for the Section. Activity in Hawaii and P. I. is excellent—the big P. I. totals speak for themselves!!! The Philippine Section under Mr. Thompson, KA1XA, has forged ahead and this Section leads many in the mainland U.S.A. in the volume of traffic—all useful, well-handled messages. At Phoenix, Ariz., 160-meter 'phone men hold tri-weekly meetings. Their organization is called the Salt River Valley Night Hawks! North Carolina operates a 3.9-mc. 'phone net each Sunday morning. In Virginia W3BIG believes that A.R.R.L. Official Observers using the special 'phone forms to help better operating conditions will be of real help. West Virginia activity remains high. This A.R.R.L. Section is mighty well organized.

On March 2nd the Central Colorado Radio Association is sponsor of a hamfest—contests, prizes and a bang-up feed, all for one buck. Hamfest headquarters at the Olin Hotel, Denver. Drop a postal to W9FYY or W9PVZ to-day and tell them you will be there. Utah-Wyoming hams working 'phone are invited to schedule W7ARK and make arrangements for his measuring percentage modulation. The Caspar Radio Club is holding its meetings over the air. The *Southern Emergency Net* (Mobile Alabama Hq.) is functioning 100%. W4BSL and

W4CCP are active in this. The Miami Amateur Radio Club operated several different transmitters for communication problems in connection with the recent Air Meet. W4BVX, W4CVI and W4BXL send 160-meter code practice. The "Meters of the Morning" has a new Kingfish, W4CWR, and the morning get togethers continue on 160. K5AT, Ft. Davis, C. Z., has been working on 14 mc. with a 46-46-211D rig and power from two dynamotors with filtered output. A battery charger and storage cells are used to drive the dynamotors.

Amateurs in New Mexico please send activity reports and ideas for Section doings to Bob Shadden, W5AOP, who has been appointed Acting S.C.M. since W5DUI transferred to Oklahoma City. Nominations are in order from this Section. In El Paso, Texas, a committee of three has been appointed to investigate and handle BCL interference complaints, and the results show that every club should have such a Mediation Committee. Northern Texas issues a call for new men to swell the Section organization ranks . . . O.R.S. and O.P.S. appointments for those who can qualify. In Texas and Oklahoma a "weather collecting" net is functioning (as first reported in November QST). W5BDX has volunteered for this interesting and valuable work. The Enid Club is conducting a code class with a large number attending. The 1935 Oklahoma Convention dates have been set by the Ponca City Key Clickers as June 8th-9th. Oklahoma is conducting a contest for high traffic man. A crystal is offered to the ham whose totals are highest the first 6 months of 1935. The SCM is not eligible and W5ASF is first in line for the month of January.

## CANADA

### MARITIME DIVISION

**MARITIME**—SCM, A. M. Crowell, VE1DQ—ER schedules VE2HK daily as eastern end of trunk line "I." FL alternates for ER. GL works Europe often on 3.5 mc. HH schedules WIIBD and VE1BJ daily. HX is new man on 3.5-mc. c.w. FT is building Sniggle Sniggler. BN, EA, EQ, EX, EL, BZ, CO, AP, CF, EV and BW have regular hook-up for rag-chewing on 3.9-mc. 'phone. HG is now W.A.C.; he hooked his 37th country. EP worked D4BAR on 3.5 mc.; he has worked 50 countries to date. GR, AQ, AR, BO, AG and CL are active on 1.75-mc. 'phone. FN is trying new high-power rig. ET works scads of DX daily on 14 mc. FB, QSL Mgr., has bunch of cards for out-of-town hams. Wants stamped envelopes. VO1W (Ex-V08W) reports change in N'fid regs. Permission is given for 1.75-mc. 'phone. VO1H (Ex-V08H) would like an HRO receiver.

Traffic: VE1ER 50 FL 51 GL 42 HH 6 FT 4 EP 2. VO1W 6.

### ONTARIO DIVISION

**ONTARIO**—SCM, S. B. Trainer, Jr., VE3GT—We are sorry to report 3JT has been ill in bed since before Christmas with bad eye trouble . . . improving slowly. WK continues good eastern schedules. SG has 7-mc. c.c. rig now working. ZE finds e.c. oscillator FB. UF and WX are now c.c. WU gets out well on 1.75-mc. 'phone. ABW was visited by PX and CI. Have you heard CE's signals? RK sent fine report from Ottawa district. TF and LC are prospective O.R.S. MX is QRL R.I. work. 9AL has 14-mc. 'phone. 3QK edits Frontier Radio Club Bulletin "MIM." TM finds T.L. "M" going fine. AZ handles some traffic on 'phone. NX awaits unlimited 'phone license. SZ reports all Oshawa stations now c.c. DU is new Route Manager for Central Ont. ACO is new London station. FD is on ½ meter. PL wants to see more 56-mc. activity. GT has taken over T.L. "I" schedules for JT. GG says ice from Hydro Falls spray covered his shack a foot deep.

Traffic: VE3JT 355 WK 56 SG 5 ZE 2 MB 48 CE 8 YS 4 RK 172 TF 40 LC 25 LI 2 KR 21 QK 127 TM 167 AZ 7 DU 13 GT 131 GG 241 VD 2. VE9AL 26.

### QUEBEC DIVISION

**QUEBEC**—SCM, Stanley C. Comach, VE2EE—Your new S.C.M. greets you and extends best wishes for 1935. HP is proud of his RK20; GE has one perking F.B.

FY makes debut on 3.5-mc. 'phone. HK takes excursions to 14 mc. HS and GZ are testing 23-mc. 'phone. IE is buying new receiver. BE likes his FBXA. BT: Your 'phone sounds swell. AH is new QSL manager. EK and EC: Thanks for photos; swell rigs. CU rebuilt. DU has 50-watter final. BE, BB, AX, CA, HG and EE have hooked that elusive Asian for W.A.C. S.C.M. had enjoyable visit to W1BJP and 1CGW, also had great time with 2FE and the Sherbrooke gang. Thanks, fellows.

Traffic: VE2HK 438 DR 135 BK 40 EE 18 CA 15 DV 2.

### VANALTA DIVISION

**ALBERTA**—SCM, J. Smalley, Jr., VE4GD—Trunk lines keep BZ hopping. LX plans 500-watt c.w. rig. Second op at OG now has ticket. LG is new O.R.S. QK delivers most of Calgary's 3.5-mc. traffic. KG resigned as O.R.S. due to ill health. Alberta stations are urged to keep off the trunk line frequency, 3690 kc. UF is new ham. JR operates 5NC at Vancouver. VN is new 56-mc. ham. AF is in on B.C. and trans-Canada trunk lines. EO wins the W/V contest.

Traffic: VE4BZ 166 LX 51 OG 40 LG 32 QK 26 AF 22. **BRITISH COLUMBIA**—SCM, R. K. Town, VE5AC—FG keeps northern schedules. DF operates on Salvage boat. EC works LU on 14 mc. HP is rebuilding power supply. HR is blowing 83's. FT works in B.C. Net. MD is on 7 mc. LQ is QRL commercial operating. 9AJ, station of B.C.A.R.A., is active on 3.5 mc. 5NL is ex-5BA of old days. IQ and DZ work in local net. KC schedules Winnipeg on 14 mc. KU is on 3.5 mc. FM is doing fine work on T.L. "F." Unusual Christmas snowstorms provided thrills in emergency work for many. 5BY, JA, BR, BL, EO, FN, CX, GI, BK, MK, HY and AC all did yeoman service when lines went out for three days on Vancouver Island. BY, BK and AC kept relatives in Vancouver informed as to condition of a very sick child in Alberni. V.S.W.C. held annual hamfest. NS won high-speed code test. V.S.W.C. reports annual contest for Burrows Challenge Cup now in full swing. JL won a crystal at hamfest. KL worked all VK and ZL sections on Jan. 1/35. KY reports 1.75-mc. DX very good; W8, W9, W5 and W4 coming in very well. AC finished long promised modulator and will be on 3514 kc. BJ, BQ, DW, BK, ER, AZ, CE, FN and 9CY are active on Canadian 3.5-mc. 'phone band. HX at Trail goes 3.9-mc. 'phone. Alberni reports forming a club, the A.D.A.R.C. EP sends code practice Mondays, Wednesdays and Saturdays. Any interior hams interested in the B.C. Network, get in touch with the S.C.M. or R.M., EP. Our Section paper, the "Amachewer," is getting bigger and better with every issue. NG is our first YL operator operating her own station. AS reports good results on 1.75-mc. 'phone with ¾ watt input.

Traffic: VE5FG 36 DF 32 JA 74 EC 16 KL 24 HP 12 HR 4 BY 16 FN 15 FT 22 MD 18 LQ 3 NL 1 IQ 24 KC 28 EO 16 KU 15 BK 7 KY 13 FM 147 AC 114 AS 3 EP 14 NG 4 DZ 14. VE9AJ 3.

### PRAIRIE DIVISION

**MANITOBA**—SCM, Reg. Strong, VE4GC—AG, trunk line "I," has real total. GC is alternate trunk line station. EK works west coast on 1.75 mc. AC from Brandon visited for a week. BG has FB7. NR works 3.9-mc. 'phone. SF schedules DK at Ilford. NI, KU, IP, TV, GC, MV and CP are on 3.5 mc. VI has c.c. rig on 7 mc. MY built FB super. MW changed QRA. MF, UM and RM are on 1.75-mc. The M.W.E.A. in Free Press Bldg. is active. GQ is on 'phone.

Traffic: VE4AG 171 GC 67 SF 10 GQ 9. **SASKATCHEWAN**—SCM, Wilfred Skaife, VE4EL—"Where do we hold the Hamfest this year?" Write in your comments. MH is building 56-mc. transceiver. GA schedules 4GI, 5FL, 4EK, 4FA, 4QS, W9MLP and 9RII. Op was heard in VK. VQ is new ham at M.J. KA had strenuous time in SS. RE is convalescing. NE works 1.75- and 3.9-mc. 'phone and c.w. PM and SY are rebuilding. EH is building for 500 watts. ND and CV are trying 56-mc. 'phone. NO is new S.C. ham.

Traffic: VE4CM 160 MH 211 GA 37 FW 20 EL 15 ND 10.

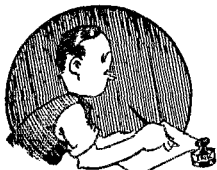

# CORRESPONDENCE

The Publishers of *QST* assume no responsibility for statements made herein by correspondents

## From Mr. Holland

Philadelphia, Pa., January 15, 1935

Editor, *QST*:

I wrote you under date of December 21st, stating that I had been misquoted in the write-up in the October 24th issue of the "Radio Weekly" to which you called my attention. Owing to my tardiness in replying to your letter, you did not have all the facts before you when you wrote the editorial, based on my alleged statement, in the January, 1935, number of *QST*. May I ask, therefore, that you print this letter?

The statement I made to a group of foreign newspaper correspondents, as nearly as I can remember it, was to the effect that more space should be allocated to international short-wave broadcasting, which at present is given an insignificant amount of space compared with General Communication, Fixed, Amateur, Government and other short-wave services. It is very unfortunate that the reporter for the "Radio Weekly" did not quote my full statement but singled out the word "amateur." I assure you no one in the Philco organization, and I least of all, has any desire to limit the amount of space given to amateurs.

I take it from your editorial that you personally have little use for short-wave broadcast programs, except as they are picked up and re-broadcast on standard channels. I think, however, a considerable percentage of the membership of your League will agree with me that, whether it be called "DX-chasing" and in spite of the nationalistic propaganda, the direct tuning of foreign short-wave programs offers a great deal of interest. Short-wave broadcasts are rapidly becoming better as to signal strength and quality. Furthermore, there are already some programs which, when tuned with an up-to-date all-wave receiver operating on a well-designed noise-reducing antenna, give satisfactory "program quality."

I personally have several friends not connected with the radio industry who prefer to listen, and do listen regularly, to certain programs from England, Germany and South America, rather than to our American programs. They like the character and continuity of the foreign programs and find the occasional nationalistic propaganda less objectionable than the incessant commercial propaganda on the American programs.

Now let us look for a moment at my statement

that short-wave broadcasting occupies a very small amount of radio space compared with other services. The most useful short-wave band at present and for the immediate future is, I should say, the 26,500 kilocycles of radio space lying between 3500 and 30,000 kc. I have gone over the latest frequency allocations, as published by the Federal Communications Commission, and find that of this space 75% is allocated to four services as follows:

Fixed Services . . . . .	10,050 kc. or 38%
General Communication . . . . .	5,750 kc. or 22%
Amateurs . . . . .	3,200 kc. or 12%
Relay Broadcasting . . . . .	830 kc. or 3%

I contend that the millions of listeners who have shown their interest in short-wave broadcasting by purchasing receivers adapted to tune some or all of the relay broadcast frequencies are entitled to something more than 3% or eighty-three 10-kilocycle channels of the useful short-wave band. This applies particularly in view of the great service area and enormous interference area of each short-wave transmitter. Furthermore, it would seem most unfortunate that this new broadcast service, owing to inadequate allocations, should become established on the basis of 10-kilocycle separation or less, thereby repeating the apparently irreparable mistake made in the standard broadcast band which bars the attainment of full fidelity.

I fully agree with you that any campaign for more broadcast space should not be directed toward amateurs, but toward the three or four classes of service which have been given approximately 80% of the available space and who actually use their space so little that it is an event to find them on the air.

—Walter E. Holland

Vice-President in charge of Engineering

Hudson, Ontario

Editor, *QST*:

With reference to Ralph J. Woodfield's letter on page 68 of January *QST* it strikes me that we amateurs, if we stick together, have a very very effective weapon for dealing with Philco or any other BCL manufacturer that wishes to get "tough" with us.

My plan is simply to boycott the offending manufacturer. An amateur is called on many

times in the course of a year to advise his friends on the purchase of a B.C.L. set and, as there is no present day set that is very much superior to its competitive models, he would not be letting his friends down by advising against the purchase of a Philco or the product of any other unfriendly manufacturer.

Surely, the 45,000 amateurs in U. S. and Canada, each with the power to promote or kill several B.C.L. set sales each year, do not have to sit meekly by while these . . . manufacturers seek to rob us of our hobby.

—G. B. Lawrence, VESET

**EDITOR'S NOTE.**—Many writers of letters of similar sentiment, with thanks for their loyalty to amateur radio, are asked to observe that, in view of Mr. Holland's statement, Philco is not deserving of such treatment.

116 Lenox Road, Brooklyn, N. Y.

Editor, *QST*:

In reading your editorial in January *QST*, I wish to say that I have been reading *QST* since it was a few sheets of paper and all this time I have never read anything that riled me up as much as this article.

Instead of "We amateurs show them how to use the short-waves and then they want to steal them away from us," it should be it took men like Walter Holland and his type to show us what we now know.

An exact example of what I mean is shown on page 11, extreme right-hand bottom corner, and on page 12, first four lines, of the January issue. Personally, I have been a SWL for a long while and have gone no further because I do not see the reason for calling out and asking somebody how my "sigs" are coming over, what my modulation is, etc. Ham radio has done a great deal for the benefit of all, but do not bite the hand that feeds you.

In regard to Philco, I wish to state that from years of experience in the broadcast receiver radio business Philco has always had a set rating as high as any other manufacturer and that they have pioneered in a great many features. I would suggest that we find exactly who limited our bands and still wants more before we definitely point to any certain manufacturer. . . .

—Richard E. Meeker

## Misnomer

8527 Germantown Ave., Philadelphia, Penna.

Editor, *QST*:

I wish to call attention to a misnomer in distinguishing between "radiotelegraph" and "radiotelephone" and to suggest a remedy. I refer to the term "c.w." Both of these methods of transmission are "c.w." Its application to radiotelegraph alone apparently comes from its original construction in differentiating between V.T. and spark transmission.

The words "phone" and "voice" are accurate contractions for radiotelephone: why not use "code" or "m.c." (Morse code) in referring to radiotelegraph? "Code" is two syllables shorter than "c.w." and "m.c." is one syllable shorter.

—John Buck Morgan, W3QP

## Kill QSL

167 Carter Lake Club, Omaha, Neb.

Editor, *QST*:

Isn't it high time we abandon this infernal QSL nuisance?

Isn't there some escape for those of us who recognize QSL-ing as an antiquated practice, a hangover from the old spark days when it frequently took a postcard to complete a contact, but continue to send them out merely for the sake of common courtesy?

At the risk of being called all sorts of dire things by those who manufacture these cards (and I doubt if they realize enough profit out of them to make it really worth while) I am pleading for the absolute abandonment of the use of

QSLs except in those few instances when there is genuine reason for a QSL and one of these reasons will not be the mere desire of some QSL collector to see what a deucedly clever fellow I might be in designing a fancy, highly colored card.

In this day and age, we don't talk from New York to Frisco or London on the telephone and then send a postcard along to convince the other fellow that we actually talked to him. We don't follow a telegram up with a QSL, but that's just what we do in amateur radio. We have the most modern means of communication at our command and yet, for some unexplained reason, revert to one of the most primitive means of communication in a sort of anti-climax to send a message to the other fellow. By means of radio we can easily get every bit of information which the other fellow will give us on his QSL except the flaming red color of his call letters.

Personally, I have never failed to send a fellow a QSL when he sent one, so I feel privileged to speak on the subject with skirts clean.

There are only a few occasions, as I see it, where a QSL is justified. One is where you are sending the other fellow a diagram of a circuit, a thing almost impossible to send over radio. Another would be in confirming a real DX contact where it was impossible to have gotten over all the information either party desired.

Then, too, there are economic reasons why we should abandon dear old QSL. You may not believe it but there are just lots of fellows who really cannot afford to have QSL cards printed and stamped. You'd be surprised how quickly you'll spend the equivalent of a '10 tube on them.

I would suggest that we mail our remaining stocks of QSL cards into one central point to be destroyed in one huge bonfire as a sort of testimonial that amateur radio now rules supreme.

—W. H. Graham, W9BNC

## Racket

Everglades, Fla.

Editor, *QST*:

Some few weeks ago I received a card from South Pasadena, Calif., stating that there was a certain clipping in which my name was mentioned, and in which I might be interested. I was told I could get this clipping for the sum of 25¢, so I unsuspectingly sent the 25¢, as I was curious to know in what way and why I should be mentioned so far away. On receiving the clipping I found it to have been cut from the "Radio Amateur Call Book Magazine," giving my call and location.

It is not that I care about the 25¢, but I think that the swindler who is responsible for this should be apprehended if possible, as I am sure many more of the hams are being swindled as I have been, and all should be warned.

The only address given by the party was Box 75, South Pasadena, Calif.

—Walter J. Helzman, W4ARU

**EDITOR'S NOTE.**—It is doubtful if there is any actual illegality involved in such an instance as this. The clipping was supplied as contracted. Let amateurs beware of such rackets, and advise Hq. when they are encountered so that other amateurs may be warned, however.

## Also-Rans

5822 E. Green Lake Way, Seattle, Wash.

Editor, *QST*:

Northwestern Division A.R.R.L. elections for Director, and Alternate Director have just been held, and we are two of the three also-rans.

We may be disappointed in the results, but by no means dissatisfied. The elections were the cleanest Director's Elections that have been held in this division for many years. We know the two elected to office are fine fellows.

We would like to thank those who voted for us. Neither

(Continued on page 78)

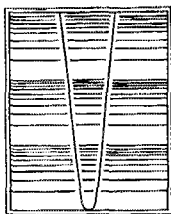

MUCH is being said these days about variable band-width in connection with the development of high-fidelity broadcast receivers, and in many designs for such receivers there is provision for varying the band-width (selectivity) of i.f. circuits from "ordinary" to "wide" so that the usual side-band clipping necessary on distance reception may be eliminated for high-fidelity local reception. While this idea may be considered something radically new in broadcast receivers, it is already standard in amateur receivers — having been used in our AGSX and FBX models since 1932 and being incorporated in an advanced version in the

new HRO. In fact, in these receivers variable band-width is employed in a fashion even more unusual than in modern high-fidelity broadcast types. Where the latter range downward in selectivity from "ordinary" to "wide," our receivers range upward from "ordinary" to "very narrow." Also, whereas broadcast designs use orthodox coil-condenser circuits with a few extra trimmings to obtain a variation in band-width, our receivers employ the Lamb circuit in which a quartz crystal in conjunction with a variable impedance constitutes the essential variable band-width element. With this crystal filter circuit switched "out," the selectivity provided by the normal i.f. transformers (equivalent band-width of several kilocycles), prevails. But when this filter is switched in, a range becomes available from the maximum selectivity that can be used for slow-speed c.w. telegraphy (equivalent band-width of less than 20 "cycles") to selectivity that will accommodate phone. In the battle against interference, that prime affliction of radio communication in general and of amateur communication in particular, this feature is of inestimable value.

And speaking of interference, it must be appreciated that selectivity and noise are closely inter-related. In describing our receivers we have always used the expression "usable sensitivity," by which we mean the weakest signal that is readable. This is not the customary definition; sensitivity usually being expressed as the signal required to give a standard output as measured by a meter across the speaker terminals. Obviously such a meter measures noise as well as signal. Consequently, if the set is poorly designed and very noisy (with the noise level equivalent to 1 microvolt, for instance) it may be found that a very weak signal (say 1/10 microvolt) will bring the output up to "Standard." Such a set is therefore, rated at 1/10 microvolt sensitivity, though such a signal could not possibly be read. Actually it would probably require a 4 microvolt signal to give a readable output.

For this reason, the noise originating in the first stage of a receiver is the ultimate limit on sensitivity. In the HRO design particular pains have been taken to bring this to the very minimum. At best, however, the "bottom" sensitivity of a good transformer — coupled two- or three-stage i.f. type receiver cannot be made much better than 1 microvolt. Remember that the useful sensitivity is several times the measured noise-equivalent value, which may be 1/4 microvolt in a good design. But increasing the i.f. selectivity above that ordinarily obtainable reduces the noise, the reduction in noise power output being directly proportional to the reduction in equivalent band-width. This applies whether the noise originates in the receiver's first circuit or rides in with the signal from the antenna, so long as the noise amplitude is not so tremendous as to overload tubes. In the variable band-width crystal filter HRO the improvement in effective sensitivity actually accomplished is ten-to-one at maximum selectivity, the noise equivalent voltage being brought down to a few hundredths of a microvolt.

This noise equivalent voltage rating is the real indicator of a receiver's sensitivity. It is the only thing that shows for how weak a signal the receiver still has effective sensitivity.

JAMES MILLEN





Not that I'm a softie . . . but with my new shaft of aluminum you can almost "bite" me off with a good pair of pliers . . . in fact, a few swipes with a file and I'm down to the required size.

Just another refinement that makes it so much easier to use me in a replacement job. And do I work smooth? . . . ask thousands of servicemen the world over who always use **CENTRALAB RADIOHMS** for ALL their jobs. Don't say "Gimme a Volume Control." Specify **RADIOHMS** the next time you stock up.

The new **RA-DIOHMS** offers a smoother attenuation because of greater length of resistance strip employed.

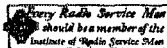

## Centralab

**RADIOHMS—RESISTORS  
MOTOR RADIO SUPPRESSORS**

Division of Globe Union Mfg. Co., Milwaukee

## Correspondence Department

(Continued from page 76)

of the undersigned also-rans is over twenty years old, so we have plenty of time to improve our paces, if we want to. Youth will be served—later. Hi!

—Rob't H. Votaw, W7WY

—Nilo E. Koski, W7LD

## Sentiment

995 Delaware Ave., S.E., Atlanta, Ga.

Editor, *QST*:

About this discussion now going on in *QST* re restricting the 7-mc. band:

Nertz.

—Howard W. Stephen, W4CDH

## Word from an XYL

1516 Corley Ave., Beaumont, Texas

Editor, *QST*:

Just a word from an XYL ham without a call. Got my ham ticket in Galveston in October, 1933, but could not get station license due to the fact that the OM has a station call at the address—W5CDM, . . . I would like to say that, although a YL, it is a race between the OM and myself for *QST* each month.

I would like to give Dr. John Alden Stewart, W1SK, a big hand on the letter he wrote in January *QST*. . . .

—Lena Elizabeth Kay, W5CDM

## 2-Mc. Harmonics

R.F.D. No. 2, Boise, Idaho

Editor, *QST*:

In the last two weeks I have had two schedules and several perfectly good QSOs destroyed by very strong 160-meter 'phone harmonics. Now I believe that any transmitter will radiate a small harmonic for a short distance, but I have heard 160-meter 'phone harmonics in the c.w. portion of the 3.5-mc. band that were like 80-meter signals. I have asked several c.w. operators and a lot of them have had experiences similar to mine.

All amateur radio operators know what the radio laws say about harmonic radiations and the present state of the transmitting art makes it absolutely unnecessary for any strong second harmonics as are heard on the 3.5-m.c. band today.

—F. W. Stuart, W7DBP

**Error's Note.**—Methods of reducing harmonic radiation include: A. Proper design and operation of final amplifier stage, principally the use of a reasonably low LC ratio (i.e., at least 200  $\mu$ f at 2 mc.); operation at normal efficiency, rather than attempting to obtain "high" efficiency, particularly avoiding operation at excessive plate voltages (oxide-coated filament receiving tubes like the 45 and 46 are especially bad when operated at plate voltages of more than 400 volts on the modulated stage, and especially when overmodulated); avoidance of overmodulation, perhaps the most pernicious offending cause; use of push-pull when possible. B. Proper design and operation of output coupling circuit; with inductive coupling, use antenna coil at "cold" end of single-ended plate tank circuit, around the center of a push-pull circuit, to avoid capacitive coupling which favors harmonics; electrostatic shields between tank and antenna coils are helpful; when coupling two-wire transmission lines the pi-section filter is recommended; the single-wire feeder system is especially obnoxious for harmonic radiation unless carefully adjusted and checked; several harmonic trap arrangements have been described in *QST* and can be used as possible cures. Transmitters that have been described in *QST*, especially of the push-pull type, when properly adjusted and operated at specified voltages, etc., have been found to be properly free from harmonic radiation.



# "Pleased beyond words"...

says W3EEY of his RCA Communications Receiver ACR-136



Dr. H. A. D. Baer, prominent Allentown, Pa., surgeon and ardent amateur, owns and operates W3EEY. Dr. Baer was kind enough to write us of his experience with his new ACR-136. We quote from Dr. Baer's letter: "I can truthfully tell you that I am pleased beyond words with my ACR-136. The sensitivity and selectivity far surpassed my expectations. Besides wonderful results on the amateur CW and 'phone bands . . . on several occasions I was bringing in German and French stations with only a five-foot antenna."

We believe Dr. Baer's statement reflects the opinion of the hundreds of amateurs who have purchased this excellent receiver to date. Because the initial demand for the ACR-136 far exceeded our expectations, we were for a while completely out of stock. Now, however, we are glad to say the ACR-136 is in stock again. Your amateur supply house will be glad to demonstrate it.



## AMATEUR RADIO SECTION

**RCA MANUFACTURING COMPANY, INC., CAMDEN, N. J.**

Say You Saw It in *QST* — It Identifies You and Helps *QST*

# RAYTHEON

TRADE-MARK

## TRANSMITTING R.F. PENTODES

Modern Transmitters use R.F. Pentodes that require:

No Neutralization

Low Excitation for full rated output

Low Audio Power for suppressor grid modulation

To meet these exacting requirements, Raytheon has designed, with the cooperation of the Amateur, the RK-20, RK-23 and RK-25, permitting ideal tube line-up.



### RK-23

CW Output	10 watts
Suppressor Phone Output	3.5 watts
Plate Voltage	400 V.
Screen Voltage	200 V. Max.
Heater RK-23	2.5 V., 2.0 A.
RK-25	6.3 V., 0.8 A.

Control grid to plate capacitance .04 uuf.

Amateur Net Price — \$5.95

### RK-20

CW Output	50 watts
Suppressor Phone Output	16.5 watts
Plate Voltage	1250 V.
Screen Voltage	300 V.
Filament	7.5 V., 3.0 A.

Control grid to plate capacitance .012 uuf.

Amateur Net Price — \$15.00

*Use them at rated conditions to obtain the greatest uninterrupted service*

For further information see your dealer or write:

## RAYTHEON

### PRODUCTION CORPORATION

30 E. 42nd St.  
New York, N. Y.  
555 Howard St.  
San Francisco, Cal.

445 Lake Shore Drive  
Chicago, Ill.  
55 Chapel Street  
Newton, Mass.

## Amateurs Around the World by Plane

(Continued from page 14)

started on our way down the Pacific Coast on Jan. 6th.

### SOUTH FROM VANCOUVER—AND HOME

Ed Stevens, W7BB, at Seattle showed what hospitality consists of out that way. Schedules with him and with W6CUU were made and as we progressed into Mexico good contacts were had with them. Their reliable, strong signals made good QSO's up to 2000 miles possible.

Stops were made at Guaymas, Mazatlan, and Acapulco on Mexico's west coast after leaving San Diego. While following the Oregon and California coasts southward good radio communication was had on 600 meters with the Navy, Coast Guard, KPH and KOK. Schedules were made with KOK for 36 meters and they were of the greatest assistance during this part of the trip. While in southern Mexico, KOK and other Mackay System stations in San Francisco, Miami and New York kept schedules with us and were invaluable in keeping track of our position and arranging contacts with stations of the Pan-American Airways. Our signals were picked up again by W1SZ while we were between Mazatlan and Acapulco; while by no means a record, 2600-mile daylight transmission between an airplane and an amateur station is worthy of note. Subsequent stops were made at Carmen, Campeche, and in a lagoon off the coast of Yucatan where 10 miles of open water separated us from the low barrier reef.

Havana next, and then Miami. From Miami northward schedules with West Hartford were kept when time allowed, and weather reports were obtained from the Department of Commerce airways broadcast stations, as we had also received them on the west coast of the United States. After a stop over at Morehead City, N. C., for weather to the north to clear, we proceeded to New York in the face of a sharp head wind and a low temperature. It was well below freezing inside the cabin, and we thought that the weather man was mistreating two poor tropical birds who had not seen a thermometer below fifty for about ten months.

Cold and tired we scrambled ashore over the icy ramp at College Point, N. Y., at the end of a five months' trip that was the experience of a lifetime. Being in radio contact with the ground for practically every inch of the 30,000 miles flown was a good radio demonstration of the present state of radio communication, just as the long trip made by two amateurs without mishap is a demonstration of the present state of aviation.

\* \* \*

Operators used to land or ship station operation will wonder how aircraft operation seems and how the different conditions affect the operator. There is the noise of the engine, both direct from the engine and from the ignition; there is the unsteadiness of the plane especially in rough air, and above all there is a psychological effect caused by being conscious of the means of trans-

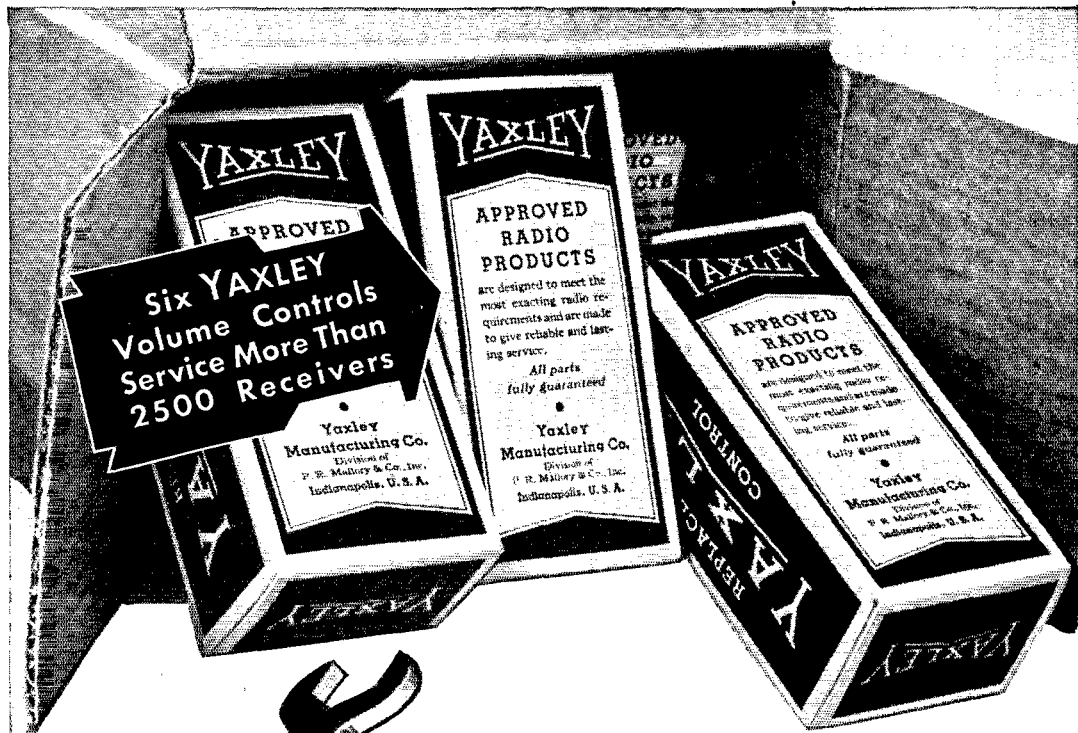

No service man can afford to be without this FREE replacement wrench.

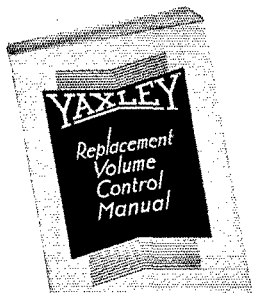

**Here is the Most Complete Manual For Service Men Ever Published**

## 3,000 Service Men Are Finding This Kit *Indispensable*

A few months ago Yaxley announced to the industry a new kit of six Yaxley Volume Controls that will service more than 2,500 set models, at a substantial saving over the regular list price.

To date, 3,000 service men in all parts of the country have availed themselves of this offer and are finding the kit indispensable in their daily work. They have discovered that it is a real saver of time and money.

They have also found that the beautifully finished wrench that is given free with each kit, or in exchange for the tops of 6 Yaxley Control cartons, is a mighty handy tool for a service man.

And then there is the free copy of the Yaxley Replacement Volume Control Manual—the most complete and authoritative service manual ever published, which tells all about the 30 new Yaxley Replacement Volume Controls that will service 98 per cent of the 3,200 set models now in existence. Mail the coupon today!

### YAXLEY MANUFACTURING COMPANY, INC.

Division of P. R. Mallory & Company, Incorporated  
 INDIANAPOLIS, INDIANA  
 Cable Address: *Pelmallo*

YAXLEY MANUFACTURING CO., INC.  
 Indianapolis, Indiana

Gentlemen:

I enclose \$3.60 (which is 40% less than the regular list price of individual controls) for kit of 6 Volume Controls which entitles me to FREE Wrench.

I enclose 6 carton tops for FREE Wrench.

Please send free copy of Replacement Manual.

Name.....

Address.....

My Jobber's Name is.....

## THE IMPROVED CATHODE-RAY OSCILLOSCOPE

Linear sweep model for broadcast stations  
and advanced amateurs, physics labs., etc.

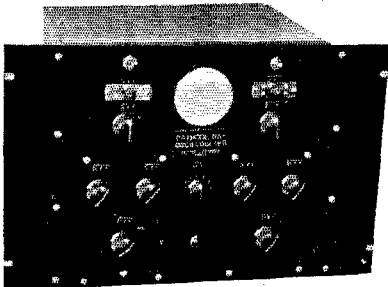

★ Controlled linear sweep. ★ Controlled external sweep  
★ Freq. locking device for sweep frequency. ★ Picture  
centering adjustments. ★ Wide range focus adjustments.  
★ Complete component shielding. ★ Unit is self contained  
and includes batteries and 110V-60 cycle power supply.  
★ Tubes RCA 900-885-234-281-280. ★ This instrument  
embodies all features ordinarily contained in only the  
highest priced Cathode Ray equipment.

Completely Equipped Ready to Use  
**F.O.B. Newark — \$97.50**

Literature now available

## R.F. Reactors

are the PERFECT r.f. chokes

Type	RFR-1	RFR-2	RFR-3
Suggested Operating Band — mc. ....	1.7— to 4	3.5 to 14.4	7.0 to 30
Inductance Value — #h.	170	70	30
DC Ohms.....	5.5	3.5	1.5
DC Current-amps.....	2	2	2
Price.....	\$1.05	\$ .90	\$ .75

Compare these values —

With your tank inductance.  
With the DC resistance of the R.F. chokes you now use.  
With the CURRENT rating of your present R.F. Chokes.

These units are practically indestructible: impervious to  
moisture, oxidization and heat.

Fitted with mounting brackets and terminal screws.

WE INVITE INQUIRIES FROM RADIO  
MANUFACTURERS AND DISTRIBUTORS

We are instituting a new service. If your radio trans-  
mitter is not performing we are equipped to handle  
the repair and adjustment service throughout the  
entire Metropolitan area. Rates reasonable.

**DUPLEX POWER  
SUPPLY**

1100v. 250ma.  
350v. 250ma

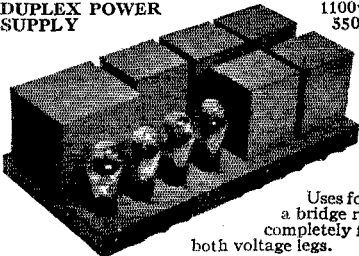

Uses four 83's in  
a bridge rectifier—  
completely filtered in  
both voltage legs.

**\$35.00**

These units can be had on special  
order in any size, mounting, or form.

We specialize in transmitter construction to customers'  
specifications. Let us quote on your favorite transmitter.  
Special code classes for beginners. No charge. Tele-  
phone for appointment

**KALTMAN & ROMANDER**  
62 Court St. Newark, N. J.

portation being used. The engine noise is over-  
come by having a receiver which delivers loud  
signals, and by sponge rubber cushions over the  
headphones. Ignition and generator hash are  
overcome by the use of shielding on all ignition  
conductors and by-pass condensers where  
needed. Because of the absolute confidence I had  
in both the craft and the pilot I was seldom  
worried. The ship and engine were of proven  
make, and frequent checks by ourselves put our  
own minds, at least, at rest about the chances of  
failure. Faith in the pilot's ability was never  
shaken. Not only did Dr. Light meet the every-  
day routine problems of flying with perfect  
solutions, but in all the new and unusual situa-  
tions we found ourselves in, and there were many,  
his experience, judgment and skill seemed to  
show him exactly how to meet them. By this I  
do not mean to say that aircraft operation is the  
same as operating your own fireside ham station,  
but it is not a totally different problem, and with  
our equipment the results obtained are better  
than if installed as a ground station, because  
the transmission conditions are so much better  
at altitudes and the operator is not hindered as  
much as one would at first think.

## Silent Keys

It is with deep regret that we record the  
passing of these amateurs:

Douglas Andrews, W9FSP, Indianapolis,  
Ind.

John Banta, W2ARS, Teaneck, N. J.

H. I. Crawford, W9FGX, Wausau, Wis.

Louis Era, ON4BC, Antwerp, Belgium.

Viktor Gramich, D4UAH, Muenchen,  
Germany.

Capt. Charles E. Hart, W5CDH, San  
Antonio, Texas.

Ilmari Jäämaa, OH2NC, Helsinki, Fin-  
land.

Arthur R. Mills, W8LDP, Carnegie, Pa.

## Vitreous R.F. Chokes

AN INNOVATION in r.f. choke design is  
marked by the introduction of chokes  
wound on ceramic cores and coated with vitreous  
enamel in the familiar manner of wound resistor  
units. Resembling vitreous resistors in all par-  
ticulars of appearance, the new chokes are made  
in three sizes. The largest has an inductance of  
170 microhenrys and is effective on all amateur  
bands from 1.75 megacycles to 14 megacycles.  
The second is designed for 3.5 mc. and its har-  
monics, and the smallest for 14 mc. and its  
harmonics. The inductances are 93 and 24 micro-  
henrys, respectively.

Since the chokes have very low resistance—a  
matter of a few ohms even in the largest size—  
they are especially suited to use as filament

# NEW SHORT-WAVE ANTENNA

## PRINCIPLE DEVELOPED by G-E ENGINEERS

For years General Electric engineers have been working on short-wave antenna design at the General Electric short-wave station in Schenectady. While developing a short-wave transmitting antenna, they discovered the new method of impedance matching that makes possible the V-Doublet all-wave antenna.

Notice the unique "V" construction. The "V" provides an efficient transfer of energy from the antenna to the lead-in (transmission line). A special transformer, in turn, provides an efficient transfer of energy from the lead-in to the receiver and at the same time balances out interference picked up by the lead-in.

Below 55 meters, the antenna operates as a V-Doublet and above 55 meters, it is automatically changed to a standard antenna by the special coupling transformer. Therefore man-made interference is minimized, giving clear short-wave reception and, without switching, excellent reception of standard broadcasts as well.

Simple to install—requires only 2 points of suspension over a 50-foot span. Not unsightly in appearance when installed. Any length lead-in of 100 feet or over may be used.

This new exclusively General Electric Antenna System is exactly what every all-wave radio owner has been wanting. Mail the coupon for complete details. Price of Antenna Kit complete, \$5.95.

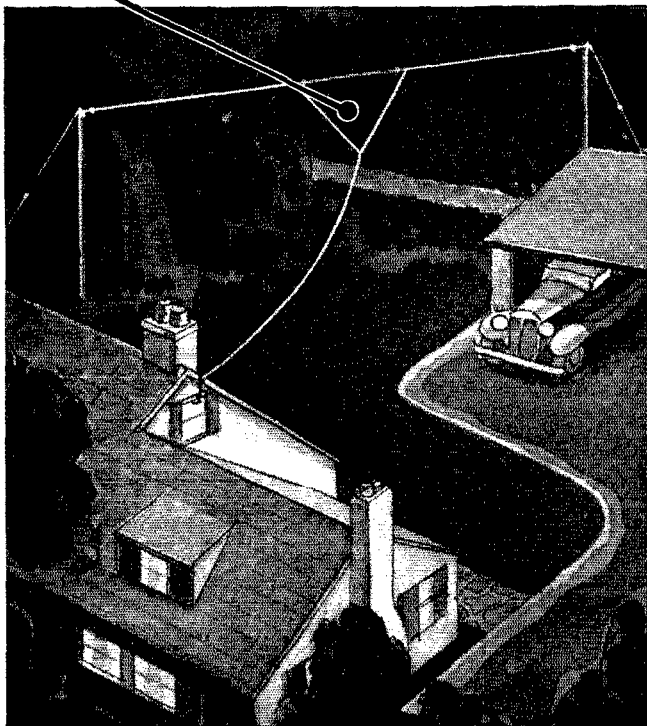

General Electric Company,  
Merchandise Department,  
Bridgeport, Conn.

Attention: Sales Promotion Section R-153

I am interested in the New G-E All-wave Antenna System. Without obligation on my part, I would like to have you send me complete details regarding it.

Name.....

Street Address.....

City.....State.....

# GENERAL ELECTRIC

## ALL-WAVE RADIO

MERCHANDISE DEPARTMENT, GENERAL ELECTRIC COMPANY, BRIDGEPORT, CONN.

# Announcing TRIPLITT

VOLT - OHM - MILLIAMMETER

## IN KIT FORM!

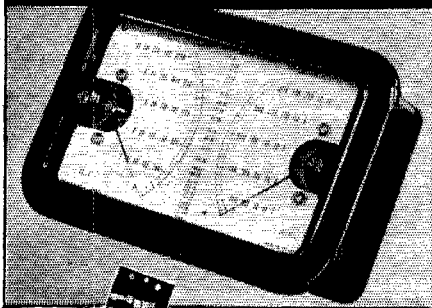

NO. 1200

**S**ERVICE men who want to build their own equipment, or who want to use instruments that can be made to fit special space and installation requirements, will be particularly interested in Triplitt No. 1200 Volt-Ohm-Milliammeter. Now, it is available in kit form, and is designed for use with built-in job equipment.

Every necessary item is included in this kit — and all assembly details have been carefully worked out. All you need is soldering iron and a pair of pliers. The complete kit includes these units:

Triplitt Twin Meter, net.....	\$10.33
Special Triplitt Selector Switch, net	1.67
Shunt Board for 1-10-50-250 milliamperes readings: 1500 ohms and 1.5 megohms, net.....	2.33
Resistor board for 10-50-250-500-1000 DC volts and 50-250-500-1000 AC volts and current limiting resistors for 1500 ohms and 1.5 and 3 megohms, net.....	4.83
.5 MFD Condenser for output measurements, net.....	.33
Rheostat Assembly, consisting of 65-6000-9000 ohm resistors for ohmmeter zero adjustments, net.....	1.67
Set of blue prints and instructions, net	.67
Hook-up wire, net.....	.33
No. 32 Triplitt test leads, net.....	.50

**SEE YOUR JOBBER**

See this complete kit at your jobber's  
Total price, complete kit, net to dealers.....\$16.67

**THE TRIPLITT ELECTRICAL INSTRUMENT CO.**

125 Main Street

Bluffton, Ohio, U. S. A.

chokes in circuits requiring the filament to be operated above ground potential. The current-carrying capacity of all three sizes is four amperes, so that the filament current of quite large tubes can be readily carried.

The new chokes are being marketed by Kaltman and Romander, 62 Court Street, Newark, N. J.

### A.R.R.L. QSL Bureau

**F**OR the convenience of its members, the League maintains a QSL-card forwarding system which operates through volunteer "District QSL Managers" in each of the nine U. S. and five Canadian districts. In order to secure such foreign cards as may be received for you, send your district manager a standard No. 8 stamped envelope. If you have reason to expect a considerable number of cards, put on an extra stamp so that it has a total of six cents postage. Your own name and address go in the customary place on the face, and *your station call should be printed prominently in the upper-left-hand corner*. When you receive cards, you should immediately furnish your QSL manager with another such envelope to replace the used one. List of managers follows:

- W1—Allen W. Jones, W1NW, 1626 Commonwealth Ave., Boston, Mass.
- W2—H. W. Yahnel, W2SN, Lake Ave., Helmetta, N. J.
- W3—R. E. Macomber, W3CZE, 418 10th St., N. W., Washington, D. C.
- W4—B. W. Benning, W4CBY, 520 Whiteford Ave., Atlanta, Ga.
- W5—E. H. Treadway, W5DKR, 2749 Myrtle St., New Orleans, La.
- W6—C. E. Spitz, W6FZQ, Box 1804, Phoenix, Ariz.
- W7—L. Q. Kelly, W7BPC, 4919 So. Prospect St., Tacoma, Wash.
- W8—F. W. Allen, W8GER, 324 Richmond Ave., Dayton, Ohio
- W9—George Dammann, W9JO, 319 Sherman Ave., Evanston, Ill.
- VE1—J. E. Roue, VE1FB, 84 Spring Garden Rd., Halifax, N. S.
- VE2—W. H. Oke, VE2AH, 5184 Mountain Sights Ave., N. D. G., Montreal, P. Q.
- VE3—Bert Knowles, VE3QB, Lanark, Ont.
- VE4—Dr. J. J. Dobry, VE4DR, Killam, Alberta.
- VE5—E. H. Cooper, VE5EC, 2024 Carnarvon St., Victoria, B. C.

### New High-Gain Audio Amplifier

(Continued from page 47)

is ample to modulate two 203-A's in Class-C.

When starting up the amplifier, snap on the control switch on the front panel and allow the cathodes to come up to temperature. Insert the meter plug in the Triadyne plate current jack and read the plate current. This should read about 90 milliamperes. Now turn on the r.f. am-

COMPLETELY REVISED  
TO MEET YOUR NEEDS!

# The New Log Book!

PARTICULARLY designed to comply in every respect with the detailed regulations of FEDERAL COMMUNICATIONS COMMISSION regarding logkeeping, providing for the recording of every item of required information, while at the same time reducing the maintenance labor to an absolute minimum. To this end places are provided on the inside cover and at the page heads to log basic information which may stand for long periods of time, and the actual logging of transmissions is reduced to a very simple operation. To accomplish this the column arrangement has been completely redesigned, resulting in the most convenient log it has ever been our pleasure to offer.

AMATEUR RADIO STATION LOG										
 Input power to last stage, _____ watts Frequency, _____ Type of emission, _____			If operating as portable or portable-mobile: Approximate location, _____ Type of vehicle or mobile unit in which installed, _____							
DATE TIME	STATION CALLED	CALLED BY	STATION HEARD OR WORKED			IF QSO RESULTED:				CHANGES FROM PREVIOUSLY RECORD- ED DATA, MESSAGES, REMARKS, ETC.
			KC. OR DIAL	R	S	T	R	S	T	

COLUMNS are provided for recording signal reports by the R-S-T method, both as to your observation of the station contacted and as to the other fellow's report of your signals. The QSA- and R- scales are given with suggestions for logging by that method if desired. Everything has been thought of. There is, for instance, a column for the time of end of QSO. The arrangement is such that the QSO's stand out on the page and may readily be spotted when looking up records. Moreover, the new page heading makes the log as useful for mobile or portable operation as it is for fixed. Covers contain frequently-consulted data on the R-S-T system of signal reporting, Q abbreviations, prefixes, abbreviations, etc.

*Thirty-eight ruled pages, one page graph paper  
with reverse side of all pages blank for notes*

IN BOOK FORM FORTY CENTS EACH,  
THREE FOR ONE DOLLAR, POSTPAID

**THE AMERICAN RADIO RELAY LEAGUE**  
WEST HARTFORD, CONNECTICUT

# Flash!

We are now making prompt delivery of this exceptional receiver

The New PR-12

# PATTERSON

AllWave Radio

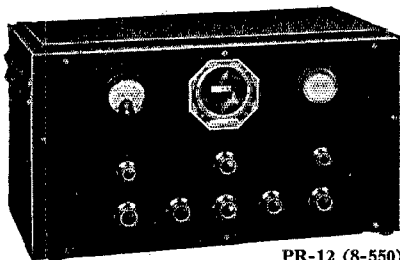

PR-12 (8-550)

Don't buy any receiver until you have tried the PR-12

Sold on five-day money-back trial

### NET DELIVERED PRICES COMPLETE

(absolutely nothing else to Buy!)

PR-12 Crackle cabinet without crystal **\$83.70** PR-12 Crackle cabinet with crystal... **\$89.70**  
 PR-12 Console without crystal **101.70** PR-12 Console with crystal... **107.70**

Chassis also available

**SHIPPED PREPAID** If Full Purchase Price Accompanies Your Order

### MARINE 140B

#### 100 WATT PHONE C.W. XMITTER

Many exclusive "MARINE" features ● Power Output (conservative rating) 100 WATTS PHONE and C.W. ● 20-40-75 and 160 meter bands ● CRYSTAL CONTROLLED FREQUENCY ● PERMANENT NEUTRALIZATION ● BUILT-IN BIAS SUPPLY ● HIGH-FIDELITY AUDIO CHANNEL ● Input Designed for Crystal Microphone Self Contained Antenna Matching Network

### VISUAL DISTORTION INDICATOR MODULATION PERCENTAGE INDICATOR

(Built-in Cathode Ray Oscilloscope)

CABINET DIMENSIONS

(Baked wrinkled enamel finish — with rear door)

60" high 19½" wide 15" deep

ONE YEAR UNCONDITIONAL GUARANTEE

Send stamp for descriptive folder with detailed information and photographs. You will be surprised at what we are offering at such an extremely moderate price.

## L. I. MARINE & ELECTRIC CO.

W2GOT — W2GRQ

163-18 JAMAICA AVENUE JAMAICA, NEW YORK

Telephones: JAmaica 6-2925, Night (long distance) LAurelton 8-4400

Cable Address: "ELECMARINE NEWYORK"

plier and high voltage supply. Open the gain control slowly and, with the meter plugged into the Class-B plate circuit, read the plate current. With no signal, the static plate current should read about 25 ma. for both tubes. To obtain this current the Class-B modulator negative grid bias should be about 35 volts for 1000-volt plate supply and 45 volts with 1250-volt plate supply.

When the static plate current is adjusted, the gain control can be opened until, when whistling into the mike, the Class-B plate current rises to the proper value for the load. Checking back on the plate current of the driver stage, it will be found that the plate current of these tubes increases from about 90 to 100 ma. This is not an indication of distortion but is normal for the 6B5 in the Hi-E circuit.

In presenting this new type of radio tube, the authors have been able to hit only the high spots in this brief discussion. It is our sincere hope that the information set forth will enable the amateur to grasp the fundamentals of 6B5 operation and to aid the construction of a high-quality modulator at minimum cost.

## Standard Frequency Transmissions

Date	Schedule	Station	Date	Schedule	Station
Mar. 1	A	W6XX	Apr. 5	B	W9XAN
Mar. 8	B	W9XAN		B	W6XX
	B	W6XX	Apr. 10	C	W9XAN
Mar. 13	C	W9XAN	Apr. 12	B	W9XAN
Mar. 15	B	W9XAN		A	W6XX
	A	W6XX	Apr. 17	BB	W9XAN
Mar. 20	BB	W9XAN	Apr. 19	BB	W6XX
Mar. 22	BB	W6XX		A	W9XAN
	A	W9XAN	Apr. 20	BX	W6XX
Mar. 23	BX	W6XX	Apr. 21	C	W6XX
Mar. 24	C	W6XX	Apr. 26	A	W6XX
Mar. 29	A	W6XX			

### STANDARD FREQUENCY SCHEDULES

Time (p.m.)	Sched. and Freq. (kc.)		Time (p.m.)	Sched. and Freq. (kc.)	
	A	B		BB	C
8:00	3500	7000	4:00	7000	14,000
8:08	3600	7100	4:08	7100	14,100
8:16	3700	7200	4:16	7200	14,200
8:24	3800	7300	4:24	7300	14,300
8:32	3900		4:32		14,400
8:40	4000				

Sched. & Freq. (kc.)  
 BX

Time (a.m.)	6:00	7000
	6:08	7100
	6:16	7200
	6:24	7300

The time specified in the schedules is local standard time at the transmitting station. W9XAN uses Central Standard Time, and W6XX, Pacific Standard Time.

### TRANSMITTING PROCEDURE

The time allotted to each transmission is 8 minutes divided as follows:

2 minutes—QST QST QST de (station call letters).

3 minutes—Characteristic letter of station followed by call letters and statement of frequency. The characteristic letter of W9XAN is "O"; and that of W6XX is "M."

1 minute—Statement of frequency in kilocycles and announcement of next frequency.

2 minutes—Time allowed to change to next frequency.

W9XAN: Elgin Observatory, Elgin National Watch Company, Elgin, Ill., Frank D. Urie in charge.

W6XX: Don Lee Broadcasting System, Los Angeles, Calif., Harold Peery in charge.



# THE RADIO SHACK

## QUALITY « « SERVICE « « FAIR PRICES

From the growth of our sales to amateurs the world over—it is plainly in evidence that dealing with the Radio Shack assures the buyer of all three essentials. We call it a Recipe for Growth. All the better lines in stock.

**YOUR DISCOUNT 40%**

*Your Order Shipped Return Mail*

2.5 volt 12 ampere filament trans. for 866s.....	\$1.25
10 volt 6.5A filament trans. (2-203A), \$2.10	
Resonant filter choke.....	\$3.60
8H — 300 mill input choke.....	\$2.50
Ohmite 200W Bleeders 100-100,000 ohms variable.....	\$1.50
Johnson 50 watt sockets.....	\$1.20

### THE NEW MAC-KEY

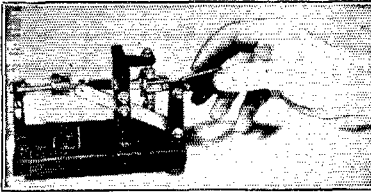

Oldtimers and commercial brass pounders alike enthusiastically acclaim this semi-automatic key as the greatest step forward in design yet accomplished. It is the last word in a telegraph instrument. The surest way to develop a good fist... **\$10.50**

Biley B C 3 Mounted Crystals. 3500 K.C. -7000 K.C.....	\$3.95
Biley Crystal Holder.....	\$1.00
General Radio Coil Form 677U.....	\$5.50
Pawood Circle Cutter No. 2.....	\$1.25
Cuts holes from 1" to 4"	
Pawood Circle Cutter No. 5.....	\$1.95
Cuts holes from 1" to 5"	
Three Wire Rubber covered shielded Microphone Cable, per foot.....	5c

DeForest 281.....	\$1.25
RCA Single button hand mike....	\$1.20
Monitor Can — steel, aluminum finish, 4 3/8 deep, 7 3/8 long, 5 3/8 high....	\$3.39
V.T. 203A Graphite.....	\$9.00
Readrite Milliammeters.....	\$5.99
<b>ALL-STAR KIT IN STOCK</b>	
HAIGIS 5M TRANSCEIVER.....	\$13.50
PEAK PRE-SELECTOR.....	\$19.80
GAMMATRON TYPE 354.....	\$24.50
Sickles 5M kit.....	\$1.20
Audio Transformer with mike....	\$1.20
Output transformer to match.....	\$ .90

#### CLOSE OUTS

Tobe 5 mfd. 1000V cond.....	\$2.00
Electro-Voice D.B. mike.....	3.95

#### TURNER CRYSTAL MIKE

\*\*\* \$12.00 \*\*\*

### INTERNATIONAL PLATE TRANSFORMERS

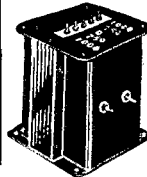

Outstanding for Value. 750 and 1000 volts each side of c.t. at 300 mills. Cased completely in steel. Crackle finish. Model 2000, **\$5.95**

Model 3000 — Same in appearance, 750-1000-1500 each side of c.t., 300 mills..... **\$8.95**

*We know of nothing that equals the value received in these two items*



Universal Model XX **\$5.88**

Lifetime D.B. **\$2.95**

Audiovox D.B. microphone and stand — outstanding value.. **\$4.20**

#### FILAMENT TRANSFORMERS

2 1/2 V. 12A. C.T. 5 V. 3A. C.T.....	\$1.20
2 1/2 V. 12A. C.T. 2 1/2 V. 3A. C.T.....	\$1.40
5 V. 3A.....	
6.3 V. 5A. 5 V. 3A.....	\$1.20
7 1/2 V. 3A. C.T. 5 V. 3A.....	\$1.20
2 1/2 V. 5A.....	\$1.00
7 1/2 V. 3A.....	\$1.00

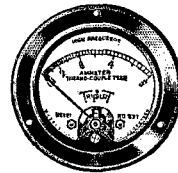

#### TRIPLET METERS

Service equipment. Complete stock of this high grade, low cost instrument line — 3 1/2-inch bakelite case milliammeters 0-5 to 0-100 mills **\$3.75**  
Thermo-ammeters 0-1, 0-2.5, 0-5..... **\$6.66**

<b>CARDWELL</b>	
156B — split Stator.....	\$3.60
157B — split Stator.....	4.80
164B — 220 mfd.....	2.40
T199 — 330 mfd.....	6.00
T183 — 110 mfd.....	5.40

<b>TRIAD</b>	
866s heavy duty.....	\$1.60
210 thoriated Tungsten.....	1.25
841.....	2.25
46.....	.55
83.....	.55

<b>NATIONAL</b>	
SW3.....	\$19.50
FB7.....	36.50
SRR cabinet.....	2.10
SW3 cabinet.....	3.30
SW3 coils per set..	3.00

<b>BALDWIN Type "C" PHONES</b>	<b>\$2.50</b>
<b>CLASS B 46 TRANSFORMERS</b>	
Input and Output to 5000 ohm load	
	<b>\$4.25 PER PAIR</b>

<b>DUNCO KEYING RELAYS</b>	
RA1 operates 2.5 volts a.c.....	\$2.00
RD1 operates 5.6 volts d.c.....	2.00

THESE ARE HIGH QUALITY PRODUCTS

### New Browning 35 Kit with the Tobe Tuner - PARTS IN STOCK

We think of nothing handier to have around a ham shack — 0-1 milli Triplet milliammeter..... **\$4.55**

<b>RAYTHEON</b>	RK20.....	\$15.00
	RK18.....	10.95
	RK23.....	5.95
	RK24.....	2.25

<b>USED</b>	
RCA 860.....	\$12.00
RCA 852.....	\$14.00
RCA 204A.....	\$20.00

Mail orders filled to any place in the U. S. Send check or money order—include postage. Prompt service. Foreign Friends: We cannot ship C.O.D. Please send money order or draft, including shipping charges.

## THE RADIO SHACK

46 BRATTLE STREET BOSTON

100 feet No. 14 enameled.....	49c
100 feet No. 12 enameled.....	.60c
Double silk or D.C. any size spool.....	.25c

# EIMAC

TRANSMITTING TUBES ARE  
UNSURPASSED

*Because of the following features*

Tantalum plate and grid ■ Ultra-high vacuum ■ Nonex glass ■ Oversize filament ■ Getter and internal insulators eliminated ■ Vertical bar "Ghost" grid ■ Low interelectrode capacities ■ High voltage breakdown ■ Low plate resistance ■ High transconductance ■ Flexibility over a wide range of frequencies and plate voltages.

TYPE 50T . . . . \$13.50

TYPE 150T . . . . 24.50

SOLD ONLY THROUGH DEALERS

"COMPARE AND REFLECT"

**EITEL-MCCULLOUGH, INC.**  
SAN BRUNO, CALIF.

## Schedules for WWV

EACH Tuesday and Friday (except legal holidays), the National Bureau of Standards station WWV will transmit on three frequencies as follows: noon to 1:00 p.m., E.S.T., 15,000 kc.; 1:15 to 2:15 p.m., 10,000 kc.; 2:30 to 3:30 p.m., 5000 kc. These emissions are accurate to better than 1 part in five million at all times and are readily useful for calibrating amateur-band frequency meters by harmonics from an auxiliary 100-kc. oscillator, as described in previous *QST* articles (June and October, 1933; February, 1934).  
—J. J. L.

## Rotary Polarity-Reversing Switch

SINCE the advent of auto radio sets a great many devices for obtaining high voltage from a storage battery supply have been introduced. Being built for a particular type of service, however, the output voltages and currents usually have been limited to those demanded by receive-



ing sets. A new motor-driven polarity-reversing switch capable of handling quite heavy currents, which recently has made its appearance on the market, offers a means of obtaining a fair amount of power for transmitters in both portable and rural service.

Models with motors designed for operation on 6, 12 and 32 volts are available. The switch contacts are rated to carry continuously 15 amperes at 6 or 12 volts, and 10 amperes at 32 volts. A 6-volt unit is illustrated. The motor speed is such that the effective frequency is about 50 cycles, so that transformers of ordinary characteristics can be used. Since the output wave form is not of the shape usually furnished by power lines, the transformer primary design will differ somewhat from the usual; for example, it is stated that a primary wound for 12 volts, 60 cycles, center-tapped, will function quite well when used with the 6-volt unit.

## TURNER CRYSTAL MICROPHONES HI-FIDELITY AND DIAPHRAGM TYPES

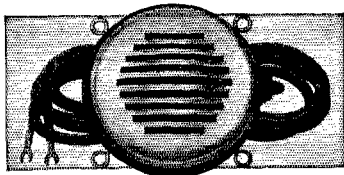

❖ Complete line of high gain crystal equipment, line amplifiers, pre-amplifiers, and associated equipment.

❖ Circulars describing any apparatus in which you may be interested will be sent on request.

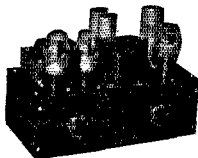

**THE TURNER COMPANY**  
CEDAR RAPIDS, IOWA, U.S.A.

# YOU CAN DEPEND ON G-E PYRANOL CAPACITORS

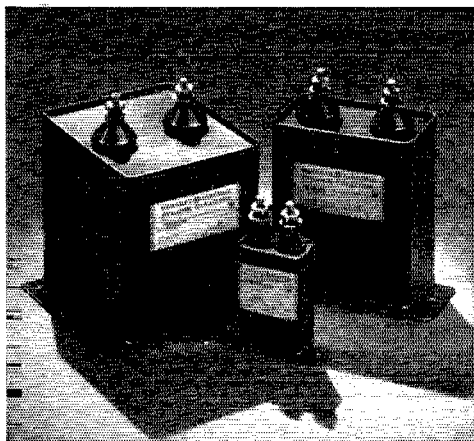

THEY'RE inexpensive, too, and scientifically designed. Years of experience in manufacturing capacitors for leading broadcast and short-wave communication stations and the government are built into them. Big, cumbersome capacitors need no longer use valuable space in your transmitter. Nor do you have to worry about fire — Pyranol won't burn. You can use more voltage — G-E Pyranol capacitors will stand the ripple, in addition to the rated d-c. voltage. They make possible better signals and have longer life. Get them from your dealer. Radio Department, General Electric, Schenectady, N. Y.

## GENERAL ELECTRIC

**GREATER POWER**

**ACCURATE CALIBRATION**

**LESS DRIFT**

**GUARANTEED OPERATION**

**FREQUENCY STABILITY**

**DURABLE MOUNTING**

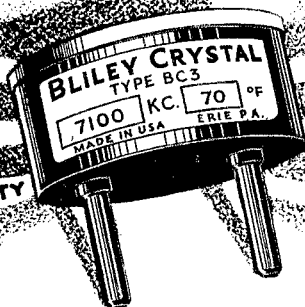

You wouldn't install a weak, worn-out tube in your transmitter — it hasn't the power; it drags down the operating efficiency of the rest of the equipment.

The same thing applies to crystal control. With poor crystals, the operating power of your transmitter cannot be depended upon and frequency stability is not assured.

It's good economy to use Bliley BC3 Mounted Crystals. They are made by specialists who devote their entire time to this occupation. Every Bliley Crystal is checked over 30 different times and is given final calibration in the holder. That's the

reason they are guaranteed .03% accurate in your set.

### BLILEY CRYSTALS from \$3.95 UP!

MC Band	Supplied to specified frequency within:			
	Exact Frq.	± 1Kc	± 5Kc	± 10Kc
7.0, 3.5	\$7.50	\$5.90	\$4.90	\$3.95
1.7	8.40	6.80	5.80	4.80

Special Crystals also manufactured between 20Kc and 15Mc.

Bliley Crystals are sold by all progressive distributors of amateur equipment. If our distributor doesn't have your choice in stock, he can get it for you quickly; order from him.



**BLILEY ELECTRIC CO., ERIE, PA.**



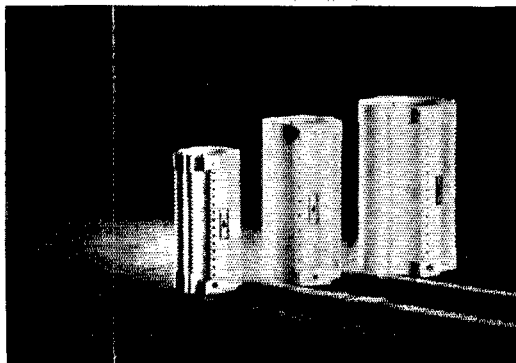

**TRANSMITTING COIL FORMS.** The popular coil forms XR-10, XR-11 and XR-12, are companion parts to the new TMC condenser. They are of low-loss Steatite and of well-proportioned efficient shape. Types XR-10A and XR-12A forms are also available at very low cost where the highest electrical efficiency is not essential.

**NATIONAL COMPANY, INC.**  
MALDEN, MASS.

## HEAR the NEW SHURE CRYSTAL MICROPHONES

*If you want—*

Relatively high output level due to exclusive Shure diaphragm design and cantilever crystal actuation . . . clear, crisp reproduction free from noise and "blasting" . . . sheer simplicity of operation without batteries, power-supplies or coupling transformers . . . rugged, dependable trouble-proof service . . . and professional appearance and performance

—then get the new Shure Model 70H Crystal Microphone.

This microphone contains a piezo-electric "Bimorph" crystal unit and is fully licensed under patents of The Brush Development Company.

Ask your Jobber for complete technical data.

A complete line of Crystal, Condenser and Carbon Microphones

**SHURE BROTHERS COMPANY**

"Microphone Headquarters"

215 W. HURON ST. CHICAGO, U. S. A.

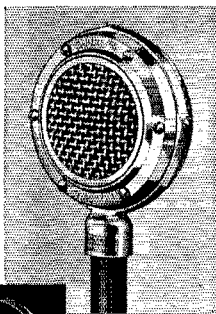

Shure Model 70H Crystal Microphone  
Mounts directly on stands or in carbon rings.  
List Price **\$22.50**

The new rotary reversing switch is manufactured by Industrial Products, Kaufman Building, Fargo, N. D.

## With the Affiliated Clubs

(Continued from page 55)

present membership consists of forty-five active hams. Meetings are held every third Monday, but a few hams will be found at the shack at almost any time. A 1.75-mc. 'phone transmitter is now under construction. The 1935 Louisiana Convention will be held under the auspices of the N.O.R.C. At the helm of this club at the present time are W5BPL, president; W5JW, vice-president and general counsel; W5ST, activities manager; and W5DKR, secretary-treasurer.

## Club Station Network

The Egyptian Radio Club (P. O. Box 751, Nameoki, Ill.) is interested in the possibilities of a network of club stations such as was mentioned in this department in January *QST*. The E.R.C. offers to help organize such a network. Being centrally located this club's station, W9AIU, might well be a nucleus around which a club station network might be built up. Clubs operating stations are urged to communicate with the gang at W9AIU, listing operating times, frequencies used, etc., so that preliminary steps may be taken to make a "club network" a reality.

## The Frontier Radio Club

A pair of 202's in parallel taking their power from a motor-generator driven by a fifty horse motor was probably the pioneer of club-owned transmitters in Canada. This rig was operated from a remodelled chicken coop, which then was the headquarters and club rooms of the Southern Ontario Radio Association of Windsor, Ontario, affiliated with A.R.R.L. on June 4, 1921. This organization was active until 1931. The beginning of the "depression" in 1929 and 1930 brought about pressure from many angles. The S.O.R.A. had graduated to a point where a real club room was necessary, but deflated pocketbooks made it necessary to disband, as far as a meeting place was concerned. But Windsor, Ontario, was not without a radio club for long. In 1932 the urge to reorganize found its mark, and one evening in the shack of VE3WX the Frontier Radio Club was born. Although the name chosen was different, practically all the old officers of the S.O.R.A. again took their places. The present executives consist of Fred J. Stoliker, BRS224, president; VE3WX, vice-president; VE3OE, secretary; VE3BZ, treasurer. A bi-monthly bulletin, "MIM," is issued to club members, with VE3QK as editor. Club rooms are located at 225 Sandwich St., West, Sandwich, Ontario. Visitors are most welcome at any time of day or evening. The guest register is never closed.

## A Unique Joint Meeting

When members of two clubs get together for a joint meeting it is usually "in the flesh"—seldom do we hear of meetings held "over the air," and it's news when it happens. One of the most unique meetings we have heard about for some time is the joint meeting held by the Schenectady (N. Y.) Amateur Radio Association and the Zero Beat Amateur Radio Club of Sydney, Australia, in early January. The S.A.R.A. members assembled in the studios of WGY and, through the medium of W2XAF on 9530-kcs., held the meeting with the Zero Beat chaps, who were gathered at VK2ME (9590 kcs.), Sydney. The meeting started about 7:45 a.m. E.S.T. with a talk on the Schenectady Club by President Eaton, W2DHS. He was followed by G. Movine of the Australian Club. Others who spoke were W2DTS, W2CGO, Ray Hutchinson of VK2ZD, Norbert Sauter (Schenectady), and G2KB of Rugby, England, who spoke from Schenectady on "An English Amateur's Viewpoint of Amateur Radio in the United States." This is believed to be the first time that two amateur radio club groups have held a joint meeting over such a distance! Arrangements for the meeting were made by W2ALP. Plans are being made for joint meetings between the Schenectady Club and clubs in South America.

# THE Amateur's BOOKSHELF

A balanced selection of good technical books, additional to the A.R.R.L. publications, should be on every amateur's bookshelf. We have arranged, for the convenience of our readers, to handle through the QST Book Department those works which we believe to be most useful. Make your selection from the following, add to it from time to time and acquire the habit of study for improvement. Prices quoted include postage. Please remit with order.

## RADIO THEORY AND ENGINEERING

**APPLIED ACOUSTICS**, by H. F. Olson and F. Massa. Covers theoretical and experimental aspects of electro-acoustical systems, including microphones and speakers. Requires knowledge of elementary physics and electric circuit theory. 430 pp., 228 illustrations. . . . . \$4.50

**THE PHYSICS OF ELECTRON TUBES**, by L. R. Koller. Written especially for engineers and students, this book presents the fundamental physical phenomena involved in the design and operation of electron tubes, emphasizing what goes on within the tube itself. 205 pp., 71 illustrations. . . . . \$3.00

**SHORT WAVE WIRELESS COMMUNICATION**, by A. W. Ladner and C. R. Stoner. Not a "how-to-make-it" book, but a text satisfying the needs of practical engineers and advanced amateurs by its thorough treatment of principles and practices in short-wave transmission and reception. The chapters on modulation, aeriels and feeders are especially good. 348 pp., 201 illustrations. . . . . \$3.50

**COMMUNICATION ENGINEERING**, by W. L. Everitt. A general text for both first year and advanced courses. 561 pp., 335 illustrations. . . . . \$5.00

**RADIO ENGINEERING**, by F. E. Terman. A comprehensive treatment covering all phases of radio communication. A good all around book for students and engineers. 688 pp., 318 illustrations. . . . . \$5.00

**MANUAL OF RADIO TELEGRAPHY AND TELEPHONY**, by Commander (now Admiral) S. S. Robinson, U. S. N.

Published by the Naval Institute. Covers both the theoretical and practical fields. 791 pp., 634 x 9 . . . . . \$4.00

**ELEMENTS OF RADIO COMMUNICATION**, by Prof. J. H. Mowcroft. This is the 2nd edition of this book by the author of the "Principles" listed elsewhere. It is about half the size of the larger work, and the subject is treated in more elementary fashion. Simple algebra is sufficient. An excellent book for the "first-year" student. 279 pp., 170 illustrations. . . . . \$3.00

**PRINCIPLES OF RADIO COMMUNICATION**, by Prof. J. H. Mowcroft. An elaborate general textbook, and one of the recognized standards on theory for the engineering student. A working knowledge of mathematics is desirable for the reader who expects to get the greatest benefit from this work. 1001 pp., 5 1/4 x 9 . . . . . \$7.50

**PRINCIPLES OF RADIO**, by Keith Henney. This book is chock-full of meat for the experimenter. The subjects treated range from the fundamentals of electricity to the modern concepts of modulation and detection. 477 pp., 306 illustrations. . . . . \$3.50

**THEORY OF THERMIONIC VACUUM TUBES**, by E. L. Chaffee. Based on Dr. Chaffee's research and study at Harvard University, this book offers much new material and many new presentations, especially in connection with regeneration. Recommended particularly for advanced study. 652 pp., 360 illustrations. . . . . \$6.00

## RADIO EXPERIMENTS AND MEASUREMENTS

**RADIO FREQUENCY ELECTRICAL MEASUREMENTS**, by H. A. Brown. A thoroughly practical book for the experienced amateur, the experimenter or engineer who has knowledge of the elementary principles of radio communication and of alternating currents. . . . . \$4.00

**HIGH-FREQUENCY MEASUREMENTS**, by August Hund. A thorough, modern book, especially useful in advanced laboratory work. Includes a chapter on piezo-electric determinations. 491 pp., 373 illustrations. . . . . \$5.00

**EXPERIMENTAL RADIO ENGINEERING**, by Prof. J. H. Mowcroft. An excellent laboratory text directed especially to

emphasizing the principles involved in the operation of radio apparatus and intended as a companion to the same author's "Principles." Following an introductory chapter on instruments and accessories, 51 choice experiments are outlined. 345 pp., 250 illustrations. . . . . \$3.50

**EXPERIMENTAL RADIO**, by Prof. R. R. Ramsey. Revised Edition. A splendid book for the experimenter. This is a laboratory manual, describing 128 excellent experiments designed to bring out the principles of radio theory, instruments and measurements. 150 illustrations, 229 pp., 5 1/4 x 7 . . . . . \$2.75

## COMMERCIAL EQUIPMENT AND OPERATING

**RADIO THEORY AND OPERATING**, by Mary Texanna Loomis. Although giving a moderate amount of theory, it is essentially a practical handbook for commercial and broadcast operators, and as such ranks among the foremost publications of this sort. Used as a textbook by many radio schools. A good book for any amateur. 1000 pp., 800 illustrations. . . . . \$4.25

**THE RADIO MANUAL**, by George E. Sterling. Another excellent practical handbook, especially valuable to the commercial and broadcast operator, and covering the principles, methods and apparatus of all phases of radio activity. Over 900 pp. . . . . \$6.00

**RADIO TELEGRAPHY AND TELEPHONY**, by Duncan and Drew. Still another work along the lines of a general practical handbook. In size it is approximately the same as the two listed just previously, and the subject matter generally follows along the same lines. A good book in this class. 950 pp., 468 illustrations. . . . . \$7.50

**HOW TO PASS U. S. GOVERNMENT RADIO LICENSE EXAMINATIONS**, by Duncan and Drew. Intended as a companion volume to "Radio Telegraphy and Telephony" by the same authors, as a guide to the applicant for commercial

licenses. It is not a text in itself. The chapter arrangement follows that of the sections of the commercial theoretical examination, each being made up of typical examination questions and their answers. 179 pp., 92 illustrations. . . . . \$2.00

**RADIO TRAFFIC MANUAL AND OPERATING REGULATIONS**, by Duncan and Drew. A book for students, amateurs or radio operators who contemplate entering the commercial field; it will enable you to learn quickly and easily all the government and commercial traffic rules and operating regulations. 181 pp. . . . . \$2.00

**PRACTICAL RADIO TELEGRAPHY**, by Nilson and Hornung. Written particularly for the student training for a commercial license, and covering theory and apparatus. A practical handbook. 380 pp., 223 illustrations. . . . . \$3.00

**RADIO OPERATING QUESTIONS AND ANSWERS**, by Nilson and Hornung. A companion volume to "Practical Radio Telegraphy" by the same authors. The latest Revised Edition is very complete, covering Commercial and Broadcasting, Amateur, Aeronautical and Police Radio, Beacons, Airways, Meteorology, and Teletype Operating. 389 pp., 5 1/4 x 8 . . . . . \$2.50

## MISCELLANEOUS

**SPEECH AND HEARING**, by Harvey Fletcher. The standard text on the subject. 331 pp., 154 illustrations. . . . . \$5.50

**THE RADIO AMATEUR CALL BOOK**. Lists all U. S. and foreign amateur radio stations, s.w. commercials and broadcasters. . . . . \$1.25 (Foreign \$1.35)

**BELOW TEN METERS**, by James Miller and R. S. Kruse. Ultra-high-frequency oscillators, radiating systems, receivers, theories, measurements, television reception, etc. Abundant photographs and diagrams. 64 pp. . . . . \$5.00

**ELECTRICITY, WHAT IT IS AND HOW IT ACTS**, by A. H. Krumboltz. A modern treatment with the electron as basis. It deals only with accepted theories, presenting them simply and straightforwardly so that those not mathematically

minded can understand them. Two volumes, 592 pp., 242 illustrations. . . . . \$4.00

**RADIO DATA CHARTS**, by R. T. Beatty. A series of graphic charts for solving, without the use of mathematics, most of the problems involved in receiver design. 82 pp., 8 1/4 x 11. . . . . \$1.50

**SERVICE RECEIVERS BY MEANS OF RESISTANCE MEASUREMENTS**, by J. F. Rider. 203 pp., 94 illustrations. An excellent book for the service man and amateur constructor. . . . . \$1.00

**WHO'S WHO IN AMATEUR RADIO**. Gives photos, personal and station data on over 3000 amateurs. Also includes comprehensive list of radio clubs, s.w. commercials, etc. 172 pp., 140 photos . . . . . \$5.50

American Radio Relay League, Inc., WEST HARTFORD, CONN.

# To

ENHANCE the appearance of  
your station

FACILITATE your reference work

PRESERVE the records of the ad-  
vancement of the radio art

## you need QST Binders

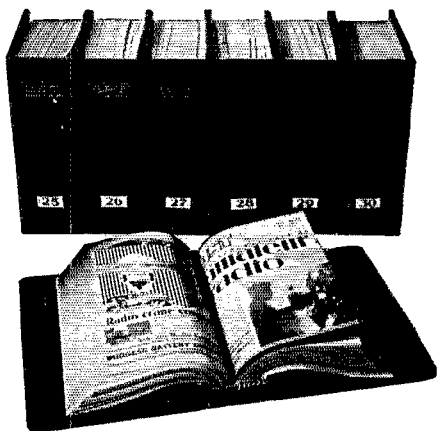

One for this year's issues and one for each of the accumulated year's issues that you have. It will accommodate twelve issues of QST and a yearly index. The QST Binder is covered in deep maroon cloth. It is cleverly designed to take each issue as received and hold it firmly without mutilation. It permits the removal of any desired issue without disturbing the rest of the file.

[Not available outside of the United  
States and Possessions, and Canada.]

A GOOD  
INVESTMENT AT **\$1.50** *postpaid*

NOTE: The illustration shows each binder with a yearly mark. This marking is not stamped on the binder. Simply cut the year label from a calendar, or paste on a piece of paper, marking it in your own handwriting.

**American Radio Relay League**  
West Hartford, Connecticut

## The Nashville Amateur Radio Club

The first annual banquet of the Nashville (Tenn.) A.R.C. was held on January 3rd. Among the contests included in the festivities were the correction of a diagram which contained several errors, and a symbol writing contest, the winner being the one who wrote the largest number of radio symbols. Election of officers for 1935 was held and the new officers installed. The installation ceremonies were amusing and may offer some suggestions. The president was crowned with a pasteboard coronet studded with jewels composed of elements of tubes long since departed this life. The vice-president, who is also chairman of the program committee, was presented with a collection of programs of various public performances that had taken place in the city. The secretary was presented with an alarm clock to help him keep the "minutes"! The treasurer was presented with a tin bank and a new penny. The club is issuing an official organ, "The Radiator," which is edited by W4DDF, and published monthly.

## New Club Government Plan

The Stockton (Calif.) Amateur Radio Club has revised its set-up to embrace the "committee plan" of government. Under this system the officers consist of (1) a manager, elected by the membership, (2) an assistant manager, appointed by the manager, and (3) a council of three, elected by the membership; two of the council are experienced amateurs and members of the club for one year or over, and the third is a representative of the less experienced amateur. The term of all officers is three months. The manager and assistant manager divide all duties of president, vice-president, treasurer, secretary and sergeant-at-arms between them. The "council" meets with the manager and assistant at least once a month to plan meetings, stunts and other activities, and acts as a committee to assist the manager and assistant whenever the manager requests such assistance. The council is, in effect, "activity director." Complete details on this new plan being tried by the Stockton Club may be secured from the manager, W6IKG, 120 S. El Dorado St., Stockton, Calif. The S.A.R.C. has a club news sheet, "The Fly Sheet."

## South Jersey Radio Association

For the past several years the South Jersey Radio Association has awarded a cup to the best all-around amateur station in South Jersey, within a radius of twenty-five miles from Camden. This contest is now in full swing and interest is greater than ever before. The S.J.R.A.'s policy is to conduct as little business as possible at the regular meetings. The major part of the club's affairs are taken care of by the directors, who meet each month a week in advance of the regular club meeting. This arrangement works out exceedingly well and allows more time at the meetings for the fellows to get together and chew the fat and have a good time, rather than sit and listen to a lot of "dry" business matters. An effort is made to have one main speaker at each meeting. Officers elected by the S.J.R.A. for the 1935 term are: W3ZX, president; W3BGP, vice-president; W3BEI, recording secretary; W3IS, corresponding secretary; John Burch, treasurer; and the following directors: W3QL, W3COT, W3DFK, W3BAY, W3CES, W3ACD, W3AN. Application for station license is being made.

## Kaw Valley Radio Club

The annual Christmas dinner of the Kaw Valley Radio Club, Topeka, Kansas, was a swanky affair—stag—at the Hotel Kansas on the night of December 23, 1934. Activities lasted into the wee hours. The principal interest of the club now is in enactment of the model interference ordinance in Topeka. Plans are already under way for the 1935 Kansas State A.R.R.L. Convention in Topeka next fall. An excellent paper, "Kan-Ham," is issued regularly. New officers recently elected: W9CET, president; W9BJJ, vice-president; W9FRC, secretary; W9DEB and Robert Thomas, executive committee. President W9CET has announced that the 1935 schedule will include social meetings and technical talks by outside talent, alternating. Meetings are held on alternate Fridays at 7:30 p.m. at the National Guard Armory. Visiting amateurs are invited to sit in on club sessions.

# SCIENCE gives you . . . . the Super SKY-RIDER



**the hallicrafters**

THE HALLICRAFTERS, INC.  
3001-I Southport Ave., Chicago, U. S. A.

Send me at once, without obligation, a complete description of the Super SKY-RIDER. Also tell me the name of my nearest jobber.

Name .....

Address .....

City ..... State .....

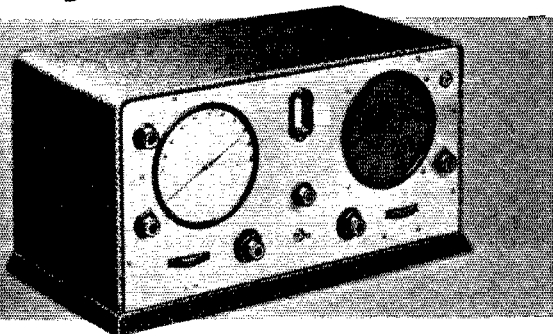

FROM exacting laboratories, with standards of vital precision, Science and keen Craftsmanship bring you the Super SKY-RIDER — the incomparable Amateurs' Short Wave Receiver. Here are just a few of the challenging features: • Four Short Wave Bands • 5 Band Selector Switch • Full 7 Inch Band-spread • Pre-Selection • Crystal Filter • Frequency Meter and Monitor • An Oscillator That Does Not Creep • Air-Tuned I.F.'s: Temperature-proof.

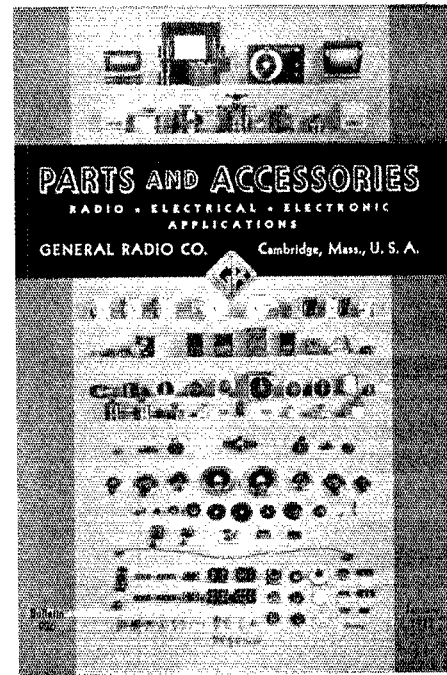

## Have You Received YOUR COPY of the New General Radio Parts Catalog?

Many new parts and accessories for the amateur and experimenter . . . condensers . . . dials . . . inductances . . . rheostats and potentiometers . . . voltage controls for the transmitter . . . sockets . . . plugs and jacks . . . transformers . . . frequency meters . . . meters . . . crystal holders . . . many other items of special interest to all QST readers in this new 48-page catalog.

Write for your copy of Bulletin 936-Q3

**GENERAL RADIO COMPANY, 30 State Street, Cambridge A, Mass.**



## A.R.R.L. EMBLEM

— insignia of the radio amateur

In the January, 1920, issue of *QST* there appeared an editorial requesting suggestions for the design of an A.R.R.L. emblem — a device whereby every amateur could know his brother amateur when they met, an insignia he could wear proudly wherever he went. There was need for such a device. The post-war boom of amateur radio brought thousands of new amateurs on the air, many of whom were neighbors but did not know each other. In the July, 1920, issue the design was announced — the familiar diamond that greets you at the top of this page — adopted by the Board of Directors at its annual meeting. It met with universal acceptance and use. For fourteen years it has been the unchallenged emblem of amateur radio, found wherever amateurs gathered, a symbol of the traditional greatness of that thing which we call Amateur Spirit — treasured, revered, idealized.

### Do You Wear the A.R.R.L. EMBLEM?

*The League Emblem, in heavy rolled gold and black enamel, is available in either pin or button type*

There are three special colors for Communications Department appointees. . . .

- ▶ Red background for the SCM
- ▶ Blue background for the ORS
- ▶ Green background for the RM and PAM

*Red and green available in pin type only, blue may be had in either pin or button style. All Emblems priced the same*

**\$1.00 POSTPAID**

**American Radio Relay League  
West Hartford, Connecticut**

## Oakland Radio Club

When the officers of the Oakland (Calif.) Radio Club took office in January, 1934, average attendance at meetings was from eight to twelve. Proving that a club can be raised out of the "dumps," at the close of the year the club boasted ninety-five members, plus many visitors! The club has its own transmitter capable of working on 3.5, 7 and 14 mcs., and a 56-mc. rig, which is very active. A 56-mc. contest held by the O.R.C. during December, 1934, had approximately one hundred participants! The contest was divided into two divisions, fixed and mobile stations. Winners of the fixed station group: W6ITH and W6HB. Mobile station winners: W6ATR and W6AGQ.

## Providence Radio Association Hamfest

Two hundred and thirty hams were present at the Providence (R. I.) Radio Association's third annual hamfest, January 19th. A receiver raffle, in charge of W1IIF, was won by W1IIF's twelve-year-old son! Real father-and-son cooperation! Among the speakers were Director Bailey, W1KH, A.R.R.L. New England Division, Fieldman Hebert, W1ES, and O. H. Brewster. W1FZG made only three mistakes in the C.W. contest to take first place. The speed was 35 w.p.m.! In the afternoon, at the club rooms under the 80-foot steel towers, the club's 3.5-mc. transmitter, W1INM, and 56-mc. rig were on the air. Round table discussions were held by Army Net members, Naval Reservists, N. E. Phone Association and O.R.S. All eyes are now focused on 1936 and the "fourth annual."

## Columbus Amateur Radio Association

On January 4th the Columbus (Ohio) Amateur Radio Association moved into new quarters in the Deshler-Wallick Hotel. Officers just elected: W8IUE, president; W8JAL, vice-president; W8GDC, secretary; W8CBF, treasurer; W8LJ, W8AYR and W8IUS, directors. The Association held its annual Christmas party on December 21, 1934. This party was one of the largest turn-outs the club has had, the attendance being about seventy-five. The C.A.R.A. meets on alternate Fridays. All hams are cordially invited to attend meetings. One dinner meeting is held each month, after dinner the members proceeding to the club rooms for the regular meeting.

## Visit the Clubs

Clubs are splendid places to get acquainted with other amateurs and to participate in interesting discussions on amateur radio. Do you want to be put in touch with a club in your vicinity? Would you like to attend a club meeting in another city you are visiting? The addresses of the several hundred amateur radio clubs affiliated with A.R.R.L., their places and times of meeting, are recorded at headquarters. Address the Communications Manager (enclosing 3¢ stamp, please) for data on Affiliated Clubs in your vicinity.

## Miscellany

The Sioux Falls (S. Dak.) Amateur Radio Club on January 22nd held its second annual banquet . . . a 56-mc. demonstration by W9AJP, W9DIY, W9JLI and W9RWE was very successful . . . South Dakota S.C.M. W9PFI was master of ceremonies. . . . The Jackson (Mich.) Amateur Radio Association will soon have its own transmitter on the air . . . new officers for this Association: W8IGL, president; W8LKV, vice-president; W8BNS, secretary; W8JSK, treasurer. . . . The Mississippi Valley Amateur Radio Club of Carthage, Ill., is publishing a sheet in the interests of its members and other hams in that area . . . copies are mailed to approximately one hundred amateurs within fifty miles of Carthage . . . new officers, M.V.A.R.C.: W9PME, president; W9HQJ, vice-president; W9RAQ, secretary-treasurer; W9BUA, sergeant-at-arms. . . . The Dartmouth College Radio Association, Hanover, N. H., is off to a fine start in 1935 with eleven licensed operators and rigs on 3.5-mc. c.w. and 'phone, 7-mc. c.w., 14-mc. c.w. and 'phone and low-power rigs on 56 and 28 mc. A 1.75-mc. 'phone outfit is under construction. . . . Listed among the officers of the Portland Sevens Club, Portland, Oregon, we find the office of "Janitor"! Perhaps that's a good way to get some one to do the work. . . . Most all of the actual "business" in the Connecticut Brass



# FOR TRANSCEIVERS AND PORTABLE RECEIVERS

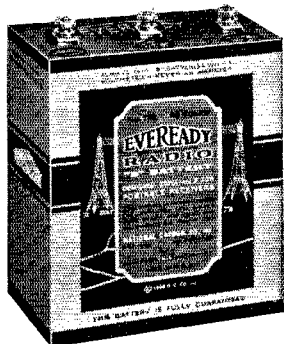

# EVEREADY

No. 762

45 Volt "B" Battery

5½ x 4⅞ x 2⅝ in. — 3 lbs. 2 oz.

List Price \$1.20

**NATIONAL CARBON COMPANY, INC.**

General Offices: New York, N. Y. Branches: Chicago, San Francisco

Unit of Union Carbide  and Carbon Corporation

## LEARN RADIO

New Classes Now Forming! Send for 40-page catalog, explains fully. 190 licensed graduates placed in past 3 years in broadcasting, shipping, police radio, aviation, etc. We teach all branches. Oldest, largest and best equipped school in New England. Equipped with Western Electric sound and broadcasting equipment and RCA marine transmitter. Course prepares for United States Government telegraph or telephone license.  
**MASS. RADIO SCHOOL, 18 Boylston Street, BOSTON**

## PANELS — BAKELITE — RUBBER — ALUMINUM

All Sizes Cut to Order  
**BAKELITE TUBING & RODS**  
*Drilling, Engraving & Special Work*  
**ALUMINUM CANS**—Stock sizes, Special sizes, made to order.  
**ALUMINUM CHASSIS**—Threaded brass studs for 6/32 screws. Length from ½" to 6"—price 5c to 30c.

Insulating bushings for all size shafts  
Couplings in brass or Bakelite—15c  
Bakelite Tubing Threaded to Specifications.

**UNITED RADIO MFG. CO.** Est. 1923 191 Greenwich St., New York

## IN THE WEST

The AMATEUR'S Headquarters  
are at the

## RADIO SUPPLY CO.

912 So. Broadway, Los Angeles, Calif.

All the latest Nationally Advertised  
Parts and Kits in stock at all times

9 Licensed Amateurs on our staff at your service

## For Transceivers, Amplifiers And Power Units

THE NEW  
TYPE EB-9080



LONG LIFE  
HI-FORMATION DRY  
ELECTROLYTIC FILTER

Plus that extra measure of C-D HIDDEN QUALITY Your eye can't see it, but the C-D label guarantees the QUALITY within. This condenser affords pure D.C. output, ideal for low power transceivers.

LIST PRICE \$1.05. YOUR COST .63

Yes! C-D H.Q. is yours at no extra cost. Your catalog 128 is ready Send for it! All the dope you want on hi-voltage x-mitting condensers.

**CORNELL-DUBILIER**  
CORPORATION

4373 BRONX BOULEVARD  
NEW YORK

# Are YOU COMPLYING

with the new

## REGS

on log keeping

?

★ SEE PAGE 85 ★

A. R. R. L.

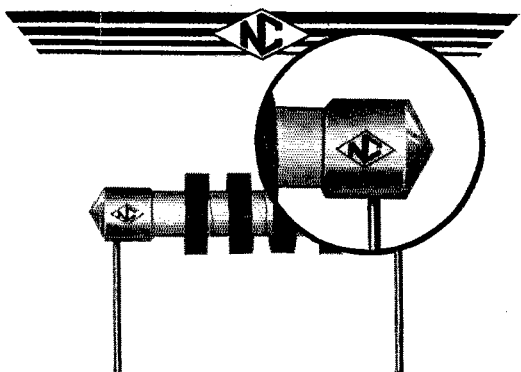
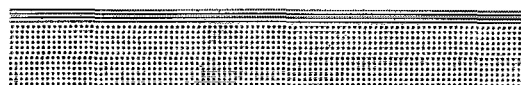

Appearance is much easier  
to imitate than performance

PATENTED

**NATIONAL COMPANY, Inc.**  
**MALDEN, MASS.**



Pounders Association (WICBA) is conducted by the club directors . . . the directors consist of the regular club officers plus three additional members. . . . The Suburban Order of Shortwavers have changed their name to the Desplaines Valley Radio Association, with headquarters at Brookfield, Ill. . . . Included in the Birmingham (Ala.) Amateur Radio Club's program for the next six months are plans for a new transmitter, rack and panel style, and portable equipment. . . . Flash!! Did you ever see 1300 hams all under one roof? Believe it or not, 1376 hams and YLs actually did register at the second annual New England hamfest held under the auspices of the South Shore Amateur Radio Club (Quincy, Mass.) and the Eastern Massachusetts Amateur Radio Association at the Hotel Bradford, Boston, on February 2d . . . a year ago 700 attended a hamfest under the auspices of those clubs . . . attendance practically doubled this year . . . 19387 . . . The Cheater (Penna.) Radio Club (W3BKQ) is operating a 1.75-mc. 'phone . . . a hamfest on February 16th inaugurates an active program for 1935, which includes a stab at B.P.L. honors in traffic work. . . . The Victoria (B. C.) Short Wave Club held its annual banquet on January 9th . . . the banquet was followed by competitions for which prizes were donated by local radio dealers . . . VE5NS, the newest ham in Victoria, snagged the high-speed code-copying prize! VE5JC was presented with a cup, an award posted by the club for the first member-amateur to QSO England and present a QSL card proving it. . . . The Jamestown (N. Y.) Amateur Radio Association looks forward to a year of much activity . . . plans are being discussed for permanent club rooms and a club station. . . . The Portland (Maine) Amateur Wireless Association reports much interest in 56-mc. activities . . . several members had quite a thrill during January when they QSO'ed W1EHOM from his plane as he flew over that territory. . . . The Ocean County Radio Association, Lakehurst, N. J., is planning for some "2 1/2"-meter experiments in the near future . . . more dope later. . . . The Associated Radio Amateurs of Southern New England (Providence, R. I.) elected: W1AVH, president; W1BGA, vice-president; W1DYD, secretary; W1EJ, treasurer. . . . On January 12th, the Mound City Radio Amateurs, St. Louis, Mo., celebrated their second anniversary . . . officers elected for the new term: W9TA, president; W9KFL, vice-president; W9BSH, secretary; W9FQY, treasurer. . . . The Cornhusker Amateur Radio Association, Lincoln, Nebr., announces new officers: president, W9HZC; vice-president, W9ONM; secretary-treasurer, W9OKG. . . . The C.A.R.A. invites visitors at its meetings on the first Tuesday of each month. . . . Meeting place: Y.M.C.A. Building. . . .

—E. L. B.

## **Strays**

Early in January the summer home of Larry Cumming at Shore Acres, Cape Elizabeth, Maine, where W1FB is located, was broken into and about eight hundred dollars worth of transmitting apparatus, power packs and short-wave receivers were stolen. Although the house was not occupied during December and early January, a card from Honolulu acknowledging QSO with W1FB has been received, indicating that some one has been using the call, possibly from the station itself. Stations having logged either W1FB or W1BV during December are requested to communicate with Larry Cumming at the above address. Information about the equipment itself also would be appreciated.

Not the least of the nasty features about this case is the fact that the thieves soaked the attic of the house with kerosene and set fuses, with the intention of burning down the house and destroying the evidence. Larry is of the opinion that an experienced ham did the job, since the selection of equipment was intelligently done. Not a nice thought that we have people of that sort in the game.

# Unconditionally Guaranteed!

## WHAT OTHER CRYSTAL OFFERS THIS PROTECTION?

**P**REMIER Isolantite holders, provided with calibrated Crystals, are sealed as shown in the illustration. The frequency is marked on a permanent nameplate and it is impossible to open the holder without breaking the seal. All Premier Crystals are guaranteed, unconditionally, against defective workmanship, materials and to be accurate within  $\pm .005\%$ . The seal and guarantee are exclusive Premier features. They are your **PROTECTION** and **ASSURANCE** that you are buying the finest equipment of its type obtainable.

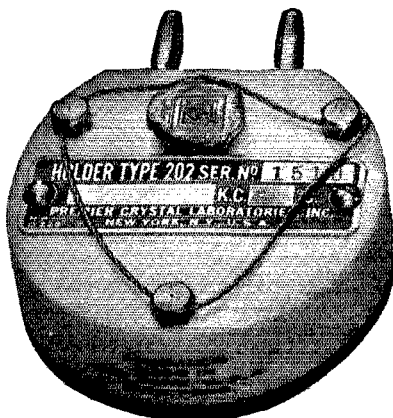

*Type 202 Precision Pressure Holder, illustrated, together with fifteen other types, is fully described in BULLETIN-103, just off the press. Send for your Free Copy.*



**PREMIER CRYSTAL LABORATORIES, INC.**

**53 PARK ROW, NEW YORK, N. Y.**

### METER REPAIRING OF ALL KINDS

Will re-build that old Jewell or Weston meter to a 0-1 M.A. milliammeter for \$3.00 even if it is burned out. Also convert to a current sensitivity as high as 100 microamperes when desired. Thermo-couples repaired for \$2.00 and up. Your complete satisfaction or money back, every customer must be satisfied.

WRIGHT'S ELECTRICAL INSTRUMENT LABORATORY  
5214 S. E. 87 Avenue Portland, Oregon

## PYRANOL 2 Mfd. 2000 V. TRANSMITTING CONDENSERS

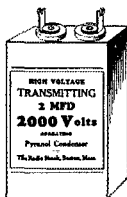

● They can take it . . . not for just months but for years. . . . Believe us you can forget your filter troubles once you have installed these Pyranol units.

● The major broadcasting stations and laboratories are all using them . . . and many of them have bought them here. . . . Manufactured by an electric company of world renown. Mail orders filled. Send M.O. Include postage. **\$2.50**

After March 15 the price will be **\$2.90**

**THE RADIO SHACK**  
46 BRATTLE STREET BOSTON, MASS.  
Dept. ML

if

IT'S A MATTER  
OF RESISTANCE

SEND FOR  
WARD LEONARD  
CIRCULAR NO. 507

The new 1935 Ward Leonard Circular 507 gives you information about Grid Leaks, Bleeder Resistors, Center-Tapped Resistors and a host of other handy items that Ward Leonard manufactures for the amateur enthusiast.

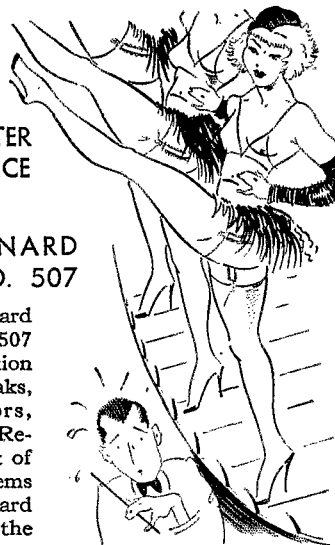

### WARD LEONARD ELECTRIC COMPANY

41 South St., Mount Vernon, N. Y.

Please send me free Circular No. 507 about W. L. Resistors.

Name .....

Street .....

City and State .....

Call Signal .....



**Nuts . . . are not  
the only things  
that come from  
Brazil!**

*We use only the best selected Quartz from  
Brazil in making Piezo-Electric Crystals*

No Crystal ever leaves our Laboratories unless it is ground to an Accuracy of **BETTER** than .01% of your specified frequency in order to meet **OUR OWN** Specifications.

### AMATEURS

Crystals are supplied to within 5KC of your specified frequency in either 80 or 160 meter band, \$15.00 each unmounted. Calibration supplied accurate to *Better* than .03%.

**"THE CRYSTAL SPECIALISTS"**

*Send for Booklet and Price List*

*Scientific*  
**RADIO SERVICE**

124 Jackson Avenue, University Park  
Hyattsville, Maryland, Q-3-35

**"WORDS TO THE WISE OMs"—**

## HEADQUARTERS

for

**STANDARD SETS AND PARTS  
MADE BY REPUTABLE AND  
RESPONSIBLE MANUFACTURERS**

Our reliability gives us the privilege of representing the following leading manufacturers:

**NATIONAL COMPANY  
HAMMARLUND MFG. CO.  
RCA-VICTOR COMPANY  
GENERAL ELECTRIC COMPANY  
PATTERSON RADIO CO.  
COLLINS RADIO COMPANY  
RADIO MFG. ENGINEERS  
AND MANY OTHERS**

*Satisfaction Guaranteed—Full Credit Allowed in  
Exchange for Another Make within Ten Days*

Write for full details on the

**DEL-RAD EASY PAYMENT PLAN**

**DELAWARE RADIO SALES CO.**

405 DELAWARE AVENUE

**WILMINGTON (W3DQ) DELAWARE**

New York Branch

11 W. 42nd St., N. Y. C.  
W2KR

Est.  
1920

Canadian Representative

J. L. Walker (VE3JI)  
Rockcliffe, Ont.

## Strays

W6MR not only has made WAC but also claims to have worked a dog. Upon inquiry the dog turned out to be a "K9"!

### Hartford-Boston Link

*(Continued from page 16)*

bands are so nearly the same—120 mc. being superior at one time, with 60 mc. forging ahead for the next session. The whole thing is a race which simply must be run to a conclusion.

#### ACTIVITIES ELSEWHERE

These two stations are, of course, by no means the only ones operating on 2½ meters. A large group of stations is already active in the New York area and have found the performance in no way inferior to five meters for around-town working. Another group is active in Boston and doubtless the activity has already spread across the country. The whole affair may sound to some like a song and dance over nothing, but this, actually, is very far from the fact. If only we can establish that the ultra-ultra-high frequencies are as good or better than 56 mc. we can avail ourselves of a most glorious field for practical work. Directive antennas will become small enough to be possible in any location and under almost any circumstances; "brass wheels" for directing the beam will at last come into their own and rag-chewers will be able to revel in the grand open spaces made available.

#### DOINGS ON 56 MC.

Of course, things are by no means at a standstill on 56 mc. Reports from most parts of the country indicate that directive antennas are showing their worth and that more long-distance links will soon be in operation. The study of 56-mc. behavior at W1HBD is still being continued—the station being operated on schedule every morning and night and continuous recordings being made of signals from W1XW. The complete curve of performance since August 11th (when Hartford was first directly linked with Boston) shows quite definitely that winter conditions are not as favorable as those of the warmer months for long-distance indirect-path working. The winter signals are a great deal steadier than those of the summer but they are stabilized at a lower level. This has meant that while communication has been maintained with hardly an exception with the Boston area, this communication has usually only been possible with stations having favorable locations. Signals which were available during the warmer months from stations at relatively unfavorable locations would now appear to be just below the limits of audibility most of the time. Only when conditions are good do they poke their heads above the background noise.

All of which reminds us that there seems to be some considerable misunderstanding with respect

**How to  
become  
A RADIO  
AMATEUR**



\*\*\*\*\*  
Published by the American Radio Relay League, Inc., West Hartford, Conn.  
Price 25 Cents

TO GET STARTED IN AMATEUR RADIO OBTAIN A COPY OF

*The 1935 Edition of*  
**HOW TO BECOME A  
RADIO AMATEUR**

(No. 8 in the A.A.R.L. series entitled The Radio Amateur's Library)

Completely done over in 1935 style, telling all about amateur radio and describing the latest equipment.

- push-pull crystal transmitter
- handsread receiver
- simplest of monitors
- giving modern operating instructions

The fourth edition of "How to Become a Radio Amateur" marks another milestone in amateur development.

Universally recognized as the standard elementary guide for the prospective amateur, the 1935 edition

of HOW TO BECOME A RADIO AMATEUR describes, in clear, understandable language, apparatus incorporating features hitherto confined to more advanced stations. Although completely modernized, the station can still be built at a minimum of expense, and the designs have been made flexible so that parts out of the junk box readily can be substituted. While easy to build, the performance of the equipment is such that any amateur can own and operate it with satisfaction and pleasure. Complete operating instructions and references to sources of detailed information on licensing procedure are given, as well as a highly absorbing narrative account of just what amateur radio is and does.

25c (no stamps, please) postpaid anywhere

THE AMERICAN RADIO RELAY LEAGUE, WEST HARTFORD, CONN.

**New QUIET VOLUME  
CONTROLS and RESISTORS  
for Every Amateur Purpose**

Write Dept. Q  
for Catalog.

175 Varick St., New York, N.Y.  
**ELECTRAD**

**PRECISION CRYSTALS**

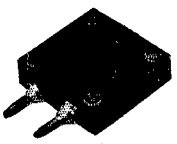

Crystal Holder—\$1.00

'X' and 'AT' cut crystals one inch square carefully ground for frequency stability and maximum output. Be sure of your transmitter frequency — use **PRECISION CRYSTALS**. Guaranteed to be the highest quality obtainable.

'X' cut **PRECISION** Crystals carefully ground for maximum power supplied to your specified frequency accurate to 0.1% and calibrated to within 0.03% are priced as follows:

1750 and 3500 kc. bands—\$3.00 each. 7000 kc. band—\$3.50. Add \$1.00 to above prices if plug-in, dustproof holder is desired. Jacks to plug holder into—\$.15 pair.

The 'AT' cut crystal recently developed has a temperature coefficient of practically zero and will handle more power than ordinary crystals. 'AT' cut crystals ground to your specified frequency accurate to 0.1% and calibrated to within 0.03% are priced as follows: 1750 and 3500 kc. bands — \$6.00 each. Crystal holder — \$1.00. Jacks for holder \$.15 pair.

Crystals and ovens for commercial use quoted on at your request. When ordering our product you are assured of the finest obtainable. Now in our sixth year of business.

**PRECISION PIEZO SERVICE**

427 Asia Street      Baton Rouge, La.

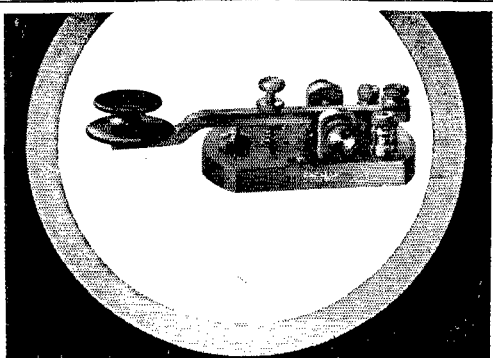

**WIRELESS KEYS**

Signal Standard Wireless Keys are now equipped with Navy type key knob. They are available in 3/16", 1/4" and 3/8" coin silver contacts.

Write for illustrated circular.

**SIGNAL ELECTRIC MFG. CO.**  
Menominee, Michigan

OFFICES IN PRINCIPAL CITIES



# ACME-DELTA

## COMPLETE POWER SUPPLIES REALLY HANDLE CLASS B!

(As used by James Millen. See Oct. '34 QST)

AD-60

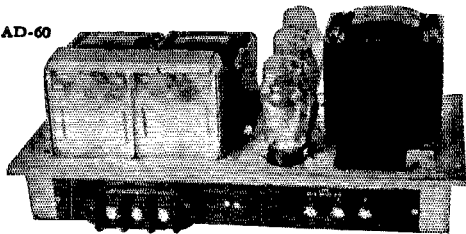

Standard Input 115 V., 60 Cycle, A.C.

Cat. No.	D.C.		Rect.	Ripple %	Reg. %	List Price
	Volts	Amps.				
AD60	1000 & 500*	.250 total	3-83	0.20	11	\$100
AD63	1250 or 1000	.400	2-66A	0.15	10	\$160

\*Note: No filter included for 500 Volt tap. Auxiliary filter required—two AD44 Chokes and one 2 x 8 mfd. Electrolytic Condenser. List prices are less tubes and subject to change without notice. Authorized distributors extend 40% discount to amateurs and experimenters. We also sell components. Send for Bulletin DL-48-13. Also DL-48-34 on Class B Amplifiers.



**RAYTHEON MANUFACTURING CO.**  
ELECTRICAL EQUIPMENT DIVISION  
190 Willow Street, Waltham, Massachusetts  
Successor to Delta Manufacturing Co.

### WESTON METER BARGAINS

ALL GUARANTEED  
All meters are reconditioned except where marked new  
Mod. 301 Milliammeters 0-1..... \$5.00  
Any range 3-500 M.A. .... 3.50  
Mod. 423 0-2 Amp. R.F. proj. case, new..... 6.50  
Other ranges to 5 Amp. reg. case ..... 6.50  
Mod. 476 A.C. Voltmeters 0-10, 15..... 4.00  
Complete Multimeter, 8 ranges..... 12.00

METER-LAB.

Limited Quantities — Free Bulletin  
224 New Haven Avenue  
Far Rockaway, L. I., N. Y.

## BIRNBACH Superior INSULATORS

DEPEND ON BIRNBACH for the largest and most complete variety of high-grade insulators and antenna equipment. "Navy-Type" Insulators with center anchor-hole for transmission line, and "Wing-Nut" Feed-Thru Standoffs now popular with amateurs. Strong, highly-glazed ceramic, rounded corners and edges, nickel-plated brass hardware.

### New R.F. TRANSMISSION-LINE FEEDER CABLE



The greatest advance in antenna arrangement in recent times. Scientifically designed twisted-pair feeder system which enormously improves efficiency of matched-impedance doublet antennae. Two low-resistance tintined solid copper conductors, impregnated with low-loss insulation (4 to 5 times more moisture and weather-proof than rubber) and spaced for 72-ohms line impedance. Dielectric strength between conductors exceeds 25,000 volts. Capacity between wires, .0008 mfd. per 100 ft. of line. Attenuation less than 1.5 db. per 1,000 ft. of line at 3,500 kc.

**BIRNBACH RADIO CO., Inc.**  
145 HUDSON STREET NEW YORK CITY

Write Dept.  
Q-4 for  
Details



to the apparent route taken by ultra-high frequency signals over the indirect paths. The signals obviously do not result from a "ground wave" in the ordinary sense of the word. Nor, would they appear to travel through, or rather, to be influenced by, the Kennelly Heaviside layer. The signals would seem to travel in the lowest atmosphere in which they are bent around the earth's curvature. The actual cause of the bending has not yet been established but there is no possible question about the fact that the bending is increased at times when a temperature inversion exists over the path. This is another way of saying that a layer of warm air on top of colder air accompanies the bending of the ultra-high frequency waves. Other factors—the humidity gradient in the atmosphere, for one—undoubtedly are concerned and we have purposely avoided any conjecture until our study has progressed further. We make this mention of our current knowledge of the matter simply to keep the record straight.

### CHANGES AT W1HBD

The transmitters on 5 and 2½ meters (they were described in February QST) have now been rebuilt with linear plate tanks to the tune of much higher efficiency. These plate tanks consist of a pair of ¼-inch diameter copper tubes approximately one-quarter wave long. The open ends of the line are connected to the two plates, high voltage being supplied at a jumper constituting the closed end of the line. The arrangement has been found very worthwhile. It is hoped that space will allow a description of these modifications together with the 2½-meter array in an early issue. In the meantime we return to the business of the battle between 56 mc. and the still higher frequencies. And in closing, we offer our sincere thanks to the operators of W1XW and W1FQV for their fine work. The battle could not continue without them.

### Correction

In the article "Stabilizing the Ultra-High Frequency Transmitter" in last month's QST, the desirable dimension ratio for a concentric line was stated incorrectly. The ratio mentioned on page 15 of that article should be between 3 and 4 for both the concentric and open type lines. A ratio between 9 and 10 is used to obtain the highest impedance value with either type of line.

### Simple Photographic Recorder

(Continued from page 28)

four inches an hour. The drum will also be considerably higher and the focal length of the lens considerably longer. This will then permit the mounting of perhaps four or five meters one above the other so that simultaneous records may be made of signals on different ultra-high frequency bands. Some of the available meter holes may be filled with other instruments such as a hygrometer, barometer and thermometer. And that, by the way, is one very great advan-

The ONE book NO radio amateur can do without



# THE RADIO AMATEUR'S LICENSE MANUAL

(No. 9 in the series entitled The Radio Amateur's Library)

Mr. Ham — prospective or present: The License Manual is an indispensable necessity when you (1) secure new licenses; (2) renew old (prior to October, 1933) licenses; (3) secure modification for change of address, etc. Whether it's the Class A, B, or C exam you're going to take — whether you're a beginner or an already licensed amateur — you need the manual for its instructions on where to apply; how to go about it in the right way; and, most important of all, for the nearly 200 typical license exam questions and answers.

All the dope on every phase of amateur licensing procedure, brought completely up-to-date in this new fifth edition — and, of course, the complete text of the new Federal Communications Commission regulations and pertinent extracts from the basic communications law.

Order your copy today, 25c postpaid (no stamps, please)

THE AMERICAN RADIO RELAY LEAGUE  
WEST HARTFORD CONNECTICUT, U. S. A.

## Best Way to Learn Code



Increase Sending and Receiving Speed! Instructograph teaches you quickly at home. Provides regular, systematic code practice — any time, any speed. Book of Instruction explains each step just as an instructor would do. No experience necessary. Machines, Tapes and Book of Instruction for sale or rent. One additional month FREE if rented for two months.

Write for FREE folder!  
INSTRUCTOGRAPH COMPANY  
912 Lakeside Place, Dept. Q-15, Chicago, Ill.

## GULF RADIO SCHOOL

Radiotelegraphy

Radiotelephony

Radio Servicing

SECOND PORT } 1007 Carondelet Street  
U. S. A. } NEW ORLEANS, LA.

28 and 56 M.C.

### TWIN-TRIODE

- TRANSCEIVERS
- DUPLEX UNIT TRANSMITTER-RECEIVERS

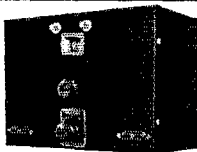

TRANSCEIVERS, each employing push-pull oscillator, Class B modulator, 19, 53 or 6A6 tubes, 10" x 7" x 5".

\$22.50 and \$26.50

COMBINATION-TRANSMITTER-RECEIVER UNITS, each with push-pull oscillator, Class B modulator transmitter and separate receiver employing r.f. stage. Built-in dynamic speaker. 10" x 14" x 5", 19, 53 or 6A6 tubes.

\$36.75 and \$39.75

Write for prices on custom built equipment

Bulletins on Request

RADIO TRANSCEIVER LABORATORIES

8627-115th Street

Richmond Hill, N. Y.

## HIPOWER CRYSTALS

Now available at your dealer

Accept no other

### HIPOWER "A" CUT

HANDLES 300% MORE POWER

HIPOWER "A" CUT in 1700-3500 Kc. Bands	\$3.90
within 10 Kc. or choice of dealers stock	
HIPOWER "X" CUT in 1700-3500 Kc. Bands	\$2.35
within 10 Kc. or choice of dealers stock	
HIPOWER "Y" CUT in 1700-3500 Kc. Bands	\$1.35
within 10 Kc. or choice of dealers stock	

You cannot buy a better crystal  
than HIPOWER at any price!



TYPE M molded bakelite holder plug-in tube socket..... \$1.00

FREE plug-in mounting with each holder

If your dealer cannot supply you  
order direct and enclose dealer's name

For complete data on "A" cut and other HIPOWER crystals, write for Bulletin E. Broadcast crystals supplied with less than 1/2 cycle drift per million, per °C.

HIPOWER CRYSTAL CO.

3607 NO. LUNA AVE., CHICAGO, ILL. TEL. AVE. 5170

# MICA CONDENSERS

... Aerovox Engineered



There's good reason why Aerovox Types 1455, 1456 and 1457 Transmitting Condensers depart from conventional design. Here's why:

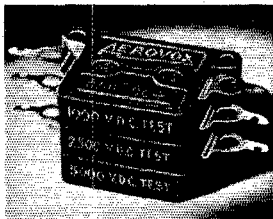

Flat top and bottom permit perfect stacking for compact assemblies or banks.

Insulated mounting holes permit any mounting independent of connections.

And insulated terminals permit any combination or individual arrangements, series or parallel.

Special terminals permit soldered connections without harmful heat transfer to encased section.

Genuine bakelite case . . . accurate values . . . conservative ratings . . . and plainly stamped as such.

**DATA FREE:** New 1935 catalog describing complete line of condensers and resistors, on request. Also sample copy of monthly Research Worker.



CORPORATION

73 Washington St.

Brooklyn, N. Y.

## JACOBS ADJUSTABLE SEPARATOR



U. S. Patent No. 1,950,179—March 6, 1934. Others Pending.

Made of porcelain they provide the means whereby 2 wire R. F. feedlines of any separation from 1" up to and including 6" (used in conjunction with Hertz antenna systems) may be rapidly and efficiently constructed. \$2.50 for a set of 6.

CHARLES F. JACOBS (W2EM), 270 Lafayette St., New York, N. Y.

## LITTELFUSES

- INSTRUMENT LITTELFUSES, for meters, 1/200 amp. up.
- HI-VOLT. LITTELFUSES for transmitters, etc., 1,000, 5,000 & 10,000 volt ranges, 1/2 amp. up.
- NEON VOLTAGE FUSES & INDICATORS (TATTELITES), 100, 250, 500, 1,000 & 2,000 volt ratings.
- AIRCRAFT FUSES, AUTO FUSES, FUSE MOUNTINGS, etc. Get new Cat. No. 6.

Littelfuse Labs., 4509 Ravenswood Ave., Chicago, Ill.

## ◀ ORDER NOW ▶

PATTERSON PR-12 complete shipped prepaid \$83.70.  
RME9D \$112.50.

SILVER 5C complete shipped prepaid \$74.70.

SUPER-PRO complete \$164.64.

NATIONAL HRO \$139.50.

All COLLINS transmitters at lowest prices.

All EIMAC, SYLVANIA, TAYLOR tubes.

Trade in Your Receiver or Transmitter

IN STOCK: 40% of National, Hammarlund, Patterson, Silver, Thordarson, Cardwell, Trimm, Cornell-Dubilier, Astatic, Turner, Ward Leonard, Ohmite, Johnson, Universal, Others, Triplett, Sylvania, Taylor, Bliley. Your used apparatus accepted in trade on any apparatus you want, too, and a large stock of used apparatus for sale at low prices.

Every inquiry and order is personally attended to by Robert Henry, W9ARA, an active amateur for ten years; graduate E.E. from M.I.T.; and owner of Henry Radio Shop selling amateur apparatus for six years. Your orders are valued and appreciated. Write for any information and bulletins. Orders gladly shipped C.O.D. if 10% deposit sent with order.

## HENRY RADIO SHOP

211-215 North Main St.

Butler, Missouri

tage of this type of recorder, it will permit; the recording of many meters simultaneously, whether they be electrical meters or not, maintaining, all the while, the same order of accuracy inherent in the original instruments. Needless to say, the new recorder will have an electric clock movement in place of the present dollar's worth.

## Neutralizing the Class-B Modulator for Greater Fidelity

(Continued from page 34)

plate electrode. Over this is slipped the piece of Herkolite or other good grade of fiber tubing having an outside diameter of one-half inch. When cut to the length indicated this will have a maximum capacity of approximately 35  $\mu$ fd. An end lap of the fiber insures against arc-over and such a condenser will safely stand any voltage applied in common practice without the addition of a series mica condenser. The outside grid electrode is formed of tin rolled snugly around the tube and soldered, with an end turned up and provided with a screw for locking purposes when set.

## What the League Is Doing

(Continued from page 44)

said in *QST*, of believing that their operator license was extended to the same date as the station license, and operating a year or so with no valid operator license! In applying for station renewal, their own proof of use is convicting them of operating without an operator license. Many such careless amateurs are being suspended for some months from the exercise of the amateur privilege. Moral: Take a look at both your operator and station licenses and *know* when they expire.

**F.C.C. Report** Complying with instructions in the Communications Act, the F.C.C. has made a special report to Congress on certain subjects that may need further legislative action. In the division that most interests us, the most important recommendation is that the law be amended to permit the consolidation of wire, radio and cable telegraph companies. Safeguards would be provided as to the continued employment of labor, American ownership, control of rates and service, etc. Another recommendation is that it be made unlawful for common carriers to make exclusive contracts as against other carriers. Still another would make it unlawful for carriers to issue or recognize franks or give any free service except in connection with distress, weather reports, etc. The language confines the suggestion to commercial companies handling messages for hire and would not apply to amateurs. A report is also to be made by F.C.C. on certain matters connected with broadcasting. It is expected that bills will be introduced in Congress intended to



# NEW ENGLAND HAM HEADQUARTERS

Promptest Service on Reliable Merchandise to N. E. Hams through conveniently located branches

37 MECHANIC STREET  
WORCESTER, MASS.  
W1DJU-W1DAU

## H. JAPPE COMPANY

46 Cornhill, BOSTON, MASS. — W1LA

450 CENTRAL AVENUE  
DOVER, N. H.  
W1DOD-W1ALN

### NATIONAL

FB7A, less coils..... \$37.50  
FBXA, less coils..... \$1.90  
SW#6 AC or DC rrvr... 19.50  
FB 7 coils, per set..... 6.00  
SW 3 coils, per set..... 3.00  
5-meter ant. coupl. unit. 2.25  
Isolantite sockets..... .36  
R 100 choke..... .45

COMPLETE National line in stock at all times.

**40% DISCOUNT**

### POWER TRANSFORMERS

Half Shell Type

P 1745D 600V ct at 40 MA  
5V 3A, 2½V 5A ct... \$ .98  
P 359 700V ct at 50 MA  
5V 3A, 2½V 7A ct... \$1.23

### INPUT TRANSFORMERS

Push Pull input, open mts..... \$ .80  
Sgl button mike trsf, open mts..... 1.20  
Db button mike trsf, open mts..... 1.20

**SATISFACTION GUARANTEED ON ALL MERCHANDISE OR MONEY REFUNDED**

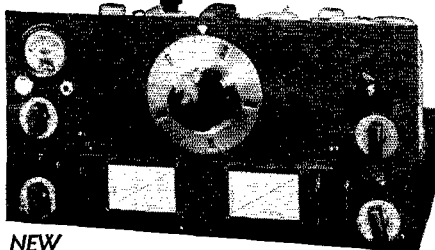

NEW

NATIONAL HRO with coils... \$139.80

### DOLLAR SAVERS

#### NEW THORDARSON

T 7337 535-0-535 at 250 MA 7.5V 2.5A,  
2.5V 5A, 5V 3A, shielded, bottom  
conn..... Special \$2.85  
T 8786 600-0-600 at 200 MA 5V 3A,  
7.5V 3A center tap 2.5V 10A ct,  
shielded bottom conn..... Special \$3.10  
T 7786 Choke 12 H 250 MA, open mtg.  
Special \$2.05

MAIL ORDERS FILLED PROMPTLY

### HAMMARLUND

Standard Pro and tubes... \$95.25  
Crystal filter additional... 17.64  
Coil set, 4-prong, wound 1.76  
Coil set, 6-prong, wound 2.20  
4 coils per set, 17-270 meters  
RCA 801 Xmit tube.  
NOW..... \$4.50  
RCA 802 Xmit pentode... 3.90  
RCA 955 acorn tube... 3.75  
RCA 906 cathode ray, 3" 18.00  
RCA 885 sweep ct tube 2.00

### MICROPHONES

Amperite RAE Velocity with trsf..... \$20.58  
Amperite RA 1 Velocity with trsf..... \$14.70  
American Ribbon with trsf... \$14.70  
Universal db type XX... 2.80  
Universal sgb type X... 3.88  
Shure 5 B db type... 5.88

### N. E. HAMS

Prepare for the Annual Divisional A.R.R.L. Convention at Worcester, Mass., April 26-27. Visit our Worcester Store

# R A D I O

**ENGINEERING**, broadcasting, aviation and police radio, servicing, marine radio telegraphy and telephony, Morse telegraphy and railway accounting taught thoroughly. Engineering course of nine months duration equivalent to three years of college radio work. School established 1874. All expenses low. Catalog free. **DODGE'S INSTITUTE**, Day Street, Valparaiso, Indiana

# RADIO ENGINEERING



RCA Institutes offers an intensive course of high standard embracing all phases of Radio. Practical training with modern equipment at New York and Chicago schools. Also specialized courses and Home Study Courses under "No obligation" plan.

Illustrated Catalog on request.

**RCA INSTITUTES, INC.** Dept. ST-35

75 Varick St., New York 1154 Merchandise Mart, Chicago  
Recognized Standard in Radio Instruction Since 1909

## PERSONIFY YOUR QSO's

Send 'em a DEL-RAD "HAM-STAMP"

Send us your Photo and \$1.50 for 100 SPECIAL "HAM-STAMPS" SENT POSTPAID

**DELAWARE RADIO SALES CO.**  
405 Delaware Ave. Wilmington, Delaware



## PEAK MONITORS

IN STOCK **\$19.80** IMMEDIATE DELIVERY

**SHIPPED PREPAID** If Full Purchase Price Accompanies Your Order

**L. I. MARINE & ELECTRIC CO.**

"Everything for the Ham"

163-18 Jamaica Ave. Jamaica, N. Y.

• PEAK • PEAK • PEAK • PEAK • PEAK • PEAK • PEAK • PEAK • PEAK • PEAK •

# LINEAR DETECTION RADIO TELEPHONY MONITOR

## PEAK

Model M-2  
110-125v 50-60 cycles



This newest PEAK product brings to your ears the audio component of the carrier being monitored. Audio distortion in any form, carrier and audio hum, can be immediately heard. Upon detection of any faults, the operator of the station can take steps to rectify their cause. It's a necessity for proper operation of any radiotelephone station on all bands from 5-200 M. The PEAK M-2 is not for use with C.W.

Diode method of detection is used in a tuned input circuit — a method especially suitable for aural monitoring as its operating characteristics are essentially linear, making the received signal as free as possible from distortion.

Other features of the PEAK M-2 are humless, well filtered, completely shielded, self-contained power supply — electrostatically shielded. Provision for milliammeter to read carrier shift. Designed for continuous operation, etc.

All monitor components are completely contained and shielded in

## EASTERN RADIO SPECIALTY CO.

Manufacturers of PEAK Products

1845 Broadway ■ Dept. Q-35 ■ New York, N. Y.

a heavy gauge, black ripple finish cabinet 8½" high x 6" wide x 10" deep. It is already available at many jobbers and Mail Order Houses. Write for literature. LIST PRICE... \$33.00

Usual Discounts to HAMS!

### PEAK PRESELECTOR

and Preamplifier is one of the developments that Hams everywhere are talking about. It gives you brilliant reception with your present receiver. Satisfaction guaranteed. Ask your jobber or write for details. LIST PRICE... \$33.00 less 40% to Hams; NET... \$19.80

Say You Saw It in QST — It Identifies You and Helps QST



## "E. H. Rietzke SPEAKING!"



Mr. E. H. Rietzke, President of CREI, and originator of the first thorough course in Practical Radio Engineering.

### ... The DIFFERENCE between a "Future" and "Just a Job" is TECHNICAL TRAINING!

There's a definite reason why some men get ahead in Radio while others plod along in the same job year after year. Men of ambition KNOW that they must have something better to offer than the next fellow to get to the big jobs and big salaries.

#### CREI GIVES YOU THE TOOLS TO BUILD WITH

Our courses are written for the man ALREADY in Radio — in a language you can understand. We provide you with the "tools" in the form of knowledge and training, with which you can build a real future.

#### WRITE FOR FREE 44-PAGE CATALOG

It will explain our various Home-Study and Residence Courses — and how easy it is to pay for them. Mail for your copy today.

CAPITOL  
ENGINEERING



RADIO  
INSTITUTE

14th and Park Road, N. W.

Dept. Q-3

Washington, D. C.

### BRAZILIAN QUARTZ CRYSTAL

Largest stock in North America of Brazilian quartz. Finest quality suitable for manufacturing piezo-electric crystals, lenses, and prisms. Shipments delivered regularly from our Brazilian Branch. Also in stock tourmalines for making crystals to control the higher frequencies and quartz for fusing purposes.

#### BRAZILIAN IMPORTING CO., INC.

6 Murray Street, New York City

Here It Is!

MARTIN  
JUNIOR

For Limited Time  
ONLY \$10

Think of it!  
A Genuine  
MARTIN  
Vibroplex  
for only \$10

All standard features. Heavy contact points. 2 3/4 pound black japanned base. The only difference is in size. Ideal for radio. Easy to use. A bargain at this low price. Don't wait — order YOURS NOW! Remit by money order or registered mail.

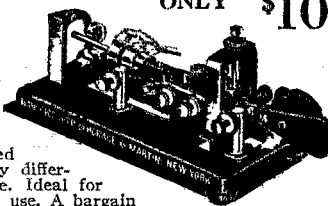

BUY!  
NOW!

#### OTHER VIBROPLEX MODELS

Famous Improved Vibroplex, Black or Colored, \$17; Nickel-Plated, \$19. Easy-Working Vibroplex No. 6, Black or Colored, \$17; Nickel-Plated, \$19. Write for catalog.

THE VIBROPLEX CO., INC.  
825 Broadway New York, N. Y.

accomplish the F.C.C. recommendations; there will then be hearings. Doubtless many waves will go out over the ether before the matters are decided.

New C.S.O. The League welcomes to office Major General James B. Allison, Chief Signal Officer of the Army, who has succeeded Major General Irving S. Carr, now retired. General Allison has lately been Signal Officer of the Second Corps Area at New York and is thoroughly acquainted with the A.A.R.S. and the merits of amateur radio and much interested in the work that the A.R.R.L. has done. During his tour at New York he missed only one Hudson Division convention. He has been an honored guest at all the division banquets. We have the following letter from him:

I deeply appreciate your letter of January 17th congratulating me on my appointment as Chief Signal Officer of the Army, in behalf of the American Radio Relay League, and assure you that the League can count upon my continued cooperation. May I ask you to transmit my congratulations to the League?

### Strays

#### Correction—Twisted Pair Feeders

In diagram "B," Fig. 2, page 23, January QST, in the article "An Improvement in Twisted Pair Feeders," the lead marked "Vary for equal feeder currents" should connect to ground and not to a condenser as shown. Resemblance between the ground and condenser symbols caused the error.

#### Resistor Color Code

Since a good many small resistors are now sold with only color-code identification of resistance value, hams will find a knowledge of the color system used of value. Resistors are marked as follows: The body color represents the first figure of the resistance value; the second figure is given by the color at one end, and the number of ciphers following the first two figures by the color of the dot or band on the body. Figures are represented by the colors given in the table below:

0—Black	5—Green
1—Brown	6—Blue
2—Red	7—Violet
3—Orange	8—Gray
4—Yellow	9—White

For example, a 75-ohm resistor would have a violet body, green end, and a black dot or band (indicating no ciphers) on the body. Similarly, a 50,000-ohm resistor would have a green body, black end, and orange dot or band (three ciphers following the first two figures).

WSGLA writes that owners of Patterson PR10 receivers can bring about a reduction in background and an increase in signal strength by changing the cathode resistor of the 57 first detector from the 2000 ohms used in the set to 10,000 ohms. This brings the tube space current down to the value recommended by the tube manufacturers.



# HAM-ADS

(1) Advertising shall pertain to radio and shall be of nature of interest to radio amateurs or experimenters in their pursuit of the art.

(2) No display of any character will be accepted, nor can any special typographical arrangement, such as all or part capital letters be used which would tend to make one advertisement stand out from the others.

(3) The Ham-Ad rate is 15c per word, except as noted in paragraph (6) below.

(4) Remittance in full must accompany copy. No cash or contract discount or agency commission will be allowed.

(5) Closing date for Ham-Ads is the 25th of the second month preceding publication date.

(6) A special rate of 7c per word will apply to advertising which, in our judgment, is obviously non-commercial in nature and is placed and signed by a member of the American Radio Relay League. Thus, advertising of bona fide surplus equipment owned, used and for sale by an individual of apparatus offered for exchange or advertising inquiring for special equipment, if by a member of the American Radio Relay League takes the 7c rate. An attempt to deal in apparatus in quantity for profit, even if by an individual, is commercial and takes the 15c rate. Provisions of paragraphs (1), (2), (4) and (5) apply to all advertising in this column regardless of which rate may apply.

Having made no investigation of the advertisers in the classified columns, the publishers of *QST* are unable to vouch for their integrity or for the grade or character of the products advertised.

**QUARTZ**—Direct importers from Brazil of best quality pure quartz suitable for making piezo-electric crystals. Diamond Drill Carbon Co., 719 World Bldg., New York.

**RADIO** engineering, broadcasting, aviation and police radio, servicing, marine and Morse telegraphy taught thoroughly. All expenses low. Catalog free. Dodge's Institute, Byrd St., Valparaiso, Ind.

**REPAIRS:** Microphones, meters, broadcasting equipment, electronic devices, instruments. Prompt repair service. Low prices. Estimates on request. Sound Engineering Corp., 2200 Kinzie, Chicago.

**HAM** equipment bought, sold or traded. Distributors of all nationally known ham apparatus. Write for catalogue. Walter Ashe Radio Co., St. Louis, Mo.

**QSL** cards, two color, cartoons, message blanks, stationery, snappy service. Write for free samples to-day. WIBEF, 16 Stockbridge Ave., Lowell, Mass.

**QSLs, SWLs, W6DOU**, Hayward, Calif.

**GENERAL** Electric 24/750 volt 200 mill dynamotors, \$25. Two machines for 1500 volts, \$40. Westinghouse, 27½/350 80 mills, \$10. 500 watt 500 cycle, \$7.50. List. Henry Kienzie, 501 East 84th St., New York.

**HI-POWER** at low cost. Super-power equipment. Taylor tubes—900 watts, \$35. Those \$1,000,000 relay racks, \$8. Mercury arcs. Edison batteries. Rectifier Engineering Service, 4837 Rockwood Rd., Cleveland, Ohio.

**WANTED**, SS super. Trade power equipment. Wanted, mercury arcs. W8MLL.

**WANTED**—QSTs, March, April, November 1916; February 1917; October, November, December 1919; August 1932. Sumner B. Young, Maplewoods, Wazytata, Minn.

2 MFD, condensers, 4000V, \$5. 2500 V, \$3. New 85ls, \$90. Universal S-G tubes, \$15. 212Ds, \$10. 866As, \$2.50. Sputtered diaphragms, 50¢. Microphones. Ewing, 1057 Pratt, Chicago.

**THE Gamma** punch cuts perfect socket holes easily and quickly in metal without disturbing apparatus or marring chassis. Two sizes 1 3/16" and 1 1/4", \$1.50 net. From your dealer or direct. Postpaid on receipt of purchase price. Gamma Mfg. Company, 907 Guaranty Bldg., Detroit, Mich.

**TRANSFORMERS**—cast cases, stand-offs, 1250—0—1250, 170 ma. \$5.75. 750—0—750, 110 ma. \$4.50. Everything in power and modulation equipment. Ruland Transformer Co., Natick, Mass.

**LIMITED** supply "A" cut crystals—trade for parts; make offer. W9ARE, 1546 S. 56th, Milwaukee, Wisc.

**QSLs**, 75¢. Order from this ad. W9DGE, 1816 N. 5th Ave., Minneapolis, Minn.

**TRANSFORMERS**—1200 watt 1200—2200—3200 each side. Quotations given. Frank Greben, W9CES, 2012 S. Peoria St., Chicago, Ill.

**NATIONAL** SW45 receiver, tubes, 20 and 40 bandspread coils, \$15. W8XCX.

**QSLs**, reasonable. W6FZQ, Box 1804, Phoenix, Ariz.

**RELAYS** keying remote control. Six volt coil. Postpaid, 75¢. Three for \$2. W3CBE.

**WANTED:** WE251A, RCA851, 861. W2ATQ.

**SELL** SW3 complete, three sets coils. Tubes, power supply, \$20. W8HFR.

**TRADE** FBXA receiver, four bandspread coils, power supply on Patterson PR10, A1 shape. W3ESY, Hellam, Pa.

50 **WATTERS**, \$7.50; 203A and 854s, new. Amateur Service, Fairview, N. J.

**QSLs!** DX specials! World's finest! Samples? (stamp) W8DED, Holland, Mich.

**CALLBOOKS** (March, W9FO) \$1.25; Biley Crystal (within 5-cc.) with holder, \$3.95. "Buy amateur!" Order direct from W8DED, Holland, Mich.

**SELL** or swap International Radio Correspondence Course. Andrew D. Kapac, Ironton, Minn.

**TRADE** for FBXA, nearly new Bausch & Lomb double objective microscope. Perfect shape. Excellent for crystallography. W5EHZ.

**MIGNON** superior transformers, low cycle response, cased Class B Universal, \$7.50 pair. Parallel 46—59 type \$7.00 pair. 203A output 40 lbs. \$9.00. Any choke transformer built or rewound. Write for details. 24 hour service. W8CUT, 1562 Main St., Buffalo, N. Y.

1000W General Electric transformer, 1100—2200—4400 each side center on 110. Sold hams eight years, \$13.50. Dawson, 5740 Woodrow, Detroit.

**CRYSTALS**—160—80 meters, within three kc., \$1.50. Guaranteed strong oscillators. Vollmer Radio Lab., 5126—35th St., San Diego, Calif.

**TRADE** splendid 2-tube receiver complete, plus \$10. for 4-tube regenerative complete. W4DEY, 373 Park Way Dr., Atlanta, Ga.

**NATIONAL**, Hammarlund, McMurdo Silver, Patterson sets, slightly used. A-1 condition. 60% off list. Cash only. No terms or swaps. Willard S. Wilson, W3DQ, Wilmington, Del.

**CRYSTALS**, x cut 1" sq., 80—160 meters. Within 3-cc. of frequency ordered, \$2. Ransom & Horn Lab., No. Syracuse, N. Y.

**QSLs**, free samples. Printer, Corwith, Iowa.

**CRYSTALS:** Orientated near AT cut provide greater stability and power. 1" sq., approximate frequency, 160—80 meters, \$1. Guaranteed. W8EBV, 1397 6th St., Muskegon, Michigan.

**CRYSTALS**—1715—4000. 1", "X", within three kilocycles, \$1.95. Guaranteed. Request Price-List. Ham Crystals, 1104 Lincoln Place, Brooklyn, N. Y.

**PATTERSON** PR-12 \$87.90 prepaid. Skyrider, National, Hammarlund, Biley xtals. Cardwell, Ward-Leonard, Speed-X, Signal, Raytheon, Eimac, Sylvania, others. Used receivers. Vinson Radio Company, W5VK, 2123 Broadway, Little Rock, Arkansas.

**QSLs**, none better—Samples? W8DDS, 2156 W. 80th, Cleveland.

**CRYSTALS:** inch square power ground, unconditionally guaranteed. X-cut 80—160 meters within 5 kilocycles \$2.00; exact frequency \$2.50; 40 meters 25 kilocycles \$3.00; 5 kilocycles \$3.75. Dust-proof bakelite holders with heavy plated electrodes G.R. or socket mounting, \$1.00. Trades accepted. Gentry Laboratories, 803 W. Maple, Independence, Mo.

**CALLBOOKS**—new Spring 1935 Radio Amateur Call Book, new Prefixes, hundreds of new DX QRAs, many new pages of late W and VE calls, is yours for \$1.25, or four issues (one year) for \$4.00 (in foreign countries \$1.35 and \$4.35, Postpaid). W9FO-610 S. Dearborn, Chicago.

**TRANSFORMERS**—1500—1350—850 each side. 400W, \$8.25. 750W, \$11.00. 10H, 500ma chokes, \$6.00. Heavy wire plenty core, terminal board, mica insulation, mounted. Finished in crinkle enamel. Spear Manufacturing Company, Waterville, Ohio.

"AT" Crystals: Guaranteed—Your approximate frequency calibrated to .1%. 1750—3500 kc. bands \$5.00. 7000 kc. band \$8.00. AT Blanks finished on one side \$2.00. Saw blanks \$1.25. Chas. C. Fagan, W3UF, Carlisle, Pennsylvania.

**CHANNEL** steel racks not drilled 66x21½ for standard panels, \$5.50. Drilled standard \$6.72. Panels 8¾x21¾ at \$9.88 steel. \$1.56 aluminum slotted or unslotted. Odd sizes a specialty. Special drilling and cutting for all layouts. Write for prices on Chassis bases and shield cans. W9DAX Sandwich, Illinois.

**CLASS B** transformers—Universal for two or four 46's, 210's, 800's, RK18's, etc., \$7.75 pair postpaid anywhere in United States. 70 watts of audio from 46's. Write for details. W8UD, Douglas, Michigan.

**CRYSTALS:** 160—80 meter X cut—1" sq., fully finished and guaranteed. Within 2 kcs. of order, \$2. Biley BC2 holders, \$1. W8DLM, Rochester, Mich.

WANTED Scott Fifteen or Silver Masterpiece also Peak or Postal preselector. Glenn Watt, Chanute, Kansas.

FOR sale standard model air tuned Hammarlund. Sixteen tube Deluxe Midwest receivers. Want meters test equipment. Glenn Watt, Chanute, Kansas.

QSLs by Maleco. Finest in country. Free Samples. Maleco, 1512 Eastern Parkway, Brooklyn, New York.

AMATEUR equipment manufactured to order. Holmes C. Miller, Box 105, Palo Alto, California.

QSL's Samples, 2143 Indiana Avenue, Columbus, Ohio.

A-CUT crystals guaranteed 160-80 approximate frequency \$3.50. X-cut \$1.35. Y-Cut \$1.00. Wolverine Crystal Service, 3942 Temple St., Calumet, Mich.

NEW HAVEN vicinity hams. Amateur parts in stock. Congress Radio, 207 Congress Avenue.

FOR exchange: W.E. 518-B volume indicator; 17-B amplifier rack mounting; W.E. mike and case. Wanted, sextant and spectroscope. A. H. Dreesen, Mansfield Center, Conn.

FOR sale. National AGS SW receiver. Extra tubes. Reasonable offer accepted. W210, 315 East 18th St., New York City.

SELL Wireless Age 1916-7, 1920-1 complete. Also 1914-5-9 and 1922 partial. Price 25¢ each plus P.P., C.O.D. Charles Alvord, 7 Summer St., Worcester, Mass.

USED Weston milliammeters, \$3.50; a.c. voltmeters, \$4; r.f. thermoammeters \$6.50. Guaranteed. Card places you on mailing list. W2EDW, Far Rockaway, New York.

CRYSTALS, guaranteed. 160-80 meter, less than 1", x or y, plus or minus ten kilocycles, \$1.35. Plus or minus two kilocycles, 1", \$2.25. Blanks 60¢; odds and ends, five for \$1; oscillating 85¢ Speedy Service, Wm. Threm, W8FN, 4021 Davis Ave., Cheviot, Ohio.

SELL—brand new National AGSX complete. Power supply, tubes, dynamic speaker, 20-40-80-160 and set of B band coils. \$130. W9JTD.

QSLs, SWLs. W1AZF, 83 Orange St., Roslindale, Mass.

CRYSTALS, 80-160 meters, \$1.25, 40, \$2.50, holders 75¢. Guaranteed. Ed. M. Hlavaty, Western Springs, Ill.

BARGAINS—parts and tubes. Guaranteed list. Wm. Tannenbaum, W2VG, 2071 Walton Ave., Bronx, N.Y.C.

TRANSFORMERS—1100 watts, 2500-3000 volts each side c.t., 350 mills, \$16.50. 800 watts 1250-1600 volts each side c.t., 500 mills, \$12. 500 watts, 1100-1300 volts each side c.t., 350 mills, \$9. Special transformers built to specifications. Transformers guaranteed two years at rated loads. Philadel, 3244 No. Bambrey St., Philadelphia, Penn.

HAM receiver, 53-57-56 cabinet, \$3.75. W9DQH.

CONDENSERS, variable, .00035, 35¢, 4 for \$1. Jewell a.c. milliammeter, 0-300 milliamps, 2 inch, \$3. Readrite set checker, 245-A, \$5. Readrite ohmmeter, model 502, \$3. W8RW, 208 N. Main, Bluffton, Ohio.

CANADIANS only! Sell or trade couple of 204A tubes. Perfect. Want receiver FBXA or 5C or movie camera. VE3GG.

SELL RCA 204A made last October. Never used. W1BVU, Box 503, Rutgers, New Brunswick, N. J.

EXCHANGE—stamp collection, covers for amateur equipment. W2HWO, H. L. Van Ness, 24 Baldwin Ave., Newark, N. J.

SELLING out: complete 400 watt c.w. xmitter, rack panel, also s.s. receiver. W9GNU.

SELL—Instructograph, 10 tapes. One Comet Pro complete. Both A1. W9SFF.

METERS repaid, reasonably. W9BMA.

COMPLETE parts, tubes, power supplies for 500 watt xmitter including ten Weston meters for first \$60. List. W3BEN.

QUADRUPLED circulation for "R/9" in one year! Why? A sample tells the story—20¢; foreign, 25¢. Subscription: \$1.50 yearly; two years, \$2.50. Canada, \$2.25 yearly. "R/9", 1455 Glenville, Los Angeles.

APRIL 1st "R/9" rates increase. Subscribe now! Rates above. "R/9."

CLUBS: Your special "R/9" group rates increase April 1st. Present rates: 3 subscriptions, \$1.15 each; 6, \$1.00; 12, \$0.85; 20, \$0.75. "R/9."

FOR sale: SW3, new, with tubes and 160 meter coils, \$16. G. H. Sechrist, 1415 Kearney, Laramie, Wyo.

BLACK crackle enamel, 75¢; coils for SW3, SW58 cheap; Victrol dope, 30¢. Catalog. Radio Specialties, 433 Monroe, Brooklyn, N. Y.

WANTED—used Postal or Comet Pro cabinet. W2BCE.

NATIONAL SW3, a.c. power supply, tubes, band spread plus 13 to 1200 meter coils, less b.c. in coil cabinet. Fine condition, \$30. Code machine, \$4. Readrite 700 analyzer, \$7.50. W6HAU.

QSLs, SWLs, 75¢ per hundred, two colors, samples on request. W5ECM, 319 Rosetta, Little Rock, Ark.

SELL—National SW58 receiver, including bandsread coils 20, 40, 80, 5880-S power supply, and all tubes. Good condition. Best offer. W5BB.

SELL \$100.00 complete xtal transmitter. 4 stages. Three 210's 211 D final 250 watts input. All RCA tubes. Three power supplies. All stages metered including antenna. Chicago hams can see this xmitter at Room 1703, 5 So. Wabash Ave., Wayman.

BRAZILIAN quartz, clear, suitable for piezo-electric crystals. F. Baumgardt, 198 Broadway, New York City.

CRYSTALS—guaranteed excellent oscillators, 7/8 to 1 1/4" your approximate frequency, 80-160 bands, \$1 postpaid. Blanks—accurately cut from high grade optical quality Brazilian quartz, 50¢. W9FES, 4433 North Kilbourn, Chicago.

QSL's. Samples free. Miller, Printer, Ambler, Pa.

CRYSTALS: Zero Temperature-Frequency coefficient. Your approximate frequency, 80 or 160 meters \$1.85. Selected for zero over a wide range in temperature \$3.25. Plug-in holders 75¢ postpaid. Fisher Laboratory, 4522 Norwood Street, San Diego, California, "Pioneers of low priced crystals."

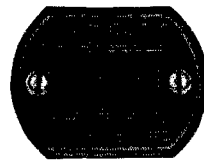

## SANGAMO ACCURATE CONDENSERS

A quality product for the amateur who wants the best results. Available in 1000, 2500, and 5000 volt construction

Write for catalog sheet

**SANGAMO ELECTRIC CO.**  
SPRINGFIELD, ILLINOIS

THE  
S  
T  
A  
N  
D  
A  
R  
D  
O  
F  
C  
O  
M  
P  
A  
R  
I  
S  
O  
N

Announcing

## TYPE RTM

### TRANSMITTER-RECEIVER UNIT

An outstanding development in the ultra-high frequency field featuring a combination of circuits and tubes which renders the conventional transceiver obsolete, and the high cost of duplex transmitter-receiver combinations unnecessary. This new type unit is made in two models for fixed and mobile use and, of course, receiver radiation has been eliminated.

### FT-30 TRANSMITTER

A new medium-powered radiophone transmitter offering commercial type construction at an Amateur price. Four band operation with an output of 25-30 watts depending on frequency. Such features as rack and panel construction, combined with finest quality parts and skillful design, make this transmitter a new leader in the Amateur transmitter field.

HARVEY TRITET—The popular five band exciter unit, less tubes and crystal. **\$42.50**

RK-20 AMPLIFIER—An efficient and well designed companion unit, with tubes **\$69.50**

Write for bulletin with full details and prices

### HARVEY RADIO LABORATORIES

12 Boylston Street

Brookline, Mass.

# Your Nearest Dealer

Your nearest dealer is entitled to your patronage. You can trust him. He is equipped with a knowledge and understanding of amateur radio. He is your logical and safe source of advice and counsel on what equipment

Patronize the dealer nearest you—

<p><b>ALLENTOWN, PENNSYLVANIA</b> Radio Electric Service Co. 1024 Hamilton Street Complete stocks transmitting equipment</p>	<p><b>DENVER, COLORADO</b> Inter-State Radio &amp; Supply Co. 1639 Tremont Place Amateur Radio Headquarters in the Rocky Mountain Region</p>
<p><b>BALTIMORE, MARYLAND</b> Radio Electric Service Co. 303 W. Baltimore Street Everything for the amateur</p>	<p><b>DETROIT, MICHIGAN</b> Radio Equipment Sales Co. 14036 Woodward Avenue, Highland Park A complete stock of amateur, shortwave and service parts</p>
<p><b>BOSTON, MASSACHUSETTS</b> Nutter &amp; Cross, Inc. 99A Milk Street All OMs, OWs, and YLs welcome — W1HRF</p>	<p><b>DETROIT, MICHIGAN</b> Radio Specialties Company 171 E. Jefferson Avenue Ham Supplies — National &amp; Hammarlund Sets and Parts</p>
<p><b>BROCKTON, MASSACHUSETTS</b> Ware Radio Supply Company 913 Centre Street Hammarlund, Sylvania, Ohmite, Raytheon, Triplett Meters</p>	<p><b>ERIE, PENNSYLVANIA</b> Jordan Radio Laboratory 2512 Peach Street Amateur, service parts, including Bliley, National, Raytheon. W8CXG</p>
<p><b>BUFFALO, NEW YORK</b> Dymac Radio 216 E. Genesee St. — Tel. CI. 2080 Complete Stock Amateur Parts — Standard Discounts — W8AWK</p>	<p><b>FRESNO, CALIFORNIA</b> Ports Mfg. Co. 3265 E. Belmont Ave. Wholesale: RCA-Thordarson-Bliley. All Standard Lines</p>
<p><b>BUFFALO, NEW YORK</b> Kronson Service Company 143 East Genesee Street Western New York's largest wholesale distributors — W8EHF</p>	<p><b>HARTFORD, CONNECTICUT</b> Radio Inspection Service Company 227 Asylum Street What do you need? We have it</p>
<p><b>CHICAGO, ILLINOIS</b>  Allied Radio Corporation 833 West Jackson Blvd.  Complete standard lines always in stock — W9NRV — W9RZI</p>	<p><b>HOUSTON, TEXAS</b> Straus-Frank Company Distributors for nationally advertised amateur products RCA-DeForest transmitting tubes</p>
<p><b>CHICAGO, ILLINOIS</b>  Chicago Radio Apparatus Company 415 South Dearborn Street (Est. 1921)  W9RA and W9PST — Amateurs since 1909</p>	<p><b>JACKSONVILLE, FLORIDA</b> Glover Weiss Co. Radio Headquarters for Southeast Distributors: RCA Victor, Stromberg-Carlson, Standard Ham Lines</p> <p><b>KANSAS CITY, MISSOURI</b> Burstein-Applebee Company 1012-14 McGee Street "Specialists" in supplies for the Amateur and Serviceman</p>
<p><b>CHICAGO, ILLINOIS</b> Mid-West Radio Mart 520 S. State Street All standard lines carried in stock</p>	<p><b>KANSAS CITY, MISSOURI</b> Radio Laboratories 1515 Grand Avenue Amateur Headquarters — Complete Stock — Quality Parts</p>
<p><b>CLEVELAND, OHIO</b> Northern Ohio Laboratories 2073 West 85 Street Wholesale Distr. for National, Hammarlund, Thordarson, Cardwell</p>	<p><b>LOS ANGELES, CALIFORNIA</b>  Pacific Radio Exchange, Inc. 729-31 South Main Street  Most completely diversified stock of amateur equipment in the West</p>

*This advertisement is paid for by the firms listed above. Qualified dealers*

# Is Your Best Friend

you should buy. His stock is complete. He can supply your needs without delay. His prices are fair and consistent with the high quality of the goods he carries. He is responsible to you and interested in you.

You can have confidence in him

<p><b>MANCHESTER, NEW HAMPSHIRE</b> Radio Service Lab. of N. H. 1008 Elm Street — Tel. 218-W Branches — Portland, Me. and Barre, Vt.</p>	<p><b>ST. PAUL, MINNESOTA</b>  Lew Bonn Company 2484 University Avenue Rex L. Munger, W9LIP, Sales Engineer  Radio Wholesaler <span style="float: right;">Complete Stock</span></p>
<p><b>MILWAUKEE, WISCONSIN</b> Radio Parts Company, Inc. 332 West State Street Complete stock Nationally Known products</p>	<p><b>SAN ANTONIO, TEXAS</b>  Straus-Frank Company Distributors for nationally advertised amateur products RCA-DeForest transmitting tubes</p>
<p><b>MONTREAL, CANADA</b> Canadian Elec. Supply Co., Ltd. 285 Craig St., W. Quality parts and equipment for discriminating buyers</p>	<p><b>SAN FRANCISCO, CALIFORNIA</b>  Offenbach Electric Company, Ltd. 1452 Market Street  "The House of a Million Radio Parts"</p>
<p><b>NASHVILLE, TENNESSEE</b> Braid Electric Co. Ham Supplies—Replacement Parts RCA, National, Hammarlund, and other leaders</p>	<p><b>SIoux CITY, IOWA</b> Warren Electric Co. Standard Lines and Discounts T. J. Morris, W9SSN, Mgr. Parts Dept.</p>
<p><b>NEWARK, NEW JERSEY</b> Kaltman &amp; Romander 62 Court Street Drop in for an over-counter QSO</p>	<p><b>SPRINGFIELD, MASSACHUSETTS</b> T. F. Cushing 349 Worthington Street An amateur, endeavoring to sell good parts</p>
<p><b>PEORIA, ILLINOIS</b> Klaus Radio &amp; Electric Co. 707 Main Street Amateur Radio Department</p>	<p><b>SYRACUSE, NEW YORK</b> Roy C. Stage, W8IGF Complete stock of standard Ham &amp; BCL parts Standard Discounts. Free technical service</p>
<p><b>PHILADELPHIA, PENNSYLVANIA</b> Consolidated Radio Corp. 612 Arch Street Ham receivers, Transmitting tubes, Collins Transmitters, etc.</p>	<p><b>TORONTO, CANADA</b> A &amp; A Radio Service Supply 101 Queen Street, West Canada's foremost radio supply house</p>
<p><b>PHILADELPHIA, PENNSYLVANIA</b> Radio Electric Service Co., Inc. N. E. Cor. Seventh &amp; Arch Sts. All nationally-advertised lines in stock</p>	<p><b>TORONTO, CANADA</b> Wholesale Radio Company, Limited 1133-39 Bay Street Canada's Largest Amateur Supply House</p>
<p><b>PHILADELPHIA, PENNSYLVANIA</b>  Eugene G. Wile 10 S. Tenth Street  Complete Stock of Quality Merchandise</p>	<p><b>TRENTON, NEW JERSEY</b> American Radio Co. 5 N. Broad Street Central Jersey's leading radio parts store</p>
<p><b>PITTSBURGH, PENNSYLVANIA</b> Cameradio Company 601-3 Grant Street "Ham" Headquarters for Pennsylvania-Ohio-W. Virginia</p>	<p><b>WASHINGTON, D. C.</b> George's Radio Co. 816 F Street, N.W. Washington's largest distributor of radio parts</p>
<p><b>PROVIDENCE, RHODE ISLAND</b> W. H. Edwards &amp; Company 32 Broadway, Room 23 Amateur Equipment — National, Hammarlund, RCA Tubes</p>	

are invited to apply for rates, etc., to Advertising Department, QST

Say You Saw It in QST — It Identifies You and Helps QST

# You Are Protected When You Buy From QST Advertisers

“Advertising for QST is accepted only from firms who, in the publisher’s opinion, are of established integrity and whose products secure the approval of the technical staff of the American Radio Relay League.”

Quoted from QST’s advertising rate card.

Every conceivable need of a radio amateur can be supplied by the advertisers in QST. And you will know the product has the approval of the League’s technical staff.

## For Your Convenience

### QST'S INDEX TO ADVERTISERS IN THIS ISSUE

Aerovox Corporation	102
Alden Products Company	105
A.R.R.L. Binder	87, 92
Book Shelf	91
Emblem	94
Handbook	2
How to Become a Radio Amateur	99
License Manual	101
Log Book	85
Supplies	91, 103
Birnbach Radio Company	100
Bliley Electric Company	89
Brazilian Importing Company	104
Burgess Battery Company	6
Capitol Radio Engineering Institute	104
Cardwell Mfg. Corp., Allen D.	112
Central Radio Laboratories	78
Collins Radio Company	Cov. 2
Cornell Dubilier Corporation	95
Delaware Radio Sales Company	98, 103
Dodge's Institute	103
Eastern Radio Specialties Co.	103
Eitel-McCullough, Inc.	94
Electrad, Inc.	99
General Electric Company	83, 89
General Radio Company	93
Gross Radio Company	4, 5
Gulf Radio School	101
Hallicrafters, Inc., The	93
Hammarlund Mfg. Company	1
Harvey Radio Labs.	107
Henry Radio Company	102
Hipower Crystal Company	101
Instructograph Company	101
Inter-State Radio & Supply Co.	103
Jacobs, Chas. F.	102
Jappe Company, H.	103
Kaltman and Romander	82
L. I. Marine & Electric Co.	86, 103
Leeds	111
Littelfuse Laboratories	102
Lynch, Inc., Arthur H.	105
Massachusetts Radio School	95
Meter-Lab	100
National Carbon Company	95
National Company	77, 90, 95, Cov. 3
New York Y.M.C.A. Schools	105
Offenbach Electric Company	91
Precision Piezo Service	99
Premier Crystal Laboratories	97
RCA Institutes, Inc.	103
RCA Manufacturing Company	79, Cov. 4
Radio Laboratories	87, 94
Radio Receptor Company	105
Radio Shack	87, 97
Radio Supply Company	95
Radio Television & Supply Co.	87
Radio Transceiver Laboratories	101
Raytheon Mfg. Company	100
Raytheon Production Corp.	80
Sangamo Electric Company	107
Scientific Radio Service	98
Shuler Supply Company	87
Shure Brothers Company	90
Signal Electric Mfg. Company	99
Telex Company	105
Triplett Electrical Instrument Corp.	84
Turner Company	94
United Radio Mfg. Company	95
Vibroplex Company	104
Ward Leonard Electric Company	97
Wright's Electrical Instrument Lab.	97
Yaxley Manufacturing Company	81



# LEEDS LEADS!!

With the first transmitter ever offered with all adjustments on the front panel for four band operation. No plug in coils—no neutralizing—1.7 mc 3.5 mc 7.0 mc 14.0 mc operation in 30 seconds CW or fone

Our new 4-B transmitter employs a number of ideas used in commercial and government short wave transmitters to secure high efficiency and rapid shift of the operating frequency over a wide range. The 4-X exciter unit advertised last month provides the driving power for the 4-A amplifier unit illustrated below. Two RK-20's in parallel develop 120 watts output on CW and 30 watts 100% modulated on fone on four bands.

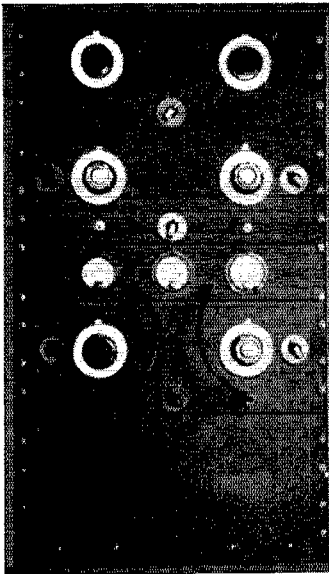

The new Triplett 2" bakelite cased instruments are used on the meter panel. Two milliammeters fitted with plugs on flexible cords make the metering of all tube circuits a matter of moments. The antenna ammeter uses an external thermo couple installed in the antenna network.

Type 4-M PANEL **\$15.25**

Our 4-S Power Supply, illustrated below employing four 5Z3 rectifiers in a bridge circuit supplies all the necessary power for the complete transmitter and speech amplifier.

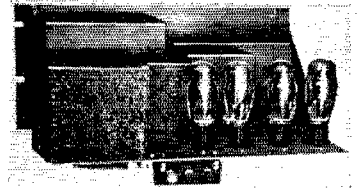

LEEDS 4-S POWER SUPPLY (less tubes) **\$45**



Type 4-A AMPLIFIER **\$33.50**  
(less tubes)



### General Radio

S.L.F. split stator condenser; 175 mmf per section; ideal for antenna networks and medium power stages.

**\$1.25**

General Radio forms; No. 677-U... 50c  
No. 677-Y... 75c  
Described fully in December issue

LEEDS low loss inductance for low power stages as described last month. **15c**  
Linear inch.

Portable transmitting antennas 150 feet, stranded phosphor bronze wire, with hand reel. **\$1.10**

SHURE Crystal Microphone **\$13.23**  
in stock.

NATIONAL SW3—the last word in TRF receivers; 3 models in stock at. **\$19.50**

The complete line of National products in stock at 40% off list price.

A thin dime brings our bulletin B-73 together with data on all of the products of 25 nationally known parts manufacturers.

Our Bulletin B-73 contains complete descriptive matter on all LEEDS APPARATUS including our new transmitter units.

Transmitter complete, with tubes and crystals for fone and telegraph operation on four bands. .... **\$210**

The Type DBT combination speech amplifier and remote control unit pictured below, is housed in a 7x8x10" box, that can be located alongside the receiver. It provides remote control of filament and plate power to the transmitter by means of two switches provided with pilot lights. A two stage amplifier similar to our DBS amplifier provides sufficient output using a double button microphone to suppressor grid modulate the 4-A amplifier stage.

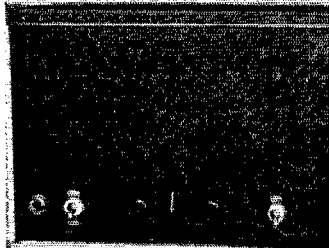

Type DBT SPEECH AMPLIFIER (less tubes) **\$18.50**

LIQUID VICTRON low loss coil dope; a 2 oz. can. .... 21c  
LEEDS 203A — 11 porcelain base socket, 95c

PYREX antenna insulators 7" .... 68c  
PYREX antenna insulators 3" .... 17c  
Tip ring sleeve plug. .... 44c  
Tip ring sleeve jack. .... 25c  
RCA 802 Pentode in stock; each ... \$3.90

THORDARSON double filter choke—18 H. 250 ma per section; shipping weight 18 lbs. Specially priced at. .... **\$5.50**

### COMPARE!!

LEEDS oil impregnated cased transmitting condensers carrying our regular guarantee. 2 mid capacity only. D.C. working voltage.

1,000 volts. .... \$1.75  
1,500 volts. .... 2.50  
2,000 volts. .... 2.95

### IN STOCK

THE NEW EO-1 feeder cable for double transmitting antennas.

Up to 50 feet; per ft. .... 7c  
50 to 100 feet; per ft. .... 6½c  
100 to 200 feet; per ft. .... 6c  
500 feet and over; per ft. .... 5½c

### COMPARE!!

LEEDS Graphite Anode 203-A **\$8.45**  
Specially priced at. ....

### LYNCH PRODUCTS

We have the complete line always on hand for immediate shipment.



**LEADS THE FIELD**

World Wide Service to Amateurs

45 Vesey Street  
New York City

Cable Address, "RADLEEDS"

# Be SCOTCH

**T**RADITIONALLY, thrift is a stern and painful necessity for the Scotsman wresting a living from the rocky soil of his native heath and even direst yearning never impels him to accept anything which he believes to be worth a farthing less in value than the hard-earned pennies he exchanges for his purchases.

In that sense, being "Scotch" when buying condensers is just good business, and Cardwells will insure the utmost for your money in quality, efficiency and satisfaction, always remembering that "THE BEST IS THE CHEAPEST"



*Send for Literature*

**THE ALLEN D. CARDWELL MFG. CORP'N.**  
83 PROSPECT STREET, BROOKLYN, N. Y.

**"THE STANDARD of COMPARISON"**

CARDWELL "TRIM-AIR"  
MIDGET CONDENSERS

CARDWELL "STANDARD"  
MODELS FOR RECEIVERS and  
MEDIUM POWER TRANSMITTERS

CARDWELL MIDWAY  
"FEATHERWEIGHT"  
CONDENSERS, RECEIVING and  
TRANSMITTING

CARDWELL 16-B TRANSMITTING  
CONDENSERS FOR LARGER  
TRANSMITTERS

CARDWELL HIGH VOLTAGE  
CONDENSERS for COMMERCIAL  
RADIO-TELEGRAPH and  
BROADCASTING STATIONS

CARDWELL S-2244 OIL  
DIELECTRIC FIXED CONDENSERS  
FOR HIGH FREQUENCY  
FURNACES and TUBE  
BOMBARDERS

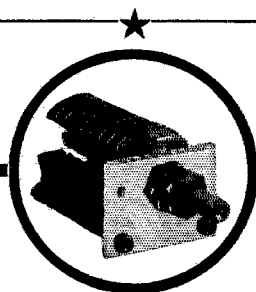

The CARDWELL "TRIM-AIR" MIDGET  
Isolanfite insulation—A quality product

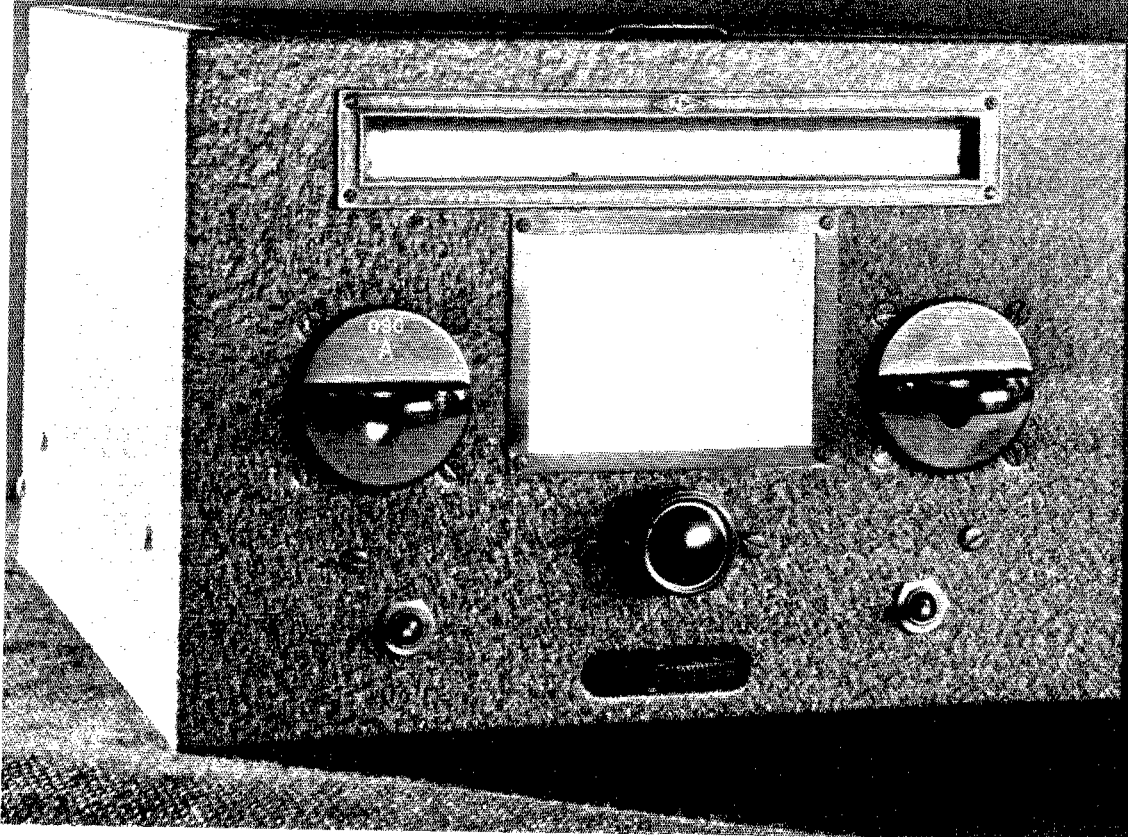

## The FBX-A

This is by way of reminding you that although the HRO is an obvious choice in the high quality field, the FBX-A is equally outstanding in its own field. The extremely low net price of \$51.90 includes a built-in single signal unit, as well as the general high performance for which the FB7A has always been famous.

NATIONAL



COMPANY

V E R S A T I L E

D E P E N D A B L E

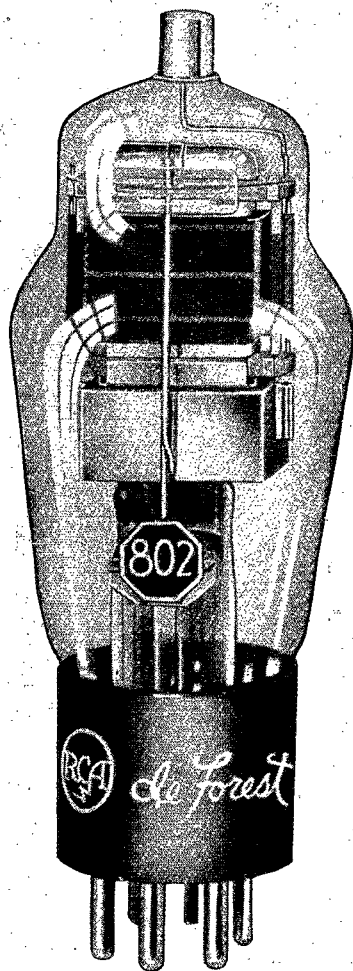

The NEW

**RCA·802**

AMATEUR'S NET PRICE

**\$3.90**

RCA Radiotron is proud to introduce this new RCA deForest type—the 802—which fills diversified needs for a moderate-powered pentode at a price within the reach of every amateur.

The applications of the RCA-802 are numerous. Some of the important uses which immediately suggest themselves are:

- (1) Straight pentode crystal oscillator,
- (2) Electron-stream-coupled oscillator,
- (3) Frequency multiplier (doubler, etc.),
- (4) Suppressor-modulated amplifier,
- (5) Control-grid-modulated amplifier,
- (6) Class C buffer-amplifier,
- (7) Class C power amplifier.

Employing a 6.3-volt heater, the RCA-802 also offers exceedingly attractive possibilities in a compact, low-powered 'phone transmitter for portable operation from an automobile storage battery.

Please send RCA-802 bulletin to:

Name \_\_\_\_\_

Address \_\_\_\_\_

City \_\_\_\_\_

Call Letters \_\_\_\_\_

Dept. T \_\_\_\_\_

Send us this coupon for complete technical information. Your RCA deForest Distributor has the RCA-802 in stock



**AMATEUR  
RADIO SECTION**

RCA MANUFACTURING COMPANY, INC.  
CAMDEN NEW JERSEY