

QST

April, 1935

95 cents

devoted entirely to

amateur radio

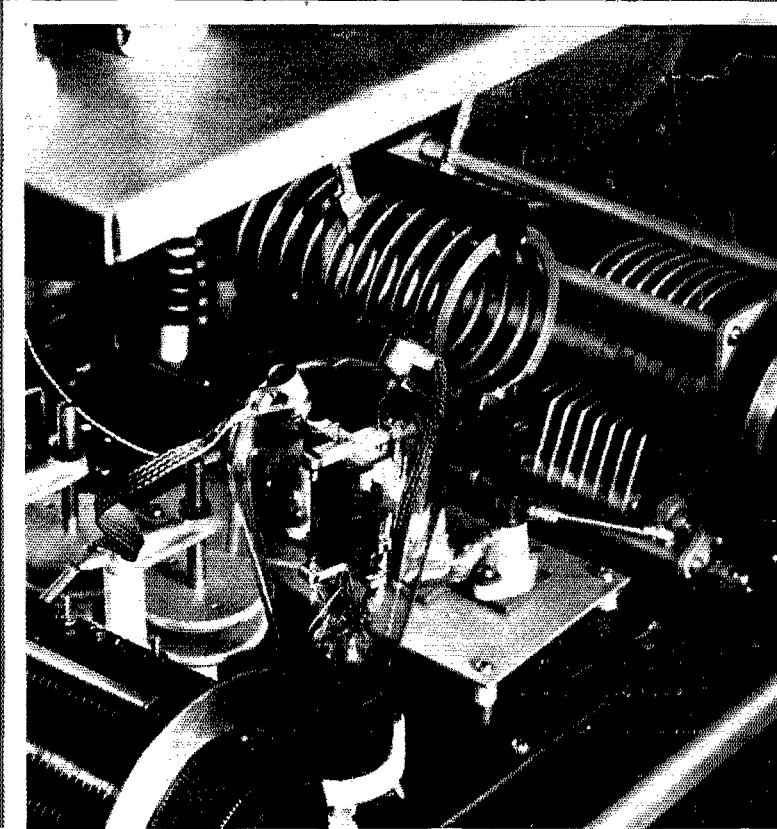

In this Issue—
**Feature
Articles on
Transmitter
Construction**

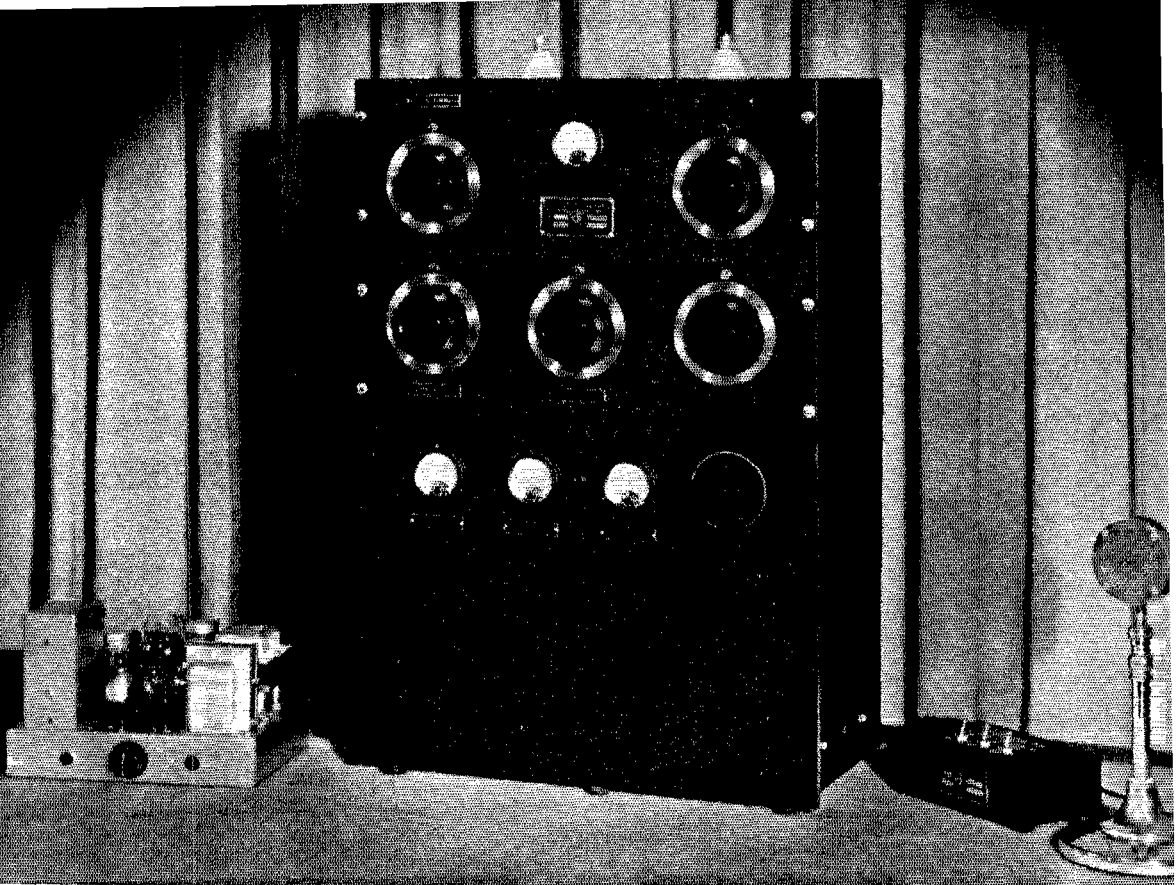

FIXED NEUTRALIZATION

Fixed neutralization means a great deal more than simply providing the neutralizing condenser with some sort of locking device. For unless the output circuit is designed to take care of antennas possessing unbalanced reactance characteristics deneutralization will result in the final amplifier. In all COLLINS transmitters neutralization is quite independent of antenna characteristics or transmission frequency.

30FX
100 WATTS CW
40 WATTS PHONE

*Left, Type 7X Speech Amplifier
 Right, Type 14C Control Box and
 Type CD-104 Crystal Microphone*

GRID MODULATION

Grid modulation is of course not new — but the COLLINS system of control-grid modulation is. It makes possible for the first time the manufacture of a highly-efficient grid modulated transmitter free from the petty annoyances inherent in earlier systems. Maximum power output with 100 percent modulation is assured together with high tube efficiency and simplicity of operation.

ANTENNA MATCHING NETWORK

An antenna matching network to match the various types of antennas put up by amateurs must be more than just a couple of condensers and coils. It must be capable of a multiplicity of circuit combinations. To do this effectively the coils must have taps for varying the amount of inductance, plus some simple means of plugging them into different sections of the network. It should be possible to change the configuration of the network without unsoldering connections or removing nuts and lugs.

Fixed neutralization, control-grid modulation and the use of antenna matching networks are just a few of the recent COLLINS RADIO COMPANY developments. These and many other worth-while improvements are incorporated in the type 30FX Control-Grid Modulated Transmitter — a set made by a firm well acquainted with the amateur's problems and sold at a price well within his reach. . . For more complete information and price write to:

COLLINS RADIO COMPANY

CEDAR RAPIDS, IOWA

New York Office

11 West 42nd Street

Continuously VARIABLE SELECTIVITY

Without Affecting Tuning

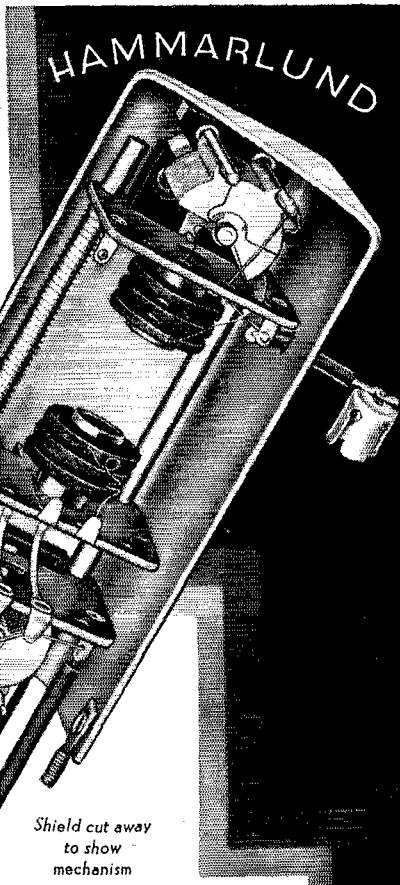
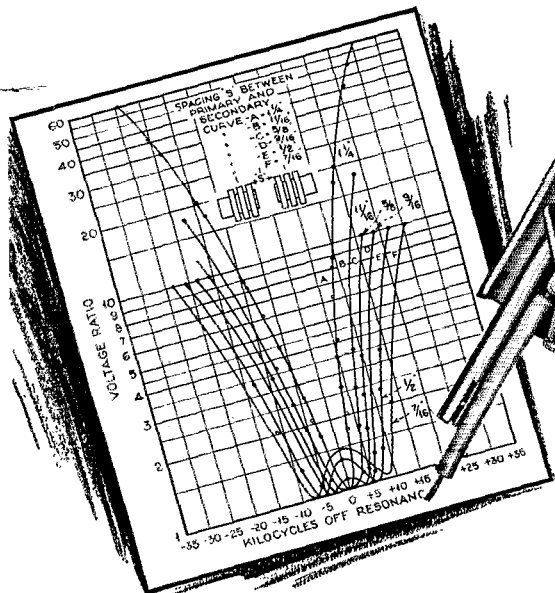

Shield cut away to show mechanism

STUDY THE DIAGRAM and you will see the remarkable range of selectivity variation obtainable in even one of these new Hammarlund I.F. Transformers, equipped for continuously variable coupling between the coils.

From a needle-sharp peak to the flat top required for high fidelity — *without affecting tuning.*

Exceptionally efficient, new triple-type, pie-wound Litz coils and air-dielectric condensers are used.

Adjustment of coil coupling in each transformer may be fixed at any point, or continuously varied by panel control, individually or ganged, according to selectivity desired for any special receiving condition.

This new Hammarlund development is one of the startling features of the COMET Super "PRO" Receiver you'll soon be excited about. But it is available also for improving the selectivity flexibility of other superheterodynes.

Code No. VT-465 (465 kc.). List price, \$5.50 each, less 40% to experimenters.



Canadian Office:
41 West Ave. North,
Hamilton, Ontario



HAMMARLUND MANUFACTURING CO.
424-438 W. 33rd St., New York

Check here for details of new Variable-Coupling I.F. Transformer.

Check here for 1935 General Catalog.

Name.....

Address.....

..... Q-4

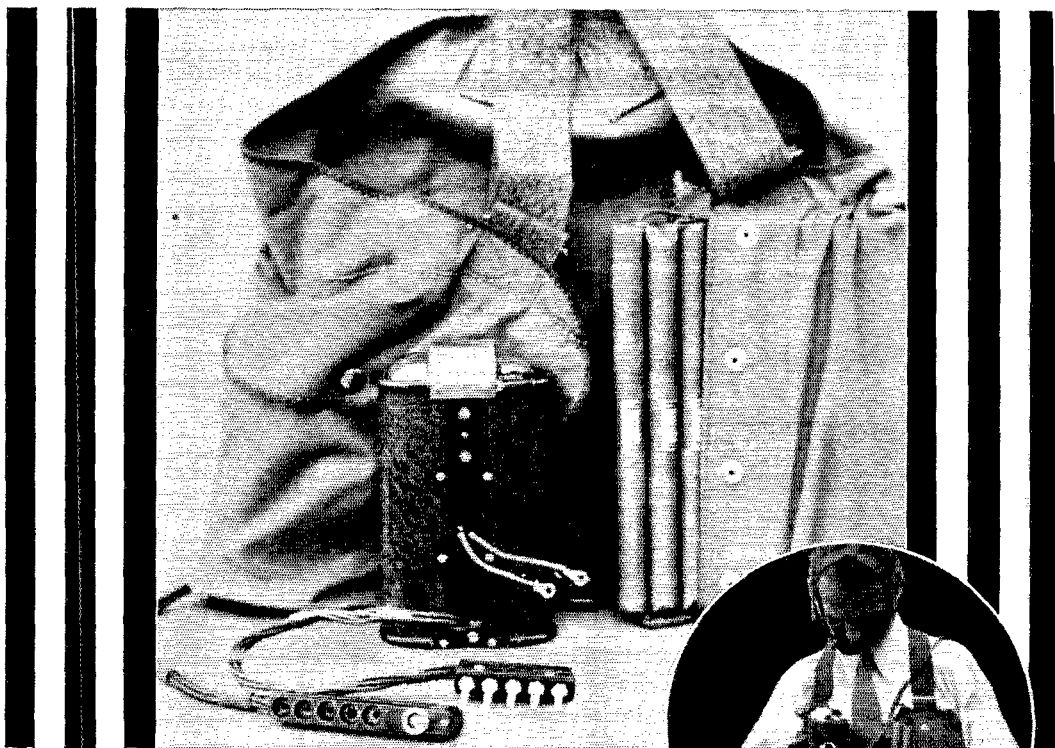

Ribbon Battery

OPERATES TRANSMITTER IN SPECTACULAR PARACHUTE JUMP

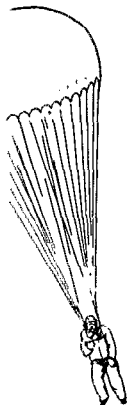

During the recent All-American Air Races at Miami, Clem Soh, world famous delayed parachute jumper, plunged over a mile and a half through space *before he opened his parachute!* During this death-defying dive, he wore a BURGESS Ribbon Battery around his waist to operate a two-and-a-half pound transmitter! This tiny transmitter, according to its builder, Norman S. Bean, E. E., of Miami, "enabled thousands of spectators to hear the rush of wind and crack of the parachute as it snapped open barely six hundred feet above ground. The jerk was terrific. Landing heavily, falling on his back and rolling over, Soh calmly announced that he felt all right. The BURGESS Ribbon Battery announced that it was all right, too. Not a single stick was crushed or broken, nor a lead torn loose through it all!" ● Photograph shows BURGESS Ribbon Battery used during this spectacular delayed parachute jump. Like the BURGESS Batteries in your set, it was built to "take it" and still give the superior performance Engineers and Radio Amateurs demand. BURGESS BATTERY COMPANY, FREEPORT, ILLINOIS.

≡ BURGESS ≡

QST

Published monthly, as its official organ, by the American Radio Relay League, Inc., at West Hartford, Conn., U. S. A.; Official Organ of the International Amateur Radio Union

devoted entirely to

AMATEUR RADIO

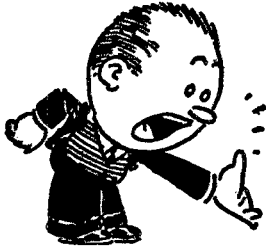

Editorials	7
Do You Want a Kilowatt?	Don H. Mix 8
Stepping Up the Output of the High Stability 56-Mc. Transmitter	W. Conrad, W9WC 14
A Compact "200 Watt" Transmitter	Edwin Y. Webb, Jr., W4UP 16
More on the Practical Operation of Transmitting Antennas	W. S. Potter, W8GLY and H. C. Goodman, W8BOG 21
Jim	John P. Flippin, W4VT 26
Midwest Division Convention	29
New England Division Convention	29
Dakota Division Convention	29
A Modernized "Modern" Transmitter	Herbert M. Wallace, W8BQ 30
More Effective Link Coupling for R.F. Power Amplifiers	Robert T. Foreman, W9QT 34
Hamdom.	37
A Detector Circuit for Reducing Noise Interference in C.W. Reception	Leland D. Thompson 38
An RK-20 Tri-Tet Transmitter for Three-Band Operation	George Grammer 41
A New Type of Two Terminal Oscillator Circuit	45
A More Efficient Impeller for Wind-Driven Generators, Edwin C. Lynch, W5EQD	48
With the Affiliated Clubs	50
What the League Is Doing	51
For the Experimenter	
BATTERY-OPERATED PORTABLE TRANSMITTER — ANOTHER WAY OF MULTI-METERING — RK-20 KEYING CIRCUITS — CHIRPLESS KEYING WITH PENTODES — CALIPER COUPLING — HARMONIC SUPPRESSION	
I.A.R.U. News	55
Amateur Radio Stations	W8BQ, W9BEZ 57
Operating News	59
Correspondence Department	73
Standard Frequency Transmissions	80
Schedules for WWV	80
Ham-ads.	106
QST's Index of Advertisers	110

APRIL
1935

VOLUME XIX
NUMBER 4

Kenneth B. Warner (Secretary, A.R.R.L.), Editor-in-Chief and Business Manager; Ross A. Hull, Associate Editor; James J. Lamb, Technical Editor; George Grammer, Assistant Technical Editor; Clark C. Rodimon, Managing Editor; David H. Houghton, Circulation Manager; F. Cheyney Beekley, Advertising Manager; Ursula M. Chamberlain, Assistant Advertising Manager.

Editorial and Advertising Offices
38 La Salle Road, West Hartford, Conn.

Subscription rate in United States and Possessions and Canada, \$2.50 per year, postpaid; all other countries, \$3.00 per year, postpaid. Single copies, 25 cents. Foreign remittances should be by international postal or express money order or bank draft negotiable in the U. S. and for an equivalent amount in U. S. funds.

Entered as second-class matter May 29, 1919, at the post office at Hartford, Connecticut, under the Act of March 3, 1879. Acceptance for mailing at special rate of postage provided for in section 1103, Act of October 3, 1917, authorized September 9, 1922. Additional entry at Concord, N. H., authorized February 21, 1929, under the Act of February 28, 1925.

Additional second-class entries pending to cover sectional editions, February 4, 1935

Copyright 1935 by the American Radio Relay League, Inc.
Title registered at United States Patent Office.

QSL PRIZE WINNERS!

HUNDREDS COMPETE IN

Sylvania

\$500 PRIZE CONTEST

● Hundreds of licensed amateurs competed in Sylvania's QSL contest which closed February 4th. Literally thousands of QSL cards from other amateurs using Sylvania Graphite Anode Transmitting tubes were received. The winners did a lot of hard work, and Sylvania congratulates them as well as all of the other contestants who failed to win an award. Prizes have already been sent out to the following winners:

- 1st PRIZE** Gene Armstrong, Niceville, Florida, Station W4AGS
- 2nd PRIZE** Fred H. Stiening, 3245 Piedmont Ave., South Hills, Pittsburgh, Pa., Station W8FIP
- 3rd PRIZE** Lawrence Lasser, Kenilworth, D. C., Station W3CIC
- 4th, 5th, 6th PRIZES** O. L. Gibson, % Oklahoma A. and M. College, Stillwater, Okla., Station W5AJF; G. D. Ozburn, 110 South 10th Street, Marion, Iowa, Station W6ARW; R. F. Fennessy, 306 Chafonte St., Pittsburgh, Pa., Station W8LCI
- 7th, 8th, 9th PRIZES** T. A. Githens, 2320 South Boots, Marion, Ind., Station W9AEH; Dr. L. R. Carmona, Tuckerton, N. J., Station W2HHM; R. B. Parmenter, 3939 Gilman St., Mt. Mathews, Louisville, Ky., Station W9P1M
- 10th, 11th, 12th, 13th PRIZES** E. E. Bryant, Rt. 2, Box 400, Vacaville, Cal., Station W6EYR; Milton Dreyfus, Rt. 2, Box 60, San Angelo, Texas, Station W5AJY; A. J. Filkins, Fort Johnson, N. Y., Station W8ISX; H. D. Gott, 36 Mt. Pleasant St., Rockport, Mass., Station W1LT
- 14th to 22nd PRIZES** Bennett Adams, % American Tel. and Tel. Co., Birmingham, Ala., Station W4APU; Dr. George A. Mack, Aldridge Rd., Chappaqua, N. Y., Station W2BYP; Frank G. Mullins, 3214-8th St., Tuscaloosa, Ala., Station W4BQU; T. M. Jones, Jr., 602 East Walnut St., Decatur, Ala., Station W4BEL; A. R. Eggenberger, 812 11th Ave., Fargo, N. D., Station W9LBI; Gerard Callihan, Jr., Caruthersville, Mo., Station W0ISZ; E. E. Hare, 1336 East 4th Street, Owensboro, Ky., Station W6BW1; T. A. Gunter, 1715 Divine St., Columbia, S. C., Station W4COY; J. W. Donahue, 404½ W. 30th St., Los Angeles, Cal., Station W61JW

HYGRADE SYLVANIA CORPORATION

ELECTRONICS DIVISION

AMATEUR RADIO DIVISION



CLIFTON

NEW JERSEY



Section Communications Managers of the A.R.R.L. Communications Department

All appointments in the League's field organization are made by the proper S.C.M., elected by members in each Section listed. Mail your S.C.M. (on the 16th of each month) a postal covering your radio activities for the previous 30 days. Tell him your DX, plans for experimenting, results in 'phone and traffic. He is interested, whether you are an A.R.R.L. member or get your QST at the newsstands; he wants a report from every active ham. If interested and qualified for O.R.S., O.P.S. or other appointments he can tell you about them, too.

Eastern Pennsylvania Maryland-Delaware-District of Columbia Southern New Jersey* Western New York Western Pennsylvania	W3GS W3BAK W3ZX W8ISP W8CUG	ATLANTIC DIVISION Jack Wagenseller Edgar L. Hudson Carroll D. Kentner Don Farrell C. H. Grossarth	26 Meadowbrook Ave. 1107 Park Ave. 213 Hickok Ave. R. F. D. 3, Eicher Rd.	Llanerch, Upper Darby Laurel, Delaware Collingswood Syracuse Emsworth, Bellevue, Pa.
Illinois Indiana Kentucky Michigan Ohio Wisconsin	W9WR W9TE W9AUH W8DYH W8CIO W9FSS	CENTRAL DIVISION Fred J. Hinds Arthur L. Braun G. W. Mossbarger Kenneth F. Conroy Robert P. Irvine Harold H. Kurth	6618 West 34th St. 5211 Brookville Rd. Box 177 7538 E. Robinwood Ave. 5508 Northcliffe Ave. 631 State St.	Berwyn Indianapolis Camp Taylor Detroit Cleveland Madison
North Dakota* South Dakota Northern Minnesota Southern Minnesota	W9OEL W9PFI W9OMI W9DEI	DAKOTA DIVISION Hartwell B. Burner Mike G. Strahon R. L. Rode Francis C. Kramer	601 S. Grange Ave. W. Bluff St.	Hope Sioux Falls White Bear Lake St. Charles
Arkansas Louisiana Mississippi Tennessee	W5ABI W5DWW W5CWO W4BBT	DELTA DIVISION H. E. Velte W. J. Wilkinson, Jr. J. H. Weems, Jr. Merrill B. Parker, Jr.	2918 West 15th St. 1624 Allen Ave. P. O. Box 244 1912 Oak St.	Little Rock Shreveport State College Chattanooga
Eastern New York N. Y. C. & Long Island Northern New Jersey	W2LU W2AZV W2FOP	HUDSON DIVISION Robert E. Haight E. L. Baunach Charles J. Hammersen	1080 Helderberg Ave. 7823 10th Ave. 92 Claremont Ave.	Schenectady Brooklyn Verona
Iowa Kansas Missouri Nebraska	W9LEZ W9FLG W9EYG-JPT W9FAM	MIDWEST DIVISION Phil D. Boardman O. J. Spetter C. R. Cannady Samuel C. Wallace	325 Kirkwood Blvd. 305 Western Ave. Broadway at Ninth Green St.	Davenport Topeka Monett Clarks
Connecticut Maine Eastern Massachusetts Western Massachusetts New Hampshire* Rhode Island Vermont	W1CTI W1CDX W1ASI W1BYR W1AYJ W1QR W1ATF	NEW ENGLAND DIVISION Frederick Ellis, Jr. John W. Singleton Joseph A. Mullen Percy C. Noble Robert Byrnes Albert J. King Harry Page	19 Merrill Rd. 10 High Street 218 Jamaica way 37 Broad St. 12 Humphrey St. 70 Metropolitan Park Dr. R. 1	Norwalk Wilton Jamaica Plain Westfield Concord East Providence Hinesburg
Alaska Idaho Montana Oregon Washington	K7PO W7NH W7AAT W7AMF W7AYO	NORTHWESTERN DIVISION Richard J. Fox Nellie H. Hart O. W. Viers Frank L. Black Stanley J. Belliveau	Box 301 Box 6 Box 265 1502 McPherson St. Route 7, Box 387	Ketchikan Twin Falls Red Lodge North Bend Yakima
Hawaii Nevada Los Angeles Santa Clara Valley East Bay San Francisco Sacramento Valley Arizona Philippines San Diego San Joaquin Valley	K6EWQ W6EAD W6BPU W6BMW W6ZX W6SG W6DVE W6JF-W6QC K41XA W6EOP W6FFF	PACIFIC DIVISION Atlas O. Adams Keston L. Ramsay Howell C. Brown Charles J. Camp P. W. Dann Alan D. Whittaker, Jr. Geo. L. Woodington Ernest Mendoza Newton E. Thompson Harry A. Ambler Clyde C. Anderson	21st Infantry Brigade 1151 Buena Vista Ave. 120 N. El Molino Ave. 318 Hawthorne Ave. 1821 Chestnut St. 78 Elmor Ave. 716 Redwood Ave. 1434 East Madison St. P. O. Box 849 4101 Hamilton St. 931 Orange Ave.	Schofield Barracks Reno Pasadena Palo Alto Berkeley Mill Valley North Sacramento Phoenix Manila, P. I. San Diego Fresno
North Carolina Virginia West Virginia	W4OG W3BRY W8HD	ROANOKE DIVISION H. S. Carter Neil E. Henry C. S. Hoffmann, Jr.	115 Crafton St. 1017 Knight St. 100 20th St.	Winston-Salem Lynchburg Warwood, Wheeling
Colorado Utah-Wyoming	W9FA W6GQC	ROCKY MOUNTAIN DIVISION Glen Glasscock Arty W. Clark	1171 Detroit St. 260 So. 9th West	Denver Salt Lake City, Utah
Alabama Eastern Florida Western Florida Georgia-So. Carolina-Cuba- Isle-of-Pines-Porto Rico- Virgin Islands	W4KP W4BCZ W4MS W4CE	SOUTHEASTERN DIVISION L. D. Elwell Philip A. McMasters Edward J. Collins Bannie L. Stewart	1066 Waverly St. 212 9th St., North 1517 East Brainerd St. 310 Orange St.	Tarrant St. Petersburg Pensacola Georgetown, S. C.
Northern Texas Oklahoma Southern Texas New Mexico*	W5AUL W5CEZ W5ADZ W5AOP	WEST GULF DIVISION Glen E. Talbutt Carter L. Simpson Bradfield A. Beard Robert Shadden	1133 Amarillo St. 2010 So. 4th St. 2030 Quenby Road 1006 Orchard Place	Abilene Ponca City Houston Albuquerque
Maritime	VE1DQ	MARITIME DIVISION A. M. Crowell	69 Dublin St.	Halifax, N. S.
Ontario	VE3GT	ONTARIO DIVISION S. B. Trainer, Jr.	4 Shorncliffe Ave.	Toronto
Quebec	VE2EE	QUEBEC DIVISION Stan Comach	780 Brault Ave.	Verdun, P. Q.
Alberta British Columbia	VE4GD VE5AC	VANALTA DIVISION J. Smalley, Jr. R. K. Town	611 1st Ave., N. W. 1754 Graveley St.	Calgary Vancouver
Manitoba Saskatchewan	VE4BG VE4EL	PRAIRIE DIVISION A. J. R. Simpson Wilfred Skaife	71 Thelma Mansions 2040 McTavish St.	Winnipeg Regina

* Officials appointed to act until the membership of the Section choose permanent S.C.M.'s by nomination and election.

The American Radio Relay League



THE AMERICAN RADIO RELAY LEAGUE, INC., is a non-commercial association of radio amateurs, bonded for the promotion of interest in amateur radio communication and experimentation, for the relaying of messages by radio, for the advancement of the radio art and of the public welfare, for the representation of the radio amateur in legislative matters, and for the maintenance of fraternalism and a high standard of conduct.

It is an incorporated association without capital stock, chartered under the laws of Connecticut. Its affairs are governed by a Board of Directors, elected every two years by the general membership. The officers are elected or appointed by the Directors. The League is non-commercial and no one commercially engaged in the manufacture, sale or rental of radio apparatus is eligible to membership on its board.

"Of, by and for the amateur," it numbers within its ranks practically every worth-while amateur in the world and has a history of glorious achievement as the standard-bearer in amateur affairs.

Inquiries regarding membership are solicited. A bona fide interest in amateur radio is the only essential qualification; ownership of a transmitting station and knowledge of the code are not prerequisite. Correspondence should be addressed to the Secretary.

DIRECTORS

President
HIRAM PERCY MAXIM.....W1AW
Box 216, Hartford, Conn.

Vice-President
CHARLES H. STEWART.....W3ZS
St. David's, Pa.

Canadian General Manager
ALEX REID.....VE2BE
169 Logan Ave., St. Lambert, P. Q.

Atlantic Division
EUGENE C. WOODRUFF.....W8CMP
234 W. Fairmount Ave., State College, Pa.

Central Division
EDWARD A. ROBERTS.....W8HC
2699 Endicott Rd., Shaker Heights, Cleveland

Dakota Division
CARL L. JABS.....W9BVH
1822 James St., St. Paul, Minn.

Delta Division
M. M. HILL.....W5EB
P. O. Box 274, Natchitoches, La.

Hudson Division
KENNETH T. HILL.....W2AHC
115 Willow St., Douglaston, L. I., N. Y.

Midwest Division
H. W. KERR.....W9DZW-W9GP
Little Sioux, Iowa

New England Division
G. W. BAILEY.....W1KH
74 Webster Road, Weston, Mass.

Northwestern Division
RALPH J. GIBBONS.....W7KV
3953 N. E. 76th Ave., Portland, Ore.

Pacific Division
S. G. CULVER.....W6AN
2962 Russell St., Berkeley, Calif.

Roanoke Division
H. L. CAVENESS.....W4DW
State College Station, Raleigh, N. C.

Rocky Mountain Division
RUSSELL J. ANDREWS.....W9AAB
1867 So. Lafayette St., Denver, Colo.

Southeastern Division
BENNETT R. ADAMS, JR.....W4APU
1512 Grove Place, Homewood, Ala.

West Gulf Division
WAYLAND M. GROVES.....WSNW
c/o Humble Pipe Line Co., Neches, Texas

OFFICERS

President.....HIRAM PERCY MAXIM, W1AW
Hartford, Connecticut

Vice-President.....CHARLES H. STEWART, W3ZS
St. David's, Pennsylvania

Secretary.....KENNETH B. WARNER, W1EH
West Hartford, Connecticut

Treasurer.....ARTHUR A. HEBERT, W1ES
West Hartford, Connecticut

Communications Mgr....F. EDWARD HANDY, W1BDI
West Hartford, Connecticut

General Counsel.....PAUL M. SEGAL, W3EEA
1010 Shoreham Building, Washington, D. C.

Address all general correspondence to the executive headquarters at West Hartford, Connecticut



THE EDITOR'S MILL

WHEN this particular issue of *QST* gets into the hands of its readers the annual meeting of the A.R.R.L. board of directors will be approximately six weeks distant. It therefore behooves those members who have something on their chests to begin thinking just what it is they want or expect of their director and to advise him of their wishes, recommendations and desires with respect to amateur matters.

The board meeting is an important event in the yearly conduct of amateur radio and the League. It is the meeting where all the directors assemble in person from this country and Canada to analyze the present status of amateur radio, examine the affairs of the League, scrutinize the performance of the paid officers and other Headquarters employees, study our existing regulations for possible recommendations or amendments in the light of technical progress or limiting conditions in operation, map out plans of campaign for forthcoming national or international conferences and formulate policies for the coming year of activity.

The directors come to this meeting well prepared to discuss these subjects. The board meeting does not spring unheralded, as it were, from the sea of ham radio. During the past year a constant stream of information on all phases of amateur and League affairs, regulations, Washington developments, etc., has proceeded from Headquarters to each director, for his information. In addition, correspondence assuming, at times, almost voluminous proportions has been carried on between individual directors and West Hartford. Subjects for the coming meeting have been introduced, working rules suggested, mail votes taken on this matter or that, proposals to review certain actions taken at last year's meeting have been considered and voted upon. About the time this issue of *QST* goes out each director, too, will receive lengthy and detailed written reports of the year's activity in their particular departments from the League's president, vice-president, secretary, treasurer, communications manager, fieldman and general counsel. Coincidentally, each director will be doing his best to acquaint himself accurately with the affairs of his division, for each director is required to bring to the board

meeting an annual report of his own, reporting on the current situation in his part of the country and recommending this or that change in the light of the majority opinion of his division.

Your director wants to hear from you. All during the year he has been kept in intimate touch with national and government matters through Headquarters and will come to the meeting thoroughly informed on those subjects. But in order to reflect the opinion of his division and to act in a manner which will represent the majority views of the League members in his territory, he must have your views expressed to him sufficiently far ahead of the date of the meeting to permit him to combine your opinions with the opinions of others and thus arrive at some comprehensive picture of the desires of the division as a whole. It is your right and privilege to let him know what you think and what you want; more than that, it is your duty.

A point often overlooked by individuals in any group when conveying their desires to their accredited representatives is that asking or demanding something creates a responsibility on the part of the petitioner to acquaint himself with the subject involved, thoroughly and in detail. It is easy to make an unconsidered request for all the things you'd like to have, Santa Claus fashion. It is not quite so convenient to make a study of the basic facts pertaining to such requests, which is probably why so few people do it. The views of those who shirk that responsibility, however, deserve scant consideration.

Your directors . . . we have said it many times before . . . your directors are the bosses of A.R.R.L. The future of amateur radio and the future of the League lie in their hands. Nominated and elected by you, the members, they are answerable only to you and to themselves. More than ever before, they are endeavoring to obtain a true picture of the conditions in and wishes of their divisions, so that this information may be combined with the data which they have accumulated on the national and international aspects of amateur radio to result in decisions that will reflect the greatest good for the greatest number.

—A. L. B.

Do You Want a Kilowatt?

A High-Power Band-Switching 204-A Amplifier Requiring Only 50 Watts for Excitation

By Don H. Mix*

THE reader looking for a discussion of theory, for pointers on why impedances must be matched here and not there, or an argument on high- C versus low- C circuits is advised to skip the next few pages. This is not that kind of story, but one dealing with what happened in the construction of a high-power c.w. amplifier and what was done about it. Some of the dope may be ancient history, but we believe it will bear repeating nevertheless.

For quite some time now, in comparing the relative merits of transmitters, more stress seems to have been placed on plate circuit efficiency than other features. While high efficiency is of major importance and certainly something worth striving for, it seems probable that, in many cases, the average amateur considers the efficiency of his transmitter to a degree entirely out of proportion to one or two other important factors.

Each of the frequency bands assigned to amateurs offers its special brand of interest. With hourly changes in conditions, one frequency band may prove more effective than others for a given communication circuit. Hence, the amateur who cannot shift from one band to another quickly and without too much effort is missing a lot. Quick-switch medium-power transmitters and exciter units have been shown in *QST*. A great deal of time and effort has been devoted to this feature by commercial designers, until now a number of modern commercial transmitters include push-button frequency-changing devices. It would seem that quick shifting should be just as important to the high-power amateur, at least over the three most commonly used bands: 14, 7, and 3.5 mc. After all, what difference does it make if such a system might reduce the output 25 percent when, in most cases, a receiving station is unable to discern the difference in signal strength with a variation in output power of 300 to 500 percent? Fortunately even a 25 percent sacrifice in output is not necessary. With a few simple precautions, tapped coils may be used in high-power stages with negligible losses.

The factor which more than any other determines the amplifier layout and circuit is the tube selected. The number of high-power tubes outside the water-cooled class is limited to perhaps a half-dozen or less types. Although one or two of these have been designed particularly for high-frequency

work, in this case a 204-A was available and, consequently, was used. A few years ago, when most amateur operation was confined to the lower frequencies, the 204-A was highly respected and had the reputation of being a tube that could "take it" well. Its structure is such, however, that the interelectrode capacities are high, making it difficult to handle at the higher frequencies, particularly 14 mc., and for this reason, it has been more or less eclipsed in recent years, despite its ruggedness. Recently improvements in circuits¹ have revived interest in such high capacity tubes as the 203-A and 211, however, so it was decided to give the 204-A a chance to redeem itself.

The first circuit tried was that shown in Fig. 1. It was hoped that before the job was finished it would be possible to use tapped coils in the grid and plate circuits for band changing. This practically dictated the use of the split-stator type of neutralizing circuit if re-neutralization with each change in frequency was to be avoided. The idea behind the particular circuit shown was, of course, to avoid the necessity for a high-voltage split-stator condenser in the plate tank circuit, not only because of expense but also because it is difficult to obtain one with any appreciable maximum capacity. The condenser in the grid circuit might be one with a much lower voltage rating.

When an attempt was made to put the amplifier into operation, however, it was found that we had a first-class example of an amplifier which could not be neutralized, at least not within the range of a standard 50- μmfd . neutralizing condenser. Capacities greater than 50 μmfd . brought no improvement, so the 50- μmfd . condenser was ripped down until it was a mere skeleton of its former self—one rotor plate and one stator plate with an inch spacing between. With the plates of this condenser barely meshed, a point was found where the amplifier might be neutralized.

However, this didn't seem reasonable, and suspicion began to fasten upon the input capacity of the tube. The unbalancing effect of a high tube output capacity upon the split-stator neutralizing circuit has been pointed out in *QST*^{1,2} previously, and it was found that an even worse unbalance can occur in the grid circuit.

¹ Grammer, "Improving the Performance of the Neutralized Power Amplifier," *QST*, Jan. 1934.

² Goodman, "Simplifying Split-Stator Final Amplifier."

* A.R.R.L. Technical Information Service.

To compensate for the tube input capacity and restore a more normal capacitive balance in the grid circuit, the tuning-condenser section between filament and neutralizing condenser was shunted by a variable condenser which was adjusted to make neutralization possible with a neutralizing capacity approximately equal to the grid-plate capacity of the tube. It took nearly 350 $\mu\text{fd.}$ to do it! Since the grid and filament of the tube certainly did not look like a broadcast receiver tuning condenser, an explanation was sought in one or two reference books. From one of these³ it seems that the actual effective tube input capacity may be entirely different from the grid-filament capacity and that a capacity of 350 $\mu\text{fd.}$ is not an unreasonable figure. While the addition of this capacity might not be too objectionable, a more serious difficulty was encountered almost simultaneously. The amplifier would remain neutralized over only a very narrow range of plate circuit tuning. It is probable that the explanation for this was found along with that for the original trouble. The input capacity of a tube varies with plate load-circuit impedance, or, in other words, with tuning of the plate tank circuit. Therefore, it would seem to be impossible to maintain neutralization over an appreciable frequency range with a neutralizing system which depends upon the input capacity of the tube to maintain a balance in the grid circuit.

As a result, this circuit was abandoned and the circuit changed to that shown in Fig. 2. This circuit is similar to one of those shown previously in *QST*² where the advantages of the split-stator circuit may be realized even though the tuning condenser may be of the single-stator type. A slightly different method of neutralizing is employed in this case, however. The neutralizing condenser is a fixed condenser of a capacity approximately equal to the grid-plate capacity of the tube. Neutralization is then obtained by adjusting the variable section of the capacity bridge until a balance is obtained. Since this balance is undisturbed by varying the capacity of the tank condenser or the inductance of the coil, neutralization is maintained over a practically unlimited frequency range. Fortunately the output capacity of the tube, unlike the input capacity, does not vary appreciably with tuning but remains quite satisfactorily fixed with changes in plate load-circuit impedance.

One more piece of irrational operation showed up before our neutralizing troubles were entirely eliminated. Although the same setting of the neutralizing adjustment held perfectly at 7 and 14 mc., an entirely different adjustment was required for 3.5 mc. After an extensive search, a change in r.f. chokes solved the difficulty and neutralization held perfectly over all bands.

Provision for antenna coupling for the various bands often is found to be an awkward job me-

³ Morecroft, *Principles of Radio Communication*.

chanically and electrically. In this case the problem was solved in a simple manner by the use of a low impedance link between the amplifier plate circuit and the antenna circuit. This system has demonstrated its effectiveness and should tend to reduce undesirable harmonic output.⁴ With a simple arrangement it is possible to provide variable coupling between the tank coil and the small link coil. To render the antenna tuning

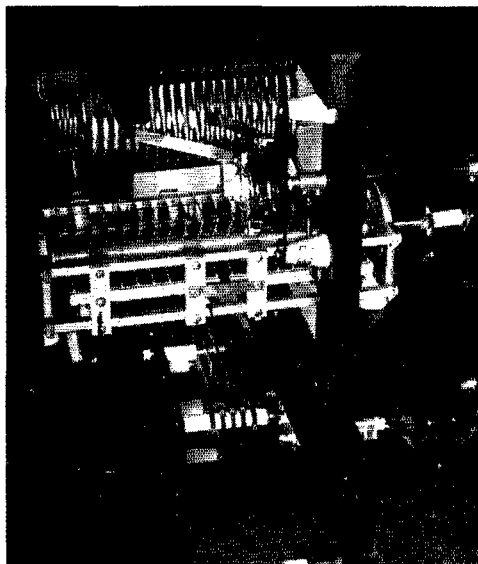

PLATE CIRCUIT DETAILS SHOWING PLATE CIRCUIT LINK COUPLING ARRANGEMENT, FIXED AIR CONDENSER, C₃, NEUTRALIZING ADJUSTMENT CONDENSER, C₄, AND THE PLATE CHOKES

equipment effective over a wide range of feeder lengths, a pair of loading coils is included.

CONSTRUCTIONAL DETAILS

Turning to the physical construction of the amplifier, the arrangement is of the open framework type. The frame is constructed of 1- by 2-inch smooth redwood given two or three coats of high-gloss quick-drying enamel. The panel is a single piece of quarter-inch plywood covered with a sufficient number of coats of Dupont flat black to obliterate the grain. The four vertical corner posts are 45½ inches long, the cross-members running from front to rear 15¾ inches long and those running from left to right 13¾ inches long. The panel is 15¾ inches by 45½ inches.

There are three main decks. The lower deck contains the grid circuit coil and condenser with the grid end of the 204-A. The central deck serves as a mounting for the plate circuit condensers, the fixed neutralizing condenser, r.f. choke, plate blocking condenser, and the plate end of the tube.

⁴ Boland, "Link Coupling to the Antenna Tuner," Experimenters' Section, *QST*, June, 1934; Grammer, "A General Purpose 50-Watt Transmitter," *QST*, Jan. 1935.

The third and top deck supports the plate circuit tank coil and the antenna tuning equipment. Horizontal cross-members below the lower deck hold the grid coil switch and grid circuit link coil. The plate coil switch is mounted on a vertical strip running between the central and upper decks. This construction results in an extremely rigid frame. All units are insulated from the frame and controls by means of stand-off insulators or insulating flexible shaft couplings. Filament by-pass condensers are mounted directly upon the lower tube mounting by means of small pieces of brass strip one-half inch wide.

Referring to the front view of the panel, the lower dial controls the grid circuit tuning condenser, C_1 , the one above it is attached to the neutralizing adjustment condenser, C_4 , and the next one turns the plate tank condenser. The two dials at the top of the panel are the antenna tuning condenser controls. The meter on the left is the plate circuit milliammeter and the one on the right the grid circuit milliammeter. There is sufficient space between and slightly below the antenna tuning dials for a thermometer for reading antenna or feeder current if one is available. A meter with a range of 5 amperes should be about right for most common feeder lengths. The knob at the top of the panel controls the loading coil switch.

INDUCTANCES

The grid circuit and antenna circuit coils are constructed by winding several more than the required number of turns of No. 12 soft drawn copper wire on a form 2 inches in diameter. When released from the form, the coil will spring to a slightly larger diameter and by the time the coil is mounted, the diameter will be just about $2\frac{1}{4}$ inches. Four strips of 1/16-inch by $\frac{1}{2}$ -inch fibre or bakelite are used to space the turns of the coil and make it rigid. Two of these strips extend about one inch beyond the first and last wire holes to provide a means of mounting the coil. The other two are cut off about $\frac{1}{2}$ -inch beyond the end holes. Holes spaced $\frac{5}{32}$ -inch are then drilled along the center line of each strip with a No. 36 drill. The strips are then threaded onto the coil simultaneously and in correct order. Care should be taken never to force the strips along more than a quarter turn at a time. When the threading has been completed, the four strips should be spaced equally around the circumference of the coil and then cemented to the turns with Duco cement. This construction takes a little patience but the reward is a coil which may be bounced upon the floor without damage and one which is easily tapped.

For each grid circuit coil and antenna loading coil, two strips $5\frac{3}{4}$ inches long and two $4\frac{1}{4}$ inches long are required. Three of the strips for each coil have 24 wire holes and the fourth 25. In threading the strips onto the coil, the strip with the extra hole should always be started first.

The antenna circuit coupling coil is constructed in a similar manner, the strips being $3\frac{7}{8}$ and $2\frac{3}{8}$ inches long. One strip has 13 holes and the remaining three 12 holes each. The spaces which may be seen at the center of the grid and antenna coupling coils were made for experimental purposes and should be disregarded. The two cross-pieces of each coil for mounting are strips of 3/16-inch bakelite, $\frac{1}{8}$ -inch wide and $2\frac{3}{4}$ inches long.

The plate tank coil is made in a similar manner except that the conductor is 3/16-inch copper tubing and only two strips are used for support. These strips are made of $\frac{1}{4}$ -inch bakelite, the lower being $6\frac{3}{4}$ inches long and the upper $6\frac{1}{4}$ inches long. The holes for the tubing are made with a quarter-inch drill and the hole centers spaced $\frac{5}{16}$ -inch. Because of the stiffness of the tubing it was found impossible to wind this coil satisfactorily with the strips projecting far enough past the ends of the coil to provide a means of mounting, so one strip was drilled and tapped and fastened to the stand-off insulators with short pieces of 8-32 threaded brass rod. The link coupling coil for the grid circuit and the one for the plate circuit are constructed similarly to the other wire-wound coils, using short pieces of fibre strips for separators. The winding form diameter for the plate tank coil should be $2\frac{1}{2}$ inches, that for the grid circuit link coil $2\frac{3}{4}$ inches and the one for the plate circuit link coil $1\frac{1}{4}$ inches. The grid circuit link coil is mounted upon a pair of stand-off insulators close to the ends of the coil.

In winding the plate circuit link coil, several turns more than the number required should be added. After the strips have been threaded to the center of the coil, the extra turns at each end should be straightened out and bent around as shown in the photographs. By using two large Eby binding posts with holes for the wire a simple variable coupling arrangement is provided. To vary the coupling, the two post tops are loosened and the end wires of the coil slid through the holes in the posts.

FIXED AIR CONDENSERS

The fixed air dielectric condenser C_3 is constructed like the one suggested on page 39 of *QST* for June 1934 with four National type GS-1 stand-off insulators as the mounting posts. Each plate is a piece of 1/32-inch sheet aluminum 2

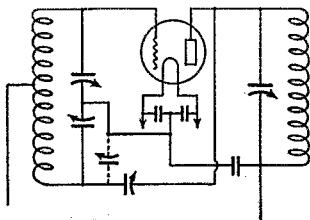

FIG. 1—CIRCUIT USING SPLIT STATOR CONDENSER IN THE GRID CIRCUIT—THE CIRCUIT WHICH DIDN'T WORK

inches by $2\frac{7}{8}$ inches. Holes are drilled in two edges of each plate $\frac{3}{16}$ -inch from the edge with a No. 28 drill to pass a long 6-32 screw. Brass spacers $\frac{5}{16}$ -inch long and $\frac{1}{4}$ -inch outside diameter separate each set of plates, giving plate separation of approximately $\frac{5}{32}$ inch. Similar spacers $\frac{1}{8}$ -inch long are used between the top of the insulator and the first of one set of plates. A total of five plates is used for this condenser. The four insulators carrying the plates are mounted on a bakelite base 3 inches square. There is no reason why a similar condenser might not be constructed for the neutralizing condenser C_6 . One with 5 or 6 plates 2 inches by $3\frac{1}{2}$ inches spaced $\frac{1}{4}$ -inch should be satisfactory.

R.F. SWITCHES

At the outset one of the problems encountered in changing inductance by means of taps was that of obtaining compact switches of suitable rating. Several different types were sketched but all of them seemed to be unavoidably bulky and difficult to construct without the aid of machine shop equipment. By the time we were ready for the switching mechanism, the Ohmite rotary switches became available. Although these switches were designed originally for low- and medium-power transmitters, they have worked out in an entirely satisfactory manner even at

high power so long as reasonable treatment is accorded them.

For wiring, No. 12 enameled wire makes a good job. The ends of the copper tubing coil are extended directly to the plate tank condenser terminals. Ordinary lamp cord is used for the link line between the plate and antenna circuits. A twisted pair made up of No. 18 "push-back" wire works well in the grid circuit link line to the driver, but lamp cord may be used here also, of course. One thing of great importance is that the leads between the grid and plate coils and their short-circuiting switches should be made as short as possible. Every inch counts here. Six porcelain feed-through insulators mounted on a strip at the rear of the frame serve as power supply terminals. R.f. excitation feeds into the pair on the left. Of the next group of three, the two outside terminals are for filament supply and the central one for bias. The single terminal to the right is for connecting the positive high-voltage lead. Two additional terminals at the top of the frame are for antenna feeder connections.

PARASITIC OSCILLATIONS

It should not be necessary to stress the importance of short leads in wiring. Unfortunately, however, with high-power tubes of this sort and the necessarily larger dimensions of the circuit

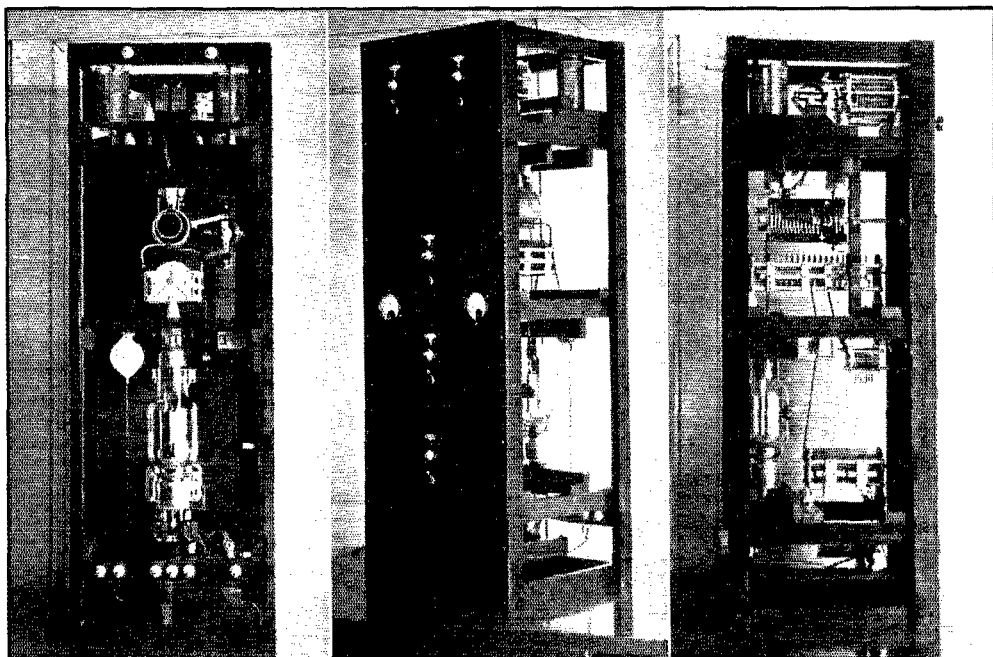

LEFT—The 204-A tube is easily accessible at the back of the set. The plate blocking condenser, to the right of the plate terminal of the tube, the fixed neutralizing condenser to the left and the terminal connections are visible in this photograph. CENTER—The frame itself is built of $2'' \times 1''$ pine. The panel is of plywood. Panel switching of plate and grid circuits plus fixed neutralization make rapid frequency shifts easy with this rig. RIGHT—The frame consists of three main decks holding the equipment. The tuned grid circuit equipment is supported by the lower deck, with plate circuit on the central deck. The feeder tuning condensers and coils are mounted at the top.

equipment, longer than normal leads cannot be avoided. But these should be made as short and direct as possible, avoiding "pretty-looking" bends.

The importance of lead lengths and placement of leads is illustrated by something which occurred just after the amplifier was first put into opera-

choke in the grid circuit, while eliminating the parasitic oscillation, also upset the neutralization to a certain extent. An attempt was made to trace the oscillatory circuit with a neon bulb with the amplifier operating at reduced plate voltage, but the entire set seemed to be ablaze with r.f. from top to bottom. Unfortunately, because of the construction and physical dimensions of the tube and associated equipment, it was impossible to reduce the lengths of leads appreciably. After several trials at alterations in the wiring, the fixed neutralizing condenser was moved to a different position which made it possible to reduce the length of its leads by a few inches. Although it was not found possible to eliminate the parasitic oscillation entirely, this change moved the point of oscillation to the maximum capacity end of the grid tuning condenser. This was entirely satisfactory for all practical purposes since it was well removed from the operating range.

While on the subject of parasitic oscillations, it might be well to mention that a low-frequency oscillation was eliminated by removal of an r.f. choke in series with the grid-biasing circuit. Since this circuit is series-fed, the choke is unnecessary.

DRIVER REQUIREMENTS

Considerable experimental work was done to determine the minimum driver power requirements. Obviously, a worthwhile amplifier should provide a reasonable step-up in power. An amplifier requiring a driver operating a plate voltage of a few thousand with a power input equal to one-third or one-half that of the final does not warrant the additional stage. It was found, however, that a driver output power of 50 watts (actual, not reputed) would do a pretty good job of exciting the amplifier to an input as high as 1000 watts at a plate voltage of 2000 with reasonable efficiency for c.w. work. Undoubtedly an improvement in efficiency would be obtained by operating the amplifier at a plate voltage of 2500 or 3000 volts, but voltages of this order were not available for test. The driver in use at the present time is the transmitter described by George Grammer in *QST* for January, 1935, with a pair of 830's substituted in the output for the 801's. This pair of tubes operates at a plate power input of about 85 watts. This is about the same order of power input often used with a pair of 10's or 801's. In fact, a pair of 10's was substituted with no noticeable difference in power output. This does not mean that any exciter unit using a pair of 10's in the output

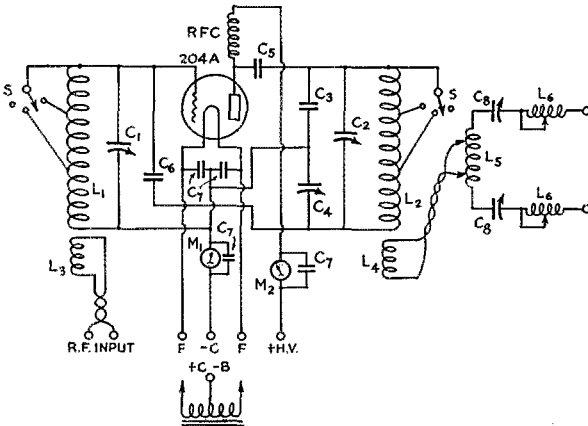

FIG. 2—FINAL CIRCUIT DIAGRAM

- C₁—150- μ fd. maximum. Hammarlund TC-150-B, 0.08-inch spacing.
- C₂—200- μ fd. maximum. Hammarlund TCD-100-A with sections connected in parallel—0.192-inch spacing.
- C₃—Fixed air condenser, capacity approximately 25 μ fd. (See text.)
- C₄—100- μ fd. maximum. National type TMC-100—0.077-inch spacing.
- C₅—Plate blocking condenser. .0015- μ fd, 5000-volt Dubilier Type 86.
- C₆—Fixed neutralizing condenser. 20- μ fd. 3000-volt Dubilier type PL-370-54.
- C₇—.001- μ fd. fixed by-pass condenser—Sungamo mica, receiving type.
- C₈—230- μ fd. maximum. National TM-230—0.077-inch spacing.
- L₁—24 turns No. 12 wire, 2 $\frac{1}{4}$ inches diameter, turns spaced 5/32 inch center to center, tapped at 3 $\frac{1}{4}$ and 10 $\frac{1}{4}$ turns from filament end. (See text.)
- L₂—20 turns 3/16 inch diameter copper tubing, 2 $\frac{3}{8}$ inch inside diameter, turns spaced 5/16 inch center to center, tapped at 3 $\frac{1}{4}$ and 11 $\frac{1}{4}$ turns from neutralizing end. (See text.)
- L₃—3 turns No. 12 wire 3 inches diameter, turns spaced 5/32 inch center to center. (See text.)
- L₄—4 $\frac{1}{4}$ turns No. 12 wire, 1 $\frac{3}{8}$ inches diameter, turns spaced 5/32 inch center to center. (See text.)
- L₅—12 turns No. 12 wire, 2 $\frac{1}{4}$ inches diameter, turns spaced 5/32 inch center to center. (See text.)
- L₆—24 turns No. 12 wire, 2 $\frac{1}{4}$ inches diameter, turns spaced 5/32 inch center to center. (See text.)
- M₁—Grid circuit milliammeter—0-200 scale.
- M₂—Plate circuit milliammeter—0-500 scale.
- S—Inductance tap switch—Ohmite transmitting.

tion. Although the immediate intention was to operate on 3.5 mc., the amplifier apparently was under the impression that it was supposed to be an ultra-high frequency transmitter working in the neighborhood of 50 mc.! Investigation showed that the parasitic oscillation was set up only when the grid circuit tuning condenser was adjusted near minimum capacity. But, unfortunately, this was the portion of the condenser capacity range which was desirable for tuning the grid circuit to the operating frequencies. Since tuning the plate circuit or even short-circuiting both plate and grid coils had no effect upon the parasite, the oscillatory circuit was made up, obviously, of the wiring leads. A small

working more or less indifferently will suffice. The 10's will have to operate at a good full 600 volts on the plate and deliver an output of not less than 50 watts at all three frequencies, which is not always easily done—especially at 14 mc. A pair of these tubes works nicely in the exciter mentioned above, however. If the amplifier is to be plate modulated, it probably would be advisable to use a somewhat greater driving power and also to hold the plate power input to not over the rated value.

BIAS

Starting with a grid leak biasing resistance of 10,000 ohms, the value was gradually reduced with improved efficiency, to a value of about 1500 ohms. With higher values of grid leak resistance, the amplifier operated less efficiently and trouble was experienced at 14 mc. with a reversal in grid current. In fact, the same trouble continued to a lesser degree with lower values of grid leak resistance. The substitution of a 90-volt "C" battery eliminated this trouble completely. Apparently peculiarities of the tube characteristics are responsible for this action.

NEUTRALIZING

In tuning up an amplifier of this sort, neutralizing, of course, is the first step. For this purpose, the grid circuit milliammeter is almost indispensable. Ordinary methods utilizing neon bulbs or flashlight lamps are not as useful with high-power amplifiers because the amount of energy fed through to the plate circuit often will be great enough to light a neon bulb almost to full brilliancy even when the amplifier is satisfactorily neutralized from a practical standpoint. This does not mean necessarily that the high-power amplifier may be neutralized less accurately than one of low power, but simply that commonly-used indicators are not sufficiently sensitive to show up minor discrepancies with the low-power rig. As a matter of fact, however, it is reasonable to expect that the larger dimensions of units required for the higher voltages and currents of a high-power amplifier, and the simultaneous necessity for longer leads, will tend to increase the feedback through stray couplings which cannot be neutralized out. The following procedure for neutralizing may be subject to criticism by some since it is carried out under conditions which are not exactly the same as the operating conditions. However, it has worked out in an entirely satisfactory manner and reduces uncertainties to a minimum.

The amplifier should be connected up as for regular operation except that the antenna and positive high voltage leads should be disconnected at the terminals at the rear of the amplifier frame. The exciter should be fired up and tuned for maximum amplifier grid current, the grid circuit of the amplifier being tuned simultane-

ously, of course. In most cases, the tuning of the amplifier grid circuit and that of the driver plate circuit will not be independent so that the two must be juggled around a bit to give the greatest grid current reading. It is a good idea to keep the amplifier plate tank circuit well away from resonance during this adjustment. The grid current should run between 160 and 180 ma. at 3.5 mc. and 7 mc., and about 120 ma. at 14 mc. When maximum grid current has been obtained, the plate tank circuit should be tuned through resonance while the grid circuit milliammeter is watched closely. Unless the amplifier happens to be completely neutralized, there will be a dip in grid current as the plate tank circuit is tuned through resonance. The dip may amount to a decrease of 50 percent if the adjustment is far from the neutralizing point. The condenser C_4 should now be adjusted in small steps while tuning the plate tank circuit back and forth through resonance continuously. As neutralization is approached, the dip will become less pronounced and when C_4 is correctly adjusted, the dip, if any, should be no more than barely perceptible. With this particular amplifier the correct point comes at about half scale on the dial of C_4 . An attempt was made to neutralize the amplifier with the positive terminal of the power supply connected to the amplifier (plate transformer primary circuit open, of course), but the correct adjustment was more difficult to determine. It was found that the grid current changed when the plate tank circuit was tuned through resonance with the positive power supply terminal connected, even though the amplifier operated in an entirely stable manner. Under these conditions the grid current increased rather than decreased so long as the amplifier was neutralized by the above method. When the amplifier was not neutralized, the grid current went through a combination of dip followed immediately by a rise, or vice-versa, when the plate tank circuit was tuned through resonance. While it was difficult to distinguish between the rise and the dip, a careful adjustment made it possible to remove the dip, leaving only the rise. This point coincided with the point determined by the previous method, which was so much easier that the other was discarded. The same adjustment of C_4 should hold for all frequencies. If it doesn't, try a change of plate circuit r.f. chokes.

TUNING

When first tuning up an amplifier, especially one of high power, it is always advisable to start out with reduced plate voltage. This is particularly important with this amplifier, because the current circulating in the tank circuit when unloaded will be extremely high with possible danger of burning up the short-circuiting switch and excessive heating of the tank coil itself. After one

(Continued on page 102)

Stepping Up the Output of the High-Stability 56-mc. Transmitter

An Added Stage for the 58-58 Oscillator-Amplifier Transmitter

By W. Conrad,* W9WC

UPON seeing the description in August *QST* of the 58-58 oscillator-amplifier transmitter, we spent some time planning a similar unit but with an additional and more powerful output tube. For the final amplifier we decided on a pentode which would operate at a plate potential of about 500 volts, and one having low enough grid-plate capacity to make it suitable for u.h.f. use. At the time of design the only tube available was the RK-23 or RK-25, depending on the filament requirements; in our case it was the RK-23 with the 2.5-volt heater. Having decided on the tube, we went about the circuit design and finally employed the standard pentode amplifier circuit with a few minor changes to adapt it for u.h.f. use.

In modifying the original transmitter, the antenna coupling condenser coil should be removed from the 58 transmitter and room made for the RK-23 and its associated plate coil, condenser, and the midget coupling condenser. The circuit is then arranged in accordance with Fig. 2. There are a few points that deserve special mention. Firstly, inductive coupling was not used because we wanted to eliminate an extra tuned circuit and keep the shielding down to a minimum; secondly, we are able to adjust the r.f. input to the RK-23 simply

by biasing is used throughout with exception of the suppressor grid. This bias voltage is obtained from batteries (in the original design, batteries with $1\frac{1}{2}$ volt taps were used).

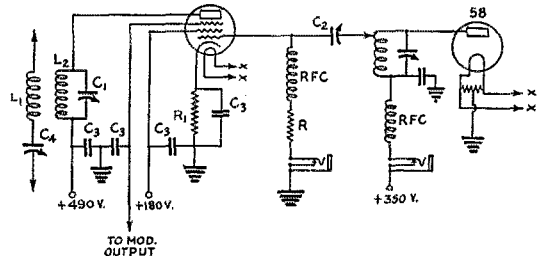

FIG. 2—THE AMPLIFIER CIRCUIT

- C_1 —35- μ fd. double-spaced transmitting midget condenser.
- C_2 —100- μ fd. midget.
- C_3 —100- μ fd. mica by-pass condensers.
- C_4 —50- μ fd. midget.
- R —25,000-ohm 2-watt.
- R_1 —400-ohm 20-watt.
- CH—Radio-frequency choke (National Type R-100).
- L_1 —2 turns No. 12 enameled wire, 7/8-inch diameter, turns spaced diameter of wire.
- L_2 —4 turns same as L_1 .

As seen in Fig. 1, the layout of parts is such as to keep all the r.f. leads down to the shortest possible length, and we suggest that this layout be followed. The RK-23 is mounted with the control-grid terminal toward the 58 amplifier.

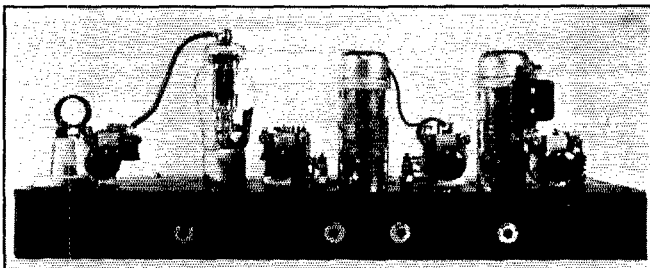

FIG. 1—THE COMPLETE TRANSMITTER

by varying the midget condenser C_1 . To avoid overloading the 58 amplifier and to keep the excitation under control for suppressor grid modulation, the adjustment of the r.f. input is very important.

Voltage for the screen grid is obtained from a bleeder-diver across the plate supply. Resistor

* 142 Clyde Avenue, Evanston, Ill.

TUNING

In tuning the transmitter, first open the plate supply to the RK-23 and put the grid meter in the jack supplied to measure the control-grid current of the RK-23. The 58-58 section of the gear is tuned up as suggested in August 1934 *QST*, with the coupling condenser set at about half capacity. After the frequency has

been set by the oscillator, the grid and plate tuning of the 58 amplifier are adjusted for maximum grid current at the RK-23. This should be in the order of 3-7 ma. and about 5 ma. should be obtained for suppressor modulation. After this grid current is obtained in the RK-23, its plate voltage is applied and the plate tank is tuned for maximum output. The antenna is then coupled and

tuned in the usual manner. Any other form of antenna tuning and coupling may be employed. The one shown is that used in the original transmitter.

THE MODULATOR

The modulator unit used for the original transmitter was altered as shown in the diagram (Fig.

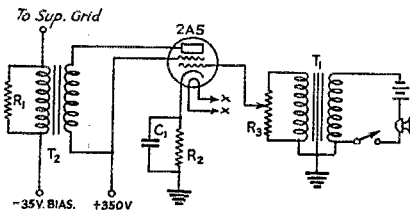

FIG. 3—THE MODIFIED MODULATOR

- T₁—Single button microphone transformer.
- T₂—1-1 output transformer to match plate of 2A5.
- R₁—2500-ohm 10-watt.
- R₂—600-ohm 10-watt.
- R₃—250,000-ohm potentiometer.
- C₁—10- μ f. dry electrolytic, 50-volt rating.

3) to make it suitable for suppressor grid modulation. Since we had already used a 1-1 output transformer for T₂, we merely changed the connections as shown. The resistor R₁ is used to place a permanent load on the modulator unit. The 2A5, when using a single-button mike, will deliver sufficient audio voltage for 100 percent suppressor-grid modulation of the RK-23.

POWER SUPPLY

In the power unit, the power transformer was replaced by one delivering 525 volts each side of

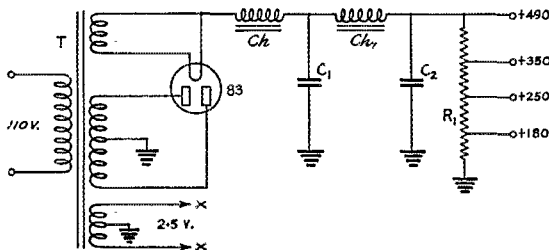

FIG. 4—THE NEW POWER SUPPLY

- T—Power transformer, 525-0-525 volts at 150 ma.
- Ch—10-henry 150-ma. choke.
- CH₁—20-henry 150-ma. choke.
- C₁—4- μ f. 1000-volt rating.
- C₂—8- μ f. 800-volt rating.
- R₁—26,000-ohm bleeder-divider with adjustable taps.

center at 150 ma., and the Type 80 was replaced by an 83. Choke input is also used (see Fig. 3).

MODULATION

For suppressor modulation, many factors enter the problem of getting good voice quality. These are: The adjustments of excitation, screen voltage, plate voltage, and control grid bias. Our

values are given but they are not necessarily correct for all cases. We used a 25,000-ohm resistor for the control-grid bias and a 400-ohm resistor in the cathode to keep plate current within safe limits in case of a failure of excitation. The control-grid current ran about 5 ma. with the screen voltage at 180 and with 490 volts on the plate. The plate current was 50 ma. with the antenna coupled. The best suppressor bias under these conditions was found to be minus 35 volts.

We would appreciate comment from anyone trying this layout and we will be glad to answer questions regarding the transmitter.

The original set is now operating daily at W9WC.

Drag out your directive arrays and your ultra-high frequency gear, gang. Signals on 56 and 112 mc. are climbing steadily as the Spring approaches and this Summer is certain to see records broken right and left. And while you're at it, keep in mind the Grunow U.H.F. Competition, announced in March QST.

Strays

FLASH!

Winners in VK Contest

(via radio from VK2EL, March 15th)

CT1ED, EA1AE, EI8B, F8RJ, G2ZQ, GI5NJ, HB9AT, I1ER, J2GX, LA3C, LY1J, MX2A, OE1ER, OH3NP, OK2OP, ON4RX, PA0AZ, PK3HT, SU1EC, TI2KF, V8AF, VE5BI, VP3AM, VQ4CRL, VS5AC, VS6AH, VS7GJ, VU2FY, W1SZ, W2AIW, W3BES, W4AJX, W5AX, W6TI, W7DVF, W8ZY, W9TB, X1AM, XLA1Y, YM4ZO, ZE1JO, ZL2FR, ZS1H, D4BAR. VE5BI won the station description for Amateur Radio magazine.

W8MJR suggests coating crystals with Higgins Waterproof Drawing Ink to lower the frequency. Frequency changes of as much as 12 kilocycles have been obtained by putting a few thin coats on each side of the crystal. The thicker the coat the greater the frequency change. The ink, which can be obtained from stationery stores or drafting-supply houses, can be washed off readily with alcohol or ether.

Did you notice the article in August *Atlantic Monthly* entitled "Paddling Through Europe?" The author is ex-CH9TC, Major R. Raven-Hart, Los Andos, Chile.

—W9QQ

A Compact "200-Watt" Transmitter

Three-Band Operation Featuring C.W. as Well as
Class-B and Grid-Bias Modulation

By Edwin Y. Webb, Jr., W4UP*

SINCE 1920 several transmitters have been used at W4LP-W4UP—some, in fact, staying together as long as overnight! However, changing conditions recently made it necessary to build a transmitter for service only; one that would require little attention and no disassembling. The transmitter now at W4UP is the product of two months' designing and 21 months' constructing. It is capable of 'phone and c.w. operation on three bands, with provision being made for the use of either grid or plate modulation for the former. Using plate modulation, the 300-watt input to the final stage can be completely modulated by a Class-B 800 audio amplifier, giving a carrier output of 200 watts. On c.w., power inputs as high as a kilowatt readily can be used, with 600 watts or more going into the antenna.

A pair of Western Electric 261-A tubes in push-pull constitute the output stage of the r.f. end of the transmitter. These are driven by a three-stage exciter consisting of a 59-Tri-tet oscillator, 59 doubler (the "universal exciter unit") and a 10 neutralized amplifier. The 10 is link-coupled to the tuned grid circuit of the final amplifier. The speech amplifier driving the 800's is push-pull throughout, using 57's in the first stage, 56's in the second stage, and 2A3's in the driver stage. Circuit diagrams of the r.f. and audio ends are given in Figs 1 and 2, respectively.

When a transmitter is to be situated in a living room a great deal of attention must be given to its appearance. Insofar as possible it must resemble, if not disguise itself as, a piece of furniture. Because of this requirement considerable thought was given to the physical layout and appearance of the set. The entire transmitter, r.f., a.f., and power supplies, is contained in the single cabinet, shown in one of the photographs.

*c/o A. T. & T. Co., 51 Ivy St., Atlanta, Ga.

GENERAL CONSTRUCTION

The cabinet stands 56 inches tall and is finished in walnut. Four shelves made of $\frac{3}{8}$ -inch by $1\frac{1}{2}$ -inch stock covered with plywood hold the four chassis, which rest on small metal knobs and are readily removable. The three doors make all controls easily accessible. These doors are covered with maroon damask to make the transmitter dust proof. The plate glass front is outlined by gold molding. The glass top is raised when the transmitter is in operation to allow air circulation, which is helped by a small fan beneath the amplifier-modulator shelf. Small gold holders, lathe turned, at each end of the test panel at the top hold $\frac{1}{4}$ -watt neon bulbs, one side of each being connected to the antenna feeders. The antenna outlets are tip jacks on top of the cabinet. Antenna tuning is accomplished by two condensers on the test panel. Either series or parallel tuning can be used by changing a switch on the rear of the panel.

As the photographs show, the transmitter is in four separate and complete units. The main power supply chassis, at the bottom of the cabinet, is arranged for either full-wave or bridge rectification, the change being made by means of switches on the chassis. With the center-tap system the output voltage is 1300, with bridge, 2600 volts. All chassis are made of $\frac{3}{4}$ - by 2-inch stock covered with plywood, and all except that for the

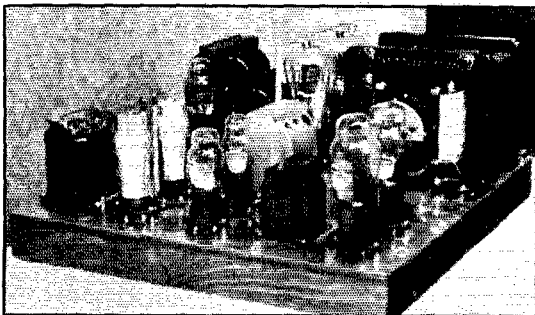

THE SPEECH-AMPLIFIER AND CLASS-B MODULATOR

Although this compact unit contains a three-stage speech amplifier, Class-B 800 modulator with all transformers, and a power pack for the speech stages, careful design and construction has made the assembly humless and free from feedback.

amplifier are covered with 16-gauge aluminum. A hole in the plywood to fit the wire, with a larger hole in the aluminum to pass it, affords a convenient means of running connections through the chassis. Wet electrolytic condensers were chosen for the main filter unit because of their low cost and healing qualities in case of breakdown. Wooden holders mounted in porcelain stand-off insulators bring the high voltage to the plates of the rectifier tubes. Outlet terminals are on porcelain stand-off

insulators at the rear of the chassis. The higher voltage of 2600 volts, obtained by bridge rectification, is used for c.w.

SPEECH AMPLIFIER AND MODULATOR

The amplifier-modulator unit, next above the main power supply, contains a separate power supply for the speech amplifier. The push-pull 57's in the first speech stage are resistance-coupled to push-pull 56's; transformer coupling is used between the 56's and push-pull 2A3's. All tube sockets are mounted on $\frac{3}{8}$ -inch brass supports to raise them above the aluminum. The W.E. microphone transformer, on the front left corner of the chassis, is pivoted on one of its corners and a micrometer screw adjustment brings it to the angle giving least hum pickup from the plate-supply transformer. The plate-supply transformer, rectifier, choke and filament transformer are in the left rear corner. The Class-B output transformer is on the right rear corner. The volume-control potentiometer and microphone-current control potentiometer are mounted on the chassis behind the microphone transformer. A jack makes mike-current readings convenient. The bias control potentiometer is located just beyond the 2A3's. Porcelain bushings bring the high-voltage leads to the output transformer, and porcelain standoff insulators at the rear of the chassis serve as terminals for external connections. The bias for the 800's is obtained from "B" batteries mounted under the shelf holding the chassis. Batteries are used for this job because they form a convenient low-voltage supply maintaining practically constant voltage under fluctuating loads. After being in service for about six months they now show a higher voltage than when new, as a result of the charging effect of grid current.

In this chassis every connection except those for the high voltage is made with shielded wire, with the shields grounded at each end and in the middle. This is a necessary precaution both from an audio and radio frequency standpoint, the grid leads to the 57's especially being very susceptible to r.f. Since the picture was made, the grid caps themselves have been shielded by spiraling tin foil around them, with friction tape for insulation. Jacks for reading plate currents and voltages are mounted in the frame of the chassis. As the diagram (Fig. 2) shows, the microphone current is obtained from the amplifier plate supply. The rheostat (P_2 in the diagram) shunting the microphone voltage affords a very convenient and effective means of controlling the current. Every resistor and condenser unit is in an aluminum shield can. Resistances in proximity to each other in the circuit—such as R_1 and R_2 , R_3 and R_4 , R_{12} and R_{13} , R_5 and R_6 , etc.—are paired in the same shield cans, with the braid covering of the connecting wires entering the cans. These precautions are necessary because of the high gain

and compactness of the unit. Hum in the amplifier is imperceptible. A few of the higher harmonics of the power supply could not be balanced out by orientation of the microphone transformer,



THIS COMPLETELY SELF-CONTAINED TRANSMITTER CAN BE OPERATED ON BOTH C.W. AND 'PHONE ON THREE BANDS

Input for plate-modulated 'phone is 300 watts; on c.w. up to a kilowatt. The final amplifier also can be grid-modulated.

being of dissymmetrical wave form, but grounding one side of the filament winding eliminated all trace of them.

RADIO-FREQUENCY EQUIPMENT

The r.f. exciter unit consists of a Tri-tet oscillator, 59 buffer-doubler and 10 driver. During two weeks of experiment with a Tri-tet it was found that the oscillator was more stable

with the third grid grounded than with any other connection, hence the arrangement shown in Fig. 1. The coils are shop-made and plug into 'phone tip jacks inserted in small stand-off legs which raise the coils about $2\frac{1}{2}$ inches above the aluminum panel. The "plugs" of the coils are made of 6/32 machine screws with the section entering the jack turned smaller to fit. This allows the "plug" to be fastened to the bakelite coil form with 6/32 nuts. The turning can be done easily by mounting a hand drill in a vise

with the 6/32 bolt in the chuck; then, while the drill is turned, pressing a file on each side of the revolving screw. The part of the screw in the chuck is unaffected; it is this part which is fastened in the coil form. A single-pole double-throw switch eliminates the buffer-doubler stage when not needed. Potentiometers control the bias voltage on the buffer and driver stage. This voltage is critical for maximum output on all frequencies above 3900 kc. The oscillator stage is at the left of the chassis, with the buffer tube

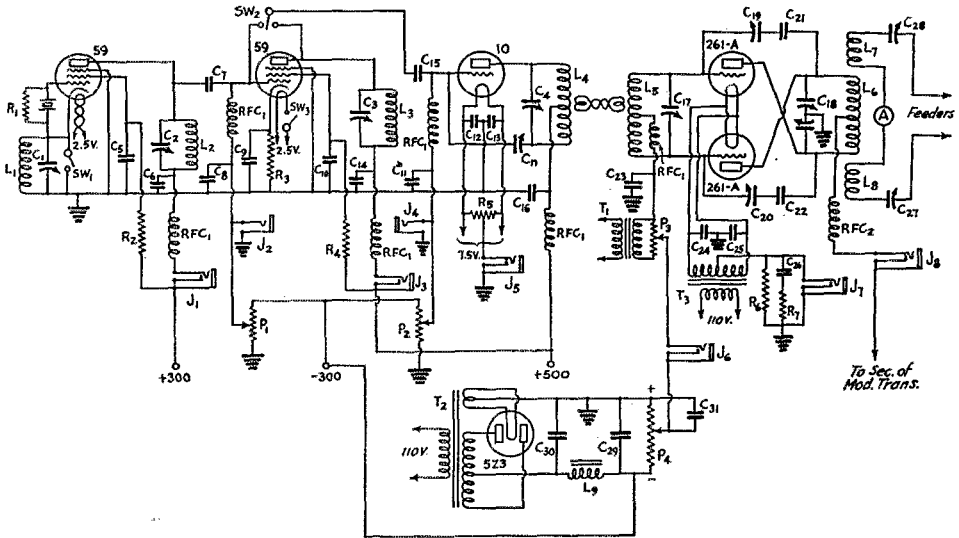

FIG. 1—CIRCUIT DIAGRAM OF THE R. F. SECTION

The exciter, consisting of the 59 oscillator, 59 doubler and 10 buffer, is one unit; the final amplifier and bias supply are in a separate section.

- C₁—100- μ fd. midget variable.
- C₂, C₃, C₄—50- μ fd. midget variables.
- C₅, C₆—0.1 μ fd., 600-volt.
- C₇—0.01 μ fd., 600-volt.
- C₈ to C₁₄, inc.—0.1 μ fd., 600-volt.
- C₁₅—0.01 μ fd., 600-volt.
- C₁₆—0.1 μ fd., 600-volt.
- C₁₇—50- μ fd. midget variable.
- C₁₈—Split-stator variable, 250 μ fd. per section, 7000-volt.
- C₁₉, C₂₀—25- μ fd. neutralizing condensers (double-spaced from 100- μ fd. midgets).
- C₂₁, C₂₂—0.02 μ fd., 5000-volt.
- C₂₃—0.01 μ fd., 200-volt.
- C₂₄, C₂₅—0.1 μ fd.
- C₂₆—25 μ fd., 1000-volt.
- C₂₇, C₂₈—200- μ fd. variables, double-spaced.
- C₂₉, C₃₀, C₃₁—8- μ fd. electrolytics, 500-volt.
- C₆—100- μ fd. midget double spaced to give 25 μ fd.
- R₁—400,000 ohms, 1-watt.
- R₂—50,000 ohms, 1-watt.
- R₃—500 ohms, 5-watt.
- R₄—100,000 ohms, 1-watt.
- R₅—100 ohms, center-tapped.
- R₆—750 ohms, 25-watt.
- R₇—100 ohms, 5-watt.
- P₁, P₂—50,000-ohm, 5-watt potentiometers.
- P₃—25,000-ohm volume control potentiometer.
- P₄—15,000-ohm, 10-watt potentiometer.
- RFC₁—8-mh. r.f. chokes.
- RFC₂—4-mh. 500-ma. r.f. choke.
- J₁, J₂, J₃, J₄, inc.—Single circuit-closing jacks.
- J₅, J₆—Single open-circuit jacks.
- L₁—34 d.s.c. No. 18 d.s.c. on 1½" form, close-wound.
- L₂—3.5 mc.—same as L₁.

- 7 mc.—15 turns No. 18 d.s.c. on 1½" form, close-wound.
- L₃—7 mc.—15 turns No. 18 d.s.c. on 1½" form, close-wound.
- 14 mc.—8 turns No. 18 d.s.c. on 1½" form, close-wound.
- L₄—3.5 mc.—18 turns No. 18 d.s.c. on 3" form, close-wound.
- 7 mc.—9 turns No. 14 on 3" form, ¼" spacing between turns.
- 14 mc.—5 turns No. 14 on 3" form, ¼" spacing between turns.
- L₅—3.5 mc.—34 turns No. 18 d.s.c. on 1½" form, close-wound.
- 7 mc.—15 turns No. 18 d.s.c. on 1½" form, close-wound.
- 14 mc.—8 turns No. 18 d.s.c. on 1½" form, close-wound.
- L₆—3.5 mc.—25 turns ¼" tubing, diameter 2½", ¼" spacing between turns.
- 7 mc.—15 turns ¼" tubing, diameter 2½", ¼" spacing between turns.
- 14 mc.—6 turns ¾" tubing, diameter 3", ¼" spacing between turns.
- Link turns are 4, 3 and 3 (at both ends) for the 3.5-, 7- and 14-mc. bands respectively.
- L₇, L₈—3.5 mc.—7 turns ¼" tubing, diameter 3½", ¼" spacing between turns.
- 7 mc.—5 turns ¼" tubing, diameter 3½", ¼" spacing between turns.
- 14 mc.—4 turns ¼" tubing, diameter 3½", ¼" spacing between turns.
- L₉—30-henry choke.
- T₁—Transformer for grid modulation.
- T₂—Power transformer, 600 volts c.t., 100 ma.
- T₃—10-volt filament transformer.

in the middle at the front; the buffer tuning circuit is at the right. The 10 driver is to the rear of the buffer tank circuit. The plate transformer, choke, condensers and rectifier are at the rear of the chassis. All connecting leads terminate on porcelain stand-off insulators at the rear.

The top chassis is that of the final amplifier. The tank assembly is complete within itself and the entire unit is removable. The bias supply for the amplifier is at the left in the photograph of the amplifier unit. The neutralizing condensers are mounted on hard rubber supports at the sides of the tubes. The regular type of split-stator condenser was not convenient to mount here so two single condensers, one on top of the other, were used. This chassis is covered with hard rubber instead of aluminum because of the intense field in the vicinity of the tank coil. The audio transformer in series with the bias supply makes grid modulation possible in this chassis. This type of modulation is used only in case of emergency, the change-over requiring about thirty seconds.

The meter panel at the top of the cabinet contains a thermocouple r.f. meter, a universal test meter assembly and the antenna tuning condensers. When currents are being checked the test cord is inserted in the current jack J_6 , Fig. 3. The shunt R_c is then across the circuit, with the

calibrated resistance P in series with the meter, which has a 0-1 milliamperere range. The shunt, R_c was made from the element of a $\frac{1}{2}$ -ampere filament rheostat and measured with a Wheatstone bridge to have a value of 5 ohms. The calibrated series resistance P controls the amount of current flowing through the meter itself. The resistance needed at P will depend upon the current range desired and the resistance of the milliammeter; for the 37-ohm instrument used in this case the following values are needed:

Full-Scale Deflection	Resistance of P
10 ma.	8 ohms
50 ma.	208 ohms
100 ma.	453 ohms
200 ma.	953 ohms
400 ma.	1953 ohms

For milliammeters of other internal resistances, the following equation will give the proper value for P for any current range:

$$R_p = \frac{(I - I_m) R_c}{I_m} - R_m$$

where R_p is the required resistance, I is the desired full-scale deflection, I_m is the full-scale reading of the milliammeter alone, R_c the resistance of the calibrated shunt, and R_m the internal resistance of the meter.

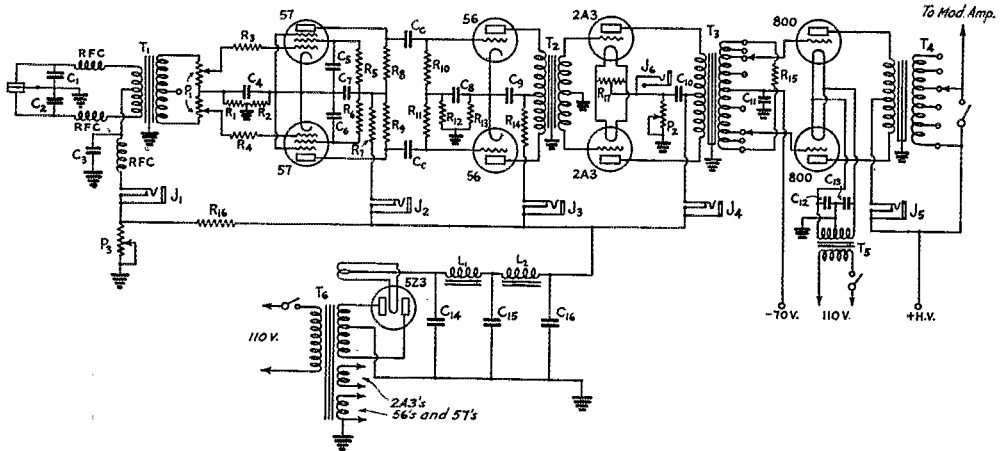
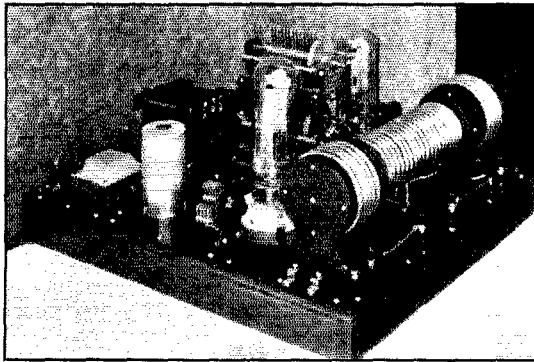

FIG. 2—SPEECH AMPLIFIER, MODULATOR AND SPEECH-AMPLIFIER POWER SUPPLY DIAGRAM

- C_1, C_2 —0.01 μ d.
- C_3 —25- μ d., 25-volt electrolytic.
- C_4, C_5, C_6 —1 μ d.
- C_7 —8- μ d. electrolytic.
- C_8 —1 μ d.
- C_9, C_{10} —8- μ d. electrolytic.
- C_{11}, C_{12}, C_{13} —1 μ d.
- C_{14}, C_{15}, C_{16} —8- μ d. electrolytics, 500-volt.
- C —0.1- μ d. mica condensers.
- R_1 —100,000 ohms, 1-watt.
- R_2 —1500 ohms, 2-watt.
- R_3, R_4 —50,000 ohms, 1-watt.
- R_5, R_6 —200,000 ohms, 1-watt.
- R_7 —10,000 ohms, 2-watt.
- R_8, R_9 —200,000 ohms, 1-watt.
- R_{10}, R_{11} —500,000 ohms, 1-watt.
- R_{12} —100,000 ohms, 1-watt.

- R_{13} —1500 ohms, 2-watt.
- R_{14} —3000 ohms, 5-watt.
- R_{15} —40,000 ohms, 2-watt.
- R_{16} —50,000 ohms, 2-watt.
- P_1 —250,000-ohm (each section) dual potentiometer.
- P_2 —500-ohms, 10-watt potentiometer.
- P_3 —1000-ohm, 2-watt potentiometer.
- J_1 to J_5 , inc.—Single circuit-closing jacks.
- J_6 —Open-circuit jack.
- T_1 —Microphone transformer (W.E.).
- T_2 —Audio transformer, 1:3 ratio.
- T_3 —Class-B input transformer.
- T_4 —Class-B output transformer.
- T_5 —7.5-volt filament transformer.
- T_6 —Power transformer, 250 watts, 600 volts c.t.
- RFC—8-mh. r.f. chokes.

When the test cord is inserted in the voltage jack, J_v , the 5-ohm shunt is removed and the series resistors enter the circuit. Since one milli-ampere will always deflect the meter to full scale, and one mil through the thousand-ohm resistor R_1 will result when one volt is applied, the meter will then be reading one volt at full scale. Three thousand volts across a 3-megohm resistor will force one milli-ampere through it and the meter will again read full scale. This neglects the resistance of the meter itself, but the error so introduced is negligible—less than that resulting from deviations of the resistors from their rated values. Plate voltages are read by inserting the plug only partially in the jack in the circuit under test. This places a voltage above ground on one side of the meter and the switch SW_3 connects the other side to ground. When reading grid voltages the tip of the jack connects to the voltage source and the



THE FINAL AMPLIFIER UNIT WITH TWO 261-A TUBES IN PUSH-PULL

An unusual feature of this amplifier is the coil assembly, tank and antenna coils being constructed in one removable unit. The bias rectifier is in the shield can to the left of the neutralizing condenser.

sleeve is already grounded on the jack in the aluminum base. Since grid voltages are negative above ground and plate potentials are positive, the polarity reversing switch SW_1 gives the correct deflection without changing the plug connections.

On this test panel are located the two buttons for starting and shutting down the transmitter. This operation is accomplished by a small reversible a.c. motor. The actual switching is performed by a three-way key switch to which the control buttons, motor, power line and power transformers are so connected that when the switch lever is down the power is off, when in the neutral position the power is applied to the filaments, and when in the up position the plate power is applied. The motor connections are likewise changed so that when the transmitter is in full operation, pressing the stop button will reverse the direction of motor rotation, thus shutting off plate and filament power. The switch is operated by a six-inch hard-rubber disc having a pin in its periphery which engages with the switch lever. The disc is belt driven by the motor, the speed reduction being 20 to 1. A variable resistance in series with the motor field used for the starting direction permits further reduction of speed so that the time delay between application of filament and plate power can be adjusted to any practical value desired. No resistance is used in the reversing field winding, so the transmitter shuts down rapidly. The motor automatically stops itself when its operation is completed.

Extensions from the two control buttons are mounted on a small panel on the side of the receiver table. With them is a small rotary quick-acting snap-switch for break in. Operating this switch operates a relay which opens the plate supply of the oscillator and opens the primary of the high-voltage transformer. A $\frac{1}{4}$ -watt neon lamp shunts this switch and acts as an indicator to show when the transmitter is in the operating condition. When the switch is open the voltage across it lights the neon lamp, showing the transmitter is idle.

OPERATING NOTES

Crystals ground for the 3500- to 4000-ke. band are used for work on all frequencies. On 3.5 mc.

(Continued on page 98)

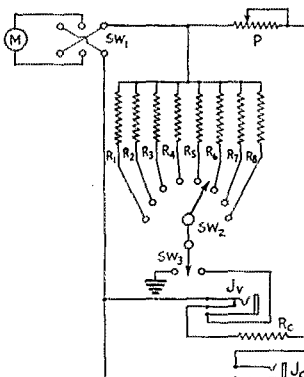

FIG. 3—TEST PANEL WIRING

A single 0-1 d.c. milliammeter is used for multi-range voltage and current measurements.

M—0-1 d.c. milliammeter.

P—Calibrated potentiometer (see text).

R_1 —1000 ohms.

R_2 —10,000 ohms.

R_3 —50,000 ohms.

R_4 —100,000 ohms.

R_5 —500,000 ohms.

R_6 —1 megohm.

R_7 —2 megohms.

R_8 —3 megohms.

R_9 —5 ohms, 25-watt.

J_v —Single closed-circuit jack.

J_c —Open-circuit jack.

SW_1 —D.p.d.t. toggle switch.

SW_2 —8-point rotary switch.

SW_3 —S.p.d.t. toggle switch.

More on the Practical Operation of Transmitting Antennas

Impedance Matching and Directional Features of Harmonically-Operated Long-Wire Types

By W. S. Potter,* W8GLY, and H. C. Goodman,** W8BOG

ALTHOUGH much information has been published recently on the subject of transmitting antenna systems, little has been said concerning certain practical aspects involving the radiator itself. It is the purpose of this article to attempt, in a measure, to explain something of the theory involved insofar as it affects practical antenna erection and operation, particularly for harmonic operation, and to describe practical checks on the performance such that we may realize still greater effective radiated power per transmitter watt. The introduction of mathematics into the discussion has been purposely limited to simple algebraic expressions and these have been used only where they are essential.

RADIATOR LENGTH AND IMPEDANCE

We know that an r.f. transmission line, to function most efficiently, must be terminated in its surge impedance. In order to realize proper conditions of match in terms of power transfer, the terminating impedance at each end must appear to the line not as a complex reactive impedance but as a pure resistance. In other words, the algebraic sum of capacitive reactance and inductive reactance at the antenna end as well as at the transmitter end must equal zero; that is, the reactance of capacity must equal in magnitude the reactance of inductance.

Now, without delving into complex calculations, we find that if we have an impedance Z , then

$$Z = \sqrt{X^2 + R^2} \quad (1)$$

Supposing resistance R equal to 73.2 ohms, as in the case of a half-wave radiator, and inductive reactance X equal to 42.5 ohms, we can determine Z by substituting in (1)

$$\begin{aligned} Z &= \sqrt{(42.5)^2 + (73.2)^2} \\ &= 84.5 \text{ ohms (reactive)} \end{aligned}$$

But we have a value of inductive reactance in our calculation and we want Z to equal only a value of pure resistance. We can again bring Z equal to 73.2 ohms (the non-reactive value) by decreasing the value of the inductive reactance (positive)

or by increasing in the correct amount the value of capacitive reactance (negative).

$$\begin{aligned} \text{Let } X_L &= \text{Inductive reactance} \\ X_C &= \text{Capacitive reactance} \\ X &= X_L - X_C \end{aligned} \quad (2)$$

If we satisfy $X = 0$
then $Z = R$, from (1)

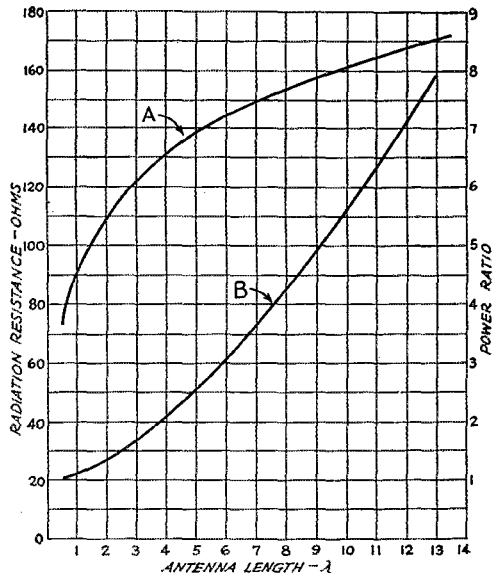

FIG. 1—THE IMPORTANT CURVES FOR HARMONICALLY-OPERATED HORIZONTAL ANTENNAS

Curve A shows the variation in radiation resistance with antenna length. Curve B shows the power in the lobes of maximum radiation for long-wire antennas as a ratio to the maximum of a half-wave doublet antenna.

The fact that in practice we can so juggle the reactive component of a complex impedance by tuning, and do so quite accurately, without worrying about the definite values we are subtracting or adding, accounts for the comparative ease with which we may arrive at a perfect or near perfect match at the input terminals of our transmission line where we can use a coupling circuit or matching network which accomplishes just what we have described above. Anyone

* 400 North Lexington Ave., Pittsburgh, Pa.

** 125 South Graham St., Pittsburgh, Pa.

who can tune a transmitter matching network can just as surely—but with some slightly greater expenditure of effort—match the remote end of the line to the antenna, which is after all the business end and the one at which the greatest losses generally occur.

The problem at the radiator end is one which involves making alteration in the electrical elements which are causing said radiator to be something which does not serve as a purely re-

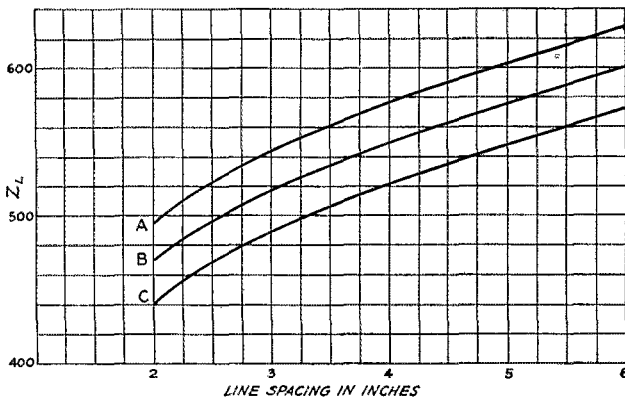

FIG. 2—CHARACTERISTIC IMPEDANCE VS. SPACING OF CONDUCTORS FOR OPEN-WIRE TRANSMISSION LINES
Curve A is for No. 14 B & S copper wire, Curve B for No. 12 and Curve C for No. 10.

sistive load for the line. Even the transmission line which potentially has the rating of an "AAA1" performer is in many cases not even a fairly good actor, simply because the radiator it feeds is either a little bit short or long for its particular job. In such cases the radiator would serve to terminate the transmission line, not in its surge impedance, but in a value of Z which may be far from it; and which, in fact, is a complex reactive quantity. We must have a purely resistive load for our transmission line—and we can get it.

Right here and now, we had better qualify that statement about the radiator "a little bit short or a little bit long." Sounds simple, doesn't it? We can correct our radiator self-impedance to match our line by just shortening or lengthening it—and we can tell quite easily just when we have it matched, too.

But wait; there are a few important considerations that we should at least think over before we go up on the roof. Turn back to the example just below equation (1) and look at the values given—they are actual quantities involved in one case, looking at the electrical center (current antinode) of an ideal half-wave radiator. But there are many factors which determine precisely the effective impedance of a practical radiator. To list them in order of their importance would require complete data on given location, with some knowledge as to its geophysical character-

istics, etc. However, in general the self- or effective impedance of the radiator is governed by its radiation resistance, affected by its length, its height above ground, conductivity of the earth, proximity to supporting fixtures and other objects including feeder systems. Fortunately for conditions ordinarily encountered at frequencies commonly used (excepting those above 20 mc.), only the radiation resistance and the height above ground need be considered. We may, with these facts in mind, equate

$$Z_A = Z_R + Z_C \quad (3)$$

where

Z_A = Self-impedance of the radiator

Z_R = Radiation resistance

Z_C = "Correction impedance," which is necessarily a function of height and other factors.

Now radiation resistance Z_R is a property attributed to a radiator, which multiplied by the current squared gives the value of the total radiated energy. Its value is determined by the effect of surrounding objects, including the earth.

Thinking further about the whole matter of self-impedance leads us to the effect of inductive and capacitive coupling between the radiator and the above-mentioned

adjacent objects and the earth. This quantity, which we have designated Z_C , is made up of a complex array of mutual impedances which we will not attempt to evaluate. Rather, we shall try to correct for their presence by simple experimental means. They do not in actual practice (at frequencies below 20 mc.) generally exceed values of several ohms per half-wave section in any radiator. In long-wire radiators Z_C becomes an important quantity, however, because of the mutual impedances of adjacent half-wave sections; but even here we can correct experimentally for discrepancies they introduce. Therefore we shall not attempt any absolute evaluation of Z_C .

The foregoing shows that an ideally situated half-wave radiator will have a self impedance which will be the practical equivalent of the value of its Z_R (shown on the curve A of Fig. 1). Then $Z_A = Z_R$. By the same course of reasoning, an ideally situated long-wire radiator will have its $Z_A = Z_R$, with the factor Z_C brought into the picture because of the effect of each half-wave section (element) on the others. Curve A of Fig. 1 shows the relation, antenna length vs. radiation resistance, which is useful for recommended and ordinarily attainable elevations.¹ The radiation

¹ See, "Development of Directive Transmitting Antennas," by Carter, Hansell and Lindenblad, *Proc. I.R.E.*, Oct. 1931.

The figure is reproduced from this paper by permission of the secretary of the I.R.E.

resistance values of this curve, each representing the total power radiated divided by the current at a current antinode, indicate the effective load resistance for a line coupled into the radiator at a current antinode. This will be brought out further in the practical design to be described later. Curve B of this figure indicates the power radiated in the directions (lobes) of maximum radiation with harmonically-operated long-wire antennas, compared with the power in the direction of maximum radiation with a simple half-wave (doublet) antenna, the total antenna power being the same in each. This involves directivity, as will also be brought out in the design to be described further on.

MATCHING RADIATOR AND LINE

Correct dimensioning of the radiator to give the proper impedance match to the transmission line for one particular frequency, particularly with long-wire antennas harmonically operated, is probably the one point where seemingly the least attention has been focused. A potentially good system with improper termination gives rise to all sorts of troubles, among which are induced r.f. in the speech equipment, ditto in the lighting and telephone circuits, poor transmission line efficiency with standing waves thereon and radiation therefrom, and a host of others.

By simple manipulation of the length of the antenna we can correct for discrepancies, making the quantity Z_A purely resistive, and hence provide a correct load for our transmission line. We could calculate for phase angle, etc., in a radiator where Z_A has a reactive component and hence approximate the correct "juggle" to be made in terms of C and L necessary to make the reactive component equal zero. This is somewhat laborious, however, and only gives approximate results for practical antennas. Better, we can make our corrections experimentally by measuring conditions in our transmission line and in the radiator itself. The transmission line is the most logical point of attack for this check and, as a matter of fact, the antenna readings may be neglected with little thought as to error.

Conditions of current distribution and balance in transmission lines form a reliable and easily obtainable indication of the correct termination thereof. Therefore all we need to do is provide a means (meter) for indicating the magnitude of I throughout our transmission line. A r.f. current meter, with suitable shunt for the power used, is the most practical device.² The shunt may be a portion of the transmission-line conductor. But

²The "trolley-type" measuring method described by Redgrave in Nov. 1934 *QST* is suggested.

we must be sure that the shunt value remains constant throughout the whole series of measurements. Our process of "juggling" resolves itself

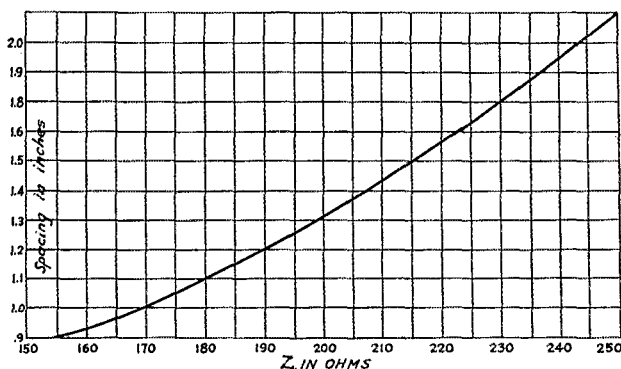

FIG. 3—SPACING VS. CHARACTERISTIC IMPEDANCE FOR DESIGN OF QUARTER-WAVE MATCHING SECTIONS USING 1/2-INCH DIAMETER TUBING

into experimentally shortening and lengthening the radiator (when it is in its operating position and with the transmitter frequency constant) until the current distribution throughout the line is uniform and the magnitudes in each conductor are equal. It is a practicability for most any location to reduce standing waves to negligibility and to realize current balances of within 2%. These conditions give rise to very little reflection loss and the whole system operates well. If the radiator is excited from any point other than at one end (Zepp feed), the alterations must be made simultaneously at opposite ends, keeping in mind that additions or subtractions should be made proportionately to the length either side of the point of connection with the transmission line. In other words, we maintain the electrical symmetry of the radiator. It will be found that perfect physical symmetry in certain radiators which may be tilted, or influenced more greatly at one end than the other by surrounding objects, is not in order. Most cases for long-wire radiators show an increase in length over what would be assumed to be correct. This is an acceptable condition and is due to the presence of Z_C ; we have added inductance to make $Z_A = Z_R$ because Z_C was of a somewhat capacitively reactive value.

Choice of the type of transmission line is a matter for the individual to decide. In general a two-conductor open-wire line is the most inexpensive and probably is more efficient than any with which we are familiar, excepting only the co-axial conductor system which will probably find manifold applications in the near future. Transposed lines are not to be considered where maximum efficiency is to be realized, except for short line-length applications. (This statement is not intended to condemn transposed lines; but their efficiencies have been shown to be generally lower

than a straight open-wire line of equivalent spacing and they offer difficulties in measurement.) Surge impedances of open wire lines may be computed and the values obtained considered correct for any placement of a relatively low-impedance line.

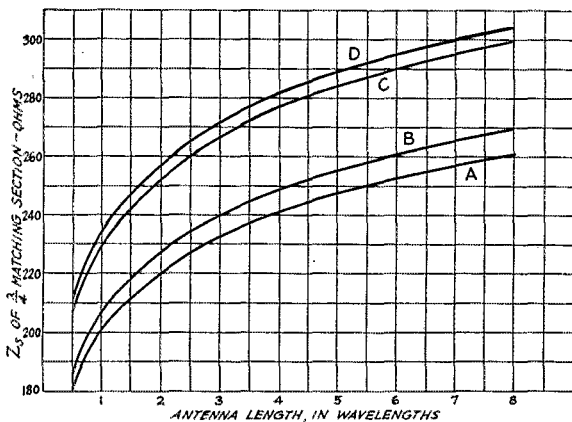

FIG. 4—SHOWING THE CORRECT SURGE IMPEDANCE OF QUARTER-WAVE MATCHING SECTIONS FOR RADIATORS OF VARIOUS LENGTHS

Curve A is for a transmission line impedance (Z_L) of 440 ohms. Curve B for 470 ohms, Curve C for 580 ohms and Curve D for 600 ohms.

For this we use the familiar relation

$$Z_S = 276 \log \frac{2S}{D}$$

where Z_S = Surge impedance of the line

S = Spacing center to center of conductors

D = Diameter of conductors

The curves of Fig. 2 show values of Z_S for No. 10, No. 12 and No. 14 wire for various recommended spacings. In open wire lines Z_S is generally limited to values between 400 and 600 ohms.

Radiator self-impedances always turn out to be somewhat lower in value than the surge impedance of any one of our practical lines. Methods of accomplishing a match have been described previously and one of those methods should be selected.³ The writers have found that the method involving the use of the large-diameter conductor quarter-wave matching section⁴ gives excellent performance for any antenna configuration. Theoretical considerations bear out the fact that it approaches the ideal. Its application will doubtless be limited to the higher order of frequencies (7 and 14 mc.), because of size and weight considerations, but its use is more than justified in terms of results.

³ Matching methods previously described are summarized with references in the article, "Getting Cooperation in the Antenna System," by W. J. Goodell, Feb. 1935 *QST*.

⁴ Johnson and Glover, "A Practical Transmission-Line System for the Doublet Antenna," *QST*, Jan. 1934.

The equation

$$Z_S = \sqrt{Z_L Z_0} \quad (6)$$

expresses the relation of the surge impedance (Z_S) of the quarter-wave section to the values appearing at its terminals (Z_L and Z_0). This transformation is accomplished by utilizing the properties of a quarter-wave tuned (resonant) line. (There is a standing wave on it.) It may be observed that all quantities involved may be calculated for a given situation. In actual practice the only factor in the entire system which may have to be altered from the computed value is the radiator length, experiments indicating that a change of 10 percent in length of the quarter-wave matching section has little effect on the entire system. This may be explained satisfactorily by several lines of reasoning which will not be included here.

To facilitate design, curves have been drawn which show actual values as to impedances, spacings and the relations existing between feeder line, matching section and antenna in various combinations. Fig. 2 shows the relation of spacing to Z_L in open wire feeder lines for No. 10, No. 12 and No. 14 B & S gauge wire. Fig. 3 shows the spacing versus Z_S for quarter-wave matching sections. Fig. 4 shows relation of Z_S of matching section to antenna length for four different practical lines. The reader will doubtless find use for them.

A PRACTICAL EXAMPLE

Suppose we decide to erect a two-wavelength antenna for the single frequency of $f = 14.2$ mc. and we want to excite it using a quarter-wave matching section. Its approximate length per half-wave by computation is 33 feet, using $468/f_{mc} = \text{length in feet}$.⁵ Multiplying 33 feet by 4, the approximate total length is 132 feet, since we have four half-waves. When cutting the wire remember that corrections in length probably will have to be made so we had better allow about 6 feet additional for alterations. Loop the excess wire through the terminal insulators and twist around the conductor so that none hangs free.

Now for locating the antenna. Considering the advantage of long-wire radiators with respect to power ratio, as shown by Curve B of Fig. 1, attention should be directed next to the resulting directive pattern. We would not want to erect a beautiful long antenna that had considerable time and effort expended in its construction, only to find afterwards that our radiation lobes were aimed to some iceberg up in the Arctic Circle and

⁵ This gives an approximate length based on average data for typical antennas. See *The Radio Amateur's Handbook*, Chapter Twelve.

down toward the south-east Atlantic Ocean where only a few scattered pieces of drift-wood are to be found. The chart shown in Fig. 5 will at a glance give the information we desire for radiators as long as 8 wavelengths.⁶ The angles of maximum lobes are shown for one quadrant of the horizontal plane but correspond for the other 3 quadrants. They also hold approximately in the vertical plane for wires a half-wave (35 feet or so at 14 mc.) above ground. Remember that the longer the wire, the lower the angle of radiation. This condition is to be desired where we want the most miles per watt on the higher frequencies, as most of us know.

If it is desired to concentrate the signal into some particular location, or several of them, we should first of all determine the direction of the path to this remote point *via* the great circle route—which is not as it would appear on the ordinary map. The best and easiest way to do this, without resorting to spherical trig, is to use a globe. Our directions can be determined readily by stretching a piece of string between the transmitting location and the receiving points, and observing the angle between the string and the latitude or longitudinal line which it crosses. This being done, we should next find our local true north bearing, from which the others can be located.

Right here it should be emphasized that care should be exercised in figuring directions. It must be emphasized that great circle paths differ considerably from directions as they appear from the ordinary map. For instance, those of us in and near New York City (or Washington, D. C.) who put up horizontal doublet antennas lining up north-south and having 90° lobes pointing east-west would find our signal maximum in southern California for the west, and in the northern part of Africa for the east. In the above-mentioned locations, transmitting to hit central Europe we should aim one lobe of our pattern approximately 50° north of east, thus putting our western maximum about 40° south of west. This matter of signal paths should be carefully considered when planning any directional system, because otherwise large errors in angle at the transmitting location may result and impair results considerably at the receiving end, especially where continent-to-continent communication is contemplated.

THE FEEDER SYSTEM

Assume we have No. 10 wire spaced 2 inches center-to-center in our line running up from the transmitter. Curve of Fig. 2 shows the surge impedance of such a line to be 440 ohms. Since we are using a radiator of two-wave length, we look at curve A of Fig. 4 and see that the Z_S of our quarter wave-length matching section should be 220 ohms. From this value, using the curve of

⁶ See also Figs. 9 to 13, inclusive, of the article referred to in footnote 3.

Fig. 3, we find the center-to-center spacing of the $\frac{1}{2}$ -inch tubing must be $1.56''$ ($1\frac{9}{16}''$).

The next step is to put everything in place and prepare to measure current conditions in the line, the quarter-wave matching section being attached to the radiator at any one of the current antinodes; that is, at a point an odd multiple of a quarter-wavelength from one end.

Preliminary readings may be taken at 2 points one-fourth wavelength (16.5 feet) apart along the line and final readings should be made at several additional locations. The relative values of current should be observed in each conductor at points equally distant from the transmitter to de-

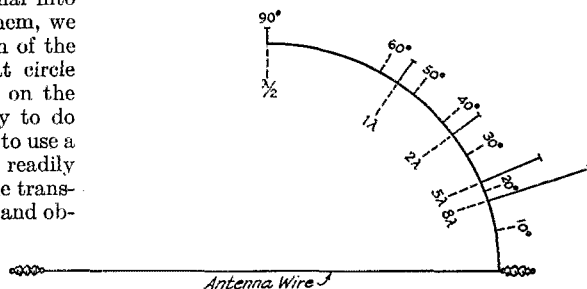

FIG. 5—THIS CHART GIVES THE ANGLES OF MAXIMUM RADIATION, MEASURED FROM THE LINE OF THE ANTENNA, FOR ANTENNAS OF DIFFERENT LENGTHS IN TERMS OF THE OPERATING WAVELENGTH

The angles are shown for one quadrant but correspond for the other three. The relative lengths of the extended solid lines indicating the angles of maximum lobes show power ratios compared with the maximum for a half-wave doublet (90°).

termine possible unbalances. Differences will doubtless exist from point to point on a given conductor indicating standing waves. An unbalance in line current will indicate qualitatively whether the radiator electrical lengths either side of the matching section are correctly proportioned. If no unbalance is in evidence, the additions and subtractions performed on the radiator should be made in the same ratio as the number of quarter-wave lengths either side of said matching section until there are no standing waves. Some experimentation will indicate which way the lengthening and shortening processes must be carried on. After several changes the length of radiator will be found which will satisfy the condition of correct current distribution in the line, which condition indicates a nearly perfect match at the radiator. Variations in corrected length of radiator from the calculated value are to be expected. Also, conditions of physical asymmetry are common. These are results of the several factors discussed previously.

Having considered only the horizontal radiation pattern in connection with directivity, let us now consider how we may better the signal still more in some particular direction. If we tilt our

antenna, the lower end being toward the desired direction, we can lower our angle of effective radiation further and in most cases find an angle in the vertical plane which will provide a much better signal for that one direction. This should be done very carefully, preferably while an observer is checking the signal at some remote point in the desired direction. Remember here that changing the antenna height will again introduce slight changes in the antenna self impedance. This should be checked finally for maximum results.

Such manipulations of patterns and angles of radiation suggests further investigation of antenna height, use of reflectors, and other variations on which many interesting papers have been published. The writers wish to acknowledge with appreciation material obtained from the footnote

references previously cited and the additional references below:

- McLean, "Transmission-Line Feed," *QST*, Oct. 1932.
- Sanders, "Practice vs. Theory In Antenna Performance," *QST*, Dec. 1934. (Describes distorting effect of metal masts.)
- Hardin, "Matched-Impedance Coupling to the Zepp," *QST*, Feb. 1935.
- Roostenstein, "Conduction of High-Frequency Oscillatory Energy," *Proc. I.R.E.*, Oct. 1931.
- Sterba and Feldman, "Transmission Lines for Short-Wave Radio Systems," *Proc. I.R.E.*, July 1932.
- A. Hund, *High-Frequency Measurements* (McGraw-Hill).
- W. Everett, *Communication Engineering* (McGraw-Hill).

Jim

A Tug at Your Memory

By John C. Flippin, W4VT*

THE fire in the shack of the university radio station burned low and conversation lagged. Every now and then someone yawned lustily. The hands of the old clock pointed to five minutes after two, yet half a dozen seniors lingered, for the fire was magnetic, the walk back to the dormitory and fraternity houses long; and the night was cold. Lazy, feathery flakes, beginning to drift down at midnight, had changed to a fine, peppery mist swirling in from the north, and the wind moaned down the chimney in icy cadences.

Jug Southgate stood up and stretched.

"See you mugs in church," he grunted, looking around for his overcoat.

"Wait a minute. I will let you walk with me. Hey! get your big feet off me!"

"Freshman, where are the earmuffs?"

"Right here, sir."

"Put them on at once. Anybody would think you had no modesty at all."

"Get up! Get up!"

"Coming, Ivy?"

"Let's go."

Exiled in a shadowy corner, a group of freshmen had been listening in respectful silence. Now they rose, after a discreet interval, and removing their sky blue caps from their hip pockets placed them carefully on the backs of their heads. Beside them stood a little fellow who was busily engaged in wrapping a rather frayed scarf around

his small neck. Judging from his stature he could not have been much older than fourteen, and he looked very small and out of place beside them. The shadows from the fire treated mercifully the worn places on the elbows of the coat which was so obviously designed for a larger occupant; they shielded understandingly the worn, cracked shoes with the scuffed toes.

His name was Jim. Nobody knew much about him except that he lived up in town some where, and that every Saturday night he appeared at the shack, slipping quietly into a seat amid the shadows in the corner, and listened with rapt attention to every word that anyone uttered. He always stayed until the group of fellows broke up. Jim replied feebly and shyly to those who would talk to him, apparently embarrassed at the attention. His face and hands were very thin and his eyes were very bright. He was a small outsider looking in on a gathering with which he could join only in spirit. College would never be for Jim.

The wind whined savagely. A flurry of snow beat a faint tattoo on the window.

"Ouch!" muttered Ivy. "Listen to that!"

Jug cast his gaze around as he pulled on his gloves. The staccato clatter of the keying relay in the adjoining room reminded him to caution Parkes about playing the end of the band too closely since the multivibrator was down for revamping. Turning back, his glance rested for an instant on Jim stretching his hands out to

* 3222 Choctaw Ave., Memphis, Tenn.

give them a last warning. Something about the little fellow's appearance arrested Jug's attention. Maybe it was the tattered edge of that scarf about Jim's ears.

"What do you say over there, sport?"

Jim didn't notice.

"You over there by the fire! Got a way to get in?"

Jim looked up, and saw Jug looking at him. He straightened up quickly and thrust his hands into his coat pockets.

"Sir?"

"Got a ride into town with somebody?"

"No."

"What are you going to do—walk?"

"Yes," answered Jim.

"Pretty long way, isn't it?"

A pause.

"Not so much."

Jug embarrassed Jim a great deal, because Jug was the chief operator and wore sterling crossed bars of chain lightning on the shoulder of the navy blue jersey. There was no greater this side of Heaven, save perhaps the three comprising the transmitting staff.

Jug shoved his pipe in his mouth and turned the bowl down. He squinted up at the clock.

"Hold on, frosh!"

He pulled off his gloves and searched in his hip pocket, producing nothing but a handkerchief and a crumpled pack of cigarettes.

"Can't find 'em. Listen! You know where the Sigma House is? OK—you go over there and look around in the back. My iron ought to be there, but if it isn't, get any of them that will start. You know mine?"

"Yes, sir."

"Look around in the front seat and find you a hairpin or something and short around the switch under the dash. You know?"

"Yes, sir."

"And hurry up, frosh!"

Rather bewildered, Jim listened.

"I can get there all right," he said finally.

Jug grunted and sat down.

"Where do you live in town?"

"Er—down by the depot. The third house from the corner."

"Guess you know all the trains."

"I guess so. The freights make an awful lot of QRM when I'm trying to listen."

Jug stuffed his pipe slowly and extracted an ember from the hearth.

"You one of these amateurs, too?"

"Yes, that is—I mean, I have a station, but it's not much good, I guess."

A flicker of surprise crossed Jug's persistently unburned countenance.

"Didn't know there was another station within fifty miles of here," he admitted. "What do you use? Never heard you."

"A 201-A," answered Jim.

The rectifiers down below howled faintly.

"Any DX?" asked Jug, quizzically, glancing at the little chap out of the corner of his eye.

"No, I—you see, I never worked anybody."

"What's the trouble?"

Jim stopped the nervous movements of his small hands and wiggled his thumb, just to see if it would wiggle.

"I don't know."

"Just don't come back, eh?"

"No."

"Call many of them?"

"Yes, I—well, I call a lot of fives and nines and fours."

"Sure you're in the band?"

"Yes."

"How do you know?"

"I cover up my receiver with a cracker box and then I can hear the transmitter. After I take off my receiving aerial," he added.

Jug looked at Jim for an instant, and then gazed again into the fire. There was a pause while Jim twisted his small, thin hands nervously.

"I know it's putting out," said Jim, faintly, "because I get a burn."

"Burn, eh?"

"Yes."

"Just don't come back."

"No."

The pity of it.

"Much of a burn?"

"Well, I can feel it on the back of my finger."

Jim held up the radio frequency detector.

"How long have you been trying to raise them?"

"Since about May—I mean, April."

"Nine months."

"Yes," answered Jim, after a pause.

Jug exhaled a cloud of smoke through his nose and regarded the fire. Some game, this! Nine months and never a break.

There was a dull rattle of contactors down below, followed by a volley of clicks in the adjoining room.

"What made that?"

"Sounds like he switched in the '7'—the forty-meter rig."

"You mean he's using another set, now?"

"Just the amplifier. Switched over the exciter from the 80-meter to the 40-meter amplifier."

"Oh!"

"Sit down! Sit down! Make yourself comfortable. Guess it'll be about fifteen minutes, yet."

Jim slid cautiously into the nearest chair. Suddenly he turned and regarded Jug inquiringly.

"Would you mind—I mean, would it be all right if I looked in there?" he asked, pointing to the transmitter room.

"Sure! Go ahead. Help yourself. Wouldn't get too close, though, to the one nearest this side."

Jim opened the door cautiously and craned

his small neck. He stood transfixed for long minutes.

"Gee!" he whispered.

"Look all right?" Jug asked, pulling his pipe apart and blowing through it with two short snorts.

"Gee!" said Jim again.

Five minutes passed with only the wind, the old clock, and the keying relay breaking the silence.

Jug looked at the swirl of smoke ascending the broad black throat of the chimney, and his thoughts travelled back to a day—so long ago, it seemed—when that UV-202, its plate glowing brightly, brought the antenna ammeter to life. As he recalled, the pointer moved over about a thirty-second of an inch, but at the time, it looked like a foot!

And then that red-letter day. He had just called CQ. It was just one of many scores of CQ's. There was nothing to distinguish it from all the others except that on this occasion 9EKY in St. Louis came back. The wild shout that brought the gardener, the chauffeur, and both maids breathless to the sanctum over the garage was not, as they feared, Mr. Edward Southgate III getting a mortal shock from his peculiar conglomeration of wires and sparkling Mason fruit jars, but merely the result of Mrs. Southgate's youngest son making contact number one with his trusty bottle!

Jug looked at Jim standing in the door. The frayed scarf. The worn old overcoat hanging awkwardly from his small body.

"Know the code pretty well?" Jug asked, rising slowly, and returning the tobacco pouch to his pocket.

"Sir?"

"Can you copy pretty well?"

"Yes—well, I guess I can copy ten words a minute, I guess."

"Want to go upstairs?"

"Upstairs?"

"Want to see the operating room?"

"Oh! Yes!"

Jug led the way with Jim following at his heels. A series of coughs escaped Jim at the top of the flight, and alarm possessed him that he would disturb the operator. He tiptoed in behind Jug, his small face radiant with excited expectation.

"What say, Jug?"

"Lo, Bohunk. How goes it?"

"Fair."

"Where you working now?"

"Using 7005. Don't worry, it's inside."

"Did you check it with the oven?"

"Yes, it's right on the line."

Jim was all eyes. He looked at the Single-Signal receiver, at the typewriter, at the 100-kc. secondary frequency standard, at the steel front control panel alongside the operating desk. The shiny brass handwheel on it. The meters. All

the relays in the back. The lacing on the cable runs. Resistors standing upright in groups. Jim's excited inspection saw it all!

"Anything coming through?"

"Few. Good many VK's and ZL's. Heard J2GX a minute ago. May be pretty fair later on."

Jug rested his elbows on the operating table and said something to Collier Parkes. Jim didn't hear. Jim was busy. He was looking intently at a Kleinschmidt perforator partially disassembled, wondering what manner of thing it was.

Parkes grinned.

"Sure! Sure!"

Jug's voice dropped lower.

"No," said Collier, "I got one with K6BAZ in fifteen minutes. Plenty of time for that, though. You go ahead while I go out here and look up another pad of message blanks—or something," he added.

He disappeared, clattering down the stairs.

"Want to listen in?" Jug asked, motioning to the receiver.

Jim came over to the operating desk and looked at Jug, then looked at the receiver. A great fear came over him. It was too beautiful to get close to; the baffling controls marked "R.F. Gain," "Selectivity," "A V C" "Voice—C W," and "Crystal Filter" were formidable. It was only to be looked upon from a distance.

Jug pulled the swivel chair up with his foot.

"Sit down. Sit down."

Jim let himself down slowly and looked around at the control panel. His elbow touched the shiny handwheel, and he hastily pulled it back, and then let it slide down again. This was real. It was not a dream.

Jug tripped one of the switches up with his thumb and motioned to the knob in the center.

"Turn that one."

Jim looked up at him inquiringly and touched the knob timidly. The shadow scale above it moved slightly. How easily it turned! Encouraged, he moved it a little more. A faint hiss which had begun to evidence itself in the dynamic speaker was at that instant ripped asunder by a kaleidoscope of crisp, bell-like signals which caused the moving coil of the speaker to wiggle perceptibly. Jim looked at it quickly. The sound seemed to hit him in his stomach, like when the bass drum passed in a parade. Just listen! A procession of grunts, drones and crystal ringing notes shrilled slowly by.

"Slow! Slow! Back this way."

Jim turned the knob back. Gee! It turned so easily, just seemed to glide! Entranced, he watched the shadowy divisions and numbers slip across the sloping, ground glass window. Was this real? His elbow slid back against the handwheel inquiringly. Yes, it was real, all right.

Slowly the dial moved back toward the 7000-kc. end. The terrific honk of W6's tore through. A myriad of faint signals in between that a touch

of Jug's finger on the gain transformed into ear-splitting intensity.

"Whoa!"

A faint lisping note. Jug brought it up to a good level. It seemed to stand out on top of all the rest, miraculously. The lisp increased in intensity. It signed.

"Hear that?"

Jim nodded.

"Japanese."

Jim's heart skipped a beat.

"Go on."

The dial crept back up the scale. A terrific shot of 100-cycle r.a.c. A fluttering rattle.

"Alaskan."

A hollow ringing crystal note with a peculiar wavering undertone.

"Get this one."

It was a long, slow CQ DX. It signed.

Jim's hands were trembling.

"KA1HR. Get it?"

Jim nodded.

"Philippines."

Jim's trembling increased.

The signal faded in slowly, dying away into the background roar, returning.

Jim's heart was pounding so hard it shook him.

"Calling DX."

Thousands of miles of black, tumbling ocean intervened. Outside, the two great towers, outlined irregularly in white, rose up and up into the swirling snow; downstairs the input reactors sang monotonously in the ghastly glow of the rectifiers. The filaments of the push-pull stage in the 7-mc. amplifier imparted a dull radiance to the polished edges of the neutralizing condenser discs. All were waiting, ready to hurl the dynamite.

"AR," grunted Jug, and with his thumb tripped a breaker closing switch at Jim's side. "OK! Go after him! Use the straight key over there."

Little Jim was shaking noticeably. He reached hesitantly over the battery of Vibroplexes strewn before him and grasped the key knob. He felt paralyzed. An hour seemed to pass. Suddenly the knob gave. Awkwardly he sent "KA" and stopped.

"What was his call again? Oh, yes—er . . ."

He began to call slowly and erratically. After a little he steadied a bit, but his heart was pounding so hard he couldn't control his arm. He was trembling as with a chill.

Downstairs, the pair of 204-A's, no respectors of persons, fired skyward all the savage energy that 4400 volts could impart. At every closure of the relay, the burnished plates of the tank condenser paled fitfully in the semi-darkness.

"Give him a long buzz."

Jim heard, but couldn't obey. The strength was gone out of him. Suddenly he found himself signing. He signed twice. K.

"Boy, you sure must believe in this signal all right," grunted Jug, tripping the breaker release.

For an instant only the background roar. Then the wavering drone started up.

Calling them.

"Well, what do you say now?" muttered Jug, glancing quizzically at Jim.

He didn't answer for a moment. Two large drops deposited themselves suddenly upon the log.

A faint sob came from the little fellow.

"I worked somebody," whispered little Jim.

Midwest Division Convention

April 26th-27th at Des Moines, Iowa

THE Hotel Savery is the place, and the Des Moines Radio Amateurs Association is sponsoring this convention. Frank J. Sadilek, chairman, promises the biggest program ever given in any previous convention. Big-Shot Program Headliners; Prizes—Exhibits—Tours; R. I. Exams and a Banquet de Luxe. The war cry is: Make your plans now! Make your plans now! And let the chairman at 4600 University Ave., Des Moines, Iowa, know that you will be there.

New England Division Convention

April 26th-27th at Worcester, Mass.

THE motto of the Central Massachusetts Radio Association for this year's convention is: "Hook up with me at Worcester—April 26th and 27th." Those are the dates and the convention committee would like to see you early at the Hotel Bancroft, Friday morning. Rain or shine it will be fair weather at the hotel and the committee is looking forward to greeting the New England hams with the assurance that you will not regret your attendance. Special hotel rates and special train fares. Registration: Ladies, \$2.50; hams, \$3.50. For further information and advance registration write: D. S. Bennett, Chairman, 1 Germain St., Worcester, Mass.

Dakota Division Convention

May 3rd-4th-5th at Minneapolis, Minn.

ANNOUNCEMENT! Announcement! Prepare yourselves, hams, for the big trek toward the West Hotel, Minneapolis, Minn., on the above dates and receive the cordial greetings of the members of the Minneapolis Radio Club and the St. Paul Radio Club, the sponsors of this convention. A program that will be of interest to all is being arranged with care to distribute technical talks, adventures of operators, the future of ham radio and Army and Navy meetings. The price is \$2.25 per person, and a word to Rex Munger, General Chairman, 2484 University Ave., St. Paul, Minn., that you will attend will be appreciated.

A Modernized "Modern" Transmitter

A Popular Low-Power 1929 Model Brought up to 1935 Standards in Design and Output

By Herbert M. Walleze,* W8BQ

BACK in 1929 W8BQ was awarded fourth prize in the world-wide station description contest, said prize turning out to be ten bucks. Since it had cost me twenty for the batch of photos taken to enter the contest, after some deep and lengthly calculating the prize winning station was sold in order to lift the collateral the bank held on the 20 they so kindly loaned for the job. But being off the air resulted in symptoms of nostalgia, so a rebuilding was in order—and a lot of fun was had by all.

Two fellows named Lamb and Dudley came out in September 1929 *QST* with what they called an "Effective Low Cost 'Phone and C.W. Transmitter of Modern Design," which looked FB to me. But I was to learn later that they were all wrong! Five years of operation with the rig slightly modified proves this. In the first place, the design was ultra-modern; in the second, "effective" did not begin to describe its effectiveness. And the cost,—well if any ham cannot duplicate it to-day, modernized and all, for one third the 1929 \$150 estimate, and have an up and going rig—he should lose his ticket!

LOOKING IT OVER

The circuit diagram of the complete rig is given in Fig. 1 and the photos show how it is put together. Don't let the pictures scare you. Anyone with a little gumption can better it. The frame is inch-and-a-quarter oak stock, 63 inches high by 22 wide and 20 deep. The panel is of 3/56-inch dural, 48 by 22 inches. The YF refused permission to use the tub for the purpose of giving the panel a lye solution bath, necessary to give the desired satin finish, unless I got in with it; so sandpaper and steel wool were resorted to. *But don't ever try it!!* It's a gosh-awful flock of manual labor and grief. Let it shine. The panel, after the labor, was given a coat of clear

* 77 Washington Ave., West Hazelton, Pa.

Valspar varnish, both sides, and may be washed with soap and water to remove dirt that is bound to collect in time.

In sawing holes in the thing, trying to decide where to put the one Weston I had, the thing got shot full of so many holes that the only thing to do was plug 'em up—with more meters. The top one is the antenna ammeter; center below, the final-stage input meter; next three in line, left to right, oscillator plate input, oscillator tank r.f. and buffer input meters. The three lower, left to right, are the d.c. high-voltage, filament voltage and the d.c. grid meter which may be switched to the voice equipment for measurements there.

The knob below the antenna ammeter controls *C* of the antenna network. Collins should not have held out on us so long! I didn't figure on that one in the original layout. Going on down the panel, the large dial, upper left, is on *C*₁; that on the right, on the final tanks, *C*₂. The small knob below *M* is for the neutralizing condensers on one shaft. Just below it is a pilot lamp. The three National dials in line are, left to right, for the crystal selector switch, oscillator tank condenser, *C*₄, and the buffer tank, *C*₃.

The lower-left knob is on the plate transformer primary rheostat. The next key switch is *Sw*₃, to change *M*₅ to either plate supply. The center switch is in the main a.c. line, while the next key switch is *Sw*₁ or *M*₆, to change to either the 7.5- or 2.5-volt filament supply. The small switch just above the main line switch is the test switch across the keying relay.

The whole transmitter frame is mounted on ball type rollers for easy moving.

THE INNER WORKS

Now if you will kindly step around to the rear—or wait, I'll swing it around. One second—there is the works. Up at the top, mounted over the antenna ammeter, is the antenna net coil *L*. That top sub-base is 21 by 9 by

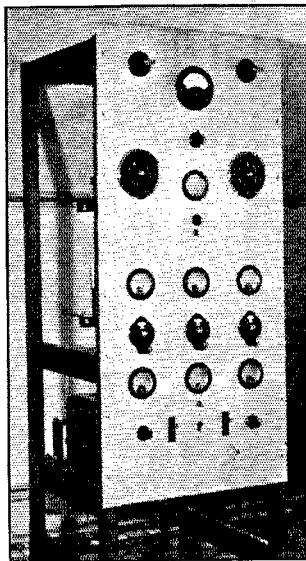

"DON'T LET THE PICTURES SCARE YOU"

"—Trying to decide where to put the one Weston I had, the thing got shot full of so many holes that the only thing to do was plug 'em up—with more meters!"

Just how it's built is described in detail in the text.

$\frac{1}{4}$ -inch bakelite. The upper side has the two Cardwells, C_1 and C_2 , mounted thereon, along with the sockets for the tubes, the plate and grid r.f. chokes and the plug-in tank coil. That Cardwell mounted directly on the panel? That is C for the antenna net. Now the under side of the top sub-base supports the neutralizing condensers, parasitic chokes and by-pass condensers. All of the condensers, you see, are driven by the dials or knobs with insulated couplings, since the panel is at ground potential.

The next sub-base below is a duplicate of the upper one. Over here on the right is a socket and a plug-in coil, L_5 , which is the cathode inductance in the Tri-tet. The original 27's that the boys specified were used in the oscillator (push-pull) until that 59 found its way in there to replace them. While the 27 circuit did an excellent job, I couldn't double frequency in it, nor in the p.p. buffer stage. Next are the two plug-in crystal holders. Yes, I made 'em out of hard rubber. They come apart easily, are dust proof and have a thick

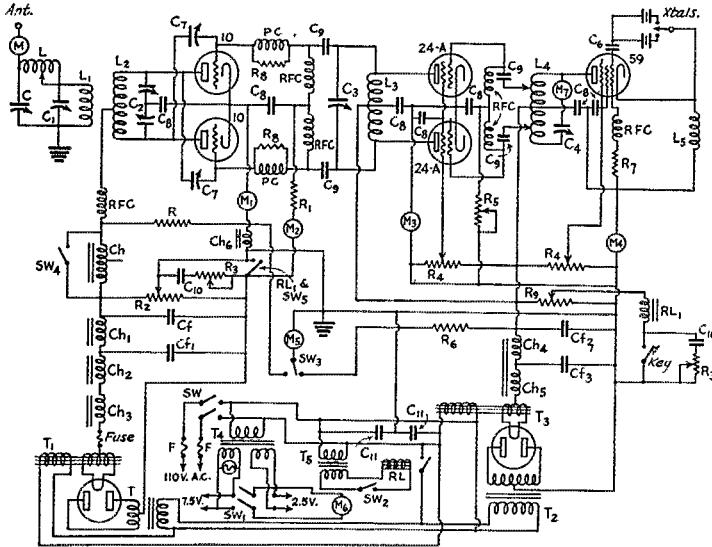

FIG. 1—COMPLETE CIRCUIT OF THE TRANSMITTER

- L—Antenna network coil. (See Coil Data for specifications of all coils.)
 L₁—Coupling coil.
 L₂—Finial tank coil.
 L₃—Buffer tank coil.
 L₄—Oscillator tank coil.
 L₅—Oscillator cathode coil.
 C, C₁—500- μ fd. antenna coupling net tuning condensers (Cardwell).
 C₂—300- μ fd. final tank condenser (Cardwell split-stator).
 C₃, C₄—100- μ fd. midget (Pilot).
 C₅, C₆—0.006- μ fd. 5000-volt (Sangamo).
 C₇—25- μ fd. double-spaced neutralizing condenser (originally 100- μ fd. Pilot).
 C₈—0.002- μ fd. 5000-volt (Sangamo).
 C₉—100- μ fd. 5000-volt (Sangamo).
 C₁₀—1- μ fd. 500-volt paper (key spark absorber).
 C₁₁—0.1- μ fd. 500-v. line filter condenser.
 C₁—10- μ fd. 2000-v. filter. (May be 4- μ fd. for c.w. operation.)
 C₁₁—2- μ fd. 2000-v. filter condenser.
 C₉—10- μ fd. 500-v.
 C₁₃—4- μ fd. 500-v.
 Ch—60-h. 200-ma. tapped modulation reactor.
 Ch₁₋₃—5-h. 250-ma. filter chokes.
 Ch₄—1/10-h. 500-ma. filter input choke.
 Ch₄₋₅—15-h. 250-ma. filter chokes.
 Ch₆—1-h. 250-ma. key-filter choke.
 Fuse—250 ma.
 T₁—50-v. a. h.v. transformer, provided with primary rheostat not shown (Acme).
 T₁—5-v. 10-amp. rectifier filament transformer (home-made).
 T₂—375-v. 250-ma. h.v. transformer (Amertran).
 T₃—5-v. 5-amp. rectifier fil. trans. (home-made).
 T₄—7.5- and 2.5-volt 20-amp. fil. trans., with primary rheo. not shown (home-made).
 T₅—50-v. trans. to operate relay RL.

- R—1000-v. meter multiplier.
 R₁—10,000-ohm 75-w. final bias res.
 R₂—100,000-ohm 200-w. bleeder and voltage divider for keying.
 R₃—1000-ohm pot (key-spark absorber).
 R₄—25,000-ohm voltage divider and bleeder.
 R₅—50,000-ohm variable grid bias res. for buffer.
 R₆—500-ohm. meter multiplier.
 R₇—25,000-ohm 5-w. non-inductive grid-bias res. for oscillator.
 R₈—100-ohm 5-w. non-inductive.
 R₉—50,000-ohm 50-watt voltage divider for operating keying relay I.
 P₀—12 turns, No. 16 wire $\frac{1}{8}$ -inch larger and mounted around R₈, making up low- and high-freq. parasitic chokes.
 RFC—Usual pie-wound r.f. chokes.
 SW—Main a.c. line switch.
 SW₁—Key switch on M₆ (to read either 7.5-v. or 2.5-v.).
 SW₂—Key switch for starting.
 SW₃—Key switch on M₅ (to read 500 or 1000 v. d.c.).
 SW₄—S.p.s.t. switch to shut modulation reactor for c.w. work.
 SW₅—Test switch on transmitter panel (shunts keying relay contacts).
 M—0-1.5 amp. r.f. meter (Weston Model 401).
 M₁—0-250-ma. d.c., final input (Weston Model 301).
 M₂—0-50-ma. d.c., final grid (Weston Model 301).
 M₃—0-50-ma. d.c., buffer input (Weston Model 301).
 M₄—0-50-ma. d.c., osc. input (Weston Model 301).
 M₅—0-500 and 0-1000-v. d.c. (Weston Model 301).
 M₆—0-3 v. and 0-9 v. a.c. (Weston Model 476).
 M₇—0-1 amp. r.f., osc. tank (Weston Model 425).
 RL—110-v. a.c. starting relay, rewound to operate on 50-v. a.c. (General Electric).
 RL₁—Pony keying relay rewound to operate on 1 ma. off osc. plate supply. Coils stripped and random wound full with No. 38 s.c.c.

lower electrode to help maintain a more even crystal temperature. Then there is the 59 Tri-tet tube. I run it at 350 volts on the plate with 25 mils. The plug-in tank coil is next. Yes, it's enameled wire on 2 $\frac{3}{4}$ -inch long by 2-inch diameter bakelite tubing, $\frac{1}{16}$ -inch wall. I grooved them up on the lathe, stretched the wire and wound it on under tension—and it stays put. Those G.R. plugs and jacks can't be beat for smooth and positive action in changing coils.

Wait a minute! Ask questions after. You will get me all balled up.

Yes, the next two tubes are the buffers. Just 24's push-pull; and boy, do they buff! What's more, they turn out a flock of r.f. volts to hustle the final and they are dead easy to drive. 46's? Lord no! These 24's cost less, don't have to be neutralized, only require around 5 or so r.f. volts to fully excite, and have a gain of something like 50. The plate current, you'll notice, is around 45 mils for the pair at the same 350 volts as on the 59. And you don't see the plate current trying to climb out and up that 65 footer in the yard when they are doing business. Those two are over three years old, so they can take it.

Getting back to the case of exciting them, that means the buffer "feed" taps can be run way down toward the "low" section of the oscillator tank, which it just loves. Unorthodox? Well, I do it, and no unholy actions result. Furthermore, the way that Tri-tet shoves out harmonics, you can easily swing the 24's on a couple of harmonics "down" and have a good time. I now double frequency in the oscillator all of the time. That makes for high stability without real need for temperature control, other than the simple heavy-electrode method previously mentioned and a huskier rock to guard against puncture. Using some of the new AT cuts the frequency stability is exceptionally satisfactory, although these X cuts hold very nicely, especially so when doubling.

One thing I want to mention, before we go further, is these three knobs along the rear edge of this shelf. They control the two potentiometers

R_4 , and the variable bias resistor, R_5 . I have found it absolutely necessary to use this method of obtaining screen and bias voltages for the 24's, and the screen voltage of the 59, to get the most

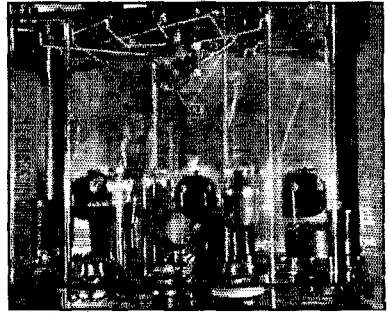

"OVER HERE ON THE RIGHT IS THE CATHODE INDUCTANCE OF THE TRI-TET"

Then there is the 59. . . . Yes, the next two tubes are buffers. Just 24's push-pull; and boy, do they buff!

out of them with safety. Series dropping resistors are the "bunque." Notice that the adjustment is critical. A quarter-inch movement on these potentiometers R_4 , from where they now set, will greatly reduce the efficiency. By all means use them and adjust them carefully for the best results.

No cathode tuning condenser? Well, yes, Jim Lamb says you should tune that Tri-tet cathode coil; but I fooled around with it a lot and think these coils, which I adjusted to fit each

crystal, work OK. You see I couldn't figure out where to mount the needed condenser without messing up the panel any more, so resorted to this. Maybe you had better use one in your rig, though.

The buffer tank coil is the one on the left and is now mounted vertical, 8 inches from the oscillator tank inductance. This eliminated a slight reaction between the oscillator and buffer which was experienced with the original layout where both the oscillator tank and the buffer tank were

COIL DATA

L—35 t. No. 16 enam., 2" dia., spaced 8 t. per inch. Tapped every 5 t.

L₁— $\frac{1}{2}$ total number of total tank turns, in each case, spaced 5 turns per inch and mounted inside L₂, in center. Dia. as large as possible, in this case, so as to give very close coupling. May be wound over top of tank winding, if more convenient, but provide insulation for twice d.c. plate voltage. Required only for p.p. final feeding an end-fed antenna.

Band, Mc.	L ₂ PA *	L ₃₋₄ Buffer and Osc. Tank **	L ₅ Cathode ***
1.7	24 t 6" dia.	48 t. No. 24, 24 t per inch	None
3.5	12 t 5" dia.	24 t. No. 20, 12 t " "	63 t. No. 28
7.0	12 t 3" dia.	12 t. No. 18, 6 t " "	28 t. No. 28
14.0	6 t 3" dia.	8 t. No. 18, 4 t " "	10 t. No. 28

* Windings are all 5" long. The 1.7-mc. ind. here is an old Benwood, 3.5 and 7 mc. being R.E.L. 14-mc. coil home-made of No. 8 aluminum wire.

** All 2" long.

*** All 1 $\frac{1}{2}$ " dia., close wound. The cathode coils specified are for frequency doubling in the oscillator. These coils should be adjusted, a turn at a time, to fit crystal used, unless condenser tuning is used. For fundamental crystal operation use coil form with jumper to short cathode coil socket.

All buffer taps directly off each end. Osc. taps as follows: 1.7-mc., 8 turns each side center; 3.5-mc., 4 turns each side; 7-mc., 3 turns each side; 14-mc. direct off each end.

mounted alike. Under the sub-base is all wiring and equipment associated with these two stages.

Now these upright bars, running between these two sub-bases, have a two-fold purpose. They escort the leads for the high-voltage d.c., the filament a.c., the bias, the two on the left carrying leads for r.f. from the buffer to the final. They are nickel-plated brass and, besides eliminating a mess of haywire, they also stiffen up the sub-bases plenty. I would not be afraid to stand on them. This makes for solid construction.

That brings us down to the power supply end. The black metal can toward you contains the rectifier tube and its heating transformer; the keying relay and filter; three filter chokes and first filter condenser, the bleeder resistor and voltage divider for keying. It is easily removed if necessary. All of the above are for the final stage only. The plate transformer for this supply and the filament transformer for the r.f. tubes are mounted between this can and the panel. The old bakelite can on the right contains the entire 350-volt power equipment. All the forementioned are mounted on a one-inch oak sub-base 22×17 inches. The large filter condensers, C_f , and the line fuses and filter, are mounted on the under side. All power wiring is under, also. The panel you see on the rear supports the starting relays and terminations. A ten-pair telephone cable runs to the receiving position for control, a Federal key switch, mounted on the receiver panel, being used for starting and also for cutting the monitor in or out.

GETTING INTO ACTION

Once assembly is completed and all wiring carefully checked, we test the various voltages to all points, then insert the tubes and close the main a.c. line switch. This will throw on all filament voltages. It is necessary to keep the filaments heated during intermittent operation, since the oscillator and buffer are of the heater type. As for the rectifiers, it is very desirable to keep them heated also. And since I run my tens at *slightly* above rating, it pays to keep them fired up too. Any filament will have greater life if kept heated, instead of turning it on and off each transmission.

Once you have allowed the filaments to come up to their proper temperature, having checked and correctly adjusted their voltages to rating,

close the starting relay, making sure that the key and the test switch are open. On the initial trial, it would be a good idea to remove the buffer tank coil first, until a check shows the oscillator to be singing on its correct frequency. The resistor R_4 should have been set approximately midway. Tune the oscillator plate tank rapidly until the plate current takes the dip toward minimum. If the crystal is OK, the plate current will be

between 20 and 30 ma. Now *carefully* adjust the potentiometer in the screen-grid circuit of the '59. A point will be found where the tank r.f. current reaches maximum with a reasonable plate current. In my set-up the tank current is about 0.7 amps with 25 ma. plate current. Turning the potentiometer arm too far toward the positive end results in high plate current, lower tank current and funny light effects inside the 59. All of which indicates that the screen voltage is too high. Lowering it too much results in low plate and tank current, and less r.f. output. Now the monitor should turn out the *finest* kind of "XPDC" signal. Granting that you have not skimped too badly on the filter (which there is no excuse for), this will be the case. Barring either wholly or partly defective parts, there isn't any other reason, that I know of, why a perfect note should not be generated.

Now let's plug in the proper buffer tank coil. Hand me that flash lamp with the loop on it. Wow! This buffer plate meter is full scale! And tuning the tank doesn't seem to help. Dump that starting switch off quick! There.

Let's adjust this variable grid leak, R_5 , to about maximum resistance. Check that potentiometer in the screen-grid circuit. Set at mid-point? OK, start her up again. Well, well, now the plate current is down to about 30 or 40 mils. Let's tune the tank. Now at resonance? OK. Hey! That flash lamp wasn't a 60-watter! Here, put this one in and don't stick it so close this time. There—that's bright enough. Retune the oscillator tank slightly. That's it. Now wait 'till I adjust the screen and bias voltages. The bias isn't so critical but watch this screen voltage change things. Back up that lamp! So—lots of light and around 40 to 35 mils on the plate. Let's see what the monitor says now: Fine! More push, but the note has not changed in the slightest. Once I put a new tube in and it

(Continued on page 92)



"NOW IF YOU WILL KINDLY STEP AROUND TO THE REAR—"

More Effective Link Coupling for R.F. Power Amplifiers

An Early Type Proves Superior to the Present Popular Version

By Robert T. Foreman,* W9QT

MANY excellent articles have appeared in *QST* from time to time which thoroughly cover the operation of radio-frequency amplifiers when used in the final stage. The data by H. A. Robinson¹ enable any amateur to determine the optimum operating conditions for a final amplifier; adjustment of load impedance is simply a matter of properly coupling the antenna.

When an effort is made to secure optimum adjustments on an exciting stage, however, the problem is more difficult. The writer was recently confronted with the necessity of coupling a Type 10 driver to a Type 60 amplifier, the latter in turn being coupled to a water-cooled screen-grid final amplifier. Capacity coupling was used, with a variable tap on the plate coil of the 10, but the 10 driver refused to swing the grid of the 60; plate input to the 10 remained very low and the grid current of the 60 was too small for satisfactory operation. Then when the 60 was coupled to the water-cooled tube in the same manner, the result was almost disastrous. The 60 behaved almost as if its plate had been grounded—high plate current, low output, and no grid swing on the final amplifier.

After consulting past issues of *QST*, a scheme was found which looked good.² Transformer coupling was employed, using a grid coil of small diameter and many turns, inserted in center of the 10 plate coil. Considerable improvement resulted; there was enough step-up in the transformer to increase the grid swing on the 60, although the 10 was still very lightly loaded. Transformer coupling between 60 and final amplifier proved to be no better than straight capacity coupling, but a new problem arose. The increased output of the 60 showed that considerable r.f. current was leaking through the choke when capacity coupling was used to feed the final amplifier grid. More than a dozen chokes—pie-wound, single layer, multi-section, resonant and non-resonant—were tried with equal lack of success.

LINK COUPLING

It seemed obvious that the input impedance of the final amplifier was too low to offer a decent load to the plate of the 60. It was, therefore, de-

ecided to try simple link coupling,³ since some were praising its value and claiming it effected an automatic impedance match. Single-turn and multi-turn links were tried, but the supposed automatic impedance match failed to appear; and a little reflection proved the absurdity of *expecting* it to appear. Probably if the impedances are not too widely different, a fair match can be secured by moving the link coil up or down the

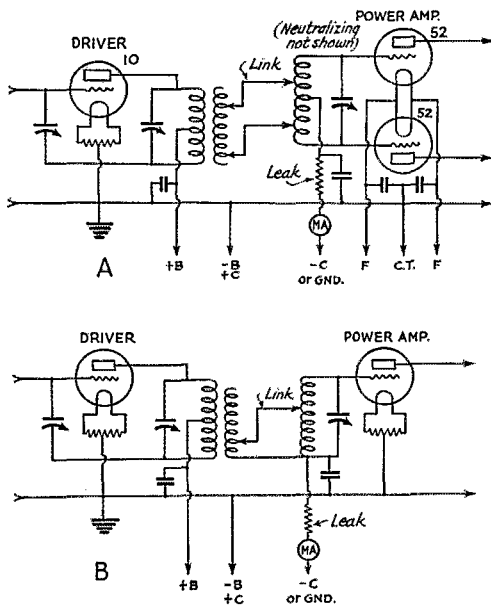

FIG. 1.—THE LINK CIRCUIT AS USED IN THE APRIL 1929 *QST* 'PHONE TRANSMITTER IS SHOWN IN A.

The same arrangement adapted to a single-ended power amplifier is shown in B.

plate coil; but such crude adjustment was not adequate in this case.

Returning to the search of past issues of *QST*, the solution was finally found on page 15 of the April 1929 issue. There, six years ago, was the daddy of later interstage link coupling—at least

Treated a number of times previously in *QST*—"Experimenters' Section," May and June 1933; and discussed in detail by George Grammer in the article, "Improving the Performance of the Neutralized Power Amplifier," January 1934 issue.—EDITOR.

* 1049 Montague Road, Covington, Ky.
¹ Page 25, February 1934 *QST*; and page 14, April 1934 *QST*.

² Page 9, March 1930 *QST*.

so far as amateur radio is concerned.⁴ In that article, the output of a modulated 10 amplifier is inductively coupled to an "antenna" coil; the latter is tapped by two feed lines, which terminate in taps on a tuned grid coil supplying excitation to a pair of 52's used as linear amplifiers.

This scheme is shown at A of Fig. 1, while its

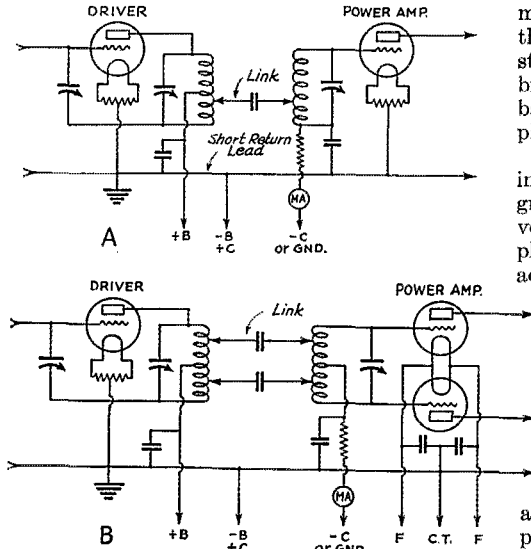

FIG. 2—THE SIMPLIFIED VERSION FINALLY ADOPTED EMPLOYS AUTO-TRANSFORMER COUPLING AT BOTH ENDS OF THE LINK, THE ARRANGEMENT FOR A SINGLE-ENDED POWER AMPLIFIER BEING SHOWN IN A AND FOR A PUSH-PULL STAGE IN B

The blocking condensers in the link circuit are of 0.001- to 0.002- μ fd. capacitance, having a voltage rating adequate for the driver plate voltage plus the p.a. grid-bias voltage. By-pass condensers are also 0.001- to 0.002- μ fd., with voltage ratings proper for their positions in the circuit.

application to a single-ended stage is shown at B. Things began to happen when it was used; plate input to the 60 dropped to a fraction of its former value, while grid-current on the final stage (the only means available for determining grid-swing) jumped enormously.

A process of cut-and-try was then begun to determine the optimum adjustment. During the process it became apparent that the plate coil itself could be used as one end of the link instead of a coil inductively coupled to the plate coil, and the circuit of Fig. 2A emerged as the final form.

No claim for novelty is made for this method of coupling; it applies well-known principles and is almost as simple as straight capacity coupling. The grid coil can be of small wire, on a small form,

⁴ The link circuit as such is even older than that. It was described for antenna systems some ten years ago in *QST* and, according to Robert W. Marriott, under that very name was a favorite device with the late Harry Shoemaker back in 1910.—EDITOR.

and tuned by a single-spaced condenser. A grid swing of 455 volts will put 550 watts into a Type 04-A, and a grid swing of 455 volts will put 1050 watts into a Type 61, according to Robinson's data.¹ Hence, no elaborate equipment is necessary; the grid tuning capacity must be kept as low as possible, anyway, and no large circulating current is present. The blocking condenser must, of course, withstand the plate voltage of the exciting stage plus the grid bias of the driven stage, just as in straight capacity coupling. Grid bias may be obtained in any desired manner, from batteries, series grid resistor, resistor in negative plate lead, or any combination of these methods.

Examining the circuit, it is easy to see that moving the tap "down" on the plate tank (toward ground, that is) causes less of the available voltage to be developed in the link-turns of both plate and grid coils. When making preliminary adjustments, it is easy to set the grid-coil tap at a fixed point (about $\frac{1}{4}$ "up" from the ground end) and then adjust the tap on the plate coil. For a fixed tap on the grid coil, moving the plate-coil tap toward ground will cause the link-coupling to reflect a higher impedance on the exciting stage, and the plate current on the exciting stage will fall. Conversely, moving the plate-coil tap toward plate will cause the link coupling to reflect a lower impedance on the exciting stage, and the plate current on the exciting stage will rise. But whether the grid-swing on the driven stage will increase with this rise in plate input to the exciting stage depends entirely on the impedances involved.

It is essential to understand this point, as was discovered when rebuilding a 10 doubler stage at this station. The 10 was doubling from 7020 to 14,040 kc., and was drawing too much current, with consequent overheating; while the grid-swing on the next stage (also a 10, straight amplifier on 14,040 kc.) was too low. In order to reduce heating of the doubler stage, the grid-coil tap was moved "up" from ground, leaving the plate tap fixed (about 1 turn up from the ground). The result was gratifying; plate input to the doubler dropped to one-half its previous value, while grid-swing on the '10 amplifier was quadrupled!

It will be observed that if the plate-coil tap is moved up to the plate end, and the grid-coil tap is moved up to the grid end, the system becomes a straight capacity-coupled affair with a resonant grid-tank substituting for the usual grid choke. But the fairly sharp tuning of the grid coil offers the tremendous advantage of keeping the r.f. where it belongs; a perfect—or even a good—choke has yet to appear in this station.

The results obtained in the 60 stage were so excellent that the entire transmitter was rebuilt to use this method of coupling, and no grid or plate chokes are used in any of the seven stages.

The negative plate supply lead, common to all stages, is grounded, and adequately cares for all stray r.f. with 900 watts input to the final stage.⁵

To avoid having an excessive number of dials on the panel, it will be found that grid coils for different bands can be wound so they resonate with approximately the same setting of the grid tuning condenser for each band. Slight variations can then be compensated for by tuning the plate-tank of the exciting stage, since plate-tank and grid-tank interlock to some extent when the coupling is tight enough.

Actual values of coils are difficult to specify, since stray capacities play such an important part, but Table I gives those used at W9QT. In general, the following principles should be observed: Use very low-C grid-tank circuits to obtain high voltage swings. Wind each grid-coil with about 1½ times as many turns as the corresponding plate coil, and then remove turns a few at a time (the grid-filament capacity shunting the grid coil may be lower than the plate-filament capacity shunting the plate coil). Remember that as the frequency is increased, the input impedance of the driven stage becomes lower, presenting a lower impedance to the exciting stage, and requiring relatively more turns in the grid-coil link-turns. Use as few link turns in both coils as possible, to keep the feed-line at low r.f. potential.

Resonance is indicated, of course, by the sharp rise in rectified grid current as resonance is approached. If the impedance presented to the driver stage is too high at resonance (indicated by low plate current on the driver stage and low grid current on the driven stage), the grid-coil tap must be moved "down" toward ground, or the

plate-coil tap must be moved "up" toward plate, or both. Conversely, if the impedance presented to the driver stage is too low at resonance (high plate current on driver stage) the grid-coil tap must be moved "up" toward grid, or the plate-coil tap must be moved toward ground, or both.

Preliminary adjustments should be made with no voltages applied to the driven stage, as in neutralizing an amplifier. When the approximate coil size has been found, check carefully for neutralization, even when using screen-grid tubes, and if the stage is not or cannot be neutralized, readjust the tap on the grid coil. With certain improper adjustments, the grid coil may act as a variometer and even a screen-grid tube may run t.g.t.p. when link coupling is being used. After resonance is secured and the stage is fully neutralized, apply reduced voltages and retune, making final adjustments when full voltages are applied. In general, the higher the plate input, the lower the grid impedance becomes at a fixed frequency.

April 1929 was a long, long time ago in amateur radio; but it has been the writer's experience that if information is really needed, it can be found either in a forgotten *QST* or in the *Handbook*. As a matter of fact, two-wire link coupling appeared in the 1930 *Handbook*; and in push-pull stages, there is practically no change from that original diagram. The one-wire link is offered merely as a modification which simplifies coil-mounting and design; either method provides freedom from r.f. losses through poor chokes. In either case the feed-line may be any reasonable length up to several feet, without appreciable losses in the line. But above all, proper impedance matching results in an enormous increase in useful output and greater economy in the number of stages preceding the final amplifier.

⁵ The common "ground" return circuit is important, too. See A. W. Friend's article, page 50, March *QST*.—EDITOR.

TABLE I

Type 10 Stage			Type 60 Stage		Final Amp.
Band	Grid	Plate	Grid	Plate	Grid
3500-kc.	18 turns No. 20 d.c.c. on tube base. Tap 7th turn. 10-μfd. capacity	20 turns No. 14 d.c.c., 2½" diam. Tap 3rd turn	40 turns No. 24 d.c.c., 2" diam. Tap 15th turn. 20-μfd. capacity	20 turns ¼" tubing, 4" diam. Tap 3rd turn	26 turns No. 20 d.c.c., 2" diam. Tap 24th turn. 20-μfd. tuning capacity
7000-kc.	10 turns No. 18 d.c.c. on tube base. Tap 3rd turn 10-μfd. capacity	10 turns No. 14 d.c.c., 2½" diam. Tap 3rd turn	18 turns No. 20 d.c.c., 2" diam. 20-μfd. tuning capacity. Tap 5th turn	10 turns ¼" tubing, 4" diam. Tap 2nd turn	16 turns No. 18 d.c.c., 2" diam. Full coil for link-turns. Grid lead attached to 12th turn. 20-μfd. cap.
14,000-kc.	6½ turns No. 18 d.c.c. on tube base. Tap 4th turn 10-μfd. capacity	6 turns No. 14 d.c.c., 2½" diam. Tap 1st turn	11 turns No. 14 d.c.c., 2" diam. Tap 3rd turn. 20-μfd. capacity	5 turns ¼" tubing, 3" diam. Tap 1st turn.	7 turns No. 14 d.c.c., 2" diam. Full coil for link-turns. Grid lead attached to 6th turn *

* Due to stray coupling between input and output circuits, the final amplifier was not perfectly neutralized by the screen-grid, and the tube required less grid driving power than on 7000 kc. Tap turns are counted from low-potential ("ground") end of each coil.



WHEN Art and Lil Bates were married on June 25, 1932, it represented the merger of a couple of good hams. Art had broken into the game as 8RY in Ohio in 1922, and promptly established an enviable reputation as a DX man.

His first record of 300 yards was quickly eclipsed by working a 2 — one of the few who never did QSL — and then by WNP's heard report from Etah. The 8RY of 1923-5 was one of the "low-losses" stations ever known to man. All tubes were debased, the 50-watter stood on its nose, with soldered direct leads to all circuit elements. This rig was heard in New Zealand on 180 meters, but soon joined the procession to 40 meters, where a reputation as a DX man was well and hardy earned. Followed a year of commercial brasspounding, after which Chicago and the "Call Book." This was 1926. It was also the year that saw the birth of 9FO, which moved from QRA to QRA until the present location, 10 miles due northwest of QRM, was found. There a "50-watter" in the final makes enough noise for anyone, with no attempt to blast the ether with a kilowatt-input-plus.

But that's only one side of the story. Lil's ham career evolved from a craze for B.C.L. set-building. But there wasn't much DX in that, so she walked a quarter of a mile each night to W8AAF and learned the code along with his YF. The first license was obtained in 1929. The first transmitter was a VT2, B-eliminator fed. Called to Kalamazoo to take the blue ticket exam in 1931, she passed with ease with a 50% code speed reserve. And then — Chicago. W8BPT was cancelled, and W9HGC made out, never to be used. For it was then she met Art Bates. First, he took her to a meeting of the C.R.T.A. They shortly made her their secretary. Then Art, perhaps not to be outdone, made her his wife.

There's not a great deal more to be said. Art and Lil are both true hams, consistently on the air. Both get their greatest thrill out of DX, and both are able to talk to quite a number of the stations they work in the operator's native tongue. And Lil will soon have that WAC — there's a J "hrd" card already, and a "wkd" one in the offing.

THE tale of Sally and her OM varies in several important respects. In the first place, when she married Millard M. Walker in Wharton, Texas, in 1930, she was not a ham-ess. In fact, her opinion of the species could probably have been summed up in one word — "Nertz!" But little did she know the danger of propinquity, and so five years later there's not only a W5AHK but a W5BKV as well.

Here are the details: The OM first felt the fatal bite shortly after the war. Jim Hunt, 5TG, provided the inoculation and, later, the gear. A semi-electrocution one day when the rotary left its shaft ended that phase of his career. When dynamic speakers came out, he went into public address work, rigging a system at the Wharton Country Fair. That was a big thrill for all concerned! About this time, several cases of YLitis developed, but it was not until 1930 — and Sally — that a resonant circuit developed. On their wedding trip to Mexico a serious throat trouble appeared which left the OM practically an invalid. After hospitalization, ham radio — a pair of '10's. After a bit of key practice — some of it surreptitious! — Sally got her ticket at Galveston, and from then on ham radio was distinctly a family affair. Voice was first tried on 1.7 mc. But that seemed tame in



ART AND LIL



SALLY AND MILLARD

comparison with what was going on on 14 mc. so in September, 1933, the Class A hurdle was leaped. In December the new rig went on the air — a pair of 276's modulated by Class B 203A's.

Now here's an odd one: While both Sally and

(Continued on page 49)

A Detector Circuit for Reducing Noise Interference in C.W. Reception

A New Experimental Angle in the Attack on Man-Made Static

By Leland E. Thompson*

In this article the author, a competent engineer, outlines a new approach to the solution of an old problem—the minimizing, at least, of static interference. While no extravagant claims are made for the method described, its trial in a standard type high-frequency superhet demonstrates that it unquestionably has merit. It, and at least one other soundly based system with which we have had recent experience (but which we are not yet permitted to describe), lead us to predict that the year ahead will see rapid progress in effective methods of static silencing applied within the receiver itself—not only for c.w., but for 'phone and broadcast reception as well—EDITOR.

WITH the coming of short-wave transmission and reception, interference from natural static has been greatly reduced. Of course, during the summer season, difficulty is still experienced from this source on the lower frequency bands. Interference of the so-called "man-made" static type has, however, increased and it is still with us on the high and ultra-high frequency bands.

The circuit which is described here is particularly effective in reducing this latter type of interference originating in all types of electrical machinery, power line leaks, automobile ignition, etc. It has little or no effect in increasing readability of signals through the usual type of natural static encountered on the lower frequency amateur bands, although it does help on the higher frequency bands during a local thunder storm.

"Man made" or "artificial" static produces, at the receiver detector input, separate damped trains of oscillations. Each train may be of considerable maximum amplitude, of a radio frequency determined by the tuned circuits in the receiver and the damping or length of duration of each train depending upon the selectivity of the receiver. The number of separate trains of oscillations per second is usually between twenty and several hundred, and may run as high as a thousand.

In the case of interference voltage caused by natural static appearing at the detector of a receiver, the oscillations may persist at an amplitude above that of the signal for a considerably greater period of time. It is known that a lightning stroke is not confined to a single discharge, but may be composed of ten or more separate discharges over the same path, with a varying

time between discharges, sometimes only a few millionths of a second.¹ The duration of the entire series of discharges ranges up to 0.6 second or more.² A further point to consider is that, on the lower-frequency bands, the static interference may be originating at considerable distances and thus not be confined to one storm center, but possibly to several. The interference radio frequency voltage at the receiver detector may then be almost continuously above the amplitude of the signal voltage. On the higher frequency bands, interference is usually encountered from only one local storm and the voltage form of the interference at the receiver detector approaches that of the artificial static.

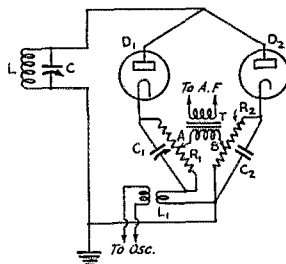

FIG. 1

It is generally believed that the best present method of reducing static interference is by the use of very selective receiver circuits. This is true for static of limited amplitude but is far from true in the case of exceedingly high amplitude static. Suppose this interference voltage is passed through a very selective radio-frequency circuit before the detector. While the peak amplitude of the interference would be greatly reduced, each train of oscillations would persist for a considerable period of time. Even if the circuit was as selective as that of a crystal filter circuit, the amplitude of the radio frequency oscillations of

* 740 White Horse Pike, Audubon, N. J.

¹ *General Electric Review*, July, 1934, page 349.

² *Code for Protection Against Lightning*, U. S. Government Printing Office, page 69.

the interference might still be continuously above that of the signal.

Another general method of reduction of this type of interference is that of limiting to a fixed value the amplitude of the interference in the receiver circuits. Limiting in the audio circuits after detection is very difficult to obtain without introducing an appreciable time lag in the circuits; that is, the circuits do not recover quickly enough after each interference impulse to let the signal through. A further difficulty is that the high peaks of the interference at the detector tend to "pull in step" the c.w. oscillator frequency and thus break up the signal audio frequency.

Ordinary limiting in the radio-frequency circuits overcomes these difficulties to some extent but introduces several others. First, a sharp limiting characteristic cannot be obtained with a simple circuit. That is, the signal and interference must be amplified to a very high value, and then both limited. This may produce a signal audio frequency which is full of harmonics and quite difficult to read in some cases. Furthermore the limiting is not likely to be complete. That is, the amplitude of the interference still may remain greater than that of the signal. This probably results because a tuned or otherwise selective circuit is necessary to connect the output of the limiting circuit to the detector and the relative amplitudes are thus partially restored.

The circuit described here overcomes the above difficulties. Specifically, each radio-frequency cycle of both noise and signal is limited to the same amplitude. Unlike the ordinary limiting circuit, however, the wave form of each radio-frequency cycle remains approximately a sine form. Thus, if an interference train of oscillations arrives at the detector exactly in phase with the signal, the interference is neither perceptible as an audio impulse, nor does it change the character of the signal in any way. If it arrives at the detector exactly out of phase with the signal, the signal has a "hole" in it for 1/5000 second or so. This is not nearly long enough to interfere with a single dot of a telegraph signal at a speed of twenty words per minute. Natural static, on the other hand, is out of phase with the signal so much of the time, and so often, that the signal is shot full of "holes" and sometimes disappears for a second or more at a time.

HETERODYNE DETECTOR ACTION

Before attempting to describe the operation of the circuit, we will review a few points in detector theory. With the ordinary biased triode detector circuit, with a comparatively low c.w. oscillator voltage of the order of 0.1 volt impressed on the grid, the amplitude of the audio beat frequency with a c.w. signal varies with the amplitude of the signal in the following manner: As the signal voltage is increased from a very low value, the output audio-frequency voltage increases approx-

imately proportional to it up to a certain point. Beyond this point, as the signal is increased above the oscillator voltage, it produces a smaller effect on the amplitude of the audio beat-frequency voltage. A point is reached where an increase in signal voltage causes no change in the audio voltage. This is the point where the grid voltage-plate current characteristic curve becomes a straight line.

The arrangement here described is a detector circuit operating with the signal voltage equal to or greater than the c.w. oscillator voltage. The receiver must have fairly high r.f. or i.f. amplification. Hence, the circuit is limited practically to use as the second detector of a superheterodyne receiver.

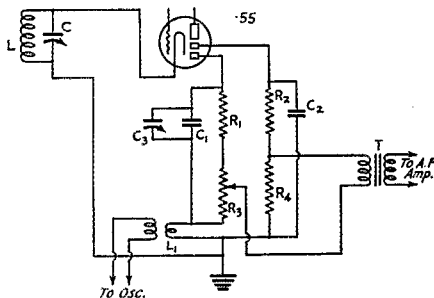

FIG. 2—THE PRACTICAL DETECTOR CIRCUIT

- R_1 —200,000 ohms.
- R_2 —200,000 ohms.
- R_3 —25,000-ohm potentiometer.
- R_4 —20,000 ohms.
- C_1 —150 μ fd.
- C_2 —200 μ fd.
- C_3 —70 μ fd. trimmer
- L_1 —15 turns closely coupled to oscillator tank circuit.
- T—Audio-frequency transformer.

Referring to Fig. 1 the action in general is as follows:

A c.w. signal will produce an audio beat frequency with the oscillator voltage introduced in L_1 . This audio beat frequency voltage will appear across R_1 but not across R_2 . It will, then, be present across the audio transformer T , the voltage across this transformer being at all times the difference between the potential at "A" and the potential at "B." Suppose the c.w. oscillator voltage across L_1 is such as to produce a current through D_2 equal to that produced by 0.2 volt across $L-C$. Then the beat frequency voltage across the transformer T will be approximately constant with any signal voltage between 0.3 volt and the maximum obtainable from the last i.f. amplifier tube, on the order of 100 volts.

Assume a signal voltage of 0.3 volt and an interference voltage composed of 120 separate trains of oscillations per second such as might be produced by a 60-cycle power line leak. The maximum amplitude of the oscillations in each train might be about 100 volts. This would represent a very serious interference to the signal on

the regular detector circuit and the signal probably could not be distinguished.

In the circuit of Fig. 1, the signal produces a *peak* audio voltage proportional to the peak voltage of the c.w. oscillator, across the transformer T . The interference produces a *peak* audio voltage of approximately the same value across the transformer T . This is true because during each radio frequency oscillation of the interference, the potential difference at any particular instant between points "A" and "B" can be no more than equal to the c.w. oscillator potential at that instant. The wave form of the audio signal is approximately sinusoidal, and perhaps of a frequency of 1000 cycles per second. The audio wave form of the interference is somewhat flat-topped, occurs approximately 120 times per second and each impulse lasts on the order of one five-thousandth second. While a more thorough analysis would show that the above is not strictly correct, it is sufficiently so for the practical purposes we are interested in here.

If the output signal and interference voltages are now plotted to scale, it will at once be apparent that the signal voltage should have a much higher *effective* value than that of the interference. Actually, by means of an output voltmeter reading the effective values, a signal-to-noise voltage ratio of 4/1 has been measured using this circuit under conditions of interference such that it was impossible to determine whether the signal was there or not on the ordinary detector circuit. It was found also with the ordinary detector circuit that, under this condition of interference, a highly selective r.f. circuit using a quartz crystal was ineffective in reducing the noise interference. Such striking results are not obtained when receiving comparatively weak signals, just above the receiver noise level, and when the interference is coming from a number of different sources. Usually, however, an increase in the readability of the signal is obtained.

The electrical balance of the circuits, without considering the oscillator voltage, must be very good. No results are obtained unless this balance is just about perfect. To secure a good balance, the phase difference between the current and voltage in each path must be adjusted to the same value. Variable condenser C_1 is used to obtain this adjustment. The adjustment is not extremely critical, but it helps materially in obtaining a good balance. The adjustment, when once made, need not be touched during regular operation of the receiver. The amplitude adjustment is made, of course, by adjusting the point "A" or "B" on the potentiometers. This adjustment, likewise, when once made is not changed during regular operation of the receiver. Another important factor in securing a good balance is the audio wave form as determined by the detector characteristics of the tubes. These characteristics must, of course, be as nearly alike as possible.

Diode tubes, operating in series with large fixed resistors, have suitably uniform detector characteristics. However, triodes or tetrodes may be used, and the detector characteristics matched by means of separately adjustable grid bias voltages.

The present circuit adds nothing to the adjacent channel selectivity of the receiver. Without proper adjustment of the receiver gain, the selectivity may be impaired. In general, the receiver gain should be kept to such a point that the interfering c.w. signal voltage on the detector is below the c.w. oscillator voltage, under which condition the receiver selectivity is the same as with the usual detector circuit. It is apparent that if the gain is increased to the point where the interfering signal voltage on the detector is higher than the c.w. oscillator voltage, and if the interfering c.w. signal voltage is greater than the desired signal voltage, the difference frequency between the desired signal and the c.w. oscillator will disappear, and the audio frequency present in the output will be the difference of the interfering signal frequency to the c.w. oscillator frequency.

USING ONE TUBE

Fig. 2 is an arrangement which has been found to work satisfactorily using only one detector tube. No use has been found for the extra grid and plate elements in this tube, since for r.f. the cathode is at comparatively high potential above ground.

It will be noted that the low ratio between R_3 and R_1 , and between R_4 and R_2 , represents an attenuation of the detector audio-frequency output. This was found to be necessary when using an ordinary audio transformer at T . Probably if a special transformer could be obtained having a capacity balanced primary winding with an impedance of 200,000 ohms or higher, this attenuation could be reduced. However, the loss can be made up in the audio amplifier without affecting the signal to tube-noise ratio, since the tube noise in the detector circuits, after the attenuation, is still of greater magnitude than that set up in the audio circuits alone. Only one audio stage is necessary to obtain good headphone signals.

In general the receiver itself should have two stages of i.f. amplification and one r.f. stage. If the superhet does not have an r.f. stage, a third stage of i.f. may be added, having a comparatively low gain so that the i.f. will remain stable. It should be remembered that if the gain of the receiver is so low that the signal voltage on the second detector is appreciably lower than the beat oscillator voltage, no improvement in signal-to-interference ratio is obtained.

A similar arrangement for the reception of 'phone signals is being tested, but at present not enough data have been obtained to determine its usefulness.

An RK-20 Tri-Tet Transmitter for Three-Band Operation

By George Grammer*

PRESENT amateur transmitter design technique for power outputs of the order of 50 watts usually calls for a layout having at least three stages—and often more—for operation in several bands. A good many amateurs are so situated that either they do not have the room for or the desire to nurse along a multi-stage transmitter. With the multi-stage job, too, band-changing often is such a complicated job that the set stays put in one band just because it's too much trouble to shift to another. The simplicity of an RK-20 Tri-tet rig has a distinct appeal to such as these, with the result that there has been a considerable demand for information on operation using crystals ground for higher-frequency bands than 3.5–4.0 megacycles.

The transmitter described here can be used on three bands with crystals ground for two of them—3.5 and 7 mc.—and provision also is made for the use of 14-mc. crystals if available. No plug-in coils are used, band-changing being accomplished by the use of tapped coils and shorting devices. The set is capable of delivering an output of about 60 watts on the 80- and 40-meter bands and about 25 watts on 20 meters, using only 80- and 40-meter crystals. It can be used for c.w. on all three bands, break-in operation being possible, and for 75-meter 'phone with a suitable modulator.

Views of the rig are shown in the three photographs, with the circuit diagram given in Fig. 1. The upright and cross-panel layout used is of ancient ancestry, dating back to the early c.w. days. It combines the conveniences of both breadboard and rack-type construction in that controls are panel-mounted yet all parts are readily accessible. In this set the uprights are pieces of $\frac{3}{4}$ by $1\frac{1}{2}$ -inch wood, each being 13 inches high. Triangular shaped pieces of thinner wood screwed to the bottom of each upright keep the assembly from

toppling over—despite the light weight of the transmitter, it is almost impossible to upset it by accident. The panels each measure 9 by 3 inches, and are of 3/16-inch bakelite.

The circuit diagram, Fig. 1, probably will look familiar to those who have scanned the similar diagrams which have been published in *QST* (June, 1934) and the *Handbook*. It is in fact the usual Tri-tet circuit modified for tapping of both plate and cathode tank coils for quick band changing. The cathode coils, L_1 and L_2 , are wound on a short piece of 2-inch bakelite tubing. The wire used is No. 14 d.c.c., with L_2 wound on the form and L_1 , which is tapped, wound right on top of L_2 . The very close coupling thus obtained between L_1 and L_2 makes it unnecessary to tap both coils, since the short-circuited portion of L_1 also short-circuits the magnetic flux about

the corresponding portion of L_2 . The two taps on L_1 were made by bending a loop in the wire at the appropriate turns as the winding progressed, the loops later being cleaned of insulation, squeezed up tight and soldered. The four ends of the two windings were brought through the coil form to machine screw terminals along the bottom edge. The drop in filament voltage through the windings is negligible, being only a few hundredths of a volt.

The lower panel contains the plate milliammeter—a miniature-size 0–200 range instrument—the crystal mounting, and the cathode tank circuit tuning condenser, C_1 . The crystal mounting, intended for the popular two-pin "tube-base" type holder, was made by drilling two holes, of a size sufficient to pass the holder

pins and the proper distance apart ($\frac{3}{4}$ inch) in the panel, and mounting behind them a pair of pin-grips taken from a discarded wafer socket. The plate tank tuning condenser and plate-coil band-changing switch are mounted on the upper bakelite panel.

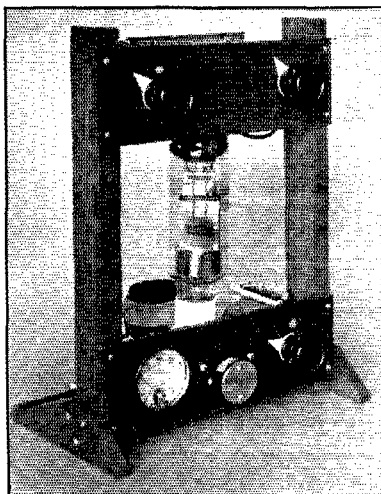

AN RK-20 TRI-TET OSCILLATOR

Although quite small in dimensions, this transmitter will give a crystal-controlled output of 60 watts on 3.5 and 7 mc. and about 25 watts on 14 mc. Its 'phone rating in the 4-mc. band is 15 watts carrier for 100% modulation.

* Assistant Technical Editor, *QST*.

In a small unit of this type a shelf or base-board would only complicate the construction and add nothing to the appearance; hence a skeleton frame for mounting parts was adopted. This frame is made of pieces of quarter-inch square brass rod, which is easily cut, drilled and tapped with simple tools. The rear and bottom views indicate the construction. The main "girder" runs horizontally across the bottom of the transmitter.

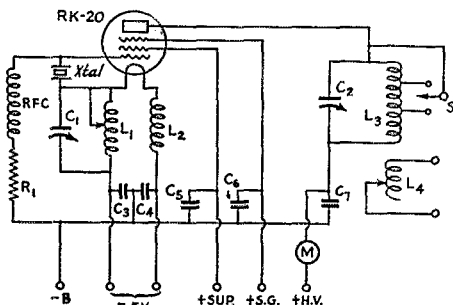

FIG. 1—THE RK-20 TRANSMITTER CIRCUIT DIAGRAM

- C₁—350- μ fd. variable, receiving type.
- C₂—100- μ fd. variable, transmitting type.
- C₃, C₄—0.05 μ d. (value not critical).
- C₅, C₆—0.02 μ d. mica condensers, receiver type.
- C₇—0.02- μ d. mica condenser, 2500- or 5000-volt rating.
- R₁—15,000 ohms, 2-watt rating.
- RFC—Short-wave choke, universal wound.
- L₁—10 turns No. 14 d.c.c. wire, close wound on 2-inch form. 7-mc. tap at 5 turns from lower (filament supply) end; 14-mc. tap at 8 turns from lower end.
- L₂—Same as L₁, but without taps. L₁ is wound directly over L₂ on the form.
- L₃—28 turns of No. 18 bare wire, turn spacing $\frac{1}{8}$ inch center-to-center; coil diameter $2\frac{1}{4}$ inches; 7-mc. tap 12 turns from plate end. 14-mc. tap 23 turns from plate end.
- L₄—6 turns same as L₃. L₄ is a continuation of L₃, the wire being cut at the appropriate turn.
- M—0-200 milliammeter.

On it are mounted the plate, screen and suppressor by-pass condensers. The brass-rod frame forms a common ground and negative bus for the transmitter. The socket for the tube is set on top of two upright pieces of rod, long enough for the socket to clear the condensers underneath, fastened to the main crosspiece. The filament by-pass condensers are mounted horizontally from these uprights. Additional bracing for the socket is provided by lengths of rod which connect the uprights on which the socket is mounted with the front panel. All power leads (properly insulated) are run through holes drilled in the crosspiece and go to the rear of the set where they connect to the terminal strip. The connections are all made with round bus bar, insulated with cambric tubing where necessary. The brass-rod frame, with all the components mounted on it, can be removed from the transmitter in a matter of a few minutes by removing a few wood screws, disconnecting the meter leads and unsoldering two or three connections.

The cathode coil assembly is held in place by

short pieces of copper strip which serve both as connections and mechanical braces between the lower coil terminals and the filament by-pass condensers. At the rear of the coil form another strip of copper furnishes additional bracing between the form and the terminal strip. The rear and bottom views should make the location of the various parts quite clear.

The plate tank coil, L₃, is mounted between the plate tuning condenser and the left-hand wooden upright (rear view) by means of brass pieces. The coil itself is wound of No. 14 bare wire threaded into strips of thin bakelite previously drilled to give the desired turn spacing ($\frac{1}{8}$ -inch center to center). The method of making coils of this type is described more completely in Don Mix's article elsewhere in this issue. Suffice to say that a coil thus constructed is quite strong mechanically, is not difficult to make, requiring only the patience necessary to drill the holes and thread the wire through, and can readily be tapped at any desired turn. In this case the wire was cut six turns in from one end to provide an output coupling coil insulated from the plate coil, which has the high voltage on it as a result of the use of series plate feed. The coupling coil is at the "dead" end of the plate coil to avoid capacity effects and reduce harmonic transfer, the turns being shorted from the plate or "hot" end.

The shorting switch used is a new type recently developed by Ohmite, utilizing a porcelain frame. Although three contacts are provided, only two are needed in this case, the switch being open in the 80-meter position, when the whole of the tank coil is used.

CIRCUIT CONSTANTS

Considerable time was spent in determining the optimum inductance values for the cathode coils, L₁ and L₂, and it is recommended that the constructor follow the specifications closely. Although the circuit will oscillate with almost any L-C combination so long as the cathode tank

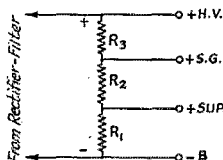

FIG. 2—SUGGESTED VOLTAGE DIVIDER FOR SUPPLYING SCREEN AND SUPPRESSOR VOLTAGES FROM 1000-VOLT PLATE SUPPLY

- R₁—2500 ohms, 5-watt rating.
- R₂—12,500 ohms, 25-watt or higher rating.
- R₃—12,500 ohms, 40-watt rating.

The resistors may be standard units of the values specified, or individual adjustment may be made to the voltages by using variable resistors of the type having sliding taps.

can be tuned to the crystal frequency or higher, maximum power output and minimum crystal heating will result only when the optimum L-C ratio is used. The cathode circuit wants to be fairly

low- L , and best operation results when the cathode coils are proportioned so that the crystal frequency is reached with the plates of C_1 full in, C_1 being a 350- μ fd. condenser. Resonance with the crystal is indicated by stopping of oscillations as the condenser capacity is increased. The resonance setting—just below the point where oscillations stop—is not the correct one for operation, however; under these conditions the power output is low and the load on the crystal is high. The optimum setting of C_1 usually will be found to be that at which the circuit is tuned in the region of the second harmonic of the crystal—in this particular transmitter, with C_1 at about half scale. The adjustment is most easily made with the transmitter coupled to a load, in which case C_1 is adjusted to bring the output to maximum. As C_1 is tuned downward (capacity lowered) from resonance, the r.f. voltage on the crystal, as indicated by a neon bulb touched to the grid of the tube, will decrease. It is advantageous, in fact, to decrease the capacity at C_1 even beyond the maximum power output point in order to reduce the crystal load. In making preliminary adjustments it is helpful to be able to listen to the signal, since the extent of crystal heating can be judged by the rate at which the frequency creeps. The cathode tuning condenser should be set for minimum creep even though some output is sacrificed, not only for the sake of the crystal but also to give a more readable signal.

In this connection, the new zero-temperature-coefficient crystals are ideally suited to the high-power Tri-tet oscillator, not only because frequency creep is practically eliminated but also because of their greater power-dissipating capabilities. While with X- and Y-cut crystals it may be necessary to detune the cathode circuit to reduce the crystal heating, the zero-temperature-coefficient crystals can be worked at the maximum power output point without harm either to the crystal or the signal.

The power output is considerably affected by the suppressor and screen-grid voltages. Although the suppressor can be connected to negative B with fair results, the decided increase in power output results when the suppressor potential is about 50 volts positive. More than 50 volts gives little increase. The screen voltage, likewise, should be adjusted so that the screen current is

about 30 milliamperes, requiring a screen potential of approximately 300 volts. The screen voltage should be, and the suppressor voltage may be, obtained from a divider across the plate supply, suitable values being indicated in Fig. 2.

The output of the transmitter is intended to be coupled into an antenna tuning unit like the one described in January *QST*.¹ This simplifies the antenna-coupling problem, and also makes the set readily adaptable to exciting a higher-power amplifier without any structural changes, since the coupling link is already provided.

TUNING

Tuning the transmitter offers no particular problems. Assuming a 3.5-mc. crystal is to be used, set the switch in the open position, leave the cathode-coil clip floating, apply filament and plate (including suppressor and screen) voltages, and turn C_1 down from maximum until the plate current drops, indicating that oscillations have started. Continue to decrease the capacity of C_1 until the plate current rises to a maximum and then adjust C_2 for the plate current dip which indicates resonance. With C_1 at about half scale the off-resonance plate current will be 100 milliamperes or more; at resonance it should drop to about 20 ma. The antenna may then be coupled and its tuning circuits adjusted for maximum output as described in the January article previously referred to. After the antenna is tuned, C_2 and C_1 should be readjusted to determine the optimum settings. The signal should be monitored for creep, with particular attention being paid to the setting of C_1 .

For operation on the second harmonic the procedure is the same as described above except that the plate-coil switch is set on the 7-mc. tap. The dip in plate current when C_2 is adjusted to resonance will not be so great as when the output is on the fundamental frequency of the crystal nor will the output be as high. Also, it may be found that a slightly higher-capacity setting of C_1 will give greater output on the harmonic than on the fundamental, crystal heating in relation to cathode-condenser setting being kept constantly in mind, of course.

To use the set with a 7-mc. crystal, both the

¹ "A General Purpose 50-Watt Transmitter, *QST*, January, 1935.

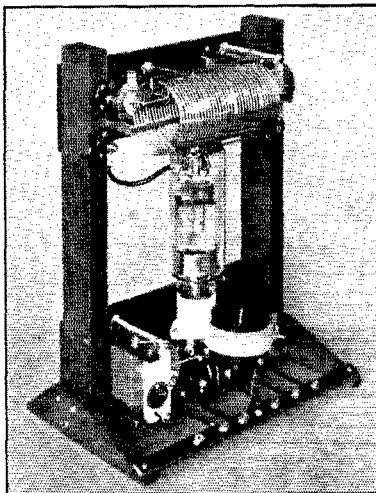

THE COIL CONSTRUCTION IS PLAINLY INDICATED IN THIS REAR VIEW

The plate coil, at the top, is wound on a 2-inch form before being threaded through the supporting strips. The springiness of the wire makes the diameter of the finished coil $2\frac{1}{4}$ inches.

plate switch and the cathode-coil clip should be set on the proper taps. The tuning procedure is identical with that just described, and it should be found that fundamental operation with a 7-mc. crystal is just about the same with respect to plate current variation and power output as fundamental operation on 3.5 mc. As a doubler, however, the tube is not as efficient in going from

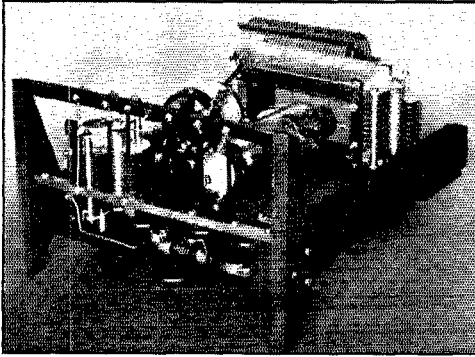

A BOTTOM VIEW, SHOWING HOW THE BY-PASS CONDENSERS ARE MOUNTED ON THE BRASS-ROD SUPPORTING STRUCTURE

The resistor near the panel is the grid leak. The grid choke is fastened by its pigtail connections between the grid prong on the tube socket and one end of the leak.

40 to 20 meters as from 80 to 40 meters, with the result that the second-harmonic plate current dip on 20 is comparatively small and the output drops to about 25 watts. This is unfortunate but not unusual, and seems to be true of all kinds of tubes used as doublers. "Twenty" is the one band of the four lower-frequency bands where simplicity in design entails a sacrifice of output. On the other hand, an alleviating feature is the fact that low power on 14 mc. is equally effective in snaring the DX as two or three times as much power on lower frequencies.

Somewhat more power output can be obtained by using a 14-mc. crystal, in which case the cathode coil clip is placed on the appropriate tap on L_1 . Since 14-mc. plates are very thin and are not capable of handling as much power as those ground for lower frequencies they should be used with caution. The tuning procedure is just the same as with the lower frequency plates.

From the description above, it should be apparent that with any single crystal, shifting the transmitter itself from one to the other of two bands is a matter of but a few seconds. Replacing crystals and changing the tap on the cathode coil adds but a few more; in fact, the maximum number of operations required on the transmitter for band changing takes no more—if as much—time than a corresponding change of receiver coils. Antenna tuning may increase the time required, depending upon the type of antenna system in use, but the whole procedure is straight-

forward and not likely to be done in such a way as to leave any loose ends, as is often the case when multi-stage transmitters are shifted from one band to another.

Although the positions recommended for the plate coil taps in Fig. 1 are likely to be about right provided the coil itself is duplicated, it may be desirable, before the taps are soldered on, to try different positions with the set actually in operation. As much inductance as possible should be used on the 7- and 14-mc. bands, so that a tap which brings the circuit to resonance with C_2 set near minimum should be used.

KEYING

Center-tap keying is a satisfactory method, but prone to produce key clicks unless a thump filter is used. Although the key is not shown in the circuit diagram, it would be connected between the negative terminal of the power supply and the center-tap on the filament transformer. Since center-tap keying cuts off completely the space current in the tube, it is decidedly positive in action.

The suppressor grid also offers a means of keying the oscillator, circuits like those shown in the Experimenters' Section, this issue, being recommended. Negative suppressor bias sufficient to cut off plate-current flow and thus give a good keyed signal on the air may not prevent the tube from continuing to oscillate through its screen-grid, however, so that this method may not be entirely satisfactory for break-in work.

MODULATION

The transmitter can be used as a suppressor-grid modulated 'phone in the 3.9-4.0-mc. 'phone

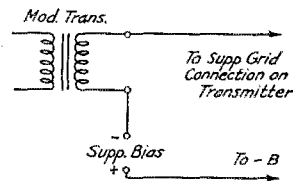

FIG. 3—CONNECTIONS FOR MODULATION OF THE SUPPRESSOR GRID

The suppressor should be disconnected from the tap on the voltage divider in Fig. 2 and fed negative bias through the secondary of the modulation transformer.

band, giving a carrier output of about 15 watts. It is not recommended for 'phone in the 14-mc. band, however. A modulator such as the one described in March *QST*² is very well suited to modulating the suppressor of the RK-20. A separate grid-bias source should be provided for the suppressor grid, either batteries or a power pack with adjustable voltage output being suit-

(Continued on page 98)

² "Grid Bias Modulation for the General Purpose Transmitter," *QST*, March, 1935.

A New Type of Two-Terminal Oscillator Circuit

The Use of the 57 or 6C6 to Obtain Negative Transconductance and Negative Resistance*

Several years ago the dynatron oscillator, which utilized negative resistance obtained by secondary emission, was a popular type with amateurs, particularly for frequency meters. With the coming of lessened secondary emission in later type tubes, along with more consistent circuits such as the electron-coupled type, the dynatron fell into disuse. But the simplicity of the two-terminal tuned circuit that is a feature of the dynatron remains attractive. It is revived in the negative transconductance circuit, a recent development having several advantages over the dynatron, described in this article.—EDITOR.

AMONG the circuit combinations possible with three-grid tubes in which the connections to all three grids are brought out, one combination of particular interest produces a simple and reliable negative-resistance device. It is the purpose of this note to explain the operation of such a device utilizing the 57 or 6C6 and to give suitable operating conditions for these types, which are particularly well suited for this application.

In vacuum tubes connected in the usual manner, a rise (change in positive direction) in control-electrode voltage causes a rise in anode current. With a resistive anode load, the anode voltage drops with a rise in anode current; thus, the grid voltage change and the anode voltage change are in exact opposition. In order to make oscillations possible, it is necessary to feed back energy from the anode circuit to the control-electrode circuit in such a way as to increase the controlling voltage. Since, with a resistive grid and a resistive plate circuit, the voltage changes in the two circuits are in opposition, it is not possible to provide feedback in a simple way. Ordinarily, either reactive circuits or magnetic coupling must be used in the oscillator arrangement to adjust properly the phase of the voltage feedback from anode to control electrode. Both methods require a more complicated oscillator circuit than that required with simple two-terminal negative-resistance devices such as, for example, the dynatron.

If the anode current of a tube could be made to decrease when the control-grid voltage is raised, the grid-voltage change and the plate-voltage change with resistive circuits would no longer be in opposition but would be in the proper relation to produce feedback effects. Such an arrangement would avoid the feedback complications of the ordinary oscillator, since only a

fixed condenser between the control electrode and anode is necessary to transmit anode-voltage fluctuations to the control electrode in proper phase. A tube in which the anode current drops when the control-electrode voltage rises has a grid-plate transconductance opposite in sign to that of the usual tube, and may therefore properly be described as a tube having negative grid-plate transconductance.

MODE OF OPERATION

If the No. 3 grid (suppressor) of the type 57 or 6C6 is used as a control electrode and is made more negative, some of the electrons will be turned back toward the cathode; the plate cur-

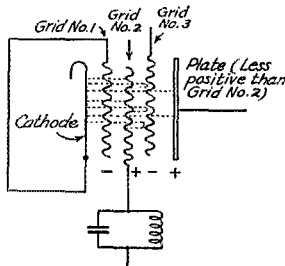

FIG. 1.—PATHS OF ELECTRONS IN A PENTODE WHEN OPERATED AS A NEGATIVE TRANSDUCTANCE TUBE

rent, therefore, decreases. (See Fig. 1.) The electrons which are turned back, however, are attracted by the positive voltage impressed on the No. 2 grid (screen), and pass to it so as to increase its current. If, then, the No. 2 grid be considered as the anode in place of the usual plate and the No. 3 grid be considered as the control electrode, the arrangement will have negative grid-plate transconductance. When a pentode is used in this fashion, the current which passes to the usual

* From Application Note, Copyright, 1935, RCA Manufacturing Co.

plate is not employed. This is similar to conventional applications where the screen current is not utilized. Although no mention has been made of the No. 1 grid, this grid does have a valuable function in the tube, because it can be used to control the total amount of cathode current and, therefore, the magnitude of the effect. In this

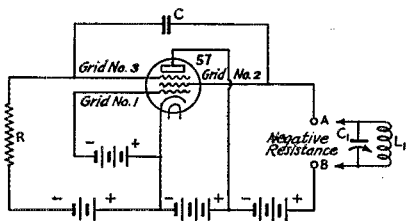

FIG. 2—THE VOLTAGE-CONTROLLED OSCILLATOR CIRCUIT

The tuned circuit values L_1 and C_1 are usual for the frequency desired. As explained in the text, the coupling condenser C should have reactance negligible in value compared to the resistance of R . For high frequencies R could be the usual grid leak and C a fixed condenser of 500 $\mu\text{fd.}$ or so. Although battery supplies are indicated for illustration, the various voltages (see table of operating conditions) can be taken from a power-pack divider—with proper by-passing, of course.

respect, it is analogous to the function of the No. 1 grid in the pliodynatron. In addition, it exerts a limiting action on the total current so that the No. 2 grid resistance is increased.

A circuit using the 57 in this manner to obtain a negative resistance is shown in Fig. 2. The No. 1 grid can, for simplicity in explaining the operation, be connected directly to the cathode. The usual plate is connected to a positive potential. The No. 3 grid is connected to the No. 2 grid through a large condenser, C . A suitable negative bias is applied to the No. 3 grid through the high-resistance grid leak, R . The negative resistance is exhibited between terminals A and B . The operation of the circuit is as follows:

An instantaneous rise in voltage across the terminals AB is transmitted by the condenser C to the No. 3 grid, which has its potential in-

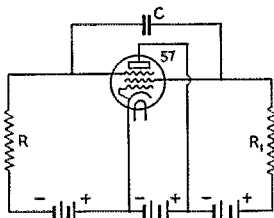

FIG. 3—THE CURRENT-CONTROLLED RELAXATION OSCILLATOR CIRCUIT

This would be more suitable for very low frequencies.

creased, thereby decreasing the No. 2 grid current. Since the No. 3 grid is biased negatively and draws no current, the total current in what-

ever circuit is connected to AB is determined only by the No. 2 grid current. It is, therefore, evident that the instantaneous rise in voltage across AB is accompanied by a drop in current. This is the characteristic of a negative resistance. From the explanation, it is seen that the negative resistance occurs only for variations in voltage which are rapid since, otherwise, the condenser C does not transmit the variations. A static characteristic taken on the arrangement shows no negative resistance, although the negative resistance is present for alternating voltages. As either the condenser C or the grid leak R is made larger in value, the lowest frequency to which the circuit behaves as a negative resistance is made less. The condenser C and the grid leak R must be chosen in the same way as the coupling condenser and leak in a resistance-coupled amplifier; that is, the condenser reactance must be small compared to the grid-leak resistance, to transmit satisfactorily the lowest frequency to be used.

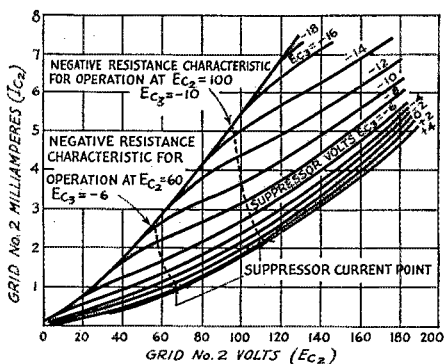

FIG. 4—TYPICAL GRID NO. 2 CHARACTERISTICS OF A 57 TO SHOW PERFORMANCE AS A NEGATIVE-TRANSCONDUCTANCE TUBE

$E_f = 2.5$ volts.
Control-grid volts (E_{c1}) = 0
Plate volts = 22.5.

Dashed-line curves illustrate voltage-controlled negative-resistance characteristics obtained by assuming equal incremental changes of E_{c2} and E_{c3} . Dynamic characteristics for operating condition with $E_{c2} = 100$, $E_{c3} = -10$ are:

Grid No. 3—Grid No. 2 transconductance = -310 micromhos.

Grid No. 2 Resistance = 40,000 ohms.

Grid No. 3—Grid No. 2 amp. factor (I_{c2} constant) = -12.4 .

The value of the negative resistance produced may be calculated as follows:

When the instantaneous voltage on the No. 2 grid rises a small amount ΔE , a rise in current $\Delta E/r_{g2}$ would be expected, where r_{g2} is the No. 2 grid resistance. At the same time, however, the condenser to the No. 3 grid permits its voltage to rise an amount ΔE ; this tends to lower the No. 2 grid current by an amount $s_{m3,2}\Delta E$. The effective resistance of the combination is represented by the change in voltage divided by the total change in current and is therefore given by:

$$\text{Resistance} = \Delta E / \Delta I = \frac{\Delta E}{\Delta E / r_{p2} - s_{m3-2} \Delta E}$$

$$= \frac{1}{1/r_{p2} - s_{m3-2}}$$

In the 57 and 6C6 tubes, $1/r_{p2}$ is much smaller than s_{m3-2} under best operating conditions to produce negative resistance. The negative resistance produced is, therefore, approximately the reciprocal of the negative transconductance between the No. 3 and the No. 2 grids. The lowest negative resistance is thus found at the point having highest negative transconductance.

OPERATING CONDITIONS

Suitable operating conditions for a tube may be found by choosing values for No. 1 grid voltage (E_{c1}), No. 2 grid voltage (E_{c2}), and plate voltage (E_b) to give a reasonable cathode current; and then varying No. 3 grid voltage (E_{c3}) to find the point of maximum transconductance to the No. 2 grid. This value of E_{c3} may then be used as the bias value.

Typical operating conditions for the two types of tubes are:

	Type 57	Type 6C6
Heater Volts (E_f)	2.5	6.3
No. 1 Grid Volts (E_{c1})	0	0
No. 2 Grid Volts (E_{c2})	100	100
No. 3 Grid Volts (E_{c3})	-10	-10
Plate Volts (E_b)	22.5	22.5
No. 2 Grid Milliamperes (I_{c2})*	4	4.1
Plate Milliamperes (I_b)*	2.9	2.4
No. 3 Grid to No. 2 Grid Transconductance (s_{m3-2}), micromhos	-320	-280
Negative Resistance Produced, ohms*	3400	4000

* Approximate.

In addition to the operating conditions for the values given, the 57 and 6C6 may be operated over a wide range of voltages. For example, increasing E_{c1} in the negative direction reduces the cathode current and increases the negative resistance. If E_b is increased, E_{c3} must be increased in the negative direction by approximately the same ratio in order to continue to operate at the center point of the negative-resistance characteristic. No improvement in operating characteristics is obtained by raising E_b . An increase in E_{c2} , though not advised from the point of view of tube life, will cause an increase in s_{m3-2} and hence a decrease in the negative resistance.

The complete negative-resistance performance of a three-grid tube may be predicted from the No. 2 grid characteristic curves. The I_{c2} vs. E_{c2} curves for various values of E_{c3} (holding E_{c1} and E_b constant) may be used to plot the dynamic characteristics. Such a set of characteristics is shown in Fig. 4 for a type 57 tube. The dashed-line curves indicate the dynamic negative-resistance characteristics to be expected at the terminals AB in Fig. 2 when the frequency is sufficiently high to make the condenser reactance negligible as compared with the grid-leak resistance.

ADVANTAGE OVER THE DYNATRON

In order to utilize the negative-resistance circuit for the production of oscillations, it is simply necessary to connect a parallel-tuned circuit to the terminals AB of Fig. 2. Variation of the No. 1 grid voltage provides a simple and convenient method of controlling the strength of oscillation. This is illustrated by the curve of Fig. 3. It should be pointed out that the advantages of simplicity, stability, and good waveform obtainable with the dynatron are all present in the negative-transconductance method. In addition, the negative resistance produced does not depend on secondary emission, so that a degree of uniformity and reliability not ordinarily found in dynatrons is present. The negative resistance produced is lower than that of most tubes used as dynatrons when the same cathode current is permitted. This is an advantage, since the lower negative resistance permits oscillation with a higher-loss tuned circuit.

At the same time, the total shunt capacitance of the tube, feedback condenser and leak may be made almost as small as that of most commercial tubes used as dynatrons.

To give practical data on the advantages of the 57 and 6C6 tubes over the dynatron method of obtaining negative resistance and to compare results with similar data taken on the 57 and 6C6 in the negative-transconductance circuit, measurements were taken on some type 24-A tubes used as dynatrons. The results are presented briefly in the following analysis. The data were taken on 24-A tubes of present production having carbonized plates. The voltage conditions were adjusted to obtain approximately the same cathode current as that of the 57 and 6C6 tubes.

	Type 57	Type 6C6	Type 24-A (Dynatron-operated)
Mean Negative Resistance	3400 ohms	3900 ohms	59,000 ohms
Average Deviation from Mean	8%	3%	44%
Maximum Deviation from Mean	23%	15%	87%

Although the 24-A tubes tested were extremely poor as dynatrons because of the use of carbonized plates, it is believed that the variations between tubes as measured by the percentage deviations from the mean are typical. Thus, the use of a more suitable plate material might lower the negative resistance to an average of 20,000 ohms or so, but the variations between tubes expressed in per

(Continued on page 58)

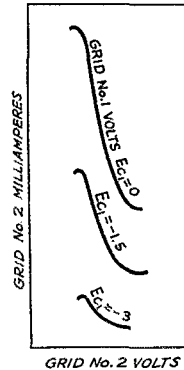

FIG. 5

A More Efficient Impeller for Wind-Driven Generators

By Edmund C. Lynch,* W5EQD

THE article on "Getting Power from the Winds," in *QST* for March, 1934, stated that the shape of the impeller is very important in the proper operation of the rig, but little specific information was given to aid in the construction of a suitable impeller. The following data are the result of three years in operating a wind-driven generator and are submitted in the hope that they may reduce the troubles of those amateurs who desire to let Mother Nature help replace a power line.

Although any kind of an impeller will work in a stiff breeze, the effectiveness of a carefully made impeller shows up in a steady, though small, charge at low wind speed. The impeller to be described was designed with airfoil sections for the blade section, modified to meet the conditions of operation and to fit in standard material.

The rig on which this impeller has been installed has been operating for three years, with the present impeller now two years old. It is used to charge three Delco Light cells which operate a receiver, although originally intended to operate a low-powered transmitter. The usual Model "T" Ford generator is the source of power and the arrangement is similar to those already described. In this case the impeller is fastened to a Model "T" front wheel hub which rotates on its regular spindle. A fiber camshaft gear has been cut out in the center and fastened to the back of the flange on the hub. This gear drives the generator through the regular drive gear fastened to the generator shaft. The impeller thus corresponds to the camshaft of the Model "T" engine.

This type generator cuts in at 650-r.p.m. generator speed, which corresponds to 200 r.p.m. camshaft speed. The impeller was designed to rotate at 200 r.p.m. in a 6-mile wind. Maximum charge is delivered in a 15-mile wind.

The impeller is carved out of a piece of standard 2-by-6 inch lumber 7 feet long. The actual dimensions are $1\frac{5}{8}$ by $5\frac{5}{8}$ inches. The piece was carefully selected for straight grain and uniform texture; that is, without a mixture of heartwood and sapwood. Almost any kind of wood may be used, but fir seemed to be the most uniform. Of course a laminated blank could be built up if it were impossible to get a suitable piece. The piece should be seven feet long, as this is the diameter of the impeller.

The first step is to make a metal template for gauging the curved back of the blade during the

* Randolph Field, Texas.

carving process. Heavy celluloid will do as well and may be easier to work. The dimensions for the blade section are given in the table and should be accurately plotted to obtain the best results. A triangular engineer's scale graduated to $1/50$ th inch is the easiest rule to use in plotting and a fine sewing needle makes an excellent marker. The relationship of the dimensions is shown in Fig. 1, "x" being the distance in inches from the nose of the section to various points along the chord, or the abscissas used in plotting the outline, while "b" and "a" are the ordinates to the lower and upper surfaces, respectively, for the point "x." For example, at a distance of .28 inch back from the nose ("x") the ordinate to the lower surface is .02 inch ("b") and that to the upper surface is .56 inch ("a").

The points will not fall exactly on a smooth curve because of the small scale of the section, but a smooth curve should be drawn as close to the points as possible. The shape may then be transferred to the material to be used for the template and the template worked down to the curve. The curve on the under side of the nose should be left off the template for carving the back and a second template made for the nose section alone. The curved back is worked down with the first template and the nose with the second, using the completed upper curve as a base.

The next step is to determine the direction of rotation. This impeller rotates in a counter-clockwise direction. Mark the center of the blank for the hole that will fit over the hub and draw a line at right angles to the long axis of the blade all the way around the blank. Hold the blank up and mark the edge ($1\frac{5}{8}$ -inch edge) which will trail as the blade rotates, the $5\frac{5}{8}$ -inch face toward you being the side on which the wind will strike, or the "face" of the blade. Mark the trailing edge for each blade. Starting from the center of the blank, lay off on the $1\frac{5}{8}$ -inch edge a mark 12 inches from the center and draw a line at right angles to the face of the blade. Lay off similar lines at 18, 24, 30, 36 and 42 inches from the center. The points as indicated in Fig. 2 are then laid off from the face of the blade, the dimensions being given in that figure. The figure is not to scale in order to make the dimensions clear. Join the points located with a smooth line. Repeat for the other blade.

The face of the blade is now worked down using the curved line just drawn as one guide line and the corner where the face and the leading

edge of the blade meet as the other guide line. The face is carved down until it is flat and smooth, the smoother the better.

The back or curved side of the blade is now worked down. It should be noted that the nose of each section is tangent to the leading edge of the

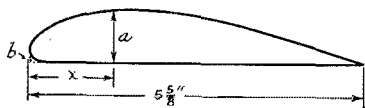
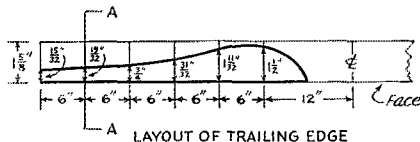

FIG. 1



SECTION A A

FIG. 2

blade as shown in section AA of Fig. 2. This serves as a reference point. The easiest way is to work down sections 6 inches apart corresponding to the markings on the trailing edge of the blade. These sections should be worked down carefully. The remaining portion of the back may then be worked down to these sections. The back should have a smooth finish the same as the face. The ends are merely rounded to take off the sharp edges. There is no curve to the tip.

The blades should be carefully balanced. Balancing should start while finishing the backs of the blades. Final balancing is done with the impeller mounted on the hub, using light oil on the bearings. In case the blades do not balance and the shape has been worked down until further carving will change the shape of the section, a small piece of lead may be driven into a hole drilled longitudinally in the thickest part of the end section.

The impeller is finished with several coats of shellac to seal the pores of the wood. The blades should be balanced while shellacing; in fact, final balancing can often be achieved by adding an extra coat or two on the lighter blade. The impeller should balance as accurately as possible. Unbalance will cause excessive vibration in a strong wind and may tear the installation down. The impeller described has stood up in strong winds without damage, though it is the practice to throw it out when the wind gets above 25 miles per hour.

When mounting the impeller on the hub the blades should be tracked to see that they rotate in a plane that is at right angles to the axis of rotation. This can be checked by setting the

assembly on a bench with the impeller vertical and placing a block on the floor so that it just touches the blade. When the impeller is turned 180 degrees, the other blade should likewise just touch the block. The impeller may be made to track by shimming at the hub.

Template Data

"x" in inches	"b" in inches	"a" in inches
0.0	0.21	0.21
.07	.075	.38
.14	.045	.45
.28	.02	.56
.42	.01	.63
.56	.00	.69
.85		.78
1.13		.83
1.69		.87
2.25		.84
2.81		.76
3.38		.65
3.94		.52
4.50		.37
5.06		.20
5.35		.11
5.625		.02

The radius of the nose is 0.18 inch.

It should be noted that this impeller was designed for a specific task. It will not be satisfactory at different conditions of wind speed and load. More power may be obtained by increasing the chord of the section and the length of the blade, but the blade angles given in Fig. 2 will only be good for 200 r.p.m. in a 6-mile wind. From the rigs previously described, it seems to meet the majority of requirements.

Hamdom

(Continued from page 37)

the OM work 'phone, it's the OM who really is the 'phone hound. Sally, it seems, prefers to revert to type and change the rig over to c.w.—and then can be heard complaining about tin ears and wondering why that VK doesn't get a new receiver. It's all a game, and a swell lot of fun; but it's more than that, too. Ham radio has meant escape and has aided recovery during four years of invalidism. It has brought many friends and much happiness. And that, be you OM, OW, YF or YL, is as much as any of you can say.

Strays

For the benefit of Canadian purchasers of the Radio Amateur's Handbook, we have been advised by the Department of National Revenue of Canada, Customs Division, that the Handbook may be entered free of Customs duty under the first part of tariff item 172. The Canadian Customs Division adds, however, that there is payable on books classified under the first part of this tariff item the consumption or sales tax of 6%.

With the Affiliated Clubs

GREETINGS to these newly A.R.R.L. affiliated clubs: Charleston Amateur Radio Club, Charleston, South Carolina. Moose Jaw Amateur Radio Club, Moose Jaw, Saskatchewan, Canada. New England Radio Research Association, Springfield, Massachusetts. St. Cloud Radio Club, St. Cloud, Minnesota.

Miscellany

The Campus Radio Club, Ames, Iowa, is working on plans for a club transmitter. . . . Yakima (Wash.) Amateur Radio Club elected officers: W7ETX, president; W7AYO, vice-president; W7DWF (Miss Mowery), treasurer; W7DCN (Miss Black), secretary; W7BUX, W7ANF, W7BCS, W7ALH, directors . . . how many clubs have YL officers? . . . The Lake Worth (Florida) Amateur Radio Club has voted to sponsor the Florida A.A.R.S.C.W. Net as its major project for the year. . . . The membership of the Tri-States Radio Club of Port Jervis, N. Y., includes amateurs from the states of New York, New Jersey and Pennsylvania . . . an official club bulletin is issued regularly with W2GTW as editor. . . . W3AMB is in charge of the Richmond (Va.) Short Wave Club's program of code instruction, a major feature of that club's activities. . . . Five members of the Radio Operators Association of New Bedford (Mass.) participated in the recent A.R.R.L. 'Phone-C.W. contest, using the opportunity for a friendly competition between themselves. . . . result—W1IKU (c.w.) 464 points, W1BLU (phone) 372, W1AGA (phone and c.w.) 288, W1AGW (phone) 40, W1CBZ (c.w.) 12. . . . The Fond du Lac (Wis.) Amateur Radio Club had an exhibit at the annual hobby show in that city, March 16-17 . . . a complete amateur station was demonstrated. . . . The St. Joseph Valley Amateur Radio Club of Mishawaka, Indiana, has outlined a series of "joint meetings" to be held with clubs in neighboring cities . . . this is an excellent idea both because it makes for better coöperation between different groups and because it breaks the possible monotony of routine meetings. . . .

In late December, 1934, the Amateur Transmitters Association of Western Pennsylvania put on a very fine amateur radio exhibit in Pittsburgh. Equipment displayed ranged from old spark transmitters to $\frac{3}{4}$ -meter gear, and included some particularly neat and modern transmitters and receivers. Amateurs coöperating in putting over this exhibit were W8OW, W8LED, W8ADS, W8OC and W8MHA. . . . The Northern Nassau Wireless Association elected new officers for 1935, as follows: W2AYJ, president;

W2AOL, vice-president; W2DPQ, secretary; W2DUA, treasurer; W2DJA, chief operator; W2AIZ, traffic manager. . . . K. B. Warner, W1EH, A.R.R.L. Secretary, was made an honorary member of the Tri-State Amateur Radio Club of Sioux City, Iowa, during his visit to that city on February 18th . . . this club has but four honorary members. . . . The Missoula (Mont.) Amateur Radio Operators' Club has been having some very interesting speakers . . . among the subjects covered have been "Cosmic Rays," "Radio as Used by U. S. Forest Service in Reporting Weather Conditions and Handling Traffic During Fires," "Spark Transmitters" and "Capacity and Inductance in Alternating Currents" . . . interesting speakers and topics help to keep up the interest of club members. . . .

Brooklyn Club Announces Contest

The Radio Club of Brooklyn is making an effort to get all licensed members active on the air. At a recent meeting it was voted to hold a contest for this purpose. Among the rules are these interesting points: All transmitters built in the contest must have an r.f. output of not less than ten watts. Contestants completing their transmitters within six months from the starting date will receive a year's membership in the A.R.R.L. Contestants must file with the contest committee proof showing consistent operation from the time the transmitter is completed to the end of the contest period. A contest of this type should do much to stir some of the "inactives" on any club's roster into action; it's well worth a try.

WJBC—1200 kc.

The Central Illinois Radio Club (Bloomington, Ill.) has been given a half hour on the local broadcasting station, WJBC, 1200 kc., every Friday at 11:00 p.m. C.S.T. starting March 1st. The main purpose of the programs is to acquaint the general public with the benefits derived from amateur radio in any community, although the material broadcast will interest hams as well. The value of amateur radio in emergencies will be stressed.

Club Meetings a la 56 mc.

In the "old days" if the winter's storms made traveling difficult, club members thought nothing of the report "no club meeting because of the storm." But nowadays! . . . A heavy snow hit Providence, R. I., late in January, seriously tying up transportation. Members of the Providence

(Continued on page 88)

What the League Is Doing

League Activities, Washington Notes, Board Actions—For Your Information

Conventions Occasionally the A.R.R.L. offices receive a letter suggesting that the headquarters staff has a tendency to pass lightly over carefully-considered criticisms and resolutions adopted by conventions. We are sorry if we have ever given that impression but we think we know from what it may arise and we would like to discuss it on this page.

The vote in A.R.R.L. affairs is by divisions, each division director possessing one vote. There are thirteen divisions in the United States and a total of sixteen directors. Let us imagine a hypothetical case where absolutely every member of a certain division is in favor of doing a certain thing but the other divisions of the United States are opposed to that thing being done. Even if the first division is 100% for it, they will have but one vote out of sixteen in the determination of A.R.R.L. affairs and the decision will have to be made in terms of the fact that all the other divisions are opposed, since majority rule must govern. Such a situation is always very difficult to comprehend in the division that is alone on the question. Every member there knows that every other amateur with whom he discusses the question thinks as he does and they are aware that they are 100% for a particular point of view. It is difficult for people as young as most of us amateurs to realize that the rest of the country outside our division may feel very differently on the question.

Now when any such matter arises it is very probable that A.R.R.L. already has a policy, which has been laid down by the Board of Directors at a previous meeting and instructions given the officers concerning it. The officers are definitely ordered to pursue a certain policy, representing majority opinion amongst the different divisions as to what A.R.R.L. should do about a particular matter. If under those circumstances the headquarters receives criticisms from a club or a division, or some resolutions adopted at a convention espousing a plan contrary to the instructions given by the Board, there are only two things for us to do, and those we do: (1) We try to explain why the League has its present policy, what the underlying reasons were that impelled the Board to decide the matter the way it has been decided, contrary to the wish of these particular resolutions. (2) If the resolutions present a new idea that might be acted upon in the future, we refer it to the division director.

There is nothing else the headquarters can do. We do not mean to pass over these views lightly,

but we cannot comply with them if they are contrary to our instructions. The voice of the division is to be expressed by the division director, not by us, and the only workable arrangement is for those resolutions to be laid before the entire Board by the director of that division, urging that point of view as being the opinion of his division and representing something that he thinks ought to be adopted all over the country.

Another complaint sometimes mentioned in letters is that the headquarters seems glad enough to let things slide along without the transaction of important business at conventions. Our general attitude on this subject necessarily has to be in compliance with the constitution and by-laws of the League. There are two ways of governing a mutual coöperative non-commercial fraternal and technical society like ours, but they are not interchangeable. One method of governing is the one that we employ in A.R.R.L.: We divide the country into regions and in each region we have a popular election by ballot to choose what is in effect a regional governor. These regional governors meet and constitute a national board of governors, each possessing one vote and by their majority opinion controlling the affairs of our entire organization. These governors, or directors as we call them, are obliged by our constitution to inform themselves on the needs and desires of their members, but the function of control is lodged in them as individuals. The theory is that it is impossible for the entire membership to participate in personal voting on every question that comes up in our affairs. The members, therefore, select a representative or spokesman and delegate to him the right to speak for them. The important characteristic of this A.R.R.L. system is that, after the members have elected a director, the director receives the power of his membership, and thereafter the membership participate in affairs *by the medium of expressing their opinion through the director*. It is exactly as in the Congress of the United States. The private citizen does not have an opportunity to vote on the adoption of every proposed law. He has elected a congressman to do that for him and has delegated his power to the congressman. But while he cannot vote, he does have the right of expressing his opinion to his congressman and letting him know how he feels about it.

Now the other way in which societies may conduct their business is the method of holding "conventions." The labor unions and the political

(Continued on page 82)



Battery-Operated Portable Transmitter

FIG. 1 is the circuit diagram of crystal-controlled portable transmitter used by Green Giebner, W4CPX, consisting of a crystal-controlled oscillator of the Tri-tet type modelled after the single-tube transmitter described in *QST* for March 1934. The circuit constants are similar to those specified in the article mentioned except that the screen voltage is obtained from a 50,000-ohm dropping resistor instead of from a

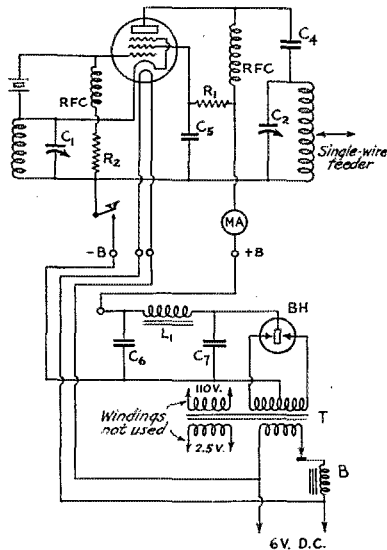

FIG. 1—CRYSTAL-CONTROLLED PORTABLE TRANSMITTER AND POWER SUPPLY

- C₁, C₂—100- μ fd. variable.
- C₄—.005 μ fd.
- C₅—.002 μ fd.
- C₆—8- μ fd. electrolytic.
- C₇—4- μ fd. electrolytic.
- L₁—30-henry, 50-ma. choke.
- T—Midget power transformer.
- B—Low-resistance buzzer or vibrator.

voltage divider. The constants are given under the figure except for the coil data, which will depend upon the crystal frequency. The tube may be either a 41 or 42. For portable work a single-wire fed Hertz antenna cut to the frequency of the crystal is used, the feeder being tapped on the plate coil approximately at its center.

Plate supply for the oscillator may be obtained

from an automobile radio "B" eliminator or from an arrangement of the sort diagrammed. This consists of a power transformer of the midget variety, furnishing a few hundred volts each side of the center-tap on the high-voltage winding, working into a Raytheon BH-type

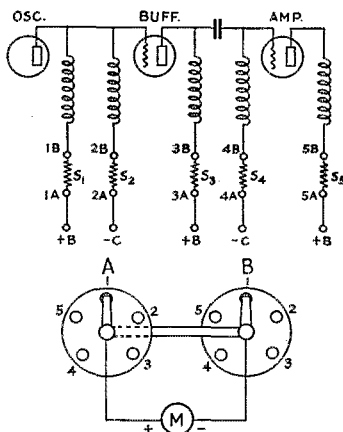

FIG. 2—METER-SWITCHING CIRCUIT

The meter shunts are part of each circuit to which the meter is connected. The numbers on the terminals of the shunts correspond to the numbers on the two multi-point switches A and B. A suggested arrangement for a three stage transmitter is shown; the system can be used for metering more or less circuits, of course.

gaseous rectifier and a brute-force filter. Direct current from the 6-volt storage battery is fed into the 5-volt transformer winding on the transformer through a low-resistance buzzer or vibrator. With the particular transformer used by W4CPX the current consumption from the battery was approximately 4 amperes and the output voltage about 275 volts d.c. under the transmitter load. The transformer was rated at 350 volts each side of the center tap.

Tuning instructions may be found in the article referred to above.

Another Way of Multi-Metering

Many of us are constantly looking for ways to get the most out of the game at the least expense. Here is one method of economizing that will detract in no way from the performance or appearance of the particular "heart's desire" we are working on at the moment. Most systems of using

one or two meters to do duty in several stages have disadvantages, such as being unsightly, cumbersome, or dangerous; the method described here, however, is inexpensive and allows fast meter QSY from one stage to another.

Fig. 2 is practically self-explanatory. A 0-1 ma. meter is connected between the rotor arms of two multi-point switches, the switches being ganged together but insulated from each other. Appropriate meter shunts, indicated by S_1, S_2 , etc., are left permanently across the indicated points of the two-deck multi-switch. Except when the meter is to be used for 10- or 20-mil ranges, the shunts will be of some value in the vicinity of 1 ohm or less; therefore it will be apparent that the shunts will not affect the performance of the set. In the event that a meter having a full-scale deflection of, say, 50 ma. is used in place of the indicated 0-1 milliammeter, the shunts would be of even lower ohmic resistance. In other words, use any meter at hand as long as the internal resistance is known—this in order that the external shunt may be calculated correctly. Some may say that the switch points will introduce errors, and this is true to a certain extent; however, the error is so small as to be unnoticeable for all practical purposes. Using a good meter, the error from this source will be less than is the case

RK-20 Keying Circuits

Two circuits for keying the suppressor of a transmitting pentode such as the RK-20, suggested by Herbert Hoover, Jr., W6ZH, are shown in Fig. 3. Both operate on much the same principle—that of cutting off plate current by means of negative bias on the suppressor grid—the first being for direct keying and the second keying through a small triode.

An auxiliary supply of about 400 volts, used both for control-grid and suppressor bias, is required. In circuit A with the key closed the suppressor is 45 volts positive with respect to the cathode, the positive voltage being obtained from a tap on the plate-supply bleeder. With the key open, however, the suppressor becomes 400 volts negative with respect to the cathode, the plate current being blocked off completely under these conditions. The 50,000-ohm resistor has no effect on the negative bias voltage, being in the circuit simply to limit the current flow through the key circuit when the key is closed.

In circuit B the positive suppressor potential is supplied through the plate-cathode circuit of a triode such as the 56. The cathode circuit of the 56 is completed through a 50,000-ohm resistor and the tap on the bias supply, the tap being adjusted to give plate-current cut-off on both the 56 and the RK-20 with the key open. When the key is closed, the grid potential of the 56 becomes positive, the plate resistance of the keyer tube drops to a low value and the voltage applied to the suppressor or the RK-20 is approximately 45 volts positive. The value of the resistance R in series with the key can be adjusted to give the necessary positive grid bias to the 56 under key-down conditions. It may not be needed at all, although some resistance at R will be helpful in preventing

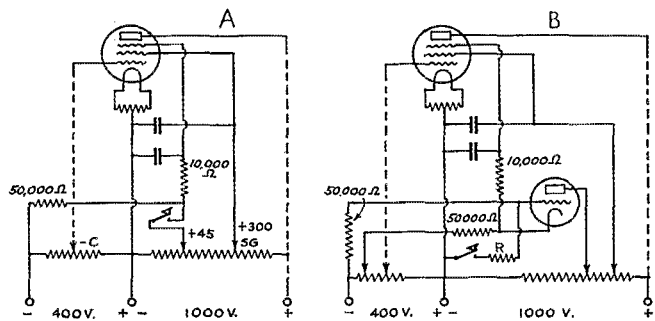

FIG. 3—SUPPRESSOR-KEYING CIRCUITS FOR TRANSMITTING PENTODES

where many of the bargain-type meters are used without shunts. I have been using the system for some time and have tried substituting a correctly-scaled meter for the shunted one, with no difference in results.

It is suggested that two meters be used, each with its separate switch, in order to obtain simultaneous grid and plate readings on one stage, or plate current in one stage and grid current in another. This will facilitate neutralizing. Remember that all grid meter connections should go to one switch, and all plate connections to the other.

—Henry T. Brummett, W6EKS

flow of grid current in the 56. The advantage of the tube-keying circuit is that the suppressor circuit is not interrupted by the key itself with the result that keying transients are reduced. The time-lag in the keying can be made almost any value desired by proper proportioning of resistors and condensers, since the keyed current is practically zero.

good enough insulation for low-power transmitters using 500 volts or less. For higher powers it would be desirable to make up special switches with plenty of insulation between contact points.

The formula for calculating the shunt resistance required is

$$R_s = \frac{R_m}{n-1}$$

where R_s is the required shunt resistance, R_m the meter resistance, and n the scale-multiplying factor desired.

EDITOR'S NOTE.—Two-gang multi-point switches of the type used for receiver coil switching would appear to have

Chirpless Keying With Pentodes

Fellows who have been having trouble with chirps in keying pentode-crystal oscillators should find a kink contributed by Roy H. Raguse, W6FKZ, of value. W6FKZ writes that his first attempt at keying a 47 oscillator brought plenty of chirps until he installed a voltage divider to supply voltage to the screen instead of using a simple dropping resistor. This required no change in the oscillator except the addition of a 50,000-

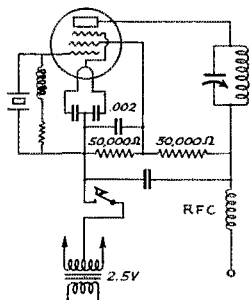

FIG. 4—PENTODE CRYSTAL OSCILLATOR CIRCUIT FOR CHIRPLESS KEYING

The important point is the use of a voltage divider instead of a series resistor for supplying screen voltage.

ohm resistor between the screen and negative B, as shown in Fig. 4. With the screen voltage tied down the chirps disappeared.

The value of the extra resistance needed does not seem to be critical, a 20,000-ohm resistance having been installed by the editor in an oscillator similarly afflicted with chirps without changing the output from that obtained with the ordinary 50,000-ohm series resistor. The voltage divider also cured the chirp.

Caliper Coupling

Many who are using link coupling between stages have found it a problem to vary the coupling when using the split-condenser circuit, with both ends of the coil "hot." A satisfactory solution has been found here by using a caliper-like

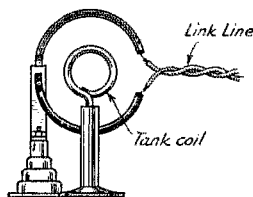

FIG. 5—A "CALIPER COUPLER" FOR GIVING VARIABLE COUPLING IN LINK CIRCUITS WITH BALANCED TANKS

coupling device supported by a standoff insulator at one side of the tank coil.

The coupling caliper consists of a single turn

of copper tubing sawn into two semi-circles and flattened at the joint to take a screw. Lock washers and double nuts are used to prevent the adjustment tension from loosening after repeated movements of the two halves. To this center joint a brass right angle is attached, being fastened by the same screw which holds the two halves of the coupler. The assembly in turn is mounted on top of the standoff insulator, as shown in Fig. 5. With plenty of excitation it is rarely necessary to have more than one turn of coupling between the plate of one stage and grid input coil of the stage following. It is possible that on low-power stages more turns will be needed to effect adequate transfer and this is best made in the form of a coil wound at the cold end of the tank coil. The adjustment is not critical, but too close coupling should be watched because of the detuning effect.

In the construction of the caliper coupling device it is wise to bond the two halves with a heavy, well-soldered flexible wire to prevent the possibility of high-resistance connections at the friction joint. The transmission line is best made of solid wire in preference to the stranded kind, and is soldered to the two ends of the caliper. The other end can terminate in a similar coupling device.

—W. H. Hannah, W2US

Harmonic Suppression

The following note from M. W. Mitchell, W9IQZ, offers a cure for a condition that is likely to cause the unknowing operator some embarrassment:

"While QSO with W9JZJ recently, I was asked to listen on 38 meters for his 75-meter 'phone

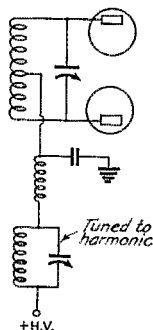

FIG. 6—WAVE TRAP IN PLATE SUPPLY LEAD TO ELIMINATE HARMONIC RADIATION

harmonic. We did and picked up the harmonic about R4 on loudspeaker. JZJ was quite worried and was wondering what to do about it when I remembered a stunt that is used in broadcast stations quite often, told to me by W9PLF some time ago. We tried it on this QSO and it eliminated the 38-meter harmonic completely.

"The thing consists merely of inserting a wavetrapp tuned to the undesired harmonic in series with the positive plate supply lead to the

(Continued on page 88)

● I. A. R. U. NEWS ●

Devoted to the interests and activities of the

INTERNATIONAL AMATEUR RADIO UNION

President: H. P. MAXIM

Vice-President: C. H. STEWART

Secretary: K. B. WARNER

Headquarters Society: THE AMERICAN RADIO RELAY LEAGUE, West Hartford, Conn.

MEMBER SOCIETIES

American Radio Relay League
Associazione Radiotecnica Italiana
Canadian Section, A.R.R.L.
Československí Amatérský Svaz
Deutscher Amateur Sende- und Empfangs-
Dienst
Experimenterende Danske Radioamatører
Irish Radio Transmitters Society
無線協會 日本 日本
Liga Colombiana de Radio Aficionados

Liga Mexicana de Radio Experimentadores
Nederlandsche Vereeniging voor Internationaal Radioamateurisme
Nederlandsch-Indische Vereeniging voor
Internationaal Radioamateurisme
New Zealand Association of Radio Transmitters
Norsk Radio Relæ Liga
Polski Związek Krotkofalowcow
Radio Society of Great Britain

Rede dos Emissores Portugueses
Reseau Belge
Reseau des Emetteurs Français
South African Radio Relay League
Suomen Radioamatöörlitto r.y.
Sveriges Sandareamatörer
Unión de Radioemisoros Españoles
Union Schweiz Kurzwellen Amateurs
Wireless Institute of Australia

Conducted by Clinton B. DeSoto

Anniversary:

Ten years ago this month the International Amateur Radio Union was formed. On April 14, 1925, the opening session of the First International Amateur Congress convened in the *Faculté des Sciences*, in Paris. From this meeting, in which there participated representatives of 23 nations,



ON4AU, THE FAMOUS STATION OF JACQUES MAHIEU, PERUWELZ, BELGIUM

At the right, above, is the push-pull 28-mc. rig with 700 watts input. Beneath is the 250-watt 3.5-mc. set, while to the left are two 750 watt Class A Heising modulators, the crystal exciter and doublers, and, at the top, a Marconi T250 used as the 14-mc. amplifier and a 503A on 7 mc. With the exception of these last two, the tubes are Philips, of the plain tungsten filament variety.

and the result of a year's previous effort on the part of an A.R.R.L. committee, there grew the Union which, with some modifications, we have to-day.

This month will see widespread international celebration of the anniversary. Perhaps the most

notable celebration of all will be that of the *Reseau des Emetteurs Français*. This society, existing in the very birthplace of the Union, to some extent founded through the Union, many of whose present members and officers were active in that first great Amateur Congress — this society has, indeed, the most fundamental cause for celebration.

We have been informed that a special commemorative issue of "Radio-REF" has been planned. An account of the history of amateur radio, the Union, and the part played by the R.E.F. will be included. It is known that many celebrated figures in the world of international radio have transmitted greetings upon the occasion, and these will be incorporated in the issue. The usual technical material which features the magazine will also be present.

Those amateurs interested in the historical development of amateur radio will find this current anniversary month, and its various manifestations, of interest.

Current:

Without warning, the Newfoundland government recently imposed on the amateurs of Newfoundland and Labrador a new set of regulations, establishing a district organization, and issuing new call signs. Formerly the prefix VO8 applied to all amateurs in this area. Now the Radio Branch of the Department of Posts and Telegraphs has established six districts, as follows:

District No. 1: All stations located in the City of St. John's within municipal limits.

District No. 2: All stations located outside of No. 1 and south of Lat. 49 and east of Long. 56.

District No. 3: All stations located north of Lat. 49 and east of Long. 56.

District No. 4: All stations located south of Lat. 49 and west of Long. 56.

District No. 5: All stations located north of Lat. 49 and west of Long. 56.

District No. 6: All stations located in Newfoundland Labrador.

Amateur radio is once again authorized in Peru. Quoting from the official order, "There having disappeared the reasons which determined the issuance of the Ministerial Resolution dated

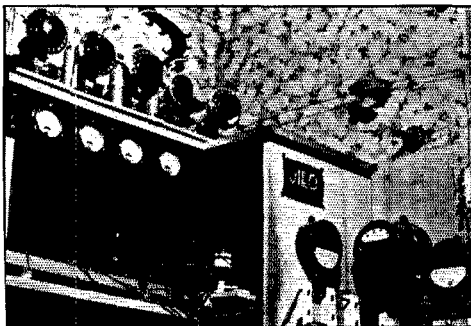

J2HN-J1EO, THE STATION OF SHIGEO SHIMA, APPOINTIVE DIRECTOR, J.A.R.L., 45 TAKAWANA MINAMICHO, SHIBAKU, TOKYO, JAPAN

November 29, 1934, which suspended the use of licenses granted by the Bureau of Radio for functioning of radio transmitting stations denominated 'Amateur' stations:

"It is hereby *Resolved*: to declare null the aforementioned Ministerial Resolution. Register and Publish. Henriod."

Officially there is no change in the amateur situation in Italy. Please note the comment under the QSL listing.

General:

The amateur world was shocked to learn of the death on February 19th of H. D. Price, G6HP, occasioned by electrocution when he accidentally got across the 2300-volt supply of an experimental television transmitter on which he was working His 14-mc. signal was one of the best known on the air; his fate should be a warning to many ON4AU worked W9TJ on 28 mc. and W3EVT, using a parabolic half-wave Zepp; now a rotary half-wave parabolic antenna and reflector system is in use, so many more DX contacts may be expected A new Manchurian (Manchuokuo) station is MX2B, owned by Takeshi Nagano, Nan Shan, He Hsi, Chieh, Pen Shi Hu, Peng Tien, Manchou Empire (Manchuokuo) It was W6AF who successfully got that mouthful through "Dad es mam are darned gld wid me. Hv three sissies, but tho nice girls, ND for ham operating! Pse stdbi fer me at the bug of dad — anno 1945,"

reads the unique birth announcement of PA0QQ, Jr., Fondest congrats, OM! The QRA of FB8C is: F. P. Bour, Faravohitra, Tananarive, Madagascar ON4UU is busy these days working on a 1-kw. rig for exhibition at the Brussels World's Fair, beginning this summer; the Reseau Belge is planning a large exhibit Two new 'phone WACs: First, W. F. Meyer, ZU6P, who has the first of these special certificates to be issued in South Africa. Second, Fred L. Mason, W5CCB, who joins the small group of American 'phone WACs.

QSL Bureaus:

Following is a list of the QSL Bureaus of the world. It is to these addresses that cards intended for the countries shown are to be sent. Corrections, additions, or deletions to or from this list will be welcomed.

- Algeria: See Morocco.
- Argentina: Radio Club del Argentina, Rividavia 2170, Buenos Aires.
- Australia: W.I.A. Federal QSL Bureau, George W. Luxon, VK5RX, 8 Brook St., Mitcham, South Australia.
- Austria: O.V.S.V., Willy Blaschek, Bahngasse 29, Klosterneuberg.
- Azores: See Portugal.
- Belgium: Reseau Belge, 312 Rue Royale, Brussels.
- Brazil: L.A.B.R.E., Caixa Postal 26, São Paulo.
- British West Indies: Ian C. Morgan, "Southlands," Warwick East, Bermuda.
- Canada: A.R.R.L., West Hartford, Conn. U. S. A.
- Ceylon: G. H. Joliffe, VS7GJ, Frocester, Govinna; or A. M. Rahim, "Rillington," Wellawatte, Colombo.
- Chile: Luis M. Desmaris, Casilla 761, Santiago de Chile.
- China: I.A.R.A.C., Box 685, Shanghai.



A GROUP OF SWISS DX MEN

Left to right: HB9AQ, winner, Swiss DX contest, 1934; HB9J, winner, for Switzerland, A.R.R.L. DX tests, 1934; HB9AO, holder of Swiss WAC record (8 hours, 37 minutes); HB9Y, perhaps the best European 3.5-mc. DX man.

- Colombia: L.C.R.A., Apartado 330, Bogota.
- Cuba: Pedro Madiedo, calle Santa Rosa, Buen Retiro, Marianao, Habana.
- Czechoslovakia: C.A.V., Post Box 69, Praha I.
- Denmark: E.D.R., Postbox 79, Copenhagen K.
- Dominican Republic: Bull Insular Line, San Domingo City.
- Dutch East Indies: N.I.V.I.R.A., J. M. van Heusden, Ir., Burg., Coopsweg 28, Bandoeng.
- England: R.S.G.B., 53 Victoria St., London, S. W. 1.
- Estonia: V. Suigusaar, Hobe t. 4, Pernau.
- Finland: S.R.A.L., Pohjola, Box 42, Helsinki.
- France: R.E.F., 17 Rue Mayet, Paris 6e.
- Germany: D.A.S.D., Schweinfurthstr. 78, Berlin-Dahlem.
- Guam: Foster D. Brunton, 62 Santa Cruz St., Agana.

(Continued on page 90)



Amateur Radio STATIONS

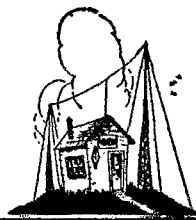

W8BQ, West Hazleton, Pa.

A DESCRIPTION of W8BQ is no new thing to the pages of *QST*, since Herb Walleze long ago acquired the habit of getting on the air and doing things. Although a great many old timers are back in the game again now after one or more lapses, few have been in the forefront continually. But through the spark days of the early post-war period, the c.w. transition, the early international

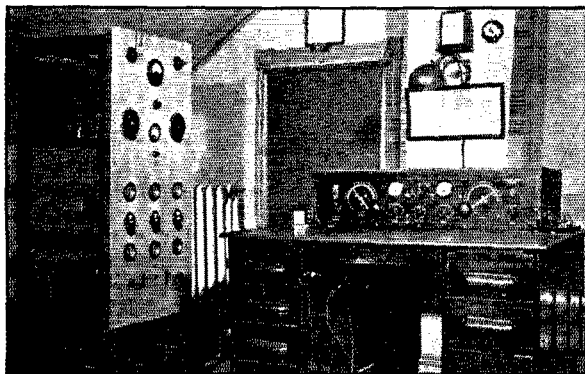

work, and up to the present when the amateur world is divided into spheres of activity which prevent close association of all groups, 8BQ has been a familiar sine. Herb's first attempt at ham radio took place in 1912, which subtracted from 1935 gives us a total of 23 years of it—not bad for a fellow who's now only 35. The call 8BQ was obtained in 1919.

The latest rig at W8BQ is just as different from the last which appeared in *QST* as that one was from the one preceding. It is interesting to note that the transmitter power considered necessary for good communication has been subject to considerable change during the time the station has been on the air. After retiring the kilowatt spark, c.w. equipment started out with 202's, larger tubes being installed until a 204-A peak was reached, after which the cycle has declined through 50 watters until now the output stage has but a pair of 10's. These are not permitted to take life too easy, however; the input is pushed up to a mere 200 watts at times! The complete line-up includes a 59 Tri-tet oscillator, a pair of 24's in push-pull as a buffer, and the 10's. Since the

transmitter has some interesting features it will be described in detail in this issue of *QST*. A 1000-volt m.g. set supplies the plate power for the 10's. The antenna is 110 feet long, supported by a 65-foot cedar pole, and is fed at the end. It is coupled to the transmitter through a filter network.

'Phone is used occasionally, the modulator being an 845 used Class-A and driven by a speech amplifier consisting of a 53 and 2A3.

Modulator bias is taken from the speech-amplifier power pack. There are no batteries in the station, leak bias being used on all r.f. stages, and even the keying relay getting its juice from one of the low-voltage plate supplies. The transmitter works on 160, 80, 40 and 20 meters.

The receiver which occupies the major portion of the operating desk is a home-made superhet built into an old Norden-Hauck cabinet. Its tuning range is from 15 to 1000 meters, with full-scale spread on all ham bands. A monitor is built into the same cabinet, its output being coupled to the grid of the last i.f. tube through a 10- μ fd. mica condenser. The monitor frequency is set so that its oscillations beat with those of the transmitter to give a difference equal to the intermediate frequency. With this arrangement the transmitter can be heard whenever the key is pressed, although the monitor itself does not interfere with reception. Naturally no switching is necessary. The transmitter control switch also is mounted on the receiver panel where it is handy.

Altogether a neat station, with none of the superfluities which characterize so many ham layouts. It kicks out, too, one of the latest DX QSO's being with HB9Y on the 80-meter band.

W9BEZ, Wichita, Kans.

W9BEZ, owned by William Obrist, of 1105 No. Custer Ave., Wichita, Kans., has been in operation since 1923. In the twelve-year period a great many transmitters and receivers have come and gone, naturally enough. The station has kept up with the times, however, and the equipment now in use is thoroughly modern.

The transmitter is a panel-and-frame affair having five shelves, each two by two feet, with those holding r.f. stages covered with metal sheet. The transmitter has four stages; the first is a 47 crystal oscillator, using both 80- and 40-meter crystals so that not more than one frequency-doubling stage is needed for work in the 80-, 40- and 20-meter bands. The oscillator is followed by a Type 10 tube used either as a straight buffer or doubler, depending upon the circumstances; this tube drives a pair of 10's in push-pull. The final stage, a pair of 203-A's in push-

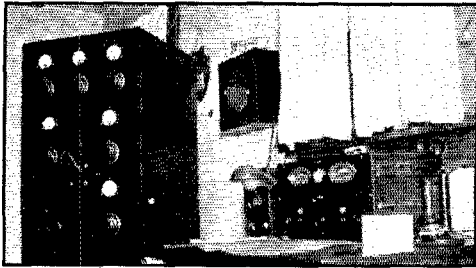

pull, is thus provided with plenty of excitation on all three bands, and its plate input can be run up to 500 watts if necessary. Power for the 203-A's is furnished by a 1000-1500-volt transformer and pair of 866's with the usual filter. A smaller supply using a home-made transformer and 83 rectifier delivers 600 volts for the three low-power stages, dropping resistors being used to cut down the voltage when necessary.

Phone work is handled by a Class-B modulator using a pair of Western-Electric 276-A tubes. These are driven by a speech amplifier consisting of a 57 first stage, 45 second stage, and a driver stage with a pair of 45's in push-pull. A double-button carbon microphone is used.

The antenna at W9BEZ is an 80-meter Zepp with 45-foot feeders, the flat-top being supported by two 40-foot telephone poles. The feeders are coupled to the transmitter through an antenna filter of the type described by Collins in a past issue of *QST*. W9BEZ's receiver is a Patterson PR-10.

Some 4000 contacts have been made in the time the station has been on the air, and W9BEZ seems to have specialized in "all-District" QSO's, having worked all call districts in the United States, Canada, Australia and New Zealand. Over 40 countries in all continents have been worked.

New Type Two-Terminal Oscillator

(Continued from page 47)

cent would probably remain nearly the same for tubes chosen at random.

In most applications, a figure of merit for a negative-resistance device of the class in

which the dynatron and the negative-transconductance method fall is given by $1/CR$, where C is the total effective shunt capacitance and R the negative resistance. On this basis, the 24-A's which have an effective capacitance of approximately $10 \mu\text{fd.}$ would have a figure of merit of 1.7. If it is assumed that more suitable plate material could be used, this figure might be increased to 5. In the 57 or 6C6 circuit, the tube contributes about $12 \mu\text{fd.}$ to the shunt capacitance, and the external coupling condenser and leak may be caused to contribute as little as $6 \mu\text{fd.}$ The figure of merit is then approximately 15, or three times as great as the best figure given for the dynatron.

Electron transit-time effects limit to approximately 20 megacycles the upper frequency at which the 57 or 6C6 will oscillate. This limitation makes it impracticable to use these tubes as oscillators in all-wave receivers at frequencies much above 15 megacycles. The negative-transconductance tube can, however, be used to advantage as a two-terminal oscillator in receivers, measuring devices, or other equipment in which the frequencies involved are lower than 15 megacycles. No tickler coils or taps are required for this type of oscillator. This is a feature which greatly simplifies the switching problem for apparatus employing more than a single frequency band, since but one switching terminal need be considered for each band; the other terminal can be connected permanently in the circuit.

Fig. 2 shows how the 57 or 6C6 can be connected for use in a voltage-controlled negative-resistance oscillator in conjunction with a tuned circuit. This arrangement will produce sinusoidal oscillations. Fig. 3 illustrates a relaxation-oscillation circuit using the 57 or 6C6 in a current-controlled circuit. For operation at small amplitudes, the oscillations are approximately sinusoidal.

Strays

Bogus QST Solicitor

A number of amateurs residing in the vicinity of Oneonta, N. Y., recently gave their money to Hal Mahoney (or Mahanay) supposing it was for group subscriptions to *QST*. That is the last they heard of it. This man has also been operating in Norfolk, Va. It is his racket to represent that he is taking *QST* subscriptions in "club" form in connection with the "Round Robin Club," which does not exist to our knowledge. If this man should approach you, please send us a collect telegram with such information as you can give.

Do not give your money to magazine subscription solicitors unless you know them or are absolutely sure of their credentials. Bogus solicitors are plying their racket all the time. Obviously we cannot make membership-subscription entries unless orders with proper remittances arrive.



OPERATING NEWS



Conducted by the Communications Department

F. E. Handy, Communications Manager

E. L. Battey, Asst. Communications Manager

THE census taker certainly must have his troubles. Last month we printed a questionnaire coupon to help us take a census of amateur band occupancy and amateur opinion. The returns, as we write this, have already reached 100-per-day proportions, with no signs of a let up in view. The tabulation and analysis of results are proceeding, day by day and Division by Division, and we hope by next month we shall have the details well in hand.

The purposes of the questionnaire were (1) that you might register on your use of amateur frequencies, and (2) that you might give your Director your opinion on the controversial subject of allocation of frequencies within the amateur bands for radiotelegraph and radiotelephone operation. Have you sent this information on your use of the bands to Hartford? Do you care how the frequencies are used? If so, you have spent the sum of one penny on a U. S. government postal card, which conveyed the information and your honest beliefs . . . and if you didn't? Then, in our opinion, you haven't any right to kick about the results, for the system of representation through your A.R.R.L. Director exists, but will not function unless you avail yourself of it. Like your ham station, or any machine, it will not function unless you operate the controls.

Which is all by way of saying that ours is a democratic form of A.R.R.L. government. The power is yours to advise your Directors, through this "census" of your use of amateur radio, so that they may know and be guided by the will of the majority. It isn't too late to refer to page 67 of March QST, and do your part to be represented. If you have overlooked this opportunity, we suggest you lose no time, but refer to that information, and DO IT NOW.

OTHER THINGS

Besides forwarding your questionnaire to Hartford you will undoubtedly be writing your Director personally between now and May, expressing your sentiment on all amateur radio problems that occur to you as important. On operating matters we have heard talk, both pro and con, about various means of reducing band congestion, and making our ham work more interesting and effective. If a cooperative scheme were approved by Directors, and all foreign amateurs requested to concentrate on a certain 50 or 100 kc. segment of the 7-mc. band, with U. S. A. stations agreeing to keep out of that segment, would or wouldn't operating in that band be more enjoyable for everybody? Would you cooperate? Would others? Is it practical? Does skip effect make it unnecessary and undesirable? Is it workable or unworkable? In some quarters it has been proposed that power on 160-meter 'phone should be limited to 50-watts to reduce BCL QRM complaints. One group proposed to prohibit the use of 'phone, even in the 56-mc. band until after one year of licensed activity. Some 80-meter 'phone operators believe a "stiffer" Class A would be a mighty good thing.

Many query why there is any excuse, in these days of crowded bands for any kind of amateur "music transmission" on the air for any purpose. It is reported that Class-A privileges are being abused, and said that to aid in monitoring those with this right, operating privileges should not go with the operator from station to station, but should be fixed in station licenses as formerly, after examination of the responsible amateur. Also the question

is raised, "What excuse for any but a licensed amateur operator being permitted to operate any amateur station?" A club sends us its resolution opposed to eliminating code examinations for work on 5 meters. This club also resolves that "mobile work should be permitted on all bands." Many general comments are to the effect that amateur radio is "too much regulated" now.

In all these proposals your Board has the nice job of finding out what is for the greatest good of the greatest number, what is practical and what is impractical, what you like and what you disapprove. Some proposals are wise; others silly. Which make amateur radio better? Which hurt amateur radio? All ideas must be studied in the light of their effects and your desires. Which should be thrown out, and which adopted? By all means we urge you to file your coupons—to register on your use of amateur radio. But don't stop there. After thought on these subjects, and others that occur to you write your personal representative on the Board of Directors and give him your thoughts and opinions. He will appreciate it—and you will be represented.

—F. E. H.

The following contribution by Mr. C. D. Perrine, Jr., wins C.D. article contest prize for this month. Your articles on any phase of amateur communication activity are likewise solicited and may win you a bound Handbook, six logs, or equivalent credit applied toward other A.R.R.L. supplies. Let us have your article, and mark it "for the C.D. Contest," please. —F. E. H.

DX Technique

By C. D. Perrine, Jr., W6CUH *

SOMEONE once said that the performance of a station is 90% dependent on the operator's skill—the station itself being responsible for only 10%. This statement is especially true in the matter of working DX. Every amateur has at some time or other sought this elusive goal, but after apparent failure has blamed the transmitter, location, or conditions when the DX was there all the time and could have been worked with a little application of "DX Technique."

Each operator will have to work out the details of his own technique (though some must have been born with it, hi), but there are several general rules that may be observed to great advantage. They are, in order of importance: "tis more blessed to receive than to give" (in this case at least), calling procedure, and judging DX.

You guessed it—the first point is less "CQ DX" and more listening. In general, foreigners are seldom in the habit of answering our CQ's—they know they can get several answers to one of their own, so why try to break through the barrier of QRM to a "W" who may not hear him in the end. Even so, "CQ DX" is useful; when one has considerable power and knows that only a few

* 527 23rd Street, Manhattan Beach, Calif.

"W" stations are breaking through to a particular region, such a CQ will be fruitful. Here may be mentioned a good cure for the "W" pest who dumbly answers one's "CQ DX" with something like "wi, ur DX fer me." A simple "NO USA" inserted just before the AR, coupled with a slow businesslike fist, will in almost every case send our pal on his way—and not in ours.

Even in the simple process of calling a DX station there are two points to be watched. The call itself should last 2-3 minutes, no matter what one's transmitting frequency may be, because nearly all foreigners cover the whole band after a CQ irrespective of the number of answers they may encounter—they evidently do this in order to choose the best DX, the strongest signal, or the newest country. It is obvious that if we only make a short call and our foreign friend returns to our signal because he likes it best, a good contact may be lost. A slow sending speed should be used, especially on 14 mc.; the characters should be solid and well spaced, because the rapid fading on extreme DX signals often makes the sending unintelligible by running it together—the "echo" and "hollow" effects.

Several things may be classed under DX judgment. The good DX man will be able to differentiate between "local" and DX signals by their character and "sound." This faculty can only be acquired by practice, but once attained is quite reliable. The immediate analysis of DX conditions at any one time is an aid to effective DX hunting; on the West Coast we use the signals from the English end of the transatlantic radiophone as an index to our chances of working Europe; as another example, we know that when Australians are audible there is little chance of Africa's coming through due to the limiting effect of skip.

In conclusion it may be said that patience is one of the best assets to successful DX; quite often we may hear a number of desirable DX signals all QSO, but it is often possible to raise several of them by watchful waiting—as a help to this last it is a good idea to jot down DX as it is heard, thus keeping track of the air. There are other minor points, but the above serves to show that DX is not entirely dependent on such important factors as a good note, conditions, and location.

On the Origin of 73

The December Bulletin from the Navy Department Office of the Chief of Naval Operations contains some extremely interesting information about "73."

The origin of "73" as the telegrapher's conventional signal of greeting has been ascribed to a dinner given to Andrew Carnegie on his 73rd birthday by the Order of Military Telegraphers. The dinner referred to was given on November 27, 1908, and the signal "73" was played upon in connection with his 73rd birthday. However, investigation indicates that the term "73" was used for many years prior to that time.

The following material, believed to be authentic, is quoted from the "Telegraph and Telephone Age," dated 1 June, 1934:

"It appears from a research of telegraph histories that in 1859 the telegraph people held a convention, and one of its features was a discussion as to the saving of 'line time.' A committee was appointed to devise a code to reduce standard expressions to symbols or figures. This committee worked out a figure code, from figure 1 to 92. Most of these figure symbols became obsolescent, but a few remain to this date, such as 4, which means 'Where shall I go ahead?' Figure 9 means 'wire,' the wire chief being on the wire and that everyone should close their keys. Symbol 13 means 'I don't understand'; 22 is 'love and a kiss'; 30 means 'good night' or 'the end.' The symbol most often used now is 73, which means 'my compliments,' and 92 is for the word 'deliver.' The other figures in between the foregoing have fallen into almost complete disuse."

Mr. J. L. Bishop, Chief Telegrapher of the Navy Department Communication Office, quotes from memory the signals that were in effect in 1905:

- 1 Wait a minute.
- 4 Where shall I start in message?
- 5 Have you anything for me?
- 9 Attention, or clear the wire (used by wire chiefs and train dispatchers).
- 13 I do not understand.
- 22 Love and kisses.
- 25 Busy on another circuit.
- 30 Finished, the end (VA) (Used mostly by press telegraphers to denote the end of a story or closing out).
- 73 My compliments, or Best regards.
- 92 Deliver.

Emergencies

Maryland-Delaware-Virginia

On January 23rd the eastern shore of Maryland, Delaware and Virginia was visited by the most severe sleet storm of the past twenty years. Practically all wires, poles and lines of telephone and power companies went down under the heavy sleet covering the lines. All telegraph lines were out of service and all means of communication with the outside were cut off, causing the eastern shore to be left without means of communication other than Amateur Radio. At 5:30 p.m., January 23rd, station N3VJ, Salisbury, Md., went off the air and contacted Naval Reserve District Control Station NDK at Norfolk, Va. During this contact conditions were explained and messages handled for several hours. Later on that night contact was established with W3SN, of Baltimore, Md., the Third Army Corps Area Control Station for the A.A.R.S., as practically all traffic of an emergency nature was directed to Baltimore from the C. and P. Telephone Co. and others. W3SN also had both Western Union and Postal Telegraph connections in the same room with them, making it easy to place telegraph messages on proper routes with speed. NDK, standing by all the time, furnished us an outlet for traffic in southern directions. The Naval Reserve station NDK of Norfolk, Va., standing a 24-hour day watch with us for four days deserves great credit for the work performed and much credit must be given to the operators there. They were all Naval Reserve men and gladly stood by during the entire period of emergency work lasting four days. The operators on duty at NDK were: W3NT, W3BWA, W3DEW, W3EWP. W3EWP also operated from his own station while not on duty at NDK. W3AUG of Portsmouth, Va., stood watch and took traffic. Many contacts were made and messages handled by many amateur stations. The stations handling the bulk of the traffic were NDK of Norfolk, Va., W3SN of Baltimore, Md., W3UX of Berwyn, Penna., and W3CII, A.A.R.S., of Arden, Del. The stations with whom W3VJ handled traffic were W3EWP, W3AUG, W3BTQ, W3BEZ, W3HC and W3ELZ, W2AVS and W3CRO on 3.9-mc. 'phone co-operated with W3UX. Much credit must be given to the operators of station W3SN of Baltimore for their untiring watch with N3VJ for four days and handling hundreds of messages by them for press, telegraph companies, and many others. The operators at W3SN were Robert N. Fox, Roy Morrison, Robert Knerr and Lt. H. O. Bixby.

Traffic was handled out of Salisbury as well as that coming in for the local papers. Press was handled for the *Baltimore News*, the *Baltimore Sun*, the *Washington Post* and many others. Traffic was handled for the Maryland State Roads Commission, Red Star Bus Lines, Victor Lynn Transportation Co., the Eastern Shore Public Service Co. of Salisbury, the Maryland State Police, Virginia Public Service Co., Postal Telegraph Co., the Telephone Company and Western Union Tel. Co. Weather reports were sent out at frequent intervals. N3VJ was operated by its owner, N3CQS, all of Salisbury, Md. N3DEL was of great assistance in furnishing a telephone right on the operating table. Much credit must be given to W3CQS for handling the bulk of the traffic. Many messages were handled for people anxious for word from friends and the like. Communication was maintained and held from Jan. 23rd to Jan. 27th with about two hundred messages being handled.

It was a job well done. N3VJ says, "We of the naval reserve appreciate the chance to show that the reserve is on

the job when needed and hope we have assisted in a time of need." Thanks to N3VJ for the foregoing report.

The Delaware A.A.R.S. Net was on the job throughout this emergency. W3AIW relayed an emergency message from an airport in the west to W3ZI. Many amateurs in nearby eastern states stood by to assist the Eastern Shore gang as needed. W3CXI, A.A.R.S. Control Station, sent out frequent requests for amateurs to avoid QRM with emergency work.

In the same storm of January 22nd-23rd, the city of Lewes, Del., was also isolated. From the 23rd until the 28th, W3DTO, O.R.S. of that city, handled all Western Union and press dispatches, and for the first two days all government weather and maritime traffic from the Delaware Breakwater Maritime Exchange. W3DTO maintained schedules with W3DUK, O.R.S., and W3EGN, both of Wilmington. Most all traffic was handled with these stations, with some going through W3AEJ, O.R.S., and W3DQG. W3DTO worked on 3540 kc.

Mississippi Flood

Members of the A.A.R.S. were on the job during the flood disaster in the states of Arkansas, Tennessee and Mississippi about January 21st. W4AEP, Memphis, Tenn., was outstanding, handling a number of Red Cross emergency messages pertaining to supplies and relief work until other reliable communication could be established. W4IR, Atlanta, Ga., and W4AEP maintained daily schedules. W4AFM also scheduled W4AEP. W4KV, W4RO and W4BBT were always ready to help, if needed.

More on British Columbia Emergency

VE5FU, Vancouver, on 1.75-mc. 'phone maintained schedule with VE5II, New Westminster, taking traffic for the Great Northern Railway and forwarding it to Seattle. VE5JB, Vancouver, kept a contact with VE5AR, Kamloops and handled railway traffic. VE5GU, Vancouver, contacted VE5BW, Kelowna and handled telegrams for the C.P.R. Meanwhile on 7 mc. VE5HC, VE5EU, VE5GF, VE5EP, continued their good work. VE5JB maintained schedule with W7RY, Seattle, handling much important traffic. W7BKC cooperated in this.

Thursday, January 24th, was a repetition of Wednesday with traffic getting heavier. The need for double operators was urgent. VE5JB, who had pressed the XYI into service on Wednesday, found need of more help and VE5BP was secured. VE5DZ came to the aid of VE5AC; VE5FM and VE5KU doubled up. The C.P.R. sent messengers out to various stations to handle telephone calls. VE5JB handled messages from the Dollar Steamship lines to passengers on snowbound trains at North Bend, B. C., via VE5AR at Kamloops. VE5AS, VE5FN; VE5FU continued their fine work on 1.75 mc. handling scores of important telegrams and urgent messages. VE5JB handled considerable traffic throughout Thursday with W7DJD, Portland, Ore., W7RY and W7CMJ.

Friday at 8 a.m. VE5AC contacted VE5ER, a 'phone station in Chilliwack, B. C. Chilliwack had been completely isolated, without trains, communication or electric power since Monday. VE5ER had moved his station to the Telephone Company's office and had pressed a motor-driven generator into service. VE5AC's contact with VE5ER was turned over to VE5JB, as VE5ER is a 'phone station and the 'phone company officials wanted to hook up via 'phone with Vancouver. VE5JB took over the contact at 9.00 a.m. Three special telephones were put into his home and a mass of traffic handled—press dispatches and requests for help from the flooded valley. At Chilliwack some four feet of snow had fallen, and with four days of rain the whole lower Fraser Valley had become virtually a lake two to six feet deep. Land slides had caused several deaths and help was badly needed. VE5JB worked all day and on into the night relaying via some of the southern stations back to VE5ER. VE5KX and VE5BP assisted at VE5JB.

Saturday, January 26th, the railways were gradually overcoming the slides and washouts, but there was still plenty of work for the hams. VE5JB and VE5ER had a very busy day; VE5FM contacted VE5BU at Enderby; VE5GU and

VE5BW kept up their contact; VE5HW contacted VE5AC and sent urgent personal traffic to relatives. From New Westminster came a report of VE5HJ maintaining southern contacts with W7AYL and interior contacts with VE5AX at Kamloops and VE5BU at Vernon. He was assisted by VE5IA. At night the 1.75-mc. boys continued their fine work. VE5EK operated commercial broadcast station CFJC at Kamloops. The BC station had been put down onto 1.75 mc. after the evening's programs and had maintained contact with Vancouver through VE5KN, VE5DC, VE5DO, VE5FN and VE5AS. Sometime Saturday lines were put through to the south, relieving the hams from the pressure of traffic in that direction.

Sunday, railway conditions were a little better. A telegraph line was finally put through to Kamloops and the movement of trains was expected within a couple of days. Amateur stations were gradually dropping out of the picture or turning to personal traffic, although some important messages were still handled. VE5JB and VE5ER cleared traffic held over from the previous night.

Monday, January 28th, brought a cessation of amateur activities in the emergency and all took a well-earned rest. Besides the stations who took active part in the emergency, great credit is due those stations who stood by and helped out by keeping the frequencies of active stations clear of interference. VE5EF is to be especially commended in this connection.

QRR traffic was handled by dozens of amateur stations through British Columbia, Alberta and the Northwest states. A few of the stations cooperating, which were contacted by VE5JB: W7RY, W7EBK, W7DJD, W7DYK, W7BKC, W7AO, W6CBR, W6RP, W6ATR, VE4NC, VE5AR, VE5OI, VE5DO, VE5HW, VE5KT, VE5FT, VE5BY, VE5DW, VE9CY, VE5BR, VE5JN, VE5FZ. The following Vancouver stations were on the job: VE5AC AS FN BP EF KU BC JU JF CU ML HC DS BK CE BJ JO VE9BK. Credit is particularly due Reg. Town, VE5AC, A.R.R.L. S.C.M., for the efficient routing of messages through organized traffic channels throughout the province. 1.75-mc. 'phone played an important part in the emergency, credit being due the following for a major part in the assistance rendered: VE5BY, VE5BR, VE5AS, VE5FN. On 3.5-mc. 'phone VE5JB, VE5ER, VE5JF, VE9BK, VE5BJ, VE5CE, VE5EF, VE5BY, VE5BR, VE5DW, VE9CY and VE5CI all put in effective work. VE5ER, Chilliwack, performed a real public service by installing his 'phone in the telephone building, thus facilitating the movement of traffic. At VE5JB over 300 messages of telegraphic importance were handled during the emergency, including several long press reports. Other stations furnishing valuable cooperation, not mentioned in the above account: VE5AX, VE5AK, VE5HD, VE5JP. Splendid cooperation was given by the VE4's who stood by to avoid QRM. VE4DC, VE4ID, VE4GA and VE4OF were prominent in keeping the air clear of unnecessary QRM. VE5HC and VE5FG were still trying to get planes in to the marooned mercy plane.

The January storm in Vancouver, B. C., was at its height; rain was coming down in torrents. The vicinity of Elgin Street (where VE5ED lives) was pretty well flooded as VE5ED, feet perched on a chair in an effort to keep from being submerged in the rising waters, coughed into the mike of his 1.75-mc. 'phone, "QRR VE5ED calling VE5EO, please answer on 40 meters." At last his efforts were rewarded, for VE5ND (5EO's brother) heard him and replied. VE5ED said, "We have nothing for supper. Ask George (5EO) to send down two cans of beans and one can of soup." VE5ND gave an OK. A little later VE5EO, garbed in voluminous hip gumboots and with three tins tucked under one arm, cranked the ancient Ford, scrambled aboard and screeched madly to the rescue. With squealing brakes, and amid a shower of flying water, he drew up on Elgin Street, grabbed the precious tins and sloshed towards VE5ED's. There ED awaited ankle-deep in muddy water. Passing over the tins, VE5EO gasped, "The beans must get through, ham radio wins again!"—VE5EU in the Amachever, B. C., Section paper.

Several Alberta amateurs assisted in the actual handling of emergency messages. VE4LX, O.R.S. at Calgary, handled about 175 emergency messages, dispatching relief crews, snow plows, aeroplanes with food, etc. VE4HM, O.P.S. at Edmonton, also handled a quantity of emergency dispatches. Details on work done by other VE4's are expected later.

The January storm was not the first opportunity British Columbia amateurs had had to demonstrate amateur radio as a means for emergency communication. A snow storm on Christmas day put out nearly all telephone and telegraph wires on Vancouver Island and many places on the mainland. For three days the bulk of communication services over a large part of Vancouver Island were given by amateur radio. Amateurs coöperating in this emergency were VE5BR, VE5BY, VE5DP, VE5JA, VE5BL, VE5FN, VE5BK, VE5EU and VE4DC.

Northern New Jersey Section QSO Party

Date: Two week-ends; April 26th, 27th, 28th and May 3rd, 4th, 5th. Contest starts the Friday of each week-end at 6 p.m. and ends the Sunday of each week-end at midnight E.S.T.

Qualifications: Only stations located in the Northern New Jersey Section of the Hudson Division who send in copies of their logs with final score are eligible for prizes.

Object: To work and get acquainted with as many other Northern New Jersey stations as possible during the contest; contacts outside the section do not count in the scoring.

Scoring: Three points may be counted for each different N. N. J. station worked. Each additional N. N. J. station heard but not worked may be counted one point. Total score to be multiplied by the number of different towns worked.

Power: Each station making contact with other stations and not using more than fifty watts may multiply the score by two.

Call procedure: CQ NNJ DE W2. . . . This procedure should be used by all stations in contest to be sure you are contacting a station in the section and to let others know you are in the contest.

Frequency: Any frequency may be used. Phone or c.w. may be used.

Prizes: Prizes are being donated by radio dealers. All donors have not been heard from. It is expected that there will be more than ten prizes, including two 3.5-mc. crystals (any frequency desired) donated by W2BCX and W2GNK, a bound copy of the Radio Amateur's Handbook, and three message files.

Turn in scores: At the conclusion of the contest, May 5th, tabulate results, listing stations worked and heard with the time worked or heard, and forward to your S.C.M.

Official Relay Station Doings

A large number of new and active station operators have qualified for O.R.S. appointment lately. Also a number of stations have been dropped because of inactivity, failure to live up to the precepts for which the appointment stands, etc. Suffice it to say that high standards, as ever, are going to remain in force for O.R.S. appointment. While there is some tendency toward regular increases in the number of O.R.S., such change in size of our group will only be permitted if really qualified candidates meeting the rigid requirements of "good operating," and consistent activity on the air and in traffic work continue to come forward.

A quota system has been discussed for both the O.R.S. and O.P.S. appointments, and is now under consideration by your Section Communications Managers. This bases the number of O.R.S. and O.P.S. appointments on a fixed percentage of the membership of each Section. In 43 of the League's 69 Sections some additional O.R.S. are desired, to build these Sections out to quota strength. In 26 Sec-

tions, O.R.S. organization is already "over quota." No harm in putting your application in to the S.C.M. if interested, but there is the possibility that, unless you can show exceptional qualifications in the line of a good traffic record, or unless yours is a transfer from some other Section, that your S.C.M. may ask you to wait for the next "vacancy" to occur.

At any rate, all interested hams are invited to drop a line to A.R.R.L. Headquarters or direct to your S.C.M. (address page 5, *QST*) for details on this appointment.

The following newly appointed O.R.S. are welcomed into the band of "reliables." Add them to your O.R.S. roster:

W1GME	W2HCP	W5AUC	W7DZX	W9DEJ
W1HSX	W2BPJ	W5DB	W7AHS	W9HSQ
W1DDK	W2FPU	W5CPV	W7EFP	W9PAH
	W2DPA	W5ASD	W8MCR	W9KEI
W1EOB	W3DZF	W5ABL	W8NQ	W9DIC
W1HJI	W3DQO	W5RH	W8IET	W9RYD
W1EAL	W3CYI	W5BXA	W8LOQ	W9SDC
W1IBM	W3ETX	W5EEW	W8KXT	W9SQY
W1DDY	W3UVA	W5EMS	W8PPT	W9DPD
W1DCH	W4BDT	W5DAQ	W8ABH	W9NNM
W1AMZ	W4CPS	W5DRW	W8FCL	W9PVZ
W1BMW	W4COV	W5CGJ	W8INT	W9BYV
W1DHX	W4BRK	W5BNT	W8DSQ	W9STT
W1GOG	W4BBV	W5DLG	W8FIY	W9FYY
W1HNP	W4COB	W5ENI	W8MQO	W9POB
W2GFW	W4AYU	W5DRY	W8JFZ	W9NGG
W2GOQ	W4CYR	W6AHI	W8CDK	W9NIU
W2GGE	W4DIO	W6KGO	W8MHE	W9OJJ
W2GWJ	W4XCX	W6YGO	W8IHN	W9RQE
W2HJK	W4AYE	W6LLW	W8MCL	W9OAK
W2AHC	W4CTZ	W6HDV	W8EJU	VE2CX
W2BYL	W4CZA	W7DBT	W8INR	VE3RO
W2FPU	W5DXT	W7EMT	W9PAZ	VE4QK
W2HCM	W5AAJ	W7BRT	W9EVI	
W2HHY				

MORE ON JANUARY O.R.S. PARTY

The record breaking January O.R.S. contest was reported in some detail, page 68 March *QST*. The O.R.S. Trophy, won by W9MN was mentioned, and the special milliammeter prize to W5BML. All Section scores have now been examined and we hasten to report who got the special prizes given by the SCM Virginia and W8FQB to the "high" stations in Virginia and in West Virginia, respectively. Here's that information: Va. Model 321 milliammeter won by W3EBD (Score 4960, QSOs 35, Secs. 26, Hrd. 83) W. Va. W8FQB Crystal Donation won by W8KKG (Score 20,514, QSOs 105, Secs. 39, Hrd. 81).

Inadvertently omitted from the list of outstandingly excellent scores presented last month, please note the FB results of Director Adams (Alabama) of the Southeastern Division: W4APU 95 QSOs in 39 Sections (71 heard) Score: 18, 564.

Speaking of the January Party, W9KXE's comment was quite typical, "Enjoyed the contest much. ORS sure are a fine bunch of ops, and every contact really FB. Glad to meet as many of the boys and wish I could QSO them all." Another one, W9STG, "Never had a more enjoyable week end in my life. The snappy QSOs, fast working break in, good DX, and chummy work with real fast operators made it the two best days I ever experienced on the air." "ORS were thicker than bees around a bee-hive." Conditions were excellent in January. We hope they will be as good for our April Party.

"The ORS are the swellest bunch of fellows I've ever met either personally or by QSO. I hope to be able to keep contacting as long as possible and as much as possible. Look over any amateur band some day and you will find that best operator will sign ORS."

April 27th and 28th Next O.R.S. Party Date

Special Prizes: The W9AUH-Trophy Cup will be given permanently to any O.R.S. winning it three times. W9KJY and W9MN are the two calls inscribed on it so far. Visit W9MN . . . or see page 55, December *QST*, if you have

missed an eyeful of this beautiful Trophy. Donated by Kentucky's S.C.M., W9MN brought it back to Kentucky . . . but don't think there aren't a lot of fellows making certain plans. This is an operator's cup . . . *par excellence*. What if you shouldn't win? Anyway, nobody can prevent you from having a swell time, and dozens of contacts all over, in an O.R.S. Party.

Again we have a fine piece of apparatus, as another prize. Nat Pomeranz, W2WK, offers a *50-watt Powerack*, to be shipped to the winner by him. Anyone who makes second-high score is eligible for this prize. Whoever wins this will have a fine power supply for running portable 110 v. a.c. equipment in the field during the coming A.R.R.L. June Field Day—and will be well prepared for emergency work afield as every O.R.S., and every ham should be! So, if you miss the cup or need extra incentive, think of this fine prize. W5BMI operated only 17 hours of the January party, and won the apparatus prize for second-high score in January.

Rules for the scoring in the April 27/28 O.R.S. doings will be the same as for the January Party. However, the starting and ending time will be changed to read as follows:

Start: 3 p.m. P.S.T., 4 p.m. M.S.T., 5 p.m. C.S.T. or 6 p.m. E.S.T. April 27.

End: 12:01 a.m. P.S.T., 1:01 a.m. M.S.T., 2:01 a.m. C.S.T., 3:01 a.m. E.S.T. April 29 O.R.S. appointees will receive further details on 7 m.c. and 3.5 m.c. periods, progress of the "Police Net" plan, and other traffic data, with the quarterly (April) Bulletin.

With the O.P.S.

A.R.R.L. Official Phone Stations constituting a nationwide 'phone operating organization number close to 200 at the present writing. Each period of activities has shown increases in the group and new operating records.

The activities for both O.R.S. and O.P.S. are designed to create an opportunity to (1) test station performance, and (2) make new friendships and QSOs. As shown in last QST, the leading scores were "doubled" in the January activities.

April 27th and 28th has been set as the dates of the next Official Phone Station get together. The rules have been changed so the starting time is just the same time, all over the country—3 p.m. P.S.T., 4 p.m. M.S.T., 5 p.m. C.S.T. or 6 p.m. E.S.T. (April 27) and the O.P.S. Party closes at 12:01 a.m. P.S.T., 1:01 a.m. M.S.T., 2:01 a.m. C.S.T. or 3:01 a.m. E.S.T. (April 29). The usual details will be sent all appointees in the April O.P.S. Bulletin. O.P.S.! Don't miss the April Party!

We welcome the following recent O.P.S. appointees:

W1ANS	W1AVP	W4CXB	W5EDR	W9ATS
W1QV	W1BJP	W4CLB	W8LUQ	W9AA
W1AXL	W2GOW	W6BOW	W8LYL	W9NHF
W1BES	W2ECO	W7FL	W8CJP	VE3AZ
W1EFC	W2AVS	W8JFC	W9KQX	
W1FJP	W4ASR	W8HMS	W9EDP	

DX Notes

3500 kc.

From W8EUY (via W9FM) a very fine list of frequencies used by various European and other DX stations on the 3500-kc. band has been received: G6RB 3585, HB9Y 3585 and 3595, D4BAR 3500 (or little lower), D4BMJ 3496, OE7JH 3555, ON4AU 3500, F8VS 3590, PA0DC 3725, PA0ASD 3560, VO8HK 3570, VO8Y 3570, ON4JB 3530, HB9AQ 3525, G2ZW 3560, F8GI 3530 ..

3.9-mc. 'Phone

Trans-Atlantic 3.9-mc. 'phone contacts are being reported lately .. On February 24th at 7:10 p.m., E.S.T., W1EF, Stonington, Maine, worked G5VL .. He reported QSA5 R7 on i.s. .. G5VL's signals were same strength .. G5VL's frequency is reported as 3719 kc. .. Each evening at 2300 Greenwich, VE1EI works G5VL on schedule .. contact lasts for about one hour, after

which time VE1EI acts as a "go-between" to help G5VL contact United States 'phones .. W1EF wonders if his is the first Maine-England contact on 3.9-mc. 'phone ..

1.75 mc.

W5MS reports what he says is believed to be the first two-way QSO with Hawaii and Venezuela from the fifth district on 1.75-mc. 'phone .. this took place during the morning of February 14th between W5DVK, Portland, Texas, on 1.75 mc., K6CMC and K6LQL on 3.9 mc. .. reliable communication was also established between W5DVK and Senor Gomez, Venezuela .. During December W1DIK, Rumford, R. I., was heard on 1.75 mc. by G5BI and BRS1422 .. S.C.M. W4BCZ writes as follows: "On Nov. 18th W4CPG was heard QSA4 R5 in Japan on 160-mx 'phone, and has the card to prove it!" W8ASI, Buckhannon, W. Va., is on the look-out for 1.75-mc. trans-Atlantic calls each night from 7:00 p.m. to 3:00 a.m., E.S.T.

14 mc., and General News

VE5LD is located at a place where one really appreciates amateur radio .. his QRA is Tuk-Tak-Yak-Tuk, near Aklavik, Northwest Territory. The operator is Graham Sturrock, ex-VE4JR. Mail arrives only twice yearly .. W2BSR, on February 12th, had the good fortune to work Australia, South Africa and Japan within three hours .. this was on 14 mc. in the late afternoon .. stations worked were VK4GK, 3:11 p.m.; ZS6AL, 4:43 p.m.; J2HG, 6:07 p.m., all E.S.T. .. W3EYV worked EA4AV on 14 mc., March 1st, at 8:00 p.m., E.S.T. .. this represents total darkness all the way .. W9FM worked VK3MR at 4:40 p.m., C.S.T., February 9th, on 14 mc. .. And on March 4th he worked a VK4 on 14 mc. at 7:20 a.m. .. he worked "both ways around" on 14 mc. in two weeks .. W1EWD heard PK2DX on 14,100 kc. calling CQ PA at 8:15 a.m., E.S.T., February 24th .. W8AKX was QSO VQ4CRP, Kenya, on 14 mc. during the afternoon of February 19th .. VQ4CRP's frequency is reported as about 14,325 kc. .. he has worked all W districts and VE1, 2, 3 and 4 .. he is particularly anxious to contact a VE5 to complete an "all district" record .. W1QV has worked D4CAF on 14, 7 and 3.5 mcs. .. WANTED: some definite dope on the elusive VU2CP .. he has been worked by W3ANH, W1HE, W1LZ, W1ZI, W1GF and others (about 14,125 kc.), but no confirmation has been received by any of these stations .. the lads wonder if it is the authentic VU2CP they are working.

W1INF—HQ's 'Phone

The A.R.R.L. Headquarters Operators Club reports its station, W1INF, now active on the air on 14,198-kc. 'phone. W1INF is located at the headquarters offices and is operated by all members of the staff. A number of splendid contacts have been made. Plans are being formed to make possible the maximum number of operating hours for W1INF; regular "shifts" will be lined up for the various operators. Calls are welcomed from all amateurs. What say, gang?

The Thursday Morning Club

A group of 3.9-mc. 'phone operators have organized the "Thursday Morning Club," which specializes in DX —and how! The members of this group work a surprising amount of DX each Thursday morning. "Meeting" starts at 12:01 a.m., P.S.T., with W6HXP as Master of Ceremonies. Among the members of the club are W5MS, VE5BY, K6CMC, H17G, H16C, K6LQL, W7AO, W9NNO, W9BXC, W9JDO, K6FJF, H16F, H17F and TI2RC.

O.B.S.

The following is a supplement to the list of A.R.R.L. Official Broadcasting Stations in October QST (page 49): W1FFL, W2FPU, W2MY, W3AOT, W3EZZ, W6ZX, W9SVH, VE2EE.

BRASS POUNDERS' LEAGUE

(Jan. 16th-Feb. 15th)

Call	Orig.	Del.	Rel.	Total
WJTT	166	60	1186	1412
W9PIG	88	139	1104	1331
W9LFI	13	71	1198	1282
W8BMC	4	36	1204	1234
W6ETL	188	221	808	1217
W3ADM	47	37	1132	1216
W5CEZ	132	116	938	1186
W3OK	290	54	798	1132
W9RYD	56	920	134	1110
W2BCX	70	145	872	1087
W5MN	32	143	836	1011
W8GUF	84	97	826	1007
W8KWA	69	81	826	976
W9KJY	126	230	612	968
OMITB	349	108	494	921
W3BND	143	83	662	888
W3ANT	127	331	394	852
W9ESA	51	111	680	842
W2DQH	49	35	660	744
W3AKB	41	66	578	685
W5BMT	63	71	541	675
W2BGO	512	88	64	664
W8ADY	51	81	514	646
W9IQI	120	109	386	615
W9RIZ	68	64	478	610
W8DYC	15	35	558	606
OMZBX	95	39	442	506
W9PVZ	90	51	454	595
W2EGF	45	48	489	582
W3BWT	135	108	338	581
W9BMM	5	38	508	554
W3DSS	38	28	486	522
W6JSG	17	502	22	541
W7WY	28	32	480	540
W9EFK*	267	260	12	539
W9OQV	174	80	294	538
W9MZF	51	22	478	531
KALLG	264	251	47	525
W3EZ	66	78	378	522
K6DV	155	342	23	520
W9HFW	182	74	264	520
W2LU	34	49	426	509
W3ECD	31	19	468	308
W8FLA	40	47	416	503

MORE-THAN-ONE-OPERATOR STATIONS

W6ZG	623	1660	219	502
W3SN	627	324	1174	2125
KATHR	436	366	666	1468
W3CNL	148	91	914	1153
W5OW	113	391	45	549
W4NC	367	52	105	524

These stations "make" the B.P.L. with totals of 500 or over. Many "rate" extra credit for one hundred or more deliveries. The following one-operator stations make the B.P.L. for delivering 100 or more messages; the number of deliveries is as follows: Deliveries count

W6CXX, 286	W6HJP, 143	W3CMS, 101
W7BB, 199	W6LBE, 130	W5FES, 106
KALSK, 186	W1MFC, 113	FALCS, 100
W6IMI, 167	W6FQU, 115	More-than-one
W8KMC, 164	W3ETX, 114	VEJJB, 122
	W2FQG, 112	

A.A.R.S. STATIONS

Call	Orig.	Del.	Rel.	Total
WLMG (W2BZZ)	42	40	1208	1290
WLR (W4KV)	35	45	684	764
WLNF (W2BCX)	51	75	471	597
WLMF (W9RYD)**	56	212	20	288

MORE-THAN-ONE-OPERATOR STATIONS

WLM (W3CXL)	409	263	2913	3585
WLV (W5OW)	208	102	1130	1440
WLV (W6ZG)	128	318	197	643

A total of 500 or more, or just 100 or more deliveries will put you in line for a place in the B.P.L.

* Dec.-Jan.

** B.P.L. rating on deliveries.

ELECTION NOTICES

To all A.R.R.L. Members residing in the Sections listed below: (The list gives the Sections, closing date for receipt of nominating petitions for Section Manager, the name of the present incumbent and the date of expiration of his term of office.) This notice supersedes previous notices.

In cases where no valid nominating petitions have been received from A.R.R.L. members residing in the different Sections in response to our previous notices, the closing dates for receipt of nominating petitions are set ahead to the dates given here-with. In the absence of nominating petitions from Members of a Section, the incumbent continues to hold his official position and carry on the work of the Section subject, of course, to the

filling of proper nominating petitions and the holding of an election by ballot or as may be necessary. Petitions must be in Hartford on or before noon of the dates specified.
Due to resignations in the North Dakota, Rhode Island, Southern New Jersey, East Bay, New Hampshire and New Mexico Sections nominating petitions are hereby solicited for the office of Section Communications Manager in these sections and the closing date for receipt of nominations at A.R.R.L. Headquarters is herewith specified as noon, April 15, 1935.

Section	Closing Date	Present SCM	Present Term of Office Ends
No. Texas	Apr. 1, 1935	Glen E. Talbutt	Apr. 15, 1935
Maritime*	Apr. 15, 1935	A. M. Crow	Jan. 15, 1935
Sacramento	Apr. 15, 1935	G. L. Woodington	Apr. 15, 1935
Valley			
Nevada	Apr. 15, 1935	K. L. Ramsey	Aug. 15, 1934
Saskatch-ewan*	Apr. 15, 1935	Wilfred Skafle	June 15, 1934
Alaska	Apr. 15, 1935	Richard J. Fox	Feb. 16, 1934
N. Dak.	Apr. 15, 1935	Fred J. Wells (resigned)
Rhode Island	Apr. 15, 1935	Albert J. King (resigned)
So. N. J.	Apr. 15, 1935	Gedney M. Rigor (resigned)
East Bay	Apr. 15, 1935	P. W. Dann (resigned)
New Hamp-shire	Apr. 15, 1935	Basil Cutting (resigned)
New Mexico	Apr. 15, 1935	Dan W. Lay (removed from Section)
Maine	May 15, 1935	John W. Singleton	May 25, 1935
West Virginia	July 1, 1935	C. S. Hoffmann, Jr.	July 12, 1935
Md.-Del.-D. C.	July 1, 1935	Edgar L. Hudson	July 15, 1935
Arizona	July 1, 1935	Ernest Mendoza	July 15, 1935
Eastern Penna.	Aug. 1, 1935	Jack Wagenseller	Aug. 7, 1935
Washington	Aug. 1, 1935	Stanley Bellevue	Aug. 15, 1935

* In Canadian Sections nominating petitions for Section Managers must be addressed to Canadian General Manager, Alex Reid, 165 Logan Road, St. Lambert, Quebec. To be valid such petitions must be filed with him on or before the closing dates named.

1. You are hereby notified that an election for an A.R.R.L. Section Communications Manager for the next two year term of office is about to be held in each of these Sections in accordance with the provisions of By-Laws 5, 6, 7, and 8.

2. The elections will take place in the different Sections immediately after the closing date for receipt of nominating petitions as given opposite the different Sections. The Ballots mailed from Headquarters will list the names of all eligible candidates nominated for the position by A.R.R.L. members residing in the Sections concerned. Ballots will be mailed to members as of the closing dates specified above, for receipt of nominating petitions.

3. Nominating petitions from the Sections named are hereby solicited. Five or more A.R.R.L. members residing in any Section have the privilege of nominating any member of the League as candidate for Section Manager. The following form for nomination is suggested:

(Place and date)

Communications Manager, A.R.R.L.
38 La Salle Road, West Hartford, Conn.
We, the undersigned members of the A.R.R.L. residing in the _____ Section of the _____ Division hereby nominate _____ as candidate for Section Communications Manager for this Section for the next two-year term of office.

(Five or more signatures of A.R.R.L. members are required.) The candidates and five or more signers must be League members in good standing or the petition will be thrown out as invalid. The complete name, address, and station call of the candidate should be included. All such petitions must be filed at the headquarters office of the League in West Hartford, Conn. by noon of the closing date given for receipt of nominating petitions. There is no limit to the number of petitions that may be filed, but no member shall sign more than one such petition.

4. Members are urged to take initiative immediately, filing petitions for the officials for each Section listed above. This is your opportunity to put the man of your choice in office to carry on the work of the organization in your Section.

—F. E. Handy, Communications Manager

ELECTION RESULTS

Valid petitions nominating a single candidate as Section Manager were filed in a number of Sections, as provided in our Constitution and By-Laws, electing the following officials, the term of office starting on the date given.

San Francisco	A. D. Whittaker, Jr.	W6SG	Jan. 18, 1935
Manitoba	A. J. R. Simpson	VE4BG	Feb. 15, 1935
Idaho	Mrs. Nellie Hart	W7NH	Mar. 1, 1935
North Carolina	H. S. Carter	W4OG	Mar. 1, 1935
Northern Minnesota	R. L. Rode	W9OMI	Mar. 1, 1935

In the Northern New Jersey Section of the Hudson Division, Mr. Charles Hammersen, W2FOP, and Mr. Robert W. Maloney, W2BPY, were nominated. Mr. Hammersen received 171 votes and Mr. Maloney received 147 votes. Mr. Hammersen's term of office began Feb. 15, 1935.

In the Michigan Section of the Central Division, Mr. Kenneth F. Conroy, W8YH, and Mr. Raymond A. St. Cyr, W9HK, were nominated. Mr. Conroy received 212 votes and Mr. St. Cyr received 86 votes. Mr. Conroy's term of office began Feb. 27, 1935.

Station Activities
PACIFIC DIVISION

HAWAII—SCM, A. O. Adams, K6EWQ—MV works South Africans on 7 mc. in the evenings. LEJ is on two months' trip to the mainland. KQM is on 7 mc. with nice note. EWQ and DV are still pushing traffic through. BAZ is planning to hook up on 'phone with England, relaying through California and New York hams. BFI, JRN and AG are rebuilding. FJF has regular museum of tubes. IBW is working DX on 7 mc. CIB has completed a splendid new outfit, 'phone and c.w. LCV worked the west coast with low-power 'phones. KKP has new 'phone-c.w. rig. JPD works South American 'phones with new rig. KZT is on the air. OA pounds out CQs on his drums in dance halls. JUY is building half kilowatt rig to work schedule with YL in Chicago.

Traffic: K6DV 520.

LOS ANGELES—SCM, Howell C. Brown, W6BPU—Ed Taylor 6GNM, Chief R.M. Bell Club takes Traffic Banner back from Pasadena. LVQ is new ham in Whittier. Welcome to the gang. TN moves out of Section. We are going to miss him. 8LYP is portable at C.C.C. Camp in Lone Pine. KEI works BWI from San Pedro on 56-mc. mobile job and gets R_p over 100 miles. IOX gets rig back from the factory and resumes schedule with K6LBB. FVD, GEX, IOX, KEI, LVQ, MA and DZI report. Thanks, OMs. LBE handles China traffic by mail from P. I. GXM is trying to form Police Net. CII has daily schedule with KA1HR. N6FGT moved to Los Angeles. KQN, club station, has five operators. DWP is building 1.75-mc. 'phone. KHZ has 400-watt rig now. ERT is only on 1.75- and 14-mc. 'phone now. DNA is trying out lot of antennas. JSK is on 7 mc. now. AM has 50-watt 56 mc. mobile on several hours every day. KBY always reports for the gang. FB. DEP has 5-watt, 1.75-mc. 'phone portable. ZBJ is QRL Community Chest work. JJI changed angle flat top and now gets R_p from East Coast. CV has new YL operator. Congrats. PD wanted new antenna, and wind blew down old one. Hi. GVV never missed reporting since June, 1931. Is this a record? HZB is waiting for transformer for '52. KCG is going to 1.75-mc. 'phone soon. LED is new reporter. Welcome. CU is on air again after illness. FB. BVZ is QRL job. KZX sends first report. Thanks. A strong wind blew down VI's 50-foot lattice tower on his house-top.

Traffic: W6ETL 1217 (WLVS 125) EBK 322 GNM 282 LBE 253 N6CFN 210 W6BPU 194 HEW 133 GXM 112 KNP 111 CII 109 GKZ 104 AKW 85 N6FGT 80 FYW 76 FLC 75 KBF 71 HFG 70 KQN 68 DWP 65 HAH 58 KHZ 51 HEM 44 BRT 43 DNA 42 JSK 42 AM 40 HDV 38 KBY 27 UP 26 KJE 22 GTE 20 DBF 19 JWL 17 DEP-ZBJ 14 WT 12 IKA 11 CAH 10 INH-JNE 9 DGH-KAE 8 BKY-JJI-KHV 6 BWE-CV-FMO 5 INC-JSL-KHE-PD-TN 4 CVV-GNZ-GSL-GVI-HZB-KCG-LED 3 CU-GG-HPX-JZT-VO 2 APT-BVZ-DOK-EAN-FFN-JUL-KZX-LTI 1.

SANTA CLARA VALLEY—SCM, Chas. J. Camp, W6BMW—JUQ sends in a fine letter and reports from Hollister. GBI has taken his sky hooks down. JYW is on 3.5-mc. c.w. FYD is QRL San Jose State. JUR is rebuilding. JUQ has a new antenna. JBI manages to find time to work the rig. AZC sends in a good report. KBT has RK-20 on 1.75-mc. 'phone. BSO has been extremely busy at college. LLW has several reliable schedules. YL, San Jose State, reports for the first time; was QSO G2BM on 7 mc. YG had portable rigs ready through U.S.N.C.R. for Maccon disaster, FB, OM's. Two new operators: LTQ and LPT. YU was busy rebuilding rig for DX Contest. QR and MBH have put up new antenna systems. BCF joined U.S.N.C.R. YX is bothered by QRM. FBW sends in his usual good traffic report.

Traffic: W6YX 2 FBW 56 YU 17 MBH 16 YG 104 YL 39 LLW 70 AZC 77 JUQ 7 JBI 18 (Dec.-Jan. QR-MBH 20).

EAST BAY—SCM, P. W. Dann, W6ZX—RJ, Mac, is still deep in A.A.R.S. EJA has new rack and panel job. YM has several schedules and FB traffic total. AF says

DX not so hot. CGU is experimenting with remote control. HLR has joined U. S. Navy. FMY is rebuilding. FWO decided to come back and is rebuilding. EGM saves stand-off insulators by mounting on plate glass. TM, at Williams, is back on 7 mc. with pair '52s. ZX has been busy organizing a "Good Will" network on 7294 k.c.; about 30 fellows in net now. The gang meets every night at 7:00 p.m. P.S.T. and on Sunday at 9:30 a.m. P.S.T. Traffic is handled, but it's mainly a get-together net. The special organ is "7294 k.c." published for the members.

Traffic: W6IMI 368 RJ 253 EJA 149 YM 42 AHI 22 AF 21 HWB 4 CGU-IMZ 2 ZX 210.

SAN FRANCISCO—SCM, Alan D. Whittaker, Jr., W6SG—A sincere vote of thanks for two years of hard work well done goes to Byron Goodman, the retiring S.C.M. from the Section. Good Luck, CAL. CAL is trying to find a noiseless receiver! Keep up the good work, ZG, FB! HJP makes B.P.L. on deliveries. BVL is working on coastline, Trunk "F." HRY is alternate on Trunk "F." Trunk line traffic is making good totals for KNQ. KJQ is knocking off some good DX on C.W. these days. JPA has worked all districts on 3.5-mc. C.W.; all QSOs verified. JMR is new president of Marin Radio Amateurs; he hooked a PY to celebrate. BJM gets more antenna current, same input. Hi. "Doc." LIE is now inactive on traffic due to medical duties. JXK has to let up on traffic on account of his new job. JPT has a new crystal and pair of tens output. HVX has new s.s. receiver perking very FB and is on 7-mc. C.W. after try at 1.75 mc. GAH married EK, and soon the combination station will be on the air. Good luck to both of you. IBQ has his eye on the first place in the I.R.C. SG and IBQ have been on 56 mc. every Sunday from the top of Mt. Tamalpais. JSN is still at sea. Tri-Section meeting in San Francisco was held Feb. 23rd and 24th.

Traffic: W6ZG 2502 (WLW 643) HJP 264 NK 111 (NDH 89) JNI 93 BVL 56 HRY 56 KNQ 49 JDG-LCQ 18 KJQ 16 JPA 6 JMR 3 BJM 1 JBZ 12.

SACRAMENTO VALLEY—SCM, Geo. L. Woodington, W6DVE—ISX is now in Signal Corps, U. S. Army, and is stationed at Honolulu. KBO is working on 3.5 mc. during short visits home from Forest Service camp. IAP is in C.C.C. camp and off the air temporarily. APE has gone to 1.75-mc. 'phone. GZY is doing fine job on Trunk Line "L." DVE had fine chat with FW, NT, EFM, KBK, ZS and LGD over the air. LUH is new ham in Section. GAC burned plenty of midnight oil in the A.A.R.S. ZAG Contest of Feb. 2nd-3rd-4th.

Traffic: W6DVD 43 (WLVD 41) CGJ 47 GZY 19 DVE 12 GAC 53.

ARIZONA—SCM, Ernest Mendoza, W6BJF-QC—KOL schedules 5ZM, 5DLG, 611K and IAH daily on trunk lines. CDU schedules 5OW and 5ZM daily except Sunday. KFC works K5, K6, J5 and K7 on 3.5 mc. with new Tri-tet and '10 final. JHV works W3, W8 with 5 watts to 42-71A c.c. rig. KIR uses '47 c.c. osc. while rebuilding '61 heap for FZQ. EGI has P.P. '47 c.c. osc., 30 watts, in bedroom at Tempe Teachers College. JKS is active on 56-mc. and 1.75-mc. 'phone and 3.5-mc. c.w. IYR chews fat locally with 5-watt 3.9-mc. 'phone. IYR won graphite anode '03A at Club raffle. LLL is on 7 and 3.5 mc. with '47 final. KWV employs '10s in P.P. on 7 mc. KWG is to use P.P. '30s soon. KSE is moving down to 7 mc. New officers of Phoenix Radio Experimenters Society: ALU, pres.; EGI, vice-pres. JFO and JIW like their new 866 power supplies. QC on motorcycle was hit by drunken autoist and leg broken in three places, but recovering ok in hospital. JVR is on 1.75-mc. 'phone daily with P.P. '10 final. LSK pounds brass on 3.5 mc. with P.P. '45s. JRK is rebuilding to P.P. '10s. FOH is trying to get transferred from Miami Arizona Electric Co. FPF is getting new Collins 'phone job. CVR is operating at Yuma BC station KUMA. KSP is Army operator at Camp Little, Nogales. LUF and KOK claim longest 'phone QSO—5 hours! LTS uses 12A with 150 volts on plate! BLP

has pulled up stakes to take new job at Sacramento, Calif., with Bell Telephone Co. We lose a good operator and a gentleman. LUE is having troubles with TNT, may change to P.P. '30s. HEU makes good printer at FZQ, as latter is employed elsewhere. CHR, KSE, KIA, IYR, ILL, EAW and GJC are all on 1.75-mc. 'phone. BYD has sold his 'phone heap. KKQ is back on with P.P. '45s at 60 watts. GZU is experimenting with new 150-T tube on high power. IUQ has gone into business on his own and is doing fine. JRK and KQT are liquidating! LQY is chasing DX on 1.75-mc. c.w. LSK pushes P.P. '45s on 3.5-mc. c.w. KQT sold out 1-KW rig, as Dept. of Commerce transferred him to Titusville, Fla. ISO attended De Molay meeting at Phoenix and visited hams. FFK has gone to Detroit, to stay. GFK and his portable are at Parker for couple of weeks. DPS, proud possessor of first-class 'phone ticket, is getting service on it at KOY. KKE is rebuilding heap for higher power. Harold Houghwought, ex-W6 and on KTAR staff, tries matrimony! Phoenix Radio Experimenters Society will sponsor second annual hamfest, at Adams Hotel, Saturday, April 13th; price, including banquet, \$1.50 if you buy your ticket early. Contests! Prizes!! Speakers!!! And don't forget the cats. Where, oh where, are all of those traffic reports?? The S.C.M. wishes to thank all of the hams who have dropped in at the hospital for a QSO. It won't be long!

Traffic: W6KOL 101 CDU 82 KFC 4.

PHILIPPINES—SCM, Newton E. Thompson, KA1XA --KAIRC left for the states February 26th. KA1KA on 14-mc. 'phone works China, India and Australia. FB. OM2RX will be on with new rig. OM2PI will also have new rig and new receiver. OM2BC is building new transmitter.

Traffic: KA1HR 1468 LG 525 SX 384 CS 320 DS 118 CO 101 XA 75 OMI TB 921 RX 596 OM2BC 5.

SAN DIEGO—SCM, Harry Amber, W6EOP—RMs: 6FQU, 6AXN. P.A.M. 6IBK,—two stations make the B.P.L. this month: BMC and FQU. Activity on the 56-mc. band has increased by leaps and bounds here in this Section. On Jan. 30th BWI and KEL, both in their cars, held a 30-minute QSO between LaJolla and San Pedro, about 85 miles air line. EWU and BOB held QSO between LaJolla and Lake Arrowhead, EWU using about 2 watts input. VQ, also from LaJolla, was QSO with Big Bear Lake and Pasadena. EOP, CYI, CZW, AKZ, EBX, GOG, KTZ, KBI, JRM, FGU, GWY, GRD, APG, KYG, VQ, BWI, EWU, DNS are heard on 56 mc. BMC has eight daily schedules. EFK turned in a nice total. FQU is thinking of higher power. AXN has five daily schedules. LDJ is looking for more traffic. ACJ is trying to get a 56-mc. transmitter to work; he will soon have a new 1.75-mc. rig on. BLZ tried 56 mc. and said he had no trouble working 60 miles. GNT handled a death message. BAM rebuilt for the DX Contest. IQA is putting up new poles and antenna after wind storm. 6USA, the new station for the World's Fair here in San Diego, is progressing very well.

Traffic: W6BMC 1234 EFK 318 FQU 313 AXN 275 LDJ 17 ACJ 8 BLZ 7 GNT 7.

SAN JOAQUIN VALLEY—SCM, Clyde C. Anderson, W6FFP—CYY wins the contest for contest suggestion; he will receive the subscription. A mimeographed letter will be sent out with complete details. The Bakersfield gang woke up from the dead to attend the Tulare Hamfest, then pulled the lid over the coffin again. FFU carries Modesto activities on his shoulders and completed his new rack and panel job with P.P. '10's in final. FYM is Carusoing—has lead in college opera. KQB was caught shooting down leaky insulators—there ought to be a law—that you can do that. JSG and CXK still continue to make B.P.L. with JSG leading CXK. The S.C.M. got his rig on and is going to push those two—I hope! KGO is still among the top three. JPU worked good DX till he found his buffer had more voltage than his final; he worked a PK and then asked where it was. CYY has a new receiver, Frank Jones' famous 222 that lives up to its name. DJQ is QRL YF and yard QRM. Unit 111, Sec.

111, N.C.R. gang is going crystal with new AT cuts. FFW bought a new QRA and is back on air again. AVV is finally going crystal control with heartiest thanks of Fresno gang. BWK, QK, JHV, GCF are still 56 megacycling. BWK will QSY 7-mc. low freq. when TO returns Bill's receiver. AJJ is on with 200 watts crystal and is working DX. BVM is still building his receiver that was started in 1932. BTN bit off seal of vocabulary when using electric drill to plate lead of his '52; the plate and grid came out one end and the filament on the other; new words were heard for miles around.

Traffic: W6JSG 541 CXK 494 KGO 368 FFP 102 FFU 73 FYN 38 IKG 5 AOZ 2 BBC 2 FYM 2.

WEST GULF DIVISION

OKLAHOMA—SCM, Carter L. Simpson, W5CEZ—CEZ breaks his traffic total record. BDX takes the lead in crystal contest. ASF blew his 82's and installs 366's. AMT took Commercial exam, and reports that next time he goes to take another one his is going by himself. BJG rebuilt rig and can't get the bugs shooed out; he got a new ticket. BKK is meeting the mailman every day looking for that station renewal. BMU joins the ranks of the Weather Reporting stations. AJF turned in an FB total on the A.A.R.S. ZAG Contest; he was high in the State as usual. DSM never misses a WX Report schedule. BLJ did some more pinch hitting for BJG when the latter's license expired. ABK spends a lot of time on 3.5-mc. C.W. as well as 'phone on any band. EJH, National Guard station, is operated by DKY and joined up with the A.A.R.S. DZU took Class A exam. BWN blew a power transformer again. DWW is off the air again due to illness; here's wishing you a speedy recovery, OM. BAR finally got the bugs ironed out and has schedules perking again in fine shape. ERU's shack is located on Highway 66; he wants the gang to stop and see him when they take that trip to California. ESG wants CEZ to hurry up and get a new receiver. YJ is located on Okla. A. and M. Campus and puts out a swell sig. ASQ is carrying around a sore finger where 1100 V. went in one side and came out the other MIM. CVA has new ACR 136 and entertained the S.C.M. BCS helped BEZ install a pair of '52s. AYE, another old-timer, resumes activity. ERL joins the A.A.R.S.; reports for the first time. EHR is another newcomer to the ranks of reporting stations; he is experimenting on 56 mc. with DKY. BQA says his traffic is going to pick up from now on; that's good news, OM. Our Ex-S.C.M. 5VQ is back in the state and is helping 5PP rebuild. How about some traffic reports, OM? Oklahoma breaks an all-time record for traffic reports, in that there are more traffic reporting stations than ever before within the Section. Nice work, gang. Let's keep them coming. Begin making plans now to attend the Convention at Ponca City in June.

Traffic: W5CEZ 1186 BDX 475 ASF 371 AMT 283 BJG 222 BKK 191 BMU 161 (WLJC 43) AJF 109 DSM 106 BLJ 90 ABK 95 EJH 89 DZU 85 BWN 76 DWW 70 BAR 66 ERU 57 ESG 52 YJ 43 ASQ 34 CVA 27 BCS 26 AYE 16 ERL 7 EHR 6 BQA 1.

SOUTHERN TEXAS—SCM, Bradfield A. Beard, W5ADZ—MN is in front as traffic man. BFA, BEF and OW are busy with A.A.R.S. traffic. CVW has new 830 P.P. final and worked F8, J2, EA4. AUC is looking for new PR12. BJL schedules CE3EL and HJD-2. CVQ is on 7 and 3.5 mc. EPM worked an "X" on 3.5 mc. BHO is using remote control 'phone. ETT is joining A.A.R.S. VV made W.A.C. five times! SY is on 7176 kc. with 500 watts. DWN wants some good traffic schedules. DB wants good schedules. ADZ wants to swap photos with any of the gang. DOM now has '10 P.P. final. BB is busy playing golf. BJ is now settled in new QRA. BSF reports for Kerrville gang. BKE will have new transmitter soon. BKZ is QRL with school. DSH works lots "J"'s. EBN is trying for DX. DYA wants O.R.S. EPF is on in Wink, Tex. EUH is new ham at Midland. EQD and DEE are at Randolph Field.

FPL has '46 final. BYV is QRL B.C.L. work. AJY has been very ill; hope to hear you back on soon, OM. CPM is FB publicity man for Galveston Club. EBU reports DVK has 400 watts on 1.75-mc. 'phone. ETD is new ham in Galveston and will soon be on 1.75-mc. 'phone. Galveston News: New officers of G.A.R.C. are BTK, pres.; W. Riedel, secy.; DTB, vice-pres.; CPM, publicity; CVW, chief op. The club has a new receiver for club shack. Club has emergency power supply and transmitter for storm work. New Coastal stations from Brownsville to Florida, desiring to join the Gulf Storm Net, get in touch with 5BTK. Activity: BTK is fooling with 56 mc. CPA is building 14-mc. 'phone. CDD is on 14-mc. 'phone. CVW is on 56 mc. ENX is on 7-mc. c.w. El Paso News: DWN at Ft. Bliss (active O.R.S.) will be on 14 mc. about February 15th. DE has received new supplies for his 14-mc. rig. CWW tried out portable, using single 30 with 1/2-watt input, and loop antenna. EGI is putting in a pair of 42's soon. EBS has been doing a lot of cross-band duplex work. DTT is rebuilding; DTM moved upstairs and then down again; says still no DX. EVJ is putting a new rig on 3.5-mc. c.w. BRD is building up new 'phone rig. AEC (outgoing president of local club) is now on the air. ELK is planning on going to Mexico soon. BTA, active on 7-mc. c.w., is planning a 14-mc. 'phone rig. AOT says 14-mc. DX is opening up early this year. DNU asks, "Does anybody answer QSL's nowadays?" EED is retransmitting signals from other districts on same band, using home-made condenser mike. ESI has 1.75-mc. 'phone rig with 30 watts input. EQH put on demonstration of Amateur Radio at Rotary Club, with assistance of AOT, DE, AEC, EED and also 9JF and 9BJ.

Traffic: W5MN 1011 OW 549 (WLJ 1440) BFA 126 BEF 115 CVW 109 AUG 70 BJL 42 CVQ 30 EPM-BHO 30 ETT 26 VV 22 SY 8 DWN 5 (VK7 52) DB 5 ADZ 8 DOM-BB 5 BJ 4 BSF 2.

NEW MEXICO—Acting SCM, Robert Shadden, W5AOP—ZM has a nice line of schedules, also is highest traffic man for state; he is experimenting with 56 mc. and is rebuilding c.w. rig and 1.75-mc. 'phone. ELL, CQL, CYX and ZA are experimenting with 56 mc. EAO rebuilt transmitter and has new super receiver. Portable 9KQY is building up a swell 14-mc. 'phone. ASR is on 14-mc. 'phone. AUQ and CVB took Class "A." BNT took Class "A" and Radiotelephone First. AOP has new QRA and is rebuilding. Let's have more reports so we can have larger report for QST.

Traffic: W5ZM 333.

NORTHERN TEXAS—SCM, Glen E. Talbutt, W5AUL—Whoopie! EES makes B.P.L., got married and visited the S.C.M. this month. CPB has good traffic and is winner of Section QSO Party. Congrats. BII, the C.R.M., says more local schedules needed to take care of deliveries. DXA has new "5-C" receiver. BEY is making good traffic showing. BXA is now in A.A.R.S. ZD wants O.R.S. COK is going to change rig. CHJ wants to get married; YL's note. CPT has new rig. EEW has four schedules. EDB is new A.A.R.S. man. ANU is back on the air. AW is lovesick. IA says "nertz" to his 'phone. ETA is new ham in Palestine. DAF is taking a rest. EFN is operating EEN at Lubbock. EFC and EEF are trying to get on 1.75-mc. 'phone. EMG at Clarendon wants 3.5-mc. schedules. RH has new rig. BZT reports QRL school. Chas. Kaulh reports for N.T.A.C. Club at Arlington; EUY is Club call. ECA is Prexy. JM is operating portable on 7 mc. Thanks, OM. NW "says" he worked four Africans. What ho, Director? MIM, TR, BKH and AKU visited the S.C.M. TR reports N.C.R. work progressing in Dallas. AUJ has new transmitter; even the parts are new. AZB is QRL job. BCW is active. QA tried to tear his car up. SP is trying for BC station license. ARS and PJ are engineers of police radios. Thanks for the good report, gang, and keep up the good work. If you need report cards, let the S.C.M. know. "Bill" acknowledges the many greetings and says 73.

Traffic: W5EES 262 CPB 222 BII 186 DXA 174 BEY 141 BXA 63 ZD 59 COK 46 CHJ 47 CPT 40 BKH 28 EEW 23 EDB 19 ANU 16 AW 12 ARV 6 IA 1.

NORTHWESTERN DIVISION

ALASKA—SCM, Richard J. Fox, K7PQ—EGS is a new ham at Ketchikan. VH returned to Juneau from a long vacation. DVF is using 14,000 kc. and is "hepped up" over DX on that band. DWM has an FB 1000-volt power supply. BZX now puts 200 watts into the antenna. BNW returned from Seattle, where he was undergoing medical treatment.

Traffic: K7DWM 4 PQ 26 DVF 180 BOE 176.

IDAHO—Acting SCM, Nellie H. Hart, W7NH—ASA is QRL Army Net. EMT gets bang out of ham radio. AVP waits for PR-12. DBP sends code practice four times a week on 3607 kc. CHT works DX and duplex on 14-mc. 'phone. CAP eliminates clicks. NH is QRL schedules. KV was snowed in couple of days at Boise. BCU is moving to Aberdeen, Wash. BMF is QRL service work. CSP and DAW are on 14-mc. 'phone. EES and CJK are on 1.75-mc. 'phone. CP is lonesome on 28 mc. BHN is on 'phone. ATN is QRL B.C.L. repairing. GU is building an FB all-band 'phone. BKF is rebuilding. EFR is looking for crystals. AYP is working DX. BMQ is getting the bug again. EUV is new ham in Meridian. AAJ-7DTF is working FB duplex. DEB is coming on with '04A's. EFL is now on 7 mc. AVZ is building new rig. CFX is QRL service work. JW works 14- and 3.9-mc. 'phone. DSU will be back on the air soon. AHS is new O.R.S.

Traffic: W7ASA 65 BAA 52 EMT 25 AVP 16 DBP 13 CHT 10 CAP 9 NH 289.

MONTANA—SCM, O. W. Viers, W7AAT—DHW reports for the Billings gang. EPM is on 7 mc. mostly. ESI is on 3.5 mc. and DHW on 14 mc. DEN is building new rig with a 211E in final. CRH reports for Somers. AFS is still DXing. CEG says the rule for jumping a foot for each 100 volts is not accurate up to 750 volts. CRH is on mostly for A.A.R.S. schedules. BVE is working on Trunk Line "A" with COX/AAT, and reports a total of 35 hams in Great Falls—two new ones brought the total up to that mark. BXL is back in Fort Shaw. AOD, BZA, BJZ and AQN are active in A.A.R.S. CNE bought SW3. ASB has improved transmitter, as has COX. The Missoula Radio Operators Club is making an effort to locate and eliminate power line QRM there. BZA rebuilt. FL is new O.P.S. BDS had lots of fun in 'phone-c.w. contest. EVP plans on increasing power soon. CCR is still rebuilding.

Traffic: W7AAT/COX 74 AOD 44 BVE 39 CRH 37 FL 19 BDS 5.

OREGON—SCM, Frank L. Black, W7AMF—Route Manager UJ again heads traffic list. EFP, Silverton, is new O.R.S. KL has taken over Trunk Line "F" post in Eugene, formerly held by UJ. HD is now operating Trunk "G" station in Portland. UJ was appointed state net control station for A.A.R.S., with WR as alternate. COU reports by radio. BOG has B.C.L. QRM which keeps him off the air for awhile. DTG got commercial ticket and is looking for job. CSQ moved to new location, says better for 56 mc. ABZ is rebuilding. Corvallis Communications Club announces convention dates: April 13th and 14th. RUB has gone 56 mc. AXJ resigned as state net control of A.A.R.S.; he says he has to curtail activities in radio for business reasons. Oregon has vacancies in Communications Department for a few good O.R.S. If interested in traffic handling, drop a card to Route Manager or your S.C.M. A nice section paper is mailed each month to every station reporting to the S.C.M. Please get your reports in on time, fellows.

Traffic: W7UJ 228 DUE 206 CXK 174 BWD 140 KL 115 HD 103 BRH 99 CRK 83 COU 70 AYN 59 WR 58 BDU 49 DTG 42 EFP 43 DP 22 EBQ 18 AMF 7 WL-BUB 6 CSQ-ADA-AIG 4 ENC 2 DAV 8 AHZ-BGF 1.

WASHINGTON—SCM, Stanley J. Bellevue, W7AYO—WY keeps nine schedules a day. New O.R.S.: EAW,

DZX, UE, DLN. RT got a new '35 V-8 sedan. UE is believed to be the oldest O.R.S. in the U. S.—he is 63 years old. BEK is new O.P.S. EWS is new in Ritzville. DPU's car license is M-73. Hi. EVB is new in Wenatchee. AVM worked his first ZL. AXS is on after two years' silence—has swell sounding 'phone. New reporters: ETO, ENJ. DRK is busy at W.S.C. AIT is on 14-mc. 'phone. AQB on February 10th fell from a roof while erecting a BCL antenna (two-story house). He broke both elbows, left wrist and his nose; also received two black eyes and a dozen bruises. Last we heard he was getting along OK.

Traffic: W7WY 540 BB 494 CQI 245 APS 157 LD 141 CZY 132 EAW 101 AYO 74 CSK 70 DRY 58 DGY 52 DZX 41 RT 37 EPT 36 EKA 35 DRD 28 UE 20 AZI 19 APR 15 BBK-DRR 13 AQ-DPU 12 AEA-IG-ETO 11 EPZ-DDO-AMN 10 AVM 7 RL-EUS 6 AW 4 AXS-ANF-EIR 5 EOR-ENJ 4 ECX-EAT-DRK-BCS-AUP-ETW-DLN 2 CND-AIT 1. W6JNN/7 23.

ROCKY MOUNTAIN DIVISION

COLORADO—SCM, Glen Glasscock, W9FA—ESA is still the high traffic man and finds time for plenty of 56-mc. work. GBQ had to move and spoiled his 56-mc. location for awhile. PVZ was appointed Route Manager for Northern Colo. Get after him, gang. IPH and OUI built an FB portable using RK20. ESX and DSB are kicking about QRM on 56 mc. JGA is rebuilding modulator equipment. CJJ is dolling up the BC station but gets on now and then. BTO swapped PR-10 and then got another. FYY, FYG and PVZ are planning on N.C.R. cruise this summer. MKN got out from under the theater QRM by moving. ECY is QRL Hamfest preparations. PWU and LYV are hitting the ball regularly on A.A.R.S. 'Phone Net. PIY got the 'phone rig working OK. PIH is building new rig. PTI moved again, but jumped into street car QRM this time. AAB holds honors for rag-chewer; he rattled 2UL's cans for 3½ hours. MXM is working on 56 and 14 mc. IJM is on the road for Interstate. APR is QRL sleep. Hi. EMU on with new rig; sounds OK, Reggie. BYV ran into feed-back troubles. MOC took exam for N.C.R. EKQ keeps Littleton on the map on 56 mc. PWL has a seige of the Flu. GHY got new receiver. JB goes 'phone and forgets N.C.R. JFD and "YF" settled in their new home, and Fred is back on the air. DCY grabs for the bug when the 'phone doesn't get 'em. RHF is now on 1.75-mc. 'phone. NUU finds out what they mean by "bugs" in a rig. SBE is working all bands. REU is putting in pair of 242A's. PZF is now using crystal osc. FB, OM, keep up the good work. NUD is QRL "Mines." SNB got the new rig perking swell. YAA possesses new 15-watt 'phone rig. IVT is strong booster for RME9D; same thing goes for HIR and FA. SYY is new ham at Canon City. IES helps AYP keep Sterling and Ft. Morgan on the air. NIQ finds a little time on Sunday to pound brass. SZS is still the big noise in Del Norte. GDC is working 1.75-mc. 'phone from Granada. SBJ and GYV combine to keep Montrose active on all bands. APZ is using single 30 in Hartley with 100 V. of B. Bais. GNK, "the OM in the Mountains," goes 'phone. RX visited Denver. RTQ built new power transformer. SPL says there are at least 11 hams in Ft. Collins. How about some dope on them, OM?? PGS and JRV hooked CE3EL. IGO, PFU and FG are beginning to find time for radio. YL put 'phone rig on 14 mc. FNR was QRM'd by the Flu. SAX is now working 7 mc. AMS is still looking for "ways and means" to replace filter cond's. DNP ordered National "HRO." DYP borrowed power transformer and got back on the air. EHC is handling traffic on Trunk Line "B" and building new rig. FXQ slipped a notch and found himself on 7 mc. HDI swears by all that's holy he's going to "manage" for a super-het. KNZ pulls 'em all in with home-grown super. KI is still collecting parts for the I-KW. rig. LJF is looking for traffic schedules. LFE runs into trouble with harmonics and can't get rid of 'em. NRZ tangles with

B.C.L.'s about QRM from his 'phone rig. NHI is getting to be quite a stranger. What's the QRM, OM?? NKI lost some hide in auto wreck. PRF can't find time for radio. TFT turns to "talking" CQ's instead of pounding them. The P.P.A.R.A. bought a keg of beer and invited the S.I.R.C. to help guzzle it, but they didn't show up. Sissies? OKY, P.P.A.R.A. portable, has been dusted off in preparation for Field Day. KNZ gave fine talk on field strength measuring devices. GLI takes a little time off of N.C.R. drills to aggravate the mike on 3.5 mc. LQO is QRL sewing for the youngsters. NUP joins the crystal gang, FB, OM. TDS is new call of the "YL" op at MDN. MDN throws out the Tri-tet. NPP is QRL theater wiring job. SBB has that "sick calf" look when he sees a 50-watter. SYL is new 1.75-mc. 'phone man at Lamar. EOQ and CDE are keeping Army Net going in 3.5 mc. Eastern part of state: GPP has tough luck with his power plant. KSE lets the '52 "ride easy" with 600 V. on the plate. JCQ is rebuilding. TEL, TEJ and TDR are new hams in Pueblo and all joined the N.C.R. NLD broke his wrist putting up 56-mc. antenna. PMF says C.W. not so good in the 1.75-mc. 'phone band. NLN blew a '10, '45, and a light globe all in one day. SAU is having trouble keeping the '46 neutralized. The Navy gang at Pueblo moved into new quarters in the Armory Building. OTM is getting FB reports with P.P. ten's. NVE feeds 100 watts to a '45 and makes it like it. The San Isabel Radio Club reports heavy activity on 56 mc. and has also formed a "Better Radio Reception Association." There are still plenty of stations to be heard from or about so get busy, gang, and let's have plenty of new dope on what's going on in your vicinity.

Traffic: W9ESA 842 PVZ 595 PGS 4 EHC 42 NLN 12 NLD 15 PMF 8 TDR 10 TEJ 7 GLI 99 TEL 50 PVU 44 GNK 359.

UTAH-WYOMING—SCM, Arty W. Clark, W6GQC—Asst. SCM Wyoming, T. J. Rigby, W7COH—Utah: W6PYR is pinch hitting on T.L. "D." KDI got rig on the air again. GPJ would like to lay hands on a guy who needs his guitar more than he. AHD is going to school in Logan. LCM built 59 crystal osc. HIWI is keeping regular schedule with 5DVH. LLH built new receiver. DTB moved to Randolph and is in charge of grocery store. AFN moved to Spokane and is working for Spokane Radio. Sure miss you, Dick. DAM is disgusted with crystal and went back to TNT. LXI is new call in Salt Lake. JVA is working 276A rig. KEA, LCM, KOZ and KGM are new members of U.S.N.R. JYD and HVU staged "thriller"; wrecked car belonging to JYD's dad, MIM!! BTX is going to school in Berkeley. DGR made trips to Logan and Ogden organizing U.S.N.R. units. KMA got married. Wyoming: W7ASX wants to know where he can get a 100-volt A.C. 500-watt generator. Casper: BXS has 1.75-mc. 'phone that doesn't work. CYN has a new super. EDC on 14 mc. wants schedules. NY is helping CYN build transmitter. CHR says nothing new. EOT, new ham, is building transmitter. DES reports no luck on 3.9-mc. 'phone. ELL is building new rig. ACG has new end fed Hertz ant. on 7, 3.5 and 1.75 mc. and wants schedules. EVN, new ham, gets out fine and is good rag-chewer. AMU is newly appointed asst. S.N.C.S. in place of AXG, resigned. Here's luck, OM, and sorry to lose AXG. ADF is painting and decorating shack. Sheridan: CSE is QRL with new radio club, etc. Rook Springs: DIE is busy on T.L. schedules and doing an FB job. CGH on 3.9-mc. 'phone is getting out FB from Bitter Creek with portable. Midwest: CLG had an FB P.A. system at Scout Pageant; he expects to be on 3.5-mc. C.W. soon. CMP is building crystal rig. COH is busy with T.L. "G" schedules now that crystal rig is perking FB. Gebo: ABO is back on with new crystal and the old speed demon is chewing rag again. Granger: ASX is on 3.5 mc. occasionally, chewing rag.

Traffic: W6GQC 431 FYR 109 KDI 66 GPJ 33 AHD 19 LCM 17 HIWI 1 LLH 3 W7AMU 106 CSE 4 COH 106 DIE 19 BXS-ASX 1.

MIDWEST DIVISION

IOWA—SCM, Phil D. Boardman, W9LEZ/WLUD—1 9ABE, 9CWG, 9HGH, 9HMM, 9LCX—R.M.'s. 9AED—P.A.M. Greetings to Art Rydberg, 9AED, Mitchellville, the first Iowa P.A.M. Come on, 'phone men, help Art carry out the fine plans he has in mind. All prospective O.P.S. please get in touch with him at once. The Sioux City hams were fortunate in having as their guest K. B. Warner. The Northeastern Iowa Ham Club reports new officers: Pres., NTW; vice-pres., RDK; secy.-treas., STA. The Tri-City Amateur Radio Club heard an interesting talk on crystal mikes at the recent meeting. ACL again leads in traffic. FB! LEZ resumes schedules. HCH met "KBW." HMM is a night watchman. LCX acts as Wirephoto boss. CWG is now in crystal business. MHV is Alt. D.N.C.S.—A.A.R.S. RCR works more DX. NTW and STA have new supers. NNM and PAH are new O.R.S. SQL worked K5 and K6. RDK and SWZ will have 1.75-mc. 'phones. ERY has new YL. NZW wants more contests. MCX moved back to city. KMJ is now on 3.5 mc. KBM has 1 kw. on 7 mc. CEN is proud papa. CGY invites the boys to a pole raising. BZE and JQU have RK20 'phones. YA/IO is QRL due to exams. AED almost won the last O.P.S. Contest.

Traffic: W9ACL 410 LEZ 214 (WLUD 32) HCH 160 HMM 154 LCX 142 CWG 85 MHV 51 RCR 20 NTW 10 NNM 7 PAH 6 SQL-RDK 4 SWZ 3.

KANSAS—SCM, O. J. Spetter, W9FLG—9KG and 9IOL, R.M.'s. FLG, RIZ and IQI make B.P.L. RIZ, IOL and OZN are working on police net. IQI is working at Hiawatha as service man. RQN is on 3.5-mc. C.W. with 50-watt crystal rig and 1.75-mc. 'phone with 10 watts, grid modulated. IEL is rebuilding but is keeping schedules with self-excited rig. BYV has new nine-tube s.s. receiver. IXE has Radiotelephone first class ticket. THM is new call in Wichita. CVN has Class "A" license. LFB works both coasts with '46 crystal osc. on 3.5 mc. OHY has new rig just about finished. TJQ services radios for living. BSX is planning pair '52's in final. PGL and RDW are on 1.75-mc. 'phone. BEZ is QRL N.C.R. FVR moves to Wichita. TAN and LKD are on 1.75-mc. 'phone. ABG joins A.A.R.S. BDB is now radio serviceman. GUO is having modulator trouble. BDB is leaving for school in Dayton, Ohio, to study refrigeration servicing, and wants to sell out. DMF and ABJ are experimenting with 56 mc. on high school tower. CVN is putting in Class B modulation on 14-mc. 'phone. BEZ has also changed to Class B. GML is on 14-mc. 'phone. LKD was operated on for appendicitis and is now recuperating. PGL put small transmitter in LKD's room at hospital so he could chew the rag with club members. RQS is now on 3.5-mc. C.W. and joins A.A.R.S. Club Notes: W.A.R.C. QSO Contest comes to a close, but winners not decided on yet; election of officers as follows: CVN, pres.; CVY, vice-pres.; AWP, secy.-treas.; DMF, publicity manager. W.A.R.C. invites all hams to attend the Wichita hamfest April 13th and 14th. Don't miss it!

Traffic: W9FLG 1331 IQI 615 RIZ 610 IOL 347 IEL 290 AWP 192 OZN 120 CDM 116 RAT 81 BYM 76 BYV 71 EYJ 63 CMV 52 KFQ 40 PCF 27 FMX-LTG 11 SJV 7 RQS 5.

MISSOURI—SCM, C. R. Cannady, W9EYG—JPT—RYD is now using full kw. MZD is holding 10 schedules. AIJ is starting up crystal business. NNZ rebuilt entire transmitter. DIC built emergency power supply using 6-volt battery. KCG got 87.3% on Radio-Telephone First, Commercial. SGP put up new zepth with FB results. OQI is back to Marshall and settled. TJ is doing FB in 28 mc. tests! PYF brings Hannibal back into the Missouri! C. D. LEQ went into the DX Contest. KEI raised voltage for oscillator and doubler. JAP is coming on with RK20. TGN is rebuilding with '03A final. BGE wants schedules on 56 mc. OWQ averages 90 QSO's per month. HVC is building linear amplifier with two 211's P.P., 900 volts for 'phone. KEF is QRL inventory at store. Sedalia Amateur Radio Club: LVA worked some DX. PVW had 40 QSO's last month. AWC

is still killing bugs with buffer. AZL is having B.C.L. trouble. HUN plans to rebuild. SHW will get station on when he moves to country. OWQ is on the air every day and evening. BTD is still active on DX at Fulton. O.B.P. Club of St. Louis: KEF is new member. BEQ is back on with new high-power rig. PW wants dope on 3.9-mc. 'phone. Afton Gang: EZX finished new rig for 7 mc. PFO is QRL with new op! KFL is back on 7-mc. and 1.75-mc. 'phone. BGE is doing FB work on 56 mc. Kansas City: LLN and LHQ hold weekly meetings with 9CD and HZH. BMA is off air temporarily to satisfy BCL's!! FHV has bridge playing fever. St. Louis: KHU wants O.R.S. appointment. GBJ is recovering from scarlet fever. DHN is back in school until June; he says DCB is the active ham in Columbia. SNR got an BA and almost forgot everything else. RJP is trying for DX. KTH volunteers services in Missouri State Net. HVW was active in 'Phone/C.W. Contest. ARH is back on air at Milan. The Missouri State Net is now in working order and progressing rapidly. Get in on it NOW, before the vacancies are filled. MISSOURI ACTIVITY CUP RACE for second year in succession was won by R.M. 9BMA with 9CJR and 9MZD close behind. A heated race has developed for 1935 with 9RYD and 9JWI in a tie for First and 9MZD and 9BMA locked for Second!

Traffic: W9RYD 1110 (WLMF 288) MZD 531 AIJ 367 NNZ 140 DIC 105 FJV 94 (WLUT 54) KCG 72 CJR 69 SGP-OQI 61 ENF 59 TJ 32 PYF 31 EYG 24 LHQ 22 JPT 19 HUG 16 KEI 13 JAP 11 TGN 6 MLR 5 BGE 4 OWQ 3 HVC-KEF 2.

NEBRASKA—SCM, Samuel C. Wallace, W9FAM—KPA leads the Section this month. FAM is doing all possible in conjunction with KPA on Trunk Line "L." DI has rebuilt power supply and transmitter and has made a big improvement on his signals. FWW is planning on rebuilding his outfit soon. DMY is complaining of skip on 3.5 mc. EHW is going strong in A.A.R.S. work; now has a 1.75-mc. 'phone on the air. RUJ has fine transmitter and can change from 3.5 to 1.75 mc. very quickly. KQX is a new O.P.S. in our midst; here's wishing you all the success in the world, OM. BQR reports. HYR has the 7 mc. bug but is having trouble tuning antenna. INR is new O.R.S.; congratulations. KJP is building new super receiver. IGF is busy grinding crystals and tinkering with 56 mc. MKG says he wishes the bunch in Nebraska would get busy and try 56 mc.

Traffic: W9KPA 488 FAM 392 DI 365 DMY 95 EHW 85 RUJ 66 KQX 33 BQR 11 HYR-EWO 4 FWW 359 MKG 4.

DAKOTA DIVISION

NORTH DAKOTA—SCM, Fred J. Wells, W9JVP—KZL has new Super Skyryder; he was at Watford City operating WUCX, while GNS was on leave. PGO is on 1.75-mc. C.W. PRH is coming on with new rig. BTJ is using 700 watts now. STF is new O.R.S. TNT is new ham in Fargo. OEL has six schedules daily. RQX rebuilt. RYZ is going crystal. NUM is going 'phone. DGS made 1500 pts. in O.R.S. Party. JVP works out FB with new 100-watt 'phone on 14 mc. HJC has new FBXA receiver. LBI is using '10 in Final. DTP is putting up new feeders. GNS is located in valley in badlands, he is located in HQ's of Co. 2772, C.C.C.

Traffic: W9PGO 18 LBI 37 HJC 72 (WLUI 210) PHH 66 KBE 52 DGS 111 PQW 80 OEL 215 BTJ 3 STT 8 KZL 128 GNS 82.

SOUTH DAKOTA—SCM, Mike Strahon, W9PFI—OQV and HEW, the Begley brothers, make the B.C.L. again with nice totals. BLZ's schedule with 7NE is about the longest hop on any trunk line. ALO gets the power for his '10 from the wind. PGV is the new president of the Miller Club. OED is having trouble with his new 'phone rig. CFU would like to get rid of a pair of 212D's. GLK at Boudle has new Skyryder. CAU is now operating KABR at Aberdeen. SJA is new ham at Homer on 1.75-mc. 'phone. All but two of the fifteen hams in Sioux Falls have 56-mc. rigs. SEE YOU AT THE MID-AMERICAN.

National Highlights

THE January-February period found many of the gang rebuilding for the DX contest, which will be history when this is read . . . no doubt there will be more rebuilding, if the DX results didn't come up to expectations . . . that's amateur radio. Hi! All phases of operating activities continue at an extremely high level. Communications department appointees are evincing intense interest in organization enterprises with the result that numerous efficient 'phone and c.w. networks are shaping up.

The affiliated clubs of Eastern Pennsylvania met at the York Road Radio Club, Glenside, Pa., March 5th, with an exceptionally large attendance. This was one of regular "joint meetings" held by the Eastern Pennsylvania affiliated clubs to discuss mutual problems. The annual hamfest under the auspices of the Chester (Pa.) Radio Club was bigger than ever with about 300 in attendance. The S.C.M. and R.M.'s of Western Pennsylvania have organized an O.R.S./A.A.R.S. Net, operating on a spot frequency of 3805 kc.; W8CUG, W8GUF and W8KWA deserve plenty of credit for making this net possible. The Rochester (N. Y.) Hamfest on February 9th was a decided success; about 200 enthusiastic hams were on hand. W3QL, well known as S.C.M. of Southern New Jersey, has been forced to resign his appointment due to taking a job as radio operator aboard the S.S. *J. E. O'Neill*. W3ZX has taken over the duties of Acting S.C.M., pending an election. Washington, D. C., amateurs and their ham-pals in neighboring sections are looking forward to a hamfest in April, during the cherry blossom festival.

A Wisconsin State Emergency Net has been started under the leadership of the Route Managers. This net operates each Sunday from 10:00 a.m. until noon, C.S.T. Each station operator must be able to copy at least 15 w.p.m. and must originate a message addressed to the S.C.M. regarding station activities. The sole contact that Isle Royale, Mich., has with the mainland during the winter months is amateur radio—W9PCQ on schedule with W8JO provides Isle Royale with an efficient communications link. Broadcast station WILL at the University of Illinois broadcasts a ham program; details are not at hand at this writing. W9JO, George E. Dammann, 319 Sherman Ave., Evanston, Ill., has been appointed QSL Manager for the 9th District; send him your envelopes, gang! The annual hamfest at Purdue University will be held in April; write W9YB for dope. Ken Conroy, W8DYH, was reflected S.C.M. of Michigan and pledges his continued cooperation with all amateurs in the state. W8LSF, Detroit, is now holding down the Michigan position on Trunk Line "A." Kentucky is about the O.R.S.-iest section in the country! The Illinois Bulletin, edited by W9KJY, continues to pep up activities. The QRK Amateur Transmitting Club of East Liverpool, Ohio, announces a hamfest for April 27th—everyone welcome! W8HCS, R.M., is working on an Ohio Traffic Net, with connections to all adjoining states. A Michigan 'Phone "Round Table" takes place every Sunday at 10:00 a.m., and includes W8EKT, W8DK, W8AWO, W8CZ, W8IGL, W8TT, W8AOM, W8BMI, W8AAF, W8DGH and W8IKZ, and is still growing; to P.A.M. W8IKZ goes credit for organizing these weekly get-togethers. The Kentucky Net operates on 3810 kc.; active members are W9BWJ, W9CDA, W9CIN, W9EDQ, W9HAX, W9OMW, W9PAZ, W9BAZ, W9OX and W9CNE. A Kentucky Section QSO Party is held every month on the first Sunday from 9:00 a.m. to 3:00 p.m., C.S.T.

Dakota Division amateurs are boosting the "Mid-American" Convention to be held at West Hotel, Minneapolis, May 3rd, 4th and 5th. Everything points to a gala affair. W1EH, Secretary Warner, was the principal speaker at a February meeting of the Minneapolis Radio Club; 250 amateurs attended. A.A.R.S. Nets are perking

well in Mississippi, both c.w. and 'phone. Arkansas S.C.M., OM Velte, W5ABI, and other amateurs active in A.R.R.L. organization work in that state, have organized a State Net to cooperate with law enforcement officers in conjunction with the American Legion and police radio stations. This net includes twenty-three stations in all parts of Arkansas, all of which are ready at a moment's notice to go on the air in case of law disturbances, or disaster. W5DHU was winner of first prize in the recent Arkansas QSO Party. Ned Cantrell, W4AEP, won national honors in A.A.R.S. ZAG Contest. Anyone who has heard an earful of activity in a ZAG Contest knows that this is a real feat! FB, OM, WZAL/K5AF, Albrook Field, C. Z., reports 250 messages handled on Army frequency and 22 on amateur bands.

W2DSH of White Plains, N. Y., is building up an amateur network for the police. Following his suggestions, this movement is being taken up in many other cities throughout the country. W2FOP, Charles J. Hammersen, won the recent race for A.R.R.L. S.C.M. in the Northern New Jersey Section, and is now active in that office. He is lining up a QSO Party/Contest for his section. W2BGO, Bronx, N. Y., offers fast service on traffic to the west coast via this route: W2BGO-W9JSO-W6JXK and W6DDO. Three-quarter hour round-trip service is possible using this route! W2CC, according to latest reports, has now had 876 QSO's with VK5HG!! W2BJA has Trunk Line "G" perking FB through Albany.

W9RIZ, W9TOL and W9OZN are working on a Kansas Police Net. The Wichita Amateur Radio Club invites all hams to attend their hamfest in Wichita, Kansas, April 13th and 14th; this club's QSO contest was recently concluded. Sioux City and Des Moines, Iowa, were visited by K.B.W., W1EH. The Missouri Activity Cup Race for 1934 was won by W9BMA (R.M.), with W9CJR (R.M.) and W9MZD close behind; this is the second successive year that W9BMA hit first place! As the 1935 race gets under way, W9RYD and W9JWI are tied for first place, R.M. W9KPA and S.C.M. W9FAM make an "unbeatable" team in keeping Nebraska activities on the "up-and-up."

The New England Division Convention will be held at the Hotel Bancroft, Worcester, Mass., on April 26th and 27th. A Vermont QSO Party will be held at 1:30 p.m., March 31st; full details available from S.C.M. W1ATP, Eastern Massachusetts is fairly seething with 56-mc. activity; things have reached the stage now where QRM is as much of a problem on that band as on any other, a fact perhaps difficult for amateurs in some other localities to conceive, but none-the-less true! Heads are now turning towards 112 mc. 3700 kc. has been selected as the Western Massachusetts O.R.S. Channel; O.R.S. in that section are equipping themselves with crystals for this frequency. The Worcester Radio Association is attempting to get an amateur radio police network working in Worcester. The Rhode Island Section may surprise some of its larger brothers in traffic work when present A.A.R.S. organization plans in that state are completed! W1AQW operated an amateur station at an exhibition at Bates College, Lewiston, Maine. WIUN at Mt. Washington, New Hampshire, continues to carry out excellent work on 56 mc.; "five-meter" enthusiasts visiting New England should look in on WIUN. W1FRO (Alice Fitzgerald) and W1EVJ are handling Trunk Lines "C" and "G" in Massachusetts. A hamfest will be held in Bridgeport, Conn., at the Hotel Barnum, Sunday, March 24th. Registration starts at 11:00 a.m. Activities start about 2:00 p.m. Banquet at 7:00 p.m. Tickets are \$1.25, with special price of \$1.00 for YL's and YF's. There will be good speakers and good prizes! Tickets are available in advance from W1ACV, 33 Coleman Street, Bridgeport, Conn.

A section paper is mailed each month to every Oregon

amateur reporting to the S.C.M. W7UE of Edmonds, Wash., is believed to be the oldest O.R.S. operator—he is 63 years old! W7NH (Nellie Hart) is Acting S.C.M. of Idaho, following W7AVP's resignation. K7BOE, Pilot Point (Bristol Bay), Alaska, maintains a regular schedule with W7BSJ, Portland, Oregon; the only other means of communication from Pilot Point (mail) takes from three weeks to two months to get to the states; much traffic is handled via the W7BSJ-K7BOE route as well as weather reports and many news items; W7BSJ gave K7BOE first news of the *Macon* disaster; traffic is solicited for this route. Washington's Progressive Contest is "going over in a big way," and Route Manager W7WY deserves much credit for making it a success. W7BVE is now cooperating on Trunk Line "A" in Montana. W7KL and W7HD are now handling trunk lines through Oregon. The Corvallis (Ore.) Communications Club announces hamfest dates—April 13th and 14th.

The gang at W6YG, Santa Cruz High School, had portable rigs on the job in conjunction with the N.C.R., ready to render any assistance necessary at the time of the *Macon* disaster. A Tri-Section meeting was held in San Francisco, February 23rd and 24th. W6BVL at S. F. is now working on Trunk Line "F," the Pacific Coastline route. 56-mc. activity is high in San Diego; at least twenty stations are active on that band. W6USA, new station for the San Diego World's Fair Exposition, is progressing very well according to reports. Attention!! Trans-Pacific traffic handlers!!! W6CUU schedules OMITB, who, in turn, schedules XU8AG in Shanghai. Traffic will be handled into *Shanghai only* via XU8AG, as he is in International settlement there and not subject to Chinese regulations. This information comes from W3QP, Philadelphia, who schedules W6CUU daily except Saturday and Sunday, and invites China traffic; route Chinese traffic via W3QP and W6CUU for good service! W6CYY won the San Joaquin Valley S.C.M.'s (W6FFP) "contest for contest suggestions"; details as to just what the nature of the contest is to be will be mailed to interested amateurs. Not to be outdone by his brother (W6EA), who, on December 30, 1934, was presented with an eight-pound baby daughter, Lyndon Seefred, W6EB, announces the arrival, on January 16th, of Miss Doreen Lynda Seefred! W6ZX, "Pop" Dann, is organizing a "Good Will" network on 7294 kc.; about thirty fellows are already in the net; the "meeting" time is every evening at 7:00 p.m. P.S.T. and Sunday at 9:30 a.m. P.S.T.; traffic is handled, but it is principally a "get-together" network. An official organ, "7294 kc." is published for the members. W6GXM is working up an amateur radio police net in Los Angeles. W6CVV has not missed sending in an A.R.R.L. Communications Department report since June, 1931. Record? W6CH, Los Angeles, has a daily schedule with KA1HR and solicits trans-Pacific traffic. Arizona S.C.M., W6QC/BJF, while riding his motorcycle, was hit by a drunken driver; his leg was broken in three places; we are happy to report that he is recovering OK in a Phoenix hospital. W6KOL is Arizona Trunk Line station on route "D." The Phoenix Radio Experimenters Society will hold its second annual hamfest at Adams Hotel, Saturday, April 13th; price, including banquet, \$1.50.

W3BIG, Virginia 'Phone Activities Manager, is organizing a 'Phone Net, which from all appearances will be a "clandy"! The first 1935 meeting of the Virginia Floating Club was held Sunday, February 3rd, under the auspices of the Richmond Short Wave Club; about 75 were present. Members of the West Virginia Net surprised Mr. and Mrs. W8HWT on their 25th wedding anniversary by each sending a message of congratulations. On February 17th W4FT on schedule with EA4AO had the father of a man in Spain present at his station; the son was at EA4AO; the father was able to hear the voice of his son for two hours, while W4FT sent his words in code.

The Rocky Mountain Division has a "rag-chewing" director; W9AAB rattled W2UL's cans for 3½ hours one QSO! Considerable Naval Reserve interest is being

shown throughout Colorado. The Pike's Peak Amateur Radio Association portable, W9OKY, has been dusted off in preparation for field day. Y7COH and W7DIE are holding down Trunk Lines "G" and "E" through Wyoming. W6FYR is pinch-hitting on Trunk Line "L" in Utah.

The Queen City Radio Club, Gainesville, Ga., is arranging with local police to handle any emergency calls; schedules are wanted with Atlanta and Tennessee. 'Phone activity is very high in Eastern Florida. W4ASR and W4CQD are handling Trunk Lines "C" and "J," respectively, and can QSP anywhere. Activity is picking up greatly in Western Florida; many operators are coming back on the air after rebuilding and general lay-offs. W4MS, S.C.M., is working on 56 mc. and desires to establish a 56-mc. relay route along the Gulf Coast; write W4MS, if you will cooperate. A Western Florida Hamfest in Pensacola will be held during April. W4AJP, Birmingham, Ala., put a death message into the Philippines in twenty-four hours. W4DS handled traffic to Manila, P. I., and the sender received an answer three days later!

New coastal stations are needed for the Gulf Storm Net; any operator from Brownsville, Texas, to Florida desiring to join this net, get in touch with W5BTK, 2213 Avenue K, Galveston, Texas. Oklahoma made an all-time section record for traffic reports; there were more traffic reporting stations for the Jan.-Feb. period than ever before. Oklahoma's Weather Reporting Net continues its excellent service. W5ZM, Roswell, New Mexico, is on Trunk Line "D" and invites traffic for all points.

CANADA

MARITIME DIVISION

MARITIME—SCM, A. M. Crowell, VE1DQ—FR is high traffic man and trunk line station. GL worked eight countries on 3.9 mc. HH handled one message over 300 words long. AL is new man on 3.5 mc. HH, FT, EX and AI are doing some 56-mc. work; the first successful 56-mc. two-way work in P.E.I. EX worked a "G" on his 14-mc. 'phone. VO1W rag chews on 3775 kc. VO1P has new Comet Pro. VO1H is getting R.C.A. ACR receiver. FN worked heavy in VE Contest and DX on 14 mc. DQ is doing some more work on the 'phone. AX is back on 3.9-mc. 'phone again. AW is getting out well with his 'phone on 3.9 mc. EF is also on 3.9-mc. 'phone. GR, AR, DT, AQ, FO and GG keep the 1.75-mc. band hot every night with rag chewing and hook-ups to avoid QRM while working "W's."

Traffic: VE1ER 103 GL 19 HH 10 EX 19.

ONTARIO DIVISION

ONTARIO—SCM, S. B. Trainer, Jr., VE3GT—NX now has unlimited 'phone license. VD is completing new "super." TM pulled a fast one on the Border Cities gang. RO is glad to be back again. ABW is now working all bands. SG is very QRL Queen City Club activities and Army Signal Corps. 9AL seems to like the new doublet. 3QK is editing "MIM," Frontier Radio Club Bulletin. (Have you seen it?) AU is applying Tri-tet to physics at U. of T. PL, along with MX, BI and WY, have been getting 56-mc. activities started in Ottawa. A landlord has "awskd" RK to QRT owing to key clicks. KR has moved to Toronto. VZ sent in a nice report on Hamilton activities. DU is running some nice schedules; he is new R.M. in London district. WK shows how schedules should be kept. ABD has rebuilt and has e.c. freq. meter using '24. JT's eyes are better, and he's back on again. Welcome! MB had visit from UO, and finds business keeps him QRL. The S.C.M. takes the traffic lead, pinch-hitting in Trunk Line "I." The 3.5-mc. VE 'phone band is getting more popular every day. II and JI are quite active on 3.9 mc. QH, JU, KM, QD and QE are on 14-mc. 'phone. HE is back there, too. AFM starts out as a ham with an FBXA. VJ has worked all "W" with 8 watts on '01A. ADD, AAZ, RM, QN and AEQ all visited

SZ. WO is still in N. Y. PO works DX, along with WA, on all bands. ADJ "clinks" next door. HT is working on Hamilton Radio Club ham sheet. The VE Contest went over "big." NO led the Toronto District with 1530, ABW 1330, DJ 1177, GT 1170, JT 1117. NO worked 114 VE's. First prize appears to be between 3IB, 3NO, 1HG, 4SH, 5HQ and 5HR. New officers of the Wireless Ass'n of Ontario: Pres., S. B. Trainer, 3GT; vice-pres., F. W. Hartley, 3JT; secy.-treas., H. Dawley, 3VA. "XTAL," the new Ontario Section Bulletin, is out and the S.C.M. wants your suggestions and criticisms. It is mailed each month to every VES. Notify of changes of address at once. Let's continue to have more reports each month. Ontario is going to "go places." GW has applied for O.R.S. and NC for O.P.S. The "ice" situation at GG has improved. NH, TQ, ADF, HT, QU, CC, BC and ZX pound away. See April "XTAL" for particulars of a new VE3 Contest—open to all VE's.

Traffic: VE8NX 2 VD 5 TM 29 RO 21 ABW-SG 6 QK 97 RK 29 LI 5 TF 28 SA 11 DU 36 WK 42 JT 3 CE 22 MB 11 ZE 2 GT 137. VE9AL 21.

QUEBEC DIVISION

QUEBEC—SCM, Stan Comach, VE2EE—GA is rebuilding; he's having trouble with his final. BU was heard in Europe on 14, 7 and 3.5 mc. EK reports. AP is rebuilding to an '03A and still awaiting his H.R.O. HK is very busy with school activities, but still the traffic total rides high. FB, Doc. CA worked his first K7. DR is pounding all the traffic lanes. IA does not like 14 mc. HI, Bob. EC is putting more meters in rig; watch that grid, Father. BA paid his usual visit to the big city. HT is slightly indisposed; keep that chin up, Ralph. JN visited Montreal; is on now with classy rig. HM made debut on 14-mc. 'phone; sounds swell. IQ is budding traffic man; get yourself a schedule. FQ is building for DG; we know it will be a dandy, Doc. GO is hooking those "G's" on flea power. AC is still hunting on 28 mc. CH is still hunting DX. IE is awaiting new receiver. All Canadian Contest had lots of local support. S.C.M. had most enjoyable visit to the Three Rivers District; thanks for fine time, fellows.

Traffic: VE2AC 5 HK 268 DR 52 AP 6 EK 1 BU 52 GO 3 BB 12 EE 6. EC 23 IQ 2 IA 1.

VANALTA DIVISION

ALBERTA. SCM, J. Smalley, Jr., VE4GD—LX handled 175 QRR messagers. He was closely followed in the emergency traffic by HM, HV/FL, OG and HZ. Other stations in Alberta who handled QRR were AF, HQ, NC, NH, SC, OF and several others of the gang who worked the Army and Navy stations. QK is a new O.R.S. NH, KG, KD and QU give local YL's many a pleasant evening. The AREA intends to hold monthly dinners first Friday in each month at the York Hotel. All Alberta or visiting hams are welcome. A hamfest is billed for Calgary Stampede Week. At least twenty-five Alberta hams are going en-masse to Spokane Convention. AX is busy on a new 'phone. CW, Calgary's first licensed ham, is staging a comeback. IE and CY are back on the air. EO is still DX mad. GX finds his new rig perks better than ever. KG says, "Love and let Love." HI. AW is now a VE5 in northern B. C. GM and BW continue to wrangle on 3.9 mc. BZ claims too many dead nights for the traffic net to be efficient. Believe it or not, GD is on the air again.

Traffic: VE4LX 190 OG 78 BF 61 HM 50 QK 18 LG 10.

BRITISH COLUMBIA—SCM, R. K. Town, VE5AC—We may have had busy and interesting months before this, but never the opportunities for public service that Jan. 21st-28th brought us. The great emergency of January 1935 was the direct result of a two-foot snowfall followed by a week of rain. The February "Amateur" contains letters of appreciation to all those who took part. To better prepare ourselves for the next QRR, I would like to see more join in our B.C. network. The 1.75-mc. net consisting of BR, BL, FN, KN, DC, AS, EK and others did splendid work, while on 3.5-mc.

'phone and C.W. we have NK, AC, JB, FT, ER, GU, 9CY and many others who did their share. On 7 mc. we mention HC, FG, EU, GF, EP and many others. Press and stock reports were handled by FM and KU. Other activities of the month: With the 'phone gang. There seems to be some discussion regarding the proposed code test for 'phone station operators. We hear HI on the 3.5-mc. band. DW gets into Vancouver nicely. BK is doing nicely on 3.5-mc. 'phone. The 1.75-mc. net takes stock to find their average input wattage is 6 watts . . . and they work DX. FB, OM's. EI of Smithers would like more power and a bigger and better B.C. net. FB. HW is reported as having a new "Tet" coming up. IN reports new antenna. BL came to Vancouver for short visit. CK gave an oscilloscope demonstration at the B.C.A.R.A. KN is all praise for the cooperation of the VE4 gang during QRR. OA, Camsell River N.W.T., reports 73° below; nice weather! HQ was QRL VE Contest and did FB. FG likes the 59 Tri-tet better than the old '47. HX is on 3.9-mc. 'phone. MZ is going on 14-mc. C.W. EW actually got on 1.75 mc. to everybody's surprise. HI. Flash! AG becomes proud daddy of YL. Congrats, OM. BJ worked hard during QRR! JP is using Tri-tet 59 and '45 amplifier. IT sends first traffic report. FT did plenty of work during QRR. LI handled QRR traffic. DZ schedules FT, Vernon. CV is QRL Varsity work. FG helped locate lost plane. AS, BL, BR and FN are all on 1.75-mc. net, which did splendid work during QRR. LQ relieved AG on S.S. Uniceana. MD got himself a job. EU got his rig back from North Vancouver; he will be on 3.9-mc. 'phone as soon as his two years are up. Wanted—somebody to neutralize GF's final. EP operated GF during QRR. JU gets on occasionally. JA is trying to live down a rumor that he was blessed with twins—Jack is single. FM prefers traffic and rag chew to DX. DC gave a good account of himself during QRR. NK put in long hours during QRR. DO rebuilt to a TNT. MW was assisted by NH during QRR. II scheduled FU and 1.75-mc. net during QRR. JB was very prominent during QRR. KB worked an LU. HC continues working DX after QRR. AC spent 80 hours at key during QRR. KU did his share during QRR.

Traffic: VE5BJ 21 JP 8 IT 5 FT 10 LI 8 DZ 12 CV 1 FG 68 AS 151 BL 160 BR 250 FN 65 LQ 18 MD 30 EU 77 GF 50 EP 9 JU 3 JA 70 FM 111 DC 48 NK 24 DO 18 MW 61 II 51 JB 294 KB 19 HC 75 AC 131 KU 29.

PRAIRIE DIVISION

MANITOBA—Retiring SCM, Reg. Strong, VE4GC—GC and AG lead in traffic. AC is building a Class B modulator. NR has crystal mike on 3.9-mc. MY has a T250. LEH is selling out, but Ross will keep on with low power. KX just got married so will be QRT for awhile. UX got a 276A. MV, TJ and NW are operating up in Northern Manitoba. EK, RM, MF, UM, SF, NI, KU, LP, TV, CP, VI and TO are all active these days. M.V.E.A. is starting beginners classes from which a lot of new operators are expected. All the boys are getting ready for the coming DX season.

Traffic: VE4AG 47 GC 42.
SASKATCHEWAN—SCM, Wilfred Skaife, VE4EL—CM has daily schedules with MH, BZ and AG. MH has daily schedule with CM and BZ. Your S.C.M. wishes to hear from any who will handle a little traffic. RB works DX on 3.5 mc. CM worked a "G" on 3.5 mc. UP, PE and PW have Autodyne receivers. QS visited the gang at Saskatoon for a week. UD is now getting out. UC and PE are installing crystal. TN is again on C.W. MB is seeking DX. LI worked a K7 on 3.5 mc. IV is trying out condenser mike. RE is rebuilding station. KS is back from the west. FW is trying out 28 mc. IG builds field strength meter for club use. KJ built new receiver and made 610 miles with 5.5 watts input 'phone. GA, GC, QP, OS, KJ, KE, GI, ID, MS, EL, FA, DC, GM, SD, 5LM, 5HU, 5DC, 5MQ and 3WZ had nice round table party on 1.75-mc. 'phone lasting three hours.

Traffic: VE4CM 117 MH 50 GA 17 FL 11 FW 7 KJ 3.



CORRESPONDENCE

The Publishers of QST assume no responsibility for statements made herein by correspondents

Ethics

140 Moriches Road, Riverhead, N. Y.
Editor, QST:

I have been working my ham set in the 75-meter 'phone band and have been reading all the amateur magazines regularly and I've got a lot of things I'd like to talk to you about.

... About this 75-meter 'phone QRM. I don't mind it at all. I like to hear all those stations saying, "Hello test, 1, 2, 3, 4, 5. This is W-blah-blah of Podunk Hollow owned and operated by Joe Blutz and operating on a frequency of blah-blah kilocycles by authority of the Federal Communications Commission. Tum-de-dah, tweet-tweet. When the bloo-o of the night, etc." I like to hear 'em play broadcast announcer because I think it's fun, just like playing Indian and cowboy after going to the movies. I don't believe in dummy antennas; I'd gladly give up my QSO to hear a guy tuning his transmitter and broadcasting the kids fighting and the radio squawking. What's the use of him turning off his microphone when he can play big broadcaster and let the world hear him argue with his OW, not to mention his own singing and whistling?

And then there's this here cross-town duplex. I'd rather have that break up a QSO than anything else. What's the use of reducing power or using five meters or hollering out the window when you can use full power and let the world have the benefit of your chinning with the guy two blocks away? And besides, if you can break a regulation regarding unnecessary power by doing it, why not give the F.C.C. boys something to do. That's why I'm not in favor of us getting any more frequencies—with the gang all crowded together you can lots of times get both sides of one of those duplex QSO's.

In conclusion I want to ask your advice about this overmodulation question. I spent my dough for an oscilloscope tube and had lots of fun adjusting my set so that I got a perfect 100 per cent modulation, but now I get reports (sometimes I can sneak in a QSO while the big broadcasters are eating supper) saying "Your modulation is a bit low, OM." And before, when I was squawking her up to 150 or 200 per cent, I got FB reports. I don't think that it's because hams are so used to overmodulation that they think 100 per cent is too low. I think the oscilloscope is lying so I'm going to knock the base

off and break the screen in and use it for a megaphone. Then I can play Rudy Vallee and knock the spots off the other guys playing big broadcaster. Then I can join in and be a member of our "just one big happy family."

—Murray G. Crosby, W2CSY

P.S. The ex-YL read this over my shoulder and she says she doesn't agree with me. She thinks that guys who do those things are unethical and don't display the true amateur spirit. Some women are that way—just can't understand ham radio.

Amateur Spirit

1180 Anderson Ave., Bronx, N. Y.

Editor, QST:

I wish to say that the 75-meter 'phone men have the real amateur spirit. When the Macon went down on the night of February 12th, station after station signed off, so W2BYM of Lakehurst could get some messages of the disaster from the west coast. . . .

—Arthur R. Szumski, W2DCF-ECP

Threat

Donna, Texas

Editor, QST:

Here is a clipping out of a "Midwest" catalog of Cincinnati, Ohio.

Looks like the amateur is going to be put off the air if the broadcast concerns have their way. . . .

—Orlo Stevens

EDITOR'S NOTE.—The following are significant paragraphs from the clipping sent in by Mr. Stevens:

"The removal of police bands and 'ham' bands from their present location, at about 2000 kilocycles, in order to make room for extensions of the American Broadcast Band has been considered for some time, and is already in progress. If you are going to follow these very exciting stations to their new locations, you must have a Midwest Super Precision, High Fidelity All-Wave set. It is specially designed to bring in broadcasts from the extended American broadcast bands. . . .

"The American Broadcast Band nominally extends from 550 kilocycles to 1500 kilocycles. The Canadian stations, located just outside of

this band, at the low-frequency end, cannot be received by radios that are now obsolete. Experimental work is being done by the Federal Radio Commission, which is placing stations with special privileges just outside the American Band, at the high frequency end. You can expect to receive the Canadian stations as well as the 'Special Privilege' stations only when you own a modern, up-to-date radio like the 1935 Midwest. These extensions have already progressed to 1570 kilocycles, and probably will be extended, within the next few years, to about 4 megacycles. The Midwest Super De Luxe, High Fidelity 16-tube All-Wave Radio is designed to receive stations on this extended portion of the American band."

7-mc. 'Phone

Route 1, Box 398, Vancouver, Wash.

Editor, *QST*:

Although the articles, book-length novels, and other bits of fiction by such worthy authors as WSGDC and W6AAR which have recently blossomed forth in "Correspondence"—giving the 'phones a big hand and ridiculing c.w. men—have proven humorous to some, to the majority of us they are an acute pain in the posterior portion of the anatomy.

In the first place, A.R.R.L. is organized to represent the *American* amateur. We are not concerned directly with the regulations made governing foreign amateurs—it is none of our business what foreign governments should or should not do. Of course we are in sympathy with the other hams, but legally it is none of our business. In his write-up for the 'phones, WSGDC points out that "seven out of thirteen countries specifically authorize 'phone on all bands." I wonder if WSGDC ever paused to consider the difference of numbers of amateurs in U. S. as compared to the number of amateurs in these countries who give the 'phones a more or less free hand? These foreign hams are so much less in number than we are that they do not have the QRM problems to contend with that we do here in the United States.

As to the "dead silence between 1715 and 1800 kc." which WSGDC refers to: The entire band from 1715 to 2000 kc. was just as dead until the recent regulations literally *chased* the inferior 'phone stations up there! C.w. men used this band previously to beat out skip—but now that these inferior 'phones have been chased up there to occupy over two-thirds of the band *legally*, and the other one-third *illegally* with over-modulated junk heaps that spill harmonics over all frequencies between 1800 and 3500 kc., a c.w. man hasn't a chance to use his assigned portion of the band!

WSGDC, as do many others, continually refers to A.R.R.L. without really realizing what it is. "... And at last A.R.R.L. has recognized 'phone . . ." he states. A.R.R.L. is *not* the headquarters staff—A.R.R.L. is an organization of hundreds of *amateurs*. Our affairs are governed *through our directors*. These directors are supposed to take to headquarters the opinion of the *majority*. Since c.w. men have and probably shall always continue to constitute this *majority*, A.R.R.L. has been serving its purpose—even though it may not do everything in accordance with a bunch of hot-headed *individual* opinions as to what is right and what is wrong. If the 'phone men (?) "get disgusted and take away their support from A.R.R.L." they are bigger fools than any 'phone operator has the right to be. Since this 'phone-vs.-c.w. question has come to a head, it has occasioned the birth of a number of "little Caesars" who spring nimbly upon their soap-boxes and shout, "Why pay \$2.50 for *QST*? Buy my magazine for \$2.00 per year . . . follow me and I will get you more frequencies . . . gather around, 'phone men, and we will show these A.R.R.L. fellows a thing or two . . . we will show you the inside workings of this A.R.R.L. . . etc., etc." Bah! Do these mighty leaders even attempt to fulfill

their promises of bettering ham conditions? No! When one of their number is selected to represent ham radio at a world-wide convention, he declines to go. Then when someone else is sent in his stead, he scandalizes him and belittles his efforts. If the 'phones fall for this line of corruption—deserting A.R.R.L. in its favor—they are doing nothing more than throwing away their only chance for gaining more recognition.

One of the latest attacks on c.w. is that "the commercials don't want our bands for the few hundred kilocycles we occupy—they want to chase us out because of the traffic we handle." I suggest that some of these panty-waists who faint at the sight of a key do some actual traffic-handling, and find out just what *kind* of traffic amateur traffic is! Perhaps the commercials are out for our scalp because we handle traffic—but *not* for the reason that we are "stealing" millions of dollars from them by handling traffic; *but*, as long as we continue to handle traffic we are *proving ourselves a public asset*—we mean something to a community. When a disaster breaks and we have our hands tied by not being able to help out with traffic handling—what then? The public no longer is interested in us, for we are useless to them.

Yet, we c.w. operators—the fellows who handle the traffic—the fellows who keep the public constantly aware of the benefits of amateur radio—are now accused of "being a menace to amateur radio . . . less intelligent operators." We are accused of trying to "hog" all the amateur frequencies. WSGDC presents one side of the 'phone question when he states the use of 'phones during the recent earthquake in California. If he had been out here on the coast and listened to the panning handed out to a few 'phone stations who *did* try to handle traffic, he would realize that the 'phone operators on the whole aren't nearly as rose-tinted as he paints them!

When the directors of A.R.R.L. meet and the majority of them deliver the request for more 'phone frequencies—in keeping with the majority opinion which they represent—the 'phones are welcome to their new territory. However, we A.R.R.L. members are not going to recommend new 'phone territory because some group of sissies go off in the corner to pout and threaten to withdraw their support!

—Robert H. Votaw, W7WY

Editor, *QST*:

Briarcliff Manor, N. Y.

Amateurs everywhere pride themselves on being especially proficient in handling the special and unusual communication requirements of the general public. Aside from usefulness in times of major emergencies, there are opportunities continually for contacting travelers, for locating parties of doubtful address, for assistance of the police, for reuniting families and friends, etc. Such activities are rightly within the scope of amateur radio.

Much of this activity is best handled by message relaying. However, everyone will concede that there are many cases in which direct contact between two cities is essential to success. This last mentioned type of communication will stand examination. How can it be accomplished?

Amateur communication is now either by voice or by code. Direct contact between two code stations usually conveys the bare essentials of a situation satisfactorily. But consider the scene at an amateur station when the interested parties are present. Is it not much more satisfactory to have voice transmission at each end? Every member of the public then does not have to know the code to appreciate the service of amateur radio.

Assuming that the answer is "yes" or at least that two-way voice communication is useful to a worthwhile extent, what are the facilities for its accomplishment? It is generally acknowledged that modern procedure is to choose a frequency suitable for a given distance and time.

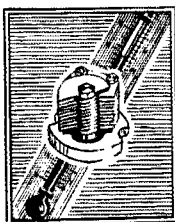

IN THE last few years much emphasis has been placed on the necessity for receivers of high selectivity as a means of combating the crowding of the amateur bands. Selectivity of itself is not particularly difficult to achieve, and a variety of highly selective receivers are of course in general use. However, their use has introduced a comparatively new problem as far as the amateur is concerned, namely temperature drift. A selective receiver that drifts with temperature change is a complete nuisance.

Like other receiver manufacturers, all this did not bother us greatly in the past. Such problems as arose were easily handled by simple methods, and it was not until we tackled the HRO that we became particularly concerned. In the HRO which combines calibrated bandspreading with extremely high selectivity, permanent calibration presented some rather difficult engineering problems along this line. In view of the fact that somewhat similar, though less severe problems occur in designing home-made amateur equipment, their solution may be of general interest.

We found, first, that mica condensers were almost always a source of frequency drift. The use of air dielectric condensers is an obvious and satisfactory answer, and in most cases the substitution involves no difficulty. It is however, essential that these air condensers be designed for low temperature error, as some air condensers have a higher temperature coefficient than good mica condensers. The space required is the principal drawback, and midget condensers are often necessary. We developed such condensers for the FB7, nicknamed "walnuts" because of their size, but even these were too large for one application in the HRO, in which we have used an air condenser about the size of a peanut with the shell off.

The worst offender, mica, being eliminated other sources appear. Perhaps next in order comes the high frequency oscillator. It was found that there were several makes of 224 tubes that just could not be held to one frequency. Fortunately most brands of tubes are satisfactory. We do not wish to make any attempt to classify tube manufacturers in order of merit, but to save correspondence we will add that for one particular receiver — the HRO — we recommend a particular brand of tube — RCA's. This is because the sets are adjusted with RCA tubes, and since tube constants vary somewhat between different manufacturers, it will be necessary to have a factory adjustment if best performance is to be obtained with certain other brands.

To return to the subject, consideration of the oscillator coil is the next step in the elimination of drift. It is possible to compensate inductances by using a bimetallic conductor if certain precautions are taken. This was done in the case of the ten meter oscillator in the HRO. However, in the case of the other ranges, it was found that it was sufficient to place the coil and associated equipment in a location of minimum temperature variation. In practice, this was done by providing double shielding for heat insulation as well as electrical stability, by locating the coils underneath the chassis where they are not heated by other parts, and by using an external power supply.

So many factors affect temperature drift (expansion of the coil shields, for example) that it is practically impossible to calculate the drift of the receiver as a whole. However, if the precautions suggested above are taken and suitably designed component parts are used, it is generally possible to make the final corrections on a trial and error basis without any difficulty.

In mentioning the HRO in the above, we do not wish to give a misconception. We referred to it because we believe it represents an outstanding example of modern temperature correction. Due to each amateur band being spread over ten feet on the dial, you can easily verify this for yourself.

JAMES MILLEN



● FOR THOSE EXACTING SHORT WAVE NEEDS . . .

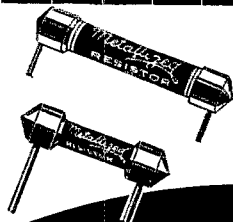
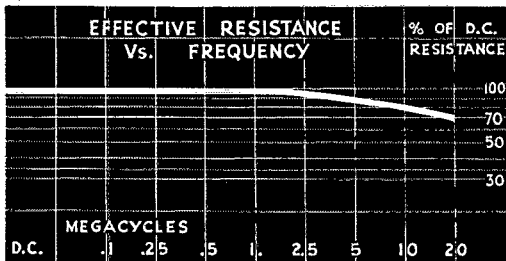

They're
NON-INDUCTIVE!



This chart based on exacting and impartial tests by an outside testing laboratory tells its own story of IRC Metallized Resistor performance on high frequencies—only a change of 30% in resistance value on 20 megacycles!

Compare this with the 100% and 200% changes of ordinary resistors under similar conditions and you will quickly see why IRC Metallized (Filament type) Resistors are unexcelled for the exacting requirements of Short Wave oscillator circuits, AVC filter circuits or as grid leaks across r.f. tubes in addition to all ordinary radio requirements.

You can't go wrong if you standardize on IRC's for every service replacement or amateur need.

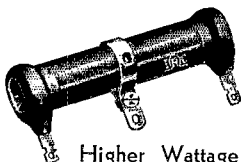

NEW!
**POWER WIRE
WOUND
RESISTORS**

Higher Wattage Ratings in smaller dimensions—lower prices. New cement coating—famous IRC integral moulded contact. All Fixed and Adjustable Types including Heavy Duty Transmitting.

Write for Catalog

INTERNATIONAL RESISTANCE CO.

2100 Arch St., Philadelphia, Pa.

(In Canada, 187 Duchess St., Toronto, Ont.)

Now comes the catch. How will an amateur in New York City, for example, hold direct two-way voice contact with, say, Cleveland, during the middle of the day? The answer is that he will not, unless Mother Nature suddenly decides to put on an exhibition of freak "short skip" on 14 mc. Contacts that would be "duck soup" were 7-mc. 'phone a reality, are now harder than WAC on 56 mc.

But observe the c.w. situation. The same station in New York City can work almost at will any point in the United States at any time of the day or year, by proper choice of the available frequency bands. Would not the culmination of the amateur activities above outlined be better accomplished by making possible such complete continuity of 'phone contacts as are now the rule in the case of c.w.?

—Arthur E. Wilde, Jr., W2AVS

Editor's Note.—Other letters on this subject, publication of which is prevented by space limitations, were received from the following:

For: Duane F. Anstett, W9BTJ; A. Paul Rabito, W5HR; J. T. McCullough, W9BEG; Joseph Hotard, Jr., W5CSD; H. W. Thomas, Jr., W5BPL; M. C. Bartlett, W9JHY; John M. Larsen, W9ABD-W9RSC; J. R. Miller, W9CP; E. A. MacCormack, W9AT; John Buck Morgan, W3QP; Frank Fretter White, W8KIP.

Against: F. J. Mehrtens, W5OK; Leo W. Gushwa, W7BAA-WL7VJ; E. H. Wiseman, W6CPG; C. J. Braddock, W2CJM.

Stop Kicking

29 Zelmer St., Buffalo, N. Y.

Editor, QST:

I wonder if I may be permitted to put in a word or so without having an ear bitten off? I've been in this ham game for more than three years now and a regular reader of QST during the whole period.

What has and still does burn me up are these letters one reads in every issue, letters from fellows who are never satisfied with the way our great hobby is run. Give us more 'phone territory, hollers one. Another, forgetting that he was once a beginner himself, wants the new hams restricted from certain frequencies. A third wants lower power limits, and so it goes on from month to month, year to year.

The fact, and a significant one at that, is that this "ever belching" crew is just an infinitesimal fraction of the ham body in full. Contact any ten fellows on the air and I'm willing to stack dollars to doughnuts that nine of these ten will agree with me that there is absolutely nothing to yelp about. I suppose, though, that these few "sour grapes" are to be found in every walk of life and that amateur radio is not to be excepted. So we'll just have to put up with them. They are really to be pitied, though, because I doubt very much whether many of them really know what it's all about.

Oftimes I wonder how many of the fellows ever stop to consider how really lucky they are to be operating transmitters in this, and not some of the other countries of the world, where amateur radio is heavily taxed and the restrictions and entry qualifications are as tough if not tougher than the proverbial "horse's hide." Then maybe there would be reason for a dissenting voice.

Prevailing laws and reservations in this hobby of ours meet present-day conditions superbly, so until the day when changes are absolutely decreed necessary, not by a few but by the majority, I vote we just go ahead and enjoy the privileges we are so very fortunate now to possess. Let well enough alone and stop kicking!

—Bernard Sikorski, W8FYH

Supplementing Reports

Hawks Nest, Georgetown, Conn.

Editor, QST:

Before leaving for an extended flight about South America, I want to say that I shall regret being off the

SEE YOUR MODULATED R-F ENVELOPE

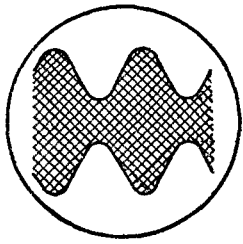

with the

New

RCA CATHODE RAY OSCILLOGRAPH

ACTUAL IMAGE... NO CALCULATIONS... NO SCREEN BURNOUTS

FOR MONITORING MODULATION

Direct monitoring by the use of a *linear* horizontal sweeping frequency gives a *true* image of your modulated r-f envelope. Distortion is indicated by a lack of symmetry or other irregularities. Percentage modulation is shown by the depth of the envelope.

FOR CHECKING DISTORTION

Over-all a-f distortion or individual stage distortion is quickly determined by applying an a-c voltage of constant frequency at any point and examining its wave-shape both before and after amplification. A new synchronizing circuit prevents image drift.

FOR EXAMINING PHASE SHIFT

Phase shift in any stage of the modulation system is easily observed by applying voltages from any two points to the horizontal and vertical deflecting plates. New wide range, high gain amplifiers permit examination of unusually low voltages. Lissajous' figures disclose frequency ratios and phase shift.

FOR SERVICING RECEIVERS

Use of the RCA Cathode-Ray Oscillograph and accessory equipment permits visual alignment of r-f and i-f circuits of radio receivers, thereby giving optimum performance. Any experimental circuit can be rapidly adjusted for maximum efficiency.

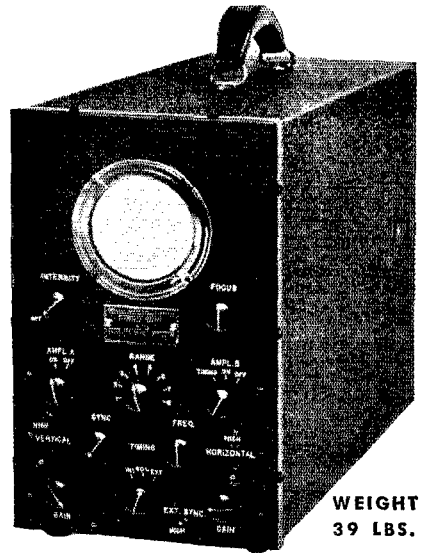

WEIGHT
39 LBS.

\$84⁵⁰ INCLUDES
ALL TUBES

Includes All Tubes—1 RCA-906, 1 RCA-879, 1 RCA-885, 1 RCA-80, 2 RCA-57, Total 6... Linear Sweep frequency oscillator—Range 20—15,000 cycles... Vertical and Horizontal Amplifiers, Range 20—90,000 cycles, Gain 40... Two Power Supplies... Horizontal and Vertical Beam centering adjustments... Sensitivity, 20 to 100,000,000 CPS: 27.0 Volts RMS for 1 inch deflection, 74.0 Volts RMS for full screen image; 20 to 90,000 CPS: 0.7 Volts RMS for 1 inch deflection, 1.9 Volts RMS for full screen deflection.

See this remarkable instrument at your nearest RCA Parts Distributor. Send 10 cents to RCA Parts Division, Camden, N. J., for a complete instruction book and treatise on Cathode-Ray Oscillographs.

RCA PARTS

DIVISION

RCA MANUFACTURING CO., INC., CAMDEN, NEW JERSEY, U. S. A.

Say You Saw It in QST — It Identifies You and Helps QST

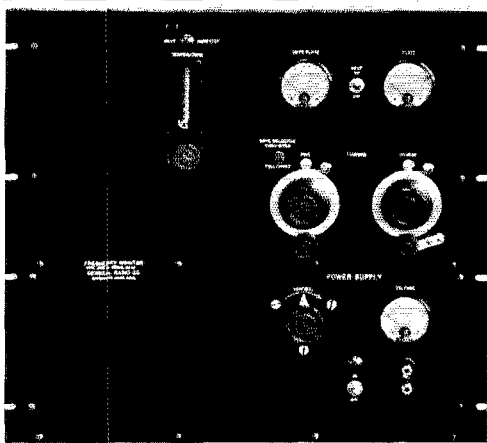

Police Frequency Monitor

A NEW frequency monitor especially designed for Police radio stations, enabling the operating personnel to keep the transmitter on frequency well within the requirements of the Federal Communications Commission.

Piezo-electric oscillator with voltage stabilization — automatic temperature control — heterodyne detector and audio-frequency amplifier — a-c operation — standard relay-rack mounting — output sufficient to give loud-speaker warning to personnel when transmitter deviates from assigned frequency.

Insures legal operation of the transmitter at all times and is simple to install and requires no attention.

Type 475-A Frequency Monitor
\$330.00

Type 376-J or 376-K Quartz Plate
(additional) \$85.00

Complete Details in Bulletin Q-385-A

GENERAL RADIO CO.
30 STATE STREET
CAMBRIDGE A, MASSACHUSETTS

air, and losing contact with my many ham friends. Of course I also realize that I am reducing the QRM on the much contested 7000 kilocycle band by so doing, and that will be a break for somebody.

... It would seem to me that there should be some supplementary mention made of the type of receiver that is reporting the RST or QSA. Inasmuch as I like the new RST system I would recommend reporting some fellow's signals thus: "Ur RST 559X on mi FBXA." By making this addition the fellow at the other end knows what is pulling in his signals and has an even better idea of how he is getting out. . . .

—Frank Hawks, W1111

Analyzing the Anti's

5623 East Side Ave., Dallas, Texas

Editor, QST:

As a rule I can pass off disagreeable thoughts and circumstances, but there is one thing that sticks in my brain, and that thing is the so-called anti-A.R.R.L. faction. About a year ago I started playing a game. Whenever I met another ham on the air or in person, I asked in different ways three questions. First, do you favor the A.R.R.L. policies? Second, why do you favor or disapprove of these policies? Third, how long have you been an amateur?

The replies to these questions were carefully kept and tabulated, and several weeks ago an analysis of them made. The totals in numbers didn't mean a whole lot except that a total of 127 answers was analyzed. The sense of the analysis was the following:

1. 71% of those disapproving of A.R.R.L. policies were not familiar with these policies nor were they able to recall any certain thing in which the A.R.R.L. was completely at fault.

2. 89% of those disapproving of A.R.R.L. policies were newcomers to ham radio of less than two years' experience.

3. 100% of those disapproving of A.R.R.L. policies were unable to suggest anything to take the place of the A.R.R.L. which they seemed to wish to do away with.

Now the whole idea I gained from making this analysis was just this: The anti-A.R.R.L. leaders in reality haven't a thing to raise Cain about, therefore they pass the word from one to another of the new amateurs who do not know the truth about the A.R.R.L. The things they say are not necessarily the truth because they so seldom ever reach print, but do the A.R.R.L. harm even so.

My idea to combat this underhanded work is just this: all you older hams who have been with the League from the beginning, let's start a bit of League advertising, let's talk A.R.R.L. to these new hams; they'll listen. And I believe if each one of us straightens out just four of these new hams we'll have a united amateur group again just as there was when I joined the League in 1920.

—F. G. Southworth, W5EOW—ex-5JJ

Deliveries

P. O. Box 1815, Winston Salem, N. C.

Editor, QST:

We have a very enthusiastic club here at "North Carolina's own Little America," and at our last club meeting a few of our hams passed a motion that I write a letter to be broadcast on the "Correspondence" page of QST, about traffic handling.

We have had trouble in getting messages through to destination on account of someone taking a message from us and filing it away, proceeding to forget it. Now, fellows, in the interest of bettering amateur radio, let's raise our percentage in that line and not take a message unless we get it off the hook at once or at least within the time limit, thus aiding the efficiency of amateur radio.

—Ralph H. Pegram, W4CKJ, Secretary
Winston Salem Amateur Radio Club, Inc.

WE'RE RIDING A WAVE

of increasing interest among wide awake amateurs, who see the many advantages of our new 4-B transmitter advertised last month.

OUR 4X EXCITER UNIT

provides excitation where you want it — when you want it. Just flip 3 switches and tune to resonance on 1.7; — 3.5; — 7.0 or 14 MC.



Type 4X exciter unit (less tubes and crystals) **\$25**

NEW — Low Loss Inductors

for high power amplifiers.

Type A "Air wound" with No. 10 wire on heavy celluloid strips, 7 1/4" mounting centres. Type B for medium power stages wound with No. 14 wire; 5" mounting centres. Both types require only 35 mmfd tuning capacity.

Type A		Type B
\$2.00	1.7 mc	\$1.20
1.50	3.5 mc	1.00
1.25	7.0 mc	.80
1.00	14.0 mc	.70

TRIPLETT METERS

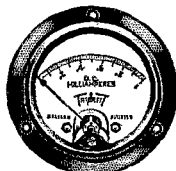

are now available in 2" and 3 1/2" bakelite cases. Exceptionally low prices. For example

2" No. 241	3 1/2" No. 341
\$2.94 D.C. milliammeters 0-5 ma to 0-1000 ma	\$3.75
2.94 A.C. voltmeters 0-1v. to 0-150v.	3.75
5.73 Thermo ammeters with external thermo couples 0-1A; 0-2 1/2 A; 0-5A	6.54

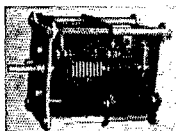

General Radio
S.L.F. split stator condenser; 175 mmf per section; ideal for antenna networks and medium power stages..... **\$1.25**

works and medium power stages..... **\$1.25**

If you already have our B-73 bulletin, a postcard request will bring you the new supplement describing our transmitting equipment. A thin dime brings our complete B-73 bulletin together with those of 25 nationally known manufacturers. No mail order catalog gives half the information contained in this assortment.

HERE TIS!!!

LEEDS new high frequency 210 thoriated filament; genuine molybdenum plate and Isolantite base insure high efficiency on all frequencies. An exceptional value at..... **\$1.75**

"COMPARE"

Another typical **LEEDS** special. Oil emersed filter condensers; cased units with standoff insulator terminals. 2 mmf capacity only.

D.C. working voltage

1,000 volts.....	\$1.75
1,500 volts.....	2.50
2,000 volts.....	2.95

The Cream of the Crop

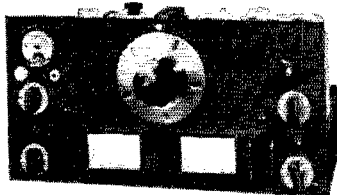

NATIONAL HRO

Now in stock

All the selectivity and sensitivity you can use, with easy one dial control. Priced at **\$139.80** with coils covering 30 M.C. to 1.7 M.C.

NATIONAL TMC

double spaced transmitting condenser; used in our single wire antenna networks; polished plates, isolantite insulation; capacity 300 mmf. A real buy... **\$3.30**

FLECHTHEIM CARBON RESISTORS

with pigtales now in stock. All standard resistance values.

1 watt.....	each 8c
2 watt.....	each 12c



LEADS THE FIELD

World Wide Service to Amateurs

45 Vesey Street
New York City

Cable Address: "RADLEEDS"

LEEDS ANTENNA NETWORKS

provide the last word in convenience, enabling the user to put maximum power into the antenna. Front of panel coil switching spells good-bye to clumsy back of panel adjustments. Networks now furnished with the new General Radio 3" dials as standard equipment. All the dope contained in our B-73 supplement.

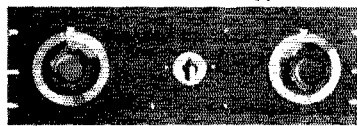

SMASH!!!

Go **LEEDS** Crystal Prices

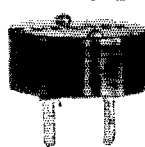

Volume sales on our special offer in Feb. *QST* has enabled us to offer unconditionally guaranteed crystals at unheard of prices. 160 and 80 meter

X cut crystals; plus or minus 1 KC of specified frequency **\$2.25**. AT cut **\$5.00**. 7 mc, plus or minus 2 KC of specified frequency; X cut **\$3.25**. AT cut **\$6.50**.

Monitor molded bakelite crystal holder for all type crystals; fits UY socket..... **\$1.00**

GENERAL RADIO

Amateur accessories are always in stock. Here are two handy forms for that multiband xmitter.

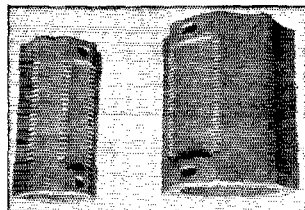

Type 677-U — 21 turns, 2 1/2" diameter, resonant on 3.5 mc with 100 mfd capacity; weight 2 lbs. Price..... **50c**

Type 677-Y — 30 turns 4" diameter, resonant 1.7 mc with 100 mfd capacity. Weight 3 lbs. Price... **75c**
Also 7-pin base to fit above forms at 70c and a matching base with jacks at 65c.

OVERSEAS AMATEURS ATTENTION!

In as much as "thin dimes" are not generally available abroad, our assortment of manufacturers bulletins will be mailed to you on request without charge. Amateurs in 62 countries now employ **LEEDS** fast export service.

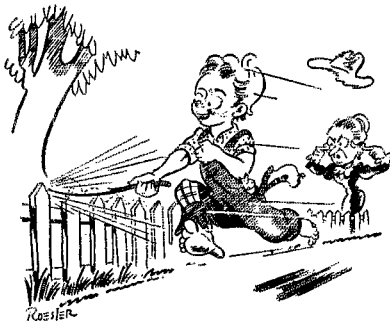

Lady-Call Constable Centralab!

By cracky . . . he'll soon put a stop to that noisy "picket fence" attenuation.

If your radio acts up, Madam, call a good serviceman . . . he'll change that noisy wire-wound control to a *smooth as silk* CENTRALAB Radiohm that will forever banish "picket fence" reception.

Note to servicemen: a mere handful of CENTRALAB RADIOHMS will service practically any radio that is still worth fixing. Employs the smooth, non-rubbing contact in both high and low resistance values. Furnished with fixed minimum external resistor at no extra cost.

**THE NEW
PATENTED
RADIOHM**

Every Radio Service Man should be a member of the Institute of Radio Service Men



Radiohms Resistors
Suppressors Sound Projection Controls

Centralab

Division of Globe-Union Mfg. Co., Milwaukee

Cops Must Read

Topeka, Kans.

Editor, *QST*:

Please change the mailing address of my *QST* from care of police radio station KGZC to my home address. I find it half worn out by the time I get to work.

—Harry N. Thompson

QRM? Nertz

KURX, At Sea

Editor, *QST*:

. . . You guys on HF do not know what QRM is. Just listen to the mess on 500 kc. any evening. . . .

—Forrest D. Masters,
W8DNN-W8GQD-exKUCN-KURX

Standard Frequency Transmission

Date	Schedule	Station	Date	Schedule	Station
Apr. 5	B	W9XAN	May 8	C	W9XAN
	B	W6XX	May 10	B	W9XAN
Apr. 10	C	W9XAN		A	W6XX
Apr. 12	B	W9XAN	May 15	BB	W9XAN
	A	W6XX	May 17	BB	W6XX
Apr. 17	BB	W9XAN		A	W9XAN
Apr. 19	BB	W6XX	May 18	BX	W6XX
	A	W9XAN	May 19	C	W6XX
Apr. 20	BX	W6XX	May 24	A	W6XX
Apr. 21	C	W6XX	May 31	B	W9XAN
Apr. 26	A	W6XX		B	W6XX
May 3	B	W9XAN			
	B	W6XX			

STANDARD FREQUENCY SCHEDULES

Time (p.m.)	Sched. and Freq. (kc.)		Time (p.m.)	Sched. and Freq. (kc.)	
	A	B		BB	C
8:00	3500	7000	4:00	7000	14,000
8:08	3600	7100	4:08	7100	14,100
8:16	3700	7200	4:16	7200	14,200
8:24	3800	7300	4:24	7300	14,300
8:32	3900		4:32		14,400
8:40	4000				

Time (a.m.)	Sched. & Freq. (kc.)	
	BX	
6:00	7000	
6:08	7100	
6:16	7200	
6:24	7300	

The time specified in the schedules is *local standard time* at the transmitting station. W9XAN uses Central Standard Time, and W6XX, Pacific Standard Time.

TRANSMITTING PROCEDURE

The time allotted to each transmission is 8 minutes divided as follows:

- 2 minutes—QST QST QST de (station call letters).
 - 3 minutes—Characteristic letter of station followed by call letters and statement of frequency. The characteristic letter of W9XAN is "O"; and that of W6XX is "M."
 - 1 minute—Statement of frequency in kilocycles and announcement of next frequency.
 - 2 minutes—Time allowed to change to next frequency.
- W9XAN: Elgin Observatory, Elgin National Watch Company, Elgin, Ill., Frank D. Urie in charge.
W6XX: Don Lee Broadcasting System, Los Angeles, Calif., Harold Peery in charge.

Schedules for WWV

EACH Tuesday and Friday (except legal holidays), the National Bureau of Standards station WWV will transmit on three frequencies as follows: noon to 1:00 p.m., E.S.T., 15,000

(Continued on page 88)

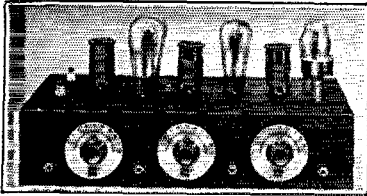

GROSS C C TRANSMITTER—OUTPUT 25-30 WATTS

The "CW-25" transmitter kit due to its low cost makes it possible for anyone to own a modern crystal controlled station. A schematic hook-up and parts layout sheet as well as tuning instructions are furnished, thus enabling the most inexperienced operator to wire and put the set on the air, for real results. The "CW-25" is supplied with a shrivel finished sturdy metal chassis under which all parts are mounted, making the wiring and components dust-proof. A plug-in crystal holder is furnished with the kit. Only one milliammeter is required for tuning the transmitter and each stage is provided with a jack for this purpose. The "CW-25" uses one '47 as crystal oscillator, one '46 as buffer or doubler and two '46's in the amplifier stage, set of three coils supplied with kit for 20, 40, 80 or 160 band. Additional coils 75c each.

Complet kit, less tubes and crystal.....

\$13.95

The "EAGLE" Three-Tube Short-Wave Receiver

"Band Spread" over any portion of the tuning range—only finest material used thruout. Employs one '32 R.F., one '32 detector and one '33 Pentode Audio—15 to 200 meters—four coils, supplied. The "EAGLE" is economical—two dry cells will operate the filaments. See March or April 1933 QST for full description of this most excellent value in short-wave receivers.

"Eagle" completely wired and tested. **\$11.95** Three tubes tested in your receiver. **\$3.00**

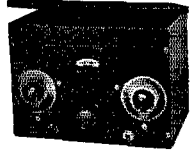

THORDARSON CASED TRANSFORMER

600 volts each side of C.T. 200 MA 2 1/2 V. 10 amps. C.T., 5 V. 3 amps, 7 1/2 V. 3 amps. C.T.....

\$2.45

THORD. CHOKE 12 H 250 MA..... **\$1.95**

MAC-KEY

The perfect semi-Automatic and Straight Key..... **\$10.50**

OUTSTANDING!!

Gross Crystal Holder

WHITE CERAMIC commercial type crystal holder—priced at less than ordinary holders. Adjustable pressure, dust proof, no tools required to open. Takes crystal to 1 1/2" square. Plugs standard 3/4" spacing. **\$1.00** Most efficient job yet.

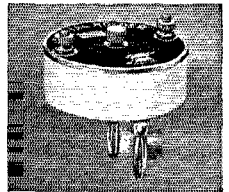

FILAMENT TRANSFORMER FOR BRIDGE RECTIFIERS

Using 83 tubes 5 v-5 v-5 at 3 amps. C.T. — 3000 v insulation..... **\$2.25**
For 866 tubes 2 1/2 v-2 1/2 v-2 1/2 v C.T. — 10,000 volt insulation..... **\$4.50**

GROSS CASED POWER TRANSFORMERS

650 v ea. side C.T. 350 ma. fila. 2-7 1/2 v C.T. and 1-5 v will give 500 v with choke input using 83 or 5Z3 tubes. You can run your entire R.F. and class B off this trans..... **\$5.50**
750 v ea. side C.T. 300 ma. fila. 2-7 1/2 v C.T. and 1-5 v..... **\$5.65**
750-1000 v ea. side of C.T. 300 watts, **\$6.65**
850-1350-1500 v. ea. side of C.T. 400 watts..... **\$8.75** (the ideal job to give 750-1000-1250 v D.C. with choke input)
850-1350-1500 v ea. side of C.T. 530 ma..... **\$12.50**
1500-2000 v ea. side of C.T. 800 watts, **\$11.70**

EXTRA SPECIAL MOUNTED, UNCASD TRANSFORMERS

500-750-1000 volt each side of C.T. 300 watts..... **\$5.50**
400-800 volts each side of C.T. 160 ma..... **\$3.40**

MOUNTED CENTER TAPPED FILAMENT TRANSFORMERS

2 1/2 v 8 a — 2 1/2 v 3 a — 5 v 3 a..... **\$1.29**
2 1/2 v 4 a — 7 1/2 v 2 1/2 a — 7 1/2 v 2 1/2 a..... **\$1.29**
2 1/2 v 4 a — 5 v 3 a — 7 1/2 v 2 1/2 a..... **1.29**
5 v 3 a — 7 1/2 v 2 1/2 a — 7 1/2 v 2 1/2 a..... **1.29**
2 1/2 v 6 a — CT (midget)..... **.75**
5 v 3 a — CT (midget)..... **.75**
6.3 v 1.5 a — CT (midget)..... **.70**
7 1/2 v 3 a — CT (midget)..... **.90**

EXTRA SPECIAL!!! GROSS CASED 20 H. 350 MA CHOKE

Limited quantity, special price.... **\$3.95**

Thord. Choke 15 H 250 MA..... **\$2.95**
Gross Cased Choke 30 H 125 MA... **.88**
Gross Cased Choke 30 H 200 MA... **1.94**

FILAMENT TRANSFORMERS shielded in metal cases, center tapped secondaries

2.5 Volt 10 amperes for 866's..... **\$2.25**
10 to 12 Volts at 8 amperes..... **2.25**

Special 10-12 Volt 7.5 ampere filament transformer, extra special..... **\$1.10**

Cased Combination Filament Transformer

2 1/2 V. C.T. 10 amps. for 866's.
10 V. C.T. 7 amps. for '50's or '52's.
10,000 Volt Insulation..... **\$3.25**

GENERAL ELECTRIC PYRANOLS

We have been appointed distributors of this famous commercial line of capacitors now for the first time available to the amateur.

	1000 V. D.C.	1500 V. D.C.	2000 V. D.C.
1 mfd.....	\$1.78	\$2.23	\$3.12
2 mfd.....	2.67	3.71	4.75
4 mfd.....	4.16	5.35	6.53

Nickel Silver Name Plates

Black background with silver letters and border. Size 1/2" x 1 1/4". Following markings:

Gain	Speech Modulator	Doubler Class-B
Buffer	Class C	Filaments
Amplifier	Plates	Grid
Stand-By	Neutralizer	Crystal
Oscillator	Antenna Plate	
Microphone		

10c each 6 for 50c

The NEW PEAK LINEAR DETECTION RADIO TELEPHONE MONITOR

Covers all Ham phone frequencies. Now in stock..... **\$19.80**

NEW!! 866-A TUBES

10,000 volts Inverse Peak. Special.. **\$1.85**

CASED DOUBLE BUTTON MIKE

Transformers..... **\$1.45**

EIMAC TUBES

Performance — Ruggedness — Power — Price

50-T Output 75 to 250 watts..... **\$13.50**
150-T Output 150 to 450 watts.... **24.50**

CASED FILAMENT TRANSFORMERS FOR EIMAC TUBES

Cased 5 volts CT 12 Amps..... **\$2.95**
Cased 8 volts CT 20 Amps..... **5.95**

CASED POWER TRANSFORMERS

2500-3600 v ea. side C.T. 250 MA. **\$16.95**

200 WATT VITREOUS RESISTORS With Variable Sliders

1000 ohms.....	\$.99
2500 ohms.....	1.05
5000 ohms.....	1.05
10000 ohms.....	1.11
15000 ohms.....	1.20
25000 ohms.....	1.29
35000 ohms.....	1.35
50000 ohms.....	1.44
60000 ohms.....	1.49
80000 ohms.....	1.59
100000 ohms.....	1.65

20% DEPOSIT WITH ALL C. O. D. ORDERS

REMIT BY M. O. INCLUDE POSTAGE

Cable Address: GROSSINC

GROSS RADIO, INC., 51 VESEY STREET, NEW YORK CITY

A Sensational Success!

MARINE 140B
100 WATT PHONE C.W.

X M I T T E R

Many exclusive "MARINE" features ● Power Output (conservative rating) 100 WATTS PHONE and C.W. ● 20-40-75 and 160 meter bands ● CRYSTAL CONTROLLED FREQUENCY ● PERMANENT NEUTRALIZATION ● BUILT-IN BIAS SUPPLIES ● HIGH FIDELITY AUDIO CHANNEL F.R. 30 to 10,000 cycles, plus or minus, 1½ D.B. ● Input Designed for Crystal Microphone Self Contained Antenna Matching Network

Built-in Cathode Ray Oscilloscope

for both trapezoidal and envelope figures
Visual Distortion Indicator —
Modulation Percentage Indicator —

CABINET DIMENSIONS

(Baked wrinkled enamel finish — with rear door)
60" high 19½" wide 15" deep

ONE YEAR UNCONDITIONAL GUARANTEE

Send stamp for descriptive folder with detailed information and photographs. You will be astounded at what we are offering at such an extremely moderate price.

IMMEDIATE DELIVERY!

The New PR-12

PATTERSON

All-Wave Radio

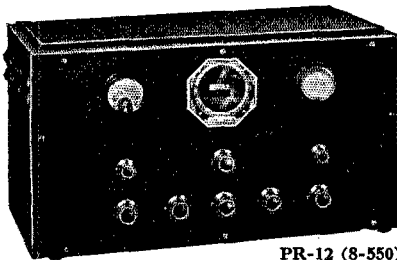

PR-12 (8-550)

Don't buy any receiver until you have
tried the PR-12

Sold on five-day money-back trial

NET DELIVERED PRICES COMPLETE

(absolutely nothing else to Buy!)

PR-12 Crackle cabinet **\$83.70** PR-12 Crackle cabinet **\$89.70**
without crystal with crystal...

PR-12 Console **101.70** PR-12 Console **107.70**
without crystal with crystal...

Chassis also available

SHIPPED PREPAID if Full Purchase Price Accompanies Your Order

L. I. MARINE & ELECTRIC CO.

W2GOT — W2GRQ

163-18 JAMAICA AVENUE JAMAICA, NEW YORK

Telephones: Jamaica 6-2925, Night (long distance) LAurelton 8-0400

Cable Address: "ELEC MARINE NEWYORK"

What the League Is Doing

(Continued from page 51)

parties, for example, conduct their affairs in this manner. Local delegates are selected, frequently are instructed, and then assemble in a convention. The business of the organization is actually done in this general assembly or convention by the votes of delegates. Perhaps you remember "Alabama, 24 votes for Underwood." That is an example of the transaction of business by conventions. This alternative method of government is not employed in A.R.R.L.









As a matter of fact, A.R.R.L. amateur conventions ought not to be called conventions, for that is a word which implies an assembly constitutionally convened for the purpose of doing the necessary business to govern its affairs. Our conventions do not have that power. They are primarily get-togethers for social, fraternal and technical purposes and for general discussion. Nobody has thought of a better name for them so we still call them conventions but everybody is invited to them and *there is no such thing as a delegate to an A.R.R.L. convention.* A.R.R.L. government being by a board of directors and not by conventions, a convention does not have the power to transact the business of the League or to commit the League or its members or to exercise any authority over the directors. If on this subject any member has ever felt a reluctant attitude from the headquarters, it doubtless arises from the necessity on our part to safeguard the traditional system of government established by our present constitution. It will be apparent that we are under the obligation of pointing out unflinchingly that the power of government resides in the directors and that it is not legal for members to choose delegates, send them to a convention, and there transact business in the name of the League.

There remains a perfectly huge field in which there is opportunity for conventions to engage in constructive work. So long as they escape violating the adopted system of government in A.R.R.L. and so long as they do not expect that their resolutions will be instantly put into effect by the headquarters regardless of their relation to existing orders from the Board, they can very profitably engage in intelligent discussions. Their chief value, as we see it, is to *aid the director in knowing the needs and desires of his members.* The opinions adopted ought to be transmitted to the director as an expression of the sentiment of those present. But it should also be borne in mind that even though it be an official division convention, it has no functional ability to express the sentiment of the division in its entirety. The director still has the duty of considering the opinion of those who were not present and of formulating his judgment upon the needs and desires of the division as a whole by taking all expressions into consideration.

With these pitfalls avoided, convention discussions on the topics of the day have a very useful place. Most convention resolutions that we have seen have the appearance of representing a

In the Spring

A YOUNG MAN'S  FANCY **RIGHTLY**
TURNS TO PORTABLE TRANSMITTERS!

Before you know it Spring  is here and then the Summer  when you take a rig out under the trees or stars, experiencing once again (or perhaps for the first time) the thrill of  portable operation. New problems to be solved and fascinating experiments to be made make portable operation a welcome change from the  "home office" operations. Now  is the time to start planning that portable or mobile transmitter and receiver. For the ultra-high frequency receiver (and low-powered, fly-weight transmitter) consider the RCA 955  especially designed for the $2\frac{1}{2}$ and $1\frac{1}{4}$ meter bands. If you want an efficient, compact and easily constructed phone transmitter, the RCA 802  with suppressor-grid modulation warrants your attention. Furthermore, its 6.3 volt heater is conveniently operated from an auto storage battery. If you want a portable with a sock comparable with your main rig, try the husky RCA 801  now priced at only \$4⁵⁰. Technical information on these, any other RCA deForest types, or RCA Receiving Tubes is yours for the asking 

AMATEUR RADIO SECTION • RCA RADIOTRON DIVISION



RCA MANUFACTURING CO., INC. • CAMDEN, NEW JERSEY



To

ENHANCE the appearance of
your station

FACILITATE your reference work

PRESERVE the records of the ad-
vancement of the radio art

you need

QST

Binders

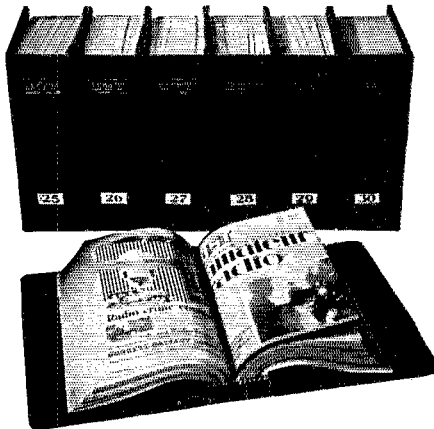

One for this year's issues and one for each of the accumulated year's issues that you have. It will accommodate twelve issues of QST and a yearly index. The QST Binder is covered in deep maroon cloth. It is cleverly designed to take each issue as received and hold it firmly without mutilation. It permits the removal of any desired issue without disturbing the rest of the file.

[Not available outside of the United
States and Possessions, and Canada]

A GOOD INVESTMENT AT **\$1.50** postpaid

NOTE: The illustration shows each binder with a yearly mark. This marking is not stamped on the binder. Simply cut the year label from a calendar, or paste on a piece of paper, marking it in your own handwriting.

American Radio Relay League
West Hartford, Connecticut

stampeding of the assembly in a particular direction by some persuasive talker who was primed for the job, with nobody present who was prepared to present the other point of view. There is generally another side to the question. It seems to us that it would be desirable and beneficial to have intelligent discussions at conventions on the amateur topics of the moment, under arrangements that would insure the thoughtful and intelligent examination of the subject by properly prepared people. Amateurs ought to know a great deal more about their affairs than they do. We encourage a better understanding, and we suggest that it is the duty of the older and saner fellows to give a helping hand from their greater fund of experience and endeavor to lift, from within, the general level of amateur understanding about our problems.

Financial Statement

The appearance of the new Handbook in the last quarter of the year, itself frequently the best quarter from the business standpoint, together with the general improvement in business conditions, combined to give the League in the last quarter of 1934 the greatest gain from routine operations that it has experienced in any three-months period. For the information of members the operating statement is reproduced below, at the instructions of the Board of Directors.

STATEMENT OF REVENUES AND EXPENSES FOR THE THREE MONTHS ENDED DECEMBER 31, 1934

REVENUES	
Membership dues.....	\$16,823.78
Advertising sales, QST.....	16,574.08
Advertising sales, Handbook.....	1,402.50
Newsdealer sales, QST.....	15,851.24
Handbook sales.....	10,443.31
Booklet sales.....	2,572.07
Interest earned.....	269.19
Cash discounts earned.....	296.14
Membership supply sales.....	2,703.02
	<hr/>
	\$66,935.33
<i>Deduct:</i>	
Returns and allowances.....	\$3,991.17
Increase in provision for news- stand returns of QST.....	627.82
Cash discounts on sales.....	426.25
Exchange and collection charges.....	1.97
	<hr/>
	5,047.21
Net Revenues.....	<hr/>
	\$61,888.12
 EXPENSES	
Publication expenses, QST.....	\$13,715.31
Publication expenses, Handbook.....	6,446.13
Publication expenses, Booklets.....	821.68
Salaries.....	19,252.08
Membership supplies expenses.....	1,416.23
QST forwarding expenses.....	705.89
Telephone and telegraph.....	707.53
Postage.....	1,987.00
Office supplies and general ex- penses.....	2,475.60
Rent, light and heat.....	835.69
Traveling expenses.....	2,332.76
Communications Department field expenses.....	185.37
Headquarters station expenses.....	108.21
Bad debts written off.....	246.24
Federal tax on checks drawn.....	6.74
Depreciation of fixed assets.....	225.53
	<hr/>
Total Expenses.....	51,467.99
Net Gain before Appropria- tions.....	<hr/>
	\$10,420.13

"Attention Amateurs"

Our New Fully Illustrated
RADIO PARTS CATALOG

Is Just Off the Press

Offering the LATEST in ALL NATIONALLY KNOWN PARTS
LINES—At Competitive NET PRICES

Our Large MAIL ORDER DEPARTMENT Offers Complete
Stocks—PROMPT SERVICE—and

PRACTICAL ADVICE ON ALL AMATEUR PROBLEMS

AMATEURS
IN ATTENDANCE

W6DUX
W6KMT
W6DMW

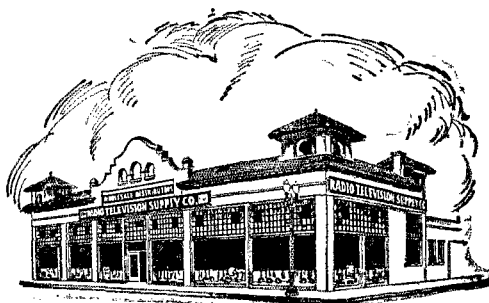

AMATEURS
IN ATTENDANCE

W6EGH
W6ELR
W6JQW

YOUR REQUEST FOR OUR NEW CATALOG
WILL RECEIVE OUR IMMEDIATE ATTENTION

We Solicit Your Patronage

RADIO TELEVISION SUPPLY CO.

1701 South Grand Avenue
LOS ANGELES, CALIFORNIA

All Phones • RICHmond 6123

Where to buy it

A directory of suppliers who carry in stock the products of these dependable manufacturers.



BUTLER, MO. Henry Radio Shop 211 N. Main St.

CHICAGO, ILL. Midwest Radio Mart 520 S. State St.

CHICAGO, ILL. 833 W. Jackson Blvd.
Allied Radio Corp.

CHICAGO, ILL. 415 N. Dearborn St.
Chicago Radio Apparatus Co.

CINCINNATI, OHIO 633 Walnut St.
Steinberg's, Inc.

CLEVELAND, OHIO 2073 West 85th St.
Northern Ohio Laboratories

COLUMBUS, OHIO 178 N. 3rd St.
Hughes-Peters Electric Co.

DAYTON, OHIO 140 E. 3rd St.
Burns Radio Company

DENVER, COLO. 1639 Tremont St.
Inter-State Radio & Supply

DES MOINES, IOWA 1212 Grand Ave.
Iowa Radio Corporation

DETROIT, MICH. 171 E. Jefferson Ave.
Radio Specialties Company

EL PASO, TEX. 618 Montana St.
Western Battery & Magneto Co.

FT. WORTH, TEX. 1808 St. Louis Ave.
Amateur Supply Company

FRESNO, CALIF. 2501 Tulare St.
B. J. DeJarnatt

FRESNO, CALIF. Ports Manufacturing Co.

GRAND RAPIDS, MICH. 235 Market St.
Radio Distributing Company

HOUSTON, TEX. Travis at Calhoun St.
Straus-Frank Company

INDIANAPOLIS, IND. 316 N. Illinois St.
State Distributing Company

KANSAS CITY, MO. 1012 McGee St.
Burstein-Applebee Company

KANSAS CITY, MO. 1515 Grand Ave.
Radio Laboratories

LOS ANGELES, CALIF. 912 S. Broadway
Radio Supply Company

LOS ANGELES, CALIF. 1701 S. Grand Ave.
Radio Television & Supply Co.

LOS ANGELES, CALIF. 729 S. Main St.
Pacific Radio Exchange

LOUISVILLE, KY. 911 W. Broadway
P. I. Burks & Company

MILWAUKEE, WISC. 332 W. State St.
Radio Parts Company

OAKLAND, CALIF. 12th & Fallon Sts.
Electric Supply Company

OMAHA, NEB. 2855 Farnham St.
Radio Accessories Company

OKLAHOMA CITY, OKLA. 130 W. 3rd St.
Southern Sales Company

PEORIA, ILL. 707 Main St.
Klaus Radio & Electric Co.

PORTLAND, ORE. 1207 S. W. Washington St.
Wedel Company, Inc.

ST. LOUIS, MO. 1100 Pine St.
Walter Ashe Radio Co.

ST. PAUL, MINN. 2484 University Ave.
Lew Bonn Company

SAN ANTONIO, TEX. 301 S. Flores St.
Straus-Frank Company

SAN DIEGO, CALIF. 744 G Street
Coast Electric Company

SAN FRANCISCO, CALIF. 1452 Market St.
Offenbach Electric Co.

SAN FRANCISCO, CALIF. 1025 Market St.
I. S. Cohen's Sons

SEATTLE, WASH. 520 Second Ave.
Wedel Company, Inc.

SIOUX CITY, IOWA 647 Water St.
Warren Electric Company

SPOKANE, WASH. 611 First Ave.
Spokane Radio Company



CHICAGO, ILL. 927 W. Madison St.
Newark Electric Company

CHICAGO, ILL. 520 S. State St.
Midwest Radio Mart

CHICAGO, ILL. 833 W. Jackson Blvd.
Allied Radio Corp.

CINCINNATI, OHIO 633 Walnut St.
Steinberg's Inc.

CINCINNATI, OHIO 111 East 5th St.
Krauss Radio Stores, Inc.

Where to buy it

A directory of suppliers who carry in stock the products of these dependable manufacturers.

CLEVELAND, OHIO Northern Ohio Laboratories	2073 West 85th St.	CINCINNATI, OHIO Steinberg's, Inc.	633 Walnut St.
CLEVELAND, OHIO Goldhamer, Inc.	610 Huron Road	CLEVELAND, OHIO Northern Ohio Laboratories	2073 W. 85th St.
COLUMBUS, OHIO Hughes-Peters Electric Corp.	178 N. 3rd St.	CLEVELAND, OHIO Cleveland Distributing Co.	1301 Superior Ave.
DES MOINES, IOWA Iowa Radio Corporation	1212 Grand Ave.	DETROIT, MICH. Radio Distributing Co.	129 Selden Ave.
DETROIT, MICH. Radio Distributing Co.	129 Selden Ave.	ESCANABA, MICH. Delta Hardware Co.	400 Ludington St.
DETROIT, MICH. Aitken Radio Corp.	1326 E. Congress St.	GRAND RAPIDS, MICH. Radio Distributing Co.	235 Market St.
FARGO, N. D. Dakota Electric Supply Co.	123 Broadway	KANSAS CITY, MO. Moser & Suor, Inc.	McGee at 23rd St.
GRAND RAPIDS, MICH. Radio Distributing Co.	235 Market St.	PEORIA, ILL. Klaus Radio & Electric Co.	707 Main St.
HONOLULU, T. H. Mutual Telephone Co.		PORTLAND, ORE. Stubbs Electric Company	33 N. W. Park Ave.
LOS ANGELES, CALIF. Leo J. Meyberg Co.	35 West Washington St.	SAN FRANCISCO, CALIF. San Francisco Radio Exchange	1284 Market St.
OAKLAND, CALIF. E. C. Wenger Co.	1020 Oak St.	SEATTLE, WASH. Seattle Radio Supply Co.	2319 2nd Ave.
PEORIA, ILL. Klaus Radio & Electric Co.	707 Main St.	TOLEDO, OHIO Baumgardner Distributing Co.	1013 Jefferson Ave.
PORTLAND, ORE. Harper-Meggee, Inc.	17th & Irving Sts.		
ST. PAUL, MINN. Lew Bonn Company	2484 University Ave.		
SAN FRANCISCO, CALIF. I. S. Cohen's Sons, Ltd.	1025 Market St.		
SEATTLE, WASH. Harper-Meggee, Inc.	Republican & Terry Sts.		
SPOKANE, WASH. Harper-Meggee, Inc.	So. 122 Lincoln St.		
TOLEDO, OHIO Aitken Radio Corp.	1014 Madison Ave.		
YOUNGSTOWN, OHIO Ross Radio Company	46 E. Federal St.		



ATLANTA, GA. Wholesale Radio Service Co.	430 W. Peachtree St., N. W.
CHICAGO, ILL. The Radolek Company	601 W. Randolph St.
DES MOINES, IOWA Iowa Radio Corp.	1212 Grand Ave.
DETROIT, MICH. Radio Specialties Co.	171 E. Jefferson Ave.
KANSAS CITY, MO. Burstein-Applebee Co.	1212 McGee St.
LOUISVILLE, KY. P. I. Burks & Co.	911 W. Broadway
NEWARK, N. J. Wholesale Radio Service Co.	219 Central Ave.
NEW YORK, N. Y. Wholesale Radio Service Co.	100 Sixth Ave.
WICHITA, KANS. Stimson Sales & Investment Corp.	1107 E. Douglas

ANTENNA

IMPROVE YOUR CIRCUIT with a



THERMO-COUPLE Instrument

WIDELY accepted as the most advanced meter for high frequency measurements, this Triplet instrument will improve your circuit. It is characterized by long-life design and high overload capacity.

When the Triplet Thermo-Couple Ammeter is included in circuit, it may be placed on a panel at a distance from the antenna leadin. This precludes the possibility of upsetting the circuit, and permits placing meter on panel where it can be more conveniently read.

The thermo-couple is external to the meter, permitting the use of different ranges of couples with the same instrument and their replacement in the event of a burn-out. Triplet couples withstand a 50% overload and are connected to the instrument with 2' leads.

Triplet Electrical Instrument Co.

134 Main Street

Bluffton, Ohio

NO. 341 — 3"
Model

This is one of the many Triplet instruments, furnished in 2', 3', 4", 5', 6", and 8" sizes . . . and all popular ranges and types

See the Triplet Thermo-Couple Ammeter

AT YOUR JOBBERS!
List Price \$10.00

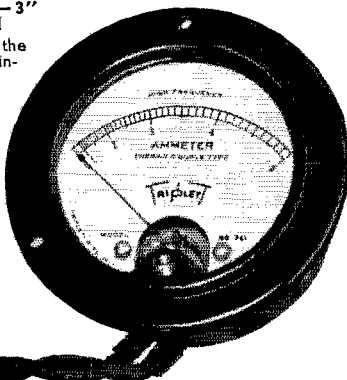

TRIPLET ELECTRICAL INSTRUMENT CO.

134 Main Street, Bluffton, Ohio

Please send me your literature on Triplet Instruments

Name

Street Address

City.....State.....

Schedules for WWV

(Continued from page 50)

kc.; 1:15 to 2:15 p.m., 10,000 kc.; 2:30 to 3:30 p.m., 5000 kc. These emissions are accurate to better than 1 part in five million at all times and are readily useful for calibrating amateur-band frequency meters by harmonics from an auxiliary 100-kc. oscillator, as described in previous QST articles (June and October, 1933; February, 1934).

Experimenters' Section

(Continued from page 54)

final amplifier. (See Fig. 6.) The wire of the coil must, of course, be heavy enough to carry the plate current of the amplifier. This system will work equally well with a self-excited oscillator coupled directly to the antenna as the wavetrapp does not affect the tuning.

"For the 38-meter band, a coil of ten or twelve turns on a small form shunted by a 140- μ fd. midget variable condenser will do the trick very nicely. A neon lamp cannot usually be used as there isn't enough power on that harmonic to start it, but in a high-power rig one should be able to get it to light up. On low-power transmitters, a monitor tuned to the undesired frequency must be used, and the wavetrapp tuned till the harmonic either disappears entirely or is much weaker, depending on the power of the transmitter.

"I might add that while testing with W9JZJ we both listened on 38 meters and it sounded very much like the 20-meter band. All kinds of ham signals were heard, with c.w. on the low-frequency end, 'phones on the high end, and commercials interspersed throughout!"

—M. W. Mitchell, W9IQZ

With the Affiliated Clubs

(Continued from page 50)

Radio Association had a hard enough time getting to and from work, without braving the drifts to get to club meeting. But "the meeting must go on." In truly up-to-date fashion the P.R.A. gang held their meeting, storm or no storm—on 56 mc. About fifteen members were present at this "meeting on the air" and everything went off without a hitch. The P.R.A. members are 56-mc. hounds from now on!

Worthy Efforts

Clubs can do much to strengthen the position of amateur radio by running down and eliminating all forms of illegal operation within their localities. Enforcement Committees are being appointed in various clubs for this purpose. B.C.L. educational programs are also valuable to prevent amateurs from being blamed for every nature of interference; well prepared newspaper items, aimed to help the B.C.L. better understand what amateur radio is, are a great help to this end. In these days of "all-wave receivers" amateurs cannot do too much explaining of their activities; it is too easy for the uninitiated to get a distorted view of our hobby.

IN THE WEST

The AMATEUR'S Headquarters

are at the

RADIO SUPPLY CO.

912 South Broadway + Los Angeles, Calif.

*All the latest Nationally Advertised
Parts and Kits in stock at all times*

9 LICENSED AMATEURS ON OUR STAFF AT YOUR SERVICE

RADIO ENGINEERING



RCA Institutes offers an intensive course of high standard embracing all phases of Radio. Practical training with modern equipment at New York and Chicago schools. Also specialized courses and Home Study Courses under "No obligation" plan.

Illustrated Catalog on request.

RCA INSTITUTES, INC. Dept. ST-35
75 Varick St., New York 1154 Merchandise Mart, Chicago
Recognized Standard in Radio Instruction Since 1909

**New QUIET VOLUME
CONTROLS and RESISTORS
for Every Amateur Purpose**

Write Dept. Q
for Catalog.

175 Varick St., New York, N.Y.
ELECTRAD

NEW COMMERCIAL TYPE
RADIO ROOM CLOCK
meeting **RULE 296-C**

Of the Federal Communications Commission

Every amateur will welcome this new precision clock, which meets the above rule for the ship service and also all international requirements under provisions of Par. 1, Art. 23, Gen. Radio Regulations, International Telecommunication Convention of Madrid. Sweep-seconds hand. 24 hr. dial with 2 hands gives Greenwich and local time. 4 second marks and 3 min. silent periods marked in red on dial. Price \$55.

FREE CIRCULAR—describing clock and summarizing national and international recommendations and requirements. Write direct to:

CHELSEA CLOCK COMPANY
BOSTON, MASS.

ASTATIC

CRYSTAL MICROPHONES AND PICKUPS

Guaranteed instruments, known for their quality, dependability and ruggedness. Extensively used in both Professional and Amateur fields. Send for your literature today!

ASTATIC MICROPHONE LABORATORY INC., YOUNGSTOWN, OHIO

M. & H. Ham Specials

New! Ceramic
Lead-in Insulators **38c**

Overall length, 5 inches. Bowl type. Complete with Gaskets and Wing Nuts.

High Voltage Transmitting
Condensers

2MFD, 1000 Volts, \$1.75 each

2MFD, 2000 Volts, \$2.95 each

Oil impregnated

Continental Carbon
Microphone

2-button Studio Type. Brand new. In original cartons. Regular \$50 list. Special... **\$16.95**

Send for big 1935 Catalog

**M. & H. Sporting
Goods Co.**

512 Market Street, Philadelphia, Pa.

CONCENTRIC GRID 56 MEGACYCLE OSCILLATOR

Completely built ready to operate. Uses any type of triode — 210, 245, 800, etc. Signals from a Concentric Grid transmitter can be received on a superhet.

COMPLETELY BUILT
LESS TUBE

\$12.45

SPECIFY TUBE
YOU INTEND TO USE

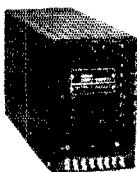

K & R 550V. 200 MA. POWER SUPPLY

2½V. @ 10A. — 7½V. @ 5A.
TWO-SECTION FILTER

Uses 83 rectifier

EXCELLENT
REGULATION **\$15.00**

THE IMPROVED CATHODE-RAY OSCILLOSCOPE

Linear sweep model for broadcast stations and advanced amateurs, physics labs., etc.

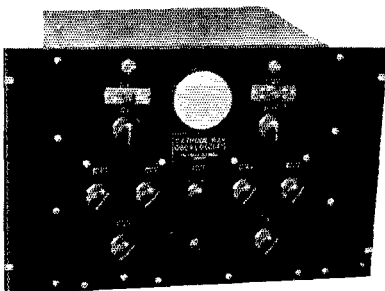

★ Controlled linear sweep. ★ Controlled external sweep
★ Preg. locking device for sweep frequency. ★ Picture
centering adjustments. ★ Wide range focus adjustments.
★ Complete component shielding. ★ Unit is self contained
and includes batteries and 110V-60 cycle power supply.
★ Tubes RCA 906-885-234-281-280. ★ This instrument
embodies all features ordinarily contained in only the
highest priced Cathode Ray equipment.

Completely Equipped Ready to Use

F.O.B. Newark—\$97.50

Literature now available

R.F. REACTORS

are the MODERN and PERFECT r.f. chokes

Type	RFR-1	RFR-2	RFR-3
Suggested Operating Band — mc.	1.7— 4 to	3.5 to 14.4	7.0 to 30
Inductance Value — μ h	170	70	30
DC Ohms.	5.5	3.5	1.5
DC Current-amps.	2	2	2
Price.	\$1.05	\$.90	\$.75

KALTMAN & ROMANDER

62 Court Street

Newark, N. J.

The Columbus (Ohio) Amateur Radio Association helped run down local interference being blamed on hams by B.C.L.'s. The committee in charge included W8GDC, W8CKG and W8IYO. The activities of this committee will continue along similar lines when needed.

The Connecticut Brasspounders Association is working on several cases of illegal 56-mc. operation. One of the members is watching the 56-mc. band about twelve hours per day and is tracing down the guilty parties.

The Ocean County Radio Association (New Jersey) has been securing some very good publicity for amateur radio in four local newspapers. The comparison of "broadcasting" and "amateur radio" brought out in this publicity should help B.C.L.'s to understand our part in the radio picture.

Visit the Clubs

At A.R.R.L. headquarters there are recorded the addresses of the several hundred amateur radio clubs affiliated with the League, their places and times of meetings. Clubs are splendid places to get acquainted with other amateurs and to participate in interesting discussions on amateur radio. Why not drop in at your local club and "meet the gang"? Address the Communications Manager (enclosing 3¢ stamp, please) for data on affiliated Clubs in your vicinity.

—E. L. B

I.A.R.U. News

(Continued from page 56)

Haiti: Signal Co., 1st Brigade U. S. Marine Corps, c/o U. S. Naval Radio Station NSC, Port-au-Prince.

Hong Kong: H.A.R.T.S., Box 651.

Hungary: National Union of Hungarian Short-Wave Amateurs, VIII, Mátyás-tér 6, Budapest.

India: B. M. Tanna, Ismail College, Jogeshwari, Bombay.

Iraq: L. A. C. Lewis, No. 1 A.C.C., R.A.F., Hinaidi, Baghdad.

Irish Free State: R. V. N. Sadleir, Esq., Lonsdale, Roebuck, Clonskeagh, Dublin. (Cards for Northern Ireland go to R.S.G.B., England.)

Italy: Do not send any QSL cards to Italy until further notice. Cards can be sent to A.R.R.L. to be held, pending change in the situation there.

Jamaica: Cyril M. Lyons, 2-B North St., Kingston.

Japan: J.A.R.L., Box F-77, Tokyo.

Java: Th. F. Leyzers (via), Van Heutz Boulevard 2, Batavia, Centuz.

Jugoslavia: Stephen Liebermann, Meduluceva 9, Zagreb.

Kenya: George F. K. Ball, Box 721, Nairobi.

Latvia: A. Karklin, 2 Lenca dz. 8, Riga.

Lithuania: L. R. M., Post Box 100, Kaunas.

Luxembourg: J. Wolff, 67 Avenue du Bois.

Madeira: See Portugal.

Malaya: Thos. G. Laver, Supt. Gov't Electrical Power Station, Johore Bharu, Johore.

Mexico: L.M.R.E., Sinaloa 33, Mexico City.

Morocco: A.A.E.M., BP 50, Casablanca.

Netherlands: N.V.I.R., Post Box 400, Rotterdam.

New Zealand: N.Z.A.R.T., P. O. Box 517, Dunedin.

Norway: N.R.R.L., P. O. Box 2253, Oslo.

Palestine: D. Window, Royal Air Force, Ramleh.

Peru: Radio Club Peruano, Apartado 538, Lima.

Poland: P.Z.K., Nowy Swiat 21, Warszawa.

Porto Rico: Francis M. McCown, Family Court No. 7, Santurce.

Portugal: R.E.P., Rua Primeiro de Dezembro 33-3, Lisbon.

LEEDS LEADS AGAIN

With Single Signal Reception at Prices Every Ham Can Afford

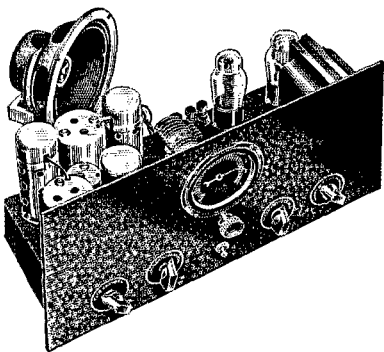

On the second anniversary of J. J. Lamb's article on S.S. reception with a super het employing a regenerative I.F. stage, comes LEEDS' adaptation of the "ALL STAR JUNIOR" super het to S.S. reception.

The standard "ALL STAR" kit is sponsored by 11 leading radio manufacturers to fill the demand for low cost, all wave, band spread reception. The complete kit, including all parts, drilled chassis, panel, and complete instructions can be assembled and wired in 5 hours with screw driver, pliers and soldering iron at the amazingly low cost of

\$27.97
6" Dynamic Speaker\$2.50
Matched Kit Sylvania Tubes.....\$3.47

BRASS We supply the additional parts and instructions necessary for conversion to single signal reception at \$2.25.

As a finishing touch LEEDS black crystalline finished metal cabinet

\$3.85
LAZY HAMS — The "ALL STAR JUNIOR" completely wired and tested \$5.00 extra.

A postcard request brings the 4 page "ALL STAR" new bulletin to you. Remember — ALL STAR "SINGLE SIGNAL" is exclusively LEEDS.



World Wide Service to Amateurs

45 Vesey Street
New York City

Cable Address, "RADLEEDS"

All Wave 30 MC to 540 KC continuous band spread. Beat oscillator for C.W. reception. Excellent sensitivity and selectivity. Uses 1 — 6A-7; 1 — 6F-7; 1 — 77; 1 — 42 and 80 rectifier.

Resistance coupled audio insures faithful reproduction with dynamic speaker. Humless built in 110 v. — 60 cycle power supply. Optional S.S. reception.

RADIO COURSES

Radio Operating

Prepare for Gov't license exam.

Radio Amateur Code

Radio Servicing

Including short wave receivers.

Resident Courses

Write for Booklet

NEW YORK YMCA SCHOOLS

4 West 63rd Street, New York City

*We Have Not Been Making
Immediate Delivery on the*

**PATTERSON PR-12
NATIONAL HRO
HAMMARLUND SUPER-PRO**

We can ship as soon as the manufacturers are definitely in production

Prompt Shipments on

COLLINS TRANSMITTERS

RME9D—RCA ACR-136

DELAWARE RADIO SALES CO.

405 Delaware Avenue

Wilmington, Delaware

PANELS — BAKELITE — RUBBER — ALUMINUM

All Sizes Cut to Order — BAKELITE TUBING & RODS
Drilling, Engraving & Special Work

ALUMINUM GANS—Stock sizes. Special sizes, made to order.
ALUMINUM CHASSIS—Threaded brass studs for 6/32 screws.
Length from 1/2" to 6"—price 5c to 30c.

Insulating bushings for all size shafts



Couplings in brass for Bakelite—15c



UNITED RADIO MFG. CO.

Transmitting frames and racks
Est. 1923 191 Greenwich St., New York

PRECISION CRYSTALS

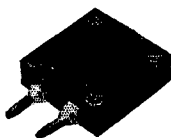

Crystal Holder—\$1.00

'X' and 'AT' cut crystals one inch square carefully ground for frequency stability and maximum output. Be sure of your transmitter frequency use PRECISION CRYSTALS. Guaranteed to be the highest quality obtainable.

'X' cut PRECISION Crystals carefully ground for maximum power supplied to your specified frequency accurate to 0.1% and calibrated to within 0.03% are priced as follows:

1750 and 3500 kc. bands—\$3.00 each. 7000 kc. band—\$3.50. Add \$1.00 to above prices if plugin, dustproof holder is desired. Jacks to plug holder into — \$.15 pair.

The 'AT' cut crystal recently developed has a temperature coefficient of practically zero and will handle more power than ordinary crystals. 'AT' cut crystals ground to your specified frequency accurate to 0.1% and calibrated to within 0.03% are priced as follows: 1750 and 3500 kc. bands — \$6.00 each. Crystal holder — \$1.00. Jacks for holder \$3.15 pair.

Crystals and ovens for commercial use quoted on at your request. When ordering our product you are assured of the finest obtainable. Now in our sixth year of business.

PRECISION PIEZO SERVICE

427 Asia Street

Baton Rouge, La.

To OUR READERS

who are not

A.R.R.L. Members

YOU should become a member of the League! That you are interested in amateur radio is shown by your reading of *QST*. From it you have gained a knowledge of the nature of the League and what it does, and you have read its purposes as set forth on the page opposite the editorial page of this issue. We should like to have you become a full-fledged member and add your strength to ours in the things we are undertaking for Amateur Radio. You will have *QST* delivered at your door each month. A convenient application form is printed below — clip it out and mail it today.

A bona fide interest in amateur radio is the only essential qualification for membership

AMERICAN RADIO RELAY LEAGUE

West Hartford, Conn., U. S. A.

I hereby apply for membership in the American Radio Relay League, and enclose \$2.50 (\$3.00 outside of the United States and its Possessions, and Canada) in payment of one year's dues, \$1.25 of which is for a subscription to *QST* for the same period. Please begin my subscription with the..... issue. Mail my Certificate of Membership and send *QST* to the following name and address.

.....
.....
.....

Do you know a friend who is also interested in Amateur Radio, whose name you might give us so we may send him a sample copy of *QST*?

.....

Thanks

Roumania: Dr. Alex Savopol, Radio Club Craiova, Rosetti 6, Craiova; or Lieut. ing. F. Dinescu, Ecole Polytechnique, Bucarest.
Salvador: J. Frederico Mejia, 7a Calle Poniente 76. San Salvador City.
South Africa: S.A.R.R.L., P. O. Box 7028, Johannesburg.
Spain: U.R.E., Apartado 262, Madrid.
Sweden: S.S.A., Stockholm 8.
Switzerland: U.S.K.A., Neu Allschwil near Basle.
Uruguay: U.S.W.C.G., Box 37, Montevideo.
U.S.S.R.: C.B.S.K.W., Karuninskaa pl. 2/5, Moscow.

A Modern Transmitter

(Continued from page 35)

"ruffed" the note up a bit. Didn't match the other one so well. They are so cheap that I put 'em in in pairs, now, and seldom have trouble. New ones, you understand—not ex-BC receiver tubes.

Don't get excited. Lay off that key till we tune up the final. First cut the primary rheostat back to "Max." resistance and (with the a.c. off) cut off the positive high voltage to the final. Being a Bradley carbon-pile rheostat, screwing it all the way out automatically opens the primary. Now, with the a.c. on again, and the oscillator and buffer running normal, close the test switch, *Sw5*. What does the grid meter, *M1*, say? Well, never mind, let's tune up the final. There—tuning the tank causes the grid meter to flop. Roughly, that is resonance on the tank. We'll set the neutralizing condensers *C7* to about half capacity. Less kick now as we tune the final tank over resonance. Very carefully adjust the neutralizing condensers, keeping their capacities equal, until the final tank tuning does not change the grid current in the slightest in slowly passing through the resonance point. Now set the final tank back, as nearly as possible, to the dial setting that indicated resonance before we neutralized.

Disconnect the side of the coupling coil *L1* that goes to the antenna net. You may leave the grounded side on. Keep the key and test switch open. Turn the primary rheostat of the plate transformer in until we get about 300 volts. Now close the key. About 100 mils? Tune the tank. Whoa! there is the dip—scarcely any plate current. Touch up the buffer tank tuning a little. That cut it down a few mils. Next cut the final's high voltage again and recheck the neutralizing. It may be a shade off and that won't do. OK now. Let's get 300 or 400 volts on the tens again.

TUNING THE ANTENNA NET

Check that tank tuning for exact resonance—minimum plate current. Now, don't touch any of the final tuning controls again. Reconnect *L1* to the antenna net. The plate current has hopped up to 75 or 100 mils again. Set *C* at half capacity and rapidly tune *C1*. There, that's back to minimum plate current again. If it isn't, readjust *C* a little and retune *C1* until the dip is obtained, just as though you were resonating the tank. But don't touch that p.a. tank condenser setting. You will upset all this work if you do.

On 160 meters the antenna is working against ground and we get perhaps an ampere antenna current. If the antenna net doesn't seem to act

20,000,000,000,000,000 Vibrations AND STILL GOING STRONG

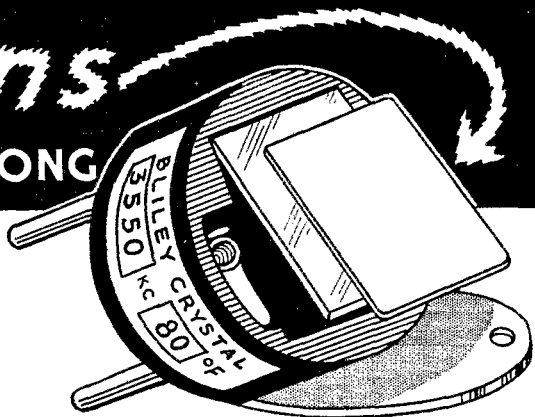

When you consider that an 80 meter crystal vibrates over 12 billion times every operating hour and a 40 meter over 25 billion times, it's no wonder that cheap poorly made crystals can't stand the gaff.

It's not unusual to receive letters telling of undiminished power and efficiency of Bliley Crystals after four years of use — an equivalent of over 20 trillion vibrations!

Performance records like these make Bliley Crystals the choice of leading amateurs everywhere. For the greatest dollar and cents value in crystals use Blileys. All progressive distributors of amateur equipment sell them.

WRITE FOR NEW CATALOG G-6



BLILEY ELECTRIC CO.



ERIE, PENNSYLVANIA

BLILEY Crystals from \$3.95 Up!

MC Band	Supplied to specified frequency within:			
	Exact F.	± 1Kc	± 5Kc	± 10Kc
7.0,3.5	\$7.50	\$5.90	\$4.90	\$3.95
1.7	8.40	6.80	5.80	4.80

Crystals manufactured between 20Kc and 15Mc

The WHERE TO BUY IT Column—

appears for the first time on pages 86 and 87 of this issue. It should prove of great value to discriminating buyers of dependable amateur radio equipment.

Paid for jointly by manufacturer and dealer, advertising in this column is a cooperative effort by which progressive manufacturers make it possible for their dealers to take direct advantage of their national advertising.

Rates for manufacturer and dealer advertising in this column are available upon application to QST Advertising Department, West Hartford, Connecticut.

ECONOMY



Save money by insisting on Aerovox transmitting condensers. First, by getting genuine quality, reflected in long and satisfactory service. Second, by comparing these prices based on popular demand and mass production:

Type 1005 — 1000 v.				
Cap. mfd.	Size	List Price	Your Price	
1	2 x 5 1/8"	\$3.20	\$1.92	
2	2 x 5 1/8"	4.95	2.55	
4	2 1/2 x 5 1/8"	6.00	3.60	
Type 2005 — 2000 v.				
1	2 x 5 1/8"	\$4.75	\$2.85	
2	2 1/2 x 5 1/8"	6.50	3.90	

Send for 1935 CATALOG . . . covers complete Aerovox line of condensers and resistors. Also sample copy of monthly Research Worker.



CORPORATION

73 Washington St.



Brooklyn, N. Y.

NOW

Here is something you have always wanted

A sensitive, rugged, moving coil Dynamic Microphone

Clean cut speech without background noise or annoying power supply

And the Price—

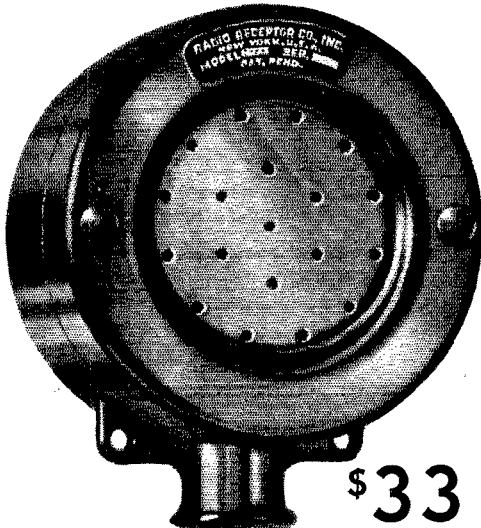

\$33

U. S. PATENTS PENDING

Write for our introductory ARRL offer

RADIO RECEPTOR CO., INC.

108 7th Ave., N. Y. City

Here It Is! **MARTIN JUNIOR**

Think of it!

A Genuine MARTIN Vibroplex for only \$10

All standard features. Heavy contact points. 2 3/4 pound black japanned base. The only difference is in size. Ideal for radio. Easy to use. A bargain at this low price. Don't wait — order **YOURS NOW!** Remit by money order or registered mail.

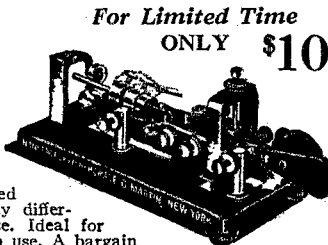

For Limited Time ONLY **\$10**

BUY! NOW!

OTHER VIBROPLEX MODELS

Famous Improved Vibroplex, Black or Colored, \$17; Nickel-Plated, \$19. Easy-Working Vibroplex No. 6, Black or Colored, \$17; Nickel-Plated, \$19. Write for Catalog.

THE VIBROPLEX CO., INC.

825 Broadway

New York, N. Y.

right, readjust the number of coil turns and repeat the tuning. The correct combination seems to be where the tuning of C will vary the antenna current from a low value up to maximum and on down the "other side" to low again, in a smooth, even manner, the final plate current following in the same proportion. But the minimum dip in plate current must be maintained by adjustment of C_1 , with each change of C . Never change the tank tuning for any reason, except a QSY.

On the higher frequency bands the antenna, in my case, is working as an end-fed Hertz (or Fuch's, if you prefer) and very little, if any, antenna current will show up. Here, a neon lamp or, better, an r.f. galvanometer, will give an indication of resonance in the antenna circuit. The end-fed Hertz is very simple and effective; and, since the transmitter is near a window on the third floor, the antenna runs straight out with only a few feet inside. It is kept reasonably well clear of everything and the losses surely are not more than with a more complicated radiating system that requires complicated adjustment—and then must be kept on or very near its one proper frequency. Weather changes alone will upset it, and you must either ignore it or mess with it. This end-fed thing seems to soak up great gobs of r.f. with the least fuss; and all its tuning is here on the sunny side, thanks to Collins.

But let's get on with the keying adjustments.

KEYING AND MODULATION

What does it sound like now? Still OK? Open the key. There's still plate current on the final. Here, adjust this voltage divider R_2 —up towards "positive." As soon as the plate current reaches absolute zero, stop. The grid is now "blocked." In other words, the grid voltage, with respect to filament, is so negative as to stop completely all plate current flow. Once the resistor R_3 is adjusted for minimum sparking, we're ready to go. In passing, let's mention that W. H. Hoffman described this beautiful version of clickless keying back in September 1925 *QST*, on page 30. It has been, like many other good things, rediscovered many times since.

Let's see what this final will do now. The grid current is 23 mils? Jack up the plate voltage. There, that's 800 volts. By twiddling C and C_1 , the plate current can be made anything from 20 to 200 mils or more. Wait—we will make the plate voltage 1000! Adjust C and C_1 so we get 150 mils. 150 nice, smooth, rock-solid watts input. Can those tens take it! Overloaded? Well, maybe. Sylvania says 20 watts maximum plate dissipation per tube, 40 for the pair. Who said they had more than that now? The input doesn't mean everything. You can either burn up 40 watts input heating the plates, or soak up most of it in the antenna which, if it's any good at all, in turn boots the power through space. As for the extra plate volts, I have not yet lost a ten due to flash-overs—but I do take the utmost care in correct adjustments. You say the graphite plates won't get noticeably warm, even though the plate dissipation is high? Well, here, put in these old

40% DISCOUNT

PRACTICALLY ALL LINES

NATIONAL PARTS AND SETS
HAMMARLUND PARTS AND SETS
ELECTRAD PRODUCTS
ARCTURUS RECEIVING TUBES
EIMAC TRANSMITTING TUBES
BURGESS BATTERIES
CORNELL-DUBILIER CONDENSERS
BILLEY CRYSTALS AND HOLDERS
THORDARSON TRANSFORMERS
FLECHTHEIM CONDENSERS
SANGAMO CONDENSERS

AEROVOX CONDENSERS
INCA TRANSFORMERS
PYREX INSULATORS
OHMITE RESISTORS
ALLEN D. CARDWELL
TRIPLETT METERS
READRITE METERS
WESTON METERS
ACME PHONES
TRIMM PHONES
AND MANY OTHER LINES

► **Complete Stock of Amateur Books!!** ◀
MAIL ORDERS AND INQUIRIES HANDLED PROMPTLY!!



"The House of a Million Radio Parts"

1452 Market Street
San Francisco

OPEN EVERY DAY OF THE YEAR

GULF RADIO SCHOOL

Radiotelegraphy

Radiotelephony

Radio Servicing

SECOND PORT } 1007 Carondelet Street
U. S. A. } NEW ORLEANS, LA.

PEAK MONITORS

IN STOCK **\$19.80** IMMEDIATE DELIVERY

SHIPPED PREPAID If Full Purchase Price Accompanies Your Order

L. I. MARINE & ELECTRIC CO.

"Everything for the Ham"

163-18 Jamaica Ave.

Jamaica, N. Y.

BIRNBACH Superior INSULATORS



"NEW, Better, Larger Variety!" That's the Birnbach slogan that saves you money and headaches. Our newest feature is a remarkably efficient Transmitter Lead-In Insulator (3 1/2" to 9"). Also "Navy-Type" with center anchor-hole for transmission line. And "Feed-Thru," "Wing-Nut" and standard standoffs. Strong, highly-glazed ceramic with rounded corners and edges. Nickel-plated brass hardware.

Write Dept. Q-4 for Details

BIRNBACH RADIO CO., Inc.
145 HUDSON STREET NEW YORK CITY



STANDOFF

• TWO OUTSTANDING PEAK DEVELOPMENTS •

LINEAR DETECTION RADIO TELEPHONY MONITOR
This newest PEAK product brings to your ears the audio component of the carrier being monitored. Audio distortion in any form, carrier and audio hum, can be immediately heard. 110-125V. 50-60 Cycles

It's a necessity for proper operation of any radiotelephone station on all bands from 5-200 M. Not for C.W. Now on sale at Jobbers everywhere. List price \$33.00 with usual discounts to Hams. Ask your dealer, or send us for literature.

REGENERATIVE PRESELECTOR—PREAMPLIFIER
Predates and Modernizes Your Present Receiver

Hams everywhere are talking about this great development. Gives you brilliant reception with your present receiver. Here's what P-11 gives you: 1. Tremendous Increase in Signal Strength. 2. Increase in Sensitivity. 3. Rejection of Image. 4. Increased Selectivity. 5. Reduction of Noise to Signal Ratio. List Price, less tubes, \$33.00. 40% discount to Hams. Your cost.....\$19.80

110-125V. 50-60 Cycles

EASTERN RADIO SPECIALTY CO.

Manufacturers of PEAK Products

1845 Broadway ■ Dept. Q-45 ■ New York, N. Y.

Ask your Dealer about PEAK M-2 and P-11 today

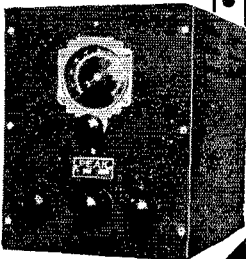
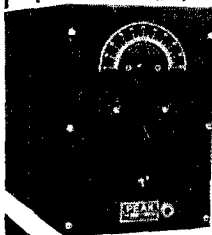

Say You Saw It in QST — It Identifies You and Helps QST

ALWAYS FIRST

TYPE TC-30020

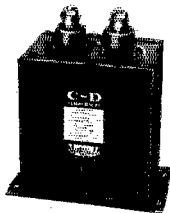

C-D

2 MFD.—3000V—DC.

PYRANOL X-MITTING CONDENSERS

Cornell-Dubilier was the first to make the famous Pyranol heavy duty x-mitting condensers available to amateurs — the same type of non-inflammable capacitor as used by leading broadcasting stations. Amateurs you can now obtain these fine condensers at new low prices from leading jobbers and mail order houses.

LOOK FOR THE C-D LABEL

CORNELL-DUBILIER

CORPORATION

4373 BRONX BOULEVARD
NEW YORK

EIMAC

TRANSMITTING TUBES ARE
UNSURPASSED
FROM THE STANDPOINT OF
POWER GAIN

The high transconductance and flat grid current characteristic of the EIMAC 150T and 50T enable high power output and high plate efficiency to be realized with the minimum of grid drive. Also remember that abnormally high bias and plate voltage is unnecessary.

TYPE 150T \$24.50

TYPE 50T 13.50

AT YOUR DEALER

—“COMPARE AND REFLECT”—

EITEL-MCCULLOUGH, INC.

SAN BRUNO, CALIF.

deForest 510's. They ran for almost three years at no less than 125 watts input. I don't see those "tin" plates heating, do you? That means that the plate dissipation is within reason and the rest of those watts are being heard but not seen. Sure, I know all about the filaments being good for only so many electrons per second and that trying to drag out more by overshooting the tube rating shortens their life. But 10's cost less than third of what 50's do and, since three years of this punishment just seem to have toughened these babies up nicely, I figure I am slightly ahead of the game. Confidentially, these Sylvania g.p.'s have been run at 300 watts input at 1500 volts without any evidence of funny business and 801's act just the same. Careful tests show practically no difference with other good tens, at least at frequencies lower than 7000 kc.

As a rule, I dislike overloading any equipment, as is evidenced in the foregoing description. By intelligent handling, however, plenty of fellows run all kinds of tubes greatly in excess of ratings, and figure it pays. So while these tens, at 150 watts input, continue to QSO every W and VE district, and occasionally G, F, ON, PA, HB, HO, VO, etc., as they have on 3.5 mc., I'll let 'em roar! They *do* take it—and how! But be fair about it. If you "blow" them in this manner, don't decry their maker. And give the tubes plenty of air circulation!

For occasional 'phone operation the audio line up is a tandem 53, resistance-coupled, driving a 2A3 which is impedance coupled to the 845 Class-A modulator. The input is from a double-button Kellog b.c. mike. The 53 and 2A3 have a separate power pack which also provides bias for the 845. The modulator reactor tap goes to the 845 plate, so the regular c.w. high-voltage supply furnishes the d.c. for both.

In closing, the writer wishes to state (with the permission of the F.C.C.) that this was not written of his own free will but that he was egged on to do it; that, in fact, he was forced to perform the job under dire threats. But he has the last laugh. Everything was copied out of *QST* anyway—although maybe you, foolishly, haven't saved your back issues.

An RK-20 Transmitter

(Continued from page 44)

able. If a power pack is used, it is desirable that an audio by-pass condenser of at least one or two μ fd. be connected across its terminals. The secondary of the modulation transformer is simply connected in series with the lead from the negative terminal of the bias supply to the suppressor grid connection, as shown in Fig. 3.

As pointed out by a note on the subject in March *QST*, for linear modulation it is important that the screen-grid voltage be supplied from a voltage divider across the plate supply and not from a separate fixed-voltage source. The variations in screen voltage with modulation operate in such a way as to straighten the modulation characteristic in a sort of compensating effect

DOES YOUR
HANDBOOK
LOOK LIKE
THIS?



OR . . .

HAVE YOU A BRAND NEW 1935 TWELFTH EDITION HANDBOOK

With the sweeping changes in short-wave radio technique that have been made since publication of the 1934 eleventh edition?

The chapters devoted to apparatus design and construction have been re-written all through, with new illustrations and new circuit diagrams. Needless to say, the new methods and technique which have so recently almost revolutionized ultra-high frequency work have been treated in full detail.

Nothing in the book that does not represent the very latest practice

268 pages—237 illustrations, postpaid \$1
(Buckram bound, \$2)

AMERICAN RADIO RELAY LEAGUE, INC.
WEST HARTFORD, CONNECTICUT

Say You Saw It in QST — It Identifies You and Helps QST

FT-30 Transmitter

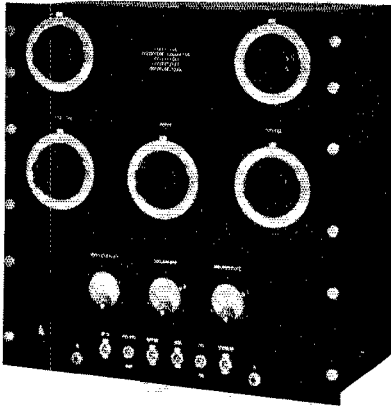

A complete radiophone transmitter of medium power, featuring commercial type construction and appearance, fixed neutralization, and isolantite insulation.

Full data and prices furnished on request

Harvey Tritet less tubes and crystal \$42.50

RK-20 Amplifier with two tubes \$69.50

Latest additions to our popular ultra-high frequency line include Type HF-4 non-radiating receiver and Types RTM and RTF Transmitter-Receiver combinations for the General Experimental frequencies.

Write for information

HARVEY RADIO LABORATORIES
12 BOYLSTON ST. BROOKLINE, MASS.

HIPOWER CRYSTALS

Now available at your dealer
Accept no other

HIPOWER "A" CUT HANDLES 300% MORE POWER

HIPOWER "A" CUT in 1700-3500 Kc. Bands \$3.90
within 10 Kc. or choice of dealers stock
HIPOWER "X" CUT in 1700-3500 Kc. Bands \$2.35
within 10 Kc. or choice of dealers stock
HIPOWER "Y" CUT in 1700-3500 Kc. Bands \$1.35
within 10 Kc. or choice of dealers stock

You cannot buy a better crystal
than HIPOWER at any price!



TYPE M molded bakelite holder plug-in tube socket \$1.00

FREE plug-in mounting
with each holder

If your dealer cannot supply you
order direct and enclose dealer's name

For complete data on "A" cut and other HIPOWER crystals, write for Bulletin E. Broadcast crystals supplied with less than 1/2 cycle drift per million, per °C.

HIPOWER CRYSTAL CO.
3607 NO. LUNA AVE., CHICAGO, ILL. TEL. AVE. 5170

which is absent when the screen voltage is fixed at a steady value. For this reason also there should be no audio by-pass across the part of the voltage divider from which the screen voltage is taken.

To adjust the transmitter for modulation, first tune it exactly as already described for c w. work, with the suppressor 40 or 50 volts positive. When the tuning is satisfactory, note the antenna or load current and apply negative bias to the suppressor, increasing the bias until the antenna current drops to exactly half its maximum value. The negative suppressor bias required will be in the vicinity of 45 volts, so that the use of a small-size "B" battery will be convenient and economical. Modulation may then be applied, taking care that the level does not become high enough to cause the plate-current meter reading to vary. The antenna current will kick upward slightly with modulation, but the rise ordinarily will not exceed five or ten percent with voice input. Adjustment of a suppressor-grid modulated phone is simplicity itself.

POWER SUPPLY

The power supply for the RK-20 oscillator should be capable of delivering about 150 milliamperes at 1000 volts. Of this current, 80 to 100 ma. goes to the plate of the tube, about 30 to the screen grid, and 10 or 20 to the bleeder and voltage-divider. Design data for a power supply of this type will be found in the *Handbook*.

A possibility for an inexpensive power supply lies in the alteration of a 550-volt power transformer of the type used in the older broadcast receivers having Type 50 tubes in the output stage. These transformers, usually have two 7.5-volt filament windings, one of which can be used to light the filament of the RK-20. The other could be removed and three 2.5-volt windings put on instead, using No. 16 or No. 18 wire. These windings would then be used to light three Type 82 rectifiers in the bridge circuit shown in Fig. 1009 in the twelfth edition *Handbook*, the low-voltage filter being omitted. Using a two-section filter with electrolytic condensers in series to stand the voltage, a 1000-volt power supply having sufficient capacity to handle the transmitter with either keying or modulation could be built at relatively little cost. The rectifier filament windings should be well insulated from each other.

A "200-Watt" Transmitter

(Continued from page 20)

the oscillator is operated as a straight pentode by closing switch Sw_1 , thus shorting out the tuned cathode circuit. Switch Sw_2 is thrown to the left, thereby cutting out the 59 buffer stage, and the filament of the 59 is disconnected by opening Sw_3 . For 7 mc., the oscillator is again used as a pentode on 3.5 mc., the second 59 being used as a doubler to drive the 10 buffer. Sw_2 is thrown to the right and Sw_1 and Sw_3 are both closed. On 14 mc. Sw_1 is opened, a 7-mc. coil is used at L_2 , and the second

There Are Two Ways

Yes — there are two ways to get your hands on the kind of Short Wave Receiver you've always been dreaming about. The first way is to build it yourself — along grand lines — to work out your circuit with the country's best engineering talent at your elbow — to put into it the finest parts anybody's money can buy — to lavish on it all the building skill at your disposal. That would be the royal road to a great Short Wave Receiver. But it's a way only a rare few of us can take.

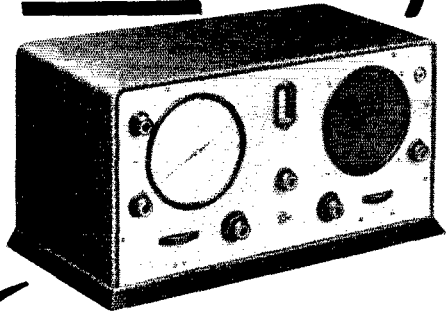

the hallicrafters

THE HALLICRAFTERS, INC.
3001-I Southport Ave.
Chicago, U. S. A.

Send me your interesting new 16-page booklet fully describing the Super SKY-RIDER. Also send me the name of my nearest dealer.



Name.....

Address.....



The other way is to get yourself the Super SKY-RIDER. It's the kind of Short Wave Receiver you would be proud to say you had designed and built yourself. The circuit includes such features as: • Four Separate Short Wave Bands • Smooth Electrical Bandsread • High Gain R.F. Pre-selector • Built-in Frequency Meter and Monitor • Air-tuned I.F.'s • Beat Frequency Oscillator • Crystal Filter Circuit • Built-in Speaker and Power Supply, etc. The finest parts that can be bought at any price are built into the Super SKY-RIDER with the utmost precision and skill. We have squeezed into this set that last bit of fine craftsmanship which is reflected in our exhaustive final tests in superb all-around performance. The best way to perfect Short Wave reception is to own the Super SKY-RIDER.

28 and 56 M.C.

TWIN-TRIODE

- TRANSCIEVERS
- DUPLEX UNIT TRANSMITTER-RECEIVERS

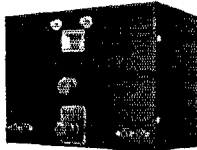

TRANSCIEVERS, each employing push-pull oscillator, Class B modulator. 19, 53 or 6A6 tubes, 10" x 7" x 5".

\$22.50 and \$26.50

COMBINATION - TRANSMITTER - RECEIVER UNITS, each with push-pull oscillator, Class B modulator transmitter and separate receiver employing r.f. stage. Built-in dynamic speaker. 10" x 14" x 5". 19, 53 or 6A6 tubes. \$36.75 and \$39.75

Write for prices on custom built equipment
Bulletins on Request

RADIO TRANSCIEVER LABORATORIES

8627-115th Street Richmond Hill, N. Y.



LEARN CODE the easy way with INSTRUCTOGRAPH

No experience necessary to become an expert Radio or Morse operator. Book of instruction explains each step.

You can buy or rent INSTRUCTOGRAPH. Write TODAY for full details. No obligation.

INSTRUCTOGRAPH CO., Dept. Q4

912 Lakeside Place Chicago, Ill.

Representatives for Canada

RADIO COLLEGE OF CANADA, Ltd., 863 Bay St., Toronto

READ AND SEND CODE

Learn Easily at Home This Quicker Way

No experience needed. Beginners read code quickly, copy accurately. If already an op, speed up your wpm with this amazing improved Master Teleplex. Only instrument ever produced which records your sending in visible dots and dashes on embossed copper tapes then sends back your own key work. Fascinating, fool-proof; gets results because you learn by HEARING as well as seeing. Used by U. S. Army and Navy, R. C. A., A. T. & T., and others. We furnish Complete Course, lend you the New Master Teleplex, and personal instruction with a MONEY-BACK GUARANTEE. Low cost, easy terms. Write today for folder Q. 28, no obligation.

TELEPLEX CO.

76 Cortlandt St.

NEW YORK, N. Y.

MASTER TELEPLEX — "The Choice of Those Who Know"

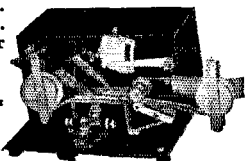

ANNOUNCING The Turner

"DIA-CELL" Microphone

The latest development in high-fidelity microphones. Uses three to eight crystal units connected in series — parallel. Basically flat response from 30 to 10,000 cycles. Licensed under "BRUSH" Patents. Descriptive circular and prices mailed on request, or see your jobber for complete details.

THE TURNER COMPANY
CEDAR RAPIDS, IOWA

2-Kw Maximum Power?

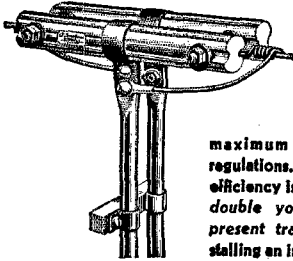

No, as an amateur you can't use a 2 Kw. Transmitter, for that's just twice the maximum allowed under F.C.C. regulations. But — if your antenna efficiency is low, you may be able to double your radiation with your present transmitter, simply by installing an improved radiating system!

Many amateurs have achieved remarkably improved performance after installing a Johnson Type "Q" Transmitting Antenna System . . . their letters prove it! Even in the commercial field, "Q"'s are adding to the reliability and efficiency of press radio, airways communication, and broadcast radio pickup links.

The Johnson line includes everything you need for your high-efficiency antenna — Type "Q" Antenna System, Johnson Enameled Copperweld Wire, Antenna and Transmission Line Insulators. Any Authorized Johnson Distributor will gladly give you descriptive literature.

E. F. JOHNSON COMPANY
Manufacturers of Radio Transmitting Equipment
WASECA, MINNESOTA, U. S. A.

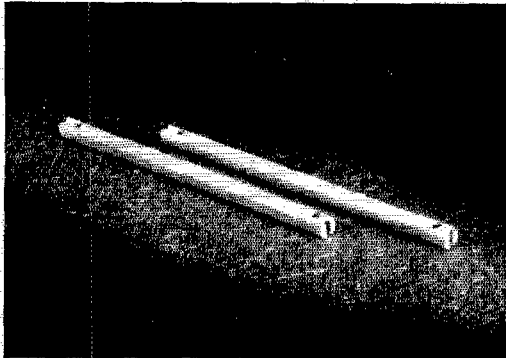

SPREADER: Light in weight as well as exceptionally efficient, these Statite spreaders offer unusual advantages. The material is non-hydroscopic and weatherproof. The slender shape minimizes surface leakage. The power factor is of the order of 0.15%. The weight is but one ounce each. Catalog Symbol AA-3.

List Price \$.30

Usual Discounts apply

NATIONAL COMPANY, INC.
MALDEN, MASS.

59 doubles to 14 mc., exciting the 10 on that frequency. The 10 buffer stage, therefore, is operated as a straight amplifier on all frequencies.

For plate modulation the final amplifier and modulator are both operated at 1300 volts. The Class-B input and output transformers are home-made jobs having plenty of secondary taps to take care of different load impedance and to permit close adjustment of transformer ratios under operating conditions. It has been found that a pair of 800's will easily handle peak inputs of 250 watts or more under the normal conditions of voice modulation, so that it is not difficult to get the 150 watts audio required to modulate the r.f. amplifier input of 300 watts.

GRID MODULATION

When running the amplifier as Class-C the bias is approximately 200 volts, twice the cut-off value. For grid modulation this voltage is changed to one and one-half times cut-off (150 volts) by means of the potentiometer P_2 , Fig. 1, and the r.f. excitation is varied by adjustment of the oscillator tuning condenser until the plate meter moves upward as much as downward upon voice input. The volume control is then reduced until the meter shows no movement at all. This is an emergency method of fixing the parameters of the amplifier but is just as correct as if all currents were fixed by meter checking. A study of the plate current-grid voltage curve of the tube will reveal the reason. The object is, with one and one-half times cut-off bias, to excite the grids until the peak excitation voltage is equal to the cut-off value of bias. If the cut-off voltage is 100 volts, 150 volts would be proper bias. Then the total peak r.f. voltage swing should be 200 volts, which gives 100 volts positive for affecting the 150 volts negative bias. This, then, should place the peak excitation voltage in the middle of the linear portion of the characteristic curves. When additional audio voltage is applied to the grids, the average grid voltage will be made to vary. If the peak r.f. excitation voltage is correct but the applied audio voltage is too great, the plate current will vary both more and less than the unmodulated value because of the nonlinearity of the grid-voltage plate-current curve above and below the straight section. Then when the modulated voltage is reduced so that the average plate current remains constant as shown by the plate meter, the modulating grid voltage is being held within the proper limits. The carrier output of the final stage so operated is 30 watts.

Because of the stability of the transmitter circuits, adjustments are seldom required, so that there is no necessity for bringing tuning controls out to the panel. When once the transmitter is adjusted for a particular band no further adjustments need be made for days. Since the action of the plate current of the final amplifier is a positive indication of the operation of the transmitter, the milliammeter is always connected by a direct lead into the plate circuit when not being used to check currents in other circuits. If this transmitter were to be built again no changes would be made.

PREMIER BRINGS COMMERCIAL STANDARDS WITHIN THE MEANS OF THE AMATEUR!

Type 195 is a fixed air-gap filter holder made in three sections. To establish the air-gap between the two electrodes and the crystal the center member may be ground accurately to a thickness dimension. Body, cover and base are of highest grade glazed isolantite. Electrodes are made of heat treated nickel silver, ground and hand lapped.

This holder accommodates 100 kilocycle bars and filter crystals from 450 to 525 kilocycles.

Dimensions: Body Diameter: 1½". Height overall: 1¼".
 Terminals: Two small size pins spaced ¾" on centers for tube socket mounting.

Send for Bulletin No. 103 which fully describes our complete line of isolantite low-loss holders.

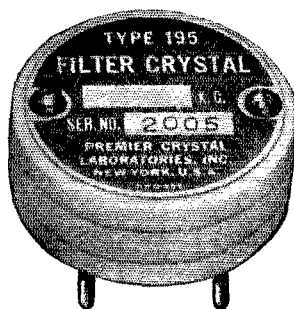

PREMIER CRYSTAL LABORATORIES, INC.
 53 PARK ROW, NEW YORK, N. Y.

*Johnny Jones groans and groans,
 There are no signals in his phones.
 Tomorrow night he'll be all right,
 His Handbook's in the mail tonight.*

GOT YOURS ?

LEARN RADIO

New Classes Now Forming! Send for 40-page catalog, explaining fully, 190 licensed graduates placed in past 3 years in broadcasting, shipping, police radio, aviation, etc. We teach all branches. Oldest, largest and best equipped school in New England. Equipped with Western Electric sound and broadcasting equipment and RCA marine transmitter. Course prepares for United States Government telegraph or telephone license.

MASS. RADIO SCHOOL, 18 Boylston Street, BOSTON

new! KELLOGG TRANSCIVER HANDSET

A better all-around Transceiver Handset! Highly efficient single-button Kellogg microphone, super-sensitive Kellogg receiver. Easy to hold. Fits the face. ● Microphone has greater sensitivity and "fatter" response curve than the usual "mike" of this type. Precision built, as are all Kellogg products. Gold plated diaphragm. Especially processed carbon. ● Receiver is the product of 35 years experience building telephone apparatus. Bi-polar magnet of cobalt steel. Cadmium plated diaphragm. Small, compact, easy on the ear. ● Simply and ruggedly constructed and light weight. Cast aluminum triangular handle. Baked black enamel finish. Has 6-foot, 4-conductor, 18-strand tinsel cord of telephone quality. ● You will be proud to own this unit. Better yet, it's not expensive. Code No. 38-A, 70 ohm receiver, list price \$10.00. Code No. 38-B, 2000 ohm receiver, list price \$11.00.

KELLOGG SWITCHBOARD & SUPPLY CO.
 1068 W. Adams St. CHICAGO, ILLINOIS

LITTELFUSES

- INSTRUMENT LITTELFUSES, for meters, ½ amp. up
- HI-VOLT. LITTELFUSES for transmitters, etc., 1,000 5,000 & 10,000 volt ranges, ½ amp. up.
- NEON VOLTAGE FUSES & Indicators (TATTELITES) 100, 250, 500, 1,000 & 2,000 volt ratings.
- AIRCRAFT FUSES, AUTO FUSES, FUSE MOUNTINGS, etc. Get new Cat. No. 6.

Littelfuse Labs., 4509 Ravenswood Ave., Chicago, Ill.

A hit! The 7-POINT MICROPHONE

Here's why the Amperite Velocity Microphone gives you the best in quality and value. (1) Wider frequency range. No peaks; no distortion. (2) Directional quality makes it easy to eliminate feedback. (3) Wider area of coverage. One Amperite Vel. Mike will replace several diaphragm type mikes. (4) Not affected by temperature, weather conditions or age. (5) Rugged construction. (6) Best value in mikes, or money refunded. (7) Fully guaranteed for two years against any service costs.

Write for Bulletin Q

AMPERITE Corporation 561 6WAY, N.Y.C.

AMPERITE VELOCITY MICROPHONE

THIS

NOT THIS

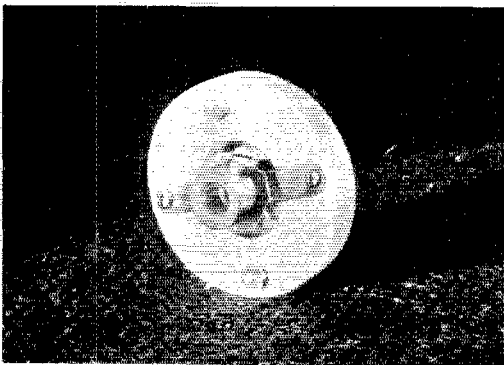

COUPLING: Extremely practical where space is limited, this coupling has Steatite insulation that will not char under flash over and does not absorb moisture. Equally important, it possesses high electrical efficiency as well as the mechanical rigidity so lacking in couplings of the fibre disk type. Catalog Symbol TX-9.

List Price \$1.00 Usual Discounts apply

NATIONAL COMPANY, INC.
MALDEN, MASS.

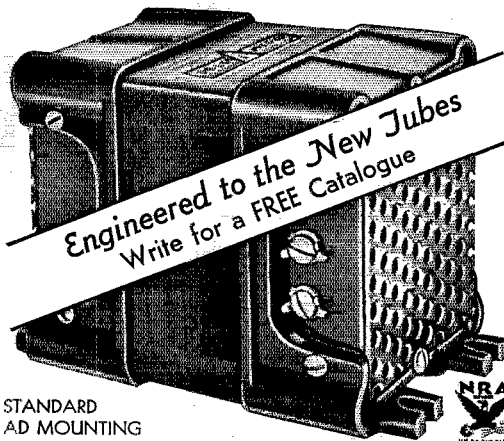

STANDARD
AD MOUNTING

ACME~DELTA

POWER SUPPLY EQUIPMENT

New Acme-Delta Power and Filament Transformers, new Swinging and Smoothing Chokes and the necessary coupling transformers, especially and specifically designed for use with the Raytheon RK-18, the remarkable new RK-20, R. C. A. 800, and the Hygrade-Sylvania 825 and 830-B tubes, are now ready. See the complete catalogue in QST for December, 1933. Extra copies will be gladly sent you on request. Delta Manufacturing Co., 190 Willow St., Waltham, Mass.

RAYTHEON MANUFACTURING CO.
ELECTRICAL EQUIPMENT DIVISION
190 Willow Street, Waltham, Massachusetts
Successor to Delta Manufacturing Co.

102

Do You Want a Kilowatt?

(Continued from page 13)

has become accustomed to the operation of the amplifier, it will be possible to tune it up with the load at least partially on so that it should not be necessary to reduce plate voltage when changing frequency.

It is recommended that the coil taps be made temporary until their exact positions are determined by experiment. The taps should be arranged so that as much inductance as practicable is in the circuit on each of the two higher frequency bands. Aside from these few precautions, the amplifier is tuned up in the usual manner. Resonance in the plate circuit will be indicated by an abrupt dip in plate current with the amplifier unloaded. Don't try to find resonance with either plate or grid circuit switches turned to the wrong positions!

LOADING

With the antenna connected, the link coil should be coupled loosely to the plate tank coil, the other end of the link being tapped on the antenna circuit coil at the center with one or two turns between the taps. Turn on the exciter and high voltage and tune the antenna circuit to resonance, keeping the tank coil tuned always to minimum current dip or close to it. If an antenna ammeter is available, the tuning of the antenna is an easy job. Without one a little judgment must be used. It is a good idea usually to start off with the antenna circuit tuned well away from resonance and the plate tank circuit tuned to resonance by plate current dip. As the antenna circuit is tuned nearer to resonance in small steps, the plate current will gradually increase. With each slight change in antenna tuning, the plate tank condenser should be readjusted to keep the plate current at a minimum point. Finally, a point will be found where the plate current will no longer increase with tuning of the antenna circuit. At this point, tuning the plate tank condenser off resonance will cause the plate current to rise, while tuning the antenna condensers off resonance will cause a drop in plate current. After the entire transmitter has been tuned up with loose coupling, the link coil may be moved closer to the plate tank coil or the spread between taps at the antenna end increased. While there should be no particular difficulty in running the input up to the full legal limit of 1000 watts, there seems to be little point in exceeding 750 or 800 watts with 2000 volts on the plate, since the last few hundred watts input do not result in proportionate increase in output. At 800 watts the key may be closed for indefinite periods with no detrimental effect upon the tube or other equipment. Fairly close coupling between the link coil and plate tank coil, with three turns between the taps at the other end of the link, will be about right for 3.5 and 7 mc. when using Zepp feeders 45 to 50 feet long. Fairly loose coupling and two turns between taps was found satisfactory for 14 mc. With full plate loading, the grid current will drop to about 50 ma. on 3.5

Say You Saw It in QST — It Identifies You and Helps QST

1935 Supplies for 1935 Stations

... THE LOG BOOK

Designed to comply with the detailed regulations of Federal Communications Commission regarding logkeeping, providing for the recording of every item of required information. To this end places are provided on the inside cover and at the page heads to log basic information which may stand for long periods of time, and the actual logging of transmissions is reduced to a very simple operation. Columns are provided for recording signal reports by the R-S-T method, both as to your observation of the station contacted and as to the other fellow's report of your signals. The QSA- and R- scales are given with suggestions for logging by that method if desired. The new page heading makes the log as useful for mobile or portable operation as it is for fixed. 38 ruled pages in book form.

40c each 3 for \$1.00

... THE RADIOGRAM BLANKS

The radiogram blank has been revamped to allow for that much needed room for the body of the message and to facilitate copying of messages. $7\frac{1}{2} \times 8\frac{1}{2}$ sheet padded 100 sheets to the pad. It will reflect credit on your station when you deliver a message on this form.

35c each 3 for \$1.00

... THE MESSAGE FILE

The F. C. C. requires amateurs to keep messages handled for a period of one year. The message file has been designed to facilitate compliance with that regulation. An expanding file of thirteen compartments (one for each month and one for extra papers), it provides for more messages per month than the average station will handle. On the face of the FILE, space is provided for a complete and accurate record of traffic handled. It will accommodate a year's traffic. For a practical and convenient solution of the regulation, you can't beat it.

40c each 3 for \$1.00

AMERICAN RADIO RELAY LEAGUE
WEST HARTFORD, CONNECTICUT



.... Precision

is the Prime factor of all PIEZO ELECTRIC CRYSTALS. Scientific Radio Service Crystals are ground to an accuracy of BETTER than .01% before they leave our laboratories in order to meet our own specifications.

AMATEURS

Crystals are supplied to within 5KC of your specified frequency in either 80 or 160 meter band, \$15.00 each unmounted. Calibration supplied accurate to Better than .03%.

"THE CRYSTAL SPECIALISTS"

Send for Booklet and Price List

Scientific
RADIO SERVICE
 124 Jackson Avenue, University Park
 Hyattsville, Maryland. Q-4-35

A NEW DEMOUNTABLE CRYSTAL MICROPHONE!

Insert the plug . . . push . . . click, and the new Shure Demountable Crystal Microphone is installed on its stand! And it's only a matter of a second to remove it for safekeeping or use elsewhere.

The Shure Model 70H-79A Demountable Crystal Microphone is a complete unit consisting of a high-quality diaphragm-type crystal microphone with a rugged, positive, completely-shielded plug attachment, and a receptacle which mounts on the microphone stand. Due to exclusive Shure "Cantilever" principle, frequency characteristic is excellent and the output level is unusually high.

SHURE MODEL 70H-79A
 Demountable
CRYSTAL MICROPHONE
 List Price... **\$27.50**

Shure Model 70H Crystal Microphone. Without adapter, but including "close-fitting" ring and 7 ft. of cable. List Price.....\$22.50

Bullet, Studio and Desk-Type models, complete with associated preamplifier, are also available from \$57.50 list up.

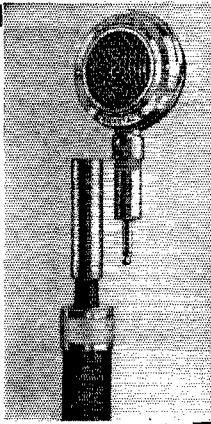

See your Jobber for complete details.

Licensed under patents of the Brush Development Company.

SHURE BROTHERS COMPANY

Manufacturers of *Microphone Headquarters* Telephone
 CHICAGO, ILLINOIS DELAWARE 8, 163
 215 WEST HURON ST.

and 7 mc., and to approximately 25 ma. on 14 mc.

The two antenna loading coils were designed so that it would be possible to use series tuning on all bands with feeders 45 to 50 feet long. They are connected in for 3.5 mc. operation and short-circuited entirely for 7 and 14 mc. To provide tuning of a Zepp system with feeders of any length, it is necessary merely to provide loading coils which will bring the effective feeder length to an odd number of quarter wavelengths. If the coils are constructed so that they may be tapped at any point, a pair of coils having the properties of a quarter wavelength of feeder at the lowest frequency to be used will make it possible to tune the system to resonance regardless of feeder length. The coils described should take care of almost any feeder length likely to be used at the three operating frequencies.

At a plate voltage of 2000 volts, the plate current may run 350 to 400 ma. or slightly more. It is important, however, that the plate tank circuit be kept at resonance whenever the amplifier is operating. The relatively tremendous plate currents resulting from off-resonance adjustment will ruin any tube if continued for any appreciable length of time. This type of tube shows an even red color over the entire surface of the plate when operating at its rated dissipation with the key closed for several seconds.

POWER SUPPLY

Readers are invariably interested in a brief description of the power supply used with the original model. This one is surprisingly simple. The plate transformer is a 1-kw. affair delivering approximately 2200 volts each side of center-tap under load. The filter consists of a single section with choke input using a 500-ma. 16-henry smoothing choke and a 5000-volt oil condenser with a capacity of 1 μ fd. The bleeder resistance is made up of a miscellaneous collection of resistors totalling about 100,000 ohms. While the voltage regulation could be improved, it is of no particular importance in this case. When proper filtering is provided for the driver power supply, this filter will produce good clean T9 signals. It is quite probable that few of us realize how much can be saved on high-power filters by careful filtering of the power supply feeding the low power stages.

An estimate of the power output based upon an observation of plate coloring and check by lamps used as a dummy load indicated, conservatively, an output of 500 watts for an input of 750 watts at 14 mc. This represents a step-up in power of at least 1 to 10, which isn't so bad for a tube designed before hams thought of working below 200 meters.

In conclusion, it might not be out of place to warn those working on high power transmitters for the first time that they are playing with real fire. If you must test with a neon bulb, use a large one with plenty of glass between fingers and contact. The time-honored advice about counting ten before punching noses applies equally well to punching high-power tank coils.

PYRANOL

2 mfd 2000 volt trans. condensers **\$2.90**
 Impregnated and filled with Pyranol. We rate these at 2000 volts working and we know of cases where they are in use at a 50-75% overload. Made by one of the world's largest manufacturers of electrical apparatus.

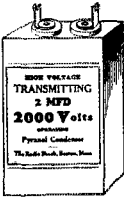

IMMEDIATE DELIVERY The RCA-ACR-136 Communications RECEIVER

Amateurs are unanimous in their praise of this communications receiver. Surely a lot of receiver when all its features are taken into consideration. Seven-tube super — 540 to 18000 KC. Built-in power supply and speaker. Beat frequency Osc. — AVC. Complete with coils, speaker, tubes and cabinet. **\$69.50**

THE SUPER SKY RIDER

A four-band super embodying in its construction all the latest engineering developments — Pre Selection — AVC — Crystal Filter (optional) Dual Air Tuned IF'S — Band Spread — SR Switch — Built-in power supply and speaker. Circular on request. **\$59.95**
 Complete.

INTERNATIONAL PLATE TRANSFORMERS

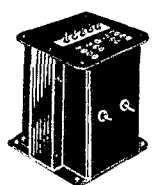

Outstanding for Value 750 and 1000 volts each side of c.t. at 300 mills. Cast completely in steel, crackle finish. Model

2000. \$5.95
 Model 3000 — Same in appearance. 750-1000-1500 each side of c.t., 300 mills. \$8.95
 We know of nothing that equals the value received in these two items

TRIPLETT METERS

0-5 to 500 mills
 3 1/4" bakelite case. \$3.75
 0-15 a.c. volts. 3.75
 0-1-2.5-5 thermo ammeters **\$6.66**

THE NEW MAC-KEY

Oldtimers enthusiastically acclaim this semi-automatic key as the greatest step forward in design yet accomplished. The surest way to develop a good list. **\$10.50**

TRIAD

210 \$1.25	46 \$6.60
250 1.25	3048
28 1.25	3378
8355	841 2.25

CARDWELL

157B \$4.80	164B \$2.48
156B 3.60	T183 5.48
T199 6.00	137B 3.00

2.5 volt 12 amp. trans. for 866s. \$1.25

HD-866 \$1.60	BALDWIN Type C Phone \$2.50	V.T. 203A Graphite \$9.00	RAYTHEON RK-20, \$15.00 RK-23-25, ... 5.95 RK-18, 10.95 RK-24, 2.25
--------------------------------	---	---	---

EIMAC 150T .. \$24.00	50T ... \$13.50	GAMMATRON Type 354. \$24.50
---------------------------------	-----------------	--

HAIGIS 5M Transceiver \$13.50	THORDARSON TRANS. 600-O-600-200M 5V-3A, 7.5V-3A, 2.5V-10A \$3.10 535-O-535-150M 7.5V-2.5A, 2.5V-5A, 5V-3A \$2.85	PEAK Pre-Selector \$19.30
---	--	---

JUST FIFTY RAYTHEON 250 TUBES 75c	THE RADIO SHACK 46 BRATTLE STREET BOSTON	AUDIOVOX DB Mike and Stand 200 ohms per button... \$4.20
--	---	--

THE BROWNING 35

Space will not permit an adequate description of this latest outstanding development of Glen H. Browning. For those who want advance technical information we offer five full-scale progressive drawings, 17" by 22", with a 24-page treatise by Glen Browning describing in detail his latest **\$1.00** receiver. Postpaid
 Circular on request

GENERAL ELECTRIC Pyranol Condensers
 1 mfd. 2000V. \$3.12
 2 mfd. 2000V. 4.75
 4 mfd. 2000V. 6.53

MAIL ORDERS FILLED
 Send Money Order

UNIVERSAL MODEL "G"

A completely assembled, ready-to-use condenser microphone unit — All A.C. operated — Nothing to add — No batteries or battery expense, yet guaranteed as silent as batteries. Just plug into 110v. A.C. 50-60 cycle socket and be assured of trouble-free, full-satisfaction performance — 2 stage amplifier with No. 230 tubes — barometric adjustment — temperature compensator — shielded diaphragm — frequency response 70 to 7,000 cycles — Engineered by Universal to guarantee maximum results at the lowest price consistent with Universal standards.
 Dealers Net Cash \$49.39
UNIVERSAL MICROPHONE CO., LTD.
 424 Warren Lane Inglewood, Calif., U.S.A.

SANGAMO ACCURATE CONDENSERS

A quality product for the amateur who wants the best results. Available in 1000, 2500, and 5000 volt construction
 Write for catalog sheet
SANGAMO ELECTRIC CO.
 SPRINGFIELD, ILLINOIS

EBY PATENTED

Specializes in Quality

- Binding Posts
- Tip Jacks
- Male Plugs
- Female Plugs
- Low-Loss Sockets
- A-C Switches
- Tap Switches
- Terminal Strips
- Short Wave Switches

Write for Latest Bulletin

HUGH H. EBY Inc.
 2066 Hunting Park Ave.
 PHILADELPHIA, PENNA.

HAM-ADS

(1) Advertising shall pertain to radio and shall be of nature of interest to radio amateurs or experimenters in their pursuit of the art.

(2) No display of any character will be accepted, nor can any special typographical arrangement, such as all or part capital letters be used which would tend to make one advertisement stand out from the others.

(3) The Ham-Ad rate is 15¢ per word, except as noted in paragraph (6) below.

(4) Remittance in full must accompany copy. No cash or contract discount or agency commission will be allowed.

(5) Closing date for Ham-Ads is the 25th of the second month preceding publication date.

(6) A special rate of 7¢ per word will apply to advertising which, in our judgment, is obviously non-commercial in nature and is placed and signed by a member of the American Radio Relay League. Thus, advertising of bona fide surplus equipment owned, used and for sale by an individual or apparatus offered for exchange or advertising inquiring for special equipment, if by a member of the American Radio Relay League takes the 7¢ rate. An attempt to deal in apparatus in quantity for profit, even if by an individual, is commercial and takes the 15¢ rate. Provisions of paragraphs (1), (2), (4) and (5) apply to all advertising in this column regardless of which rate may apply.

Having made no investigation of the advertisers in the classified columns, the publishers of *QST* are unable to vouch for their integrity or for the grade or character of the products advertised.

QUARTZ—Direct importers from Brazil of best quality pure quartz suitable for making piezo-electric crystals. Diamond Drill Carbon Co., 719 World Bldg., New York.

RADIO engineering, broadcasting, aviation and police radio, servicing, marine and Morse telegraphy taught thoroughly. All expenses low. Catalog free. Dodge's Institute, Byrd St., Valparaiso, Ind.

REPAIRS: Microphones, meters, broadcasting equipment, electronic devices, instruments. Prompt repair service. Low prices. Estimates on request. Sound Engineering Corp., 2200 Kinzie, Chicago.

QSLs, SWLs, 75¢ per hundred, two colors, samples on request. W5ECM, 319 Rosetta, Little Rock, Ark.

GENERAL Electric 24/750 volt 200 mill dynamotors, \$25. 12 volt input delivers 375. Two machines 1500 volts, \$40. 500 cycle 500 watts aircraft 110-220 volts \$7.50. Westinghouse 6-15 volts 500 watts, \$10. 27½/350 volts, \$10. List. Henry Kinzie, 501 East 84th St., New York.

MG 250 watt 250 mil 1000 volt direct coupled 110 60 cycle motor—bronze bearings—perfect condition. Offer? W2US.

HAM equipment bought, sold or traded. Distributors of all nationally known ham apparatus. Write for catalogue. Walter Ashe Radio Co., St. Louis, Mo.

100WV General Electric transformers, 1100-2200-4400 each side center on 110. Sold hams right years. \$13.50. Dawson, 5740 Woodrow, Detroit.

PAYMENT! "R/9" pays moderate rates for acceptable, full-length technical articles. Details for stamped envelope. Kruse, Technical Editor, RFD 2, Guilford, Conn.

POSTAL 1935 receiver, complete, slightly used, guaranteed A1 condition, \$50. G. Howard, 9034-171st Street, Jamaica, L. I., N. Y.

QSLs! America's finest! Samples? (stamp) W8DED, Holland, Mich.

"RADIO" magazine only \$2.00 year via W8DED, Holland, Mich.

SELL—Majestic Super B eliminators, excellent power supplies, complete, \$5.25. Also have chargers reasonable. W9JHP.

MUCK saws: 8" diameter copper discs, 1/2" hole. Machined perfectly round and flat, 1/32" thick, 75¢ each. W8GJM.

SLIGHTLY used FB7, 80 and 40 meter coils, tubes, power supply, \$45. W5DRH, White Deer, Texas.

SWAP parts or tubes for 800. W8HNY.

YOUR call on monel metal finger ring, \$1. W5DRN, 2507 Grant St., Wichita Falls, Texas.

QSLs? Free samples. Waggoner, 117 W. Kentucky St., Louisville, Kentucky.

SELL—surplus equipment. Write for list. W2HNQ-9, 511 North 14th St., Manhattan, Kans.

CLASS B transformers—Universal for two or four 46's, 210's, 800's. RK18's, etc., \$7.75 pair postpaid. 70 watts audio from 46's, 100 watts from 10's. Write for details. W8UD, Douglas, Michigan.

SELL—Proceedings of I.R.E.—1929 Complete—1930 Complete—July 1931, QST—October and November 1916—All but February, October, November, December in 1917—June to December inclusive in 1919—1920 Complete—1921 Complete—All but June in 1922—1923, 1924, 1925, 1926, 1927 all Complete. Unused Supreme 333 analyzer—best offers accepted W9ADS.

QSL cards, two color, cartoons, message blanks, stationery, snappy service. Write for free samples to-day. W1BEF, 16 Stockbridge Ave., Lowell, Mass.

BEST place to trade-in your old receiver on a new one. Everything in radio. New tubes and other items to swap. Palmer's Trading Post, Route 1, Duluth, Minn.

QSLs. Free samples. Printer, Corwith, Iowa.

200 two-color QSLs, SWLs, \$1.25. Time limit offer. W8ESN, Toledo.

CRYSTALS—160-80 meters, within three kc., \$1.50. Guaranteed strong oscillators. Vollmer Radio Lab., 5126-35th St., San Diego, Calif.

SWAP brand new RCA851 tube for good amateur superhet receiver. W2AVG, 2311 Harrison St., Schenectady, N. Y.

GENERAL Electric 204-A tubes \$35. each, Westinghouse 840 tubes \$30. each, guaranteed OK. Hammerlund Comet Pro, Special 6 volt a.c.d.c. model complete with coils and tubes \$59.50. H. C. Wing, Greenfield, Mass.

BEST offer takes new ACSW3 complete with tubes and three sets of coils. Write for list of other equipment available. Rufus Baldwin, W3AII, 1117 Westover Ave., Norfolk, Va.

CRYSTALS: Fully finished and guaranteed, 1" X cuts, within 2 kc., \$2. A-T cuts, 1" \$3.50. Billey BC2 holders, \$1. W8DLM, Rochester, Mich.

QSL samples, 2143 Indiana Ave., Columbus, Ohio.

SELLING out. Power Transformers, chokes, National SW3, condensers, tubes, r.f. meters, at bargain prices. W4DEN, Box 85, Mount Dora, Fla.

METERS repaired properly at reasonable rates. Electrical Instrument Labs., 1542 Hertel Ave., Buffalo, N. Y.

CALLBOOKS—new Spring 1935 Radio Amateur Call Book, new Prefixes, hundreds of new DX QRAs, many new pages of late W and VE calls, is yours for \$1.25, or four issues (one year) for \$4.00 (in foreign countries \$1.35 and \$4.35, Post-paid). W9FO-610 S. Dearborn, Chicago.

QSLs by Maleco. Finest in country. Free samples. Maleco, 1512 Eastern Parkway, Brooklyn, New York.

SWAP set eleven golf clubs, accessories. Want ACSW3 complete or good receiver. WIDIE, 14 Orient St., Worcester, Mass.

SWAP: Saxophone. White's King, for commercial ham receiver or \$100. W9RSU, Cumberland, Ky.

SWAP 1927 Chevrolet coupe for transmitter. What have you? H. Molter, 1749 Washburne Ave., Chicago, Illinois.

CRYSTALS—guaranteed excellent oscillators. ¾-1¼" your approximate frequency 160-80 bands \$1. Approximately 465 kilocycles, \$2. Blanks—accurately cut from optical quality Brazilian quartz, 50¢. Roy Scherman, W9FHS, 4433 North Kilbourn, Chicago.

Y-cut crystals, \$1.00. W9ERU.

120 watt 4 stage wired xmtr, tubes, rack panel, shielded, \$30. complete. W2BJJ.

QSLs? W2AEY.

QSLs! Something up our sleeves! See ours first! W6FZQ/W6HEU, Box 1804, Phoenix, Arizona.

REBUILT Vibroplexes, \$5-\$7. New large base bugs, \$9. Lydeard, 28 Circuit, Roxbury, Mass.

ORACLE enamel 75¢, crystals, ACSW3-58 coils, liquid Victor 30¢. Radio Specialties, 433 Monroe, Brooklyn, N. Y.

QSLs, 75¢. W9DGH, 1816 N. 5th Ave., Minneapolis, Minn.

CRYSTAL Holders: Machined Formica. Genuine "GR" plugs. Special non-warping alloy electrodes. Holds 1-¾" crystal. \$1.00. Crystals: 1715-4000. 1" X within three kilocycles, \$1.95. Catalogue. Ham Crystals, 1104 Lincoln Place, Brooklyn, N. Y.

CRYSTALS: Zero cuts, Temperature-Frequency-Coefficient. Your approximate frequency, 80 or 160 meters \$1.85. Selected for zero over a wide range in temperature \$3.25. Plug-in holders 75¢ postpaid. Fisher Laboratory, 4522 Norwood Street, San Diego, California. "Pioneers of low priced crystals."

SELL 30/300 volt dynamotor \$3; Bug \$3; SW3 with tubes, coils \$20; "Megger" hand crank generator \$5; 6 volt motor \$2; Rotary mimeograph \$20. W9AIR, Sleepy Eye, Minnesota.

MILLIAMMETERS—triple range (see February *QST*), Satisfaction, reliability, accuracy, guaranteed, \$2.75. W9SXF, 1237 C St., Lincoln, Nebr.

IMMEDIATE delivery RCA 802, \$3.90 net, 801 now \$4.50 net. Klaus Radio Co., Peoria, Ill.

BARGAINS. Navy SE1440A receiver, SE1603 RF driver, General Radio amplifier test set, attenuation box, variable inductor, Carbon condensers, ribbon mikes, Jensen dynamos, RCA amplifiers, meters, audio power transformers, laminations, large navy variable condensers. Swiss jewelers lathe. Canady, 19570 South Sagamore Road, Cleveland, Ohio.

CONSTRUCTION details of six volt input power transformers and power supplies from spare parts, 50¢. W9MTU, Mt. Pleasant, Iowa.

TRANSFORMERS—1200 watt 1200-2200-3200 each side, \$23. Quotations given. Frank Greben, W9CES, 2012 S. Peoria St., Chicago, Ill.

SELL CW fone transmitter. Class B, filament power transformers. Power supplies, etc. W9KQO, Topeka, Kans.

SELL two five meter transceivers complete. Write for particulars. W8LMB, Charlevoix, Mich.

QSLs—samples. W1AZF, 83 Orange, Roslindale, Mass.

SELL Gross CW25 complete. Also fifteen watt P. A. complete. W9OSM.

W2CR sells equipment, tubes, parts.

QSLs. Samples? W2SN, H. W. Yahnel, Helmetta, N. J.

AT crystals 160 and 80 meters within 5-kc., \$2.50; 2-kc. \$3.50. X-cut, within 5-kc., \$1.50; 2-kc., \$2. AT blanks, 90¢ each, 6 for \$4.50. E. L. Minnich, W3BML, Carlisle, Pa.

POWER transformers built to order, high quality, moderate cost. Special impregnating compound keeps insulation live. Write Henry Beaubier, 2254 Park Ave., Indianapolis, Ind.

CHANNEL steel racks not drilled 66x21½ for standard panels. \$5.50. Drilled standard \$6.72. Panels 8¾x21x¼ at \$98 steel. \$1.56 aluminum. Slotted or unslotted. Odd sizes a specialty. Special drilling and cutting for all layouts. Write for prices on Chassis bases and shield cans. W9DAX, Sandwich, Illinois.

QSLs, none better. Samples? W8DDS, 2156 W. 80th St., Cleveland.

CRYSTALS, guaranteed. 160-80 meter, less than 1", X or Y, plus or minus ten kilocycles, \$1.35. Plus or minus two kilocycles, 1", \$2.25. Rough-cut blanks, 60¢; oscillating 85¢; odds and ends, five for \$1. Speedy service. William Threm, W8FN, 4021 Davis Ave., Cheviot, Ohio.

AT crystals: finished blanks \$2.00; saw blanks \$1.25. Finished crystals, .1% calibration 1750-3500-kc. bands, \$5.00; 7000-kc. band \$5.00. Chas. C. Fagan, W3UF, Carlisle, Penna.

MAXIMUM output for minimum investment. Stretch the dollars. Get our estimate on your power supply requirements, relay racks. Edison batteries. Rectifier Engineering Service, 4837 Rockwood Rd., Cleveland, Ohio.

WANTED—radio dealers for world's most compact and beautiful radios, outstanding for profits and performance. Unusual sales plans. W9CKU, Kadette Distributor, Heron Lake, Minn.

NATIONAL, Hammarlund, McMurdo Silver, Patterson sets, slightly used. A-1 condition. 60% off list. Cash only. No terms or swaps. Willard S. Wilson, W3DQ, Wilmington, Del.

FOR sale—best offer—latest model Hammarlund Comet Pro. Box 88, QST.

McMURDO Silver 5B-5C-5C xtal receivers—new. 50% off list. Cash only. No trades or terms. L. A. Daniels, W3AJH, Tuxedo Park, Del.



"E. H. Rietzke SPEAKING!"



Mr. E. H. Rietzke, President of CREI, and originator of the first thorough course in Practical Radio Engineering.

The CREI Diploma Marks You Not Only as a Graduate . . . but as an ENGINEER!

Are you to be classed with thousands of other Radiomen who are "lost" in routine work? There never will be enough good jobs in Radio for men who are "pretty good." Today you must have specialized **TECHNICAL TRAINING** to get to the good jobs and the big money.

Any man who has sufficient ambition and isn't afraid of hard work can get an education. If you will combine your experience with the necessary technical education, you will be equipped to take advantage of every opportunity to improve yourself.

CREI can help you as we have helped others out of routine jobs into top positions in Radio. Write today for details of our courses and the easy way to pay for them.

FREE! WRITE FOR 44-PAGE CATALOG

**CAPITOL
ENGINEERING**



**RADIO
INSTITUTE**

14th and Park Road, N. W.

Washington, D. C.

Dept. G-4

88 COMPLETE LINES

Short wave radios, most famous lines—every worth while piece of equipment used by the amateur—all are carried in our stocks ready for instant shipment.

Only Midwest could offer such service. For only Midwest is devoted **EXCLUSIVELY** to the service of the amateur—its staff especially designed to meet the amateur's needs.

4 hour service from complete stocks, expert advice on technical problems, and the world's largest catalog of short-wave transmitting and receiving equipment.

Send for your copy today!

MIDWEST RADIO MART

520 S. State St., Chicago, Ill.

TYPE EO-1 LOW-LOSS 72 OHM TWISTED-PAIR RF TRANSMISSION LINE

For Matched-Impedance Doublet Type TRANSMITTING Antennae.

BRING YOUR ANTENNA UP TO DATE!

(See article by Robert C. Graham in January QST)

Net Prices to Radio Amateurs

Up to 49 feet.....	@ .07	per foot
50 to 99 feet.....	@ .06½	per foot
100 to 499 feet.....	@ .06	per foot
500 feet and over.....	@ .05½	per foot

20% deposit is required with all C.O.D. orders. Remit by Certified Check or M.C. include Postage. Shipping weight per 100 feet, 7½ pounds. See your jobber or order direct. Write for circular.

RUSSELL A. GRAY (W8AAC)
HOMER, NEW YORK

Your Nearest Dealer

Your nearest dealer is entitled to your patronage. You can trust him. He is equipped with a knowledge and understanding of amateur radio. He is your logical and safe source of advice and counsel on what equipment

Patronize the dealer nearest you—

ALLENTOWN, PENNSYLVANIA

Radio Electric Service Co.
1024 Hamilton Street
Complete stocks transmitting equipment

BALTIMORE, MARYLAND

Radio Electric Service Co.
303 W. B Itimore Street
Everything for the amateur

BOSTON, MASSACHUSETTS

Nutter & Cross, Inc.
99A Milk Street
All OMs, OWs, and YLs welcome — W1HRF

BUFFALO, NEW YORK

Dymac Radio
216 E. Genesee St. — Tel. Cl. 2080
Complete Stock Amateur Parts — Standard Discounts — W8AWK

BUFFALO, NEW YORK

Kronson Service Company
143 East Genesee Street
Western New York's largest wholesale distributors — W8EHF

CHICAGO, ILLINOIS

Allied Radio Corporation
833 West Jackson Blvd.

Complete standard lines always in stock—W9NRV—W9IBC—W9RZL

CHICAGO, ILLINOIS

Chicago Radio Apparatus Company
415 South Dearborn Street (Est. 1921)

W9RA and W9PST — Amateurs since 1909

CHICAGO, ILLINOIS

Mid-West Radio Mart
520 S. State Street
All standard lines carried in stock

CLEVELAND, OHIO

Northern Ohio Laboratories
2073 West 85 Street
Wholesale Distr. for National, Hammarlund, Thordarson, Cardwell

DENVER, COLORADO

Inter-State Radio & Supply Co.
1639 Tremont Place
Amateur Radio Headquarters in the Rocky Mountain Region

DETROIT, MICHIGAN

Aitken Radio Corp.
1326 E. Congress St.
Complete stock nationally known brands for amateur and serviceman

DETROIT, MICHIGAN

Radio Equipment Sales Co.
14036 Woodward Avenue, Highland Park
A complete stock of amateur, shortwave and service parts

DETROIT, MICHIGAN

Radio Specialties Company
171 E. Jefferson Avenue
Ham Supplies — National & Hammarlund Sets and Parts

ERIE, PENNSYLVANIA

Jordan Radio Laboratory
2512 Peach Street
Amateur, service parts, including Bliley, National, Raytheon. W8CXG

FRESNO, CALIFORNIA

Ports Mfg. Co.
3265 E. Belmont Ave.
Wholesale: RCA-Thordarson-Bliley. All Standard Lines

HARTFORD, CONNECTICUT

Radio Inspection Service Company
227 Asylum Street
What do you need? We have it

HOUSTON, TEXAS

Straus-Frank Company
Distributors for nationally advertised amateur products
RCA-DeForest transmitting tubes

JACKSONVILLE, FLORIDA

Glover Weiss Co.
Radio Headquarters for Southeast
Distributors: RCA Victor, Stromberg-Carlson, Standard Ham Lines

KANSAS CITY, MISSOURI

Burstein-Applebee Company
1012-14 McGee Street
"Specialists" in supplies for the Amateur and Serviceman

KANSAS CITY, MISSOURI

Radio Laboratories
1515 Grand Avenue
Amateur Headquarters — Complete Stock — Quality Parts

LOS ANGELES, CALIFORNIA

Pacific Radio Exchange, Inc.
729-31 South Main Street
Most completely diversified stock of amateur equipment in the West

This advertisement is paid for by the firms listed above. Qualified dealers

Is Your Best Friend

you should buy. His stock is complete. He can supply your needs without delay. His prices are fair and consistent with the high quality of the goods he carries. He is responsible to you and interested in you.

You can have confidence in him

<p>MANCHESTER, NEW HAMPSHIRE Radio Service Lab. of N. H. 1008 Elm Street — Tel. 218-W Branches — Portland, Me. and Barre, Vt.</p>	<p>ST. PAUL, MINNESOTA Lew Bonn Company 2484 University Avenue Rex L. Munger, W9LIP, Sales Engineer Radio Wholesaler Complete Stock</p>
<p>MILWAUKEE, WISCONSIN Radio Parts Company, Inc. 332 West State Street Complete stock Nationally Known products</p>	<p>SAN FRANCISCO, CALIFORNIA Offenbach Electric Company, Ltd. 1452 Market Street "The House of a Million Radio Parts"</p>
<p>MONTREAL, CANADA Canadian Elec. Supply Co., Ltd. 285 Craig St., W. Quality parts and equipment for discriminating buyers</p>	<p>SIoux CITY, IOWA Warren Electric Co. Standard Lines and Discounts T. J. Morris, W9SSN, Mgr. Parts Dept.</p>
<p>NASHVILLE, TENNESSEE Braid Electric Co. Ham Supplies — Replacement Parts RCA, National, Hammarlund, and other leaders</p>	<p>SPRINGFIELD, MASSACHUSETTS T. F. Cushing 349 Worthington Street An amateur, endeavoring to sell good parts</p>
<p>NEWARK, NEW JERSEY Kaltman & Romander 62 Court Street Drop in for an over-counter QSO</p>	<p>SYRACUSE, NEW YORK Roy C. Stage, W8IGF Complete stock of standard Ham & BCL parts Standard Discounts. Free technical service</p>
<p>PHILADELPHIA, PENNSYLVANIA Consolidated Radio Corp. 612 Arch Street Ham receivers, Transmitting tubes, Collins Transmitters, etc.</p>	<p>TOLEDO, OHIO Aitken Radio Corp. 1014 Madison Ave. Complete stock nationally known brands for amateur and serviceman</p>
<p>PHILADELPHIA, PENNSYLVANIA Radio Electric Service Co., Inc. N. E. Cor. Seventh & Arch Sts. All nationally-advertised lines in stock</p>	<p>TORONTO, CANADA A & A Radio Service Supply 101 Queen Street, West Canada's foremost radio supply house</p>
<p>PHILADELPHIA, PENNSYLVANIA Eugene G. Wile 10 S. Tenth Street Complete Stock of Quality Merchandise</p>	<p>TORONTO, CANADA Wholesale Radio Company, Limited 1133-39 Bay Street Canada's Largest Amateur Supply House</p>
<p>PITTSBURGH, PENNSYLVANIA Cameradio Company 601-3 Grant Street "Ham" Headquarters for Pennsylvania-Ohio-W. Virginia</p>	<p>TRENTON, NEW JERSEY American Radio Co. 5 N. Broad Street Central Jersey's leading radio parts store</p>
<p>PROVIDENCE, RHODE ISLAND W. H. Edwards & Company 32 Broadway, Room 23 Amateur Equipment — National, Hammarlund, RCA Tubes</p>	<p>WASHINGTON, D. C. George's Radio Co. 816 F Street, N.W. Washington's largest distributor of radio parts</p>
<p>SAN ANTONIO, TEXAS Straus-Frank Company Distributors for nationally advertised amateur products RCA-DeForest transmitting tubes</p>	

are invited to apply for rates, etc., to Advertising Department, QST

Say You Saw It in QST — It Identifies You and Helps QST

You Are Protected When You Buy From QST Advertisers

“Advertising for QST is accepted only from firms who, in the publisher’s opinion, are of established integrity and whose products secure the approval of the technical staff of the American Radio Relay League.”

Quoted from QST’s advertising rate card.

Every conceivable need of a radio amateur can be supplied by the advertisers in QST. And you will know the product has the approval of the League’s technical staff.

For Your Convenience QST’S INDEX TO ADVERTISERS IN THIS ISSUE

Aerovox Corporation	93
Amperite Corporation	101
Asatic Microphone Laboratory	89
A.R.R.L. Application Blank	92
Binders	84
Handbook	97
Hints and Kinks	85
How to Become a Radio Amateur	95
License Manual	89
Supplies	103
Birnbach Radio Company	95
Biley Electric Company	93
Burgess Battery Company	2
Capitol Radio Engineering Institute	107
Cardwell Mfg. Corp., Allen D.	112
Central Radio Laboratories	80
Chelsea Clock Company	89
Collins Radio Company	Cov. 2
Cornell Duplicator Corp.	96
Delaware Radio Sales Co.	91
Eastern Radio Specialties Co.	95
Eby, Inc., Hugh H.	105
Eitel-McCullough, Inc.	96
Electrad, Inc.	89
General Radio Company	78
Gray, Russell A.	107
Gross Radio, Inc.	81
Gulf Radio School	95
Hallicrafters, Inc., The	99
Hammarlund Mfg. Company	1
Harvey Radio Laboratories	98
Hipopower Crystal Company	98
Hygrade Sylvania Company	4
Instructograph Company	99
International Resistance Co.	76
Jappe Company, H.	85
Johnson Company, E. F.	100
Kaltman and Romander	90
Kellogg Switchboard & Supply Co.	101
L. I. Marine & Electric Co.	82, 95
Ledis	79, 91
Littelfuse Laboratories	101
M & H Sporting Goods Co.	89
Massachusetts Radio School	101
Midwest Radio Mart	107
National Company	75, 100, 102, Cov. 3
New York Y. M. C. A.	91
Offenbach Electric Company	95
Precision Piezo Service	91
Premier Crystal Laboratories	101
RCA Institutes, Inc.	89
RCA Manufacturing Co.	77, 83, Cov. 4
Radio Laboratories	85
Radio Receptor Company	94
Radio Shack	105
Radio Supply Company	89
Radio Television & Supply	85
Radio Transceiver Labs.	99
Raytheon Mfg. Company	102
Sangamo Electric Company	105
Scientific Radio Service	104
Sinter Supply Company	85
Shure Brothers Company	104
Teleplex Company	99
Triplett Electrical Instrument Co.	88
Turner Company	99
United Radio Mfg. Company	91
Universal Microphone Co.	105
Vibroplex Company	94
Vaxley Mfg. Company	111

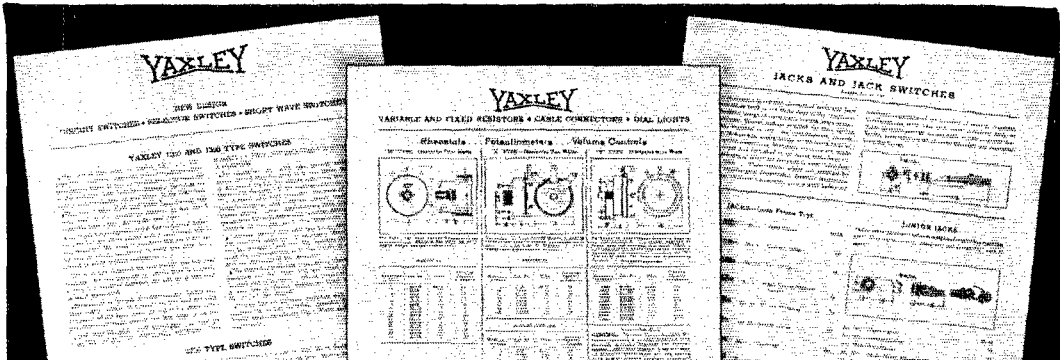

Make the Yaxley Jobber Your Friend by STANDARDIZING on Genuine Yaxley Replacement Parts

DON'T MISS THIS SPECIAL OFFER



The Yaxley Kit of 6 Volume Controls that service more than 2500 set models.



This handy wrench is FREE with each kit.

A copy of this complete and authoritative Replacement Manual is yours for the asking.

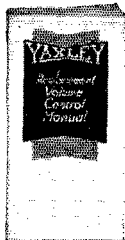

There is no better way to insure better profits in your radio service business than to give your customers still better service. And every service man knows that Yaxley Distributors who carry the Yaxley line 100% can give him the best service obtainable anywhere.

By being able to supply your needs promptly with a complete line of high quality parts, the Yaxley Jobber acts as your friend, and in so doing helps you build a profitable service business. He makes your job easier by being able to provide you with a product for which a wide acceptance has long been established by an extensive and sustained program of national advertising.

Mail the coupon today for your free copies of Yaxley catalogs Y-201, Y-202 and Y-203, illustrated above, which give full information and prices on the complete line of Yaxley parts. They will be very helpful in enabling you to give still better service.

YAXLEY MANUFACTURING COMPANY, INC.

Division of P. R. Mallory & Company, Incorporated
INDIANAPOLIS, INDIANA

Cable Address: *Pelmallo*

YAXLEY MANUFACTURING CO., INC.
Indianapolis, Indiana

Gentlemen:

Please send me free copies of Catalogs Y-201, Y-202, Y-203.

I enclose \$3.60 (which is 40% less than the regular list price of individual controls) for kit of 6 Volume Controls, which entitles me to FREE Wrench.

I enclose 6 carton tops for FREE Wrench.

Please send free copy of Yaxley Replacement Volume Control Manual.

Name _____

Address _____

My Jobber's Name is _____

CARELESS SELECTION of CONDENSERS

*Can also
mean waste!*

The photographer's carelessness in taking a double exposure means, at most, the waste of two negatives and his time. The careless choice of condensers that are to be included in expensive receiving and transmitting equipment may well cause damage that runs into real money. The fine performing and mechanical qualities of the CARDWELL are acknowledged everywhere by those who *really know*. That's why we say, "Insist on a CARDWELL when you want a *dependable* condenser".

There's a CARDWELL for every tube and purpose, and remember that in the long run

"THE BEST IS THE CHEAPEST". *Send for Literature.*



CARDWELL "TRIM-AIR" "MIDGET"
CONDENSERS

CARDWELL "STANDARD" MODELS
FOR RECEIVERS and MEDIUM
POWER TRANSMITTERS

CARDWELL MIDWAY
"FEATHERWEIGHT" CONDENSERS,
RECEIVING and TRANSMITTING

CARDWELL 16-B TRANSMITTING
CONDENSERS FOR LARGER
TRANSMITTERS

CARDWELL HIGH VOLTAGE
CONDENSERS FOR COMMERCIAL
RADIO-TELEGRAPH
and BROADCASTING STATIONS

CARDWELL S-2244 OIL DIELECTRIC
FIXED CONDENSERS FOR HIGH
FREQUENCY FURNACES and
TUBE BOMBARDERS

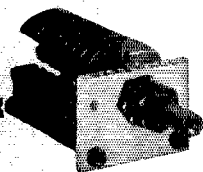

THE ALLEN D. CARDWELL MFG. CORP'N.
83 PROSPECT STREET, BROOKLYN, N. Y.

"THE STANDARD of COMPARISON"

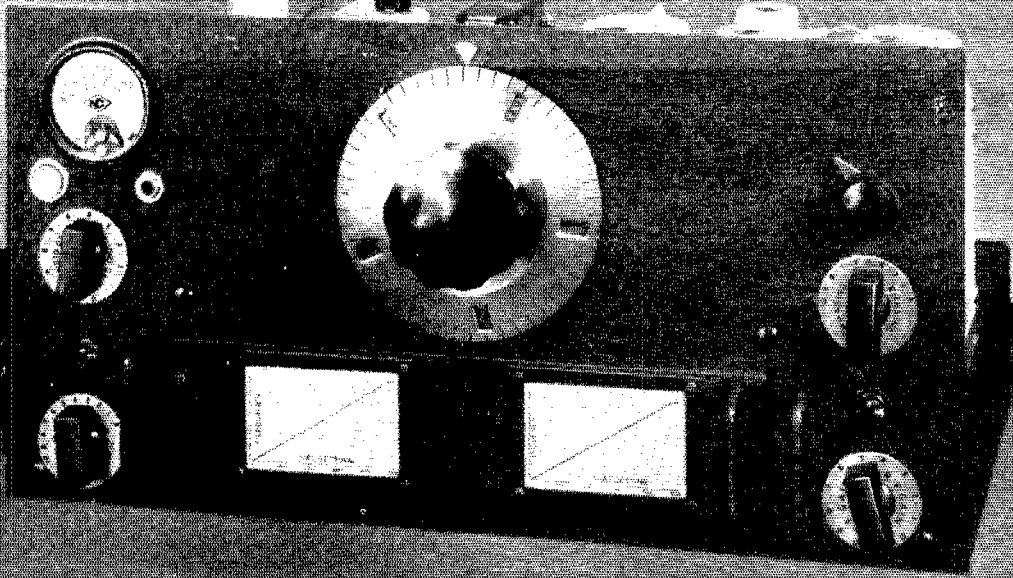

THE HRO

A few of the 59 air-dielectric condensers that make each HRO drift free are illustrated on this page, plus a few of the moldings that contribute to its efficiency, and a few of the machinings that lend it precision.

It is as unique in construction as in performance. Look it over at your dealers.

National  Company

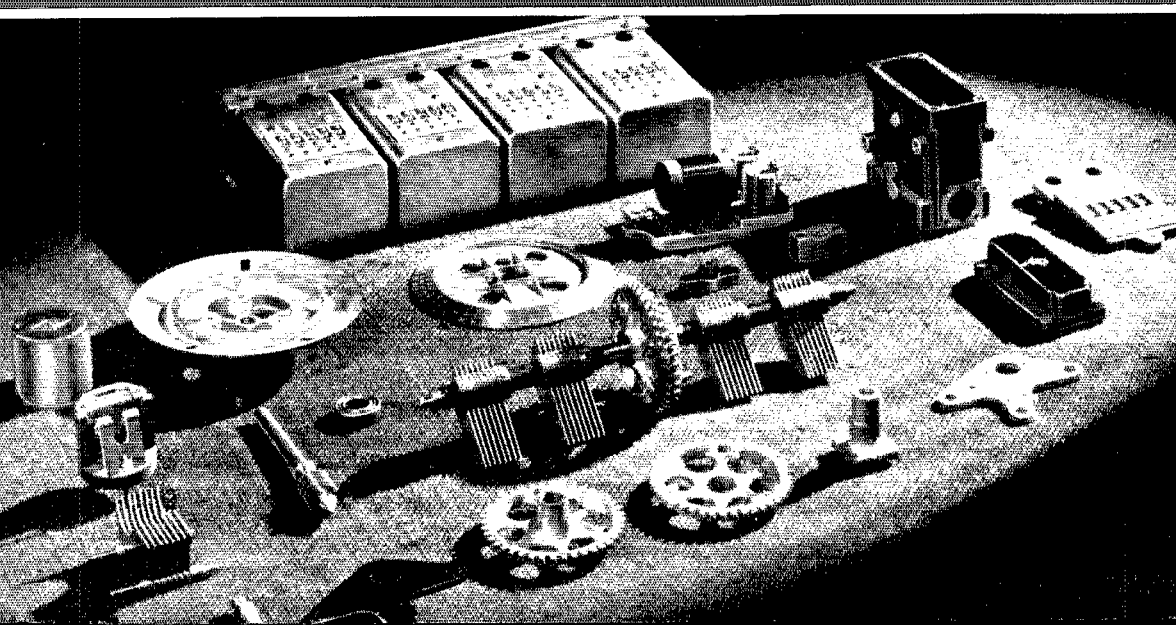
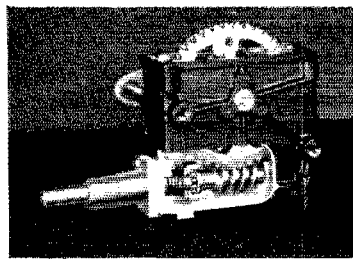
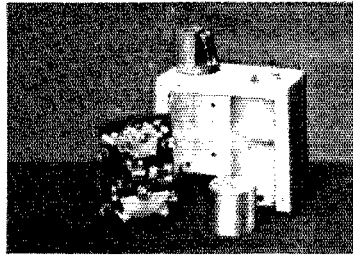
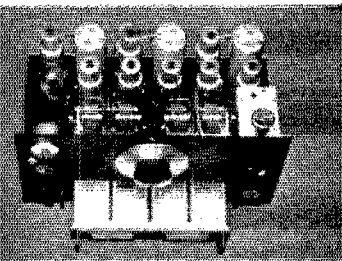
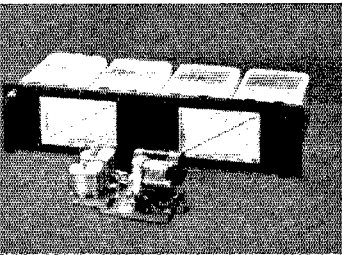

Try the SIDE-BY-SIDE TEST

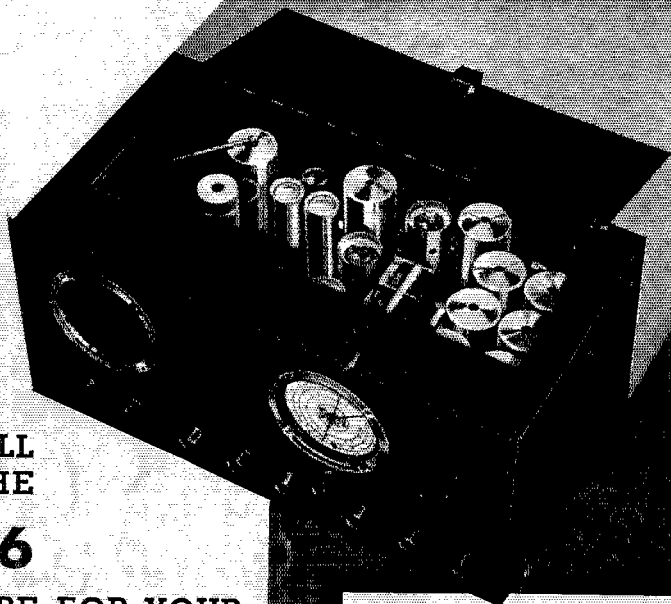

WE THINK YOU'LL
AGREE THAT THE

ACR-136

GIVES YOU MORE FOR YOUR
MONEY THAN ANY OTHER
AMATEUR RECEIVER AT ANY-
WHERE NEAR THE PRICE

First, check the features of the ACR-136 against those of other receivers selling at the same price or even considerably higher. Then, go to your nearest Authorized Sales Outlet and try the ACR-136 in operation. If possible, make a side-by-side operation check with other receivers. We feel sure that you will agree with us—and with the hundreds of amateurs who have bought the ACR-136 on this basis—that it is not only a swell instrument, but an unbeatable value. Descriptive folder free on request.

\$69⁵⁰

(F. O. B. FACTORY)

COMPLETE

Seven-tubes superheterodyne • One efficient tuned r-f stage, assuring low image response • Single-control tuning • Frequency-calibrated dial which permits positive logging • No plug-in coils • Band change by switch from front of panel • Both a-f and r-f gain control, giving unusual flexibility • Separate r-f and detector coils for each range • Tone control • Readily adjustable beat-frequency control • Excellent tone quality • Superior sensitivity and selectivity • 540-to-18,000-kilocycle range • Built-in speaker and power supply, with nothing else to buy.



AMATEUR RADIO SECTION

RCA Manufacturing Co., Inc.

Camden • • • • • New Jersey