

QST

July, 1936
25 cents

devoted entirely to

amateur radio

In this Issue—

**Further
Advances in
Transmitter
Design**



CALLING ALL CONTINENTS

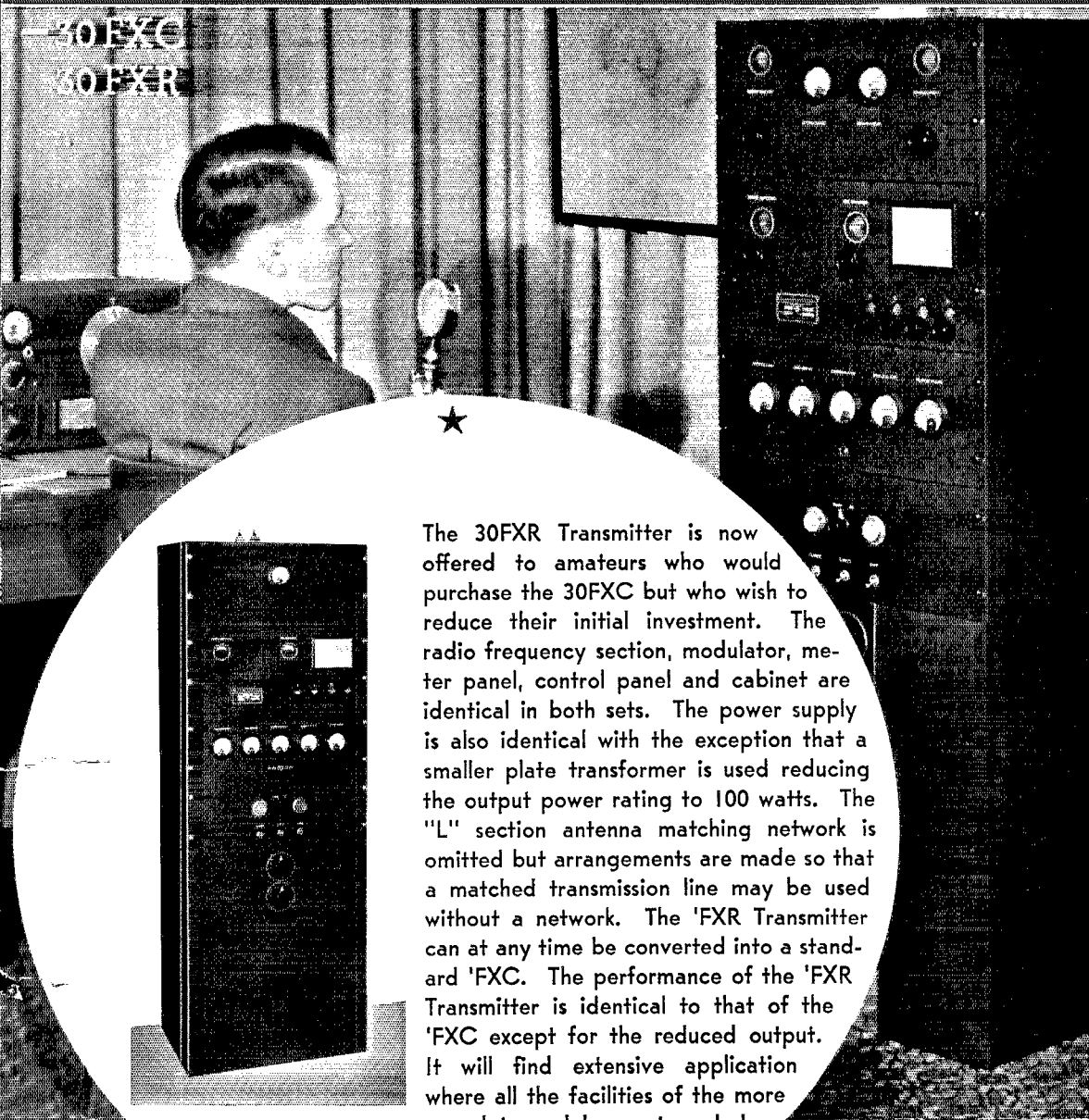

The 30FXR Transmitter is now offered to amateurs who would purchase the 30FXC but who wish to reduce their initial investment. The radio frequency section, modulator, meter panel, control panel and cabinet are identical in both sets. The power supply is also identical with the exception that a smaller plate transformer is used reducing the output power rating to 100 watts. The "L" section antenna matching network is omitted but arrangements are made so that a matched transmission line may be used without a network. The 'FXR Transmitter can at any time be converted into a standard 'FXC. The performance of the 'FXR Transmitter is identical to that of the 'FXC except for the reduced output. It will find extensive application where all the facilities of the more complete model are not needed.

The 30FXC has every feature v
experience has shown to be desir
in a general purpose high frequ
transmitter—rated output 175 w
quick frequency change 30 mc
1.5 mc.

30FXC USERS SAY: "THE MOST OUTSTANDING TRANSMITTER MADE"

Collins Radio Company

CEDAR RAPIDS
New York
11 West 42nd St.



IOWA, U. S. A.
Mexico City
Edificio "La Nacional"

ANNOUNCING the WINNERS of the HALLICRAFTERS' MILEAGE MARATHON

After careful checking of the hundreds of logs submitted by the entrants in the HALLICRAFTERS' MILEAGE MARATHON, the judges have finally determined the winners. It has been a tremendous task that has taken far more time than originally anticipated but here they are.

First Prize — \$200

WILLIAM HALL, Widener, Ark.
"Total Mileage — 6,111,550"

Second Prize — \$100

I. G. CAMPBELL, 196 Van Houten Avenue, Passaic, N. J.
"Total Mileage — 4,129,380"

Third Prize — SUPER SKYRIDER

HUGH MACPHERSON, 95 Devett Road, Rochester, N. Y.
"Total Mileage — 3,534,955"

Fourth Prize — SUPER SEVEN

JOHN E. ROBERTS, 4221 Winchester St., Atlantic City, N. J.
"Total Mileage — 3,334,741"

Fifth Prize — \$10

F. G. A. MAKEPEACH, Sub. P. O. 23, Edmonton, Alberta, Can.
"Total Mileage — 3,001,650"

Sixth Prize — \$10

GEORGE MCQUISTON, 717 Olin Ave., Indianapolis, Ind.
"Total Mileage — 2,682,490"

Seventh Prize — \$10

CHAS. W. ROGERS, 155 Main St., Manasquan, N. J.
"Total Mileage — 2,684,020"

Eighth Prize — \$5

CLYDE CHAMBERS, 519 Foyette St., Washington, Pa.
"Total Mileage — 2,669,916"

Ninth Prize — \$5

DAVID F. DANSER, 702 Eldridge Ave., W. Collingswood, N. J.
"Total Mileage — 2,624,530"

Tenth Prize — \$5

J. M. CLARKE, 937 Washington Blvd., Pittsburgh, Pa.
"Total Mileage — 2,533,915"

Eleventh Prize — \$5

VANE A. JONES, 1105 West 31st St., Indianapolis, Ind.
"Total Mileage — 2,425,670"

Twelfth Prize — \$5

EARL R. ROBERTS, 2308 Roosevelt Ave., Indianapolis, Ind.
"Total Mileage — 2,276,840"

Thirteenth Prize — \$5

WALLACE H. TRAVERS, JR., 64 Essex Ave., Glen Ridge, N. J.
"Total Mileage — 2,019,945"

To the Winners—congratulations, and our thanks to all who entered to make this contest the success it has been.

Sincerely,

W. J. HALLIGAN, *President*
THE HALLICRAFTERS

MARINE 140 B

A modern transmitter having a nominal output rating of 175 Watts Phone and C.W. (Actual measured output more than 200 watts).

Incorporates the latest developments in broadcast engineering. Completely equipped with Visual Oscilloscopic Modulation Control, Variable Panel Switch for line voltage control, Eight Three Inch Meters, Complete Overload Relay Protection, and Protective Rear Door Cut-Out Switch.

Other important marine characteristics of this ultra-modern transmitter completely detailed in descriptive literature supplied on request

VISUAL OSCILLOSCOPIC MODULATION CONTROL

INQUIRE REGARDING OUR DEFERRED
PAYMENT PLAN

Catalogs and photographs on other Marine transmitters from 20 to 75 watts also available.

All Marine transmitters unconditionally guaranteed for one year.

MARINE RADIO COMPANY

60 Lispenard Street, New York City

Note: During the Summer months of July and August offices and factory will be closed on Saturday.

Say You Saw It in QST — It Identifies You and Helps QST

QST

devoted entirely to

AMATEUR RADIO

PUBLISHED, MONTHLY, AS ITS OFFICIAL ORGAN, BY THE AMERICAN RADIO RELAY LEAGUE, INC., AT WEST HARTFORD, CONN., U. S. A.; OFFICIAL ORGAN OF THE INTERNATIONAL AMATEUR RADIO UNION

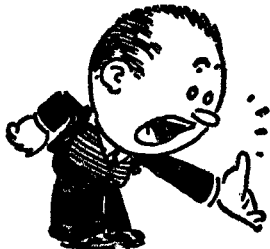

JULY
1936

Volume XX
Number 7



Kenneth B. Warner (Secretary, A.R.R.L.), *Editor-in-Chief and Business Manager*; Ross A. Hull, *Associate Editor*; James J. Lamb, *Technical Editor*; George Grammer, *Assistant Technical Editor*; Clark C. Rodimon, *Managing Editor*; David H. Houghton, *Circulation Manager*; F. Cheyney Beekley, *Advertising Manager*; Ursula M. Chamberlain, *Assistant Advertising Manager*.

Editorial and Advertising Offices

38 La Salle Road
West Hartford, Connecticut

Subscription rate in United States and Possessions and Canada, \$2.50 per year, postpaid; all other countries, \$3.00 per year, postpaid. Single copies, 25 cents. Foreign remittances should be by international postal or express money order or bank draft negotiable in the U. S. and for an equivalent amount in U. S. funds.

Entered as second-class matter May 29, 1919, at the post office at Hartford, Connecticut, under the Act of March 3, 1879. Acceptance for mailing at special rate of postage provided for in section 1103, Act of October 3, 1917, authorized September 9, 1922. Additional entry at Concord, N. H., authorized February 21, 1929, under the Act of February 28, 1925.

Additional second-class entries to cover sectional editions authorized March 20, 1935. Copyright 1936 by the American Radio Relay League, Inc. Title registered at United States Patent Office.

The Contents

Editorials	7
Five Meters Again Shoots the Works	9
Simplifying the Push-Pull-Push Oscillator <i>J. Stanley Brown, W3EHE</i>	10
A 500-Watt Transmitter with Band-Switching Exciter <i>Clark C. Rodimon, W1SZ</i>	13
What the League Is Doing	19
A "Neon Stick" for Visual Modulation <i>C. A. Campbell, W9QK</i>	21
Inductive Neutralization of R.F. Amplifiers <i>L. M. Craft and Arthur A. Collins</i>	22
Hamdom	25
1935 Sweepstakes Contest Results <i>E. L. Battey, W1UE</i>	26
High-Fidelity at Low Cost <i>A. G. Hull</i>	34
A New Type of Unguyed Skyhook for Amateur Antennas <i>Frank Cartwright</i>	37
Audio Amplifier Noise Interference Silencers <i>N. Bishop, W1EYM</i>	39
A High-Power Three-Stage C.W. Transmitter with Beam Power Crystal Control . . <i>Frank Edmonds, W2DIY</i>	41
Dixie Jones' Owl Juice	42
Hints and Kinks	43
Amateur Radio Stations <i>W8ACY, W5VU</i>	45
I.A.R.U. News	46
Operating News	48
Correspondence Department	55
New Receiving Tubes: 1F4, 1F6, 5W4, 6N7	60
Missouri State Convention	62
Standard Frequency Transmissions	64
New England Division Convention	66
Rocky Mountain Division Convention	68
Ohio State Convention	68
Silent Keys	80
Hamads	91
QST's Index of Advertisers	94

An Ideal Receiver!



The Hammarlund "Super Pro"

IN the nation's leading research laboratories, on the air fields, in "ham" shacks, on scientific expeditions, in naval and war departments, coast-to-coast broadcast systems, foreign commercial and government services — everywhere — where the most exacting equipment must be used, Hammarlund "Super Pros" have been unanimously approved and promptly installed! "Super Pros" receive such decided acclamation, for they have every grand, important feature demanded by experts—truly the "ideal receiver." One such feature is the electrostatically shielded input. Then there is that uncanny, exclusive Hammarlund five-band switch, remarkably positive and smooth in action. The unique variable selectivity system affords continuous variation from 1/3 to over 3 times critical coupling. Another fea-

ture is the special 12-gang band spread condenser. That cleverly designed "Super-Pro" crystal unit permits selectivity from a knife-like point for C.W. to a wider degree for practical phone reception. And there are dozens of other outstanding features winning new admiration every moment. The "Super-Pro" reaches new performance standards that you've always wanted! The complete story of this "ideal instrument" appears in a profusely illustrated bulletin. Write for your copy today!

MAIL COUPON FOR FULL DETAILS!

HAMMARLUND MFG. CO., Inc. Q-7
424-438 W. 33rd St., New York
 Check here for complete data on the new
Hammarlund "Super Pro."
 Check here for 1936 Hammarlund General Catalog.

Name.....

Address.....

HAMMARLUND'S 25TH YEAR

Section Communications Managers of the A.R.R.L. Communications Department

All appointments in the League's field organization are made by the proper S.C.M., elected by members in each Section listed. Mail your S.C.M. (on the 16th of each month) a postal covering your radio activities for the previous 30 days. Tell him your DX, plans for experimenting, results in 'phone and traffic. He is interested, whether you are an A.R.R.L. member or get your QST at the newsstands; he wants a report from every active ham. If interested and qualified for O.R.S., O.P.S. or other appointments he can tell you about them, too.

Eastern Pennsylvania	W3EZ	ATLANTIC DIVISION James M. Bruning	339 W. Lancaster Ave.	Haverford
Maryland-Delaware-District of Columbia	W3BAK W3ZX W8DSS W8CUG	Edgar L. Hudson Carroll D. Kentner Charles Smith C. H. Grossarth	1107 Park Ave. 310 E. Walnut St. 261 N. Balph Ave.	Laurel, Delaware Collingswood Oneda Bellevue
Southern New Jersey		CENTRAL DIVISION		
Western New York	W9WR	Fred J. Hinds	6618 West 34th St.	Berwyn
Western Pennsylvania	W9TE	Arthur L. Braun	530 East Morris St.	Indianapolis
Illinois	W9AUH	G. W. Mossbarger	Box 177	Camp Taylor
Indiana	W8DYH	Kenneth F. Conroy	18030 Waltham Ave.	Detroit
Kentucky	W8CIO	Robert P. Irvine	5508 Northcliff Ave.	Cleveland
Michigan	W9ATO	E. A. Cary	3922 No. 19th Pl.	Milwaukee
Ohio		DAKOTA DIVISION		
Wisconsin		Hartwell B. Burner		Hope
North Dakota	W9OEL	Andrew J. Kjar	257 Prospect Ave.	Pierre
South Dakota	W9SEB	Leonard Holstad		Elbow Lake
Northern Minnesota	W9OWU	Webster F. Soules	3549 36th Ave., So.	Minneapolis
Southern Minnesota	W9DCM			
		DELTA DIVISION		
Arkansas	W5ABI	H. E. Velte	2918 West 15th St.	Little Rock
Louisiana	W5DWW	W. J. Wilkinson, Jr.	1523 Laurel St.	Shreveport
Mississippi	W5CWQ	J. H. Weems, Jr.	P. O. Box 244	State College
Tennessee	W4BBY	Merrill B. Parker, Jr.	1912 Oak St.	Chattanooga
		HUDSON DIVISION		
Eastern New York	W2LU	Robert E. Haight	511 South Holmes St.	Scotia
N. Y. C. & Long Island	W2AZY	E. L. Baunach	7823 10th Ave.	Brooklyn
Northern New Jersey	W2FOP	Charles J. Hammersen	92 Claremont Ave.	Verona
		MIDWEST DIVISION		
Iowa	W9LEZ	Phil D. Boardman	325 Kirkwood Blvd.	Davenport
Kansas	W9FLG	O. J. Spetter	305 Western Ave.	Topeka
Missouri	W9CJR	J. Dewey Mills	Box 205	Mount Vernon
Nebraska	W9FAM	Samuel C. Wallace	Green St.	Clarks
		NEW ENGLAND DIVISION		
Connecticut	W1CTI	Frederick Ellis, Jr.	19 Merrill Rd.	Norwalk
Maine	W1CDX	John W. Singleton	73 Allen St.	Wilton
Eastern Massachusetts	W1ABG	Albert N. Gladis	128 Crawford St.	Lowell
Western Massachusetts	W1BVR	Perot C. Noble	37 Broad St.	Westfield
New Hampshire	W1AVJ	Robert Byron	12 Humphrey St.	Concord
Rhode Island	W1HRC	Clayton C. Gordon	206 Calhoun Ave.	Providence
Vermont	W1GNF	Alvin H. Battison	9 Central St.	Windsor
		NORTHWESTERN DIVISION		
Alaska	K7PQ	Richard J. Fox	Box 301	Ketchikan
Idaho	W7NH	Nellie H. Hart	Box 6	Twin Falls
Montana	W7CRH	Russell U. Richmond		Somers
Oregon	W7AMP	Frank L. Black	1502 McPherson St.	North Bend
Washington	W7WY	Robert H. Votaw	Route 1, Box 398	Vancouver
		PACIFIC DIVISION		
Hawaii	K6EWQ	Atlas O. Adams	21st Infantry Brigade	Schofield Barracks
Nevada	W6BIC	Edward W. Heim	509 Claremont St.	Reno
Santa Clara Valley	W6BMW	Charles J. Camp	318 Hawthorne Ave.	Palo Alto
East Bay	W6TFV	Carol C. Burchfield	2240 106th Ave.	Oakland
San Francisco	W6SG	Alan D. Whittaker, Jr.	79 Elinor Ave.	Mill Valley
Sacramento Valley	W6DVE	Geo. L. Woodington	716 Redwood Ave.	North Sacramento
Philippines*	KA1GR	George L. Rickard	Box 849	Manila
San Joaquin Valley	W6CRF	Vernon C. Edgar	732 Blackstone Ave.	Fresno
		ROANOKE DIVISION		
North Carolina	W4OG	H. S. Carter	115 Crafton St.	Winston-Salem
Virginia	W3UYA	Charles M. Waff, Jr.	P. O. Box 1212	Univ., Charlottesville
West Virginia	W8KKG	Dr. Wm. H. Riheldaffer		Lost Creek
		ROCKY MOUNTAIN DIVISION		
Colorado	W9FA	Glen Glasscock	2164 So. Corona St.	Denver
Utah-Wyoming	W6GQC	Arty W. Clark	260 So. 9th West	Salt Lake City, Utah
		SOUTHEASTERN DIVISION		
Alabama	W4DGS	James F. Thompson	2248 S. Arlington Ave.	Birmingham
Eastern Florida	W4BCZ	Philip A. McMasters	731 Arlington Ave.	St. Petersburg
Western Florida	W4MS	Edward J. Collins	1517 East Brainard St.	Pensacola
Georgia-So. Carolina-Cuba- Isle-of-Pines-Porto Rico- Virgin Islands	W4CE	Bannie L. Stewart	C. C. C. Co. 4466	York, S. C.
		SOUTHWESTERN DIVISION		
Los Angeles	W6BPU	Howell C. Brown	120 N. El Molino Ave.	Pasadena
Arizona	W6LVG	C. C. Day	"La Posta Quemada"	Vail
San Diego	W6EOP	Harry A. Ambler	4101 Hamilton St.	San Diego
		WEST GULF DIVISION		
Northern Texas	W5BH	Richard M. Cobb	Box 185	Dodd City
Oklahoma	W5CEZ	Carter L. Simpson	2010 So. 4th St.	Ponca City
Southern Texas	W5BDI	Ammon O. Young	4803 Eli St.	Houston
New Mexico	W5CGJ	Joseph M. Eldott		Chamita
		MARITIME DIVISION		
Maritime	VE1DQ	A. M. Crowell	69 Dublin St.	Halifax, N. S.
		ONTARIO DIVISION		
Ontario	VE3QK	John Perdue	229 Askin Boulevard	Windsor, Ont.
		QUEBEC DIVISION		
Quebec	VE2EE	Stan Comach	780 Brault Ave.	Verdun, P. Q.
		VANALTA DIVISION		
Alberta	VE4LX	Alfred D. Kettenbach		Rockyford
British Columbia	VE5EP	D. R. Vaughan-Smith	1221 Burnaby St.	Vancouver
		PRAIRIE DIVISION		
Manitoba	VE4BG	A. J. R. Simpson	71 Thelmo Mansions	Winnipeg
Saskatchewan	VE4EL	Wilfred Skaffe	2040 McTavish St.	Regina

* Officials appointed to act until the membership of the Section choose permanent S.C.M.'s by nomination and election.

The American Radio Relay League



THE AMERICAN RADIO RELAY LEAGUE, INC., is a non-commercial association of radio amateurs, bonded for the promotion of interest in amateur radio communication and experimentation, for the relaying of messages by radio, for the advancement of the radio art and of the public welfare, for the representation of the radio amateur in legislative matters, and for the maintenance of fraternalism and a high standard of conduct.

It is an incorporated association without capital stock, chartered under the laws of Connecticut. Its affairs are governed by a Board of Directors, elected every two years by the general membership. The officers are elected or appointed by the Directors. The League is non-commercial and no one commercially engaged in the manufacture, sale or rental of radio apparatus is eligible to membership on its board.

"Of, by and for the amateur," it numbers within its ranks practically every worth-while amateur in the nation and has a history of glorious achievement as the standard-bearer in amateur affairs.

Inquiries regarding membership are solicited. A bona fide interest in amateur radio is the only essential qualification; ownership of a transmitting station and knowledge of the code are not prerequisite. Correspondence should be addressed to the Secretary.

HIRAM PERCY MAXIM, FOUNDER

OFFICERS

President.....EUGENE C. WOODRUFF, W8CMP
State College, Pa.

Vice-President.....GEORGE W. BAILEY, W1KH
Weston, Mass.

Secretary.....KENNETH B. WARNER, W1EH
West Hartford, Connecticut

Treasurer.....ARTHUR A. HEBERT, W1ES
West Hartford, Connecticut

Communications Mgr....F. EDWARD HANDY, W1BDI
West Hartford, Connecticut

General Counsel.....PAUL M. SEGAL, W3EEA
1010 Shoreham Building, Washington, D. C.

Address all general correspondence to the executive headquarters at West Hartford, Connecticut

DIRECTORS

President
EUGENE C. WOODRUFF.....W8CM-
226 W. Fairmount Ave., State College, Pa.

Vice-President
GEORGE W. BAILEY.....W1KH
74 Webster Road, Weston, Mass.

Canadian General Manager
ALEX REID.....VE2BE
169 Logan Ave., St. Lambert, P. Q.

Atlantic Division

Central Division
EDWARD A. ROBERTS.....W8HC
2699 Endicott Rd., Shaker Heights, Cleveland

Dakota Division
CARL L. JABS.....W9BVH
1822 James St., St. Paul, Minn.

Delta Division
E. RAY ARLEDGE.....W5SI
P. O. Box 286, Pine Bluff, Ark.

Hudson Division
KENNETH T. HILL.....W2AHC
115 Willow St., Douglaston, L. I., N. Y.

Midwest Division
FLOYD E. NORWINE, JR.....W9EFC
120 South Fourth St., St. Louis, Mo.

New England Division

Northwestern Division
RALPH J. GIBBONS.....W7KV
c/o United Air Lines, Pendleton, Ore.

Pacific Division
S. G. CULVER.....W6AN
2962 Russell St., Berkeley, Calif.

Roanoke Division
H. L. CAVENESS.....W4DW
State College Station, Raleigh, N. C.

Rocky Mountain Division
RUSSELL J. ANDREWS.....W9AAB
1867 So. Lafayette St., Denver, Colo.

Southeastern Division
BENNETT R. ADAMS, JR.....W4APU
1512 Grove Place, Homewood, Ala.

Southwestern Division
CHARLES E. BLALACK.....W6GG
443 Main St., El Centro, Calif.

West Gulf Division
WAYLAND M. GROVES.....W5NW
c/o Humble Pipe Line Co., Neches, Texas

THE EDITOR'S MILL

LADEEZ and gemmun, permit us—the President and the Vice-President of the American Radio Relay League! In the haste to button up last month's *QST* after the Board meeting, there was time only to mention the names of the distinguished amateurs who have become our new officers. Although they are both well-known figures in the amateur world, a more extended introduction is now in order.



DR. EUGENE C. WOODRUFF, WSCMP
President, A.R.R.L.

teaching, he has taught practically every scientific subject at schools and colleges in various locations, including—in addition to State College—Bozeman, Mont., Decatur, Ill., and Chicago. He has been much interested all his life in athletics and has coached in football, baseball, track and basketball at various places where he taught.

He has of course left his mark in the scientific world. He is a fellow of the American Association for the Advancement of Science and a member of the American Institute of Electrical Engineers and of the Institute of Radio Engineers. He is also a member of Sigma Xi, Phi Kappa Phi and Sigma Tau, and was a 1935 medalist for Pi Eta Sigma for scientific attainment. He is the inventor of a system of automatic controllers for railway motors and industrial motors of considerable importance. Although the device has not been marketed, it served as the subject for several years of senior research, which was more important!

Dr. Eugene C. Woodruff, A.R.R.L.'s second president, is the head of the Departments of Electric Railways and Radio, senior classes, at Pennsylvania State College, located in the city of State College in that state; he also teaches general electrical engineering to a junior class. He started life in St. Clair, Michigan, April 8, 1871, and received most of his schooling at Ann Arbor, graduating from the University of Michigan there with the degree of B.Sc. in general science in 1894. His master's degree in chemistry, physics and music was received in 1896, to be followed in 1900 by a Ph.D. in physics, mathematics and chemistry. Entering then upon a life of



MR. GEORGE W. BAILEY, WIKH
Vice-President, A.R.R.L.

In a life devoted to investigation and ingenious experimentation, the doctor has been a pioneer in several fields. He has been an enthusiastic photographer since 1899. He began automobiling in 1908 and has since owned twenty-three cars and driven across the continent twenty-five times. His blue Duesenburg, with the call W8CMP on the trunk, has been seen in almost every state of the Union. There is an art side also, for Dr. Woodruff is an accomplished musician, having graduated from the University School of Music at Ann Arbor in 1896. His particular interest is the pipe organ and he was organist in various churches for about twenty-five years.

He started radio in 1897, at the very beginnings of this art. He is in consequence one of the real radio pioneers, the entire development of radio being encompassed within his scientific career. W8CMP has always been an active station. More than that, it is a laboratory, for it is at his home station that Dr. Woodruff conducts his senior class in radio. He is an indefatigable constructor of new and interesting apparatus. Combining this with photography, the methodical habit of making up notebooks of experiments and results, and a lifetime's teaching and lecturing ability, Dr. Woodruff has been much in demand as a speaker at amateur conventions. Lending the aforesaid Duesenburg to these purposes, he has been a convention speaker in almost every A.R.R.L. division. It is probable that no one outside the A.R.R.L. headquarters staff has attended so many ham gatherings, where "Doc Woodruff and his bag o' tricks" have been the highlight of many a program. Elected to the A.R.R.L. Board in 1925, he is the dean of the directors and an able chairman. An ardent amateur himself, he has an intact philosophy on the value of amateur radio in American life, some of which our readers have no doubt glimpsed in the utterances of the Cairo Committee.

George W. Bailey, fifth man to serve A.R.R.L. as vice-president, is a New Englander all the way back. Born May 14, 1887, he graduated from Adams Academy at Quincy, Mass., and from Harvard in 1907. He is the treasurer of his Harvard class. A practical business man, he has spent fifteen years in shoe manufacturing and fourteen years in the manufacturing and selling of rubber flooring. His business connections are the Stedman Rubber Flooring Company and the Bailey Rubber Tile Company, of which latter he is president. In Honolulu in 1913 he married Alice Cooper, distinguished authoress. They have three children, a married daughter, a son who enters Harvard this coming autumn, and a boy of nine who is a real ham already.

George Bailey is a big fellow who radiates good fellowship. He has had an amazingly active career as an amateur. A member of A.R.R.L. for about ten years, he has served the New England Division as its director the past five. He was president

of the Eastern Massachusetts Amateur Radio Association for seven years, is a regular member of three New England ham clubs, an honorary member in five others, and an honorary life member of the Chair Warmers Club.

The League's vice-president is a real practising amateur. He holds a W.A.C. certificate, having worked seventy-four countries with a pair of 210's. He has an A.R.R.L. public service certificate for his work in the *Viking* disaster. He is a member of the A-1 Operator Club, holds A.R.R.L. appointments as O.R.S., O.O., O.B.S., and was formerly R.M. for Eastern Massachusetts. He has kept a schedule at 6:30 A.M. daily for six years with the amateur station of the Grenfell Mission in Labrador and is assistant secretary of the International Grenfell Association. His accomplishments in emergencies have made front-page news and brought letters of commendation from authorities. He is a real ham if there ever was one!

THERE is a third personality about whom we would like to say a few words this month. Arthur A. Hebert, treasurer of the League, has just been released by the Board of Directors from field work, at his own request, after having served the Board in that respect for twelve years. He carries on, of course, in the West Hartford office but will now be able to take things a bit easier after rather strenuous service, while some of the younger fellows in the headquarters gang rotate amongst themselves the business of visiting clubs and conventions.

Some of the statistics on Hebie's travels may be of interest. He covered over 157,000 miles, attended 99 divisional conventions and 189 special meetings, made talks before a total of 35,438 people. A.R.R.L. expended \$10,761 sending him on this missionary work. His longest trip was in 1924 when on one journey he covered 23,559 miles, visiting 14 conventions and 34 special meetings.

He is perhaps America's best-known amateur as the result of these travels and in turn himself knows hundreds of hams. In his journeys he has made countless personal friends, and many friends for the League as well. His travels have been a symbol of the fraternal side of amateur radio.

K. B. W.

Strays

W9OKZ, investigating a complaint of ham interference from a BCL, found that said BCL had thrown away all the tube shields because the instruction book with the set said that "cartons on tubes were for shipping purposes only and should be removed." Which is even worse than the BCL, who tightened all the trimmers on his new set because he thought the screws were loose!

Five Meters Again Shoots the Works

Night-Time Thousand-Mile Working Repeated Under Extraordinary Circumstances

MAY 9, 1936, will stick in the minds of many hams for years to come. It is the date of what has been dubbed "The Great Five-Meter Panic." On that night, the band undid the string on its bag of tricks and shot the whole works. Forgetting that it was supposed to limit signals to their immediate neighborhood, the band carried East Coast signals to the Middle West and dumped them down there with an unholy wallop. And, playing no favorites, it carried the Western signals to the East with just as much of a whack. Wot a nite!!

Almost a year ago (May 26th, 29th and June 22nd) five meters gave us the first real showing of its possibilities when a handful of stations exchanged signals between the East Coast and the Chicago area. Many people still doubt that genuine DX signals were heard and worked at that time but we have long since established that they really were. The session of May 9th now proves very conclusively that five meters can and does do things like that and, what is more, that it is becoming more adept at the business. Our tip, based on nothing more than a chat with some of the scientific people who spend their days observing Kennelly-Heaviside layers and such, is that the lower ultra-high frequencies are just giving us a few hints of what is coming. Maybe, before we are much older, five will be doing what ten has done. Anyway, OM's, five is worth watching.

This May 9th affair seems to have started up at approximately 8:30 p.m.—a strange time for the ionosphere to get geared up for very high frequencies. Operators out in the middle of the country, peacefully chewing fat with their near neighbors, were then started to find the band smeared up with W1's, 2's and 3's. And the peaceful fat-chewing Easterners, no less startled, found their private band choked up with W9's. Then the real fun started. In the three hours that followed, a wide-spread group of ultra-high-frequency workers soaked up the sort of thrill that they will be telling their grandchildren about in the dim years to come.

Unfortunately, as it happens, many of the participants have apparently been so busy telling their own children about it that they have not had time to report in to Ye Olde A.R.R.L. Hence we are only able to present a few authentic details abstracted from logs. We have had to depend on grapevine telegraphs for the general picture of the "panic."

For the benefit of future historians and as proof

that May 9th was not a big spoof night, we include the following outline of work reported:

Columbus, Ohio

H. R. Young, W8LEN, between 8:30 and 9:45 p.m. E.S.T. heard W1CEE, W1HQE, W1CMF?, W1ABR?, W1BKE and a host of others signing too rapidly to be logged. P. S. Kaparaff, W8OUP of the same city also logged a group of W1's.

Des Plaines, Ill.

G. E. Hart, W9LBP, between 9:10 and 11:00 p.m. E.S.T. worked W3FJW, W3NU and W3CTG before his mike battery went dead. He heard W1CE, W3EUY, W3FMU, W3EP and W2HWC. His antenna is a directive affair; the transmitter a pair of 59's and the receiver a two-tube superregen. Severe selective fading was noticed, with part of the signal dropping out and the rest remaining.

Niles Center, Ill.

James E. Dickert, W9PEI, worked W3GAH, W1DVO, W2AMJ, W2BRO, and heard W3HG, W2IIN, W3KW, W3BO, W3AYG, W1ZE, W1EER, and W1HRZ. A pair of 45's was used in the transmitter with a super for reception. He also reported that W9UAQ, LBP, AI, SQE and LWI grabbed off some of the DX for themselves.

Kansas City, Mo.

George K. Shirling, W9AHZ, who hears 7- to 8-meter DX police signals quite frequently logged on this occasion W2AMJ, W3EUY and heard a host of others operating too snappily to be identified.

Chicago, Ill.

George R. Svoboda, W9UOV, as late as 11:45 p.m. E.S.T. worked W3AMW, W3AYG and heard W3FHJ, W3NU, W3EPN, W2CLB, W2HWC, W1ZE, W1FHN, W1HRZ, W1EER. He reports that many of the signals were R7 to 9. His transmitter—15 watts input.

Park Ridge, Ill.

A. H. Knodell, W9TLQ, worked W1EYM. He heard W3EO, W3EHU, W2AMJ, W1JLK, W1DSV, W2JCY, W2HEJ, W3FJW, W2GKD, W2VE, W2CLD, W1IYX, W3NU, W2INJ and W1ZE. He reported extremely rapid fading at times with frequent examples of selective fading.

Portland, Conn.

Rev. Hollis M. French, W1JLK, poked his signals into Chicago but failed to make a contact.

(Continued on page 84)

Simplifying the Push-Pull-Push Crystal Oscillator

An Effective Single-Stage Transmitter Working Two Bands With One Crystal

By J. Stanley Brown,* W3EHE

TNX OM for ur FB report—rig here is two 802's and 1 xtal push pull grids and doubling output—input abt 50 watts."

And thereby hangs a tale: There is an experimental transmitter here that consists of just the above-mentioned equipment and one 600-volt power supply. It produces 30 to 40 watts of measured output on each of two bands with either

been stepping out nicely on 20 meters. All reports have been T9X and R6 to 8 which, considering that no real DX has ever been worked from this station, is rather unusual performance. The old final with a pair of 10's taking 150 watts or so has been removed from the rack to make room for this versatile little rig.

The material to follow is an elaboration and refinement of that presented in May 1935 *QST*¹ to which article the reader is referred, plus numerous tests and experiments conducted here since that date. Probably 50 or more push-pull crystal and electron-coupled oscillator circuits for both fundamental and second-harmonic output have been set up and evaluated. The findings are of quite some interest and so numerous that the whole subject is best dealt with in two articles. This work is far from complete, but it is hoped that it will inspire brother hams to take up the idea and do something with it.

A SIMPLE TRANSMITTER

The fundamental circuit arrangements are shown schematically in Fig. 1. The diagram of the actual transmitter in use at W3EHE is given in Fig. 2. Circuit constants except as marked in Fig. 2 are not at all critical. Analysis of the circuit will bring out the fact that the screens and suppressors are tied together and serve as the plates for a push-pull triode oscillator. In the same glass bulbs we have all the elements of a push-pull or push-push tetrode amplifier. Notice that we do not mention these tetrodes as harmonic amplifiers because they are not being used as such. They operate much as a following r.f. amplifier would except that electron coupling is used instead of capacitances or links. It should be mentioned at this point that if output at the crystal fundamental is desired, $C_1 L_1$ may be shorted out and some feed-back provided between the plates and control grids in the form of 3- μ fd. (max.) variable condensers good for six or seven hundred volts. The circuit will then operate as any push-pull screen-grid oscillator would.

Normal operation is with output at twice crystal frequency, under which condition there is no interlocking of the two tuned circuits. This doubling operation requires that the plates be connected in parallel. Many people believe that this is just another way of tuning to the second harmonic and therefore bound to be less efficient

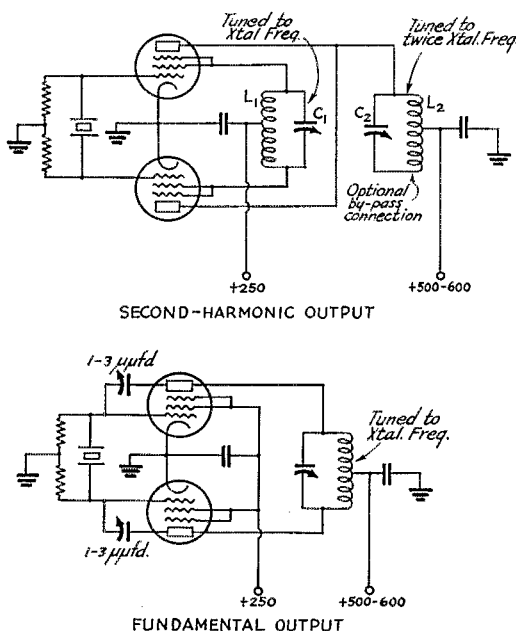

FIG. 1—CIRCUIT ESSENTIALS FOR BOTH FUNDAMENTAL AND SECOND-HARMONIC OUTPUT

a 160- or 80-meter crystal, and about 25 watts on 40 and 20 with a 40-meter crystal. Fifty watts can be obtained if you wish to run your 802's at 700 volts (RCA did not suggest this voltage). This circuit has been successfully suppressor-grid modulated as a 10-watt 'phone, on 160 and 80 meters. It has worked all U. S. districts on 40-meter code and, since means were recently found to get some output from a 40-meter crystal, it has

* 3039 Macomb St., N. W., Washington, D. C.

¹ Brown, "Push-Pull-Push Oscillator Circuits for 15-watt Second-Harmonic Output," *QST*, May, 1935.

than fundamental operation. This is not the case, for under high bias conditions it is theoretically possible to get just as much plate efficiency with a push-push connection as with push-pull; assuming, of course, the same output frequency. Results here, for instance, have been in one case 40 watts of 80-meter output from an 80-meter crystal, and over 35 watts of 40-meter output

lation at the crystal frequency. The tank, because of its fly-wheel effect, irons out any inequalities of impulse excitation and produces a practically pure sine wave.

Now, if we connect the plate tank push-push, both plates are in parallel and the two plate-current pulses occur alternately but in the same phase. Inasmuch as nothing in the driver has been

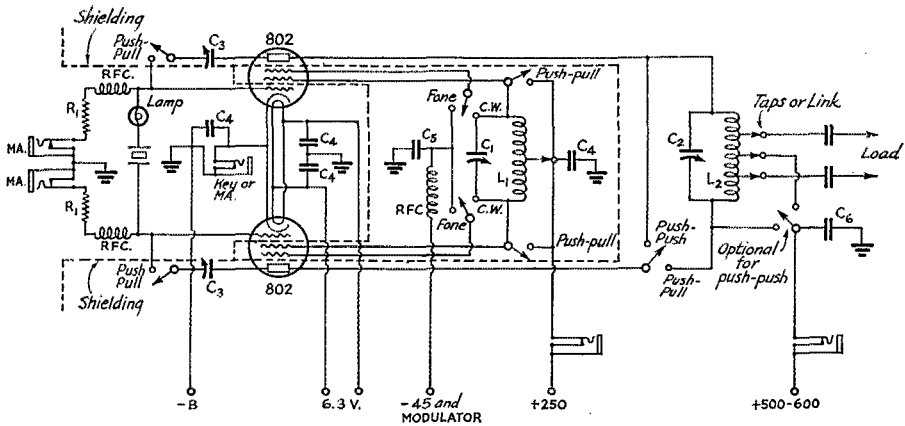

FIG. 2—CIRCUIT DIAGRAM OF THE TRANSMITTER

C₁—75 μ fd. Hammarlund "Midline" single spaced.
 C₂—33-33 μ fd. Hammarlund "Midline" double spaced (sections parallel).
 C₃—1-3 μ fd. double-spaced.

C₄—0.005 or larger, mica.
 C₅—0.002 mica.
 C₆—0.005 or larger, mica, 1000-volt working.
 Lamp—6.3-volt dial light.
 M.A.—Jacks, closed circuit, for mil-

liameters (Milliammeters should be bypassed).
 RFC—National type R-100 R.F. choke.
 Switches—Optional, links or other means suitable.
 Coil Data given in Table II.

from the same crystal with approximately identical bias and loading of tubes. Plate efficiency of 75% has been obtained while doubling.

Fig. 3 is analogous to the respective operation of push-pull and push-push amplifiers. Perhaps a word or two can explain the statement that for a given bias, it is theoretically possible for them to be equally efficient: Fig. 2 shows the plate current flow when an 80-meter crystal is exciting the circuit of Fig. 1. The grid bias is assumed to be twice cut-off or more. Under this bias condition the excitation voltage on the grids causes plate current pulses to flow during only a portion of the r.f. excitation cycle. If the circuit is wired push-pull these pulses have a phase difference of 180° and "kick" the tank into oscil-

lating, these pulses represent as much energy for the same duration (kilowatt hours if you wish) as they did before the plates were paralleled. All we have to do now is tune the plate tank to twice the crystal frequency and we should and do get just about the same output that we did at crystal frequency. Those who have had trouble with the 1935 circuit,¹ and there were several, may be assured that this newer circuit is vastly more simple to operate. It has none of the trickiness caused by the inductive coupling to the crystal and none of its predecessor's tendency towards self-oscillation.

Some of the operating conditions noted are given in Table I. These are reasonably accurate observations and should serve as a fair guide to

TABLE I

OUTPUTS AND CONDITIONS OF OPERATION

Plate voltage 600; d.c. grid current 4-6 ma. total; screen-suppressor voltage key down, 225 to 250; screen-suppressor current 25-35 ma.; cathode current 120 ma. max.; plate current 92 ma. max.

Crystal Freq.	Output Freq.	Output Watts	Operation of Plates	Approx. Plate Input	Approx. Plate Eff.	Crystal R.F. Current, ma.
1963	1963	40	push-pull	55 watts	73-75%	Less than 35
1963	3926	35-40	push-push	" "	65-73%	" " "
3504	3504	40	push-pull	" "	73-75%	35
3504	7008	35-40	push-push	" "	65-73%	35
7137	7137	—	push-pull	No notes made of this		60-80
7137	14,274	25	push-push	40 watts	63%	60-80

performance. Outputs were determined by lamp comparisons, and crystal r.f. currents were adjusted by tuning L_1C_1 to about the values shown.

For 'phone operation it is necessary to bring the suppressor connection out separately, as shown in Fig. 2. The suppressors should be bypassed for r.f. with an 0.002- μ d. mica condenser, with further r.f. filtering through a small choke such as the National R-100. Adjustment for 'phone has been described in *QST* numerous times and is, briefly as follows: Adjust for maxi-

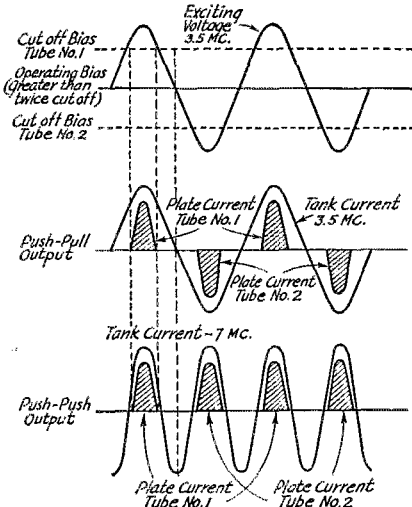

FIG. 3—SHOWING TUBE OPERATION WITH PUSH-PULL AND PUSH-PUSH OUTPUT CONNECTIONS

mum r.f. output with the suppressor at 45 volts positive, then cut the bias to a negative value that brings the antenna current to one-half its maximum value, leaving all other adjustments unchanged. In this circuit the correct value is between 40 and 45 volts negative; 45 was used.

In spite of the fact that the screens are above ground for r.f. when doubling, a check for linearity showed up reasonably well, although the range of the test only covered "upward" modulation. The modulator used was a pair of 45's driven by a triode-connected 57. Listeners reported the transmitted quality as excellent and I believe the circuit would make a very good portable 'phone.' Phone has not been tried yet on 20 meters because of the difficulty of getting much 'phone carrier output from a 40-meter crystal.

The rig here is still of test board construction, but there are some constructional points that the experiments have suggested, and an attempt is

TABLE II

COIL DATA

Coil forms 2" outside diameter and 2½" winding length. Each coil to be trimmed to operate in plate circuit push-pull or push-push and in the screen circuit push-pull.

Coils Band	Assumed Capacity in Circuit	Total Turns
A 1715	75 maximum	62 of #20 d.c.c. close wound
B 3500	75 "	30 of #18 enamel double spaced
C 7300	40 minimum	20 of #14 enamel " "
D 14,400	30 "	12 of #14 " spaced out
E 30,000	30 "	6 of #14 " " "

The number of turns on coils D and E may be increased somewhat if the sections of tank condenser C_1 are connected in series for 20 and 10 meter operation. This will give lower minimum C.

made to show them in Fig. 4. The control grids especially should be isolated from any plate circuit feed-back because failure to do this may result in a very rough note and even poor keying. The screen tank should be shielded from the plate tank, especially if it is allowed to run on fundamental when the plate tank is also on fundamental (to avoid the use of plate-grid feedback condensers). In making the coils it is believed that it would be better to avoid the standard receiving type plug-ins used here in favor of something about 2 inches in diameter by 3 inches long with side jacks instead of end prongs. It is almost impossible to find the electrical center on a coil connected to end prongs. Symmetry of leads and parts is also quite essential in the circuit. Lack of such care made a lot of trouble here until corrected. Fig. 4 is a longitudinal elevation of the suggested arrangement of parts. The vertical shield is almost a necessity and the other shielding is advisable. Any somewhat similar arrangement that gives short leads should be a good substitute.

If one desires, the suppressors may be disconnected from L_1C_1 and run 45 volts positive for

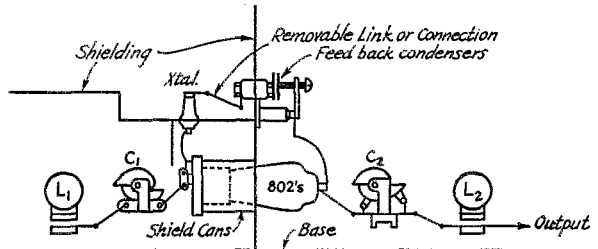

FIG. 4—SUGGESTED PHYSICAL LAYOUT FOR TRANSMITTER COMPONENTS TO AVOID FEEDBACK

code operation, but there will be an attendant reduction in output of 20 to 25%.

The coils, specifications for which are given in Table II, should be progressively interchangeable so that each can be used at its designed frequency

(Continued on page 84)

A 500-Watt Transmitter With Band-Switching Exciter

Using 805's in the Final—Complete Transmitter Works From Single Power Supply

By Clark C. Rodimon,* W1SZ

MOST of the transmitters built at HQ are tested rigidly and after being put through their paces they get into *QST* just about time to go to press. The transmitter to be described was built several months ago in anticipation of the annual DX contest. Since that time the transmitter has been given plenty of "air test" on all bands it was designed to cover, 'phone and c.w. The original idea was a compact transmitter primarily for c.w. work which could be run efficiently at inputs around 800 watts (exceeding ratings a bit) and still use medium voltage tubes. Band-switching had been planned in all stages. Time and thought did not produce a practical band-switching arrangement for the push-pull final amplifier so this stage turned out to be plug-in.

UNIT CONSTRUCTION

The complete job consists of three different units, "build-up-able" one at a time as the pocket book allows. This is in keeping with the trend of the times. The first unit consists of a pentode crystal oscillator and pentode buffer-doubler. This unit makes a complete transmitter of moderate proportions as may be seen in Table I. The second unit consists of a push-pull amplifier giving a power output gain of about 7. The third unit contains a pi-section antenna coupler.

One can build up as many more of these units as desired. The separate cabinets fit one above the other in a sturdy fashion and give the impression of a complete rig rather than a collection of units. These particular cabinets were procured from the Radio Communications Equipment Co. of Maywood, Ill. For a complete transmitter two more units would suffice, one for audio equipment and the other for power-supply gear.

* Managing Editor.

LOW-POWER STAGE

A glance at the photograph of the low-power unit will show a mass of coils, condensers and crystals. Actually, much time and thought was given to this primary layout. It consists of a 42 crystal oscillator with plug-in crystals and crystal switching; RK20 or 804 buffer-doubler-amplifier (depending on its use at the time). The plate coil of the 42 is tapped for 80-, 40- and 20-meter band-switching (always working on the same frequency as the crystal). Variable coupling to the grid of the 804 or RK20 is obtained by the use of a variable condenser. The aluminum "doghouse," shielding the grid end of the amplifier, was found to be essential to eliminate reac-

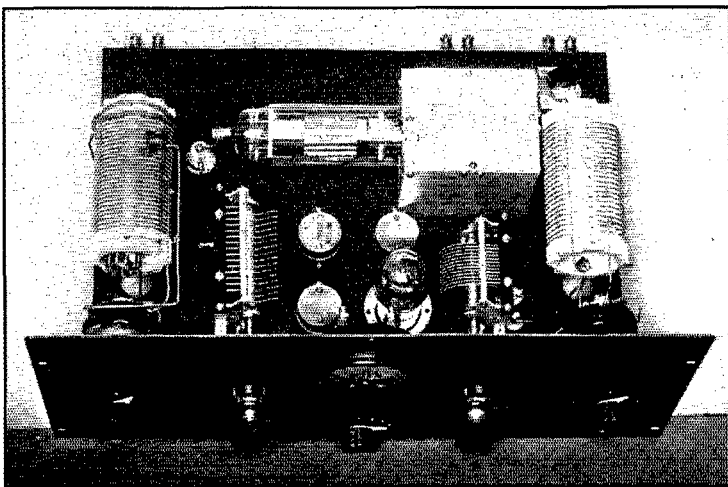

LOW-POWER OR EXCITER STAGE

As explained this unit could well be used as a low-power transmitter in its own right. See Unit 1 of Table I. The layout is described in the article.

tion between the two stages. Nothing but complete shielding would produce reaction-free results. The shielding extends to the metal shield within the tube with at least $\frac{1}{16}$ " clearance between the external shield and glass, as recommended by the manufacturers.

The plate coil of the pentode amplifier is tapped for band switching, allowing operation on 80, 40, 20 and 10 meters with the use of proper crystals. This arrangement permits doubling from any one crystal frequency. Originally the 804-RK20 stage

had been planned as a high-power Tri-tet oscillator, but the additional low-power pentode crystal oscillator was adopted as giving better over-all efficiency. With the dependable 20-meter crystals now available, the ten-meter band can be covered with plenty of excitation on the final stage at all times. There are 3 sockets for plug-in crystals—and front-of-panel selection of these gives a sufficient range of frequency change.

The Ohmite band switches are mounted on brackets which in turn are insulated from the base by bakelite spacers. The variable grid-

is sufficient for all bands. If there was no amplifier following this stage, the output would go to an external antenna coupler. The coil forms are mounted on 2-inch stand-off insulators. (See the circuit diagram of this unit for reference to the terminal strip at the rear of the chassis.)

In operation this unit is very stable and fool-proof for both c.w. and 'phone work. If 'phone is desired with this unit as a low-power transmitter, suppressor-grid modulation of the pentode amplifier is very practical. When the time comes for addition of the push-pull amplifier, without more 'phone equipment being necessary, a very convenient method is to continue to suppress-modulate the pentode amplifier and use the final amplifier as a linear. Proper loading of the driver stage is secured by a non-inductive resistor which is tapped across the proper amount of the driver plate coil, as described in the adjustment procedure for linear amplifiers given on pages 97 and 216 of the 1936 A.R.R.L. Handbook.

The network of combination bleeder-voltage-divider for the high-voltage power supply is mounted underside on the low-power deck. Fig. 1 shows the complete wiring. The crystal selector switch is also underside, as well as plate and grid chokes and all by-pass condensers.

Power supplies necessary for this first unit are: 7.5-volt for the 804-RK20 and 42 (via a 2-ohm dropping resistor for the latter); 1250-volt or 1500-volt plate supply depending on whether

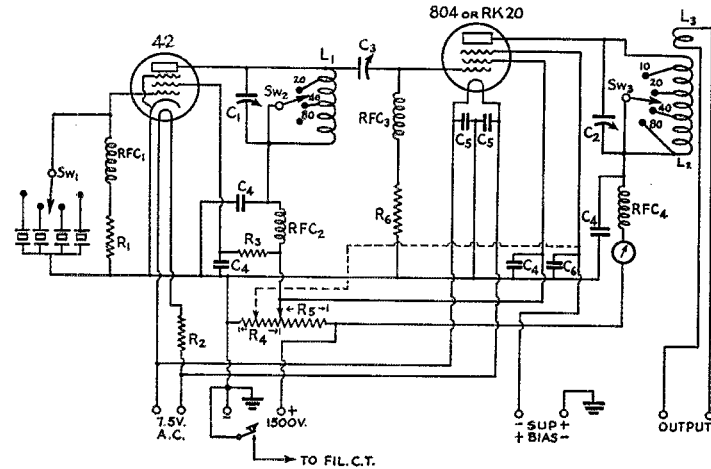

FIG. 1—CIRCUIT OF EXCITER STAGES

- SW₁—Six-point selector switch.
- SW₂, SW₃—Heavy duty switches for band selection (Ohmite).
- RFC₁—RFC₄—Regular 2½-uh. choke (National R100).
- C₁—260-µfd. variable, 0.031" air gap (Cardwell MR-260-BS).
- C₂—150-µfd. variable, 0.070" air gap (Cardwell MT-150-GS).
- C₃—100-µfd. variable midget, 0.020" air gap (Cardwell ZU-100-AS).
- C₄—0.002-µfd. by-pass condensers, 1500-volt rating.
- C₅—0.002-µfd. by-pass condensers, receiving variety.
- C₆—0.0005-µfd. by-pass condenser, 1000-volt rating.
- R₁—10,000-ohm, 5-watt resistor.
- R₂—2-ohm, 10-watt.
- R₃—15,000-ohm, 5-watt resistor.
- R₄—25,000-ohms, 50-watt Dividohm tapped 3000-ohms for positive suppressor voltage if not taken externally.
- R₅—15,000-ohms, 100-watt.
- R₆—15,000-ohm, 5-watt resistor. See text and coil table for coil data.

coupling condenser to the RK20-804 is mounted on the rear of the pentode "doghouse," insulated by the special mounting bracket supplied.

TABLE I

Unit I with the RK20 or 804 as the final.	70 watts output c.w.
18 " " 'phone (Supp. mod.)	
Unit II as a final amplifier with 805's.	500 watts output c.w.
110 " " 'phone (linear amp. or grid mod.)	
300 " " 'phone (plate mod. final)	

Link coupling from the pentode stage goes to a pair of terminals at the rear of the chassis. The link input is a permanent 2-turn coil with connections to a pair of GR terminal strips (274-Y), which brings the r.f. below the chassis. Thence it goes directly to the rear of the chassis through another pair of GR terminal strips. This coupling

one contemplates the 838 or other tubes in the same category, or the 805 which has the 1500-volt plate rating with 125-watt plate dissipation. In any case, it will be wise to look into future possibilities here because the same plate supply is used on the initial unit as used in the high-power amplifier by the use of voltage dividers as shown in the circuit diagram.

HIGH-POWER FINAL AMPLIFIER

insulation in the amplifier and a huge plate tuning condenser would not be necessary. As seen in the photo of this stage everything is pretty well in its place with room to breathe between *C* and *L* in the tank circuits. Nonetheless, it is interesting that the final amplifier has been Class-B plate modulated with 1500 volts on the 805's on both 14 and 3.9 mc. (500 watts input) with only rare flashovers on over-modulation peaks. (Insulation of the plate tuning condenser from ground and the use of an r.f. by-pass completely eliminated that!) The carrier was of the order of 300 watts. The Class-B modulator used zero-bias 838's running off the same power supply. As mentioned above, this treatment was not intended when original plans were drawn up but when the going got tough it was decided to try to boost up the power a bit to "see what would happen." The amplifier took to this treatment without a whimper and is in daily use in this fashion. Insulating the rotor completely cured the flashovers. The tubes used were 805's but the following were substituted with equal success when the tubes were run at rating: 838's, 211's and 203A's.

From left to right in the photo of the final amplifier may be seen the grid coil with link around it. The GR plug-and-base arrangement provides outlets for seven connections to the coil—only five are needed. The grid tuning condenser is next and is mounted by brackets direct to the chassis. The neutralizing condensers are insulated from the chassis by mounting on feed-throughs. A high-voltage shaft coupling connects the condensers for single drive. Next come the 50-watt National XM sockets which are sub-base mounted—only the metal shells (which are grounded) appear above the top of the chassis. Then the plate tuning condenser and coil complete the layout above the chassis. Four insulating bushings are used to carry the grid and plate r.f. connections under the chassis to the socket terminals. The criss-cross wiring of the neutralizing condensers is done above the chassis. The plate tuning condenser is mounted on brackets directly to the chassis. This grounds the rotor of the condenser, which means that a flashover will short the power supply. If 'phone work is contemplated it is suggested that the condenser be insulated from the base by mounting the brackets on insulator feed-throughs and grounding via an r.f. by-pass as previously mentioned. There is no photo of the gear underneath the chassis. This is hardly necessary for the only components there

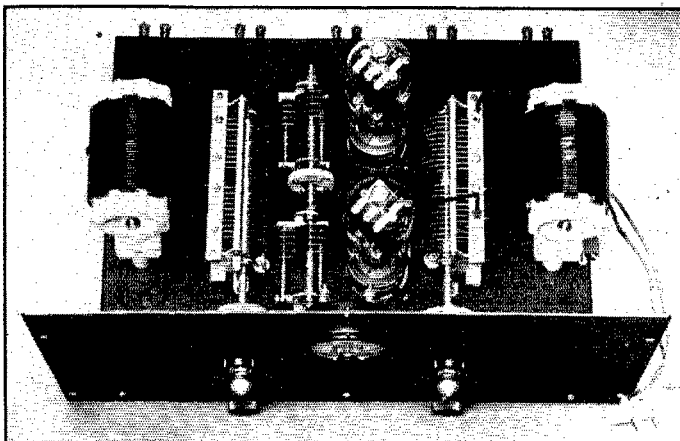

FINAL AMPLIFIER WITH 3.5-MC. COILS

See text for layout. At the extreme right may be seen the output link that goes to the antenna coupler.

are plate and grid chokes, grid resistor and filament by-pass condensers. The terminals at the rear are GR pairs Type 274-Y. From left to right (referring to photo of final) these pairs are as follows: Link circuit; grid circuit for zero or external bias; grid circuit for resistor or resistor-battery bias; filament, and finally, plate connections. Two pair of connections in the grid circuit will not be amiss. They are clearly shown in the circuit diagram. This gives one a variety of combinations, depending on the tubes to be used, whether one is using c.w., Class-B linear or Class-C plate modulated radiotelephony. Resistor bias is recommended for the last inasmuch as grid currents run quite high.

Both the grid and plate circuits are tuned by Cardwell Midway Type MD-100-GD condensers with Micalex insulation. Space limitations and the necessity for a high-voltage low-capacity variable neutralizing condenser started us looking all over for what we needed. Not finding the exact capacity requirement to fit the space available we used the nearest thing which was a Bud type 566 which had high-voltage insulation. It was necessary to remove 3 rotor and 3 stator plates in each of the condensers to reduce the minimum capacity to allow neutralization of the 805's. This operation was accomplished with a hot soldering iron. These condensers are ganged by a high-voltage coupling.

Referring to the photograph of the final amplifier, the pair of leads carrying r.f. to the antenna coupler is shown at the right. These leads connect to the antenna coupler by a pair of GR plugs mounted in a piece of Micalex. This was found quite necessary after burning up bakelite mountings. The r.f. potential of the entire final amplifier is on these two leads, so it can readily be seen that excellent insulation will be necessary. This unit, as are the rest, is complete in itself. Power supply

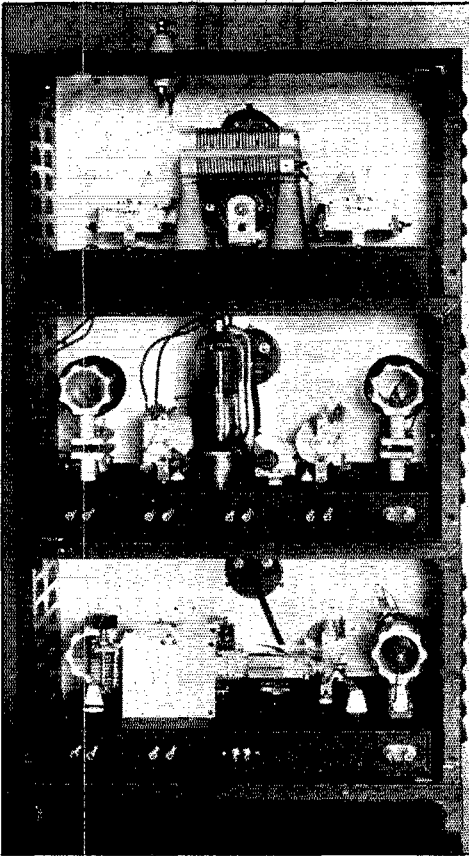

REAR OF TRANSMITTER UNITS IN PLACE

Without the supply cables attached each unit can be removed with ease as there are no permanent connections between any of the units.

and r.f. leads attach at the rear to GR Type 138-VD binding posts insulator-mounted in pairs. Power supply leads come up the rear of the transmitter in cable form. To pull out the unit, it is only necessary to disconnect the leads at the rear and the entire unit is free to slide out of its cabinet. It will be noted that there is a single meter in each unit, without plugs and jacks for placing in different circuits. As mentioned before, simplicity was the keynote and the meters in their present circuits are sufficient to tune the transmitter. It is a fact that a grid meter in the final amplifier would be helpful and probably essential to initial checking and tuning up.

ANTENNA COUPLER

To cover a wide range of frequencies with efficient coupling into various feed lines, it was decided to construct the pi-section antenna coupler with coil shorting to match impedance variations on different frequencies. Split-stator con-

densers are used in both the input and output positions. Combining a fairly large amount of capacity with a fairly high r.f. voltage rating called for condensers that at first look out of place with the rest of the rig. Playing around with full output showed that the voltage ratings of these condensers was not entirely out of line. Two Ohmite switches are ganged by means of a National flexible shaft coupling. These switches should not be turned when the rig is in operation, for the r.f. potential may damage the switch when the circuits are opened. Since the switches are only rated for low voltage, they are insulated from the base by brackets and Steatite feed-throughs. The tuning condensers are not insulated from the base. Getting r.f. from the final amplifier to the antenna coupler turned out to be a bit of a special job when making this connection direct. Underneath the base of the antenna is mounted a GR jack (274-AJ) to accommodate the plug from the final amplifier. It was necessary to fashion a hole about 2 inches long and 1 inch

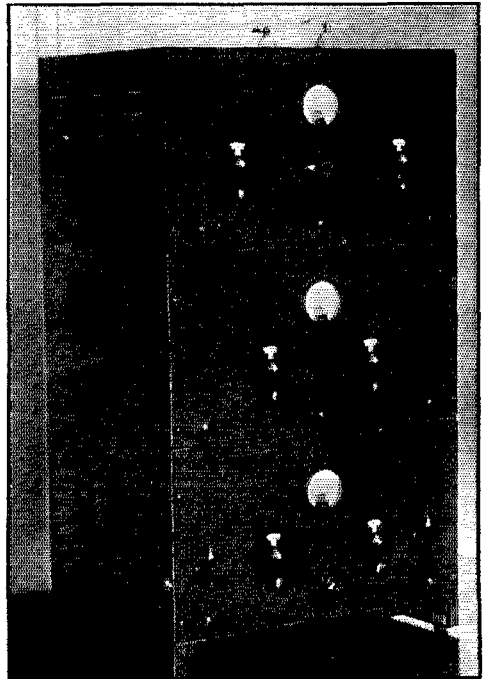

FRONT VIEW OF COMPLETE R.F. UNITS FOR 500-WATT TRANSMITTER

Three separate metal units fit together for forming unit construction.

wide through the top of the final amplifier cabinet to get the jack through to the plug permanently attached to the underside of the antenna coupler. These r.f. leads are fed through the base of the coupler by a pair of Steatite feed-throughs. An

antenna meter is permanently connected in one side of the coupler circuit. National h.f. bushings come out of the top of the coupler and serve as mountings for the feeders.

To keep a symmetrical layout and keep the two antenna coils separated, it was necessary to mount them above the shorting switches. The coils are mounted on 6-inch stand-offs. The input and output condensers may be mounted directly to the chassis, since the rotors are grounded.

KEYING

This transmitter may be keyed in several ways. One may key the suppressor of the buffer, center-tap of the buffer, center-tap of the final or both center-taps. The set-up as used keyed the center-tap of the final amplifier. Slight clicks resulted and were eliminated with a small key-click filter (Fig. 100g, '36 A.R.R.L. Handbook) in the keying leads. This was dead simple.

MISCELLANEOUS

Dials that would be compact and allow one to jot down dial settings were decided upon. The ones shown are National type BM. GR knobs and pointers were used for the switches. Various switch positions were engraved on the panels by the simple means of a prick-punch mark and some white paint. Coils in the low-power and antenna coupler stages are National. Those in the final amplifier are GR type 677-U. These were chosen because it was possible to get positive plug and jack bases for this type of coil. It is well to take precautions here for a poor contact will result in many watts being lost in heat. The r.f. lost in the plug and jack assembly of these coils was not enough to heat them, though there was heating in the coils. When the two r.f. units were finished the final amplifier was mounted above the low-power unit. Then two power cables were made, one for each unit. Packard cable was used for all leads. Each cable was made by wrapping 1/2-inch cotton strip in a spiral after binding with cord to completely cover the several wires in the one cable. Then orange shellac was applied which resulted in a semi-flexible cable that was very sturdy. At the set end of the cable each lead is cut just long enough to reach its proper terminal. Then the power connections are made. At any time a unit is to be worked on it is merely a matter of loosening all binding posts and pulling the unit out from the front. One need not worry about proper power leads going to proper terminals, for they are all cut to the proper length and one cannot make a mistake. The cables may be connected permanently to the power supplies for they need not be removed.

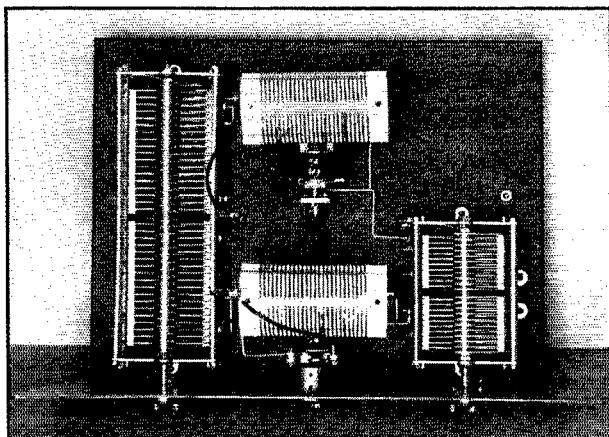

LAYOUT OF ANTENNA COUPLER

Apparatus from left to right is: output condenser, for setting proper load; coils are in the center for each leg of the system, mounted on tall Steatite pillars above the band switches; input condenser for tuning to resonance; Steatite feed-throughs bringing r.f. from the final may be seen as two white buttons.

TUNING UP

With the rig assembled and coils wound the time to try it out is at hand. Let's tune it up for 7-mc. operation. The low-power stage is first put into operation. Either an 80- or 40-meter crystal may be used. One always has a choice of a crystal working on its fundamental frequency or doubling. The plate coils of both stages of the low-power unit are set for 40 meters (if 40-meter crystal—if 80, the oscillator switch is set for 80 meters). When the crystal frequency is reached by the tuning condenser there will be a kick in plate current (probably up, as the following stage will be out of resonance). The meter will read around 130 mils with 1250 volts on the plate and positive suppressor bias. The amplifier plate circuit should be tuned to resonance immediately to avoid the out-of-resonance high plate current. With the amplifier unloaded and tuned to resonance the plate current will be around 40 ma. The single meter in the plate circuit of the amplifier was found to be adequate.

It is now time to complete the link circuit to the final amplifier by means of a pair of leads run between the two sets of binding posts at the rear of the units. The 40-meter grid coil is put in the final amplifier. Plate voltage should not be put on the final amplifier yet. For preliminary tuning up a grid meter is inserted in the place of the shorting bar A in Fig. 2. When the grid current is at maximum the amplifier must be neutralized. The neutralizing is done in the well-known manner, with the plate coil in place but without the link attached that goes to the antenna coupler. During this process the grid circuit paths at A and B are closed. The grid current flowing through the grid resistor will be about 200 ma. but will fall to about 120 ma. when the plate

voltage is applied and the antenna circuits are in tune. Before plate voltage is applied one should experiment with the variable coupling condenser to the buffer amplifier for maximum grid current to the final. Too much excitation will lessen the output as has been explained before regarding pentodes. In practice this condenser, C_3 in Fig.

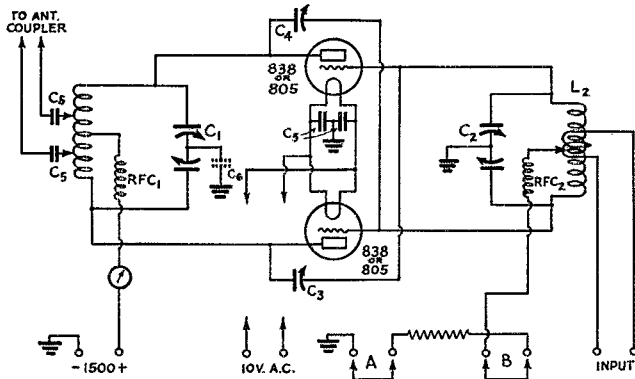

FIG. 2—CIRCUIT OF FINAL AMPLIFIER

C_1 —100 μ fd. in each section, 0.07" air gap. See text.
 C_2 —100 μ fd. in each section, 0.07" air gap. See text.
 C_3, C_4 —Variable neutralizing condensers ganged. See text.
 C_5 (Output coupling)—1500-volt, 0.01 μ fd. by-pass.
 C_5 (Fil. by-pass)—0.002 μ fd. by-pass.
 C_6 —1500-volt, 0.01 by-pass. See text.
 A, B—See text. Connecting resistor is 1500 ohms, 100 watts.
 RFC₁—Receiving type layer-wound choke.
 RFC₂—Ohmite Type Z-4.
 See text for coil dimensions.

1, was found to be optimum at $\frac{3}{4}$ capacity on all bands. The link circuits, L_3 in Fig. 1 and L_2 in Fig. 2, should be varied for maximum excitation to the final stage. Two turns were found adequate on all bands for L_3 . Note the coil table for the data on L_2 .

Now it is time to apply the high voltage to the final. During the first tuning up it is recommended to use about 800 volts rather than the normal 1250. With the plate coil in place resonance should be found without coupling to the antenna coupler. Still using the lowered voltage, connect the pi-section network and connect the antenna to the terminals.

Tuning the antenna coupler is a paper in itself if one were to attempt to cover all the different feeder systems and possible combinations one might run into. For the two systems in use at W1SZ, it was found a simple matter to match the feeder to the network. The shorting switch was set on the middle position, which meant that half of each coil was being used. The output condenser of the network was set for minimum coupling and resonance was found by tuning the input condenser. Then the output condenser was varied, increasing the coupling until the proper load on the final amplifier was reached, always returning the input condenser to resonance whenever the output condenser was varied. During this process the final plate tuning condenser should not be touched. Its setting should be the same as it was when resonance was found without the coupling plug in place.

The above procedure is sketchy at best but it actually is much less complicated than it is to describe. For Class-C 'phone operation (Class-B modulation of the final) the tuning is identical to that described above. It will be necessary to use fixed bias on the final instead of leak bias for Class-B linear or grid-bias modulated operation. If this is done, the shorting plug at B (Fig. 2) is removed and the rated negative bias is connected to the left hand plug of this pair. The positive, of course, is grounded, or connected in series with the grid meter at A if the current is to be measured.

If the load is proper for the modulator, all meters should remain still even under 100-percent modulation, save the antenna meter which should flicker upward. A neon-stick modulation indicator¹ is used with excellent results. Enough r.f.

¹ Visual Modulation Indicator, Campbell, this issue.

(Continued on page 80)

TABLE II

	OSCILLATOR L_1 has shorting sv. for band selection (No. of turns)	AMPLIFIER-DOUBLER L_2 has shorting switch for band selection. Link fixed at "hot" end of coil*	FINAL			ANTENNA COUPLER No. of turns in each coil—shorting switch for band selection	
			L_1	No. of turns each side of center tapped for antenna coupler	L_2		L_2 link
3.5-4 mc.	26	26	32†	14	36	2	26
7.0 mc.	12 turns free	16 turns free	14	4	18	3	14 turns free
14 mc.	5 turns free	6 turns free	6	Not tapped. Use a 3-turn link around center of coil	7	2	6 turns free

* L_3 on diagram, Fig. 1.

† It was necessary to get a greater diameter to the coil to hit 3.5 mc. To accomplish this the grooves were filled with $\frac{1}{4}$ " bakelite spacers the length of the coil and $\frac{1}{8}$ " wide around entire coilform. No. 12 enamelled wire wound close filled the coil. All other coils were wound with No. 12 solid tinned copper wire.

What the League Is Doing

League Activities, Washington Notes, Board Actions—For Your Information

Election Notice

To all members of the American Radio Relay League residing in the Atlantic and New England Divisions:

You are hereby notified that, in accordance with the constitution, an election is about to be held in each of the above-mentioned divisions to elect a member of the A.R.R.L. Board of Directors, the recent directors thereof having been elected president and vice-president, respectively, of the League and consequently resigning their offices as division directors, as required by By-Law 22. In the case of the Atlantic Division the election is to choose a director for the remainder of the 1936-1937 term. In the case of the New England Division, the election is to choose a director for the remainder of the 1935-1936 term. Your attention is invited to Sec. 1 of Article IV of the constitution, providing for the government of A.R.R.L. by the Board of Directors; Sec. 2 of Article IV, defining their eligibility; By-Laws 11 to 22, providing for the nomination and election of division directors. Copy of the constitution and by-laws will be mailed any member upon request.

Voting will take place between July 6, 1936, and August 3, 1936, on ballots which will be mailed from the headquarters office in the first week of July.

Nomination is by petition. Nominating petitions are hereby solicited. Ten or more A.R.R.L. members residing in either of the above-named divisions have the right to nominate any member thereof as a candidate for director therefrom. The following form is suggested:

(Place and date)

*Executive Committee
The American Radio Relay League, Inc.
West Hartford, Conn.*

Gentlemen:

We, the undersigned members of the A.R.R.L. residing in the Division, hereby nominate, of, as a candidate for director from this division for the unexpired remainder of the current term.

(Signatures and addresses)

The signers must be League members in good standing. The nominee must be a League member in good standing and must be without commercial radio connections: he may not be commercially engaged in the manufacture, selling or renting of radio apparatus or literature. His com-

plete name and address should be given. All such petitions must be filed at the headquarters office of the League in West Hartford, Conn., by noon of the 6th day of July, 1936. There is no limit to the number of petitions that may be filed, but no member may append his signature to more than one such petition. To be valid, each petition must have the signatures of at least ten members in good standing.

These elections provide the constitutional opportunity for members to put the direction of their association in the hands of representatives of their own choosing. Members are urged to take the initiative and file nominating petitions immediately.

For the Board of Directors:

K. B. WARNER,
Secretary.

May 11, 1936.

Requests of F.C.C.

The several requests of the F.C.C. made by the A.R.R.L. Board of Directors, notably to widen the 4-mc. 'phone assignment and to increase the examination code speed, have duly been transmitted to the Commission. They are under study in the Engineering Department there but at this writing there has been no action and there is no news.

June Hearings

The major item in the life of A.R.R.L. headquarters, as this issue of *QST* is being written, is our preparation for the informal hearings of the F.C.C. which begin on June 15th. The seven commissioners, sitting *en banc*, will hear the status of the entire radio art in America reported in a series of meetings estimated to last a month and expected to fill a large auditorium in Washington. Primarily these hearings are the long-deferred conference on ultra-high-frequency allocations above 30 megacycles, the future needs of services that are to occupy that portion of the spectrum, their relative importance, etc. It also embraces a review of the allocations below 30 megacycles for the purpose of informing the commissioners on the present state of the art and as a useful background for Cairo preparation. The League representation at these hearings is in the charge of General Counsel Segal and Secretary Warner but the actual presentation will make use of the services of several other members of the headquarters staff as witnesses. At this writing a half-

dozen members of our group are industriously at work writing up the amateur case. We shall explain our present frequencies and the use to which we put them, demonstrate that the national policy of encouraging amateurs in this country has been exceedingly wise and productive of good results in the national welfare, we shall show our need for more normal frequencies and the desirability of assigning us additional bands of frequencies in the ultra-high-frequency region. However, it is important to note that these hearings are not going to allocate frequencies. Indeed it is doubtful if any report will issue from them. In the autumn there likely will be another hearing on a tentative regulation actually allocating frequencies to u.h.f. services, while the matter of the lower-frequency bands will be a subject for the United States committees preparing for the Cairo conference. The preparatory committee dealing with allocations will not hold its first meeting until after these June hearings. The HQ gang is buried to the ears at this writing, getting up charts and arguments. We hope our correspondence won't suffer delays, but if it does you'll know it has been in good cause. We should be back to normal by middle July.

Calls On page 15 of June *QST* there appeared a "Stray" suggesting that when you keep schedules at a borrowed station while away from home traveling or visiting, it would help if you had your own crystal with you, thus automatically putting you on the frequency known to your correspondent. We would like to emphasize that on such occasions it is imperative to sign the call of the station you are using, not the call of your home station. This is important: a station is a station, and each is identified by its own call. Several of the brethren have got into serious trouble over this little matter. Your own call is to be signed only on your own gear.

Financial Statement The League enjoyed an excellent first quarter's business. By instructions of the Board of Directors, the operating statement is here published for the information of the membership.

STATEMENT OF REVENUES AND EXPENSES,
EXCLUSIVE OF EXPENDITURES CHARGED
TO APPROPRIATIONS, FOR THE THREE
MONTHS ENDED MARCH 31, 1936

REVENUES	
Membership dues	\$14,452.84
Advertising sales, <i>QST</i>	21,025.48
Advertising sales, Handbook	3,187.05
Newsdealer sales, <i>QST</i>	12,708.84
Handbook sales	17,140.31
Booklet sales	2,962.90
Calculator sales	1,001.01
Membership supplies sales	2,928.87
Interest earned	768.70
Cash discounts received	411.19
Bad debts recovered	213.55
	\$76,800.74

<i>Deduct</i>		
Returns and allowances	\$4,679.94	
Cash discounts allowed	458.14	
Collection and exchange	115.38	
	\$5,253.46	
Less decrease in provision for newsdealer returns of <i>QST</i>	26.87	\$5,226.59
Net Revenues		\$71,574.15

EXPENSES	
Publication expenses, <i>QST</i>	\$15,281.90
Publication expenses, Handbook	10,764.56
Publication expenses, calculators	726.31
Publication expenses, booklets	788.41
Salaries	21,644.82
Membership supplies expenses	1,569.69
Postage	2,377.66
Office supplies and printing	1,543.10
Traveling expenses	1,615.86
Telephone and Telegraph	556.54
General expenses	776.44
Insurance	496.37
Rent, light and heat	834.47
<i>QST</i> forwarding expenses	799.11
Provision for depreciation of furniture and fixtures	255.37
Communications Dept. field ex- penses	116.41
Bad debts written off	62.51
Headquarters station expenses	31.79
General Counsel expenses	38.60
Total Expenses	\$60,279.92
Net Gain before Expendi- tures against Appropria- tions	\$11,294.23

Strays

W3AOF has a suggestion for those using SW3's on 28 mc.: By leaving the general-coverage grip clips off the composition pillars when using band-spread coils a decided improvement in signal strength was noted. Evidently the dielectric loss in the pillars was enough to affect the signal strength.

Errata: In last month's article on the "Improved Tritet Exciter," the wire size and coil diameters were omitted. The wire size is No. 18 enamelled, the coil diameters 1 1/2".

Two bulletins of interest to technically-minded amateurs, "Pentagrid Converter Oscillator Considerations" and "The Relation of Modulation Products with Multi-Tone Signal to Harmonic Distortion with Mono-Tone Signal in Audio Amplifier Analysis," are available without charge from the Ken-Rad Corporation, Owensboro, Ky. The latter bulletin is of particular interest because of its discussion of a type of distortion peculiar to the Class-B audio amplifier. An engineering bulletin on the 6L6 tube also is available.

A "Neon-Stick" Visual Modulation Monitor

By C. A. Campbell,* W9QK

DESPITE the many excellent articles published regarding 'phone adjustment, overmodulation, the most obnoxious of abuses, still persists. Most of us who operate 'phone consistently are so used to it that we develop a tolerance and learn to understand the peculiar sound of speech sliced up with "splashes"; but a talk with several who have given up 'phone for c.w. was so convincing that it seemed a little further investigation was needed.

All of our available accurate measurements are based upon the use of a continuous audio signal of one frequency for modulation when these measurements are made. What happens when we remove the 60 cycles, beat oscillator, or other source of sine wave, and substitute one of the most complex waves known, the human voice? A wholly false but too general impression exists (even in broadcasting circles) that because the *average* energy in speech is greatest at lower frequencies, the *peak* values are also; and, consequently, if means indicating either of these at the lower frequencies are employed, full information regarding possible overmodulation is had. Recent authoritative work¹ has shown that this assumption is not so! Energy peaks occur as often and with fairly equal intensity over the range of 200 to 5000 cycles. The intensities are very nearly equal and maximum between 500 and 2000 cycles.

When a carrier is modulated, no matter how, it is the *peak* modulating voltage that determines the percent modulation; consequently, even though the amount of *average* energy is kept low, it is entirely possible and probable that numerous unobserved peaks are over-shooting on the positive half cycle and interrupting the carrier on the negative. As we have seen from too many articles to quote, this interruption causes an extensive series of r.f. sidebands which are spaced apart by the modulation frequency. The fellow with controlled carrier supposedly operates at constant percentage modulation, but in all the schemes so far proposed it can be shown that due to the time constant of the necessary audio filter, it is entirely possible for the higher-frequency audio components to "splash," since the carrier cannot rise as rapidly as a peak of higher frequency which may appear in the modulation circuit.

The Federal Communications Commission has instructed all broadcasting stations, or will shortly, to install monitoring equipment which flashes a light on *every* modulation peak exceeding a certain value, some of the more progressive stations having done this previously. The device in its commercial form, while excellent, is no doubt beyond the means of practically all amateurs; but it seems that something similar is necessary if we are to avoid needless interference. Some years ago I saw a piece of neon tubing connected to a modulated r.f. stage and watched the thing flicker with modulation; upon inquiring why it wasn't used as a modulation indicator, I was told that it apparently wasn't linear—or something to that effect—and that, anyway, the operator didn't know just where to let the end of the column shoot on modulation.

Out of curiosity, I obtained a piece of neon tubing myself to find out just how the thing did work and found that, on my particular outfit, if the glow was allowed to extend about half the length of the tube with the carrier unmodulated, 100% modulation was indicated by the tip of the glow just touching the other electrode. Upon passing *apparently* similar hunks of tubing around, the reports were variable to say the least;

some said that they overmodulated with this adjustment, others couldn't make it work, and still others said that they were not "hitting it hard enough." Recently, with better facilities

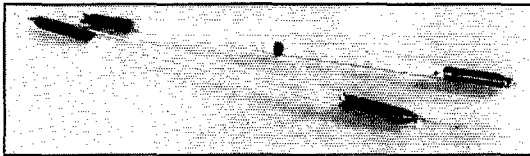

for investigating the neon tube itself, it was found that the bunch of tubes I had passed around were all different in construction and could not be expected to work alike. Maybe if some more were to be made just like the sample I was fortunate to possess, they would all work that way. To make a long story short, we went into the tube design quite thoroughly and found that the diameter and length had to be in the proper ratio, approximately 14 inches of 15 mm. tubing being about correct, and the gas mixture controlled quite carefully to keep the tip of the glow distinct. It was also found that if the tube was to respond linearly to peak r.f. voltage variations, the electrode drop had to be as small as possible (some electrodes may take as much as four or five hundred volts, while those adopted require about fifty). With this construction the life is over 5000 hours.

* 301 Dodson St., Geneva, Ill.

¹ Fletcher, *Bell System Technical Journal*, Vol. X, No. 3.

(Continued on page 70)

Inductive Neutralization of R.F. Amplifiers

By L. M. Craft* and Arthur A. Collins*

IT IS perhaps incorrect to refer to one type of neutralization as "capacity" neutralization and another type as "inductive" neutralization. All neutralization circuits employ some type of bridge involving both inductance and capacity. However, it is common practice to adjust one of the capacities to balance the neutralization bridge, therefore in contrast it may be permissible to use the term "inductive neutralization" to describe a bridge circuit in which a mutual inductance is varied to perfect the balance.

Inductive neutralization circuits are very old,

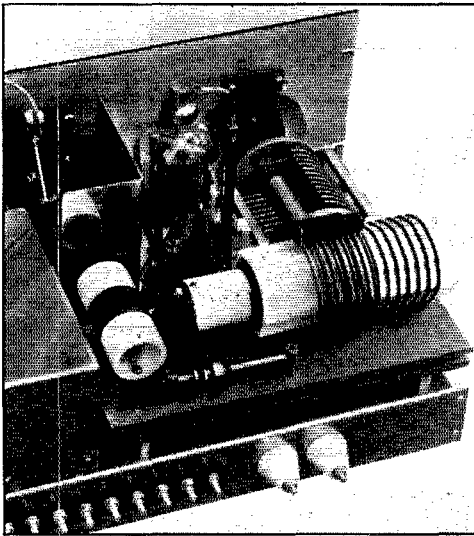

INDUCTIVE NEUTRALIZATION IN A MANUFACTURED TRANSMITTER

The input and output tank coils are co-axial, the smaller (input) being arranged to move in and out of the larger (plate). Neutralization is accomplished by varying the coupling. This particular installation corresponds to the diagram given in Fig. 2, the tank inductance for the pentode driver being divided into two sections. The second section is mounted to the left, with its axis at right angles to those of the other coils so that coupling is minimized.

but they have not been widely used in connection with receivers. An application of inductive neutralization has recently been made to transmitter circuits which offers several practical advantages of general interest. An inductively-neutralized amplifier is represented in Fig. 1. The input and output tank coils L_1 and L_2 are mutually coupled; any simple mechanical means may be provided to vary the degree of coupling. The connections and

direction of winding of the two coils are such that the voltages produced in either coil by the mutual inductance and by the grid-plate capacity current are opposed.

A practical circuit may actually be as simple as that shown in Fig. 1, but several precautions must be observed if complete balance is to be ob-

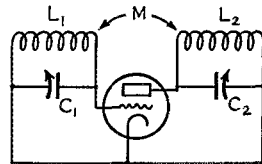

FIG. 1—THE FUNDAMENTAL CIRCUIT FOR INDUCTIVE NEUTRALIZATION

tained. In the first place, the inductances L_1 and L_2 must be connected directly across the grid-filament and plate-filament capacities of the amplifier tube; that is, there must be no taps on these coils such as might be used for varying excitation or loading. In the second place, if power is to be taken from the plate tank circuit by inductively coupling to the plate coil, the plate tank circuit must have an effective "Q" between 5 and 10; that is, the reactance of the plate tank

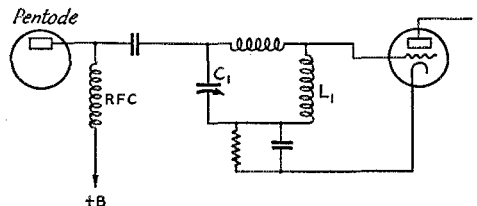

FIG. 2—COUPLING CIRCUIT FOR MATCHING A PENTODE PLATE TO THE GRID OF A FOLLOWING TRIODE

The inductance in the resonant circuit is divided into two parts, the inductance ratio of the two coils being adjusted for proper power transfer. The coil L_1 , connected between grid and cathode of the amplifier tube, is coupled to the output tank coil for neutralization. The remaining inductance is arranged so that there is no coupling either to L_1 or the plate tank.

condenser at the operating frequency should be one-fifth to one-tenth of the load impedance seen by the amplifier tube.¹ There is no restriction as

¹ This is quite in line with usual amateur practice. With a load impedance as low as 2000 ohms (most tubes require a considerably higher load for efficient operation) this requirement would necessitate an effective tank capacity of approximately 30 μfd . at 14 mc., with proportionate values on the other bands. As tubes are normally operated, considerably lower tank capacity values could be used, although excessively low C is undesirable because of the increased harmonic output.—EDITHOR.

* Collins Radio Company, Cedar Rapids, Iowa.

to tank circuit "Q" when the load is connected in the capacity branch.

The circuit is readily adjusted for neutralization by any of the common means used to indicate minimum current in the plate tank circuit when it is tuned to resonance. The most convenient method is to observe the rectified grid current appearing in the amplifier with the plate voltage removed. As the circuit is adjusted for neutralization a point will be reached where the grid current does not fall as the plate circuit is tuned to resonance.

Inductive neutralization has two important disadvantages which, although they do not preclude its use, must be borne in mind. The first of these is that the adjustment for neutralization is dependent upon frequency. A limited range of frequencies such as from 14,000 to 14,400 kc. may be used without readjustment of neutralization. When a single set of coils is to be used over a wider range of frequencies, such as an octave, it is convenient to link the neutralization adjustment mechanically with one of the tuning adjustments so that automatic tracking of neutralization is obtained. The most usual case, however, is the one in which a single set of coils will be used for one or, at the most, two fixed frequencies and in which it is possible to have a plug-in coil assembly mounting both plate and grid coils, so that, once the neutralization adjustment is made, it is not disturbed when changing from one set of coils to another.

The second limitation of the system is that the coupling coefficient for neutralization on ultra-high frequencies is very large, and considerable care must be taken in coil design and attention paid to the inductance of circuit wiring. Perhaps the practical upper frequency limit for inductive neutralization is in the neighborhood of 20 to 30 mc., except when amplifier tubes of very low grid-plate capacity are used.

The list of advantages is more impressive. The first of these is the extreme simplicity of the

ment always interlocks with one of the tuning adjustments so that a see-saw procedure must be followed to obtain an accurate balance. In contrast, the inductive neutralization adjustment has an imperceptible effect on the tuning of either the grid or plate circuits.

A second advantage is that an inductively-neutralized amplifier is simpler and more compact mechanically than a corresponding capacity-neutralized amplifier. The plate and grid tank coils themselves form the only components required for neutralization, and no special neutral-

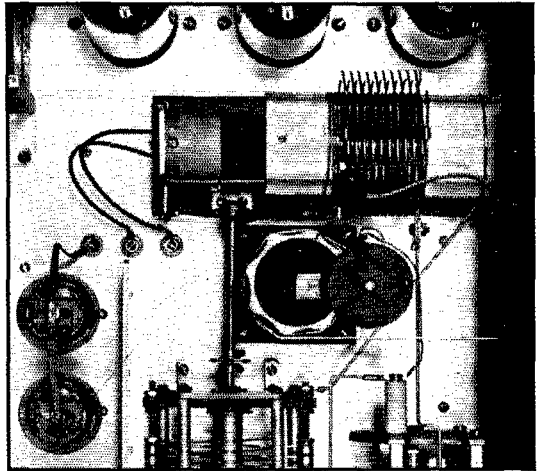

ANOTHER INSTALLATION OF INDUCTIVE NEUTRALIZATION

In this transmitter the plate tank condenser and mutual-coupling adjustment are ganged mechanically through a cam arrangement so that neutralization can be maintained over a wide frequency range.

izing windings, shielding, split-stator condensers or neutralizing condensers are required. A corollary to the mechanical simplicity of an inductively neutralized circuit is that higher operating efficiencies are usually obtained. In most cases an increase of plate efficiency and reduction in driving power is noted when changing from the capacitive to the inductive system.²

An additional and very much appreciated feature is that parasitic oscillations are rarely encountered in an inductively-neutralized amplifier. This is particularly true of the circuit of Fig. 2 where provision is made to match the grid circuit

² Probably because no splitting of the tank circuits is necessary. With the ordinary capacity-balanced systems either the input or output circuit is working under rather unfavorable conditions, depending upon the type of neutralization employed ("plate" or "grid"). In one case the effective load impedance is comparatively low for a given degree of antenna coupling; in the other only part of the voltage developed in the grid circuit is available for excitation purposes, which makes excitation more difficult even though the neutralizing circuit consumes negligible power.—**EDITOR.**

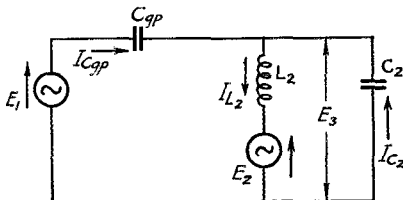

FIG. 3—SIMPLIFIED EQUIVALENT CIRCUIT OF THE INDUCTIVELY-NEUTRALIZED AMPLIFIER

amplifier circuit and the ease with which the neutralization adjustment may be made. In neutralization circuits employing a variable condenser for adjustment, the neutralizing adjust-

of a neutralized triode to the plate circuit of a screen-grid driver.

Either single-ended or push-pull amplifiers may be inductively neutralized. A symmetrical coil arrangement for push-pull circuits is desirable to avoid capacity unbalances between the windings. Symmetry can be obtained by splitting one coil and placing the other coil between its halves, or by placing the coils side by side with their axes parallel. The latter arrangement may give suffi-

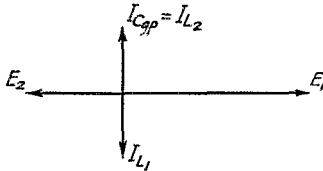

FIG. 4—VECTOR DIAGRAM OF CURRENT AND VOLTAGE RELATIONSHIPS IN THE CIRCUIT OF FIG. 3

cient coupling only on the low and medium high frequencies.

DESIGN DATA

The following analysis of inductive neutralization is interesting from a theoretical standpoint and is useful when it is desired to calculate the circuit constants in advance. Fig. 3 is a simplified circuit showing one tank circuit consisting of inductance L_2 and capacity C_2 which is both inductively and capacitively coupled to the other tank circuit. The capacitive coupling C_{gp} is the grid plate capacity of the amplifier. The input tank circuit, consisting of inductance L_1 and capacity C_1 , is for simplicity replaced by the voltages E_1 , the voltage appearing across its terminals, and E_2 , the voltage induced in L_2 due to the mutual inductance M between L_1 and L_2 .

Consider first the circuit of Fig. 3, neglecting any resistance appearing in either grid or plate tuned circuits.

Then:

$$E_1 = I_{L_1} \omega L_1 \text{ and } E_2 = I_{L_1} \omega M$$

where

$$\omega = 2\pi f \text{ and } f \text{ is the frequency in cycles}$$

per sec.

and I_{L_1} = current flowing in L_1

Further let the mutual inductance coupling be such that with the positive directions of E_1 and E_2 as shown by arrows in Fig. 3, E_1 and E_2 will be 180° out of phase as shown by the vector diagram, Fig. 4.

Temporarily assume C_2 to be replaced by a short circuit. Then:

$$I_{C_{gp}} = E_1 \omega C_{gp} = I_{L_1} \omega^2 L_1 C_{gp}$$

and

$$I_{L_2} = \frac{E_2}{\omega L_2} = \frac{I_{L_1} M}{L_2}$$

These currents are shown in Fig. 4 also. $I_{C_{gp}}$ leads E_1 in phase by 90° and I_{L_2} lags E_2 in phase

by 90°. Thus I_{L_2} and $I_{C_{gp}}$ are in phase and if they are made equal in magnitude there is no current flowing in the short circuit. Thus the short circuit may be removed and no voltage will appear across the terminals of L_2 and no current would flow in a condenser C_2 when added.

Thus for neutralization $I_{C_{gp}} = I_{L_2}$ or $M = \omega^2 L_1 L_2 C_{gp}$.

If the coefficient of coupling between L_1 and L_2 is designated as k ,

$$\text{then } M = k \sqrt{L_1 L_2} = \omega^2 L_1 L_2 C_{gp}$$

$$\text{Thus } k = \omega^2 \sqrt{L_1 L_2} C_{gp}$$

For design purposes the capacity C_{gp} is known and the inductances L_1 and L_2 are chosen first. A parameter

$$K = \frac{C_{gp} \sqrt{X_{L_1} X_{L_2}}}{1000}$$

is computed where $X_{L_1} = \omega L_1$ and $X_{L_2} = \omega L_2$ (L_1 and L_2 in henries) and C_{gp} is the grid-plate capacity in micro-microfarads. For various values of this parameter the coefficients of coupling in percent have been plotted versus frequency in Fig. 5. This chart becomes more useful if it is noted that for a constant L/C ratio of the tank circuits K is independent of frequency. A further precaution to be observed in the use of this chart is to keep in mind that coefficients of coupling of more than 50% are difficult to obtain at radio frequencies.

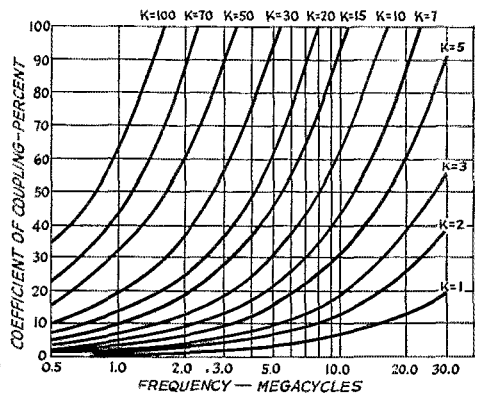

FIG. 5—COUPLING COEFFICIENT VERSUS FREQUENCY FOR NEUTRALIZATION WITH VARIOUS VALUES OF PARAMETER K

$$K = \frac{C_{gp} \sqrt{X_{L_1} X_{L_2}}}{1000}$$

To make a more exact analysis, assume the tuned circuits to have resistances R_1 and R_2 either due to loss in coils or due to load coupled into coils from grid circuit or antenna circuit. Then, using complex notation:

(Continued on page 86)

H A M D O M



Colloquy ("Hamdom" editor and alter ego):
How about a YL page this month?

OK; how many YL's have we got on the hook?

Four, including a pair of sisters.

Oh, the poor things! Take them down this instant, and we'll see what they're like.

Righto. Whom shall we . . . er . . . I mean, with whom shall we start?

Why, the Johnson sisters, of course. Two against one? Don't be silly! (Tnx, Henry L.

Luoma, W9SQB, for the dope.)



"traffic man." Although she has been licensed but three years, she is O.R.S., O.B.S., R.M., and has one of the most efficient stations on Trunk Line "C." On the air with a flea-power rig in February, 1933, she handled a message and got such a kick out of it she was O.R.S. a year later. The present station line-up is 47-46-'10's p.p. with 100 watts. Now 19 years of age, a bookkeeper by occupation, Alice has many avocations and enthusiasms. Swimming, bowling, skating, skiing, rifle shooting—she likes all sports. She is an ardent Red Sox fan, and intersperses radio with attendance at baseball, hockey and football games, wrestling matches and boxing bouts—anything with the earlier-mentioned competitive element. A music-lover, too, her tastes run from musical comedy to opera. Finally, her ambitions: (1) To be a newspaper reporter; (2) a commercial ticket! Perhaps her flood work on behalf of Boston newspapers may help with the first.

ASK any ham in the Great Lakes region about W9PCU and he'll tell you that they are the two finest YL ops in the country—and "regular guys," besides. (At least, that's what we were told!) They are Violet and Vivian Johnson, of Chippewa Harbor, Isle Royale, near the Canadian shore of Lake Superior. Violet, blue-eyed, blonde, and tall, is 21; Vivian, about two years younger, is dark, has hazel eyes, and—well, anyway, since getting their first tickets in October of 1933 they have had nearly 3,000 QSO's and have handled nearly that many messages, all with 3 or 4 watts input to a 112A TNT. Their receiver is a 3-tuber using 30-31-30. Chances to be of public service have been excellent on the island, and the girls have never been found wanting. QST has chronicled several of their feats, including the saving of their brother's life. Their rescue of Isle Royale's moose was dramatized in the A.R.R.L.-N.B.C. series a year or two ago. Isle Royale is entirely isolated in winter time, and amateur radio is the only means of communication. But this summer you'll be able to visit their Dad's tourist resort, and sample some of Violet's famous cakes and pies, and enjoy some glorious hiking, or swimming, or trolling. Whatever your forte, you'd be assured a "Royale" welcome at W9PCU!



SAYS Carrie Jones, W9ILH: If I can't get any answers to my calls after this is published, I will know the reason why! Says the "Hamdom" editor: Well, if I were you, I wouldn't worry. Anyway, we shouldn't be speaking of W9ILH thus informally, for she is actually Mrs. M. D. Jones, the OM being W9ICN. It was one of those things. The OM, needing code practice in late 1931 while boning up for his ticket (they were married in 1928; note the 3-year lapse!), picked

on the XYL. So intrigued did she become that, lo and behold, she passed her exam the same time he did. From a Hartley '10 she has progressed to 59-841-242A-852. She is O.R.S., R.M., D.C.N.S., A1 Op, and a beacon light on Trunk Line "K," where she averages 8 to 14 daily skeds. Her ambition is to be O.R.S. "Queen"—and maybe she did it, this time! Well, what else? Brown hair, blue eyes, 5-feet-3, 130 pounds, a charming 26, and—she got her Class A license in 1933 (just couldn't let the OM get ahead), but she wants it known she's "strickly a c.w. hound" for a' that!



Alice Fitzgerald, W1FRO, likes anything where competition is involved. Doubtless that's the reason she is such an outstanding

1935 Sweepstakes Contest Results

By E. L. Battey, WIUE*

HAM radio contests are great stuff! Perhaps you win and perhaps you don't—and you never know until it's all over! But whether you do or whether you don't, you have a whale of a lot of fun and get much good operating experience. The Sixth All-Section Sweepstakes Contest was no exception. From start to finish the



W3BES, E. PENNSYLVANIA WINNER

Jerry Mathis ran inputs of up to 1 kw during the SS. For 7 and 14 mc. the tube line-up was 802-two 802's-52-two 52's (500 to 1000 watts). For 3.5 mc.: 802-two 802's-52 (300 to 500 watts). He attributes his 72,215 score to the HRO receiver, use of 13 crystals, break-in, careful selection of operating times, use of the three most popular S.S. bands and plenty of soup in the antenna.

bands buzzed with "CQ SS," "Ur nr 73 ok," "Tnx for new section," "CQ SS," "Hr msg fm . . .," more "CQ SS," and other familiar phrases found in the "Sweepstakes." There were no lulls (except when one lost a vital piece of the station apparatus!—and what an unequalled opportunity a contest provides to see of what stuff your station is made!!). Operating skill was matched against operating skill. And good operating ability, plus a good receiver, a well-adjusted transmitter and intelligent use of the various bands was the winning combination!

W6JMR expresses well the feeling of the ardent "SS-er": "The SS is a whole lifetime wrapped up in one week. You start out even with the other fellow; you're full of vim and vigor, have certain goals you hope and strive for. As the contest goes on, maybe you get there and maybe you don't. Maybe you get the breaks—maybe you don't. But it's all in the game, and you keep fighting on until the end, then sit back and say, 'There's my

* Assistant Communications Manager.

record, and rotten or not I'm proud of it.' There are those who give up the battle early and just plain quit; there are those who keep fighting on against hard luck to the bitter end and take joy in the fact that they've done the job just as well as they were able; and, of course, there are Dame Fortune's chosen few whom you just can't beat! That's the SS."

The accomplishments of 676 operators are recorded in the list of scores. In addition to the usual listing of number of sections worked by each participant, the number of different stations worked, power factor used and number of operating hours are also recorded so that a more comprehensive picture of each operator's success may be given. 38% of all scores topped the 10,000 mark . . . 19% are over 20,000! Forty-five scores are above 40,000 . . . 27 above 50,000! Sixty or more sections were worked at 36 stations! Grasp the significance of these facts and you'll realize that the Sixth National QSO Party—the Sixth SS—was *some contest!*

Certificate awards are being made to the leading operator in each of 66 of the 69 A.R.R.L. Sections. No entries were received from Mississippi, Western Florida and the Philippines. Competition was extremely keen in practically every one



W8BEN

If neatness in station arrangement aids operating, one of the answers to W8BEN's 46,943 points is immediately apparent! Enclosed in the framework is a 59 crystal or e.c. oscillator, 59 doubler and RK-20 final, 100 watts input. The receiver is a three-tube t.r.f. The skywire is a 66-foot Hertz, single wire feeder.

of the 66 sections where awards are being made and especially so in Illinois, where 55 operators reported scores. The N.Y.C.-L.I. and Ohio Sec-

tions each have 36 operators listed in the scores; Western New York has 34, Connecticut 30.

LEADING SCORERS

While actual competition in the Sweepstakes is between the operators within any given section (awards go only to the leading operator in each section), it is only natural that contestants should strive to place high "nationally." This is, indeed, one of the factors that keeps the contest humming and interest high. James W. Ringland, W8JIN, Norwood, Ohio, takes highest honors in the 1935 Sweepstakes with 99,509 points!! One more section and he would have topped 100,000, but every SS-er knows that "one more section" is usually the "one that gets away"! W8JIN worked 534 different stations in 63 sections in a total operating time of 86 hours . . . a record of which to be proud! The rig at W8JIN consisted of a 53 crystal oscillator, 841 doubler-buffer, P.P. '10's final, running at 96 watts input. Four different frequencies were utilized in each of the 3.5- and 7-mc. bands, and two frequencies on 14 mc. Antenna was a 66-foot Hertz, single-wire feed. Harold C. Pratt, W1EZ, Pownal, Vt., placed second-high with a score of 86,690, working 504 stations in 58 sections in 90½ hours. A single '10 did the business on 3.5 (50 watts) and 14 mc. (25 watts), while an '03A running at 100 watts took care of 7 mc. Not far behind W1EZ comes Cameron Pierce, W6HJT, San Mateo,

strated time and time again that good judgment in using the "right band at the right time" counts much in making a winning score! R. D. Carter, VE3QD, Toronto, leads the Canadian participants with the noteworthy score of 68,076, based on QSO's with 375 stations in 61 sections . . . 85

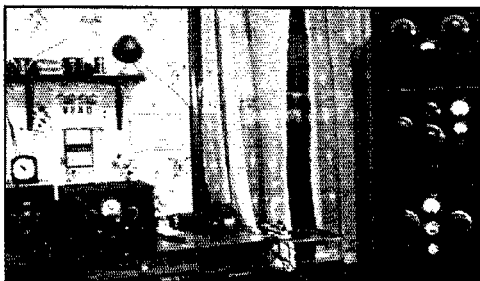

W8AQ

Designed for operating, W8AQ, owned and operated by Ev Gibbs, makes a pleasing appearance. The tube line-up is an RK-20 crystal oscillator and '03A amplifier, running at 180 watts input. W8AQ was one of the highest scoring Ohio stations.

operating hours. He also used less than 100 watts input.

At this juncture it is revealing to "turn back the pages of time" to the First Sweepstakes Contest, held in 1930, and note that the national high score in that competition was only 13,158 (153 stations, 43 sections). At that time that was a real record and W1ADW, whose achievement it represents, should not feel that we are now attempting to belittle his accomplishment! We only wish to illustrate how the SS has grown and how much more can be accomplished to-day! Further, the first SS lasted a full two weeks and there was no "time factor" — in 1935 scores were based on only 90 operating hours.

We list here all scores above 50,000. The operators concerned should feel no shame if their hat sizes have increased a notch or two. Who wouldn't swell with pride at such operating records!? W8JIN 99,509, W1EZ 86,690, W6HJT 81,648, W4AG 79,680, W8BYM 76,725, W8FIP 75,609, W3BES 72,215, W4CA/9 70,492, VE3QD 68,076, W9DCB 66,681, W8NUR (W8GUF opr.) 65,056, W5ASG 63,612, W8DOD 61,331, W8KUN 59,508, W4PL 58,588, W5CJZ 58,212, W1BLR 57,175, W1DHE 56,917, W9AUH 55,836, W3OZ 55,491, W2HHF 54,312, W2CWE 53,586, W4IB (two oprs.) 53,105, W4BOU 51,480, W5WG 51,153, W1TS 51,125, W3EOP 50,447.

There have been six Sweepstakes but so far no operator has worked all 69 sections in any one of them. That is something to shoot at in future Sweepstakes. W9AUH came within one of hitting the coveted 69 figure in the 1934 contest, missing it only by the Philippines. In this 1935 contest the three operators at W6GPU managed to corral 67

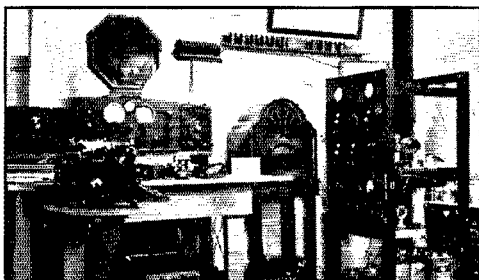

W7CY, CHEROKEE, WYOMING

Located in one of the "hard to get" sections, W7CY brought joy to many. In ham radio since 1912, his present rig consists of '47 crystal oscillator, '10 buffer-doubler, 801's p.p. final; input 92 watts. During the contest only the 801's in p.p. were used due to more flexible band switching and frequency changing. Equipment includes a Leeds freq-monitor and an RME9-D with ACSW3 as a two-stage pre-selector for receiving. The antenna is an 80-meter Zepp working on three bands. For receiving a double doublet is used.

Calif., with 81,648 . . . the result of contacts with 448 stations in 63 sections in 70 hours of operating. OM Pierce used nine different frequencies on three bands (3.5-, 7- and 14-mc.) and pushed out with a pair of '10's in the final, 95 watts input. To W8JIN, W1EZ and W6HJT: Well done and congratulations! It is interesting to note that each of these gentlemen made use of the 3.5-, 7- and 14-mc. bands. It has been demon-

sections—all except Nevada and New Mexico! The best work of a single operator was that of W7BSU and W9AUH, each of whom snagged 66 sections. W7BSU missed only Mississippi, Western Florida and the Philippines, while W9AUH missed Western Florida, New Mexico and the Philippines. The lads say, "There's always a next time," so watch out, records! The complete list of those working 60 or more sections is as follows: 67: W6GPU (three oprs.); 66: W8BSU W9AUH; 65: W3BES W4CA/9 W4IB (two oprs.) W4PL W5LW W6SN W8KKG; 64: W4AG W4APU

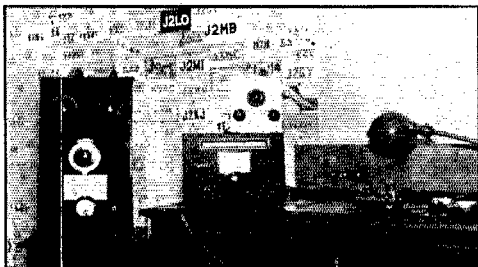

W5CJZ' EFFICIENT LAYOUT

Barney Moffatt, W5CJZ, won the Oklahoma Section certificate with a score of 58,212. His transmitter consists of the popular '47 crystal, '46 doubler, '10 final arrangement. Seven crystals and three bands, 14, 7 and 3.5 mcs., were used.

W6EPZ W8AQ; 63: W1DHE W1TS W3EJO W4OI W5CJZ W6HJT W8JIN W9AQD; 62: W2HHF W5ASG W6GTM W8BYM W8FIP W9DCB; 61: W3EOP VE3QD W8NUR (W8GUF opr.) W9IPT; 60: W1MK (Hal opr.) W4BOU W9BTJ W9VKF.

Three hundred or more stations were worked at 42 participating stations. W3BES leads the procession with contacts with 563 different stations, an average of 6.3 per operating hour. A pile of stations by any man's count! W8JIN worked an average of 6.2 per hour for a total of 534. W1EZ worked 504, or 5.5 per hour. The complete list of multi-QSO artists is W3BES 563, W8JIN 534, W1EZ 504, W1DHE 486, W6HJT 448, W2HHF 442, W9AUH 424, W3EOP 417, W4AG 416, W4IB (two oprs.) 415, W8BYM 413, W8FIP 412, W1ELR 408, W8NUR (W8GUF opr.) 397, W9AQD 393, W6GPU (three oprs.) 385, W2BXA 377, VE3QD 375, W4CA/9 371, W9DCB 362, W3OZ.354, W1BVP 353, W8DOD 351, W8KUN 349, W2CWE 347, W8AQ 346, W5ASG 342, W2FIS 334, W4PL 332, W8KKG 330, W5LW 327, W7BSU 319, W2AHC 318, W8JTT 315, VE3ACS 315, W4OI 313, W1GME 311, W5CJZ 308, W2PY 307, W3EXB 302, W3NF 302, W3BKZ 300. One of the "burning questions" in SS participation is whether to spend time looking for new sections, which increase the multiplier, or whether to work as many stations as possible (thereby increasing the points to be multiplied) and let the multiplier take care of itself. Opinions

vary on this and it is not possible offhand to say just which is best. However, and let this be a tip to those who enter future Sweepstakes, we are convinced that it is highly important to build up the section multiplier, but we are also convinced that there is a "turning point" in building up a score, after which additional sections become less important, and when it pays to start working as many stations as possible. Just when this turning point is reached, we don't know—possibly after working 35 sections, 40 sections, 45 or who can say? The point is, such a turning point exists and the contestant who finds it will have found one of the secrets of highest honors. Get out the slip sticks, boys!

USE OF FREQUENCY BANDS

7 mc. has been becoming more and more the most popular SS band. In this contest 85% of all contestants made full-time or part-time use of 7 mc. 26% made full-time use of this important band. 3.5 mc. was the second most popular band with 55% of all participants operating there either full- or part-time; 11% used 3.5 mc. exclusively. The greatest value of 3.5 mc. lies in its ability to produce the more "local" sections, not so readily obtained on the highest frequencies. 41% used 14 mc. full- or part-time. 21% divided operation between 3.5, 7 and 14 mc., 20% between 3.5 and 7 mc., and 16% between 7 and 14 mc. 28 mc. was used for the first time in an SS and 56 and 1.75 mc. came in for a slight amount of usage. Among



W1GME

A familiar signal throughout the S.S. was that of Rus Clark, W1GME, O.R.S. His compact station shown here consists of a 53 crystal oscillator-doubler, '46 buffer-doubler and p.p. '10's final amplifier; a Sky rider receiver; and a monitor, which rests between the transmitter and receiver. The rig puts out on the 1.75-, 3.5-, 7- and 14-mc. bands. Input averages 90 watts.

those using 28 mc. were W1FRK, W3CHH, VE3DU, W4AJY, W5WG, W6DIO, W7EVV and W8ITK. A careful use of all the most popular bands at the right times is the answer to best results in most cases. Witness that W8JIN, W1EZ and W6HJT each used 3.5, 7 and 14 mc. And that W9AUH and W7BSU, who each worked 66 sections, also used those three bands. The W6GPU operators worked their 67 sections on 7 and 14

mc. An exception to the rule that it is not usually possible to work a great many sections on one band only is W6SN, who worked 63 of his 65 sections on 7 mc.; the other two were worked on 14 mc.

THE POWER FACTOR

There were but two power classifications in the 1935 Sweepstakes—those using “up to and including 100 watts” (who multiplied their basic scores by 1.5 for final scores), and those using “over 100 watts” (who multiplied by 1 for final scores). The final scores of those using power over 100 watts part-time, and under 100 watts part-time, are comprised of the total of their “low power” and “high power” scores, which are computed separately. 75% of all contestants chose to operate in the “100 watts or less” group, taking advantage of the 1.5 multiplier. 24% used over 100 watts, while the remaining 1% operated in both classifications. W8JIN was the highest scorer using the 1.5 multiplier, W3BES highest using multiplier of 1, and W4PL highest operating in both power groups. In order to give an idea of actual accomplishments (number of stations worked and number of sections worked) of those using power under 100 watts and those over 100 watts the following statistics are given. These figures will help to determine the relative merits of the two power classifications. We reach no conclusions, however, since operating ability and use of bands play such a big part in actual results. Of the 42 stations where 300 or more stations were



W6HJT, HIGH WEST COAST SCORER

The highest west coast scorer and third highest national scorer was Cameron G. Pierce, W6HJT. He used a '47 crystal oscillator, 841 buffer and p.p. '10's final with 95 watts input. Nine frequencies were used on three bands (14, 7 and 3.5 mc.). Contacts with 448 stations in 63 sections brought him 81,648 points.

worked, 21 used 100-or-less watts, 18 used over 100 watts, and 3 operated in both classifications. Of those working 60 or more sections, 18 used over 100 watts, 17 used 100-or-less watts, and 1 operated in both classifications. W6GPU (two oprs.), who worked 67 sections, and W7BSU and W9AUH, who worked 66 sections, all used over 100 watts. W3BES, who worked the most stations, 563, used over 100 watts, while W8JIN (534 stations) and W1EZ (504 stations) used under 100 watts. As a matter of record, 46 of the 66 section-winners operated in the 100-watt-or-

less group, 18 operated with over-100-watts, and 2 operated in both groups.

LOW POWER RECORDS

The work of several operators, who used what we consider truly *low power*, is worthy of special



W6LDJ

Winner in the San Diego section was W6LDJ, O.R.S.. owned and operated by S. T. McNeal. The rig used in the S.S. was a 59 c.c.-e.c. oscillator—'46-801-242A. A Zepp on 7 and 14 mcs. and a center-fed antenna on 3.5 mc. were the radiators.

mention. W9VES worked 107 stations in 31 sections using only a '45 TNT with 5 watts input. W2EEL worked 124 stations in 22 sections with 6 watts input. W9KCG made 18,075 points (124 stations, 50 sections) using 7 watts to a '71A amplifier. With 8.1 watts to a '12A TNT oscillator, W5BD made 13,455 points (118 stations, 39 sections). W8FDA, using but 10 watts to a single '71A oscillator, made the astounding total of 45,441 . . . contacts with 283 stations in 54 sections! 19,593 points is W8NDG's record using 10 watts on 3.5 mc. and 12.5 watts on 7 mc. into a '45 Hartley. He worked 158 stations in 42 sections. W3FBM used a '45 Hartley on 3.5 and a '45 TNT on 7 mc., each with 10 watts input . . . and he worked 160 stations in 41 sections for 19,250 points. W9AND, using the 3.5-mc. band entirely except for five 7-mc. contacts, and with but 16 watts input to a single 2A5 crystal oscillator, made a score of 30,141 . . . 200 stations in 51 sections! Of interest also is W9AND's receiver—an '01A detector and '01A audio! The records of these operators deserve the praise of everyone who ever sent a CQ!

PHONE PARTICIPATION

VE3ER made the highest score, 4623, of those operators using radiotelephone. He worked 67 stations in 23 sections using the 3.9- and 14-mc. bands; many contacts were 'phone-c.w. W4BZA made 1562 points (36 stations in 22 sections) on 14-, 3.9- and 1.75-mc. 'phone. Thirty-two contacts were on 14 mc., 2 on 3.9 and 2 on 1.75. W4DGS' 952 points were rolled up on 1.75-mc. 'phone; he worked 34 stations in 14 sections. Using 3.9 and 14 mc. W9DMF worked 17 stations in 17 sections

for a score of 563. In addition to making one of the highest c.w. scores, W8FIP put in a little time on 1.75- and 3.9-mc. 'phone, making 138 points (23 stations, 2 sections). W6HJT made one contact on 3.9-mc. 'phone.

CLUB AWARDS

Scores were submitted by amateurs in 83 different clubs. Special certificate awards were of-

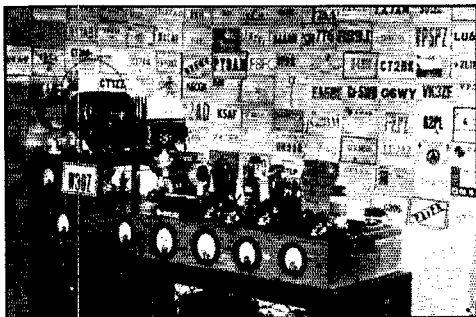

W3OZ

The five-stage rig at W3OZ consists of 53 crystal, '46 doubler, '10's p.p. amplifier, 860 final. Keeping the input below 100 watts for the contest Edwin Roller led the Md.-Del.-D.C. Section with 55,491 points.

ferred to the highest scoring participants in each A.R.R.L.-affiliated club where three or more individual club members took part and submitted scores. Awards are being made to the following amateurs in the clubs indicated: W1IOT, Worcester (Mass.) Radio Association; W1NE, Connecticut Brasspounders Association; VE2FG, Montreal Amateur Radio Club; W3ATR, Beacon Radio Amateurs (Philadelphia, Pa.); W3BES, The Frankford Radio Club (Philadelphia, Pa.); W3EOP, The Key Club (Easton, Pa.); VE3QD, Hamilton Amateur Radio Club; W4APU (c.w.), Birmingham (Ala.) Amateur Radio Club; W4DGS ('phone), Birmingham (Ala.) Amateur Radio Club; W5BDI, Houston (Tex.) Amateur Radio Club; W6CIS, Associated Radio Amateurs of San Francisco; W6KBD, Whittier (Calif.) Radio Amateurs' Association; W8BDV, Finger Lakes (N. Y.) Transmitting Society; W8DOD, Rochester (N. Y.) Amateur Radio Association; W8EMW, Central New York Radio Club; W8LAW, Cleveland Heights Amateur Radio Club; W8MCL, Bluefield (W. Va.) Amateur Radio Club; W9AWP (c.w.), The Wichita (Kans.) Amateur Radio Club; W9DMF ('phone), The Wichita (Kans.) Amateur Radio Club; W9LKI, Fort Wayne (Ind.) Radio Club; W9OQW, Southtown Amateur Radio Association (Chicago); W9RCQ, Egyptian Radio Club (E. St. Louis, Ill.); W9RH, Milwaukee Radio Amateurs' Club, Inc.

Members of 62 other clubs submitted scores but, since there were not three or more entrants from their clubs, no awards can be made. If, upon

checking, any club finds that it actually had three participants, but no award has been made, we shall correct the situation upon receipt of such advice. There are many cases where contestants did not mention membership in any club so their work could not be credited towards a club certificate.

ITEMS OF INTEREST

Probably the closest race of the SS contest was in the Northern Texas section between W5CPB and W5BTS; they wound up with only 31 points difference in scores—W5CPB 17,784, W5BTS, 17,753. Other close battles were in E.N.Y., between W2EWD, 27,669, and W2BMX, 27,284; 385 points difference; in W.N.Y. (the Central New York Radio Club), between W8EMW, 34,506, and W8AQE, 33,810; 696 points difference; and in N.Y.C.-L.I., between W2HHF, 54,312, and W2CWE, 53,586; 726 difference. W2FIS QSO'ed W1AQW, Lewiston, Maine; his next QSO was with W8CHR, Lewiston, Pa. W9EHA did one better by working Lewiston, Pennsylvania, Vermont and Maine. Mrs. Mary Roth, W9TSV, is winner in Illinois; she says she could have made more points, but had to attend to her housework as well as cook a Thanksgiving dinner for six! And yet some of the OM's say we need a multiplier for the married men! The texts of all messages originated at W8KXA were titles of popular songs. W9VKF's first QSO of the contest was with W4SV, Florida on 14 mc., and his last was with W7EOF, Tacoma, Wash., on 3.5 mc.—two extremes in frequencies, and two extremes in geographical location. W9IGW and W9OUD, brother and sister, with rigs at the same QTH, had to share time. The "biggest little" report came from W9MMX—a two-foot figure "2" cut out of wrapping paper, carrying a score of "2." Hi. Oddities at W9NUF: Working W8AVH, W9AVH; W5AQE, W8AQE; W3CHH, W9CHH! W8DED will award free QSL cards to the highest national scorer. Says W9KEH, "Please note that stations can be worked on CQ's—only 4 CQ's missed during the contest." First Michigan contact at W3DPU was W8GQB; the very next contact was with W8GQC, also in Michigan! Sour grapes: "This score won't win a prize but then, I didn't try very hard." The average number of operating hours of the 66 Section winners was approximately 65. W4CA, operating portable at Nederland, Colo., is believed to have had the highest location in the SS—8257 feet above sea level. One of the worst locations is claimed by W6BNH, Stanislaus Power House, Stanislaus, Calif. Says he, "I'm down in a canyon on the Stanislaus River with the highest points at about 2000 feet. The camp is on the east side of a horse-shoe bend of the river. It takes a 1500-foot jump to get our east and south. The country is full of mineral deposits, besides all the power equipment!" W8KKG offered a millimeter to the

West Virginia station contacting more sections than he did—but nobody did it. Proof of a successful contest: The few heard calling "CQ No SS"—they couldn't raise anything but! Hi. Break-in operation more than proved its worth to those using it—saved precious minutes and soothed weary nerves. There is keen SS rivalry between North and South Louisiana. Looking ahead, W5BZR says he's going to win the Louisiana award in the next SS and gives the Louisiana award in the next SS and gives the Southern Louisiana gang fair warning. The Wichita (Kans.) Amateur Radio Club was sponsor of a local competition, several equipment awards being donated by local supply houses. Asking one ham if he were in the SS, K6CGK received this answer: "No, OM, I don't hold tickets for any sweepstakes." W6HJT was on the air about ten hours less than in the 1934 competition, but he worked about 200 more stations and was using one third the power of the previous year. W6FVD reports, "Using almost same equipment as previous year made about 6000 points more—even with the reduced multiplier. This is mostly due to using two bands instead of one only as in 1934." W3DSC's message to an unknown W9, "Hope you are in Wisconsin?"—back came, "Hr msg fm Milwaukee Wis. . . ." W2HHP's message to W7JL: "Wish I could work Oregon!"—on signing, he was called by W7AFG, Portland! W3BZP's operation was all from his bed, where he was confined during the contest. Among the "youngsters" in the SS: W9VES, age 14; W9NUF, 15. One lad who was put off the air by blown equipment moaned, "Woe is me!"—"Whoa was he," say we. The old 90% operator, 10% station, formula was checked by many contestants and found to be correct—W4AG goes further and says

that 9% of the 10% constitutes the receiver! W6BPM hands the SS a real bouquet: "Used to be one of the sideline skeptics, but am now really glad I got into it." And voicing the opinion of many, W2HWS asserts, "The greatest thrill since I got my ticket." "There's nothing like an SS except another SS," says W7DGY. W6JMR's message to W1AVJ, New Hampshire, told of the need of Vermont to complete his 48 states. W1AVJ gave him the call of a Vermont station . . . and the next station worked was in Vermont! WAS at last! VE1 was also needed to complete the Canadian districts and—sure enough, right after signing with Vermont, VE1ER was worked. W4CA/9 worked all states but Mississippi. W5DQB got his 48th state in the SS. W6GAL and W8ITK both spared the long-needed Vermont. It was the 48th for W6GAL. After five years of trying, W8AZU finally landed South Dakota. You can't beat the Sweepstakes for adding new states! Only six contestants put in more than ninety operating hours—and they forfeited points accordingly: W1DHE, W1EZE, VE3ACS, W6GPU, W8JTT, W8NUR. W1DHE observes, "With over 50,000 points it is just about impossible to gain points by operating overtime." 62% of W5BDI's contacts were made by calling CQ SS, the remaining 38% by calling stations. The biggest kick for W9JCW was snagging VE4NH for the last needed Canadian section one-half hour before the final gun! Oh, those final minutes! How they speed by, and how we work for that additional section and a few more contacts!! And the disappointments—the ones we missed—compensated for by the ones we didn't expect. What a game!!

SCORES

Sixth All-Section Sweepstakes Contest, 1935

(Scores are grouped by Divisions and Sections, in the order listed on page 5 of each issue of QST. . . . The operator of the station first-listed in each Section is winner for that Section unless otherwise stated. . . . Asterisks denote stations not entered in contest, reporting to assure that stations they worked get credit. . . . The number of sections and number of different stations worked by each station are given following the score. . . . Likewise the "power factor" used in computing points in each score is indicated by the letters A or B. . . . A indicates power up to and including 100 watts (multiplier of 1.5), B indicates over 100 watts (multiplier of 1). . . . The total operating time to the nearest hour is given for each station and is the last figure following the score. . . . Example of listings: W3BES 72215-65-563-B-89, or, Final Score 72215, number of sections 65, number of stations 563, power factor of 1, total operating time 89 hours. . . .)

ATLANTIC DIVISION

E. Pennsylvania

W3BES	72215-65-563-B-89 ¹	W3BZP	4869-27-60-A-29
W3EOP	50447-61-417-B-70	W3CFG	4290-22-66-A-39
W8FDA	45441-54-293-A-89	W3BGD	3393-29-62-B-16
W8MAH	40343-55-246-A-76	W3CQU*	1200-16-25-A-5
W3BRU	39546-52-254-A-62	W3DMF	1113-14-28-A-15
W3DPU	36192-52-236-A-66	W8NPQ	360-8-16-A-6
W3BXE	32423-55-199-A-72	W3EPJ	168-7-12-B-1
W3ATR	29759-51-198-A-82	W3MG*	2-1-1-B--
W3EJO	27594-63-222-B-44		
W3DRH	22509-43-173-A-60	<i>Mid.-Del.-D. C.</i>	
W3CHH	20228-52-106-B-35	W3OZ	55491-53-354-A-89
W3FKJ	17514-34-172-A-68	W3BKZ	35282-59-300-B-85
W3ADE	15480-40-129-A-40	W3DML	15600-40-130-A-33
W3CCD	13392-32-147-A-52	W3EIL	11319-49-117-B-60 ²
W3ENX	11868-43-100-B-20	W3FQZ	10973-35-105-A-78
W3EDC	10788-31-118-A-45	W3EJW	8324-31-91-A-38
W3DGM	9936-32-104-A-32	W3ER	5856-32-61-A-21
W3MZC	7600-38-100-B-32	W3EOW	5520-24-115-B-30
W3AKB	4884-22-75-A-15	W3FFN	2016-14-48-A-31
		W3FSP	1848-16-41-A-64
		W3FNK	1053-13-27-A-16
		W3FJE	624-13-17-A-11

¹ Two ops. Combined score: 72735. ² Station Score. EHM 4514. CRM 3270. ³ Score of opr. W8FWY; oprs. W8MLM and W8MJV also made 3 contacts. ⁴ Station score; oprs. W8LDA, W8JQV. ⁵ W8GUF operating. ⁶ Station score; oprs. W9UQT, W9A9Y. ⁷ Both power factors; high power: 6444, low: 4848. ⁸ Score of opr. W9KHD; opr. W9KHC also made 18 pts. ⁹ W9KAU operating. ¹⁰ Portable at Angola, Ind. ¹¹ Both power factors; high power: 10908, low: 168. ¹² Station score; oprs. W9PUC, W9RIK. Individual oprs. scores not itemized so No. Minn. award cannot be made until score of highest operator at W9PUC is ascertained. ¹³ Both power factors; high power: 604, low: 57984. ¹⁴ Station score; oprs. W4IB & P. McCampbell. ¹⁵ Both power factors; high power: 5760, low: 192. ¹⁶ Both power factors; high power: 8084, low: 28512. ¹⁷ Both power factors; high power: 5310, low: 180. ¹⁸ W9SCW operating. ¹⁹ Portable at Parkville, Mo. ²⁰ Both power factors; high power: 39273, low: 105. ²¹ Chief opr. Hal Bubb operating. ²² Connecticut Brasspours Association; W1GBX operating. ²³ Station score; oprs. W1TS, W1UE. ²⁴ Phillips Academy Radio Club; station score; oprs. W9KJQ, W1EFM, W1QGE. ²⁵ Worcester Polytechnic Institute Radio Club; station score; oprs. W2GNI, W1TX, W1BH, W1CCD, W1ISQ. ²⁶ Worcester Radio Association; W1DDQ operating. ²⁷ Radio Club of St. Paul's School; W1ZL operating. ²⁸ Boise Jr. College Radio Operators Club; score of opr. W7BRU; opr. W7DKY also made 6 pts. ²⁹ Station score; opr. W4BYD; opr. W4TEP also made 140 pts. ³⁰ Both power factors; high power: 5907, low: 15120. ³¹ Portable at Nederland, Colo. ³² Station score; oprs. W6GPU, W6FGE, W6BXL. ³³ Both power factors; high power: 17334, low: 60. ³⁴ Portable at State College, New Mexico. ³⁵ Station score; oprs. VE1EH, VE1EP, VE1HK. ³⁶ The Conn. award goes to W1GME since W1TS (HQ member) is not eligible.

High-Fidelity Audio at Low Cost

A Simple and Inexpensive Power Amplifier Unit of Striking Performance

By A. G. Hull*

"Broadcast station quality," we have been recently jolted to realize, is something that most of us hams talk about quite glibly without really knowing what we are talking about. We don't know what it is because we seldom, if ever, hear real high-quality reproduction. Quite properly, we do not get it with the communication-type equipment we are accustomed to use. But we ought to be exposed to it, at least occasionally, just to give us a proper reference standard for those "broadcast quality" 'phone reports we pass out so freely, if for no other reason. All this was brought home to us by Mr. A. G. Hull, technical editor of Australia's *Wireless Weekly* and brother of QST's Associate Editor Ross A. Hull, during his recent visit to A.R.R.L. headquarters in the course of a trip around this country and Europe surveying radio and television status for his Aussie readers. He learned some things about ham radio from us; and, we frankly admit, we learned some things about quality reproduction from him—which we pass on to Hamdom in this article, written especially for QST by "A. G." just before his return trip home.—EDITOR.

THERE is a vast gap separating the hobby of amateur radio from ordinary listening to broadcasting stations. Perhaps this explains why so few hams worry about maintaining any prestige when it comes to the matter of a program receiver for the home. A survey of a typical ham shack may reveal a fine transmitter and perhaps a hundred-and-fifty "bucks" worth

But here is an idea for those who are just a little fed up with messing around with what they have been doing for the past six months. Give that particular job a rest for the next few days and have a change. They say that a change is as good as a holiday. Try your hand at high-fidelity phonograph reproduction and broadcast reception. You may find it very interesting; and when you return to the 5-meter band, or whatever you are working on, you will find renewed enthusiasm and refreshed energy—along with a better conception of just what "broadcast quality" really sounds like. Apart also from the appreciation of the YF, you may find that the modernized home set sounds very impressive to the neighbors and other visitors who happen to hear it. After becoming accustomed to the tonal quality (?) of any ordinary set with single pentode output, a receiver which has a fairly high degree of fidelity tends to take hold of your ribs and make itself felt. And it doesn't do the game any harm if the man in the street gets an impression that hams have such brilliant brains that they can make up a receiver which sounds so much better than Mr. Street's factory-built job.

There are lots of simple ways of getting some reproduction which sounds impressive. The simple audio amplifier suggested for the purpose and diagrammed in Fig. 1 uses a circuit idea which has attained great popularity in Australia, where it has been going strong since 1932, as it has also in England and France. In the latter country they call it a "Kathodyne" circuit, that name being used because the method of obtaining out-of-phase signal for driving a pair of push-pull output tubes consists of taking excitation from the cathode circuit as well as the usual plate circuit of the first tube. And so we obtain resistance-coupled push-pull, with a frequency characteristic which is about as nearly perfect as can be

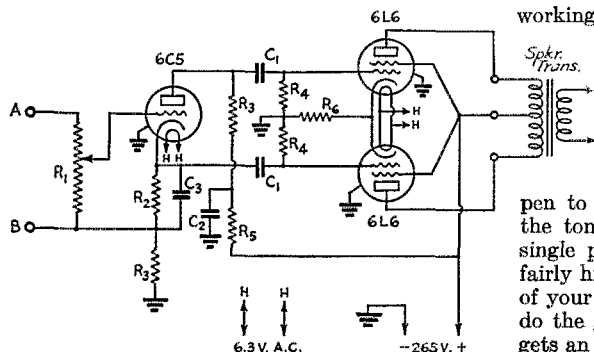

FIG. 1—CIRCUIT OF THE HIGH-FIDELITY AUDIO AMPLIFIER

- C₁—0.1- μ fd. 400-volt tubular condenser.
- C₂—8- μ fd. 500-volt electrolytic.
- C₃—25- μ fd. 25-volt electrolytic.
- R₁—500,000-ohm volume control.
- R₂—10,000-ohm 1-watt fixed resistor.
- R₃—100,000-ohm 1-watt.
- R₄—500,000-ohm 1-watt.
- R₅—50,000-ohm 1-watt.
- R₆—125-ohm wire-wound resistor to carry 150 ma.

of communications type receiver. But the much-neglected YF has to be content with a 1928 model Majestic, or maybe twenty-five dollars worth of tinny midget.

Which is all very well in its way, and likely to be one of the permanent features of ham radio.

*Technical Editor, *Wireless Weekly*, Sydney, N.S.W., Australia.

desired, along with a particularly low hum level, even with limited filtering—and all at the cost of about a dollar's worth of parts.

The introduction of the new Type 6L6 "beam tube" means that it is easy to get 14 watts of output with 2 percent total harmonic distortion. All that is then needed is the right kind of input for the amplifier, the right kind of speaker to handle the output and shatter-proof glass in the windows of the room in which it is going to be operated.

The actual construction of the amplifier itself is simple—just a couple of hours entertainment for even a novice. We trust that there is no need to go into detail or to give any instructions such as, "take the tip of a hot soldering iron between the thumb and forefinger of the right hand." Layout is quite unimportant, since there are no

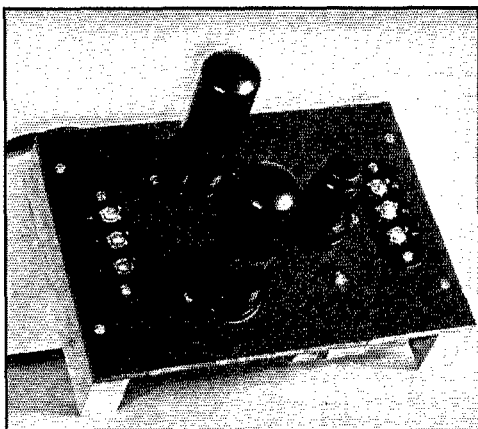

THREE TUBES AND NOT MUCH ELSE CONSTITUTE THE MAKE-UP OF THE HIGH-GAIN HIGH-FIDELITY AMPLIFIER

Input from a crystal pick-up will drive it to its full 14-watt output.

by taking a reading across the 125-ohm resistor. It should be about 16 volts if the plate voltage is 250 volts, measured from plate to cathode on either 6L6.

To those who are accustomed to working on ordinary amplifiers there is another detail about this circuit which is rather different from the usual run. This is in the matter of the input circuit, which is above ground, neither side being returned to B-negative. When using a crystal pick-up this is not even an inconvenience; but it

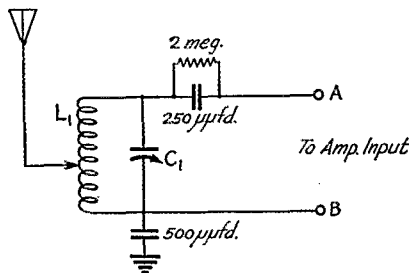

FIG. 3—A SIMPLE TUNER CIRCUIT FOR LOCAL RECEPTION

To tune the range 540 to 1500 kc. with a 350- μ fd. tuning condenser (C_1), the coil L_1 should have inductance of approximately 350 microhenrys (95 turns of No. 22 d.s.c. wire on a 2-inch diameter former, winding length $2\frac{1}{2}$ inches).

becomes necessary to earth the B-negative in order to eliminate a little sizzly hum which is otherwise likely to be in evidence.

RECORD REPRODUCTION

The first problem is to get a satisfactory signal input. A crystal pick-up, operating on a modern recording, will be fairly OK for a start. Two points need to be carefully watched, however.

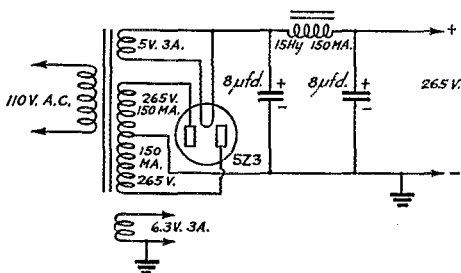

FIG. 2—CIRCUIT OF THE POWER-SUPPLY UNIT

audio transformers to pick up hum by induction. The main idea will be to get the sockets spaced so that the coupling condensers and various resistors will drop into place and hang by their own pigtails.

The power supply required is also of simple specification, as shown in Fig. 2; but again there is a point, fairly hard to detect but very critical in effect. Unless the voltage regulation is good the tonal quality will suffer. Use a big power transformer with plenty of core, and a choke with heavy gauge wire. Pay particular care to get good filter condensers. If in doubt, see if you can find a couple of good paper condensers of 4- μ fd. capacity and ample voltage rating, and use these instead of the more usual electrolytics.

Another big advantage of the amplifier is the way in which voltages can be checked to prove correct operation. Using an ordinary thousand-ohm-per-volt d.c. voltmeter (0-1 ma. meter), the first check is across the two 100,000-ohm load resistors. Both readings should be exactly the same, and about 60 volts. The reading across the 50,000-ohm resistor should be one-tenth; that is, about 6 volts. Also try for a reading across the two half-meg. grid leaks—and hope that you won't find one. There should never be any current through either of these, not even when the amplifier is running full out (if you can stand it that way). The bias of the output tubes can be checked

The first is the torque of the motor. Unless the motor has powerful torque and runs at exactly 78 revolutions per minute it is quite impossible for overall results to be satisfactory. The use of a stroboscope will tell if the speed is right, but unfortunately will not readily indicate any slowing

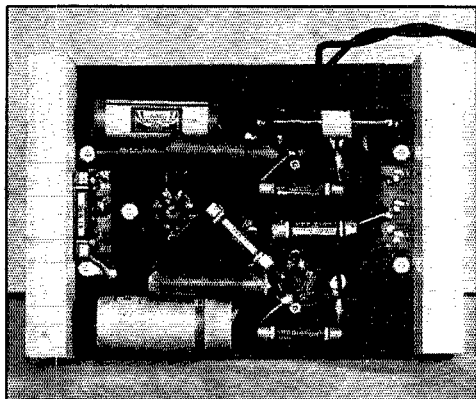

INEXPENSIVE RESISTORS AND CONDENSERS DO THE JOB UNDERNEATH THE BASE

up which may occur when dragging on low notes with a motor having insufficient torque. The next important point about the use of a crystal pick-up is the question of the impedance of the input circuit. The pick-up should feed into a load of not less than 500,000 ohms. If a volume control is used in parallel with a grid resistor, the effective resistance must be at least 500,000 ohms. Normally a simple volume control will be used; but we mention this point in case anybody builds up this amplifier, finds it desirable to maintain a grid return for the first valve, or perhaps fits a tuner

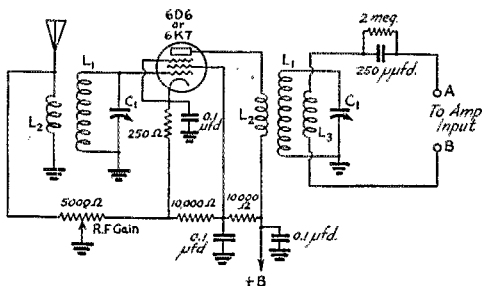

FIG. 4—A ONE-STAGE TUNER FOR BETTER LOCAL-STATION SELECTIVITY

With 350- μ fd. tuning condensers (C_1), coils L_1 would be the same as in Fig. 3. Primary windings L_2 may be 20 to 30 turns wound at the ground ends of secondaries L_1 , while L_3 may be 100 turns or so wound on a former to slide inside L_1 of the second transformer.

across the input. In all such cases the matter of the impedance must be taken into consideration.

The loud-speaker problem is readily solved, for all that is necessary is one of the modern "high-

fidelity" types, such as A12, G12, etc. But the speaker field must be adequately energized and must have ample baffling. It is suggested that great care be taken to see that the speaker gets an effective 15 watts in the field and that a baffle board three to four feet square be used. It may also be worth mentioning that it is useless to expect good results unless the acoustic properties of the room are suitable. Generally speaking it will be found that the usual room, with a carpet on the floor, will work out pretty well. On the other hand, unnatural brilliance, with ear-tearing highs and distressing reflections, will result if the amplifier is used in a bare workshop. Small bare rooms are useful only if it is desired to retain brilliance at low volume levels.

RADIO INPUT

Having once heard the amplifier in operation on a modern recording, the builder will immediately want to hitch it up to some radio tuner in order to get the full benefit of the high-quality broadcast transmissions. This can be readily arranged, but not quite as easily as may be expected.

In some cases where there may be a local 50-kilowatt within a few miles, and if programs from this single station are going to fill the bill, a simple single-circuit tuner can be fitted as suggested in Fig. 3. The incidental non-linearity of

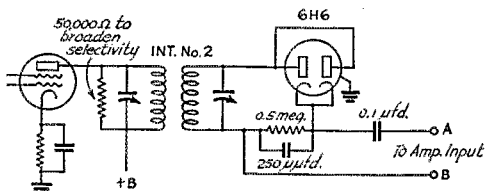

FIG. 5—DIODE DETECTOR CIRCUIT OF A TYPICAL SUPERHET ADAPTED TO FEED THE HIGH-FIDELITY AMPLIFIER

the first stage is utilized for detection. If there are two or three powerful stations to be separated it may be worth building up a t.r.f. unit of one or two stages, as suggested in Fig. 4. The tuner of a midget superhet can also be used, as suggested in Fig. 5; but in most cases it will be found that as soon as a superhet tuner of even moderate selectivity is added, the brilliance of the highs will be lost and the broadcast program will not sound as good as reproduction of a recording. To help out in such a case it may be found advisable to shunt a 50,000-ohm resistor across the primary of the second intermediate transformer, from plate of the intermediate amplifier to B-plus. This should help flatten out the intermediate selectivity a little. The actual diode circuit will need to be modified to conform with

(Continued on page 80)

A New Type of Unguyed "Sky-Hook" for Amateur Antennas

General Features of the Free-Standing Triangular Wooden Tower at W3ZD

By Frank P. Cartwright*

The simple "2-by-2" or "A"-type guyed wooden mast originally described in September 1932 QST (and shown in subsequent editions of the A.R.R.L. Handbook) has become practically standard as the sky-hook for supporting amateur antennas at heights up to 40 feet; but there has been no such standardization in structurally proper wooden towers, least of all in self-supporting types running to 70-foot and greater heights. It is true enough that a variety of "lattice" towers have been built by amateurs and described in QST. But it must be admitted that a generally satisfactory structural design has not been supplied. In this article the author introduces a new type of construction which may well fill this long felt need and develop into a state of standardization for amateur use. Since the final design must be influenced by height, suggestions from interested amateurs will be helpful in arriving at two or three typical designs which will meet general requirements for horizontal and vertical antennas. Letters of suggestion concerning heights and other factors may be addressed to QST.—EDITOR.

ABOUT the time WRVA built its 326-foot all-wood tower at Richmond, Virginia, Bob Eubank, W3AAJ, transmitter chief of the station, suggested to the writer that such a tower, developed in miniature and economically designed to meet the antenna pull and wind pressure conditions, would fill a long felt need in the amateur field. Many other commitments, however, prevented following up the matter until February of this year, when W3ZD's 88-foot tower blew down in a high wind, and H. Clay Thompson of Chevy Chase, Maryland, undertook to build Roy Corderman a more substantial one from the writer's design.

The reasons soon became apparent why little progress has been made to date in developing light wood towers for amateur station purposes, or that the towers built here and there have not proved uniformly satisfactory from the structural viewpoint. W3ZD specified that his new tower, to be thoroughly effective from a radio viewpoint, must be free-standing (without guys), and not less than 70 feet in height. We soon found that the design of such a tower, which would be not merely a makeshift but which would be permanently adequate to the requirements and at the same time within the reach of the amateur's pocketbook, was no small problem. The selection of sizes to meet the loads, the detailing of connections which would realize the full strength of the members, the selection of suitable and economical hardware items obtainable as far as

* Structural Engineer, 47 West Lenox St., Chevy Chase, Md.

possible from customary stocks, and the workmanship required to combine these items into a complete and permanent structure, involve almost as much detail, investigation and special experience as the design and erection of the WRVA tower. Numerous improvements on the first design suggested themselves during the fabrication and erection of W3ZD.

It may be a surprise to many amateurs to learn how much pressure the wind can exert on a tower and antenna, even though of no great height. The

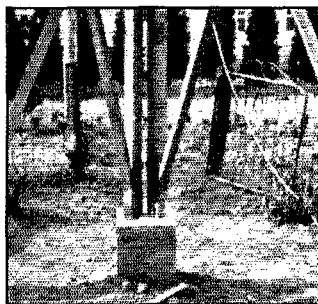
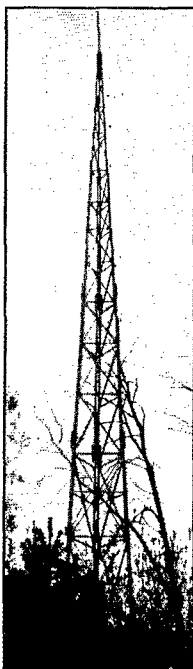

THE THREE FEET OF THE TOWER ARE ANCHORED TO CONCRETE PIERS

gradient or pervading velocity of the wind increases steadily from a minimum near the ground surface up to heights of several hundred feet, but due to peculiar local conditions such as the slope of the ground or the relative positions of nearby buildings or trees, the wind pressure here and there close to the earth's surface may be as great or greater than far up in the air. The opinion is spreading among engineers, due both to added

research in this field and to rather numerous failures of radio broadcasting towers in recent months, that these structures should be designed for greater wind pressures than have been assumed in the past. Corresponding care should be

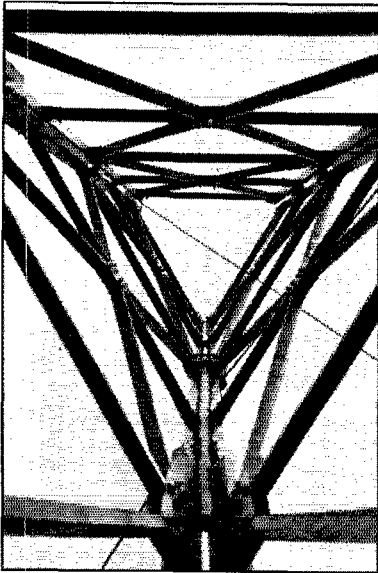

INTERNAL VIEW FROM THE GROUND
WITH THE LOWER HALF ERECTED

taken to strengthen the smaller towers used by amateurs.

The tower designed and erected for W3ZD was of the same three-cornered type used at WRVA. As compared to a square tower, the triangular type saves about 25% on lumber, fitting and foundations, presents less resistance to the wind and requires fewer sizes and lengths of pieces. It also is not affected adversely if one of the foundations settles slightly or is heaved by frost out of level with the other two piers. This method of tower construction is patented and has been used by the U. S. Government for forest lookout towers in the Pacific Northwest.

The material used for the W3ZD tower was dense, longleaf, all-heart Southern yellow pine, though the plans were so made that any one of several other species also could have been used. It was painted with one coat of aluminum and one coat of grey concrete paint. All connections were made with bolts, except for a few points near the bottom of the tower, where timber connectors of the type employed in the WRVA tower were used for leg splices. Steel gusset plates

¹ *The Bearing Strength of Wood Under Bolts*, Misc. Publication No. 332, U. S. Dept. of Agriculture; *Wood Handbook*, by the Forest Products Laboratory, U. S. Dept. of Agriculture. Both available from Superintendent of Documents, Washington, D. C., price 5 cents each. (Postage stamps not accepted.)

were used for web member connections but the leg splices were made with wood.

Such a tower, economically designed, requires about 200 feet of lumber, weighing from 400 to 600 pounds, and about forty pounds of bolts and fittings. The footings have to be designed against uplift due to the overturning moment of the wind, and require about one-third cubic yard of concrete for each corner or leg of the tower.

Two alternative methods by which amateurs could avail themselves generally of the advantages of a free-standing tower of this economical type are suggested.

1. A complete set of plans and templates could be provided by which the owner could lay out his own tower members using lumber purchased from local retailers, the builder shearing and drilling his own fittings; or the plans might be accompanied with sets of sheet metal fittings, bolts, and other hardware ready for use.

2. The members and fitting of a complete tower, manufactured at some central point, could be shipped knockdown with directions for foundations and erection.

The former method affords the amateur desiring a wood tower greater opportunity to utilize his own time and energy. It requires considerable care and skill to secure a satisfactory, permanent structure, but is quite feasible if the builder is willing to take the necessary pains.

The small sizes of lumber required for an economical structure are in many cases not stock or standard sizes available from ordinary lumber yards. They have to be ripped from clear stock of larger sizes and care must be taken that the resulting small pieces show no serious cross-grain due to defects which are not important in the larger piece but may seriously weaken the small section. For this work a small $\frac{1}{4}$ - to $\frac{1}{2}$ -h.p. bandsaw is preferable to the big circulars at the lumber yard, which often seem to take about as much wood out in saw kerf as they deliver in the desired sizes.

The builder would have to be sure that the lumber was all heartwood, of one of the more durable species, unless he should be in position to have the members pressure treated with a preservative after they are cut to length and bored for fittings, before the tower is erected. The heartwood of trees is much more resistant to decay than the sapwood and, except perhaps in the extreme northern parts of the country, should always be used for towers unless preservative treatment is employed.

Sheet steel fittings should be galvanized. The holding power or load capacity of screws and bolts of different sizes in wood of different species is available in recent publications of the U. S. Forest Products Laboratory.¹ Their bearing capacity in sheet steel of various gages is less well known. The writer secured his information from the American Rolling Mills Company.

Another Crack at Background Noise in C.W. Reception

Class-C Audio System for Reducing Interference

By N. Bishop,* W1EYM

AT THE recent Connecticut State A. R. R. L. Convention in Bridgeport, I had the pleasure of hearing Jim Lamb describe his development work on noise silencer and diversity reception circuits. One of his remarks prompts me to cast aside my cloak of silence and describe a paper which I read before the Yale Radio Club in New Haven on February 1, 1933.

Mr. Lamb's remark was to the effect that the c.w. telegraph selectivity obtainable by making use of a crystal filter in the i.f. circuit of a super-heterodyne receiver could be made so high that any attempt to increase the circuit selectivity further would fill in the intervals between the dots and dashes and make them indistinguishable because of the reduction of the sidebands necessary for the formation of readable characters. Some development work carried on by me in 1932 opened up new possibilities in the beat-note reception of c.w. telegraph signals under such conditions of high selectivity.

The circuit to be described accomplishes the following results:

1. For a given speed of transmission it permits tremendous increase in the allowable selectivity without loss of intelligibility.

2. If the beat-note level is above the existing noise level, it will eliminate all noise between the dots and dashes.

3. Intelligible aural reception up to forty words per minute or more can be obtained through a circuit so selective that only the most stable transmitters will stay in the acceptance band for the duration of a dash or dot.

It would be well at this point to state the premise on which the circuit was developed. The only condition which must be fulfilled for the reproduction of aurally intelligible telegraph signals is that it must be possible to distinguish dots, dashes, and spaces. In other words, we can distort the original signal in any way to our liking as long as the above conditions are fulfilled. In order to illustrate the theory behind the operation of this circuit, let us consider a stable transmitter sending a series of dots at a rate equivalent to forty words per minute. If this signal is fed through an extremely selective receiver, which may have a crystal filter in the i.f. circuit and a sharp audio filter in the a.f. system, we might expect to see the changes shown in Fig. 1.

* Round Hill Road, Fairfield, Conn.

In Fig. 1-C, the percentage modulation has been so reduced as to render copying impossible. But now let us take the signal shown at C and distort it in such a way as to restore the normal percentage of modulation. As shown in D, by applying this signal to a Class-C audio amplifier with adjustable bias we may restore the depth of

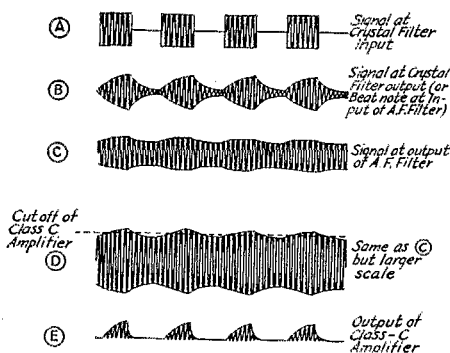

FIG. 1

modulation at the expense of the length of the dots and dashes.

We now have the dots with nothing between them, unless the peak noise voltage at the output of the filter exceeds the peak value of the signal; in other words, clear dots and no background. The peak value of the noise may be made less than that of the signal in the i.f. system by the Lamb silencer, or limited in the output by using very low plate voltage on the Class-C audio amplifier (i.e., just enough to give comfortable volume). The higher the signal level applied to the Class-C amplifier input, the simpler the adjustment of the cut-off bias, since the voltage increment of the bias adjustment is fixed by the potentiometer control.

Fig. 2 illustrates a simple circuit using readily available parts with which this system may be used on any stable receiver equipped with a separate beat oscillator and an audio power stage. The choice of a resonant frequency for the audio-frequency filter depends on several factors. If cost is no consideration, a multi-section 1000-cycle filter would be ideal; but not many amateurs will have the necessary components available for its construction. Assuming that the filter will be

limited to a single section, the choice of a relatively low frequency simplifies the problem of getting a narrow band-pass in terms of cycles band-width. One successful filter used in the demonstration at New Haven in 1933 was resonant at 250 cycles. This may seem rather low for copying, but it must be remembered that the Class-C amplifier output contains strong harmonics which give a pleasing tone. The resonant circuit is very loosely coupled to the power stage so that it will not be loaded by the plate resistance.

A check of the circuit shows that a high negative grid bias is supplied by biasing the cathode positive with respect to ground. Low plate voltage is obtained from the voltage divider R_3 - R_4 . C_4

a c.w. signal is tuned in, the bias may be increased until no sound exists between the dots and dashes. Of course, if the noise level is as high as the signal level, it will be impossible to leave the spaces clean. If, however, the signal exceeds the noise by only a small amount, the background may be completely eliminated.

For best operation of such a device two conditions must exist. The incoming signal must be stable in frequency and amplitude. If the frequency varies, selectivity will have to be sacrificed in order to hold the signal. The incoming signal must be stable in amplitude as far as the level of the beat note is concerned. Some a.v.c. helps this situation. If, however, the Class-C stage is operating so that the dots and dashes are just shoving their heads up above the threshold and the signal fades out, nothing will be heard.

It is rather difficult to cover the whole subject of selectivity in a small amount of time. I should like to say, however, that all these methods of getting selectivity after a conversion process are definitely not the final answer (referring to i.f. selectivity after conversion and a.f. selectivity after the second detector or again after a second converter).

The ideal receiver would consist of pick-up, selectivity, amplification and detection in the order named. One general rule must be remembered and that is that selectivity is no good to anybody if it occurs after an early stage has been rendered inoperative by a strong interfering signal.

The circuit as described may be used without the audio filter if the individual feels that his crystal i.f. filter provides ample selectivity for most signals. It will then allow him to eliminate noise between the desired-signal dots and dashes so long as the noise level is below the signal level. It's easier to copy when the spaces are clean and a trial should be ample proof.

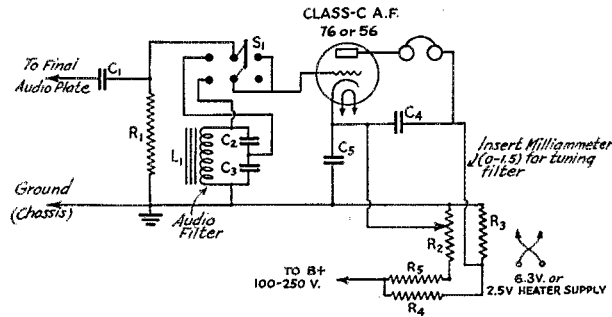

FIG. 2—CIRCUIT OF THE AUDIO FILTER AND CLASS-C AMPLIFIER

- C_1 —1- μ f.d. paper blocking condenser.
- C_2 —0.01- μ f.d. filter tuning condenser, paper or mica. (Depends on L_1 .)
- C_3 —1 to 4- μ f.d. filter coupling condenser, paper. (Depends on L_1 .)
- C_4 —1- μ f.d. a.f. by-pass, paper.
- C_5 —1- μ f.d. cathode by-pass, paper.
- R_1 —100,000-ohm, 1-watt.
- R_2 —25,000-ohm, wire-wound potentiometer.
- R_3 —5000-ohm, 2-watt.
- R_4 —50,000-ohm, 2-watt.
- R_5 —25,000-ohm, 2-watt.
- L_1 —Inductance which with C_2 will resonate at 250 cycles (1.5-henry choke).
- S_1 —D.b.d.t. switch to cut out audio filter.

provides a low impedance path around the bias and plate voltage supplies for the audio frequencies in the plate circuit.

The filter may be adjusted best by tuning the receiver to some steady carrier, say on the broadcast band. The bias on the Class-C stage is reduced until it is above cut-off. The resonant frequency may be judged as the beat-note adjustment which gives the loudest signal in the 'phones. Various values of C_2 and C_3 may be tried until the selectivity is a maximum. A small milliammeter in series with the 'phones provides an excellent means for plotting selectivity curves; that is, meter reading versus beat-note control dial setting.

Increasing C_3 will reduce the coupling between the power stage and the filter and hence give a sharper response curve. Incidentally, the tuning of a receiver so equipped is so sharp that a smooth vernier beat note adjustment is essential. After

Straits

Meter-Type Modulation Monitor

In the meter-type modulation monitor described by D. C. Summerford in May, 1936, *QST*, the tube should be connected as a diode rather than as a triode. That is, the grid and plate should be connected together in the diagram of Fig. 1, everything else remaining "as is."

In the 6L6 story in June *QST*, Fig. 4, the plate transformer was erroneously listed. The correct number is T-5303.

Shall we have another Field Day in late August or early September? Drop us a QSL card *at once* if you would like another F.D. this summer.

A High-Power Three-Stage C.W. Transmitter With Beam-Power Crystal Control

By Frank W. Edmonds,* W2DIY

SINCE the advent of the new beam power tube, known as the 6L6, there has been considerable interest shown in the possibilities of its use in r.f. circuits. Because of the good efficiency of this tube as an oscillator, and its higher power output capabilities, it seemed desirable to put it to work in a high-power c.w. transmitter.

Operating the 6L6 as a crystal oscillator with 400 volts on the plate, with a power output of over 30 watts, it is possible to drive a rather large

involved. With sufficient output from the oscillator and with the new crystals now available there is really no necessity for use of transmitters with more than three stages for usual c.w. use.

In order to construct a three-stage transmitter which will perform satisfactorily at high power levels on all of the commonly used amateur bands, starting out with an oscillator having sufficient power output, it is advisable to select tubes for the other two stages which have not only low

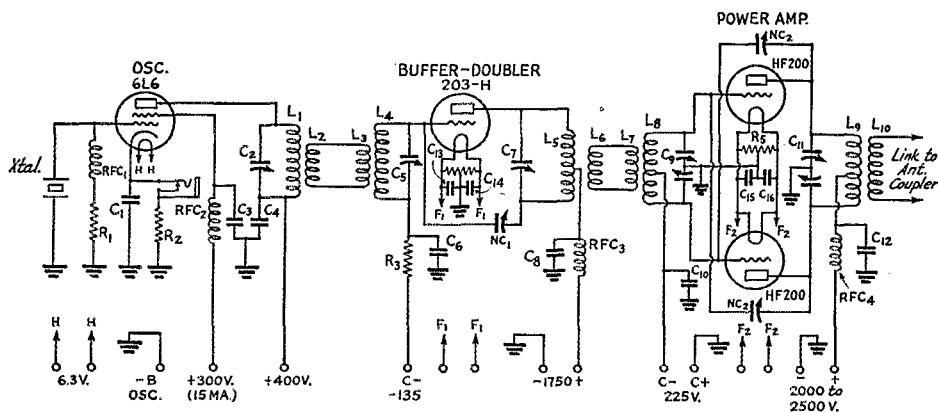

FIG. 1—CIRCUIT OF THE HIGH-POWER TRANSMITTER

- L₁ to L₁₀—Coils to suit frequency combination (See A.R.R.L. Handbook.)
 C₁—0.01- μ f. 2000-v. oil, tubular.
 C₂—100 μ f. (Cardwell MT 100 GS).
 C₃—0.01- μ f. 2000-v. oil, tubular.
 C₄—0.01- μ f. 2000-v. oil, tubular.
 C₅—100 μ f. (Cardwell MT 100 GS).
 C₆—0.002- μ f. 5000-v., mica.
 C₇—110 μ f. (Cardwell XG 110 KS).
 C₈—0.002- μ f. 5000-v., mica.
 C₉—100 μ f. per sec. (Cardwell MT 100 GD).
 C₁₀—0.002- μ f. 5000-v., mica.
 C₁₁—160 μ f. per sec. (Cardwell TC 160 UD).
 C₁₂—0.002- μ f. 5000-v., mica.
 C₁₃, C₁₄—0.01- μ f. 2000-v. oil, tubular.
 C₁₅, C₁₆—0.01- μ f. 2000-v. oil, tubular.
 RFC₁, RFC₂—125 ma. 2.5 mh. (Hammarlund).
 RFC₃, RFC₄—500 ma. 2.5 mh. (Hammarlund).
 NC₁—(Cardwell) NA14NS.
 NC₂—NA 14 NS (Cardwell).

tube as a doubler to excite a 1-kw. final amplifier. In this manner we can cut down on the number of stages necessary in a high-power transmitter. No one needs to be told that the simpler the design of a transmitter, or any piece of apparatus, the less chance of trouble in its operation. Those who have labored over a multi-stage transmitter with a flock of doublers and low-power amplifiers in an almost vain attempt to get sufficient excitation for the final high-power stage will appreciate the advantages of reliability and ease of operation of a transmitter with fewer stages, aside from the saving in the cost of apparatus

interelectrode capacities but also high efficiency and low excitation requirements. As shown in the photograph and diagrammed in Fig. 1, the combination selected for this particular transmitter was a 6L6 crystal oscillator, an Amperex 203-H buffer-doubler and, for the final, a pair of HF-200's. Other combinations will no doubt work equally well, provided the characteristics are such as to meet the above requirements.

The 203-H, which is a 203 type of tube with the plate lead brought out on top of the envelope, thus reducing the interelectrode capacities and raising the permissible plate voltage, is quite easily driven, even at 14 mc. The power output from this stage when doubling is adequate for ex-

* Engineering Dept., United Transformer Corporation, 72-78 Spring St., New York City.

citation of the push-pull HF-200's used in the final. Link coupling was used throughout in order to provide maximum efficiency in coupling and to improve the flexibility of the transmitter. The antenna tuning system is not shown in the photo since this was located some distance away and link-coupled to the final plate tank. The entire

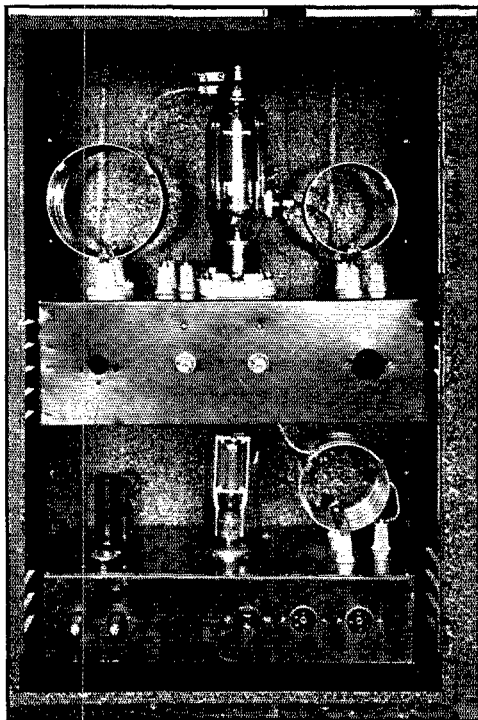

REAR VIEW OF THE 3-STAGE 1-KW. INPUT TRANSMITTER

r.f. section is built up on two decks with the condensers mounted below deck to provide the shortest possible leads, and to conserve space. These two units fit very nicely into a 30-inch cabinet or rack. Another 30-inch cabinet or rack takes care of the two plate supplies and the bias supply.

Now let's look at the back view of the transmitter and consider it step by step. In the lower left-hand corner is the 6L6 with its associated crystal and tank coil. The screen of the 6L6 is fed from a tap on the power supply bleeder, both to provide oscillator keying and to prevent power output fluctuations due to changing screen voltage. The power supply for the oscillator should have a capacity of between 150 and 200 ma. in order to obtain good efficiency from the 6L6 oscillator. It is wise to put a milliammeter in the screen lead when first setting up the oscillator and to adjust the screen potential to a value such

that the screen current does not exceed 15 ma. since drawing too much screen current may cause disintegration of the cathode. Both metal shell and glass types of the 6L6 were tried in this setup and with the shell floating on the metal variety there was found to be little or no difference in performance between the two. The tank coils should have as large a ratio of L to C as will permit tuning across the band selected, in order to provide a maximum voltage swing for the grid of the succeeding tube. The ground returns for each stage should be brought back direct to the cathode or filament center tap ground. A value of 10,000 ohms was found to give best results as a grid leak for the crystal oscillator. Fixed bias was used on the buffer and final stages. Incidentally, the transformer used for the bias supply should be capable of considerable current drain so that the bleeder may have a low resistance; otherwise the bias voltage is likely to vary considerably under keying conditions. It is far cheaper, in the long run, to invest in a good husky bias supply than to use batteries, which, incidentally, have a nice habit of charging up, due

(Continued on page 78)



DIXIE JONES' OWL JUICE

HAMS that ain't had no bringin' up and hafto sorta git what polish they git as they go along are cautioned that whereas it useto be the proper caper to curl up the little finger into a knot like a grub worm when guzzling a dish of tea in an assemblage of strange and uppity white folks, it is now very de trop to follow such a procedure and it ain't bein' done no more except by guys whitch don't know no better whitch is why I am tellin' you. It is very disencouraging for a guy that's just began to git his little finger so it will kink some and then hafto stop doin' it, but that's the edict. Nowdays when your hostess shoves a mug of beverage at you wye you just grab it natural and let the little finger take part or trail off according to whether what she hands you is hot or not. Also when you're walking along with a dame that thinks she amounts to sumpn and you come to a pebble in the road and you wanta help her over it as she is a frail thing only 18 years old and big as a small horse and you couldn't kill her with a club wye instead a grabbing her by the arm like you was starting in to choke a cat you let her clamber over this here obstruction by herself. The new regs don't require you to give no dames a boost unless they date back and are sorta wobbly on their pins. Shucks. I wisht they'd let things alone so when you learnt sumpn it would stay learnt.

—W4IR of the "Dixie Squinch Owl"

HINTS and KINKS for the Experimenter



A Simple and Inexpensive QRP Transmitter

WE ALL realize that a large part of the QRM on amateur bands is caused by the use of high-power transmitters for local and other short-distance communication. The average amateur, however, is not financially able to put more than a few dollars into an auxiliary transmitter; he always needs every dollar he can spare for

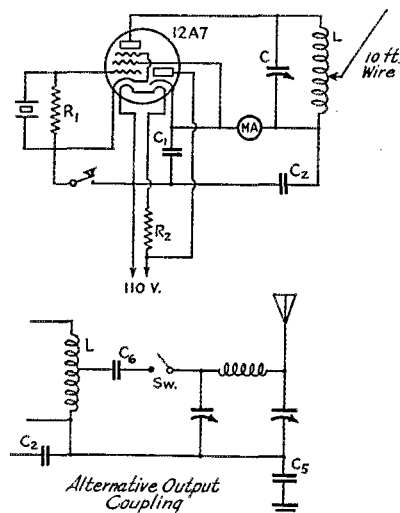

FIG. 1—SIMPLE AND COMPLETE ONE-TUBE TRANSMITTER FOR LOCAL OR PORTABLE WORK

R_1 —25,000 ohms.
 R_2 —350 ohms, 50-watt (line cord).
 C_1 —24- μ fd. electrolytic, 200-volt or higher rating.
 C_2 —0.002 μ fd.
 C_3, C_4 —500- μ fd. variable.
 C_5, C_6 —0.002 μ fd.

Plate tank circuit, LC, has usual constants for frequency of crystal employed. The inductance in the pi-section coupler shown as an alternative output circuit likewise should be adjusted for the frequency and type of antenna used. This coil may be provided with taps.

improvements on his main rig. There is one way, however, in which a very inexpensive low-power set suitable for short-distance communication can be built in a few minutes' time. It requires no additional power supply; only the key, crystal and antenna from the main transmitter.

I have built two such transmitters, using the circuits in Fig. 1, and have had very pleasing results with them. Using the simpler antenna system, I contacted a station 407 miles away and received an RST349X report; this was done

merely by answering his CQ, not by the usual "low-power" method of contacting a station on high power and then shifting the crystal to a flea-power transmitter.

—Carl C. Drumeller, W9EHC

For the benefit of those not familiar with the 12A7, the tube consists of a pentode and power rectifier, with separate cathodes, in one bulb. W9EHC's circuit uses the rectifier to convert the 110 a.c. to half-wave d.c., the filter being condenser C_1 . The r.f. part of the circuit is the familiar pentode crystal oscillator. A line cord with built-in 350-ohm resistor drops the 110 volts to the proper value for the heater of the 12A7.

—EDITOR.

Changing Antenna Directivity

SEVERAL times in the past I have noted in *QST* various methods of switching a full-wave center-fed antenna so as to change the directional properties by feeding the two sections of the antenna so that they are either in or out of phase.

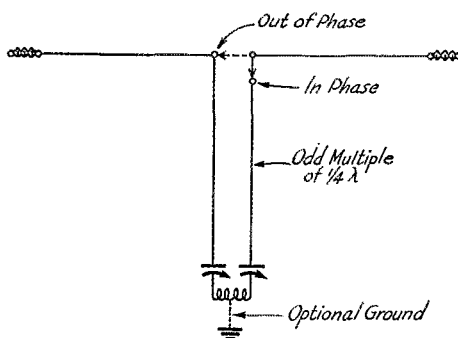

FIG. 2—SUGGESTED SWITCHING ARRANGEMENT FOR CHANGING ANTENNA RADIATION PATTERN

W3AKU gave some very good connections for accomplishing this in November, 1935, *QST*; however, they have their objections in that with one system the feeders radiate and with the other three feed wires are required.

For several months I have been using at W5EBP on the 20-meter band a system of feeding the two ends of the antenna out of phase, without radiation from the feeders, with series tuning at the transmitter, and with two feed wires. The ar-

rangement is shown in Fig. 2. Although I do not switch from in- to out-of-phase, this could be done very simply with a pull-cord switch at the junction of the feeders and the antenna.

—M. H. Lovelady, W5EBP

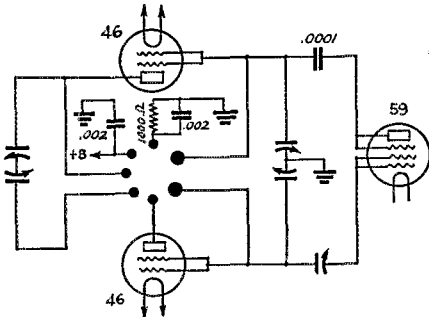

FIG. 3—CIRCUIT FOR CHANGING FROM INDUCTIVELY-NEUTRALIZED STRAIGHT AMPLIFICATION TO BACK-TO-BACK DOUBLING BY PLUGGING IN APPROPRIATE COILS

The "top" and "bot." refer to the positions of the ends of the windings on the coil form.

Adapting Inductive Neutralization to the Low-Power Transmitter

INDUCTIVE neutralization of triode r.f. amplifiers has recently come into use in commercially-manufactured transmitters.¹ A trial of this method has convinced me that it can be easily and

Below are coil specifications for the three main bands, using 100–100 μ fd. split-stator tank condensers in both buffer and final stages.

All coils are wound on ribbed ceramic forms which plug into a small 7-prong socket. For straight amplification the two windings are wound in opposite directions and for doubling they are wound in the same direction. After the coils are wound some adjustment of the spacing between windings is usually necessary to obtain perfect neutralization, and when the correct position is found the windings should be fastened in place with coil dope.

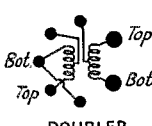
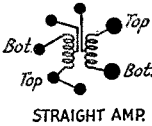

Coupling to the antenna tuner may be by means of a small coil wound on celluloid and placed so that it slips inside the amplifier tank coil when the form is plugged into its socket. One or two turns wound directly over the amplifier tank coil, terminating in flexible leads fitted with G.R. plugs, may also be used.

Estimated outputs, using an 80-meter crystal, range from about 20 watts when doubling to 20 meters in the final stage, up to nearly 50 watts on both the 40- and 80-meter bands. The use of this scheme results in a saving of several pieces of apparatus with their attendant losses and space requirements. It also allows optional doubling in a push-pull stage and facilitates band changing.

—O. K. Blackburn, W9MB

Band	Dia. of Form	Space Between Windings	Size of Wire	No. of Turns	Length of Winding
14,000..... Doublor	1 3/4"	5/16"	Bfr. Pl. 18 d.c.c. Amp. Pl. 18 d.c.c.	14 10	3/4" 1 1/4"
14,000..... Str. Amp.	1 3/4"	11/16"	Bfr. Pl. 18 d.c.c. Amp. Pl. 18 d.c.c.	7 10	3/8" 1 1/4"
7000..... Str. Amp.	1 3/4"	7/8"	Bfr. Pl. 18 d.c.c. Amp. Pl. 18 d.c.c.	14 15	3/4" 13/16"
3500..... Str. Amp.	2 1/4"	1 3/8"	Bfr. Pl. 22 d.c.c. Amp. Pl. 18 d.c.c.	21 29	11/16" 1 1/8"

profitably adapted to apparatus of the home-grown variety.

Following are some details of its use in the final stage of a portable rig consisting of 59 Tritet, 59 neutralized buffer and two 46's as either push-pull straight amplifier or back-to-back doublers. The plate coils of the last two stages are both wound on the same 7-prong coil form. The diagram, Fig. 3, shows the connections for straight amplification and for doubling. Direct coupling between buffer tank and amplifier grids may be unorthodox, but it works and has the advantage of simplicity.

¹ See Craft and Collins, "Inductive Neutralization of R.F. Amplifiers," this issue.

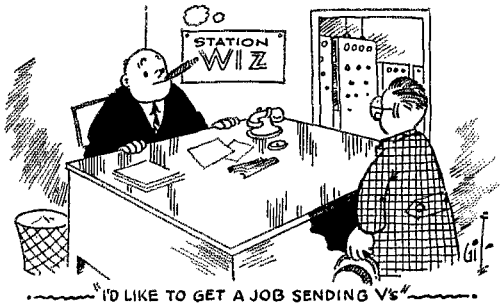



Amateur Radio STATIONS

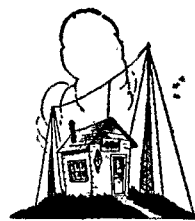

W8ACY, Rochester, New York

UNLESS there has been a change in QRA since the accompanying photo was taken, W8ACY is located at 36 Earl Street, Rochester, New York. Frequent changes in location since 1929 have caused the transmitter to be developed into a semi-portable affair. Bruce Kelley, the owner, has only one object in amateur radio—low-power 14-mc. DX. Considering the fact that the station is set up in a new location on the average of every six months, quite remarkable work has been accomplished. The original transmitter consisted of a single 45 in a series-fed Hartley with approximately three watts output. All continents except Asia were contacted with this layout.

In 1935 a more modern transmitter was constructed using a 59 Tri-tet oscillator, 46 doubler, and a single 210 final with an output in the vicinity of ten watts. A single wire about 100 feet long, without feeder, is directly-coupled to the tank through a Collins network. Two power supplies are used, each with an 83 tube. Occasionally grid-

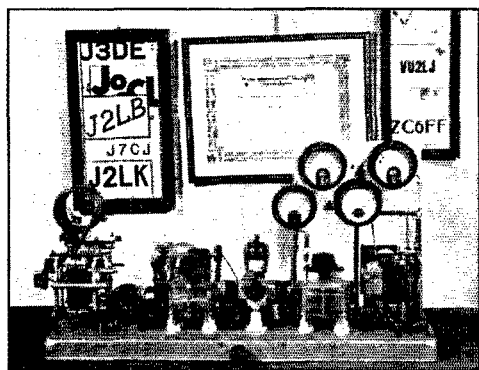

W8ACY

bias modulation is used for 'phone work. The receiver has always been the DX'ers standby type, consisting of a 24 detector and a 2A5 audio. With this transmitter WAC has been made innumerable times and the operator is looking for the 70th country. Besides low-power DX, considerable interest is shown in photo collecting. Photos have been swapped with stations in all continents. A similar transmitter under the call W2ICE is also used at another location. This station is also WAC.

W5VU, Dallas, Texas

STATION W5VU is located at 5712½ Marquita Avenue in the northern outskirts of Dallas, Texas, and is owned by Durward J. Tucker.

The layout shown in the photograph is the latest version of that endless circle from the shack to

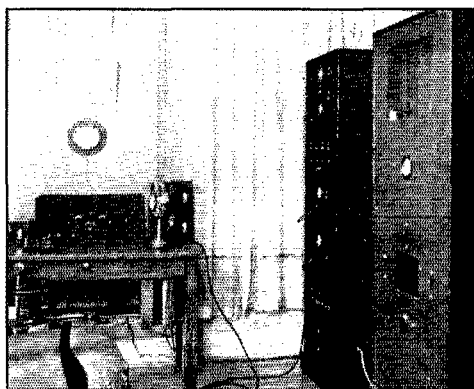

W5VU

the ham store that started with spark gadgets back in 1919.

Each of the two transmitter cabinets houses a complete transmitter. The large cabinet contains the crystal-lock 40-meter transmitter described in June 1934 *QST*. However, since the publication of the dope on this transmitter in *QST* another 212-D has been added to the final amplifier and the whole layout has been revamped and changed from breadboard to cabinet style. The complete transmitter layout consists of an eighty-meter crystal oscillator using a UX-112 tube, a 46 doubler, and two W.E. 212-D's in the final amplifier. The 212-D's are in a push-pull tuned-plate fixed-grid circuit with the grid circuit r.f. voltage in synchronization or locked with the r.f. voltage of the 46 doubler plate circuit. The tremendous ratio of power between the 212-D's and the 46 provides a very economical means of attaining high power, since the two 212-D's normally operate at about 500 or 600 watts input.

The smaller transmitter cabinet contains a transmitter normally operated on 20-meter

(Continued on page 90)

I. A. R. U. NEWS

Devoted to the interests and activities of the

INTERNATIONAL AMATEUR RADIO UNION

Headquarters Society: THE AMERICAN RADIO RELAY LEAGUE, West Hartford, Conn.

MEMBER SOCIETIES

American Radio Relay League
Associazione Radiotecnica Italiana
Canadian Section, A.R.R.L.
Československí Amatéri Vysílací
Deutscher Amateur Sende-und-Empfangs
Dienst
Experimenterende Danske Radioamatører
Irish Radio Transmitters Society
日本アマチュア無線聯盟
Liga Colombiana de Radio Aficionados

Liga Mexicana de Radio Experimentadores
Nederlandse Vereniging voor Internationaal Radioamateurisme
Nederlandsch-Indische Vereniging voor
Internationaal Radioamateurisme
New Zealand Association of Radio Transmitters
Norsk Radio Relæ Liga
Oesterreichischer Versuchssenderverband
Polski Związek Krotkofalowcow

Radio Society of Great Britain
Rede dos Emissores Portugueses
Reseau Belge
Reseau des Emetteurs Francais
South African Radio Relay League
Suomen Radioamatöörlitto r.y.
Sveriges Sändareamatörer
Unión de Radioemisores Españoles
Union Schweiz Kurzwellen Amateurs
Wireless Institute of Australia

Conducted by Byron H. Goodman

Executives:

The A.R.R.L. Board of Directors elected for their new president Dr. Eugene C. Woodruff, W8CMP, of State College, Pa., and for vice-president Mr. George W. Bailey, W1KH, of Weston, Mass. These gentlemen assume similar positions as the new heads of the I.A.R.U. Biographical data on our new officers will be found on page 7.

Reseau Belge:

Mr. Rene Kersse, ON4GW, is the new president of the Reseau Belge, succeeding Paul de Neck, ON4UU, who has headed the society since 1926. Mr. de Neck was accorded the title of honorary president, in recognition of his excellent work. Mr. Paul Antheriens, ON4PA, continues as general secretary, and all correspondence for Reseau Belge should be sent to him at LA PINTE, lez Gande, Belgium.

Regret:

The headquarters society joins with the other member-societies in expressing their sincere sympathy to the J.A.R.L. upon the loss of Kunio Shiba, J2HJ, secretary of the J.A.R.L. Mr. Shiba died in April, after a short illness, and was but 26 years old. Widely known throughout the amateur world for his splendid work on 28-mc. as well as the lower frequencies, his was the first Asian station to work North America and Africa on ten meters.

Denmark:

From an interesting letter from OZ7Z we learn that there are now 240 licensed amateurs in his country, and that the EDR boasts over 400 members. In an effort to gather further data on the 28-mc. band, the EDR is sponsoring a Danish ten-meter test, to be held from May 1st to August 15th.

England:

The Annual Convention of the R.S.G.B. will be held in London from September 3rd to 5th. Foreign amateurs in England at that time should avail themselves of this opportunity to meet many of the English amateurs. Further details can be obtained from the R.S.G.B., 53 Victoria Street, London, S.W. 1.

WAC:

Does DX depend upon location, competition, accessibility of equipment, lack of YL's, etc., or is it simply a measure of the amateur population, of which a certain fixed percentage will always be the DX men? This question has been the subject of many debates in amateur circles and, in an effort to arrive at an answer, the number of WAC certificates awarded to each call area has been compiled. We leave it to you to draw your own conclusions.

Since 1926, when the first WAC was awarded, up to December, 1935, the following certificates have been awarded:



J2HJ

W1: 84 c.w.	W8: 98 c.w.
W2: 80 c.w.	W9: 133 c.w., 1 'phone
W3: 46 c.w., 1 'phone	VE1: 5 c.w.
W4: 37 c.w.	VE2: 8 c.w., 1 'phone
W5: 65 c.w.	VE3: 5 c.w.
W6: 177 c.w.	VE4: 3 c.w.
W7: 32 c.w.	VE5: 4 c.w.

At a later date, the number of certificates awarded to the other countries of the world will be listed. Prepare yourself for a few surprises.

QSL Bureaus:

This column inadvertently erred when it listed

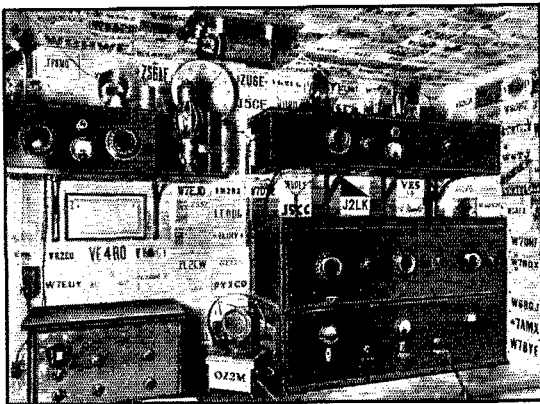

OZ2M, THE FIRST DANISH 28-MC. WAC

Built and operated by K. L. Ewald, of Hobro, OZ2M is well known in the DX world, and was the highest scoring Danish station in the 1936 DX Contest. The crystal-controlled transmitter uses a Marconi T250 in the final amplifier, and a 25-watt modulator stage allows 'phone to be used when the bug bites.

the QSL Bureaus two months ago. Please delete:

British West Indies: Ian C. Morgan, "Southlands," Warwick East, Bermuda.

Dominican Republic: Dr. Enrique de Marchena, Apartado Postal 912, Santo Domingo.

And add the following:

Belgium: Baron Bonaert de la Roche, Chateau de Marchiennes, Harvengt nr Mons.

Bolivia: Henry E. J. Smith, CP1AA, care Standard Oil Company of Bolivia, La Paz.

British West Indies: Alfred E. Redman, "Elsing," Middle Road, Devonshire, Bermuda.

Dominican Republic: H. H. Gosling, Calle Cesar Nicolas Penson, Ciudad Trujillo.

General:

G6NJ would like to know if he holds the English WAC record. He worked FB8AG, W3FPX, VK4HR, G5JF, J4CT, and LU6JB, in two hours and 20 minutes on the 27th of April William Hall, W5ASG, has his troubles. He re-

ceived a heard call from Solhov, Baumanabad, Tadjikistan, U.S.S.R., Asia, but "even the National Geographic Society has not been able to locate the darn place!" Can anyone help him? Jack Anderson, VK3JA, has been receiving QSL's from W stations acknowledging QSO's on the 3.5-mc. band during February. As VK3JA has not been operating on that band for some time, he asks that the pirate acknowledge the QSO's so the W's won't be disappointed! SU1CH, the 300 watt 'phone on 14,285 kc. is giving many of the 'phones their first African contact. SU1CH, who has been in

Egypt since 1931, used to be a W7 G. A. Shoyer, ZS1H, has several 28-mc. "firsts" to his credit, working J2HJ for the first Asia-Africa, VK6SA for the first Oceania-Africa, and LU1EP for the first South America-Africa contacts. His WAC was the second achieved on ten, running second by only nine hours to W3FAR U3AG recently worked 51 W stations in one day, a notable achievement in view of the fact that the time during which contacts are possible is necessarily limited by conditions W4CCH reports a rare one for the lads to tackle: FK8AA in New Caledonia. Look for a T8 signal at about 14,360 kc. at 1 a.m., E.S.T. Anton Habsburg, Archduke of Austria, took time out long enough to sign OE3AH in the DX Contest OK2AK, recently FBTOC with W2DC, uses a four-element array on 14-mc., which probably accounts for his walloping signal in this country In these days of super-powered ether-busters, we like to meet fellows like D. C. Blake, W5EZA. In

sending in his cards for WAC, he mentions the fact that his transmitter is an e.c. '36 oscillator driving a '12A final, input 8 watts! What price high-power?

Strays

Ham Humor—the W8 who called CQ on 14-mc. signing call letters "HI," and then came back with the informative statement, "I just wanted to see what it was like to have the whole band laughing at me."—W9FYK/7.

As W2HFO remarks with some reason, the only winner in the DX contest is the power company!

Well, it seems we can file dimes and pennies for various ham purposes all we want. Several of the gang have written in response to W9EHC's Stray in February *QST* that there is no law against mutilating U. S. currency so long as it is not placed back in circulation. W4AKH quotes B.I.O.N. Ripley as his authority.



OPERATING NEWS



Conducted by the Communications Department

F. E. Handy, Communications Manager

E. L. Battey, Asst. Communications Manager

REBUILDING is now the watchword. Activity reports from all over the country already show plans and progress in this annual pastime. Of course a certain amount of building is always under way. To keep up with the times and insure that our amateur technique stays "out in front," we amateurs are always necessarily trying out new ideas, improving stations and modernizing equipment. While new construction and rebuilding are always in the back of a ham's mind, summer is the logical and normal season for major building activities.

It seems timely to suggest making outside changes now instead of waiting to risk life and limb during the high winds and icy blizzards of next season. Stations need periodic overhaul. Don't put off examination of the condition of tubes, equipment, antennas until the outfit folds up, but "do it now." In summer comes the best time to replace worn antenna ropes and rusted guys, avoiding interruption of skeds and operation during the more active operating season . . . and when unseasonable weather, or sleet and snow put a sudden quietus on ham work, and replacements are difficult, hazardous or even impossible.

Some 80% or more of our telegraphing readers could well consider the advantages of BREAK-IN, and change rigs to key-the-crystal with general benefit to themselves and all amateur radio! Snappier operation would make more QSOs and more pleasurable effective work possible. There are many also who could to advantage wire up a simple monitor. This would permit *better* keying and, in addition to improvement in "fists," would assure the operator of his signal characteristic at all times. Constructors of all kinds of transmitters will find rack-and-panel unit construction justly popular. It makes future changes possible without complete rebuilding, and accessibility for servicing and testing is in its favor.

'Phone stations can be similarly improved by modification for push-to-talk capability. Also mikes of the communications type can be installed or existing mikes modified by placement to improve the ratio of signal to background. Understandability is too often reduced during QSOs by an undesired bedlam from broadcast receivers, children, pets and "aside" conversation. The photograph on page 96 of June *QST* gives a

good idea of what needs to be done to some mikes. Ours are not "broadcasting" but real "communicating" stations, and the readability and efficiency in action should be improved accordingly. A push-to-talk arrangement using a push-button switch or telegraph key for 'phone break-in will at once put your station above the average ham class.

Simple changes sometimes produce amazing improvement and convenience at little or no cost. Give study to your situation and look for easy and logical ways to improve matters. Plan alterations and new equipment early; he who plans carefully and builds leisurely builds well for his amateur station of the future.

The pleasures of 56-mc. operation and work in the open on other bands reach a maximum at this time of year. Summer is a good time to experiment with directive antennas on the higher frequency bands. Don't overlook the summer building and testing of portables . . . for work at the seashore or in the mountains . . . and for *year-round readiness for communications emergencies*.

Amateur radio builds to ever higher standards of two-way communication performance. Your *QST* file is full of station ideas, the *Handbook* full of reliable reference "dope." Let us then look over our equipment and remedy weak points and determine the possible improvements for next season. Summer is rebuilding time. To be ready for next season start the good work today.

—F. E. H.

Briefs

Schooner *Morrissey*

The Schooner *Effie M. Morrissey* is leaving on June 21st for another summer trip to the Arctic. The party will be headed by Capt. Bob Bartlett. Clifton Foss, W2OJ, is the radio operator. A 100-watt 'phone transmitter will be used as well as c.w. Frequencies are not yet known. The call of the *Morrissey* is W10XFP.

WMMN Ham Programs

Starting Sunday, July 5th, 2:00 A.M. EST, and on each Sunday thereafter, WMMN will broadcast a special program by radio amateurs under the auspices of the Mountaineer Amateur Radio Association, Fairmont, West Virginia. All amateurs are invited to listen to these programs each Sunday at the same time.

DX Notes

WITH the closing date for receipt of DX contest logs just past and with all reports in, save the usual few late stragglers, work has started on the compilation of final results. In looking through the logs we find numerous items that rightfully belong in this DX Notes column, and we're passing them along this month.

CPIAC (Yacuiba, Bolivia), who is ex-W2CDA, provided a welcome additional country for many. . . . ZB1E at B-Kara, Malta, was active on 14 mc.; those fortunate enough to snag him were W1FH, W2UK, W2BJ, W3FYR, W3JM, W4DZ, W2GRA, W4CEN, W1CJP. . . . G5YG, Scotland, entered the contest lacking 14 states for W.A.S.; at the close he lacked only 4. . . . Did you know that VK4YL is truly a YL?—Miss Madeline Mackenzie. . . . HB9AD, using 3.5 mc. only, worked 36 stations in the W1, 2, 3, 8, 4 and VE1 districts. . . . As an example of the kind of band 28 mc. has been in 1936: From January 1st to March 23d, OAJ worked all W and VE districts with a total of 400 QSO's, and in addition had 60 QSO's in 30 other countries; he had 228 QSO's on 28 mc. in the contest alone. . . . FM8D, well-known Martinique station, now has the call FM8AD. . . . In the Queensland area of Australia there is a group that calls itself the "U gang," consisting of VK4UU, 4UL, 4US, 4UR and 4UW. . . . The operators at KAIUS will be recognized by many U. S. hams: C. C. Larcum, ex-W7AOQ (owner KAIUS); Major N. L. Baldwin (BN), ex-W3CXL-W3CXM; Sgt. P. W. Blair, ex-W1ICF; J. L. Moriarty, ex-W1GLT. . . . For 28-mc. work CX1CG uses a vertical copper pipe. . . . YT7KP, active on 14 mc., gladdened the hearts of W4ZH, W1DNJ, W8CJJ, W1BXC, W8SI, W1FH and W4OC with contest contacts. . . . VP5AE at Montpelier, Jamaica, is ex-CM8AF. . . . YR5AA, Roumania, worked 55 W/VE contestants on 7, 14 and 28 mc., providing contact with one of the elusive ones. . . . VS6AH's contest DX totalled 1,212,000 miles. . . .

D3CFH gave numerous of the boys a chance to work a D3. . . . W2CAY heard a rare one on 3.5 mc.—TG1AR, Guatemala; also ZE1LA and HJ4A (worked). . . . Quite a bunch of FBTOC's (Four Band-TOC's) were made or completed in the contest, making the old TBTOC seem commonplace. . . . W7AVV made FBTOC with K6CGK. . . . W3SI and K4KD got together on an FBTOC, and W3SI also worked EA3EG on 3.5 mc. to complete another. . . . W3AWH's contacts on 3.5 and 7 mc. with HB9J made him eligible. . . . HB9J FBTOC'd with W2BYP. . . . VE1EA made it with EA3EG. . . . VE1EA is also FBTOC with G2PL. . . . FASBG and W1TS also did the Four-Band stunt. . . . K6CGK worked FBTOC with W6GRL and W7AVV. . . . K4KD went right to town with his Four-Band work, making FBTOC with W1SZ, VE2EE, W3SI, W4DZ, W9TB, W3CHE. . . . Still another Four-Bander: OK2AK and W2DC. . . . And G2PL claims the honor with VE1EA, W4AH and W1EWD. . . . W1WV and W1KH completed FBTOC with EA4AO. . . . The bands concerned were 28, 14, 7 and 3.5 mc. in every case. . . . W6CUH is now TBTOC with all continents. . . . A contact with YR5AA in the contest and one with CPIAC on March 29th brought W4MR's countries to 79. . . . W2AYJ reported his total countries as 68 at end of the contest. . . . W4AH, Charlotte, N. C., lists his DX (as of contest ending) as WAC, 92 countries on c.w.; 5 continents, 38 countries on 'phone. . . . The contest netted W6GRL 4 new countries, bringing his total (as of April 17th) to 102 countries worked. . . . W8BTI added one, making 95 countries total. . . .

YM4AA had the contest to himself in Dansig and made 321 W/VE QSO's on 7, 14 and 28 mcs. . . . W2GTZ's countries totalled 75 after contacts with YR5AA and VK7JB. . . . W6AAT's QSO with VQ3FAR, Tanganyika Territory, added his 112th country; he worked 70 countries in four months with his new transmitter. . . . K5AY, Cheva-Cheva, Canal Zone, is ex-W2BXU; in the DX fray he was using two '45's self-excited, run from receiver B supply; located near WV1L's transmitters he has plenty of QRM from the commercial rigs. . . . K4DDH is located at the University of Porto Rico at Rio Piedras; a separate transmitter is used on each band. . . . As usual, the DX contest

made possible many WAC's . . . among this year's contest records we find some rather speedy WAC's. . . . W8KKG WAC'd in 2 hours, 25 minutes; W6KNE in 3 hours, 35 minutes (March 18th); W9OQP in 3 hours, 57 minutes (K7ENA, OA4J, ZS1AH, J2LO, K6IDK, D4DLC); W5ASG in 7 hours, 43 minutes; W6JJS in 9 hours. . . . W6NKY WAC'd on each 7, 14 and 28 mcs. . . . VK7JF reports he has WAC'd on both c.w. and 'phone. . . . HAF8C Worked All Continents on 28 mc. on February 9th: OH7NF, CN8MQ, W2AOG, VU2BL, VK4EI, CPIAC. . . . For the information of the 1600-odd W's he has worked, ZU1T sends some dope about himself: 34 years of age, married, two jr. ops, accountant and auditor by profession, a Hollander by birth, 16 years in a town of 30,000 inhabitants, the only ham in a radius of 50 miles, first licensed in Sept., 1934. . . . And ZU1T QSL's immediately after every QSO. . . .

Seven XU8's were on the air in Shanghai during the contest. . . . on 7 mc.—XU8OG, XU8JR, XU8CB, XU8CR, XU8RL; on 7 and 14 mcs.—XU8AG and XU8HW. . . . The only eastern W's worked by these XU's in the tests were W1SZ and W2UK, worked by XU8AG on 14 mc. . . . XU8AG sounds a bright note for U. S. east coast hams when he writes that more XU's are planning on 14-mc. work. . . . MX2B, a highly desirable one (Manchoukuo), was active in the contest but worked only 7 mc., working W6's and W7's. . . . W1OMX was lucky in landing MX2C on 7 mc. at 5:12 a.m. EST, March 22d; he also heard XU8HW, XU8AL, PK3BX and PK1MO. . . . There were numerous Asians and Oceanics active during the tests, real choice ones such as VS1AJ, Singapore, Straits Settlement, who worked 7 mc. only and worked ten W6's; XU1B, Canton, China (ex-VS6AE), who worked 40 W's and VE's on 7 and 14 mcs.; PK3LC and PK3ST, East Java—PK3ST worked W2CBO on 14 mc.; PK4XM and PK4DA, Sumatra—PK4DA, on 14 mcs., worked W2BVJ, W2CBO, W2FBA, W2GJK, W2FVT, W2UK. . . . Latvia was represented by YL2BQ and YL2CD. . . .

HB9J worked all W districts within 1 hour, 21 minutes during the DX battle. . . . FT4AF, Tunis, had 78 QSO's on 7 and 14 mcs. . . . VP1JR, Belize, British Honduras, is 17 years old; has been on the air for about 4½ years; worked 14 and 28 mcs. in the contest. . . . Hint to DXers from W8BRB: "The best thing for local QRM is an ax and wire-cutters." . . . SU1SG worked 62 stations the first day of the contest, and worked all W districts in 3 hours, 20 minutes. . . . ZU1T, on March 27th, had worked 43 states and QSL'd to all stations worked, but only 33 states QSL'd—he is after W.A.S. certificate; give him a hand. . . . TF3AG, Iceland, made several hearts beat faster; among those working him were W5ARO, 7 mc., 5:50 a.m., March 16th, and W6GAL, 7 mc. . . . W3AWH worked FA3JY (14 mc.) March 21st, 2205 GMT. . . . The few eastern W's to work PK3BX in the tests were W2UK and W1SB on 14 mc., and W4DZ, W4MS and W4CYU on 7 mc. . . . PK4DA was operating on a small motor launch in the contest. . . . VK3MR heard W6TT, W8BAS and W6NKY on 3.5 mc. . . . W6GHU, South Gate, Calif., was QSO VQ3FAR (abt 14,150 kc.) at 5:55 a.m. PST, April 26th. . . . W2CTO worked ZP2AC, Paraguay, on 14 mc., March 18th, at 7:45 p.m. EST. . . . While we're on the subject of DX Notes, it might not be amiss to mention that all DX "Notes" are not T9—this refers to W stations as well as those in other countries. . . . one signal heard during the contest was compared to keyed auto ignition QRM. . . . some hams lose all their self-respect, or something, as soon as a contest starts. . . . but enough of that. . . . HJ3AJH put Colombia in the contest grab bag, to the delight of those who worked him. . . .

W2BDZ worked VU2KZ on 7 mc. at 1:25 a.m. EST, March 21st. . . . W1DLD worked XU1B on March 27th, 8:35 a.m. EST; the Asian was on about 14,150 kc., T9. . . . W1RY raised ZE1JJ on 28 mc. in the contest, but QRM prevented exchange of numbers. . . . VP9R's (Bermuda) contest work was all on 14-mc. 'phone. . . . W8DGP worked VS6AQ, KA1LB and J2KJ in 18 minutes on three consecutive calls; this on 14 mc. on March 22d. . . . PA0UN worked W6GRL, W6HB, W6CXW and W7AMX on 28

mc. in the contest; prior to that time he had never heard a W6 or W7 on "ten." . . . PZ1AA, Surinam, was coming through during the contest. . . . W9NWE worked HJ1X on 7 mc., March 20th, 3:00 a.m. EST. . . . VR1FF, Suva, Fiji, was active on 7 mc., making 31 W/V QSO's, several with the east coast. . . . W6KIP and W6NKY report contacts on 14 mc. with a station signing VP1FF and giving QTH as Suva, Fiji—this was not VR1FF, since he did not use 7 mc. . . .

W9ELA, Minneapolis, Minn., worked three DX "sixes" on the morning of April 5th, on 14 mc.: VK6FL, PK6AJ and VS6AH. . . . W5EIP was VQ8AF's first W5 QSO; the time and date—May 31st, 6:10 a.m. CST; VQ8AF was on about 14,000-ke., d.c. note. . . . W5DXG made WAC in 11 hours, 55 minutes on May 8/9; stations were ON4CJJ, CP1AA, W2EIG, ZL2FA, OK1LM, J2LL. . . . 5th District record? . . . W5EZA, with 8 watts to a single '12A, has WAC'd twice; among the good ones he has worked are found ZT6X, FB8C, SU1SG, J2LW, J3FI, VK6SA, K7ENA. . . . W9DBC reports the following coming through (mid-May) from 6:30 to 9:00 a.m. CST: XU8AG 14,090 kc., FB8AB 14,375, PK1MO 14,120, KA1WP 14,310, OM2BC 14,135, J2ME 14,280, J2CL 14,345, J2LL 14,340, J2JJ 14,290, J2LU 14,048, J3FI 14,280, J3DP 14,400, YL2BB 14,342. . . . W9DBC QSO'd J2CL at noon on May 7th, an unusual time. . . . W1EWD reports J2LU good strength at his shack from 8:00 to 8:15 a.m. EST, frequency about 14,050 kc., T9X. . . . On April 10th, when QSO with W9TJ on 28 mc., ZE1JJ reported the first contact between Southern Rhodesia and New Zealand. This contact was at 0820 GT, April 1st, between ZE1JJ and ZLIAR, both on 28 mc. . . . ZE1JJ states this was the first contact between the two countries on any band. . . . KA 'phones active include KALAK 14,190 kc., KA1ME 14,220 and KA1AN 14,198 and 14,212. . . . KA1AN has worked two-way 'phone with CX1CG several times. . . . W9PIL, Portland, Ind., reports 14-mc. 'phone contacts with all continents but Asia and a total of 34 countries, including VK2, VK3, VK5, KA1, LU, EAS. . . .

The article by Mr. Boland, W3HY, wins C.D. article contest prize this month. Each month we print the most interesting and valuable article received marked "for the C.D. contest." Contributions may be on any phase of amateur operating or communication activity (DX, 'phone, frame, rag-chewing, clubs, formalism, etc.) which adds constructively to amateur organization work. Prize winners may select a 1938 Handbook, six logs, six message files, six pad blanks, or equivalent credit toward other A.R.R.L. supplies. Send your contribution today!

— F. E. H.

Knowledge Is Power

By John N. Boland,* W3HY

IN ORDER to enjoy this game of ours, we must get a maximum of efficiency from our equipment and ourselves. This does not necessarily mean that the last tenth of an amp. in the antenna is the main requisite for enjoyable operation. What is meant is that all component parts of the station must be used with a maximum of knowledge or common sense. There is where the difficulty starts; what is common sense? We have set it equal to knowledge and therefore have a basis to work on. The A.R.R.L. is the best distributing agency that we have in amateur radio for disseminating knowledge. It fills this place by virtue of its organ *QST*; so watch *QST* for ideas, large and small, that may be put to work in your station. Just because you don't happen to have the material to build a particular high-power transmitter as described is no reason why you shouldn't put the principles applied to work in your own layout. In case some of the material doesn't fit the case at hand file it away in your mind for future reference. We can never learn all there is to be learned about radio. We will be constantly running into difficulties

* News Ferry, Va.

of one order or another that may be solved by piecing together the particles of information we have come into contact with. That is engineering; the practical application of knowledge. So store up the information you gather from here and there. Once you have the knowledge stored away, if you can apply it to your station so as to produce the maximum efficiency from the amount of gear available, you will have gone a long way toward using some common sense. Knowledge breeds proficiency and proficiency breeds efficiency. The ham station must be operated efficiently in terms of gear and tuning, as well as the last drop in the antenna.

Now that we have dug into technical whys and wherefores without actually dissecting something, let's see if we can't do the same thing for our operating activities. Some of us play with DX, others monkey with rag chewing, still others handle traffic. Whatever your interest, there are certain more or less recognized procedures to be followed. The greater part of these are dictated by experience and are well taken. The radio work in our bands themselves teaches most excellent lessons if we can find them out. Here again, knowledge is the criterion of station operation. For DX, it is the knowledge of the times and frequencies that foreigners may be found and contacted on and the proper operating procedure to contact them with. In rag-chewing, it is the choice of a station that is about your equal in operating ability and then the employment of some catch question away from ordinary ham routine; or, perhaps, it is scheduling a station that you know you like to chew the sock with. Traffic handling requires good schedules with reliable stations and a thorough knowledge of the routes that are scheduled by your own station, with a knowledge of the connecting links and good operating ability on the part of the operator; not necessarily a 20 or 25 w.p.m. man, but one who has a working knowledge of traffic procedure. In every case then, knowledge of some factor or another plays an important part. A good, all around op should have a working knowledge of all types of operating. Increase your knowledge to make your participation in the various activities of amateur radio most enjoyable.

The Golden Rule applies to hams as well as to anyone else and the ham should apply it to all whom he encounters (including B.C.L.'s). Co-operation is essential in order to maintain your self-respect on the air and carve yourself a niche in the ranks of those who enjoy something because of what is in it and not because of what they are able to put over on the other fellow. Operate your station efficiently and wisely. If you do, you will observe the rights of others and still be able to partake of your own privileges with the certainty of getting the most fun, kick, or whatever you feel you are getting. The B.C.L. rates some attention when you are interfering with him, and the neighboring ham deserves likewise. Co-operation with the government in maintaining its laws regarding ham radio is also not a bad idea! There are many other ways in which co-operation can be extended, too, but the average op should be able to continue along the train of thought as started above and apply it. Knowledge in co-operation plays a large part in applying the Golden Rule, and all who follow it find themselves with a satisfied feeling of having done no one wrong and of having done the best for himself.

To sum all of this up, we may say that in all fields of ham radio, KNOWLEDGE in the form of its COMMON SENSE applications plays a large part in the efficient and enjoyable operation of a Ham Station. Knowledge itself is, of course, highly desirable, but it does us little good, if we do not apply it. First learn the hows and whys, then couple them with common sense and put them to work.

O.B.S.

The following is a supplement to the list of A.R.R.L. Official Broadcasting Stations in November *QST* (page 60): W1DUK, W2BJP, W2HON, W5FPO, W8LAJ, W8NW, W9EYV, W9JAW, W9UJZ, W9WFW, VE8DD.

OBSERVERS' HONOR ROLL

Cairo Commercial Occupancy Survey For May 1936

6000-8000 kcs.

René Allard	W2CSH	W9UJZ	W5BJ
W. R. Faries	W8JIW	W3BGD	W5CVO
W9EFK	W9WKO	W3DGC	W5DWW
W8APQ	W3FZQ	W3ERF	W7EYR
W110A-3	W9LEB	W800W	W8BFF
W3ALB	W9SJK	W9BFC	W8JZ
W3ETM	W9SXL	W9SYI	W9CGC
W8NQ	W2HAY	VE3ABW	W9SGT
W3AJF	W3FCQ	P. R. Randolph	W9TPS
W3BYS	W3FEW	W1CJP	VE5JP
W3EDC	W8ELC	W3AVJ	ZL2OD
W3EHz	W9DQD	W3ZX	Northwest A.R.C.
W3ESH			

4000-4500 kcs.

W8KNB	W3EQP	W1CJP	W3AEJ
W1AXS	W1JCN	W1GTS	W5BJ
W1INT	VE3ABW	W1LZO	W8JQE
W1GV	Northwest A.R.C.	W2JHB	W8NQ

Brief

The Great Lakes Amateur Radio Committee, sponsored by the Northeast Amateur Radio Club, Cleveland, Ohio, and a council of all the clubs in that vicinity, will have an amateur radio station in operation at the Great Lakes Exposition, which starts June 27th and lasts 100 days. A large number of operators will be needed to man the station. Schedules will also be wanted. Any ham having spare time during the period in question is invited to send W8C10 (R. P. Irvine, 5508 Northcliffe Ave., Cleveland) information as to times available for schedules or times available to help in the operation of the exposition station.

W3EOP Winner of April O.R.S. Party

THE high scores made in April Official Relay Station activities indicate the fine conditions that obtained. The leader, W3EOP, worked 171 stations in the short space of 20 operating hours with others close behind in the competition. W1TS worked most different A.R.R.L. Sections (48) and W4RA at the key of W4NC contacted 47 Sections during this get together. The figures have been carefully tabulated showing performance of all the leading stations in detail.

Fun in traffic handling and pride in schedules ready for any emergency job is a large part of the regular tradition and practice of each Official Relay Station appointee. Quarterly, however, time is appointed for an O.R.S. nation-wide get together at which contacts with brother O.R.S. are renewed in a station and operator testing radio get together. Hundreds of O.R.S. take part and operators consistently better their own best previous records. Next season an interesting competition for all O.R.S. has been worked out. Results in monthly traffic handling will count part, and the records in three O.R.S. parties will also count, and the leading operators will receive A.R.R.L. watch-charm awards. Also the Winston-Salem Amateur Radio Club are donating a 23-inch high sun-gold Trophy, a beautiful cup with handles surmounted by a figure awarding a wreath to the winner! There is room in A.R.R.L.'s field organization for more qualified traffic handlers. To receive recognition by O.R.S. appointment shows that you are a keen operator, and a top notcher in amateur organization. Regular bulletins and activities for O.R.S. keep this group at the front. Drop a line to A.R.R.L. Headquarters or to your S.C.M. for an application blank and details on O.R.S. appointment if you are interested in regular doings and plans for next season. A card will bring you dope and a sample bulletin besides.

Here is a tabulation of the work of the leading stations in April:

Station	QSOs	Sections	Heard	Score	Power	Section
W3EOP	171	45	173	47,385	—	E. Pa.
W1TS	157	48	44	40,992	800	Conn.
W4NC (W4RA)	149	47	42	38,164	800	N. C.
W2AYJ	142	41	122	35,137	400	N. Y. C. & L. I.
W1INF (W1UE)	135	42	72	32,424	250	Conn.
W8BYM	142	45	100	31,130	150	Ohio
W6KFC	92	41	64	30,463	68	Ariz.
W3FTK	140	38	81	29,678	90	So. N. J.
W9JRK	143	43	46	27,649	90	Indiana
W8FIP	134	46	15	27,048	600	W. Pa.

Call	QSOs	Power	Score	Call	QSOs	Power	Score
W5DEJ	125	—	26,312	W8KNB	121	35	18,034
W8JTT	111	45	22,750	W1JTD	100	45	17,444
W2FN	115	3	22,330	W2ECO	86	150	17,430
W1GME	121	75	21,856	VE2DR	108	150	17,030
W2DXO	121	300	20,992	W8ONK	99	53	16,592
W0RAQ	102	—	20,958	W7NH	63	—	16,388
W80FO	124	—	19,800	W8MHE	85	150	15,620
W1EOB	101	75	19,173	W8YA	96	—	15,098
W9ENH	96	—	18,520	VE4GE	59	—	14,586

W2HNP Leads in O.P.S. Tests

IN THE April station tests by Official 'Phone Station operators W2HNP made a record number of contacts placing N.N.J. at the top of the list. W9HSF, using switching to electron coupled oscillator for rapid frequency change (5 seconds from any frequency as he puts it) stands second in the listings and puts Indiana at the top once again. W8JTI is in third place for Ohio. 18, 16, and 12 different A.R.R.L. Sections were worked respectively by the leaders.

Three bronze medallion awards will be made by A.R.R.L. next season to those Official 'Phone Station operators who over the operating year have the best all around record . . . achievement being rated half on operating and half on equipment factors. We invite all voice operated stations (any ham band) to consider the advantages and prestige of O.P.S. appointment and to drop a card to Headquarters (or your SCM) for further details, a sample O.P.S. bulletin, application blank, etc. O.P.S. aim to set the example and find pleasure and profit in forming a national group dedicated to better 'phone operating ethics. As W8DZF says, "In the parties, new friends are made in all Sections in addition to ascertaining the performance of the equipment in practical, regular operating tests." He is in favor of a bonus for stations operating two bands and ideas from the gang on this point will be appreciated. W2HNP expresses enjoyment in the doings and would extend the operating time in quarterly parties. W9HSF and many others look forward to the plans for the next season competition which will be open to all new O.P.S. appointed during the summer. Get lined up for O.P.S. appointment today if you have a good 'phone.

There follows a tabulation of the results of leading stations in April O.P.S. activities:

Station	QSOs	Sections	Heard	Score	Power	Section
W2HNP	36	18	7	3,310*	100	No. N. J.
W9HSF	27	16	10	2,480	80	Indiana
W8JTI	24	12	17	1,848	160	Ohio
W8MOL	25	12	13	1,812	150	W. Va.
W3MCG	20	13	11	1,586	75	E. Pa.
W8CEX	22	10	5	1,200	70	Mich.
W2CBO	17	12	5	1,140	500	E. N. Y.
W2DC	15	11	10	1,045	500	E. N. Y.
W8KNF	18	5	20	1,040	100	Ohio
W9KEF	15	11	4	913	140	Missouri
W8JZ	18	8	4	784	—	Ohio

Call	QSOs	Power	Score	Call	QSOs	Power	Score
W8ICF	16	350	756	W4ANU	12	100	420
W8CPJ	12	—	704	W8MOP	8	60	420
W8DZF	11	140	664	W4QI	11	120	344
W3BRZ	11	135	621	W2GY7	7	125	295
W4BYA	15	175	609	W8JFM	7	75	189
W8BDD	12	200	560	VE3NX	7	85	172
W8CHT	12	100	524	W8HFR	7	100	125
VE3KM	14	200	490	W4CXD	4	85	112

* Score of 3492 reduced to a "6 hour basis."

BRASS POUNDERS' LEAGUE

(April 16th-May 15th)

Call	Orig.	Del.	Rel.	Total
W8LSF	110	117	1190	1417
W8JTT	19	15	1204	1238
W2BCX	8	20	1029	1057
W2GGW	42	46	926	1014
W9ALJ	105	68	742	915
W1ECK	50	103	672	825
W1ICE	115	119	586	820
W0KZL	—	—	819	819
W8PLG	24	14	702	740
W1TY	29	330	345	704
W1FFL	38	115	522	675
W2GGE	20	46	609	675
W6LMD	3	22	629	654
W8ESA	72	228	334	634
W9POB	28	13	373	618
W1DCW	—	22	595	617
W1ITB	100	44	462	606
W1INI	85	60	460	605
W8MGO	—	17	378	395
W8FTK	38	19	330	387
W8CEZ	56	69	438	563
W6LLW	27	49	474	550
W5MN	15	253	272	540
W2IBT	104	109	318	531
W6MTP	32	29	470	531
W1AKS	96	72	356	524
W9KEI	388	52	76	516
W1J8K	321	128	64	513
W2FOP	38	19	454	511
W7HD	4	15	492	511
W8BWT	84	38	331	503
W8LXC	22	19	462	503

MORE-THAN-ONE-OPERATOR STATIONS

Call	Orig.	Del.	Rel.	Total
W5OW	162	113	734	1009

These stations "make" the B.P.L. with totals of 500 or over. Many "rats" extra credit for one hundred or more deliveries. The following one-operator stations make the B.P.L. for delivering 100 or more messages; the number of deliveries is as follows: Deliveries count!

W1BDC, 188	W8KXX, 143	W6CDU, 116
W6GHD, 174	W1IPA, 132	W1GLN, 104
W1JBI, 152		

A.A.R.S. STATIONS

Call	Orig.	Del.	Rel.	Total
WLVB (W6BMC)	3	10	375	888
WLNF (W2BCX)	12	9	536	557
WLRY (W4IR)	20	88	448	556
WLXF (K6FKB)	302	125	80	507

MORE-THAN-ONE-OPERATOR STATIONS

Call	Orig.	Del.	Rel.	Total
WLM (W8CXL)	170	247	1814	2231
W1MI (W6GXM)	98	208	430	736

A total of 500 or more, or just 100 or more deliveries will put you in line for a place in the B.P.L.

More Re Moose River Mine

Supplementing the report in June *QST* (page 23) of the cooperation of radio amateurs in transmitting press from the Moose River mine concerning the three men entrapped there, J. M. Morton, VE1JM has submitted a complete account of the work from which we have obtained some further facts.

Instrumental in organizing the party to provide communication for the Canadian Press at Moose River was Gordon Arthur, VE1AX. The party itself consisted of Arthur Crowell, SCM, VE1DQ; William Horne, RM, VE1GL; and Trevor Burton, VE1CP. The emergency station set up by these men at the mine consisted of a 6F6 oscillator and 42 buffer for transmitter (property of VE1CP) and an SW3 receiver (VE1GL's). Batteries were used for power. VE1AW, the station of Clifford Shortt at Halifax, was designated as the receiving station of the "press circuit." For a period of over ninety hours VE1DQ/portable and VE1AW were in communication; thousands of words of copy were handled. All work was on 3.5-mc. c.w. Practically all of the operating at VE1AW was by Walter Wooding,

VE1ET, an excellent operator with keen ability for copying weak signals. F. R. Fraser, VE1HJ, Halifax, operating his own station, took one dispatch from VE1DQ. Difficulty was experienced at times in copying VE1DQ's signals in Halifax. This problem was overcome by establishing a relay station

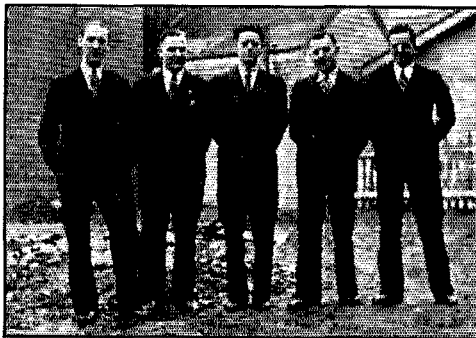

HALIFAX AMATEURS WHO PARTICIPATED IN AMATEUR RADIO EMERGENCY NEWS REPORTING CIRCUIT IN CONJUNCTION WITH THE MOOSE RIVER GOLD MINE DISASTER IN APRIL, 1936

Left to right: Walt Wooding, VE1ET; Art Crowell, S.C.M., VE1DQ; Trevor Burton, VE1CP; Cliff Shortt, VE1AW; Bill Horne, R.M., VE1GL.

between Halifax and Moose River, VE1AG, the station of Fred E. Bayer at Musquodoboit Harbor, VE1BC, Bill Bligh, and VE1FN, John Doull, operated VE1AG.

All amateurs who took part in this Moose River work may feel justly proud of their achievement. The thanks of the press was expressed in an article appearing in the leading Canadian newspapers. Those taking part have received personal letters from the General Manager of the Canadian Press. A message of congratulation was also received from the New York office of the Associated Press telling the Halifax amateurs that their dispatches were making the front page of New York papers.

Free code instruction is given under the WPA Adult Program at the Bronx Vocational High School, 330 East 152d Street, N. Y. City. Hours are from 9:00 a.m. to 1:00 p.m. until September, at which time hours will be from 6:00 to 10:00 p.m.

The Moncton (New Brunswick) Amateur Radio Club will hold the "Hamfest of Hamfests" at Moncton, July 4th, 5th, 6th. It promises to be "tops."

The North Newark (N. J.) Amateur Radio Club has inaugurated a code practice program on the 56-mc. band. Each Monday and Tuesday W2JAS will transmit at a very slow speed from 7 to 7:15 p.m., and W2JBY from 7:15 to 7:30 p.m. Both will use automatic tape transmission. Groups of letters, not standard words, will be sent so that guesswork cannot be used. Copies of these lessons may be mailed to the club secretary, Bob Salisbury, 112 Lincoln Ave., Newark, N. J.; the averages will be reported on the following week's transmissions.

W5ERU, Littlefield, Texas, is originating a special QSL card and will be on the air regularly each evening from 9 to 10 CST and each Sunday from 3 to 5 a.m. (7100 kc.) throughout the period of the Texas Central Centennial Exposition at Dallas, which opens June 6th. The QSL will carry a picture of the Alamo and buildings around the Exposition grounds and will be mailed to all stations worked by W5ERU. The cards will be stamped with Centennial stamps and will be mailed at one of the Centennial cities having a special cachet for cancelling the stamps. These cards will be worth having so watch for W5ERU!

DASD Jubilee DX Contest

Get ready now for the DASD's first DX Contest to be held during the five week-ends of August. The idea of the contest is to work as many German and other European amateurs as possible. Complete details will appear in August *QST*.

CANADA

MARITIME DIVISION

MARITIME—SCM, A. M. Crowell, VE1DQ—VE1ER has new rig working FB and has second class comm. ticket. HH schedules ER and W1SH as usual. GL is rebuilding with 801's in the final and wishes to remind the gang that the H.A.R.C. net for reporting by radio will be working all summer—*so don't forget to report by radio*. HJ, new traffic man on 3.5 mc., is in line for O.R.S. EV is building 28-mc. rig. IV is getting out swell on 7 mc. CX has e.c. osc. instead of crystal. CJ is on early mornings after the old DX. DC is busy on Moncton Hamfest—ALL ROADS LEAD TO MONCTON FOR THE BIGGEST MARITIME HAMFEST EVER—JULY 4th, 5th, and 6th. \$2.00 for hams and \$1.00 for XYL's. WE'LL ALL BE THERE. DI is waiting for fine day to put up new skyhook. GI has Collins matched impedance going FB. GS is building to P.P. osc.—'10's in final. EL is having trouble with his dog chewing up a.c. lines! FF is new Halifax man. IJ has 270 going as self-excited rig. IL is at new QRA—Richibucto. IA is doing FB work on 7 and 14 mc. with flea power. EY schedules AJ for traffic. FT is busy getting bugs out of new car radio. DB is QRL on tug "Bally." BL is awaiting new receiver. BZ is back from the South and will be on the air soon. FC—Congratulations on your recent marriage, OM! HU and HB are on 1.75 mc. ID is going on 1.75 mc. with '03A's final-mod. with '03A's. BT, AJ and BF are back on 3.9 mc. JM, who so ably wrote up the Moose River work of some of the Halifax gang, had misfortune to crack his crystal, but luckily it still perks. IN, the FB station of the MacMillan exped., will be quite active again in this Section during the coming summer; contacts on 28 and 56 mc. are especially desired where possible. The S.C.M. wishes to thank each and every one who took part in the handling of emergency traffic in connection with the Moose River rescue—not forgetting those who stood by and helped clear the channel for portable VE1DQ—swell cooperation, fellows. We've the satisfaction of knowing we did the best job possible under the circumstances, possible only by the rapid and excellent organization work of IAX and the prompt assistance of those who furnished emergency equipment. Congratulations—ALL. GU hopes to annex a super. AR rebuilt his 3.9-mc. 'phone to 175/200 watts, rack and panel, crystal-controlled on 3865 kcs. EI is troubled by sewing machine QRM. BO is active on 3.9-mc. 'phone; chief interest—rag chewing. BT rebuilt to P.P. '10's final and put up a new skyhook—65 ft. high. ID, new ham in Berwick, is building new rack and panel rig—P.P. '03A final. AL, 3.9-mc. 'phone man, is having "feedback" trouble. FE worked his first African by hooking an EAS on 14-mc. 'phone. EA still threatens to put up new antenna. CD had a couple weeks' vacation at his home in Windsor. Newfoundland News (By VO1W): A meeting of the N.A.R.A. was held at the QRA of 1H on April 6th. Hams present were 1C, 1F, 1G, 1H, 1I (Cliff es Oscar), 1J, 1L, 1P, 1U, 1X, 1W. At 11 p.m. 1H went on the air with 3.9-mc. 'phone for a general broadcast to all VO hams. IJ has a Collins 50-watt transmitter that was at 1H and is quite active on 14-mc. 'phone. 1I can QSY by remote control now just by throwing one toggle switch. Cliff of 1I has gone to Corner Brook to live; he will be licensed there under the call 4C; at present he is heard over 4Y, who is active on 3.9-mc. 'phone every night. 1L is active on 7 mc. working the most northern stations in Nfld. 1G has shifted his QRA into the country. 1G and 1U are experimenting with 56 mc. 1C is active in Cairo Survey work. 1P was quite active in DX contest as was 3HM. 1C has donated a year's

subscription to N.A.R.A. including VO News to the VO station getting the highest score in the B.E.R.U. portable tests in June. 1C comes on every Monday night with a short broadcast to all N.A.R.A. members on about 3600 kc. c.w. transmitted at 15 words a minute (for code practice); this is repeated on Tuesday nights by 1J on 3950-ke. 'phone. IX tried M.O.P.A. with a '45 and '46, but is back to his '10's in P.P. osc. with 590 volts on the plates.

Traffic: VE1ER 40 HH 64 GL 40 HJ 34 EV 16 IV 2 GU 14.

ONTARIO DIVISION

ONTARIO—SCM, John Perdue, VE3QK—R.M.'s: 3WX, 3TM, 3QK, 3DU, 3GT, 3SG, 3GG. P.A.M.: 3NX. By this reading NX will have been relieved of his appendix. 1K is rearing along the other lanes with a De-Haviland Moth. KM handles some traffic and Mr. "X" says WAHOO! as a result. TG moved to Lakeside Beach. ACC is after more mileage per stage. ADD has been going great guns with new l.f. receiver and low power. AAZ is rapidly losing interest because of inability to sink longer putts on the other side of Atlantic and Pacific. NC is moving across the street and erecting new skyhook. AIZ puts Lindsay on ham map. PX took time out to visit NC. AE's 18 watts still hold FB schedule with N.Y.C. on 7 mc. . . . he thinks the VE3 central frequency idea is the berries and is moving a crystal to same for fall season . . . Orchids, Carl! FP reports the Ontario 'Phone Net has suspended Wednesday evening meetings until Sept. 2nd. SG is QRL in rôle of office heavy. PL is signing VE4TA on fossil expedition and will not be heard from Ottawa again until late October. AER may be found on 1779.5-kc. 'phone as second op to Chief Operator Lois, who sends her heaviest to the gang . . . incidentally don't be misled by the three letters; they're the OM's initials and the rig is his thirty-first one! ER claims distinction as being the first VE to W.A.C. on 28 mc. Anyone object? AGM submits his usual bit. AGG is QRL a new rack and panel job. AFR has completed chiselling of a cranny in his new diggin's for the radio junk. VN does likewise. AGL and AGM have a lot of fun with their old rigs. GG has blood in his eye for 5 or 10 kc. on low end of 3.5-mc. band for QRR network exclusively. CP conducted a stunt night for Frontier gang in Windsor. AEV says that success is just around . . . the modulator, in any 14-mc. 'phone. MR is an aspirant for O.P.S. on 1.75 mc. AEM is looking forward to initiation into CNE traffic. AZ boasts of another rig for 14-mc. 'phone. GT was laid low with bugs in his mug—his first trip beneath the downs for ten years! WB finally completed W.A.C. through generosity of J2LK and needs VU2BG's for W.B.E. RO is Windsor tennis star and celebrates same birthday as BZ. MB reports for twenty-first consecutive time (take note, you loafers). UO and XS swapped lies with MB in person. TM is increasing power and will have "super stuff" in his new 'phone gimmix. QK has purchased Bob's old bottle and will serenade the O.F.N., come Michaelmas. FO is ready to compete with PeeWee OC, both boys being heavyweights and packing awful wallops. HK is now in Kingsville and bubbles over with warm hospitality . . . go see him, all you Essex County-ites, a real ham and a grand guy is Father Williams. AHK has deserted 28 for 7 mc. Southern Ontario Radio Ass'n of Windsor celebrated its 15th birthday on June 2nd as an affiliate of A.R.R.L. since 1921 . . . has a snazzy clubhouse and a limited membership of twelve. BZ threatens to give Ed Wynn some competition. IA is aspirant to select ranks of O.R.S. WX, CP and QK want all continents, not just two, if the mug who uses their call insists upon records. QB still is buried in unclaimed "furrin" cards—come on, gang, loosen up and send Bert the necessary self-addressed and stamped number 10. ABW keeps TL "I" open via 2DR and KH. VO, MK and XW sweetened up at a sugar party. There'll be no holding those '01's of QB since he has grown a 50-foot pole. MA and YK say it's the berries. STOP THE PRESS—FLASH! "last call for suggestions on the 3750-3850, 100-kc. 'spread' for VE3 operation this coming fall season. Now is the time for organization. See May divisional report for details. Write NOW and sign up." AHA at Dryden is a chemist with a future. LY may be found nosing around 7 mc. HA has taken over operation at Val d'Or, Quebec, for C.N.R.

ON is now at Little Longlac Mine where he says another tyro is about to bud. RK, formerly of Ottawa, is gold beating by day and brass pounding by night at Schumacher. HY dreams of becoming O.R.S. BG and ADZ may be found around 3525 kc. from Kapuskasing. The inimitable Russian, Jerry Ireland, of HY is buzzing around again on 3.5 mc.

Traffic: VE8GG 166 ABW 133 WK 46 MB 23 QK 19 FL 18 QB 16 SG 12 AEM 8 KM 7 AZ-WX 5 RO 2.

QUEBEC DIVISION

QUEBEC—SCM, Stan Comach, VE2EE—The Eastern Division A.R.R.L. Convention is over, and it is the general consensus of opinion that the sponsors deserve heartiest congratulations on its unquestionable success. The Convention Chairman, VE2DU, and his various committees did a real job, and we rate the whole affair "Five Stars." The sponsors would again extend their thanks and appreciation to all who attended; through their wonderful cooperation was such a success possible. BN purchased a new receiver. BO has fully recovered and is back on the job. W2BNX is with us this summer, working at one of the amusement parks. LJ put up a 14-mc. vertical. LV is contemplating following his footsteps. KK moved out of town. JI received listeners' cards from Moscow. DR is handling the Trunk while "Doc" is getting a new skyhook erected. CR is now the proud holder of the Burgess Trophy; copied Ted McElroy's tape at 36 w.p.m. FB, Val, the Division is proud of you. IQ is laid up with an attack of bronchitis. Speedy recovery, OM, AA is on 14 mc. with 200 watts. IY is building a Super-Gainer. HT has been slightly under the weather, but is quite spry again. The call AG, so long associated with Doug Jarvis, has changed hands; Doug has really gone commercial. AE, our QSL Manager, has lots of cards on hand; send in envelopes, gang. DV should send a truck. BV is leaving us in the near future for the Maritimes. Luck, Frank, CU came down from the north country for the convention. DA was third in line for the Burgess Trophy. FB, Margot, FE is back on the air. Miss HH5PA was a visitor to Montreal, also 1CR and 1DQ. FK is having a little trouble with his 14-mc. 'phone. Our R.M., DR, is looking around for more traffic men. Anyone interested in handling traffic, please get in touch with Bill.

Traffic: VE2DR 151 BU 35 EC 25 JI 2 EE 17.

VANALTA DIVISION

ALBERTA—SCM, A. D. Kettenschlag, VE4LX—GY is grid modulating a pair of ten's. DC is using dynamic mike. MO is active on 'phone. JP is looking for grid mills. IN's chickens roost on antenna. GD has Johnson "Q." HQ is trying 28 mc. CY has the photography bug. JJ has FB 14-mc. rig. AA is revamping his super. OF has 14-mc. beam. RV has FB battery 'phone. LA has new 54-foot stick. GM is rebuilding shack and rig. PB and OJ dismantled rig to build separate stations. CT is active on 'phone and c.w. SN gives the breakfast club hot news—37 new licenses in Edmonton District including AAB, AAD, AAG, AAS. Edmonton Club meetings still enjoy good attendance. GW has new rig with P.P. ten's in final on 'phone and c.w. BV expects to put up low power rig at Cooking Lake this summer. HM is building modulator for his 50T. LQ gets FB reports. QX will be away for the summer. RU is getting plenty of DX cards. ZP is going north as commercial op for fish co. LE is selling refrigerators to the Eskimos. LM is coaxing the gas-eating green monster around again. AJ is on 7 mc. with a pair of ten's. OG on 14 mc. with the limit of power and gets FB DX. OZ is on 7 mc. with ten in final. OI is on 56 mc. OE worked couple of W9's. SJ built 56-mc. rig and is looking for QSO's. VN on 14 mc. is hunting DX with a '46 in final. GE tops the traffic gang for the month.

Traffic: VE4GE 85 LX 84 OD 16 HM 15 QK 12 AF 11 EO 6 OI 4.

BRITISH COLUMBIA—SCM, Don Vaughan-Smith, VE5EF—First reporters this month: JW, JY, FW, PT and MR. Thank you, fellers, and come again! Victoria Club is in search of a lot on which to build clubhouse. North Vancouver gang meets regularly with good attendance. Collingwood boys are busy renovating their clubhouse. Alberni bunch is conducting series of technical talks, and results already apparent. Committee from B.C.A.R.A. is hard at

work on details for the Vanalta Jubilee Convention to be held in Vancouver, Aug. 29th and 30th. They ask you all to make a super effort to be at the biggest and best convention ever held in the Vanalta Division. 5DD, Convention Manager and Official Broadcast Station, makes weekly transmissions on 3850-ke. 'phone, Wednesdays, at 7 p.m., with latest dope from A.R.R.L. and announcements regarding the convention. AC is back on T.L. "F" pinch-hitting for FM. AM fits from band to band, both 'phone and c.w. JC capped the cup as winner of the DX contest sponsored by the Victoria Club for its members. BY sojourns in Vancouver. OT, EF and ES are heard on 14-mc. 'phone. EO's borrowed 50-watter went to its last rest. CC, Ashcroft, is eager for a schedule with Vancouver. Likewise NF at Dawson, Yukon, who often hears Vancouver gang but seldom raises 'em! DW, Williams Lake, roars into the east coast nightly on 3.9-mc. 'phone! OM is going strong with new c.c. rig. KL is proud possessor of a 50-w. bottle. DV put his rig on 14 mc. BI is having a lot of fun modulating his Gamatron on 28 mc. NG keeps the odd schedule for EP, but now she is planning to work on 7 mc. JY works fair DX and has hopes of a super! FW, Victoria, is a former VE3 staging a comeback after ten years off! PT, Victoria, with s.e. rig on 14 mc. works lotsa stations and was second in V.S.W.C. test. OA and MR report via PT that they are very active on 14 mc. RK-20 'phone coming up for MR! JW is moving to Telegraph Creek and carrying with him rig for 7 and 3.5 mc. New calls: RF and RS. LX, the Ham Paradox, makes a 59 sit up and do tricks, but can't get his 211 to perk! KS (is it Ivy or the OM?) is heard nightly rattling a mean bug!

Traffic: VE5OK 6 DD 70 EO 7 MR 25 PT 11 FW 2 EP 26.

PRAIRIE DIVISION

MANITOBA—SCM, A. J. R. Simpson, VE4BG—QF gets out much better with new antenna. GC reports working several stations in Winnipeg while at Bird's Hill with a 50-mc. portable. TV at The Pas is having his rig sent up to him so he can get on the ham bands. Also reports two new stations up there in CX, aviator and Morse man, and LI, who is getting a 14-mc. 'phone going; also, XT, while not running the local movie house, is busy putting a transmitter in shape. AP at Foxwarren, is heard nightly on 3.5 mc. as is UA at Oxbow. RO is bemoaning the loss of his VO500 tube; he is replacing the VO500 with a pair of '52's. IP has moved to new QRA. QC has ironed the wrinkles out of his transmitter. 14-mc. 'phone is kept active locally by NI, QY, GQ. ZK keeps schedules with W9's. KX concentrates on 14-mc. 'phone and c.w. MY is at Kenora and schedules Winnipeg through 3ADP. Trunk Line station AG is the only station handling traffic for this period.

Traffic: VE4AG 139.

SASKATCHEWAN—SCM, Wilfred Skaife, VE4EL—Boys, meet these new hams reporting for the first time and note their QRA's: 4VZ, Lloydminster; OW, Lockwood; ABI, ACG, Moose Jaw; ABR, ABT, ABS, Regina. VZ is rebuilding with '45's in P.P. KJ is doing well on low-power 1.75-mc. 'phone. TN is working out FB on low-power 3.9-mc. 'phone. QZ gets plenty of traffic from K6's on 7 mc. RJ rebuilt entire set. PQ has been hooking XE's. UD snagged a UE on 14 mc. UC and UG are active on 14 mc. and FB on 'phone. YX is pounding out with 200 watts to '52. RB has brushed off the dust from his rib and means business again. MB works DX but gets no QSL's. XM tries bike radio; expects to visit Los Angeles July and August. XL copies press for CJRM. ML is experimenting with photo-electric cell. UK is on 28 mc. EB recuperates after bad operation, and entertained club with educational movies. RM finally got on the air. OH soon will be on 28 mc. CM, VR, EL, GA, FA and SQ are all active on 3.9-mc. 'phone. OW has 41 crystal into 89 final. The rig at Boys' Fair, Moose Jaw, handled about 120 messages; rigs operating were 3.5-mc. c.w., 1.75-mc. 'phone and 28-mc. c.w. and 'phone. ZC is rebuilding. JV reports 28 mc. gone again. PG, OM and RE lost skywires in wind storm. JU is on the way to recovery after operation. ABE had 28-mc. 'phone and receiver in operation at Regina Boys' Fair.

Traffic: VE4FW 157 QZ 56 PQ 5 MB 3 OW 4 UL 8 EL 5.

(Continued on page 72)



CORRESPONDENCE

The Publishers of QST assume no responsibility for statements made herein by correspondents

Congratulations!

State of Connecticut
Executive Chambers
Hartford

Dear Mr. Warner:

One of the redeeming features of the recent flood disaster was the very real coöperation exerted by all the various agencies, departments, and organizations who participated in the relief and rehabilitation work.

Certainly one of the most important volunteer activities was the prompt and efficient assistance rendered by the American Radio Relay League. The necessity for maintaining communication with the outside world at that time was vital. There is no way of determining the inconvenience and cost of carrying on in such a crisis without your aid.

As Governor of Connecticut, I want to thank you and the members of your League for your fine response to the situation.

Most sincerely yours,
/ s / Wilbur L. Cross

Treasury Department
United States Coast Guard
Washington

Gentlemen:

During the recent tornado disaster relief operation at Tupelo, Mississippi, the Coast Guard had a radio Communication truck detail at the scene coöperating with the Red Cross. The Officer in Charge of the detail, Radio Electrician R. W. Finley, makes the following statement in his report of operations on April 8th and 9th, 1936:

"Arrangements were made via Headquarters and the American Radio Relay League, in Hartford, Connecticut, and amateur station W4DEP at Memphis called us on the 80-meter band that afternoon. He proved to be an expert operator and worked with us most efficiently. On the following day he could not stay with us but arranged for W4LN to handle our traffic until 1400 when his services were no longer required."

The Commandant takes pleasure in informing you of the helpfulness and efficiency of the operators of stations W4DEP and W4LN and requests you to convey his thanks to them for their efforts in this case.

/ s / P. W. Lauriat,
Acting Commandant

QSL Manager's Troubles

Lanark, Ontario, Canada

Editor, QST:

The A.R.R.L. QSL Forwarding System has been running smoothly enough here in Ontario but there are a number of points which I believe would help the QSL managers.

About one half of the amateurs here are sending the correct size of envelopes. The size asked for by the A.R.R.L. is a No. 8. As far as I myself am concerned, I don't know what size a No. 8 is, but the size which will take almost all the cards is one that is four inches by six inches. An envelope smaller than this, as a rule, makes it necessary to either trim the cards or enlarge the envelope. Also an envelope opening on the end should not be sent.

At the Ontario office a number of QSL cards are received monthly direct from U.S.A. hams and SWL's. The sender asks on the card that it be forwarded at once. Well, gang, the Canadian postal regulations do not allow this (reforwarding with original postage—EDITOR) so the card is put into the file, perhaps never to be sent. For U.S.A. hams and SWL's I put on the necessary Canadian postage if they enclose the card with either 2¢ in money or two one cent unused U.S.A. stamps. (A used \$1.00 stamp will be accepted until further notice, as VE3QB is a stamp collector.)

To U.S.A. hams: It costs two cents to send a postcard from the United States to Canada. If full postage is not put on we are charged twice the amount of postage that is lacking. In one week I received five cards to forward and had to pay two cents on each.

To Ontario Hams: If you are working much DX or if you are on the 14,000-ke. band very much enclose an extra 2¢ stamp in the envelope. If the letter is over the three-cent weight limit I have the necessary postage and you are not charged 4¢ postage due—and believe me, OM's, the Lanark postmaster weighs every letter I mail. Hi!

—W. Bert Knowles, VE3QB
Ontario A.R.R.L. QSL Manager

Biggest complaint from all QSL Managers is that hams don't send in envelopes. Result: thousands of unclaimed cards on hand. See list of QSL Managers this issue and send your envelope NOW.—EDITOR.

BT Portable

36 Earl St., Rochester, N. Y.

Editor, *QST*:

For over two years I have been operating a portable station at various locations in the second and eighth districts. In this period of time I have found by actual checking that 95% of all foreign stations contacted questioned me as to the meaning of the portable suffix BT8 or BT2. The other 5% accepted me as a refined "bootleg" station trying out something original. Canadian stations are in the same category; practically every VE is ignorant of the meaning of our portable sign. To make matters worse, I have had local stations interrogate my call with a series of question marks.

Why not publish the fact that the BT sign plus a district number following the station call designates the station as a portable in that district?

—B. Kelley, W3ACY/8—W2ICE/8

CQDX? No!

R.F.D. No. 1, Brockport, Pa.

Editor, *QST*:

I would like to express my opinion on CQ DX. My xmtr is decidedly low power, using a 46 final with 16 watts input. All my DX which includes 40 countries has been worked by answering CQ's. In fact, only one DX contact has resulted from calling CQ DX.

Referring to VE3IG's statement that he only has a 15-to-1 chance of raising a VK by calling him, this is very true, but I think his chances would be even smaller by calling CQ DX for the simple reason that when a VK can get fifteen answers to a CQ why should he take a chance on raising VE3IG by calling him?

A VK or G invariably raise a W station when they CQ but they don't really consider us DX in a way due no doubt to the large number of W stations they work. When they really go after DX such as SU, PY, J, etc., they call them and not CQ DX. . . .

—Louis E. Bundy, W8WQ

Re VE3GG'S Plan

2575 N. 12th St., Philadelphia, Pa.

Editor, *QST*:

After reading VE3GG's letter and some of the answers to it I have come to the conclusion that it is about high time to put in my bit. Having been a reader of *QST* since 1922 and a member of the A.R.R.L. for the past few years I find that there are two types of amateurs: The radicals who would eliminate the code test on 56-mc. band and frequencies above and the conservative group who would make the code test more difficult, thus creating a situation which makes the middle path of the A.R.R.L. difficult.

If "Milke" Cavaney had applied as much common sense to the last portion of his letter as to the first part he would have discovered that sending speed does not cause QRM. What difference does it make if the lid sends 5 or 20 w.p.m. if his signal is rotten and wobbly thus hogging the major portion if not all of the band? I am a regular listener to the A.R.R.L. broadcast from W1MK which is transmitted at 13 and 22 w.p.m. and I cannot see where the slower sending causes QRM inasmuch as the signal is clean cut in both transmissions. . . .

Now we know that most of the QRM caused by lids is due to tuning inexperience and maladjustment of their transmitters. Since a majority of the lids break in with the self-excited oscillator rig, which as you know is the easiest to maladjust, why not get the gang and the A.R.R.L. to request the F.C.C. to ban the self-excited oscillator rig on frequencies below 14.4 mc. In this way we can clear the air of some QRM. Since Grammer brought out the one-tube crystal-controlled transmitter in the March, 1934, issue of *QST* which is very inexpensive I can see no further use for the self-excited rig on frequencies of 14 mc. and below. Personally in my opinion it can follow "Old King Spark" with his rotaries to the graveyard.

Remember, Mike, raising the sending speed is not going to improve the lid's technical knowledge and make him a better operator. He won't be practical, as this quality comes only with experience and practice. Your statement that "Any irresponsible kid who swears that he can send 10 w.p.m. and draw a diagram can secure a license" proves that you have not looked at the F.C.C. regulations for some time. I suggest that you do so. You will find that you have to do a little more than just draw a diagram to get a ticket today.

In conclusion would like to say that your letter is unfair to those amateurs who want to do work with 'phone, especially those on 56 mc. and above. They are kicking now that they have to study code, for which they have no use once they are on the air. I do think that exams for Class "C" tickets should be revised, inasmuch as this ticket is too easy to get and is therefore not appreciated. Instead of an amateur giving them a test, why not a traveling inspector who could make a round of his district 3 or 4 times yearly and give exams to invalids and shut-ins?

—Bill Hobart

EDITOR'S NOTE.—Expressing, in general, similar opinions are B. J. Curasi, W2JQN; Charles J. Uher, W9ONR; DeForest F. Richardson, W9VRO; and Leon Hill, W7FJE.

For reasons of space limitations, no further space in *QST* will be devoted to this question for the present.

Good Fellowship

741½ S. Orange Grove Ave., Los Angeles, Calif.

Editor, *QST*:

A good number of people have already deplored the lack of real fellowship in amateur contacts ere this. As an active licensed "ham" since 1921 I have long since ceased to worry about what others get out of their investment of time and money in radio, and concentrated on making it enjoyable to me and those whom I contact on the air.

But I would like to widen my range somewhat. I am in a profession that includes many members of the ham fraternity in its ranks, but I have never been able to find more than a scattered handful of them. The profession I speak of is the stock and bond business, and it is one which by its very nature binds together all those engaged in it regardless of their position or geographic locale. We communicate daily with other brokers all over the country by wire, teletype and telephone. How nice it would be if you should discover some man you had been doing business with in Podunk had a ham set at home! And you could get together in the evening for a good talk in the same language!

So here's an invitation: If you're in the financial game just give WGSN a buzz any time on 7031 kc. or 14,062 kc. and we can talk about the gold movement, the technical position, the Dow-Jones Theory, that defaulted dog you own, or what have you. And it'll make life more interesting than this "Wx hr" and "CUL 73" stuff we're all fed up with.

—William A. Lippman, Jr., W6SN

It Looks Like a Boom

3920 Elmwood, Cleveland Hts., Ohio

Editor, *QST*:

I agree with W4AT on ham television. I have thought about this for several months, but don't know where to start or what I need. Several other hams around here have the same opinion. I think if *QST* started some television articles it would be well worth while. *QST* can easily start the ball rolling and, incidentally, standardize the apparatus. I believe much can be done when things get started.

—James B. Bamberg, W8OPX

187 E. Genesee St., Auburn, N. Y.

Editor, *QST*:

At last someone has started it so let's keep it going. The "someone" is W4AT, and "it" is ham television. I have been waiting for some dope on television in *QST* for some time and now I hope we will get some. As long as we are given the privilege of transmitting pictures, why not make use of it? Are the commercials going to get away with television,

(Continued on page 58)

CAPACITY versus TURNS

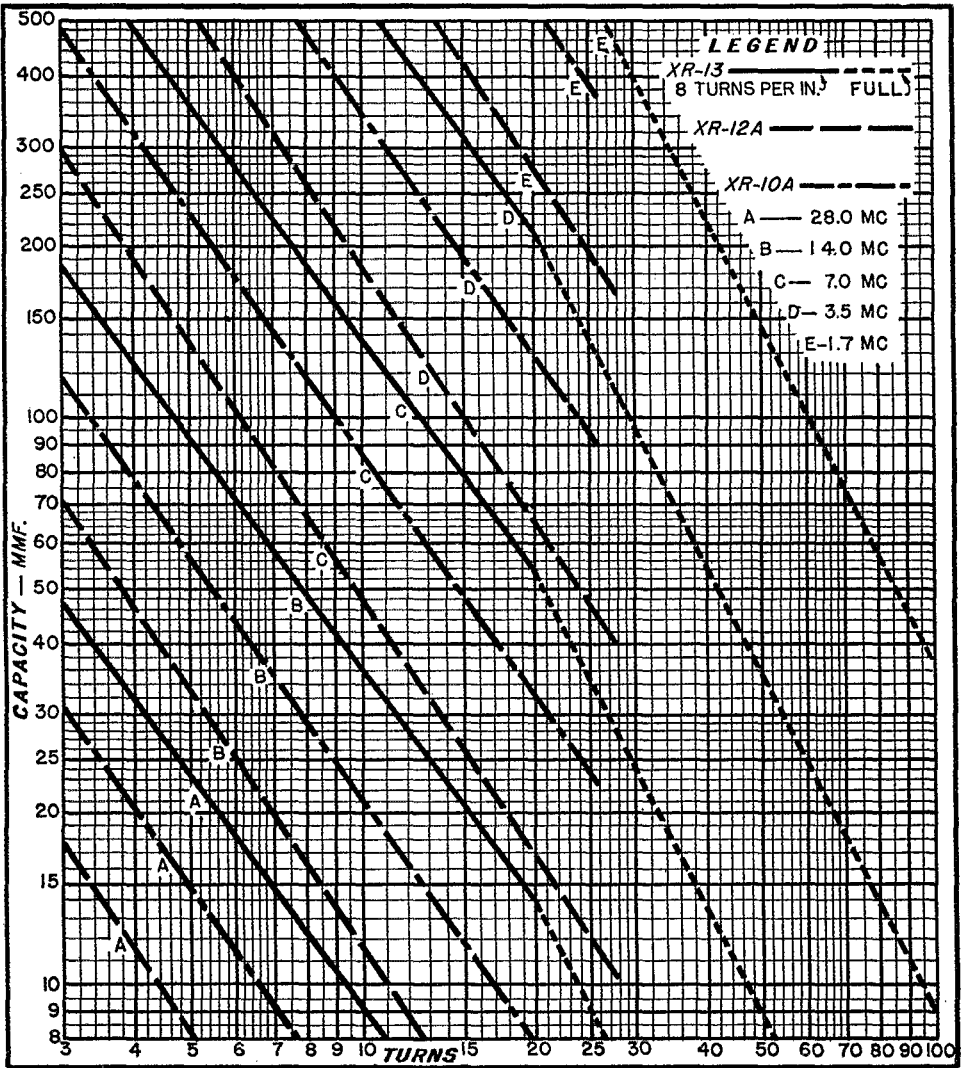

LAST MONTH the article on this page ended with a formula for determining the capacity for final amplifier tank circuits. To refresh our memories this formula is

$$K = \frac{I(\text{ma})}{E(\text{volts}) \times \text{Freq. (mc.)}} \times K = \text{Tank Capacity (mmf.)}$$

where K=2600 for single ended C.W., 5200 for single ended phone, 650 for push-pull C.W., and 1300 for push-pull phone. As a conclusion to this discussion, we are offering the chart above which will prove a convenient means for determining the correct coil form and number of turns of wire to use with the calculated capacity. There are five groups of curves (one for each ham band) plotted for three of our coil forms. The XR-13 is our 1 3/4" dia. Buffer Coil Form, the XR-12A (4" dia.) and the XR-10A (2 3/4" dia.) are our Transmitter Coil Forms. As an example of the use of the chart, suppose the calculated capacity is 60 mmf. and the operating frequency of the rig is to be 7 megacycles. Then for this frequency we refer to group "C" of the curves and at this capacity we find that the XR-12A requires 8 turns, the XR-10A requires 13 turns and the XR-13 requires 18 turns (wound 8 turns to the inch). If the transmitter is to be operated only on one band, the type of coil form will be determined by individual requirements. However if plug-in coils are to be used then it will be convenient to use only one type of form thruout. The best type can be determined by calculating the capacity required for each frequency and by referring to the chart to see which coil form can be used in all cases.

There is one thing to remember when selecting the tank condenser; the chart capacities are the sum of the tube, wiring and the tank condenser capacities.

JAMES MILLEN



THE NEW RK-36

A new triode designed for high plate efficiency and power output at all amateur frequencies. Like other Raytheon tubes designed for amateur service, the RK-36 has high mutual conductance and is Easy to Drive.

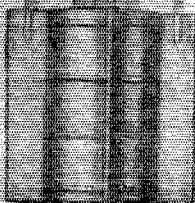

CHARACTERISTICS

Filament Voltage	5 Volts
Filament Current	7.5 Amperes
Grid Plate Capacitance	4.0 uuf.
Input Capacitance	4.6 uuf.
Output Capacitance	.85 uuf.
Typical Operation	Class C Amplifier
Plate Voltage	2000 Volts
Plate Current	150 M. A.
D. C. Grid Current	30 M. A.
D. C. Grid Voltage	-360 Volts
Required Driving Power	15 Watts
Power Output	200 Watts

Write to the office near you
for full technical data.

RAYTHEON PRODUCTION CORPORATION

420 Lexington Ave.	New York, N. Y.
445 Lake Shore Dr.	Chicago, Ill.
415 Peachtree St. N. E.	Atlanta, Ga.
555 Howard St.	San Francisco, Cal.
53 Chapel St.	Newton, Mass.

RAYTHEON

AMATEUR RADIO TUBES

Correspondence

(Continued from page 66)

and the hams sit around chewing the fat on 'phone and c.w.; or the hams going to get in and get going on it? That is probably the reason they are having such a hard time of it; they need some help from the hams. So what say—please publish some dope in *QST* on the subject.

—Roy Seccomb, W8LWN

QRR/SOS

480 Windemere Ave., Toronto, Ont., Canada

Editor, *QST*:

I wonder if any of the gang would be interested in hearing of an experience that happened to me back in 1923, or if anything of like nature has ever happened to others, wherein a broadcast station, a ham, and a commercial operator, all cooperated in getting assistance to a ship.

In 1923 I was operator on the S.S. *Canadian Adventurer*, XWD, carrying grain on the Great Lakes. One night, after clearing Chicago, we had the misfortune to pile up on a sand bar, about five miles north of the city. After trying to refloat ourselves, the attempt was given up and the old man filed a message to a salvage company in the city, requesting the services of a tug. The commercial station was not in operation that year. Great Lakes naval station was operating part time and the nearest coast stations available were Ludington and Frankfort. The equipment on board was the proverbial crystal receiver and a 2-kw. ice box xmitr with a very small antennae, and 75 miles was DX daytime range. Hi! To make matters worse the QRN was terrific and therefore couldn't even hear Frankfort or Ludington. What to do? What to do?

Just previous to the pile up I was listening to what I believe was WMAQ broadcasting a program of music. Couldn't help it, as he was coming in on 600 on my receiver. I reasoned that surely some ham who knew the code must be listening to the program too. Working on that theory I put the ash can on 300 meters and blazed away with something like this: (it sounds corny to me now, hi!) "Calling CQ CQ *QST*, etc." "If any ham in Chicago hears this please telephone the Salvage Company and tell them to send a tug to the assistance of S.S. *Canadian Adventurer*, aground, South Chicago. Sig XWD XWD." I repeated this several times and in between calls WMAQ was coming in better than ever and I just idly listened to the music. The old man came in to get the low down. I told him what the dope was and offered him one of the "Baldies" to hear the program. He sat down and got a big kick out of it as we very seldom heard broadcasts in those days. As we were listening the announcer told us that they were going to interrupt the musical program and use their test call "9XN"—"This is 9XN calling XWD XWD, etc., etc." I thought I was hearing things, but as the announcer continued, the old man thought there was some joke. His eyes bulged and the old jaw sagged. "We are taking this chance in hope that you may hear 9XN and inform you that a tug was dispatched fifteen minutes ago and is on its way to your assistance." I acknowledged the message on 300 and after an interval "9XN" came back and assured us that if needed, they would QRX until tug arrived, if not they would resume the pgm."

Very soon after this the tug bumped alongside and then got to work. While she was puffing away along comes the whole gang from Great Lakes Naval Station in a large surfboat. They took one look around, came aboard, said "Hello," and then scrambled (the midnight lunch was missing immediately after and I have grave fears as to where it disappeared. Hi!). They sure gave good service, anyway. I thought the whole U. S. Navy was paying us a midnight visit. Hi!

I never did find out the ham who relayed the dope to 9XN or WMAQ, but whoever it was, he sure helped us out of a jam. . . .

—S. J. Deemert, VE3BE

More Frequencies

241 Lake Ave., Greenwich, Conn.

Editor, *QST*:

. . . I agree 100% with the idea of asking for a 20-mc. band (or 21 mc. for 7 mc. 3rd harmonic work), rather than asking for additional frequencies in any of our present bands.

A NUMBER OF THE LEADING LINES ALWAYS STOCKED

AEROVOX
ALADDIN
AMERICAN
BARR
BEEDE
BIRNBACH
BLILEY
CARDWELL
GOTO
DU MONT

EIMAC
ELECTRAD
GENERAL ELECTRIC
GUARDIAN RELAYS
HALLICRAFTERS
HAMMARLUND
H & K
HOYT
I R G
JOHNSON
WESTINGHOUSE

JONES PLUGS
KENYON
LEACH
LYNCH
MAC-KEY
R C A
PATTERSON
PYREX
RAYTHEON
R M E

SANGAMO
SHURE
SIGNAL
SUPREME
THORDARSON
UNITED ELECTRONICS
UNITED TRANSFORMER
UNIVERSAL
VIBROPLEX
WARD LEONARD

YAXLEY

Gross Recommends — For the Best "Buy" of the Season

CW-60 (Uses New Eimac 35T) Crystal Control Transmitter

OUTPUT: 60-100 WATTS

Complete Kit, Less Tubes and Crystal

\$20.95

P-60 DUAL POWER SUPPLY KIT for CW-60 Transmitter — with matching chassis **\$25.95**

Descriptive Bulletin on Request

Power output depends on plate voltage used

TUBE LINEUP: 47 crystal oscillator — 53 Buffer and Eimac 35T in output stage.

POWER SUPPLY REQUIREMENTS: Filament voltages 2½ volts at 4 amps. — 5 volts at 4 amps.

PLATE VOLTAGES: 400 Volts at 100 MA and 500 to 1250 volts at 100 MA.

COILS: One set of three coils are furnished with kit for operation on any one amateur band. Coils for 1.7; 3.5; 7; 14 MC may be purchased separately at \$2.75 per set.

SIZE: Overall dimensions of the unit are Height 4½ inches, width 11 inches, length 19 inches.

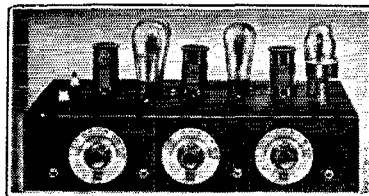

GROSS C C TRANSMITTER — OUTPUT 25-30 WATTS

The "CW-25" transmitter kit due to its low cost makes it possible for anyone to own a modern crystal controlled station. A schematic hook-up and parts layout sheet as well as tuning instructions are furnished, thus enabling the most inexperienced operator to wire and put the set on the air, for real results. The "CW-25" is supplied with a shrivel finished sturdy metal chassis under which all parts are mounted, making the wiring and components dust-proof. A plug-in crystal holder is furnished with the kit. Only one milliammeter is required for tuning the transmitter and each stage is provided with a jack for this purpose. The "CW-25" uses one '47 as crystal oscillator, one '46 as buffer or doubler and two '46's in the amplifier stage, set of three coils supplied with kit for

20, 40, 80 or 160 band. Additional coils 75c each.

Complete kit, less tubes and crystal.....

\$14.95

P-25 POWER SUPPLY — for CW-25 transmitter with matching chassis — **\$11**
450 volts at 200 MA, choke input — complete kit, less tube.....

The "EAGLE" Three-Tube Short-Wave Receiver

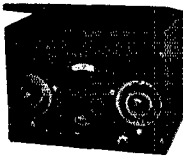

"Band Spread" over any portion of the tuning range — only finest material used thruout. Employs one '32 R.F., one '32 detector and one '33 Pentode Audio — 15 to 200 meters — four coils, supplied. The "EAGLE" is economical — two dry cells will operate the filaments.

"Eagle" completely wired and tested.....
Three tubes tested in your receiver.....

\$11.95

\$3.00

BARR DB3 TRANSCEIVERS

less tubes, batteries and accessories..... **\$16.20**

KEYING RELAY

will operate on one dry cell. Can be used as Single Pole Single Throw or Single Pole Double Throw. Sturdy construction, has ½" diameter Solid Silver Contacts. Compares favorably with expensive types. Special..... **59c**



GROSS CASED CLASS "B" TRANSFORMERS

Heavy Duty — for use with 10's, 46's or 4-46's in push pull par. per pr. **\$7.50**
For 2-46's only, per pr. **\$3.95**

BLILEY CRYSTALS

Largest Stock in New York

HF2-20 M Mounted Crystals... **\$7.50**
BC2 Crystal Holders..... **\$1.00**
BC3-40-80 M Mounted Crystals. **\$3.95**
LD2-40-80-160 M Mounted Crystals **\$4.80**

Exact Frequency if in stock

GUARANTEED TUBES ISOLANTITE TOPS

800 Carbon Plate..... **\$5.35**
866-A 10,000 volts inverse Peak. . **1.85**
203-A Carbon Plate..... **8.45**

THORDARSON CASED TRANSFORMER

600 volts each side of C.T. 200 MA 2½ V. 10 amps. C.T., 5 V. 3 amps., 7½ V. 3 amps. C.T..... **\$2.45**

THORD. CHOKE 12 H 250 MA., **\$1.95**

EXTRA SPECIAL MOUNTED, UNCASED TRANSFORMERS

500-750-1000 volt each side of C. T. 300 watts..... **\$5.50**

EIMAC UNSURPASSED TRANSMITTING TUBES!

Performance — Ruggedness — Power — Price

35-T Output 38 to 112 watts... **\$8.00**
50-T Output 75 to 250 watts... **\$13.50**
150-T Output 150 to 450 watts... **\$24.50**
300-T Output 350 to 700 watts... **\$60.00**
500-T Output 500 to 1350 watts. **\$175.00**

20% DEPOSIT WITH ALL C. O. D. ORDERS

REMIT BY M. O. INCLUDE POSTAGE

Cable Address: GROSSINC

GROSS RADIO, INC., 51 VESEY STREET, NEW YORK CITY

Say You Saw It in QST — It Identifies You and Helps QST

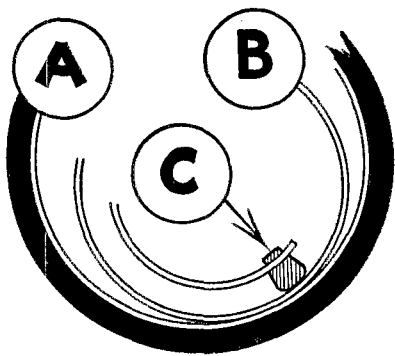

The A B C of Good Volume Control

A Resistor strip on inner circumference of Bakelite case has longest possible length to insure smooth volume control and low noise level.

B Highly polished non-rotating metal band contacts the resistor over a large area. Result, low contact resistance with light pressure, low noise level, no resistance change or wear.

C Oilless wood bearing provides the contact pressure and glides over the polished metal band when control is rotated. Permanently quiet and smooth turning.

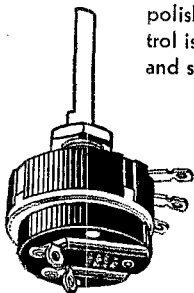

These exclusive Centralab contact features are covered by U. S. A. patent Nos. 1653745, 1660879, 1704154.

Every Radio Service Man should be a member of the Institute of Radio Service Men

Centralab

MILWAUKEE, WISC.

BRITISH CENTRALAB, LTD.
Canterbury Rd., Kilburn
London N.W.6, England

CENTRALAB
68-70 Rue Amelot
Paris, France

Of course, this plan may be entirely impossible due to international complications, but with my limited knowledge of the subject I see no reason why it would be any harder to put over than more frequencies around 7 mc.

What about an additional Cairo survey on 20-21 mc.? It's not too late if we get busy right now!

—John K. Barber, jr., W1AVB

2 Willow Road, Woodmere, N. Y.

Editor, QST:

While we are clamoring for more frequencies we never give a thought to the lower frequencies. Why should we not get the ones above S.O.S. and ship lanes. These are not in use at present and they might prove useful for short haul work, being more stable than five meters. Twenty years ago nobody thought that wavelengths below 200 meters were good for anything. Well maybe the lower frequencies are the same; besides think of the nice harmonics we could put on the broadcast band. HI!

—Fred Crystal, W2JKE

EDITOR'S NOTE.—W2JKE has evidently not been doing much listening above 500 meters recently. Several hundred stations in the government, point to point, coastal, ship and aviation services are in operation in that region. Too, the entire useful frequency range below 500 kc. is less than is contained in our 3500-kc. band alone. And imagine a half-wave antenna at 1000 meters!

New Receiving Tubes

1F4, 1F6, 5W4, 6N7

RECENT additions to the receiving-tube group include two new 2-volt tubes and two more in the metal series. None of the four involve new principles, but help round out each series in making available special-purpose types already included in other cathode groups, and in offering wider freedom of choice to the set designer.

Of the 2-volt tubes, the 1F4 is a pentode power amplifier taking less plate and filament power than the 33, and likewise having lower output. The 1F6 is a duo-diode-pentode similar in application to the 2B7 and 6B7. The pentode section can be used either for radio-frequency or audio-frequency amplification. Tentative ratings on the 1F4 are as follows:

Filament voltage.....	2.0 volts d.c.
Filament current.....	0.12 amp.
Plate voltage.....	135 volts max.
Screen voltage.....	135 volts max.
Grid voltage.....	— 4.5 volts
Plate current.....	8 ma.
Screen current.....	2.6 ma.
Plate resistance.....	200,000 ohms
Amplification factor.....	340
Mutual conductance.....	1700 micromhos
Load resistance.....	16,000 ohms
Undistorted power output.....	340 mw.

The 1F4 has a 5-pin base, the connections being the same as for the 33.

Tentative ratings on the pentode section of the 1F6 are as follows:

Filament voltage.....	2.0 volts d.c.
Filament current.....	0.06 amp.
Interelectrode capacitances:	
Grid to plate (with shield).....	0.007 μ fd. max.
Input.....	4 μ fd.
Output.....	9 μ fd.
Plate voltage.....	180 volts max.
Screen voltage.....	67.5 volts max.
Grid voltage.....	— 1.5 volts
Plate current.....	2.0 ma.
Screen current.....	0.6 ma.
Plate resistance (approx.).....	1 megohm

(Continued on page 68)



**Please
turn to
page 67**

WHERE LOSSES COUNT

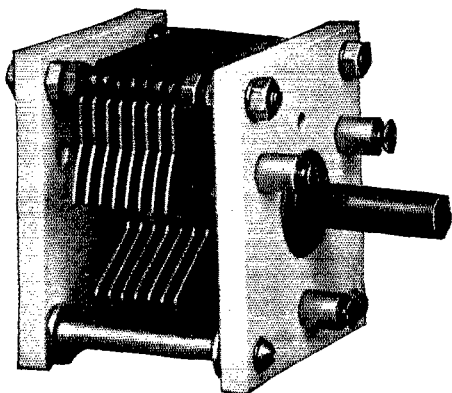

USE THE G-R TYPE 568 VARIABLE CONDENSER

PARTICULARLY designed for high-frequency circuits where accuracy of setting and low losses are essential, the General Radio Type 568 Condenser is ideally suited to amateur and experimental use. These many important features contribute to the continuing popularity of this excellent condenser.

- Exceptionally rigid construction
- Heavy, moisture-proof Isolantite ends
- Rigid frame supports
- Heavy brass plates soldered to decrease losses
- Conical bearings
- Hollow shaft for simple ganging

These condensers are rated at 500 volts, peak, consequently they are adapted to low-power transmitter use.

Two sizes are stocked:

Type 568-D, 175 $\mu\mu\text{f}$ maximum, 12 $\mu\mu\text{f}$ minimum, straight-line-capacitance plates.

Type 568-K, 50 $\mu\mu\text{f}$ maximum, 12 $\mu\mu\text{f}$ minimum, straight-line-frequency plates.

Price, either model: \$4.00

Write for Bulletin 8-Q for a description of these condensers and many other amateur parts and accessories

GENERAL RADIO COMPANY
30 State Street Cambridge, Mass.

Amplification factor (approx.).....	650
Mutual conductance.....	650 micromhos
Mutual conductance at -12 volts bias.....	15 micromhos

The two diode plates are placed at the negative end of the filament. Pin connections in the 6-prong base are as follows: Pin 1, filament +; pin 2, plate; pin 3, screen; pin 4, diode plate No. 1; pin 5, diode plate No. 2; pin 6, filament-; control grid connection is to the top cap. Pin numbers are according to the RMA system, given in the 1936 *Handbook*.

The two new metal tubes include a rectifier, the 5W4, and a Class-B twin amplifier, the 6N7. The 5W4 fits in between the 6X5 and 6Z4 in power ratings. The 6N7 is practically equivalent to the 53 and 6A6. The following ratings have been placed on the 5W4:

Filament voltage.....	5.0 volts
Filament current.....	1.5 amps.
A.C. voltage per plate, r.m.s.....	350 volts max.
D.C. output current.....	110 ma. max.

The 5W4 has the octal base with 5 prongs. Connections are as follows: Pin 1, shell; pin 2, filament; pin 4, plate No. 2; pin 6, plate No. 1; pin 8, filament.

The following tentative ratings have been placed on the 6N7:

Heater voltage.....	6.3 volts
Heater current.....	0.8 amp.
As Class-B power amplifier:	
Plate voltage.....	300 volts max.
Peak plate current, per plate.....	125 ma. max.
Average plate dissipation.....	10 watts, max.
Typical operation:	
Plate voltage.....	250 300 volts
Grid voltage.....	0 0 volts
Zero-signal plate current (per plate).....	14 17.5 ma.
Effective load resistance (plate to plate).....	8000 10,000 ohms
Power output, approx.....	8 10 watts
As Class-A driver (elements paralleled):	
Plate voltage.....	250 294 volts
Grid voltage.....	-5 -6 volts
Plate current.....	6 7 ma.
Plate resistance.....	11,300 11,000 ohms
Amplification factor.....	35 35
Mutual conductance.....	3100 3200 ohms
Plate load between 20,000 and 40,000 ohms.	

The 6N7 has the octal base with 8 pins. Connections are: Pin 1, shell; pin 2, heater; pin 3, plate No. 2; pin 4, grid No. 2; pin 5, grid No. 1; pin 6, plate No. 1; pin 7, heater; pin 8, cathode. Characteristics of the 6N7 are identical with those of the 53 and 6A6, and the tube can be used in circuits designed for the glass types.

—G. G.

Missouri State Convention

(Midwest Division)

July 25th and 26th at Jefferson City, Mo.

THE Capitol City Amateur Radio Association extends a cordial invitation to the amateurs of Missouri to attend the yearly convention to be held at the Missouri Hotel, Jefferson City, Mo., on July 25th and 26th.

An interesting program has been prepared and as an added attraction to the convention there will be a parachute jump made from an aeroplane

Many of Western Electric's tubes are ideal for amateur use

... for example

304B—The outstanding triode for ultra high frequency work

THE Western Electric 304B is a triode designed specially for ultra high frequency applications. This tube is a redesign of the now famous 304A (the original "ultra-hi" transmitting tube) and will deliver more power at increased efficiency at the upper frequency limit. The 304B will oscillate up to 400 megacycles and is capable of an output of 50 watts at 110 megacycles. This tube is indispensable to amateur builders of ultra high frequency transmitters—see page 237—1936 Radio Amateur's Handbook.



\$12⁵⁰
in U. S. A.

... and

307A—Ideal for suppressor modulated applications

THE Western Electric 307A is a filamentary power pentode suitable for suppressor modulated applications. With this tube carrier power output of 5½ watts (peak power 22 watts) can be suppressor modulated directly from a microphone without intermediate audio amplification; peak power output with positive suppressor 27 watts. Also suitable for crystal oscillator. *An ideal tube for the amateur's one-tube phone transmitter*—see page 130—1936 Radio Amateur's Handbook. (Because filament requires only few seconds to heat, transmitter may be completely shut down when not in use and is instantly available when needed, thus conserving power and tube life.)

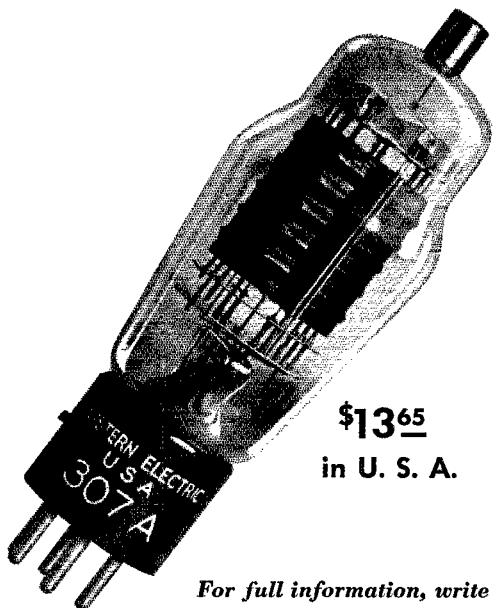

\$13⁶⁵
in U. S. A.

For full information, write Graybar Electric, Graybar Building, New York

Western Electric

Distributed by GRAYBAR Electric Co. In Canada: Northern Electric Co., Ltd.

RADIO TELEPHONE BROADCASTING EQUIPMENT

639 questions and answers covering all radio operator license examinations

This new edition of Nilson and Hornung's well-known book will help you pass examinations and to know your stuff better in any field of practical radio. Brought completely up to date. Enlarged to cover more amateur work; also police, aeronautical and other radio.

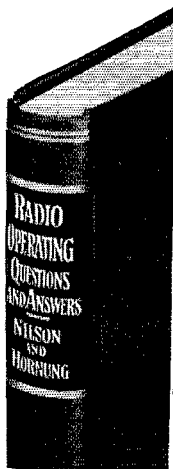

Just Published

1936 Sixth Edition

Nilson and Hornung's

RADIO OPERATING QUESTIONS AND ANSWERS

427 pages, 5½ x 8, 106 illustrations, \$2.50

Covers transmitting, receiving, power-supply, general theory, and laws and regulations, as applied to marine, broadcasting, aeronautical, police, and amateur radio. Every question is typical of those you meet on examinations; answers are complete, illustrated, and give the information essential to meet every situation. For amateurs, short wave fans, men who are preparing for operator examinations or technical positions. Radio companies give preference to licensed operators for all positions. This book gives quick, direct preparation for all examinations. Examine it free.

Users say, "Best of anything I have read on the subject," "One of the best on preparing for an operator's license that I have seen," "Wouldn't take \$5.00 for it now," etc.

Also, by Nilson and Hornung

PRACTICAL RADIO COMMUNICATION

A practical manual covering principles, systems, and equipment, for all classes of radio operating, and including all radio wave lengths, from long to ultra-short.

754 pages, 6 x 9, 435 illustrations, \$5.00

Examine these books 10 days

SEND THIS MCGRAW-HILL ON-APPROVAL COUPON
McGraw-Hill Book Company, Inc.
330 West 42nd St., New York, N. Y.

Send me the books checked, for 10 days' examination on approval. In 10 days I will pay for the books, plus few cents postage, or return them postpaid. (Postage paid on orders accompanied by remittance.)

Nilson and Hornung — Radio Operating Questions and Answers, \$2.50

Nilson and Hornung — Practical Radio Communication, \$5.00

Name

Address

City and State

Position

Name of Company QST-7-35
(Books sent on approval in U. S. and Canada only)

at the height of 8,000 feet. The parachute jumper will describe the jump by means of a five meter transmitter tied to him, while in the air. It will be broadcast from a receiver on the ground.

Write to Dr. J. A. Selvidge, W9OMG, Sec'y Capitol City Amateur Radio Association, Post Office Box 741, Jefferson City, Mo.

Standard Frequency Transmissions

Date	Schedule	Station	Date	Schedule	Station
July 1	C	W9XAN	Aug. 5	BB	W9XAN
July 3	B	W9XAN	Aug. 7	BB	W6XAN
	A	W6XK		A	W9XAN
July 8	BB	W9XAN	Aug. 8	BX	W6XK
July 10	BB	W6XK	Aug. 9	C	W6XK
	A	W9XAN	Aug. 14	A	W6XK
July 11	BX	W6XK	Aug. 21	B	W9XAN
July 12	C	W6XK		B	W6XK
July 17	A	W6XK	Aug. 26	C	W9XAN
July 24	B	W9XAN	Aug. 28	B	W9XAN
	B	W6XK		A	W6XK
July 29	C	W6XAN			
July 31	B	W9XAN			
	A	W6XK			

STANDARD FREQUENCY SCHEDULES

Time (p.m.)	Sched. and Freq. (kc.)		Time (p.m.)	Sched. and Freq. (kc.)	
	A	B		BB	C
8:00	3500	7000	4:00	7000	14,000
8:08	3600	7100	4:08	7100	14,100
8:16	3700	7200	4:16	7200	14,200
8:24	3800	7300	4:24	7300	14,300
8:40	4000		4:32		14,400

Time (a.m.)	Sched. & Freq. (kc.)
6:00	7000
6:08	7100
6:16	7200
6:24	7300

The time specified in the schedules is local standard time at the transmitting station. W9XAN uses Central Standard Time, and W6XK, Pacific Standard Time.

TRANSMITTING PROCEDURE

The time allotted to each transmission is 8 minutes divided as follows:

2 minutes—QST QST QST de (station call letters).
3 minutes—Characteristic letter of station followed by call letters and statement of frequency. The characteristic letter of W9XAN is "O"; and that of W6XK is "M."

1 minute—Statement of frequency in kilocycles and announcement of next frequency.

2 minutes—Time allowed to change to next frequency.
W9XAN: Elgin Observatory, Elgin National Watch Company, Elgin, Ill., Frank D. Urie in charge.

W6XK: Don Lee Broadcasting System, Los Angeles Calif., Harold Perry in charge.

Schedules for WWV

EACH Tuesday, Wednesday and Friday (except legal holidays), the National Bureau of Standards station WWV will transmit on three frequencies as follows: noon to 1:00 p.m. E.S.T., 15,000 kc.; 1:15 to 2:15 p.m., 10,000 kc.; 2:30 to 3:30 p.m., 5000 kc. On each Tuesday and Friday the emissions are continuous unmodulated waves (c.w.); and on each Wednesday they are modulated by an audio frequency. The audio frequency is in general 1000 cycles per second.

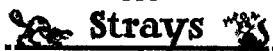

W9HDU is really crystal-controlled—Crystal is his wife's name!

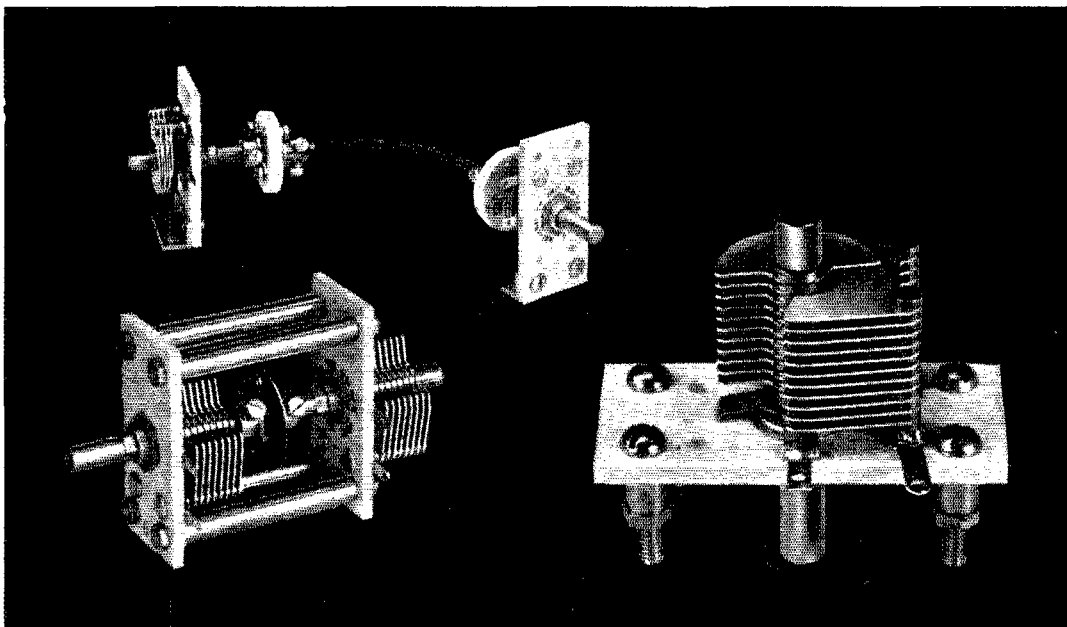

A SEASONED DESIGN

The type UM Ultra Midget Condenser is designed for use in ultra high frequency receivers, transmitters or exciters where a small efficient padding or tuning condenser is needed. Its wide acceptance for such use is founded on its small size for mounting in shield cans, on its shaft extensions on each end of the rotor for convenient ganging, and on its universal type of mounting. These features when used in conjunction with our flexible couplings (a few from our complete line are illustrated below) make a unit that is easily adaptable to unusual layouts. At the right in the illustration above, is one model of the UM condenser (a balanced stator model is also available). At the left are two of the many convenient methods of mounting and ganging. Other features include a staked and soldered construction which, together with the "self locking" rotor design, makes the UM condenser virtually proof to vibration. Prices are extremely low, ranging from \$.75 (net) for the 15 mmf size to \$1.14 (net) for the 100 mmf size.

NATIONAL COMPANY, INC., MALDEN, MASS.

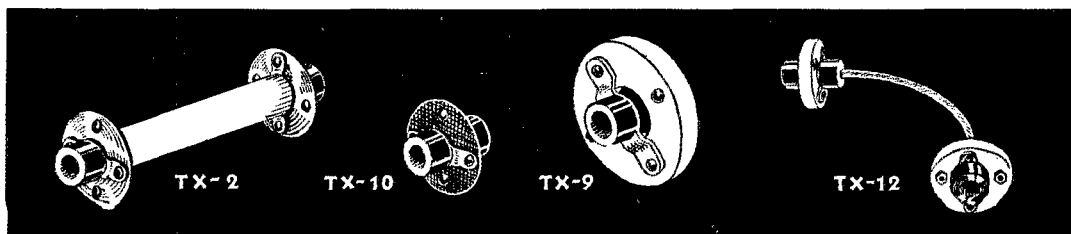

"TEN" is hot!

**YOU NEED THESE CARDWELL
COMMERCIAL UNITS
designed for Ultra HF!**

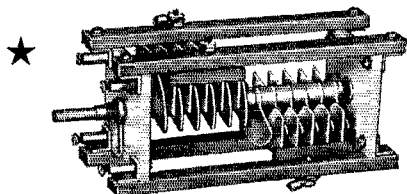

★
JD-28-GD (above)
.125" gap — 28 mmf. per section
JP-48-GD
.084" gap — 48 mmf. per section
\$9.75 NET TO AMATEURS

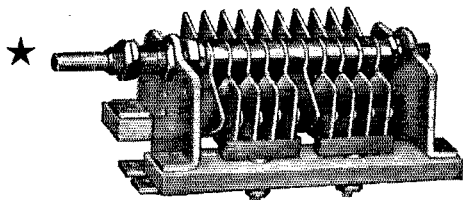

★
NP-35-GD
.084" gap — 35 mmf. per section
\$3.60 NET TO AMATEURS

IMPORTANT FEATURES!

1. NO CLOSED METALLIC LOOPS.
2. MINIMUM SURFACE LEAKAGE LOSSES.
3. VERY LOW MINIMUM CAPACITY.
4. MYCALEX & ISOLANTITE INSULATION.
5. THICK PLATES—BUFFED, POLISHED and EDGES ROUNDED.

THE ALLEN D. CARDWELL MFG. CORP.
83 Prospect Street, Brooklyn, N. Y.

CARDWELL Condensers

The New England Division Convention

RECORDS galore were broken when the New England Division Convention was held at the Hotel Bradford, Boston, on April 18th. W1XK, of Westinghouse, was on the air all day long broadcasting the various events to the world; NBC put the Army and Navy representatives on during the banquet; a record crowd of 1,289 registered and there were over 300 prizes. All of which proves it was the best ever!

Many were present Friday night for the reunion. Saturday started off with a bang as A.A.R.S., N.C.R., A.R.R.L., I.A.R.U., DX and N.E.D.R.A. meetings were held in the morning. Mrs. William Gagnebin, YF of W1DQD, was chairman of the Women's Committee and conducted the ladies through WEEI at noon, where "The Goofs" were seen in action. Bridge was played in the afternoon. Technical talks were given by Shermund, of Raytheon; Corderman, W3ZD; DeMars, W1IBA, of the Yankee Network; Rhodes, of Aerovox; Fleming, of Translab; and Arthur Lynch, W2DKJ.

W1ZE put up a one-kw. five-meter rig and gave road directions to mobile units coming in. Ted McElroy, "The Champ," gave an interesting demonstration of high-speed sending and receiving, throwing in some snappy Japanese for good measure. W1AKY had charge of the contests, which were well attended. The most amusing was the Milkotron event, proving what suckers some hams are!

P. C. McGaughey, W1ND, of RCA, gave a fine illustrated talk on ailments of 'phone and c.w. transmitters for those unable to attend the banquet.

The banquet was a huge success. Admiral Gerhardi, of the First Naval District, and Col. Moore, of the First Corps Area, were put on the Red Network. Messrs. Kolster, Hebert, Handy, Bailey, Mullen, MacAdam (chairman of the convention committee) and others prominent in the division said a few words. All listened with rapt attention to a dissertation on the relationship of the amateurs and the commercials, by one of the latter, Mr. Herbert Randall, of General-Western, of Iowa. His sudden demise was narrowly averted by the toastmaster after a vitriolic blast on the operation of amateur stations in general and the obvious imbecility of the operators. Salt-shakers, glasses, plates and silverware were poised for instant use when Randall removed his glasses and moustache and emerged as Bud Diehl, W1INC.

Director (now Vice-President) Bailey did his usual fine job as toastmaster and performed a miracle when he transferred Col. Moore from the Army to the Navy and back to the Army again in about ten seconds!

The prize drawings were held in the main ballroom and the grand prize—a Super-Skyrider—was won by a Junior Operator who was quite upset when he found it was too heavy for him to carry. His OM soon came to his rescue. Before the drawings were finished telegrams were re-

During
JULY and AUGUST

A Year's
Membership
in ARRL

A Year's
Subscription
to QST

The Radio
Amateur's
Handbook

(Of course the latest twice-
as-big 480-page edition)

\$3.00*
FOREIGN
\$3.65

★ This offer applies
ONLY if your order
is sent direct to
A.R.R.L.

THE VALUE IS APPARENT

Enclosed please find \$3.00 (foreign \$3.65) for one HANDBOOK and one year's membership in the ARRL including 12 issues of QST beginning with the issue (please state whether new, renewal or extension).

Name.....
Street or Box.....
City and State.....
Call if any.....

THE AMERICAN RADIO RELAY LEAGUE, INC.
West Hartford, Connecticut, U. S. A.

Newark's

SETS on PAYMENT PLAN at New Lower Rates

The receivers listed below are the best money can buy. Our time payment plan, at the new low rates, makes it easy to own one. COMPARE our rates with others. THE EASY WAY: Send in your down payment with your order. Set will be shipped as soon as credit is OK'd. Entire Transaction: One week. TRY US. Write for complete catalogue.

Cash Price	Down Payment	6 Months Payments	10 Months Payments
NATIONAL HRO JR. — with tubes — 1 set of coils, 10 to 20 meters (2 amateur bands)			
\$99.00	\$24.00	\$13.52	\$8.20
NATIONAL HRO JR. — complete with tubes — power supply — 2 pair of coils			
\$124.80	\$29.80	\$16.90	\$10.25
NATIONAL HRO — less power supply and speaker			
\$167.70	\$37.70	\$22.78	\$13.89
NATIONAL HRO — with power supply			
\$183.60	\$43.60	\$24.46	\$14.93
RCA — ACR — 136			
\$69.50	\$19.50	\$9.32	\$5.65
RME69 — complete with crystal — tubes — speaker housed in baffle			
\$134.90	\$29.90	\$18.58	\$11.28
HAMMARLUND SUPER PRO — Complete with tubes and speaker			
\$223.44	\$43.44	\$31.23	\$19.11
HAMMARLUND SUPER PRO — Complete with crystal, tubes and speaker			
\$241.00	\$51.00	\$32.92	\$20.16
NEW ACR-175 — complete as advertised			
\$119.50	\$24.50	\$16.90	\$10.25

Full Details of Any Set Listed, Mailed Immediately upon Request

WELL KNOWN OIL FILLED, OIL IMPREGNATED FILTER CONDENSERS

Our Special OIL IMPREGNATED-OIL FILLED CONDENSERS are guaranteed at rated voltages. All ratings are DC working voltage. These are well-known condensers. We have a few left of each capacity. Send in your orders at once.

Cap.	Voltage	Size	Weight	Price
1 mfd.	2000 V. DC	5 x 3 3/4 x 1	1 1/2 Lbs.	\$1.25
2 mfd.	2000 V. DC	5 1/2 x 3 1/2 x 2 1/2	3 Lbs.	1.50
4 mfd.	2000 V. DC	2 1/2 x 2 1/2 x 5	3 Lbs.	2.25
8 mfd.	2000 V. DC	5 1/2 x 3 1/2 x 4	4 Lbs.	2.75
9 mfd.	3000 V. DC	5 1/2 x 3 1/2 x 11	9 Lbs.	7.25
(including 2 1/2" bakelite standoffs)				
4.4 mfd.	1500 V. DC	5 x 3 1/4 x 1 1/4	1 1/2 Lbs.	1.75
5 mfd.	1500 V. DC	3 3/4 x 3 3/4 x 1 1/4	1 1/2 Lbs.	1.90
5.2 mfd.	1500 V. DC	5 x 3 3/4 x 2 1/4	2 1/2 Lbs.	2.00
10 mfd.	1500 V. DC	5 x 3 3/4 x 3	2 1/2 Lbs.	2.75
20 mfd.	1500 V. DC	5 x 3 3/4 x 3 1/4	3 1/2 Lbs.	3.50

Use the 10 and 20 mfd. for perfect filtering in class B modulation Power supply

Newark Paper Filter Condensers

1 mfd. 1000 V. DC. . . \$.56
1 mfd. 1500 V. DC.66
These condensers have stand-off insulators and mounting feet.

Thordarson No. T6877
Heavy Duty Choke. 15 henries at 250 MA. . . \$1.95

HIGH VOLTAGE TRANSFORMER. 1000-750-500-0-500-750-1000-300 MA. 3 1/4 x 4 3/4 x 5 1/4 \$5.95

Thordarson No. T6878
Plate and Filament
Transformer, 600-0-600
V. at 200 MA. 2 1/2 V. at 10
amp., 5 V. at 3 amp. 7 1/2 V.
at 3 amp. \$2.45

2 1/2 V. 10 amp. Filament
Transformer — 2500 V.
insulation for 866's. . . . \$.95

NATIONWIDE RADIO SHOW

affiliated with

CENTRAL DIVISION ARRL CONVENTION

Chicago, Sept. 5-6-7, 1936

See our booth and visit our store. Only three blocks from Hotel Sherman. Write for program!

WRITE FOR OUR COMPLETE CATALOGUE!

NEWARK ELECTRIC CO.

FASTER SERVICE — BETTER BARGAINS

226 W. MADISON ST. DEPT. Q CHICAGO, ILL.

ceived from distant hams who had enjoyed the program via short-wave broadcast.

All who attended claimed they had a swell time, and many promised to be on hand for the Boston hamfest next year.

—G. D. M.

Rocky Mountain Division Convention

August 1st and 2nd at Denver, Colo.

FOR years amateurs from every state have been coming to cool and colorful Colorado to enjoy summer vacations at their best.

Fellows, plan an ideal amateur's vacation—attend the Rocky Mountain Division convention and then proceed to Jenny Lake Hamfest which will be held a week later. The exclusive Lakewood Country Club just west of Denver on the Lookout Mountain Highway has been chosen by the Central Colorado Radio Association as Headquarters.

Good meetings have been arranged so that those attending will be more than satisfied with the program. Entertainment and contests will predominate. Dancing, prize drawing and an initiation of the Royal Order of the Wouff Hong will take place at Mysterious Red Rock Park.

Important! Every amateur who sends in his \$2.50 registration fee and QSL card to the club treasurer, Paul Johnson, 3730 Franklin St., Denver, Colorado, before July 29th becomes eligible for a prize drawing of \$15.00 net value.

For further information write Charles Sibley, 1555 Monroe St., Denver, Colo. Chairman.

Ohio State Convention

(Central Division)

August 1st and 2nd at Columbus, Ohio

ONE of the most elaborate programs ever presented at an A.R.R.L. state convention is now in preparation for the Ohio State Convention to be held at the Deshler-Wallick Hotel, Columbus, Ohio, August 1st and 2nd, under the sponsorship of The Columbus Amateur Radio Association.

There will be an elaborate display of exhibits by leading manufacturers and we are assured of an unusually large list of prizes. The speakers are well known radio celebrities and amateurs.

The gala banquet Sunday evening includes a floor show with Bill Bennett's dance band. Don't forget to bring the Y.L. and the ex-Y.L. as the committee has prepared a fine program as well as prizes for the ladies.

Registration tickets are \$2.00 and includes banquet and prize drawing. Register early. Further information may be obtained from the general chairman, J. M. Bayes, W8BZY, 371 Olentangy St., Columbus, Ohio.

Powered *by* THORDARSON

6L6 or Eimac tubes will do their best! THORDARSON transformers have the heritage of tested design, craftsmanship and materials and "CAN THEY TAKE IT!"

T-8459. Driver transformer push pull 605's or 76's to AB 6L6's. List \$3.76

T-8470. Modulation transformer AB 6L6's or class B Eimac 35T's (500 volts) to 2,500 ohms-250 M.A. D.C. through secondary 5,000 ohms-200 m.a. or 7,500 ohms-150 m.a. List \$10.00

T-8208. Class B. Output Modltn. Transformer plates of Eimac 50T's (100 watts audio pwr.) to R.F. load. List \$16.00

T-8209. Class B. Output Modltn. Transformer Plates of Eimac 50T's (250 Watts Audio) to R.F. load. List \$24.00

T-8210. Class B. Output Modltn. Transformer Plates of Eimac 150T's (500 watts audio) to R.F. load. List \$50.00

C. Q. Booths 6 and 7—Cent. Div. Convention, Chicago—Sept. 5, 6, 7

THORDARSON ELECTRIC COMPANY

500 W. HURON STREET, CHICAGO, ILLINOIS, U. S. A.



NEVER BEFORE

HAS THERE BEEN SUCH A BOOK VALUE!

MORE THAN 256,000 WORDS—OVER 500 DIAGRAMS, CHARTS AND PHOTOGRAPHIC ILLUSTRATIONS, 53 BASIC DESIGN FORMULAS, 42 CHARTS AND TABLES IN THE NEW

TWICE-AS-BIG 480-PAGE 1936 HANDBOOK

It's the equal of a two-volume \$7.00 textbook

It's EASY to get one, too—use the coupon

A.R.R.L.
West Hartford, Connecticut, U. S. A.

Your statistics overwhelm me. Here's my dollar—(or \$1.15; I live outside of U. S. A. proper). Please send to:

NAME _____

ADDRESS _____

No Technician Should Be without



**CAPACITOR ANALYZER
and RESISTANCE BRIDGE**

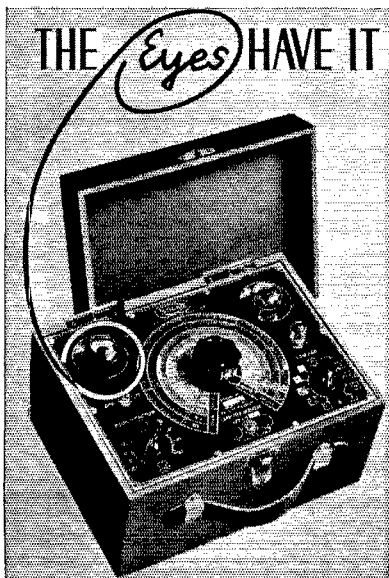

**YOUR eyes and the MAGIC TUBE
see all, know all . . .
QUICK AS A WINK!**

Why guess, when you can KNOW so easily! This scientific instrument tells the complete story of a condenser without reference to charts or tables. Saves you time, trouble and money!

Capacity, power factor, leakage, resistance, all read directly on the panel. The highly sensitive No. 6E5 Cathode Ray Tube is used for balancing. Dials are color-coded to match settings. A refined and extended Wien bridge, built into instantly useful form for laboratory, shop and field work. A new and advanced necessity, obtainable from our jobbers everywhere.

Type CB-1-60

110 volts, 60 cycles. List Price \$32.00
less tubes

Dealer's Net. **\$19.20**
less tubes

Type CB-2-U

110-220 volts, 25-60 cycles. List Price. . \$40.00

Dealer's Net. **\$24.00**

Jobbers in All Leading Cities

ORDER FROM YOUR JOBBER

SOLAR MFG. CORP.

599-601 Broadway

New York City

A "Neon-Stick" Visual Modulation Monitor

(Continued from page 81)

Regarding the operation of the tube, all that is necessary is to connect one electrode to a point in the modulated r.f. circuit which is at sufficient potential above ground; this need be nothing but a tap on the final tank circuit. The other electrode is allowed to dangle, or is secured to an insulator or otherwise separated from r.f., the tube being placed in a position convenient to observe. If the tap on the r.f. circuit is adjusted to such a point that the glow extends exactly half the distance between electrodes with the carrier unmodulated, 100% modulation will cause it to just touch the other one, full illumination indicating overmodulation. If the carrier only lights the tube for one-third of the distance, it is too difficult to observe this phenomenon since the electrode drop is a greater portion of the column and it is rather difficult, besides, to estimate two-thirds (or whatever 100% might require) of the distance. Anyway the power consumption is only about 0.9 watt, a 210 lighting it easily. Some 'phones using grid modulation do not have a capability of 100% and these 'phones should allow the illumination to extend about five-eighths of the distance between electrodes, allowing the tip to just touch the other electrode as before, insuring no more than 85% modulation.

The response of a neon column is linear as far as audio frequency is concerned up to 40,000 cycles and consequently will respond to any peak occurring in the audio frequency range. It was pointed out that a column of this sort responds both to positive and negative halves of the r.f. envelope. While this would be undesirable for use in an oscilloscope, nevertheless used as a peak visual indicator, this characteristic is very desirable since if the transmitter is adjusted so that unsymmetrical modulation exists, the maximum peak will never exceed double the average value (providing of course the operator watches the column). Likewise it will be found that, on some transmitters, the tube may go out during modulation for appreciable intervals of time. This indicates that the average value of carrier has been decreased below the ignition point of the electrode. Such a condition may occur when the modulation capability is exceeded and indicates a very serious break in the carrier.

As has been pointed out, the number of peaks occurring at high frequencies is approximately equal to those in the low end of the audio spectrum, on speech. In looking at the carrier with the inexpensive neon oscilloscope, a string oscilloscope, or a cathode ray tube, all with low-frequency scanning, a peak with very short duration is so narrow as to be unnoticed in the background of the many other wave shapes. Conversely, if the scanning mirrors or linear sweep be operated at a quite high frequency, low-frequency peaks are so broad as to be "spread out thin," and may be unnoticed in the general high-frequency hash. For this reason these devices are not so suitable for continuous observation. It is not intended to

(Continued on page 74)

An open letter to all Amateurs

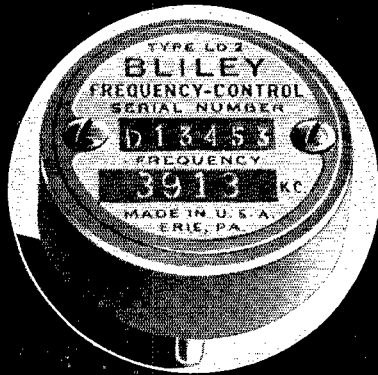

BLILEY ELECTRIC COMPANY



Manufacturers of

BLILEY QUARTZ CRYSTALS

UNION STATION BLDG.
ERIE, PENNA.

An Open Letter
To All Amateurs:

June 20, 1936.

Constant research, development, and improved manufacturing technique have brought the benefits of reliable crystal control units within the reach of more amateurs than ever before

Today you can get precision Bliley Crystal Units that give you far more value, dollar for dollar, than could be obtained even a year ago. Frequency drift has been lowered, oscillation power increased, and new high frequency units made available.

Quality products always include every tested improvement—choose your crystals on this basis.

Very truly yours,
BLILEY ELECTRIC COMPANY

F. D. Bliley
F. D. Bliley
General Manager

FDB:Nf

BLILEY ELECTRIC CO., ERIE, PA.

LEARN RADIO

New Classes Now Forming! Send for 40-page catalog, explains

fully. 300 licensed graduates placed in past 4½ years in broadcasting, shipping, police radio, aviation, etc. We teach all branches. Oldest, largest and best equipped school in New England. Equipped with Western Electric sound and broadcasting equipment and RCA marine transmitter. Course prepares for United States Government telegraph or telephone license.

MASS. RADIO SCHOOL, 18 Boylston Street, BOSTON

The VIBROPLEX JUNIOR

New
GENUINE
MARTIN

ONLY
\$10
with
All
Standard
Improvements

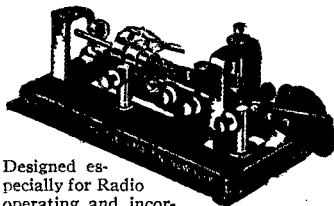

Designed especially for Radio operating and incorporates mechanical features and improvements found only in the Genuine

Vibroplex Bug . . . Provides greater precision in adjustment — clearer, stronger signals and easier manipulation . . . Quickly establishes the user as a GOOD, RAPID sender with less than half the effort of ordinary key sending . . . May be operated as slowly as 5 w.p.m. or at any speed desired . . . Easy to learn . . . Easy to use . . . Easy to own at this low price . . . Over 100,000 Vibroplexes in use . . . Other models in Black or Colors, \$17; Nickel-Plated, \$19. Remit by money order or registered mail.

THE VIBROPLEX CO., INC.
832 Broadway New York, N. Y.

Order
Yours
To-day

Ask Your Jobber to Show You this ASTATIC MODEL D-2

Exceptionally fine frequency response, substantially flat from 50 to 6000 cycles.

ONLY
2½" DIA.
½" THICK
9 ounces
in weight

An output level of -60 decibels (conservatively rated).

List Price
\$25

Fully
Guaranteed

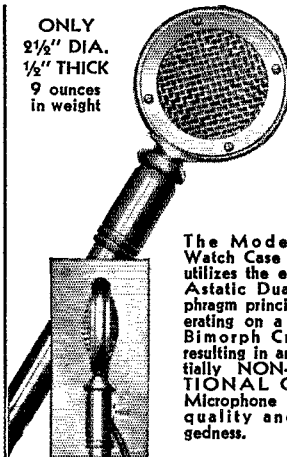

The Model D-2 Watch Case Model utilizes the exclusive Astatic Dual Diaphragm principle operating on a Grafoil Bimorph Crystal, resulting in an essentially NON-DIRECTIONAL Crystal Microphone of high quality and ruggedness.

ASTATIC Crystal Microphones and Pickups

Guaranteed instruments, known for their quality, dependability and ruggedness. Extensively used in both Professional and Amateur fields. Send for your literature today!

LICENSED UNDER BRUSH DEVELOPMENT COMPANY PATENTS

ASTATIC MICROPHONE LABORATORIES INC. + YOUNGSTOWN, OHIO

STATION ACTIVITIES

(Continued from page 54)

ROANOKE DIVISION

NORTH CAROLINA—SCM, H. S. Carter, W40G—OG has W.A.C.'d. ZH has worked Asia about 40 times in the last month and worked W.A.C. once in one hour and thirty-five minutes. Greensboro: AGX reported for the Greensboro gang, FB. He has W.A.C.'d after being on the air many years. MR is complaining of auto QRM on 28 mc., so sticks close to 14 mc. EAK, a new ham, is working on 7 mc. PW is on 14 mc. occasionally. Warren Plains: BHR confines most of his time to the Army Drills. Raeford: ANK with an input of 3.6 watts keeps several good schedules. Durham: CUB is QRL Broadcast Station. Raleigh: BRT led the State in traffic this month. FB, OM, DW has been QRL with Board Meeting, and also went to the hamfest in Lynchburg, Va. Mount Holly: CYY reports that DLY, CXG, BX, BLN and CXO went to the State Convention at Columbia, S. C. BLN, a c.w. ham, won a velocity mike. Wilmington: DIE has joined the Navy. BPL is rebuilding his transmitter. BRK is still going strong. NY moved to a new QRA. CPT spent most of the month traveling from Washington, D. C., to Florida. BPL and CPT received letters from LA2X giving the dope on the hams in Peru and Chile that he met on his tour; he plans to stop in Wilmington on his return to Norway. Winston-Salem: DKI, CGY, IY, BWC, RA and OG are holding down 14 mc. camping on the DX. CFR and DWB are on 7 mc. regularly. ABT, NC and CKJ are working on 3.5 mc. CYA is working between 7 and 3.5 mc. With the 'phones: CXO got in on the O.P.S. party and had a swell time. BQZ is the most consistent 14-mc. 'phone in Wilmington. FT is on 28 mc.; he is modulating his 150-T running as a doubler. AI is on 14-mc. 'phone working some DX. BYA reports working VK 'phones in the early morning hours. 73.

Traffic: W4BRT 56 DW 50 CYY 36 ANK 35 ABT 22 NC 15 BER 5 CUB-CPT 2 AGX 1.

VIRGINIA—SCM, Chas. M. Waff, Jr., W3UVA—FHF is on 7 mc. for the summer. ELJ needs Asia for W.A.C. BIG is rebuilding with all-band operation in view. FBW is building high-voltage power supply. APT worked VK6AA. GFM received R8 from an ON4 with 802's final. WS handled rush message for VP2GP. DBV worked U9AL for W.A.C. FGW is putting in a pair of 50T's. BWA worked three U9's for W.A.C. ADD worked SU, OH, YL, U9 and I for some rare ones. EXI is open for schedules on any band, Tues. and Fri. DJC schedules ELK and 8LYB. BSB worked YR5OR on abt. 14,000 kc. KU is one rag-chewing ham! FBL is new O.R.S.; he handled first message for Gov. Peery (118-word text)! EMX is new O.O. CCU worked U9AC. EZJ is tinkering with 14-mc. 'phone. UVA received cards from VS6AH and YU7DX. RL is increasing power with 511 final. MQ visited UVA. AAI is Chief of Police at Alexandria. FQO is trying for W.A.S. on 3.5 mc. ELN can handle traffic daily to Virgin Is. DQB is D.N.C.S. No. 1 in Va. A.A.R.S. AKN is experimenting on 56 mc. CYM is rebuilding. CGR is rebuilding receiver. ALJ is back on 'phone after rebuilding. FTC worked 4DRJ with $\frac{1}{4}$ watt input (44 volts) and was heard by VE3AEJ with same input. EZL has been received R8 five times in Germany and once in England on 3.5 mc. FYL is using 59 crystal and 841 final. CA finished new exciter unit. BFW and DZW are rebuilding. FKD is going to 14 mc. BEK worked 5 cents. two-way 'phone on night of May 16th! EXW worked ZS on 28 mc. EMM worked VU7, three U9's and three J's! CSY, ALF, BDQ, FYH, EXQ, FFO and BRE attended Lynchburg Floating Club meeting. Next meeting is in Staunton on June 28th. Roanoke Division Convention is in Clarksburg, W. Va., Aug. 28th-29th. Be sure to attend both. 73.

Traffic: W3AKN 97 DQB 67 ELN 64 FBL 54 CSY 27 BSB 6 DJC 5 EXI 3 WS 2 GFM 2 BRY 1.

WEST VIRGINIA—SCM, Dr. Wm. H. Riheldaffer, W8KKG—The MOL's and BDD's visited 9EAN. EZR and DUO are playing with 56 mc. LJX is working 3.9-mc. 'phone. AHF is moving. MQF can't get out at new QRA. ANU worked Pacific coast on 3.5 mc. with 3 watts input to final. CMJ threatens to go c.e. KWU is handling traffic on 7014 kc. KYJ has 45 states on his W.A.S. HGA is working 14-mc. e.w. (and how). AZD worked J5CE. HD was heard in Germany on 3.5 mc. AFX is working K5 on 14 mc. KRU is waiting for pair of 35-T's. MOP is on vacation in 4th call area. CHEM is using a portable rig for O.B.S. schedules. NMD is rebuilding at new QRA. JWJ is on 3974 kc. with

a nice 'phone job. PUA is new Charleston amateur and is on 3720 kc. His wife is also an operator. OSU has schedules with PQQ. MZD won a prize. JRL is on a trip to Cuba with Philco sales representatives. PAJ is now W.A.S. GDF went to Washington for radio-telephone first. ELJ attended Virginia Floating Club meeting at Lynchburg. CLQ is on staff at WMMN. Frank Key, 3ZA, was a visitor at KKG, JRL and MZD. The Roanoke Division Convention will be held in Clarksburg, W. Va., on August 28th and 29th.

Traffic: W8KKG 83 ATT-OK 43 ELJ 41 OSU 29 CFB 25 KWU 20 KBU 19 LII 15 HWT 10 ANU 9 AKQ 4 HD 5 LXF 3 GEG 2.

NEW ENGLAND DIVISION

CONNECTICUT—SCM, Frederick Ella, Jr., W1CTI—216 hams and friends of amateur radio helped the Conn. Brass Pounders Association celebrate its sixth annual dinner, May 16th, at Stamford. Dan Meserve, W1FL, Pres. E.M.A.R.A. and first President of C.B.A., was toastmaster. Speakers included: Geo. W. Bailey, A. A. Hebert and F. E. Handy of A.A.R.L., Dick Pichard of N.B.C. with two reels of movies, Frank Hawks, "Dr. Petersen" and Harold I. June. W1EER/1 was on the air with a nice 56-mc. 'phone outfit working W1CDR/1 in an airplane and several mobile units on the way to the dinner. Frank Hawks, W1LJI, won 3 of the 40 odd prizes! As this is written "CTNITE," May 23rd, has just been completed. From the great amount of activity we know the party was a success. There was real competition for the Billey crystal offered by W1BHM to the high scorer. "Hal" can't be kept down; INF leads the Section in traffic. GME likes R.M. job. JHK moved to Vermont; sure sorry to lose you, OM. IKE cancelled schedules due to press of school work. JUD gets traffic from the boys at college. GVV says less radio—more golf! New officers of the B.A.R.A.: APA, pres.; JOR, v.-pres.; GRU, secy.; APW, treas.; FYE, act. mgr. IYX did some unusual 56-mc. work May 10th, working 9UAQ, Oak Park, Ill. EER-1 worked Chicago on 56 mc. from the location on top of the Stamford Gas & Electric Co. building, E. Mass. has the jump on us in traffic, but let's show them how we can stage a comeback. Get rebuilding done now, for next season's brass pounding.

Traffic: W1INF 158 DMP 153 GME 70 JHK 53 IKE 46 GKM 48 FAJ 52 JUD 29 DOW 28 GTX 25 UE 17 DLX-2D 14 INP 11 CTB 8 AFG 7 CTI 6 GVV 4 BNB 3 BQS 2 BDJ 49 JTD 23.

MAINE—SCM, John W. Singleton, W1CDX—GOJ assays his new pre-selector for his FBXA is great. INW has new Comet Pro receiver. CDX was away from home most of the month. IKC has new schedule with BWR. EZR has new Biley LD-2 crystal unit on 3525 kc. JWR is new Auburn ham. ATA is going strong on 3.5 mc. AQL attended N. H. hamfest. DHH has new ACR-136. DRZ is on 56 mc. What say, gang, let's have a lot more reports next month.

Traffic: W1GOJ 117 INW 14 CDX 20 IKC 6 EZR 8.

EASTERN MASSACHUSETTS—SCM, Albert N. Giddis, W1ABG—ABG has new job. KH schedules daily on 28 mc. BEF is getting back to normal after flood damage. HXE realizes how serious flood really was since he got his bill from the power company!! FRO works portable over the week-end. ISM is trying to make rig perk on 14 mc. HCH is heading for 56 mc. JL expects to "ship out" soon. CIK is putting out a nice signal on 3.5 mc. QW is contemplating a Salvation Army Radio Net. ASI has his hat in the ring for N.E. Director. AKE is adding a pair of '10's. JID is trying a 242-A in his final. IGN resigned as O.R.S. WV has contacted 485 different "G" stations! BPK has gone to La. with Seismograph Service Corp. IWC and RE bemoan lack of traffic. JAI, DFW and JST are giving 3.5 mc. a whirl. IQH and JCX are DX'ing on 14 mc. JBG and CHW expect to add QRM to 3.5 mc. JST, JWT and JXO, newcomers, are welcomed to the fold. JXN in Fitchburg sends his first report. DCW has tied in with O.R.S. Network. AKS moved to new QRA. JSK is new O.R.S. appointee. IHI has new Breting receiver. CLN says A.A.R.S. Net "goes places"! DDE is doing fine work on A.A.R.S. R.M. job.

Traffic: W1ABG 158 EVJ 103 IWC 79 KH 78 BEF 60 HXE 57 FRO 49 RE 43 ISM 39 HCH 26 JL 24 CIK 24 QW 23 ASI 18 AKE 14 GGB 12 JED 10 HKY 9. The following A.A.R.S. Stations reported traffic: ECK 825 DCW 617 (WLGJ 350) AKS 524 JSK 513 IHI 425 CLN 365 DDE 206 ZQ 112 (WIGO 87) EMG 92 TY 704 INI 605 BDC 389 JBI 314 IBP 232 JKR 223 JFS 217 HWE 200 ILD 196 IPA 189 JQH 96 CKV 86 IVC 85 HJS 79 UX 67 AGR 65 AIX 60 JCK 51 INA 48 JJS 44 KK 41 AAR 27 CCL 21 IAO 18 IWR 7 EAU 6 GBW 6. The following N.C.R. stations re-

ported traffic: CC1C/QW 45 CX1B/1RH 101 CX1G/1NK 27 CE11/1AKE 26 CA1C 35 CB1C/1CQA 51 CF1C 29 CH1C 13.

WESTERN MASSACHUSETTS—SCM, Percy C. Noble, WIBVR—Complete list of A.R.R.L. appointees in Western Massachusetts (as of May 20, 1936):—R.M.: AJD, DCH, JAH; P.A.M.: GZL; N.C.R. LIAISON R.M.: DDE; A.A.R.S. LIAISON R.M.: IJR; O.B.S.: BKQ, BWY, GZL; O.O.: ZB; O.R.S.: AJD, APL, ARH, AWW, BKQ, BNL, BSH, BVR, BWY, COL, DCH, DDK, DIE, EOB, GUO, HNP, IJR, IOR, IOT, ISN, IZN, JAH, YK, ZB; O.P.S.: BAP, DUZ, GZL, HJR. O.R.S. Net and A.A.R.S. Net are connected by JAH-IJR schedule. IJR reports new ham, JXY, in North Adams. EOB has increased input and is knocking off DX in great shape. HJR sends in first report as O.P.S. ARH is rebuilding. After rebuilding for the umpteenth time, COI says that now he has got something. FB. ISN would like schedule on 3.5 mc. at 7 a.m. Work is interfering with AJD's schedules. BAP is building portable job. JOT has new rig, and the mumps. FB—too bad! All West. Mass. A.A.R.S. please send IJR monthly traffic report by the 16th of each month, for publication in this column.

Traffic: W1BVR 146 (WLG 114) IZU 117 JAH 102 IOT 68 BVG 58 (WLGE 69) IJR 22 ASU 17 EOB 10 HJR 9 DDK 6 APP-ARE-DIF 5 ATK-IOR-NS 4 COI-DJQ-ICP 2 ISN 1.

NEW HAMPSHIRE—SCM, Robert Byron, W1AVJ—FFL is taking a month off and rebuilding. IMB is on 7 mc. for the summer. HPX and JEH have 56-mc. rigs going. IDY reports new ham in town, JVV. IJB is S.C.S. while FFL is rebuilding. ICS leads the Section with a fine traffic total. HJI is interested in a PR16 receiver and would like to hear from anyone who has one. ILK says 56 mc. is going strong at school. GHT's new QRA: Hurley Street, Nashua. GOC is now member of A.A.R.S., also A.E.C. BFT is vacationing. APK is going strong on both 'phone and c.w. JDF is on 1.75-mc. 'phone and 7-mc. c.w. Many thanks for the great turn out at the hamfest in Manchester. The boys seemed to have a very fine time, and the lion's share of the credit goes to GMH, Carroll Currier, and FTJ, Dot Wilkins, who did the greater part of the work.

Traffic: W1ICS 820 HJI 675 (WLGB 84) IJB 606 IP 206 FFZ 96 JDF 49 IDY-HJI 6 ILK 5 CEA 2.

RHODE ISLAND—SCM, Clayton C. Gordon, W1HRC Prov. Radio Association points with pride to a full staff of officers holding tickets now, since Sec'y Chet Lyon recently received JXA. We also learn that since DDD can't charm them with his "broadcast quality" he's taken up "tripping the light fantastic," boiled shirt an' everything. IZO has 250 watts on 14 mc. IEX has built a "bug." IAV is on 3.5, 7 and 14 mc. The Newport 56-mc. gang, consisting of AWG-BIS-BVI-JFF-JIK-JUC, all get on every evening at 6.30 p.m., make each other a lot of QRM, get disgusted, and the rest of the 24-hour period there are no 56-mc. stations to work. IKZ has job with Mackay Radio. HJ was in port for couple of days during DX contest, but had to head out to sea again; was going great guns while it lasted. HPE changed his QRA so he could have a better shack. EZW's new QRA is nearly completed, with special radio quarters built in special. AFO also has moved to new QRA. We see by the newspapers that the Pawtucket High School and the Cranston High School both have active radio clubs with licenses, apparatus, YL's studying code, and everything. We invite them to send in activity dope for inclusion in this report.

Traffic: W1IZO 118 IAV 2 HRC 4.

VERMONT—SCM, Alvin H. Battison, W1GNF—The members of the Vermont Section unite in wishing every success to our retiring S.C.M., W1BJP, who so successfully conducted our affairs during his term. AOO is QRL orchestra and band work. IQG is leaving for Ohio to complete his studies. ATF is active with A.A.R.S. BJP and AVP are new O.O.'s. AVP is going to check for overmodulation with his oscilloscope; watch out! TJ is back from Florida. BJP reports visits from BDX-IQG-IT, and visited IQG-DQK. AVP is now P.A.M., and things are going to hum; he is forming a Green Mt. Net for c.w.-'phone work; write to him for details. FSV has new rig and is handling some fine schedules. EHB has new rig. GAE has built a new S.S. Super. AHN and ERJ are active in A.A.R.S. ERJ has new rig with 50T in final. GAZ has worked 5 continents with 30 watts. EZ and BJP W.A.C.'d, being first Vermont stations to turn the trick. EZ applied for O.R.S., which means that Vermont will go places in next O.R.S. party! GAN has velocity microphone. GNF has new antenna. JXS is a newcomer from Bethel. Another newcomer is JKE of Rutland, who has

HRO and Harvey R.K-20 rig. AOO and GNF report being heard "across" on 3.5 mc. DQK is building 28-mc. rig with new 35T's. Who is going to get that new '03A BJP is giving to the winner of the Vermont activity contest? Thanks for the election, fellows. The Vermont Broadcast is now sent on 3840 kc. every Wed. at 7 p.m. E.S.T.

Traffic: W1A00 70 ATF 7 AVP 12 GNF 19 AHN 4 GAE 33 FSV 11A.

HUDSON DIVISION

EASTERN NEW YORK—SCM, R. E. Haight, W2LU—EGF continues as high traffic man. Complete station rearrangements and set-up of operating controls has been affected at SZ. FWC reports FB traffic from R.P.I. open house. FQG attended Albany hamfest. HYC got new Super Skyriders. CBN is alternate for IBT. ATM resigned as O.R.S. JIF, club station at Y.M.C.A., is on 7 mc. BLU reports via GTW. HUM heads N.C.R. at Kingston. 1YH is heard on 3826 kc. at 7.30 p.m. daily. IUR is rebuilding for 'phone. HUK is adding a couple of 211D's. QY sends code practice on 56 mc. for several beginners. CL operates on 3915-kc. 'phone. CJS visited N.B.C. studios and took a trip through Radio Row. IMP and IOM had FB game of chess over 7 mc.; IMP lost. CBO recommends DSB for O.P.S. HCP leaves the Section for Texas. HON was appointed O.B.S. for Albany district. GPB was reinforced for O.R.S. and AVS for O.P.S.

Traffic: W2EGF 434 SZ 409 LU 299 FWC 218 FQG 180 HYC 113 GTW 74 CBN 14 ATM 11 JIF 6 BLU-HUM 3 1YH 2.

NEW YORK CITY AND LONG ISLAND—SCM, Ed. L. Baunach, W2AZV—All O.R.S./O.P.S. appointees must report regularly on the 16th of each month or they will automatically be cancelled. New O.R.S. IZU, Out for O.R.S. DNE, HLL, HRS, JHB. The W.P.A. announces free code instruction for Amateur or Commercial license at the Bronx Vocational High School, 330 East 151 Street, every evening from 6 to 10 p.m. The Harlem Radio Club had an interesting exhibit at West 135th Street branch Y.M.C.A. April 28th to May 2nd. The Section regrets the passing of CAU. BXR reports for SC-WLN and requests all interested in the A.A.R.S. to get in touch with him at Governors Island by dropping a QSL card. Our Bronx R.M., BGO, continues to keep up his fine work. ELN and EYQ operate BC station WLTH. AHC has been QRL emergency work for the Tel. Co. DBQ is still checking frequencies as announced on page 70 of May QST. IBT again makes the B.P.L. on deliveries. Law business keeps CDD QRL. JGR is now at 102nd Street and Central Park West and reports that HJ, C.C.N.Y. station, is undergoing a repainting. ELK is using a pair of 801's in the final. DXO schedules 11NF. HWS is now at Quogue, L. I., using low power on 28 mc. IOP has worked all states, but is waiting for a card from Nevada. IHT is using new six-tube t.r.f. receiver. HXT had an FB trip thru Texas, stopped off at 5ELC. OJ can now be heard on 1.75-mc. 'phone using 200 watts into a pair of '03A's. PF is looking for a good receiver to match his 30FX. HSV gets plenty of headaches trying to make a 59 Tri-tet work. GBH gave up 1.75-mc. 'phone as a bad job and is now calling DX on 7 mc. GDF is doing work as O.O. HMJ's filter went west during the O.R.S. party. IOW is on 56 mc. with a ten. HRA schedules HRB. TI has a new boiler to burn up the roads. AAZ can be heard on 1.75 mc. 'phone. HBO says that on May 9th the 56-mc. band was very FB; east coast stations were heard as far as Kansas City; BVE and CLD QSO'ed W9's in Ill.; BYK was heard in 9th District. ECL finds DX very FB on 14 mc. JKE will be one of the operators on the "Bowdoin Biological Expedition" and is looking for schedules with stations in this Section, as he promises plenty of traffic; 14, 7 and 3.5 mc. will be used. ING is building a station for his school in which he will be chief operator. EYD is testing on 56 mc. with N.Y.C. Police Department. IVT has two watts input on 7030 kc. HZS is here from Red Bank, N. J., using an 838 on 7 mc. ICW wishes he had a.c. IJAW and 6NHL are in this Section working portable. DTM has new rig using 53 crystal, 802 buffer and 211 final. BIS is experimenting with Acorn tubes. ISL is grid modulating a ten on 56 mc. GMT is at new QRA. IZN showed the boys in the d.c. district how to get out by using a Class "B" linear. EON and GSU are on 1.75-mc. 'phone. DP, HUQ, and ISE are on 14-mc. 'phone. JHU and JIE are new on 56 mc. The following Manhattan stations are on 56 mc.: FDF, COU, ICP, IWM. APV schedules HH5PA. AZV operates portable on 3570 kc. with 12 watts input down at Coney Island. The following are regular

(Continued on page 78)

SELECTING TRIPLETT JEWELS AND PIVOT POINTS

Precision Without
Extravagance

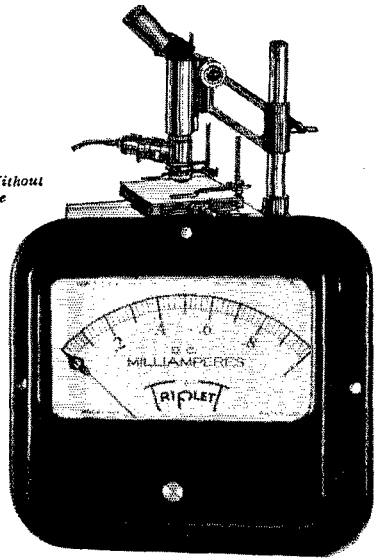

Triplet
Model 421
4" Square
Instrument

Square instrument now made in 3" size also. Both 3" and 4" square instruments are available in all popular ranges.

Accuracy in delicate instruments requires infinite care. Jewels and pivot points might look satisfactory to the unaided eye but in the Triplet factory the microscope plays an important part in selecting each pivot point and jewel.

Skilled operators examine each point for exactness of pitch and polish. Likewise, the sapphire jewel in which the pivot rides must undergo the same careful examination for polish and finish.

It is no wonder that Triplet instruments have built a reputation for precision not only when new but also after use over long periods of time.

TRIPLET MANUFACTURES

a complete line of all sizes and styles electrical measuring instruments for radio, electrical and general industrial purposes both standard and custom built. If you have an electrical instrument problem write to TRIPLET.

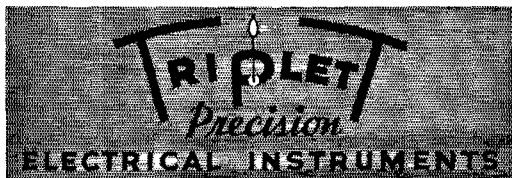

The Triplet Electrical Instrument Co.
257 Harmon Drive, Bluffton, Ohio
Without obligation please send me
_____ more information on Model 421.
_____ New 1936 Catalogue.

Name _____
Address _____
City _____ State _____

(Continued from page 70)

say that the oscilloscope is not the best device in the world for lining up a transmitter with a constant modulation frequency applied! If we use the harmonic or trapezoidal sweep of the cathode ray tube, we can follow the variations of speech much better, but again overmodulation only appears as a bright dot contrasted to a rather large figure. Besides, the manufacturers say that the life of the tube is decreased by a very sharply focussed point appearing continuously at the same position. Again, it is quite obvious that a meter which will not respond accurately to a pulse shorter than 0.01 seconds, is hopelessly out of place in any form of measuring circuit depending upon it to indicate instantaneous values.

In conclusion, it seems that the answer to overmodulation is to use continuously some sort of visual indicator such as described above. It has been my experience, after trying the gadget out for some time, that overmodulation from W9QK is deliberate if it occurs. It is hoped that these tubes will be on the market in a short time.

Sweepstakes Contest Results

(Continued from page 53)

VE2HG	13280-39-119-A-32	British Columbia	
VE2IN	7602-28-91-A-24	VE5FG	19944-48-145-A-53
VE2BK	6705-30-75-A-31	VE5AL	15228-47-109-A-38
VE2JO	6510-31-75-A--	VE5JC	6006-42-74-B-23
VE2HF	5220-29-60-A-38	VE5CC	2228-15-61-A-40
VE2AA	4788-24-72-A-41		
VE2HI*	12-2-2-A--	Manitoba	
		VE4SF	14310-45-107-A-25
Alberta		VE4SO	3540-28-43-A-27
VE4NH	20213-49-139-A-48		
VE4GE	18986-42-113-A--	Saskatchewan	
VE4EO	3844-31-64-B-25	VE4OC	29865-55-186-A-88
		VE4HU	1596-19-28-A-7
		VE4PQ	1215-18-27-A-17

Strays



A TWO-HOUR EARLY-MORNING QSO WITH AUSTRALIA JUST FINISHED

If these two gents look hungry it's because they have not yet had breakfast. They are, according to the General Electric Company's publicity release, the "Radio Brothers." The guy on the left is A. G. Hull, Technical Editor of Australia's "Wireless Weekly." On the other side of that very un-ham looking mike is Ross A. Hull, QST's Associate Editor. "A.G." was on his way back to Aussie after a world tour studying television and things when he stopped off at W2XAF to do a relay broadcast via XAF and VK2ME over some Australian B.C. stations.

"It takes a Thorobred to Win!"

FLASH!

Official DX Contest Results

GAMMATRONS USED BY WINNER OF FIRST PLACE IN THE U.S.A. . . .

91,000 POINTS!

YOU TOO CAN OWN A WINNER

See your dealer or write for
Data Sheets 354-K

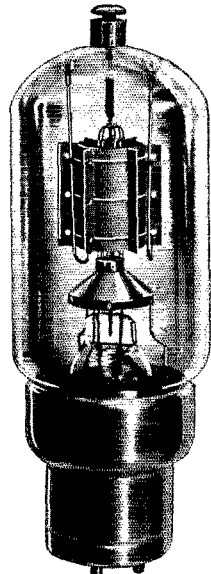

TYPE 354
GAMMATRON

**JACOBS ADJUSTABLE SEPARATOR
(Improved)**

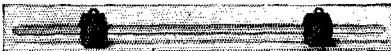

U. S. Patent 1,950,170 — March 6, 1934 — others pending
Using this improved glass Separator 2 wire R.F. feedlines of any separation from 1" up to and including 9" (used in conjunction with Hertz Antenna Systems) may be rapidly and efficiently constructed. \$1.25 for a set of 6.
CHARLES F. JACOBS (W2EM)
270 Lafayette St., New York, N. Y.

**BUD AMPLIFIER
FOUNDATION KIT**

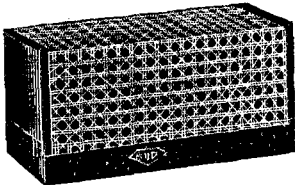

Give that amplifier a factory built professional appearance by building it on one of these units.
Undrilled chassis — 2 1/4" high. Cane design perforated metal shield cover. Finished in black wrinkle enamel.

- No. 699 — 9 1/2" x 5" x 8 1/4" high. List \$2.35
- No. 1125 — 13 1/4" x 5" x 8 1/4" high. List \$2.75
- No. 1126 — 17 " x 7" x 8 1/4" high. List \$3.50
- No. 1127 — 17 " x 10" x 8 1/4" high. List \$4.25
- No. 1128 — 10 " x 10" x 8 1/4" high. List \$3.50

40% Discount to Amateurs
New Catalog Sent Free Upon Request

BUD RADIO INC. 1937 East 55th Street
Cleveland, Ohio



JEAN HUDSON, W3BAK,
Official Champion of the
World in Class E

Two months after beginning Candler Code Training Jean could copy 30wpm on her typewriter.

FREE-1936 BOOK of FACTS

If you're "stuck," want to learn code RIGHT, or to increase your speed and technique for that com'l ticket, this book will help you. Send for it. No obligation.

CANDLER SYSTEM CO.
Dept. Q-7 Asheville, N. C.

LEARN CODE

Quickly and Easily at Home As 9 Year Old Champion Jean Hudson Did with Candler SCIENTIFIC CODE COURSE

Increase your Code Speed and Technique as Champion McElroy did with High-Speed Telegraphing and "Mill" Courses.

CANDLER SYSTEM teaches you quickly to read code by sound as easily as you read print by sight, to copy behind at high speeds without strain or confusion — to qualify for that com'l ticket!



(Continued from page 78)

operating frequencies: EAR 3540, BYL 3570, EYS 3640, KI 3665, HGO 7096. BGO handled traffic with 4CDH during the Georgia tornado disaster.

Traffic: W2IBT 531 BGO 251 EYQ 159 SC 155 (WLN 128) KI 119 PF 74 IZU 58 HRS 36 HBC 36 AZV 34 IHT 27 EAR 23 AHC 22 ING 19 IOW 17 CYX 16 EYS-BYL 12 CCD-GDF 12 FLD-BKP 11 US 10 AA 12 ADW 9 BMM 7 HGO-HXT-CIT-FIP 8 LC 7 ALZ 6 HRA 5 IZJ 4 JW-BFA-GES-CP-HJT 3 HW5-DXO-ELK-ECL 1.

NORTHERN NEW JERSEY—SCM, Chas. J. Hammersten, W2FOP—GGW is acting as net control station for N.C.R. GGE is having trouble with self-oscillation in his final. FLH operated rig at the Montclair Boy Scout Show. DLF is going in for B.C.L. set repairing. HBQ will be looking for traffic for the Jersey shore during the summer. HNP has been QRL school work. 3ETX is member of the N.N.J. QSP Club. GVZ has new HRO receiver. IAP had a good time in his first O.R.S. party. HTX worked his first ZL. HQL is member of first Signal Corps of Fort Monmouth. HFT says his new current fed ant. works FB. ICJ cleared up his B.C.L. trouble. CJX worked a U9 and J5. IQM wants O.R.S. DPA revamped his rig. New O.R.S.: HXI, HQL, ICJ and CGG. HFB is looking for O.P.S. appointment. New O.P.S.: BTZ, IDZ, Bob Waters of Montclair got JST as new call. EDJ, LI, HFZ and GHV are working 56 mc. HEJ repaired 85-foot mast with the help of GEH. ILZ is QRL dentist. HRN is complaining of 'phone harmonics on 7 mc. New officers of the Original Tri County Radio Ass'n, Inc.: GMN pres., IDZ vice-pres., HTX secy., CAY treas. CAY heard W9's on 56 mc. FOI is building portable 56-mc. rig. HVK, IKD and IYU were all bitten by the 56-mc. bug. GQX uses 825 P.P. final. HCO worked PAO during N.N.J. contest. BZJ, GAS, HBQ and HTW are now A.A.R.S. IMQ gets out FB with a little '19 on 56 mc. CDG needs only Asia for W.A.C. on 14-mc. 'phone. JJR is new ham in Rutherford. HWG is rebuilding with '10 final, 70 watts input. FKK is going to R.C.A. night school. GJK is going on high-power 'phone with 150T final. HNP is new R.M. for the N.N.J. Section. GYV was appointed 'Phone Activities Manager in charge of building up the O.P.S. activities. The Northern New Jersey QSO contest went over in great shape. Many scores were turned in and many fine prizes awarded the winners. Keep up the good work and let's see if we can reach our quota of 46 O.R.S. and 20 O.P.S. before the year is out.

Traffic: W2BCX 1037 (WLN 587) GGW 1014 GGE 875 FOP 511 HYZ 357 FLH 226 DLF 452 HBQ 208 HNP 177 HOT 176 3ETX 165 2GVZ 143 IAP 91 HTX 74 HQL 70 CGG 43 HFT 30 BZJ 29 ICJ 12 HXI 10 CJX 8 IQM 7 DPA 6 1AMZ-2 5 2IEQ 4 DVN 1.

ATLANTIC DIVISION

EASTERN PENNSYLVANIA—SCM, James M. Bruning, W3EZ—R.M.'s: 3AKB, 3AQN, 3EOP, 3ASW, P.A.M. 3E0Z. 3AGS is back on with a Class A ticket. 3AMR has resumed O.R.S. rating. 3AQN is taking his first radio vacation in five years. 3BGD needs Asia for W.A.C. 3BRZ continues as our most active all-band O.P.S. operator. 3BYS took trip to Indianapolis. 3BZP is running an endurance test on his transmitter which has now gone ten months without adjustment. 3DFC moved out to the shack for the summer air. 8DIG will be active on 56 mc. during the summer. 3EBP is taking summer radio vacation but will keep his station instantly available for emergency use. 3EOP has new Broadcasting Operator license and is looking for a job as Chief Op. at WJZ or WLW. 3EKG has been busy taking the kinks out of his new rig. 3EPJ discovered his final tank coil ungrounded itself. 3EUU continues searching for the combination which will allow QSO-ability from his location. 3EUP worked several more VK's. 3EYO received two 3.5-mc. heard cards from Germany. 3EZ installed a noise silencer on his RCA-175 and recommends it very highly for duplex phone or c.w. break-in. 3FBJ applied for O.R.S. 3FDH worked his first K6 and ZL. 8FLA traveled to Williamsport hamfest. 3FUH is building a new regenerative-beat oscillator receiver. 3IU is in line for O.P.S. 3MG put up a 14-mc. Johnson Q antenna. 8NNC is building a new rack and panel rig terminating in a 211 final. 3NF moved from S.N.J. to E. Pa. Section. 3EFS, 3GHD and 3GHP sent their first reports. 3EFS entertained 8KCC. 3ADE, 3AKB, 3ASW, 3EWJ, 3FIG, 8MRQ and 3VR are active as usual.

Traffic: W3BZP 381 EOP 243 (WLB 236) EBP 229 EZ 165 NF 123 (WLM 279) AKB 83 BYS 72 EYO 49 ADE 36 EWJ 24 EPJ 20 AMR-FIG 11 FUH 9 EFS 8 FDH 7 BGD 5

AQN 3 GHP 2 FBJ-EUP 1. W8FLA 248 ASW 164 DIG 71 MRQ 38 NNC 13.

MARYLAND-DELAWARE-DISTRICT OF COLUMBIA—SCM, E. L. Hudson, W3BAK, R.M.'s: 3CQS, 3CXL, 3EQU, Chief R.M.: 3BWT, P.A.M. 3WJ, BWT has been on the sick list. EZN has a new HRO receiver. EPD has been working lots of D.X. EHW worked his 74th country, which makes him W.A.C. CDG worked U9MF and made W.A.C. CIZ has a new Oldsmobile. ABA, CWE and W3CDQ report. CDQ will be hostess to CM2AN (Havana, Cuba) during the Atlantic Division Convention. FEG and FKT has been working the West Coast consistently from Rehoboth Beach, Delaware, on 3.5 mc. with low power. FZH experiments with 112 mc. FKT is rebuilding again. EUK has erected a new receiving antenna. DTO is still on the West Coast. We are sorry to learn that ASO has been confined to his bed with rheumatism for quite some time. CXL/WLM reports some one hundred stations enrolled as Class "A" emergency stations, equipped for operation on auxiliary power supplies.

Traffic: W3CXL 366 (WLM 2231) BWT 503 BKZ 120 CMS 92 EZN 29 CAB 10 FSP-FKT 8 EPD-BAK-FFQ-EUK 4 EHW-CDG 3 CIZ 291.

SOUTHERN NEW JERSEY—SCM, Carroll D. Kentner, W3ZX—FTK, QL, BEL, FBM, BYR and APV report via the S.N.J. Net. FXM, Hammonton, sends his first report; he uses 25 watts on all bands. FFE is on his way toward O.R.S. and visited DSC. DNU gave lightning service on message from 7NH, whom he QSO'd in O.R.S. party. ZI is operating portable-mobile rig in car all over New Jersey. BIR reports 56 mc. very active in Trenton. The last O.R.S. party gave ZX first chance to contact COT at VE2EE in Montreal. BPT is putting out feelers about getting his O.R.S. renewed. GPK is new ham on 56 mc. In an unguarded moment DQO blew most of the tubes and meters in his transmitter, but he is back on now with 250 watts to an '03A. FOS has been QRL school work. FTK made B.P.L. for fifth month in a row with fine bunch of schedules.

Traffic: W3VE 55 FFE 7 DNU 41 AVJ 19 ZI 182 BIR 2 BPT 119 EFM 146 (WLNJ 84) AEJ 6 DQO 10 FOS 48 BO 44 APV 351 BYR 75 FBM 68 BEI 10 FTK 587 ZX 33 EKL 35 EQ 47.

WESTERN NEW YORK—SCM, Charles Smith, W8DSS—Chief Route Manager JTT again leads the Section, but for the last time, as he is intending to join up with Uncle Sam soon. Best of luck to you, Roger. MQX took over some of the schedules of JTT. LWD cancelled all schedules for the summer. FUG gets most of his traffic from A.A.R.S. GWY is QRL for the summer. MBI would like a good schedule for the summer. BJO, R.M., is all set to get some big totals now that his shack and transmitter have been rebuilt. CPJ leads the O.P.S. again. BQJ is doing nice work on 56 mc. LGV and LGR attended Utica A.R.C. Field Day with the latter taking credit for making the portable transmitter that was used there. PCW is moving to his summer home and reports AXN re-licensed. LUQ is QSO Asia daily on c.w. OMJ wants O.P.S. PUM and PVH are new hams in Jamestown. GWT wants long distance traffic schedule. BHK is QRL refrigerator business. AQE is working nights and cancelled schedules. KKR and CP show fine cooperation in the Cairo Survey. The monitoring is being done at the shack of CP, who is serving beer, coffee and sandwiches to all operators assisting. NWK is father of nine-pound YL op. Congrats. LGS and NWT are rebuilding shack and transmitter respectively. NTY is working nice DX on 14-mc. c.w. Cayadutta A.R.A. is getting busy on 56 mc. Oneida and Rome Radio Clubs attended the Field Day of the Syracuse Club at Fayetteville. The Oneida Club invites you to Panther Lake, July 19th.

Traffic: W8JTT 1238 DSS 270 MQX 170 CSE 102 LW 79 FUG 44 MBI 35 GWY 41 GZM 28 BJO 25 CPJ 14 BQJ-LGV 8 EUY-LUQ 4 PCW 3.

WESTERN PENNSYLVANIA—SCM, C. H. Grossarth, W8CUG—LOQ is going to college this fall. UK is now D.N. C.S. of PA5 in the A.A.R.S. KBM says KUI has a job in St. Marys. OFO was appointed D.N.C.S. 2 of PA5. KNB expects to bag a little DX this summer. KUN wants to take a crack at 28 mc.; welcome to the O.R.S. gang, Joe. George is leaving YA next month and will be on at 3AMR. FDD and JZN signed up with the N.C.R. IOH needs Nevada for his W.A.S. Congrats to CMP on the election. IBX has a new 500-watt outfit. MIW is after an O.R.S. GUY has been playing around with 28 mc. CUG is busy rebuilding.

Traffic: W8LOQ 411 UK 277 KBM 154 OFO 121 KNB 116 KUN 106 YA 57 (WLM 278) KOB 48 IOH 33 CMP 35 NDE 29 INE 21 AXD 14 MIW 8 GUY 1 CUG 11.

FOCUSSED TONE - GENERAL ELECTRIC YEARS AHEAD



Focused Tone

REVOLUTIONIZES TUNING
- AUTOMATICALLY ASSURES
PERFECT TONE

**RADIO'S
NEWEST
MARVEL**

Watch for Your
Local G-E Radio
Dealer's Display of
G-E Focused Tone
Radio Models
Early in July

You'll ALWAYS Be Glad You Bought
a General Electric Radio

GENERAL  ELECTRIC

Focused Tone Radio

APPLIANCE AND MERCHANDISE DEPARTMENT, GENERAL ELECTRIC COMPANY, BRIDGEPORT, CONNECTICUT

LEEDS Leads WITH SUMMER BARGAINS

Our Vacation Special

ATWATER KENT Model No. 48 TRF broadcast six tube battery receivers, in sealed cartons. These receivers may be operated from 6 volts with 201 A's, or 2 volts with 230's with 90 volt B battery. Ideal for the summer camp "beyond the power line." Quantity limited — better order early. Less accessories **\$4.95**

WESTINGHOUSE AND SANGAMO Watt Hour Meters

110-120 volt; 60 cycle 2 wire meters. The meters are used instruments in perfect condition, tested and reset to zero. A fifteen dollar value, at the extremely low price of **\$3.50**
Shipping weight 15 lbs.

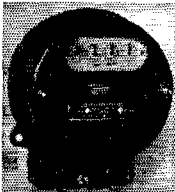

IMPORTANT ANNOUNCEMENT

On Our NEW LD-5 Mounted Crystals

These low drift plates, factory sealed in the new LEEDS metal holder are outstanding from the standpoint of stability, accuracy, high output and low cost. Low Drift — 5 cycles per million per degree. Accuracy of calibration — better than .05%. Orders filled plus or minus two kc. of specified frequency. Last but not least, the price of the mounted crystals, anywhere in the 160-80 and 40 meter bands is only **\$3.50**

Money back guarantee if you are not completely satisfied.

Thousands have discovered noise silencer adapters are a great help on reducing natural static too. Leeds "QUIET CAN" and "SILENT CAN" also provide freedom from ignition noises and afford an ideal arrangement for push to talk phone and break-in CW.

Leeds "QUIET CAN" for receivers with two IF stages; complete with tubes and instructions ... **\$8.55**

Leeds "SILENT CAN" illustrated herewith, for receivers with one IF stage; complete with tubes and instructions... **\$10.95**

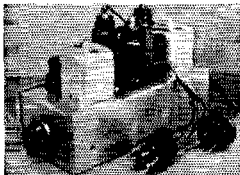

GENERAL RADIO VARIACS

Are the ideal answer to the QRP problem

Type 200 CU delivers 0-135 volts continuously variable at 900 watts from 115-volt line. Price **\$14.50**
Type 200-B — 0-115 volts at 170 watts. Price **10.00**
No. 100-K — 0-115 v at 2000 w. Price **40.00**

LEEDS carries a complete line of G.R. Amateur accessories and laboratory apparatus. Bulletin No. 936 mailed on request.

NAVY TYPE TELEGRAPH KEY

List \$3.60. Navy knob — 1/8" Tungsten contacts. Only a few left at **\$1.15**
With regular knob **.95**

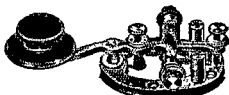

Tel. COrtlandt 7-2612

45 VESEY STREET
NEW YORK CITY

Cable Address: "RADLEEDS"

A High-Power Three-Stage C.W. Transmitter

(Continued from page 48)

to the grid current flow, and going sour just when they are needed most.

The remaining power supply is the high voltage unit which provides the plate voltage for both doubler and final. This supply is provided with an overload relay for the protection of the power equipment and the tubes. The filter in the high voltage supply is a single section affair consisting of a 5- to 25-henry swinging choke and a 2- μ f. 3000-volt oil filled condenser in conjunction with a 100,000-ohm 150-watt bleeder. Incidentally, a high voltage power supply is not a thing to be careless with. Make certain that you have a good bleeder on it and always take the extra precaution of shortening the condenser with a well insulated piece of wire before you go poking around in its innards; being sure, of course, that the supply is disconnected from the line first.

Since this rig is intended primarily for c.w. operation the ratio of L to C in all circuits was made purposely high. One turn at each end of the link coupling the oscillator to the buffer proved sufficient, the turns on the other link circuit being more or less a matter of experiment and being adjusted to provide maximum drive to the HF-200 grids with minimum loading of the buffer stage.

The bias on the 203-H was set at 135 volts and that of the HF-200's was set at 180 to 225 volts. The efficiency of the final amplifier stage should, with reasonable care in construction and wiring, run around 75 to 80%. The power output on the crystal frequency is 750 to 800 watts.

Strays

Hams having access to one of those little stapling gadgets used in offices for fastening sheets of paper together have at hand the means for making a neat job of fastening QSL cards together for wall mounting. W9HUO, who suggested the stunt, fastens them together in strings of 15 or 20, the top and bottom cards being stuck to the wall with the usual thumb tacks. The cards can be readily cleaned without danger of tearing down the row when a cloth is run over them, and can be disconnected without much trouble and no damage.

WIKE writes that not only was Noah one of the first hams because of his "arc," but that he also had a son named Ham!

Suggestion for signal reports: W3ETI says that so long as we tack an "X" on the RST report to indicate a crystal sig, why not use "C" to indicate a chirp? Logical enough—and saves spelling it out.

While discussing DX during one of their regular QSO's, W2ECL asked W2HMJ if he thought a YL ever worked an OM!

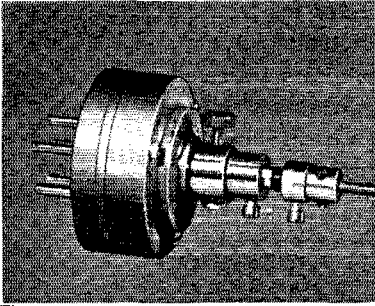

TUNING THE CRYSTAL

A new device providing crystal control at an easily-adjusted fixed-frequency.

Net Price (less Crystal)—\$5.70

With Hollister Crystal—\$19.50

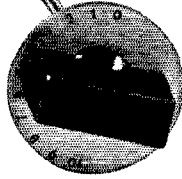

FEATURES:

Frequency change of one part in 600.

Low loss R39 Housing, totally inclosed.

Plug-in mounting.

Flexible shaft drive for convenient panel control.

Locking device for fixed-frequency operation.

National presents a new adjustable-gap crystal holder with front-of-panel control of frequency. It is designed particularly for use with special Hollister A-cut crystals, and when properly installed will provide a frequency range of 6 kc. at 3500 kc. nominal frequency. Frequency spread is proportionately greater when operating on harmonics, as for example 24 kc. in the 20 meter band. Crystals specially selected for this service should be used, as some A-cut crystals are wholly unsuitable for variable frequency use. Holders are sold either without the crystal, or with a genuine Hollister 80 meter crystal for doubling into the 20 meter band. Crystals for other bands will be available later.

NATIONAL COMPANY, INC., MALDEN, MASS.

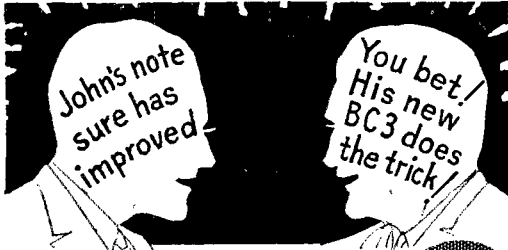

BLILEY BC3
CRYSTAL UNITS
40-80 METER BANDS

\$3.95 and up



HANDY MIDGET Electrolytics



Series GLS 1" dia. can units half height of former units (to save space) or twice capacity for given size (for better filtering). ● Inverted mounting. Color-coded leads. ● In 200 and 450 v. working ratings. Several capacities. And inexpensive. ● Send for catalog.

AEROVOX
CORPORATION

73 Washington St. Brooklyn, N. Y.

Radio Operator's Course

Complete in
Telegraphy—
Telephony



Practical
Experience
Studio—
Transmitter—
Announcing

P. A. C. is an endowed, educational institution — not privately owned, not operated for profit, college rank maintained. Course consists of maximum knowledge necessary to secure Commercial Telegraph Second-class, and Radio-telephone First-class government licenses. Course includes Wireless Code, Radiophone, Announcing, Microphone-Studio Technique, Service, Police, and Aeronautical Radio. We are authorized to teach RCA texts. At the completion of course you receive practical studio technique experience in our commercial broadcast studios located in the administration building, and experience as an operator on K P A C (500-Watt Commercial transmitter located on the campus, owned and operated by the college), and inter-departmental marine communication experience. If interested, write for Bulletin R.

PORT ARTHUR COLLEGE

Port Arthur (World-known port) Texas

MR. E. H. RIETZKE

PRESIDENT OF CREI

WE'RE INTERESTED IN MEN WHO HAVE JOBS . . . BUT WANT FUTURES!

If you're a man who wants to rise above the ranks of the average — who has ambition to reach "the top" — then you'll be interested in the CREI Practical Radio Engineering course.

Our one-year Residence Course, begins Sept. 14 or by home study at any time.

SURVEY PROVES CREI GRADUATES GET BETTER JOBS AND SALARIES

A recent survey of CREI graduates proves that our training is beneficial. These statistics show that the majority improved their positions at an increase in salary. *There must be reason.*

Write today and let us send YOU the facts

• Write for FREE 48-Page Catalog!

CAPITOL RADIO ENGINEERING INSTITUTE

Dept. Q-7

WASHINGTON, D. C.
14th and Park Road

NEW YORK CITY
29 Broadway



GTC AMATEUR PLATE TRANSFORMERS are DUO-PRIMARY

HIGH OR LOW
POWER AT THE
SNAP OF A SWITCH
(Patent applied for)

● Off resonant currents get plenty high. Don't damage expensive tubes or equipment when tuning with high power. Use GENERAL TRANSFORMERS with fingertip control — all switching done in the primary — at low power — safely, economically, practically.

Tune with safe Lo Power — Snap, and the "soup's on!" Snap to Lo for those local QSO's! Snap and you're set for DX!

Switching power with G T C's does not affect efficiency of the unit, whereas tremendous power would be wasted if resistors were used for Hi-Lo Power.

All controls on the front of the panel — you don't reach behind and run the risk of tangling with high voltage. Changing power by switching high voltage terminals is dangerous — 3,000 volts is no toy.

Fingertip switching with GENERAL'S is the safe answer — it eliminates those cold sweat visions of tubes going up in smoke.

GENERAL TRANSFORMER CORPORATION
518 S. Throop Street Chicago, Illinois

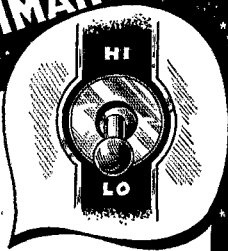

Silent Keys

It is with deep regret that we record the passing of these amateurs:

Leon Anderson, K7AGZ, Unalaska, Alaska
G. M. Baynham, VE3TX, Toronto, Canada

Donald Bean, W5CZG, Little Rock, Ark.
Matlock Cawthon, W4AQY, DeFuniak Springs, Fla.

Edmund F. Doherty, W7AHH, Walla Walla, Wash.

W. K. Ennis, W5CUI, Houston, Texas
Harry Friedman, W2FX, Bronx, N. Y.

Robert M. Furlong, W3CDU, Baltimore, Md.

Charles H. Hough, W1APG, Milton, Mass.
Orin P. Lee, W1GVM, Boston, Mass.

W. F. McKee, W9LLB, Webster Groves, Mo.

Mrs. Meta Overton, XYL at W4AOK, Bartow, Fla.

Francis J. Palmer, W1FII, Somerville, Mass.

Ray F. Rohrscheib, W6AIF, North Hollywood, Cal.

Kunio Shiba, J2HJ, Tokyo, Japan

A. K. Weaver, Jr., W5AHR, Corinth, Miss.

Henry Westphal, W2IU, Elmhurst, L. I., N. Y.

A 500-Watt Transmitter With Band-Switching Exciter

(Continued from page 18)

to ignite half of the column is obtained by a 3-turn loop around one of the antenna feeders. Such an indicator certainly indicates the modulation, while the antenna meter pointer hardly budges while talking.

After the set has all the "bugs" removed, the plate voltage may be raised to 1500 without fear of any breakdowns, if 805's are used.

For other methods of 'phone modulation, such as grid-bias on the final or linear Class-B operation of the final (suppressor-modulating the pentode) the tuning follows the practice previously referred to.

RESULTS

This transmitter was originally constructed with the idea of being a compact transmitter for use when the regular high-power job was not in service. Since it was first put on the air in early March, however, no other rig has been used at W1SZ. This rig made WAC 8 times during March on c.w. Although it has been on 14-mc. 'phone only three weeks, countries have been

5-METER SPECIALS

R.C.A. Transceiver\$19.95
Sickles 5 M. Kit 1.20
Mike and Audio Trans. 1.20
Output Trans.90
5 M. Pole with Insulator 1.50
E.O.I. Cable, per foot06
Dunco D.P. St. Relay 2.00

ACCESSORIES

Eimac 35 T. \$8.00
Astatic Crystal Microphone, K22 \$22.50
Astatic Crystal 104 13.50
Amperite Velocity Mike. 19.20
Tobe 2 Mfd — 2000V Condenser	2.45
Tobe 1 Mfd — 2000V Condenser \$1.70
Tobe Communication Receiver Kit (Complete (Air Trimmers)) \$47.40
Tubes R.C.A. 3.32
R.C.A. 955-\$3.75	R.C.A. 954-\$5.80

Used Tubes and Equipment

R.C.A. 204A\$20.00
R.C.A. 852 9.00
Sylvania 860 9.00
W.E. 276A 7.00
R.C.A. 849 30.00
Sky Rider TRF 20.00

We have the largest stock of amateur essentials in New England. We can supply it... and with snappy, prompt, satisfying service.

THE RADIO SHACK

INTERNATIONAL PLATE TRANSFORMERS

FULLY CASED

Model 2000 — 300 Mills	\$5.95
750-1000 each side
Model 3000 — 300 Mills	\$8.95
750-1000-1500 each side

2.5V-12A. Trans. (cased) for 866's.....\$1.50

INTERNATIONAL CASED CHOKES

12 H — 200 Mill	\$2.50	5/25 — 200 Mill	\$2.50
12 H — 300 Mill	3.75	5/25 — 300 Mill	3.75
12 H — 500 Mill	6.50	5/25 — 500 Mill	6.50

866 Tubes H.D. \$1.00

PYRANOL 2 MFD. 2000 VOLTS CONDENSERS

Unconditionally Guaranteed for 2 years. **\$2.90**
Need we say more?

SUPER SKY RIDER (Crystal) **\$89.50**

SUPER SEVEN **\$49.50**

NEW SKY BUDDY **\$29.50**

All in Stock... Immediate Delivery

Mail Orders Filled... Send Money Order

THE RADIO SHACK
46 BRATTLE STREET
BOSTON, MASS.

..... TUBES

R.S. 203A Graphite\$9.00
R.S. 800 Graphite 5.93
R.S. 801 Graphite 2.93
RAYTHEON R.K. 23-25 4.50
RAYTHEON R.K. 20 15.00
RAYTHEON R.K. 28 38.50
R.C.A. 800 10.00
R.C.A. 801 4.50
R.C.A. 802 3.90

ACCESSORIES

Baldwin Type C Phones.....\$2.50

Thordarson Trans. 1200V. C.T. 200 mills 5V-3A, 2.5V-10A, 7.5V-3A.....\$2.75
Valpey unmounted 80-160M. Xtals. \$1.50

Valpey mounted 40-80-160M. Xtals. \$3.00

Trimm 24,000-ohm Phones... 5.88
Johnson 50 Watt Socket..... 1.05
Johnson 5 M. Q. Antenna... 3.90
Johnson 10-20 M. Q. in stock.

10V-6.5A (Cased) Fil. Trans...\$2.50

Cardwell XC-75-K.D. (6000V) \$10.20

Cardwell MT-100 G.D..... 4.80

Cardwell XT-220 P.S..... 2.40

Cardwell XT-210 P.D..... 4.80

Complete Stock Always on Hand

Triplet 3" Bakelite cased meters 0-5 to 1000 Mills.....\$3.75

Triplet 2-inch Size..... 2.92

Triplet No. 1200 Volt Ohmmeter 21.67

Readrite Mill Meters..... .60

VALPEY CRYSTALS STEP BY STEP PRECISION MADE

Type VM2. Mounted crystal within 5 Kc of specified frequency 1.7, 3.5, 7 Mc Bands.....\$3.00

Type VC2. Unmounted x cut within 5 Kc 1.7, 3.5, 7 Mc Bands.....\$2.25

Type VC2 in 1.7, 3.5 Bands only. Plus or minus 20 Kc.....\$1.50

Type VM2A. AT cut mounted. Drift less than 4 cycles per Mc per degree C 1.7, 3.5, 7 Mc Bands.....\$4.50

Type VC2A AT cut unmounted drift less than 4 cycles 1.7, 3.5, 7, Mc Bands.....\$3.50

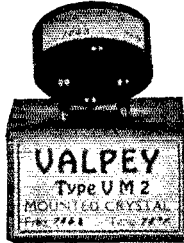

Crystals for All Requirements. At Your Dealer's or Order Direct.

The Valpey Crystals

377 Summer Street, Medway, Mass.

LET'S DO BUSINESS

Your inquiry about any apparatus will prove that it is to your advantage to buy from W9ARA. All makes of amateur apparatus in stock at lowest prices. Your used apparatus taken in trade. Time sales of all makes of receivers and transmitters made on terms to suit you. Receivers shipped on ten day trial.

TRADE IN YOUR RECEIVER AND TRANSMITTER

Collins, RCA, RME, Marine Transmitters

All Star transmitters in kits or assembled

The New National NC-100s\$105.00
RME-69s 118.80
Bretling 12c complete with crystal prepaid 93.00
National HRO Jrs 99.00
National HROs 167.70
RCA ACR-175s 119.50
PR-16Cs complete prepaid 101.70
Crystal Super Pros 241.05
S9 metal tube Super Skyriders 79.50
The new Sky Buddy 29.50
The new Ultra Skyrider 99.50

HENRY RADIO SHOP

211-215 North Main Street

BUTLER, MISSOURI

CORNELL-DUBILIER

TYPE 86 *Transmitting* MICA *Condensers*



Based upon experience gained through more than twenty-six years of specialization in the manufacture of condensers, C-D Mica Capacitors achieve a standard of perfection that is completely unrivaled!

Check these definite advantages of the Type 86 High Voltage Mica Condensers for use in tank circuits, plate blocking, grid, antenna coupling and other important functions in the "rig" where dependability is essential.

✓ Loss of power flowing through capacitor fully 1/20th that of ordinary or flint glass dielectric capacitors.

✓ Ceramic casing insulates condenser from interfering ground capacity.

✓ Ceramic casing prevents field absorption, hence lower R.F. resistance.

✓ Capacity remains constant at high frequencies and at temperatures that would materially damage glass dielectric capacitors.

Write today for Catalog No. 123 listing in complete detail these and other transmitting condensers.

CORNELL-DUBILIER

CORPORATION

4373 BRONX BOULEVARD
NEW YORK

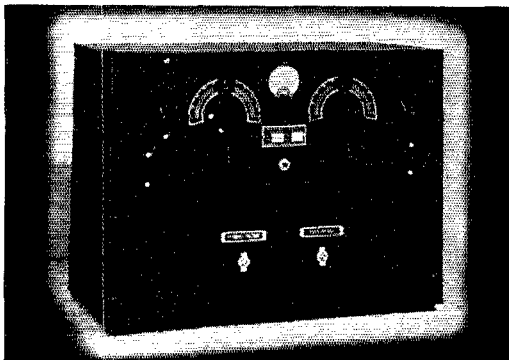

THE 60-X CW TRANSMITTER

is hard to beat in price and performance

- Rated input 80 watts
- Band switching and crystal selection
- Compact size
- Immediate delivery

- Net price as shown above... **\$69.50**
- All tubes and two LD2 crystals **27.00**

Write for Full Details

HARVEY RADIO LABORATORIES, INC.
12 Boylston Street Brookline, Mass.

Export: 25 Warren St., N. Y. C. Cable: "Simonrice"

"The Crystal Specialists Since 1925"

PIEZO-ELECTRIC CRYSTALS

Guaranteed Accurate to BETTER than .01%

SCIENTIFIC RADIO SERVICE

UNIVERSITY PARK, HYATTSVILLE, MD.

AMPERITE Leads Again -

New! EXTERNAL INPUT TRANSFORMER

(Cable type Model LGP)
NOW ENABLES USE OF LOW IMPEDANCE MICROPHONE WITH AMPLIFIERS HAVING HIGH IMPEDANCE INPUT

Up to 2000' of cable can be used

Hum trouble is entirely eliminated by special balanced windings... Extra heavy case will withstand mechanical abuse... Not to be confused with ordinary input transformer.

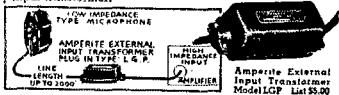

P.S.: For jobs using cables no longer than 125' we still recommend Amperite Velocity Model RB-B (2000 ohms) with high impedance input

New! DUAL-IMPEDANCE MICROPHONE

FOR HIGH OR LOW IMPEDANCE AMPLIFIERS

Can be used with high impedance input with cable lengths up to 125'... or low impedance input with cable lengths up to 2000'. JUST PLUG IN THE PROPER CABLE. NO DEAD WINDINGS OR TAPS—therefore, maximum efficiency for low or high impedance connection

FREE COMPOSITE DIAGRAM OF MICROPHONE HOOK-UPS. It's valuable. Write for it now. Also NEW ILLUSTRATED BULLETINS ON MICROPHONES and STANDS.



AMPERITE Company 561 BROADWAY, N. Y.

AMPERITE Velocity MICROPHONE

worked, scattered in all continents, including nearly two dozen VK contacts. This was accomplished with Class-B plate modulation of the final. Naturally one cannot expect the best results without the best possible antenna system permitted by the location. This rig is used on a vertical system consisting of two vertical sections stacked one above the other, working as half-waves in phase on 20, as two full waves on 10, and as a center-fed half-wave Hertz on 40 meters. For lower frequencies a separate horizontal Zepp is used.

A.R.R.L. QSL Bureau

FOR the convenience of its members, the League maintains a QSL-card forwarding system which operates through volunteer "District QSL Managers" in each of the nine U. S. and five Canadian districts. In order to secure such foreign cards as may be received for you, send your district manager a standard No. 8 stamped envelope. If you have reason to expect a considerable number of cards, put on an extra stamp so that it has a total of six-cents postage. Your own name and address go in the customary place on the face, and your station call should be printed prominently in the upper left-hand corner.

W1—J. T. Steiger, W1BGY, 35 Call Street, Willimansett, Mass.

W2—H. W. Yahnel, W2SN, Lake Ave., Helmetta, N. J.

W3—R. E. Macomber, W3CZE, 418 10th St., N. W., Washington, D. C.

W4—B. W. Benning, W4CBY, 520 Whiteford Ave., Atlanta, Ga.

W5—E. H. Treadaway, W5DKR, 2749 Myrtle St., New Orleans, La.

W6—D. Cason Mast, W6KHV, 423 East E Street, Ontario, Calif.

W7—L. Q. Kelly, W7BPC, 4919 So. Prospect St., Tacoma, Wash.

W8—F. W. Allen, W8GER, 324 Richmond Ave., Dayton, Ohio.

W9—George Dammann, W9JO, 319 Sherman Ave., Evanston, Ill.

VE1—J. E. Roue, VE1FB, 84 Spring Garden Rd., Halifax, N. S.

VE2—W. H. Oke, VE2AH, 5184 Mountain Sights Ave., N. D. G., Montreal, P. Q.

VE3—Bert Knowles, VE3QB, Lanark, Ont.

VE4—Dr. J. J. Dobry, VE4DR, Killam, Alberta.

VE5—E. H. Cooper, VE5EC, 2024 Carnarvon St., Victoria, B. C.

K4—F. McCown, K4RJ, Family Court 7, San-turce, Puerto Rico.

K7—Frank P. Barnes, K7DVF, Box 297, Wrangell, Alaska.

KA—George L. Rickard, KA1GR, P. O. Box 849, Manila, P. I.



W3FLC reports that W3FOX, prior to getting his ham ticket, worked on a fox ranch!

"Type TR-6A6"

- Better Than Ever
 - 7 Tubes — Dynamic Speaker
 - New 6E6 Unity Coupled
 - 10 Watt Carrier
 - 100% Modulation
 - Duplex Operation — PHONE ● ICW
- F.O.B. FACTORY
Less Tubes
\$39.75

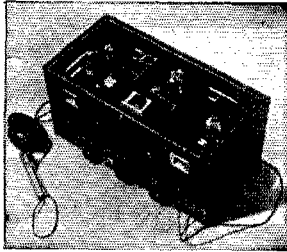

"The Compact"

- Integral Batteries
 - Five Tubes — 1A4, 30, 30, 19, 19
 - 2 Watt Carrier
 - 100% Modulation
 - Duplex Operation
- F.O.B. FACTORY
Less Tubes
\$26.50

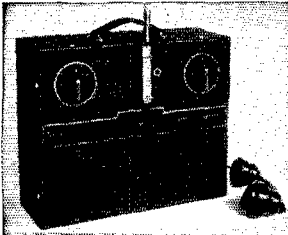

AT LAST! A compact Portable Transmitter and Non-Radiating Receiver for the popular Ultra-High Frequencies . . .
JUST THE STATION TO TAKE ON VACATION

Descriptive Bulletins on Request

RADIO TRANSCEIVER LABORATORIES

General Office and Plant: Richmond Hill, New York

"Iconoscopes and Kinescopes in Television" (Dr. V. K. Zworykin) is one of the articles by engineers of RCA and associated companies, covering developments in many branches of the radio field, in the first (July) issue of the new

RCA REVIEW

A Quarterly Journal of Radio Progress

\$1.50 a year; outside U. S., \$1.85

RCA INSTITUTES TECHNICAL PRESS

A Department of RCA Institutes, Inc.

75 Varick Street

New York

THE RADIO AMATEUR'S LICENSE MANUAL

Going after your first ham ticket? You need the manual for its instructions on where to apply, how to go about it in the right way — and, most important of all, for the nearly 200 typical license exam. questions and answers.

All the dope on every phase of amateur licensing procedure, and, of course, the complete text of the new regulations and pertinent extracts from the basic radio law.

A necessity for the beginner — indispensable to the licensed amateur

Order Your Copy Today, 25c postpaid (no stamps, please)

AMERICAN RADIO RELAY LEAGUE, WEST HARTFORD, CONNECTICUT

Already a licensed amateur? The manual is still necessary — for its dope on renewal and modification procedure, the Class A exam. (with questions and answers), portable procedure, etc.

SICKLES COILS

ALL TYPES OF RF AND IF WINDINGS

Manufactured by

F. W. SICKLES COMPANY

300 Main Street

Springfield, Mass.

THE PERFECT CODE TEACHER! NEW MASTER TELEPLEX

For beginners, experienced operators, and schoolroom. The sure easy way to learn code and to step up your speed. This amazing new instrument will record your own sending on double row perforated paper and repeat it back to you at any speed you desire. 10,000 words can be recorded on one tape.

**NO BATTERIES
NO WINDING
ALL ELECTRIC**

It is the same in principle and in operation for this service is equal to the Wheatstone Perforator and Transmitter, which cost over \$1,000.

BUY IT OR RENT IT

Send for Folder Q-7, which tells you how to get the use of this instrument without buying it. No obligation. We furnish complete course and personal instruction with a money-back guarantee. Low cost, easy terms. Write today for information.

TELEPLEX CO.

72 Cortlandt St.

New York City

The New Master Teleplex "The Choice of Those Who Know"

Utah
TRANSFORMERS
and CHOKES

Send for complete Reference Guide on Battery Transformers and Chokes for all Receiver and Transmitter Types.

UTAH RADIO PRODUCTS CO.
Orleans St., Chicago

Note
These
New
Features

4 sizes for
use on 5
to 160 meter
transmitters

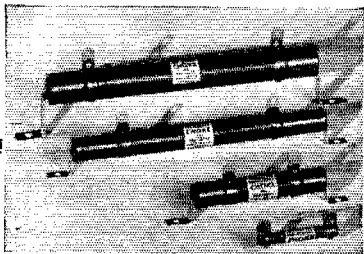

OHMITE R. F. CHOKES

■ These improved OHMITE R.F. Chokes are single-layer wound on ceramic tubes. They are coated with a moisture-resisting material which anchors the turns firmly in place. Ample space is allowed at the ends of the choke to prevent flashover to ground when mounted with non-magnetic brackets which are part of the unit. Write for descriptive bulletin with diagrams, FREE. Choke applications are fully discussed in a chapter wholly devoted to chokes in the latest OHMITE Amateur Handbook. Get a copy from your dealer, or send 10c to

HANDBOOK
PAGES
458-459
CATALOG
SECTION

O H M I T E

MANUFACTURING CO.

4831 Flourney Street

Chicago, Illinois

NOTICE REGARDING TELEVISION!

● Large radio companies have experimental television pictures on the air. Progress will be rapid. Many opportunities. **STUDY** television thoroughly... NOW! Get a copy of "Television With Cathode Rays"... hot off the press. Required 5 years to write. \$2.75 per copy, which includes free quarterly supplement service for one year. Order from:

Pacific Radio Pub. Co., Pacific Bldg., San Francisco, Cal.

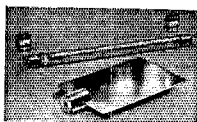

Oscilloscope Kit

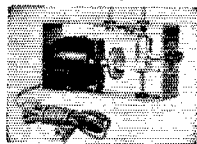

Vari-Speed Motor

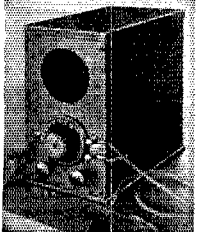

The Finished Job!

BE FIRST — Make this highly sensitive—accurate NEON OSCILLOSCOPE

Inexpensive! Checks on your signal modulation, quality—and the other fellows'. Useful in service work.

KIT. Includes improved tube with finest fidelity response—gives a clear defined picture; clips, scanning mirror and motor shaft adapter included. Only \$2.00 net

VARI-SPEED MOTOR. This type motor necessary for expert results. New control for absolutely constant speed. Makes your oscilloscope a precision instrument. Now.....\$9.50 net

(With 10 to 1 reduction shaft as illustrated, for displays, etc....\$2.00 extra)

COMPLETE KIT. All essentials included, vari-speed motor, neon tube, etc. Low net price.....\$11.50

10" NEON TUNING WAND. Very sensitive, for tuning and neutralizing transmitters. A real instrument for experimenters. Only.....75c Ea. net

Order today

SUNDT ENG. CO.

(Affiliate of Littell Labs.)

4246 Lincoln Ave., Chicago, Illinois

Simplifying the Push-Pull-Push Crystal-Oscillator

(Continued from page 18)

in locations L_1 or L_2 . For 160 and 80 meters practically full condenser should be used. For the higher frequencies the coil should be trimmed to use progressively smaller capacity settings. Very small wire was used for the 160- and 80-meter coils here and, when loaded, no heating was apparent; however, larger wire is specified in the coil table. Coupling to the load can be by means of coil taps or from a link wound tightly over the coils. The coils have been carefully computed for the various capacitances in the circuit, but don't expect that a little trimming won't be necessary. It will be well to put on a few extra turns, remembering that the plate coil must serve for both push-pull and push-push duty. The push-push connection has considerably more capacity "padding" effect than the push-pull.

It is hoped that builders of this simple transmitter (or exciter) get as much enjoyment out of it as I have. It is easy on crystals and it takes but a moment to change bands. If you want more output try a couple of RK-20's in the same circuit using an A-cut crystal.

The second part, describing a number of "trick" circuits for crystal oscillators and frequency multipliers, will appear in a coming issue.—EDITOR.

Five Meters Again Shoots the Works

(Continued from page 9)

He heard these nines: JHY, CC, PKU, JDE, LBP, TLQ. He also reports hearing W9UAQ working W1FHN and says that W1DVO managed to get a contact with Chicago.

Waterbury, Conn.

Frederick Ellis, Jr., W1IYX managed to pull off a good contact with W9UAQ and was heard by W9WUS. W1IYX used an eight-element array with a pair of tens. The receiver is a one-tube superregen.

Baltimore, Md.

John E. Knight, W3GAH, contacted W9PEI and heard W9PKU, W9BIR, W9WN, W9UAQ, W9PMQ and W8NUR with a two-tube superregen. He reports rapid fading on all stations from R9 to about R4. W9PMQ's signal, he reports, was the last one to drop out—at 11:45 p.m.

These reports, of course, do not paint the whole picture. We know that scores of stations around New York and, for that matter all along the coastal states participated in the orgy of DX.

"Yeah," we hear someone say, "now tell us why it happened and when it will happen again." At which point we get thoroughly stuck. Without much doubt the period was one during which an unusually heavy sporadic E-region ionization occurred (as one ionosphere specialist puts it), but there is nothing much more to offer.

Introducing New Automatic CODE X-MITTER

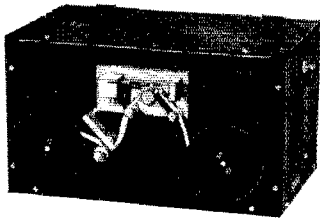

Uses Kleinschmidt Perforated Tape
Automatic Rewind 5 to 75 w.p.m.
12 x 8 x 7 inches All parts nickel plated

A scientific and useful apparatus designed particularly to fill the needs of amateurs. Sensitive polarized relay; AC or DC; 1/8 h.p. motor with hash filter; smart crackle finished black cabinet; 2000 words of press tape FREE with each unit. Specially priced to hams at \$50.00, F.O.B. New York City.

WATCH for Tape Recorder that will record 100 w.p.m. \$30.00
Details to be announced soon

UNIVERSAL SIGNAL APPLIANCE
64 West 22nd Street New York City
Blueprints of either machine — \$1.00 each

YOUR "EAR" TO THE FUTURE

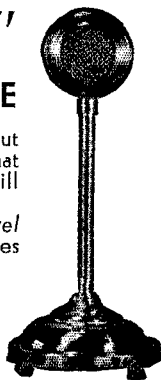

HiLevel can be used without "clipped" limitations on that P. A. you or some friend will have.

On your phone rig HiLevel performs efficiently and gives you a full HUMAN voice.

DUAL PURPOSE MICROPHONE

It is unnecessary to cripple a microphone with such clear clean response. However, if you prefer the extreme sharpness characteristic of the communications type, shunt a 1/2 megohm resistor across the microphone terminals or any convenient place in the line or input.

At 4 cents cost this simple operation frees you from "clipped" voice limitation when you wish to transfer your microphone.

For detailed information ask your dealer, or, write

THE TURNER COMPANY
CEDAR RAPIDS, IOWA, U. S. A.

Licensed under patents of the Brush Development Company

HiLEVEL

stand and 8' cable
LIST \$25.00

Specifications output level minus 54 D. B. Frequency response flat from 500 to 6000 cycles.

Learn CODE Right . . .

— the Practical, Easy Way —



Instructograph

Experts agree: it pays to learn from a perfect teacher — Instructograph. It's easy to become a test operator when you can practice Radio or Morse at your convenience — at any speed you want. Comes in two models — Senior or Junior Economy. You may buy or rent, at low cost. Just send post-card for complete details now to —

INSTRUCTOGRAPH COMPANY, Dept. Q-7
912 Lakeside Place Chicago, Illinois
Representatives for Canada
Radio College of Canada, Ltd., 863 Bay St., Toronto

MAC KEY AT \$7.95

finest speed key built

MAC OSC at \$3.95 ac/dc oscillator. Tone control.

MAC CORD \$1.00 navy spfn speed key cord.

MAC MARINE receiver 550-850 meters, r u intd?

Few deluxe MAC KEYS at \$15.00 fm me di. Wri me.

T. R. McELROY, 23 Bayside St., Boston, Mass.

If u hv Mac Key wri me for xby ipt & dsfb ifn.

NEW! BIRNBACH STEATITE CONE INSULATORS

STEATITE's superior physical and electrical qualities make these insulators exceptional. Easily mounted. Complete with cork washer and mounting screw.

Write for
Bulletin Q-7



5/8" High
No. 430
10c



1" High
No. 431-15c
No. 431J-20c



1 1/2" High
No. 432-20c
No. 432J-25c



2 3/4" High
No. 433-25c
No. 433J-50c

Birnbach Radio Co., Inc. 145 Hudson Street
New York City

PRECISION CRYSTALS

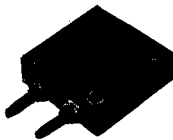

Crystal Holder

Highest quality crystals one-inch square, carefully ground for frequency stability and maximum output. Be sure of your transmitter frequency — use PRECISION CRYSTALS.

'X' cut PRECISION Crystals carefully ground for maximum power supplied within 0.1% of your specified frequency and calibrated to within 0.03% are priced as follows: 1750, 3500 and 7000 kc. bands —

\$3.00 each. Add \$1.00 to above price if plugin, dustproof holder is desired. (Holder as illustrated to fit G.R. jacks or round holder to plug into a tube socket can be furnished) G.R. jacks to plug illustrated holder into — \$1.50 pair.

Low frequency drift crystals (Type LTC) having a drift of less than 5 cycles per million per degree C. are supplied at the following prices: 1750 and 3500 kc. bands — \$3.50 each; 7000 kc. band — \$4.00 each. Holder \$1.00.

'AT' cut crystals for commercial use quoted on at your request. When ordering our product you are assured of the finest obtainable. Now in our sixth year of business.

PRECISION PIEZO SERVICE

427 Asia Street

Baton Rouge, La.

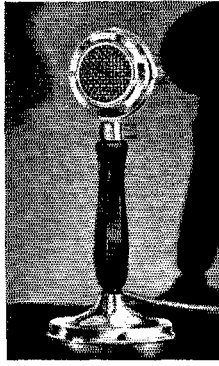
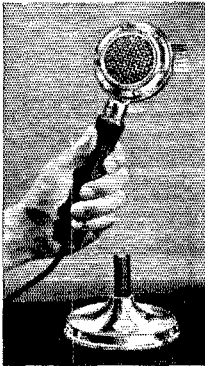

MEMO to 'PHONE MEN:

Ever wish that your Desk microphone was a Hand unit so you could lean back in comfort for a long drawn out QSO?

You can have both kinds . . . and more . . . in one economical unit with a Shure 4-WAY UTILITY Microphone! Desk or Hand Microphone at a second's notice. Simple to convert for Direct Floor-Stand mounting or Spring Suspension, if desired. Shure 4-WAY UTILITY Microphones give you maximum convenience and performance at but slightly more than you would pay for an ordinary microphone. Available in "Communications-Type" Crystal*, General-Purpose Crystal*, and Carbon Types. Ask your Jobber or write today for Bulletin 139Q.

* Licensed under patents of the Brush Development Company

SHURE MICROPHONES
SHURE BROTHERS • MICROPHONE HEADQUARTERS
215 WEST HURON STREET • CHICAGO, U. S. A.

Announcing Model 11 Universal



9.5 to 20,000 Meters

RADIO OPS!! Here's the receiver you've been waiting to hear about. Continuous tuning, without a break, from 9.5 to 20,000 meters. Dial calibrated all the way. Antenna trimmer, band spreader on all waves, break-in switch, phone jack, — everything a real operators' receiver should have, and housed in our new attractive all-metal tray-type cabinet. A.C. models use 5 tubes, D.C. and battery models, 4. One stage I.F., regenerative detector, 2 audio. Tuned r.f. circuit. Built to highest standards of engineering design. Full efficiency at short waves, — extension of tuning range introduces no additional losses, — couldn't be better if designed for short waves only. Available in 3 tuning ranges. Net prices on A.C. models follow:

Model 11-UA, UNIVERSAL TUNING RANGE, 9.5 to 20,000 meters . . . \$75.00

Model 11-MA, MARINE TUNING RANGE, 9.5 to 5,750 meters . . . \$54.00

Model 11-AA, AMATEUR TUNING RANGE, 9.5 to 550 meters . . . \$46.00

Prices include power supply, speaker, R.C.A. tubes.

Available for D.C. and battery operation, also A.C.-D.C. with separate power pack. Write for details. IMMEDIATE DELIVERY.

MODEL 10 This popular receiver continues unchanged in our line. One tuning range only — 9.5 to 550 meters — longer waves now covered by Model 11. Net price, Model 10 for A.C. operation, \$37.50 with power supply, tubes and speaker. Available also for D.C. and battery. Write for details.

E. M. SARGENT CO., 212 9th St., Oakland, Calif.

Unfortunately, it would appear that no ionosphere measurements were being made at the time (we are trying to find out definitely). We do know that conditions in the lower atmosphere over most of the path were right for effective bending in the atmosphere itself and there is the possibility that this condition served as a happy companion for an unusual ionosphere condition.

It is certain that the condition will be repeated again soon and it is quite probable that the phenomenon will become much more common in the near future. In the meantime, we can only urge all ultra-high frequency workers to keep their ears cocked for DX and to cultivate the habit of signing their calls more frequently and more clearly. Complete reports of all work done are of tremendous value to us. We request with all the enthusiasm we possess, that they be sent in by all stations playing a part in this weird and wonderful phase of ham radio.

—R. A. H.

56-mc. DX Contest

With the advent of a considerable amount of DX work on 56 mc. within the past several weeks, particular attention is called to the rules of the M.R.A.C.-A.R.R.L. 56-mc. International DX Contest (page 27, January QST) and the beautiful 16-inch loving cup offered the winner. Those who wish to compete are referred especially to rules 5 and 6 as outlined in the January issue, especially as those rules require reports to headquarters. Those who have been fortunate in participating in some of the fine DX contacts recently and wishing to receive credit in the contest should report their accomplishments in accordance with the rules. Be sure to mark your reports "For the 56-mc. Contest" when mailing.

Inductive Neutralization of R.F. Amplifiers

(Continued from page 24)

$$E_1 = I L_1 (R_1 + j\omega L_1)$$

$$E_2 = -j I L_1 \omega M$$

Writing Kirchhoff's Law equations for Fig. 3.

$$I L_1 (R_1 + j\omega L_1 - j\omega M) = \frac{-j I C_{gp}}{\omega C_{gp}} + I L_2 (R_2 + j\omega L_2)$$

$$-j I L_1 \omega M = \frac{-j I C_2}{\omega C_2} + I L_2 (R_2 + j\omega L_2)$$

$$I C_{gp} + I C_2 = I L_2$$

Solving these equations for $I C_2$ and substituting

for $\frac{1}{\omega C_2}$ the value ωL_2 since L_2 and C_2 are

tuned to resonance gives

$$I C_2 = \frac{-j I L_1 \omega [(M + R_1 R_2 C_{gp} - \omega^2 L_1 L_2 C_{gp}) + j\omega (R_1 L_2 + R_2 L_1)]}{R_2 (1 + \omega^2 L_2 C_{gp}) + j\omega^3 L_2^2 C_{gp}}$$

If M is varied, minimum $I C_2$ or best neutralization is obtained for

$$M = \omega^2 L_1 L_2 C_{gp} - R_1 R_2 C_{gp}$$

It is readily observed that if $R_1 R_2$ is very much less than $\omega^2 L_1 L_2$, the value of M is the same as that determined neglecting resistances. This condition is true in practically all tank circuits. It is common practice to have the effective "Q" of tank circuits of the order of 5 to 10 where effective "Q" refers to the ratio of reactance to effective resistance.

Where to buy it

A directory of suppliers who carry in stock the products of these dependable manufacturers.

ASTATIC
Crystal Microphones and Pickups
ASTATIC MICROPHONE LABORATORY, Inc. YOUNGSTOWN, O.
Pioneer Manufacturers of Quality Crystal Products

- NEWARK, N. J.** 219 Central Ave.
Wholesale Radio Service Co., Inc.
- NEW YORK, N. Y.** 103 W. 43rd St.
Harvey's Radio Shop
- NEW YORK, N. Y.** 100 Sixth Ave.
Wholesale Radio Service Co., Inc.
- PHILADELPHIA, PENN.** 10 S. 10th Street
Eugene G. Wile
- PITTSBURGH, PENN.** 343 Blvd. of the Allies
Federated Purchaser, Inc.

BURGESS BATTERY COMPANY
"Chrome" protected
RADIO BATTERIES
Look for the Black and White Stripes
FREEPORT, ILLINOIS

- ALBANY, N. Y.** Uncle Dave's Radio Shack 356 Broadway
- BALTIMORE, MD.** 303 W. Baltimore St.
Radio Electric Service Co.
- BOSTON, MASS.** Radio Shack 46 Brattle Street
- BRIDGEPORT, CONN.** 195 Cannon St.
Hatry & Young
- HARTFORD, CONN.** 210 Chapel Street
Stern & Company, Inc.
- MONTREAL, CANADA** 285 Craig Street, West
Canadian Electrical Supply Co., Ltd.
- NEWARK, N. J.** 219 Central Ave.
Wholesale Radio Service Company
- NEW HAVEN, CONN.** 86 Meadow St.
Hatry & Young
- NEW YORK, N. Y.** 12 West Broadway
Harrison Radio Company
- NEW YORK, N. Y.** 100 Sixth Avenue
Wholesale Radio Service Company
- SPRINGFIELD, MASS.** 349 Worthington St.
T. F. Cushing

super skyrider
halicrafters
ultra skyrider

- ALBANY, N. Y.** Uncle Dave's Radio Shack 356 Broadway
- BALTIMORE, MD.** 303 W. Baltimore Street
Radio Electric Service Company
- BOSTON, MASS.** Radio Shack 46 Brattle Street
- BRIDGEPORT, CONN.** 195 Cannon St.
Hatry & Young
- HARTFORD, CONN.** 227 Asylum Street
Radio Inspection Service Co.
- NEWARK, N. J.** 219 Central Ave.
Wholesale Radio Service Co., Inc.
- NEW HAVEN, CONN.** 86 Meadow Street
Hatry & Young
- NEW YORK, N. Y.** 51 Vesey St.
Gross Radio, Inc.
- NEW YORK, N. Y.** 12 West Broadway
Harrison Radio Co.
- NEW YORK, N. Y.** 103 W. 43rd St.
Harvey's Radio Shop
- NEW YORK, N. Y.** 100 Sixth Ave.
Wholesale Radio Service Co., Inc.
- READING, PENN.** 404 Walnut St.
George D. Barbey Company
- RICHMOND HILL, NEW YORK** 124-11 101st Ave.
Marine Radio Company
- SPRINGFIELD, MASS.** T. F. Cushing 349 Worthington St.

E.F. JOHNSON COMPANY
MANUFACTURERS OF
TRANSMITTING RADIO EQUIPMENT
WASECA, MINN.
U.S.A.

- MONTREAL, CANADA** 285 Craig Street, West
Canadian Electrical Supply Co., Ltd.
- NEWARK, N. J.** 219 Central Ave.
Wholesale Radio Service Company
- NEW YORK, N. Y.** 12 West Broadway
Harrison Radio Company
- NEW YORK, N. Y.** 100 Sixth Avenue
Wholesale Radio Service Company

Where to buy it

A directory of suppliers who carry in stock the products of these dependable manufacturers.

PITTSBURGH, PENN. Cameradio Company 603 Grant Street
READING, PENN. George D. Barbey Company 404 Walnut Street



ALBANY, NEW YORK Uncle Dave's Radio Shack 356 Broadway
BOSTON, MASS. The Radio Shack 46 Brattle Street
BOSTON, MASS. Selden Radio Company 28 Brattle Street
BUFFALO, NEW YORK Radio Equipment Corp. 326 Elm Street
CONCORD, NEW HAMPSHIRE Carl B. Evans 80 N. State Street
NEWARK, NEW JERSEY Wholesale Radio Service Co. 219 Central Street
NEW YORK, N. Y. Harrison Radio Company 12 West Broadway
NEW YORK, N. Y. Harvey's Radio Shop 103 W. 43rd St.
NEW YORK, N. Y. Wholesale Radio Service Co. 100 Sixth Avenue

HARTFORD, CONN. Hatry & Young 203 Ann Street
NEWARK, N. J. Wholesale Radio Service Co. 219 Central Avenue
NEW HAVEN, CONN. Hatry & Young 86 Meadow Street
NEW YORK, N. Y. Bruno-New York, Inc. 460 W. 34th St.
NEW YORK, N. Y. Royal-Eastern Electrical Supply Co. 16 West 22nd Street
NEW YORK, N. Y. Sanford Samuel Corp. 136 Liberty St.
NEW YORK, N. Y. Wholesale Radio Service Co. 100 Sixth Avenue
NEW YORK, NEW YORK Harrison Radio Company 12 West Broadway
PHILADELPHIA, PENN. Eugene G. Wile 10 S. 10th Street
PHILADELPHIA, PENN. Raymond Rosen & Company 117 North 7th St.
PHILADELPHIA, PENN. M & H Sporting Goods Company 512 Market Street
PITTSBURGH, PENN. Cameradio Company 603 Grant Street
READING, PENN. Bright & Company 8th & Elm Streets
SPRINGFIELD, MASS. T. F. Cushing 349 Worthington Street
WASHINGTON, D. C. Sun Radio & Service Supply Co. 938 F Street, N. W.



ALBANY, N. Y. Uncle Dave's Radio Shack 356 Broadway
BALTIMORE, MD. Radio Electric Service Company 303 W. Baltimore St.
BOSTON, MASS. H. Jappe Company 46 Cornhill
BOSTON, MASS. Radio Shack 46 Brattle Street
BRIDGEPORT, CONN. Hatry & Young 195 Cannon St.



ALBANY, N. Y. Uncle Dave's Radio Shack 356 Broadway
BOSTON, MASS. H. Jappe Company 46 Cornhill
BOSTON, MASS. Radio Shack 46 Brattle Street
BRIDGEPORT, CONN. Hatry & Young 195 Cannon St.
CAMDEN, N. J. Radio Electric Service Company 811 Federal Street
ERIE, PENN. J. V. Duncombe Company 1011 West 8th St.
GREENWICH, CONN. Mead Stationery Company 252 Greenwich Ave.

Where to buy it

A directory of suppliers who carry in stock the products of these dependable manufacturers.

HARTFORD, CONN. Hatry & Young 203 Ann Street

HARTFORD, CONN. 227 Asylum Street
Radio Inspection Service Co.

MONTREAL, CANADA 285 Craig Street, West
Canadian Electrical Supply Co., Ltd.

NEWARK, N. J. 219 Central Avenue
Wholesale Radio Service Company

NEW HAVEN, CONN. 86 Meadow Street
Hatry & Young

NEW YORK, N. Y. 460 W. 34th St.
Bruno-New York, Inc.

NEW YORK, N. Y. 12 West Broadway
Harrison Radio Co.

NEW YORK, N. Y. 136 Liberty Street
Sanford Samuel Corporation

NEW YORK, NEW YORK 124 E. 44th Street
Grand Central Radio, Inc.

NEW YORK, N. Y. 100 Sixth Avenue
Wholesale Radio Service Company

PHILADELPHIA, PENN. 3145 N. Broad Street
Radio Electric Service Company

PHILADELPHIA, PENN. N. E. Cor. 7th & Arch Streets
Radio Electric Service Company

PHILADELPHIA, PENN. 512 Market Street
M & H Sporting Goods Co.

PITTSBURGH, PENN. 603 Grant Street
Cameradio Company

NEW YORK, N. Y. 12 West Broadway
Harrison Radio Co.

NEW YORK, N. Y. 100 Sixth Avenue
Wholesale Radio Service Company

NEW YORK, N. Y. 227 Fulton Street
Sun Radio Company

READING, PENN. 404 Walnut Street
George D. Barbey Company

SPRINGFIELD, MASS. T. F. Cushing 349 Worthington Street



ALBANY, N. Y. 356 Broadway
Uncle Dave's Radio Shack

BOSTON, MASS. 46 Brattle Street
Radio Shack

BOSTON, MASS. 28 Brattle St.
Selden Radio Company

BRIDGEPORT, CONN. 195 Cannon St.
Hatry & Young

HARTFORD, CONN. Hatry & Young 203 Ann Street

MONTREAL, CANADA 285 Craig Street, West
Canadian Electrical Supply Co., Ltd.

NEWARK, N. J. 219 Central Ave.
Wholesale Radio Service Company

NEW HAVEN, CONN. 86 Meadow Street
Hatry & Young

NEW YORK, N. Y. 100 Sixth Avenue
Wholesale Radio Service Company

PITTSBURGH, PENN. 603 Grant Street
Cameradio Company

READING, PENN. 404 Walnut Street
George D. Barbey Company



ALBANY, N. Y. Uncle Dave's Radio Shack 356 Broadway

BOSTON, MASS. H. Jappe Company 46 Cornhill

BUFFALO, N. Y. 326 Elm St.
Radio Equipment Corporation

NEWARK, N. J. 219 Central Avenue
Wholesale Radio Service Company

EIMAC

TRANSMITTING TUBES

One or more of the following considerations will influence the choice of your next transmitting tube

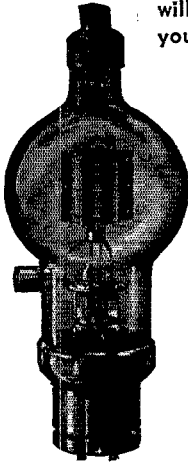

EIMAC 150T

- (1) Price
- (2) Quality
- (3) Performance
- (4) Dependability
- (5) Reputation
- (6) Appearance
- (7) Ruggedness
- (8) Versatility

Your choice will be an EIMAC if you

"COMPARE AND REFLECT"

There is an Eimac tube for your specific requirement

SEE YOUR DEALER FOR DETAILED INFORMATION

EITEL-McCULLOUGH, INC.
SAN BRUNO, CALIFORNIA
U. S. A.

RADIO ENGINEERING

RCA Institutes offers an intensive course of high standard embracing all phases of Radio. Practical training with modern equipment at New York and Chicago schools. Also specialized courses and Home Study Courses under "No obligation" plan.

Illustrated Catalog on request

RCA INSTITUTES, INC. Dept. ST-36

75 Varick St., New York 1154 Merchandise Mart, Chicago
Recognized Standard in Radio Instruction Since 1909



Instrument with tapes prepared by expert and complete course of lessons; all for \$11.95

"HAM" SPECIAL Standard Teleplex

A highly efficient code teacher using heavy specially prepared waxed paper tape, having two rows of perforations. Write for Free folder Q.T. DEALERS — Correspondence invited with dealers for protected territories.

We are the originators of this type instrument

TELEPLEX CO.
72 Cortlandt St., New York City

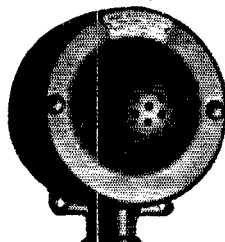

Send for Our NEW Bulletin 3012

The Superiority of Our DYNAMIC MICROPHONE

Over Other Types Is Mainly in Its Sensitivity

No high gain preamplification required. No background noise. No Power Supply. New low prices and improved performance should be of interest to all amateurs who wish to improve the quality of their stations.

PRICE \$29.00

U. S. PATENTS PENDING

RADIO RECEPTOR CO., INC.
110 Seventh Ave., New York City

High-Fidelity Audio at Low Cost

(Continued from page 36)

the circuit shown herewith, but in most cases this simply amounts to lifting off a couple of soldered joints from the tube socket.

In the circuit shown as a suggestion for coupling in a t.r.f. type tuner, it will be noticed that a form of link circuit is used. The third coil L_3 may be a hundred turns or so of fairly fine wire on a former small enough to slip inside the secondary of the coil unit.

In all cases it will be found rather difficult to arrange to have a.v.c. voltage taken from the same diode as used for detection. If a.v.c. must be fitted, one solution is to use a tube like a 6B7 for the intermediate amplifier and take some r.f. from the plate circuit of this valve back to its diodes to develop the necessary a.v.c. voltages.

Station Description

(Continued from page 45)

'phone, but which can be operated on 80, 40, 20 or 10 meters since all coils are plug-in type. The radio-frequency tube line-up in this transmitter consists of a 59 Tri-tet crystal oscillator, 59 regenerative doubler, two 46's in parallel in the buffer stage, and two 801's in push-pull in the final-amplifier stage. The audio line-up consists of a double-button carbon microphone, 56, 56, two 45's in push-pull and two 210's in Class-B as modulators. The modulator and final amplifier tubes are operated at 850 volts. The normal input to the final stage is 135 watts. Each panel unit is complete with terminals at the rear of the chassis. This makes it possible for any unit to be removed should the necessity arise.

A 66-foot flat-top 40 feet high pointing north and south, fed by Zepp feeders, is used with both transmitters. The large 40-meter transmitter has put signals into many foreign lands but as yet is not quite WAC. On 14,200-kc. 'phone contacts with United States, Canada, Central America and West Indies are comparatively easy. The best 'phone DX to date has been a ZL contact and numerous New Zealand and Australian SWL reports.

The receiver is a Hammarlund Comet Pro with a receiving antenna in the attic.

The meter boxes seen on the operating table contain a combination voltmeter, ohmmeter and milliammeter, a vacuum-tube voltmeter and a modulation analysis meter.

Strays

W9WGH mounts his filter chokes on pivots to get that "swinging" effect!—W9ISA.

Heard on 20-meter 'phone: W9—, "Sorry, OM, you got my call letters balled up. Listen, W2-er-er—say, what the deuce is your call? . . ."

HAM-ADS

(1) Advertising shall pertain to radio and shall be of nature of interest to radio amateurs or experimenters in their pursuit of the art.

(2) No display of any character will be accepted, nor can any special typographical arrangement, such as all or part capital letters be used which would tend to make one advertisement stand out from the others.

(3) The Ham-Ad rate is 15c per word, except as noted in paragraph (6) below.

(4) Remittance in full must accompany copy. No cash or contract discount or agency commission will be allowed.

(5) Closing date for Ham-Ads is the 25th of the second month preceding publication date.

(6) A special rate of 7c per word will apply to advertising which, in our judgment, is obviously non-commercial in nature and is placed and signed by a member of the American Radio Relay League. Thus, advertising of bona fide surplus equipment owned, used and for sale by an individual or apparatus offered for exchange or advertising inquiring for special equipment. If by a member of the American Radio Relay League takes the 7c rate. An attempt to deal in apparatus in quantity for profit, even if by an individual, is commercial and takes the 15c rate. Provisions of paragraphs (1), (2), (4) and (5) apply to all advertising in this column regardless of which rate may apply.

Having made no investigation of the advertisers in the classified columns, the publishers of *QST* are unable to vouch for their integrity or for the grade or character of the products advertised.

QUARTZ—direct importers from Brazil of best quality pure quartz suitable for making piezo-electric crystals. Diamond Drill Carbon Co., 719 World Bldg., New York City.

RADIO engineering, broadcasting, aviation and police radio, servicing, marine and Morse telegraphy taught thoroughly. All expenses low. Catalog free. Dodge's Institute, Byrd St., Valparaiso, Ind.

NATIONAL—Hammarlund, Patterson used sets, 60% off list. W3DQ, 405 Delaware Ave., Wilmington, Del.

CLASS B transformers—Universal for two or four 46s, 210s, 800s, RK18s, etc., \$7.75 pair postpaid. 70 watts audio from 40s, 100 watts from 10s. Write for details. W8UD, Douglas, Mich.

QLS's, W2SN, Helmetta, N. J.

QSL cards, two color, cartoons, message blanks, stationery, Snappy service. Write for free samples to-day. W1BEF, 16 Stockbridge Ave., Lowell, Mass.

1000W General Electric transformers, 1100-2200-4400 each side center on 110. Sold hams eight years. \$13.50. Dawson, 5740 Woodrow, Detroit.

CALLBOOKS—new DX calls, new prefixes, thousands of new W and VE calls, in the Summer 1936 Radio Amateur Call Book. Sent postpaid \$1.25, or a whole year (four issues) for \$4. (In foreign countries \$1.35 and \$4.35). Your call and QRA printed in large type, \$1. per year. Radio Amateur Call Book, 610 S. Dearborn, Chicago.

QLSs, SWLs. Best quality reply getters. Samples. (Stamps) W8ESN, 1827 Cone St., Toledo, Ohio.

SKYRIDER bargains, all models, sell or trade. Philco 16-X 5 band chassis, new \$50. Leica cameras. Wells Smith Radio Corp., 26 N. Wells St., Chicago, Ill.

MICROPHONES—Turner condenser mike with battery head amplifier \$35. New Universal KK, \$18. SW3 with tubes and 40, 80, 160 band spread coils \$20. Instructograph \$10. W9IRR, 1007 Fulton, Hannibal, Mo.

WRITE for list surplus equipment. No junk. Real bargains W8ESY, Hellam, Pa.

QSL's—new—different. W8NWW, Deposit, N. Y.

CRYSTALS—"Summer Sale" continued. See May *QST* Ham-Ads. Mounted units 80 and 160 X-cut \$2. Lo-drift \$3.40—\$2.75. Wolverine Crystal Service, Calumet, Michigan.

SALE Wheatstone type automatic tape transmitter and manual perforator. Perfect speeds 8-260 WPM. Must sell. \$130. Write W8DIE.

QSLs, Samples, Stamp? Printer, Corwith, Iowa.

ESCO Motor Generator, 1000 volts, 300 watts, perfect condition, \$75. Designers marine (Short Wave) receivers, transmitters. Ensell Radio Laboratory, Grandview SE., Warren, Ohio.

SELL 160 watt lone xmtr. Relay rack construction. FB Job. Good buy. Write for details, photo and price. W9KFO.

SELL: Senior Vibroplex, carrying case, \$15. W8KLP.

GENUINE gold leaf call letters—ideal for auto windows, transmitters, etc. 2 1/2" high. Complete instructions and special cement. 75¢. Meserve, W1FL, Hudson, Mass.

GIVE your station that \$1,000,000 look. Superlative all-welded relay racks, panels, chassis. Heavy duty hi-power equipment. Rectifier Engineering Service, 4837 Rockwood Rd., Cleveland, Ohio.

WRITE us for trade-in price on your old receiver. We buy meters. Walter Ashe Radio Co., St. Louis, Mo.

CRYSTALS! Bliley! Order from W8DED!

RME-69's! Patronize W8DED!

QSLs! Finest stock, printing! Samples? (stamp) W8DED, Holland, Mich.

QSL's, 300 one-color cards \$1. Samples. 2143 Indiana Avenue, Columbus, Ohio.

CRYSTALS: Zero cut. Guaranteed to compensate at near zero without oven control. Your approximate frequency, 80 or 160 meters \$1.85. Ordinary zero cuts \$1.35, small \$1., 40 meters \$2. postpaid. Blanks 85¢. Plug-in holders 75¢, dozen \$6. Fisher Laboratory, 4522 Norwood Street, San Diego, California.

QSLs of finest quality. Free samples. Maleco, 1512 Eastern Parkway, Brooklyn, New York.

CRYSTALS: "HC" Specials for July: \$1.95 "X" cuts, 80M, \$1.55, \$3.25 four cycle "V" cuts, 80M—160M, \$2.25. Beautiful formica holders, genuine "G2" plugs, \$1. Request catalogue. Ham Crystals, 1104 Lincoln Place, Brooklyn, N. Y.

SELL: complete file "QST" December 1915 to Dec. 1934 inclusive, each issue having both covers and suitable for binding. Sumner B. Young, "Maplewoods," Wayzata, Minn.

FREE crystals:—Powerful "T-9" 40 meter crystals \$1.50 postpaid, approximate frequency. Written guarantee and calibration card supplied. Announcing: Eidson's low-loss ceramic 40 meter plug-in holders, efficient and attractive, only one on market. \$1.10 postpaid. Introductory offer: First six mail orders received at each address, for crystal and holder, get additional 40 meter crystal free. Eidson's, Temple, Texas or W2GWS, 83-34 209th Street, Queens Village, New York.

SEE June *QST* Ham-ad for prices etc., on crystals. William Threm, W8FN, 4021 Davis Avenue, Cheviot, Ohio.

REBUILT Vibroplexes \$6. New large base bugs \$9. Lydeard, 28 Circuit, Roxbury, Mass.

THICKER than X cut blanks \$1, Faberadio, Sandwich, Illinois.

POWERFUL x-cut crystals, accurately calibrated. Perfect oscillators. Completely guaranteed. 40 meter band \$1.85. 80-160 bands \$1.50. Jobbers write, W9JRY, Omaha Crystal Laboratories, 501 World Herald Bldg., Omaha, Nebr.

W8IFB selling complete 20M C.W. 1-kw 204-A transmitter. 7-tube super. Very reasonable. Send for list. Entering U. S. Naval Academy. Gaylord Buchanan, Claysville, Pa.

BARGAIN—AGS complete in good condition, with power supply and coils for 20, 40, 80 and 160, \$67. Also bargain in brand new 861. For more information write Box 35, Walla Walla, Washington.

SELL FBXA Lead's Noise Silencer and National Preselector with tubes, pack, forty BS and F coils. A1 condition. Best cash offer. W5EBT.

4-band receivers General Electric model A-82, sentry box control, only \$69.50. For description see *QST* December 1935 page 87. You save \$25. Quick deliveries. W9VPC, Willy Hess, 1439 South Michigan Ave., Chicago, Ill.

QSLs, 5-meter Print, Escanaba, Mich.

BARGAIN list—amateur and broadcast equipment and transmitters. Tubes. Ham receivers. Amplifiers. All kinds of everything. Write for list quick. Real bargains. Mims Radio Co., Texarkana, Ark.

GROSS CB 100 transmitter. See page 70 July 1935 *QST* for picture description. Complete at a real bargain. Mims Radio Co., Texarkana, Ark.

LABORATORY and service equipment—General Radio, Clough Brengle, Supreme. Large assortment. All at bargains. Mims Radio Co., Texarkana, Ark.

GLOUGH Brengle CRA oscilloscope. New, complete \$65. W5BDB.

NOW 40 meter X cut and low drift cuts—Southwest Piezo Service, Abilene, Texas.

McMURDO Silver masterpiece receiver number two with crystal laboratory seals intact; also large two fifty amplifier cheap. Glenn Watt, Chanute, Kans.

QSLs-SWLs—finest obtainable. Attractive, distinctive, modern, quality, stocks, inks, samples, prices (stamps). W8NOS.

SPECIAL! one "Radio Handbook," one "Antenna Handbook," and one new three-issue "Radio" subscription, all for \$1.; foreign, \$1.40. "Radio," 7460 Beverly, Los Angeles.

"**ANTENNA** Handbook"; amateur antennas, all types, "A" to "Z," receiving and transmitting. Detailed tables—no figuring to do. Complete, practical, easily understood; profusely illustrated. 35¢ postpaid anywhere. Sold by "Radio," 7460 Beverly, Los Angeles.

McMURDO Silver 5 C crystal filter like new. Complete 60 watt transmitter reasonable. Sebastian Kampf, 4056 Lowell Ave., Chicago, Illinois.

TELEPLEXES: Ominigraphs, receivers, meters, Vibroplexes, bought, sold, traded. Ryan Radio Co., Monroe City, Mo.

NEW RCA ACR136—\$49.50. W8ANT.

USED RCA 849's. W8ANT.

USED Super Wasp cheap. W8ANT.

USED RCA 861. W8ANT.

USED National transmitting condensers. W8ANT.

PAM 19 cheap. W8ANT.

KENNEDY intermediate wave receiver. W8ANT.

RME 69's in stock. W8ANT.

NEW and used parts bought, sold and exchanged, by southern Ohio's only amateur owned amateur business. Jos. N. Davies, W8ANT, Box 602, R.R. 9, North Bend Road, Mt. Airy, Cincinnati, Ohio.

ANTENNA, new design, DX transmitting low and high angle radiations. Booklet 25¢ coin. WIDZE, Mattapan, Mass.

204A and socket \$17.50. 211 and socket \$6.50. 2 Jewell RF meters 0-10 \$4.50 each, Jewell DC voltmeter 0-1500 \$8. Hammarlund TCD 100A condenser \$7. 3 Allen Bradley Radiostats \$2.50 each, 4000 working volts 2 mid. Morrill \$10. No trades. W5UX.

QSL's, Mile-hi quality. 300 2-color \$2. W9TOS.

FIVE meter equipment receivers \$9.50; transmitters \$7.; silencers \$4.; single IF, \$6. We build equipment to order. Precision Radio Laboratories, 109 East 94 Street, Brooklyn, N. Y.

QSL's—special introductory offer. Radio Headquarters, Ft. Wayne, Indiana.

SELL: 89 metal tube Super Skyrider \$59.50, 8X9 \$64.50, silver masterpiece IVA in original cartons \$79.50, RME9D \$70. National SW5 with tubes and four pairs coils \$16. Silver 10F, Collins 32B, Collins 30FXB transmitters. Other apparatus. W9ARA, Butler, Mo.

QSL's, free samples, W8DDS, 2156 West 80th Street, Cleveland.

HAM parts dealers: increase your sales! Sell "Radio," the how-to-build-it ham magazine. Write for dealers' rates. 7460 Beverly, Los Angeles.

RADIO Handbook, 50¢ postpaid (regularly, \$1) only with subscription to "Radio" at \$2.50 (U. S. A.)! "Radio," 7460 Beverly, Los Angeles.

AUSTRALASIANS! "Radio," 1 year, and one copy "Radio Handbook," both for £1, your currency. "Radio," 7460 Beverly, Los Angeles, U. S. A.

BRITISH Empire and Europe! "Radio," 1 year, and one copy "Radio Handbook," both for 16/-! G6US.

RADIOFONE and cw transmitter—200 watt final. 2 unused Sylvania 203As supplied to increase output to 400 watts. 200 watt class B modulator. Mounted in Westinghouse metal cabinet. Commercial appearance and performance. First \$325. takes it. Cost over \$700. to construct. Full details on request. D. M. Gallagher, W2AEH, c/o Biological Laboratory, Cold Spring Harbor, L. I.

Interested in AMATEUR RADIO?

OBTAIN A COPY OF
**HOW TO BECOME A
RADIO AMATEUR**

RECOGNIZED AS THE STANDARD ELEMENTARY
GUIDE FOR THE PROSPECTIVE AMATEUR

Features equipment which, although simple in construction, conforms in every detail to 1936 practices. The apparatus is of a thoroughly practical type capable of giving long and satisfactory service — while at the same time it can be built at a minimum of expense. The design is such that a high degree of flexibility is secured, making the various units fit into the more elaborate station layouts which inevitably result as the amateur progresses. Complete operating instructions and references to sources of detailed information on licensing procedure are given, as well as a highly absorbing narrative account of just what amateur radio is and does.

Price 25¢ postpaid (no stamps, please)

AMERICAN RADIO RELAY LEAGUE

West Hartford, Connecticut

Popular with all Amateurs because of its Sensitivity

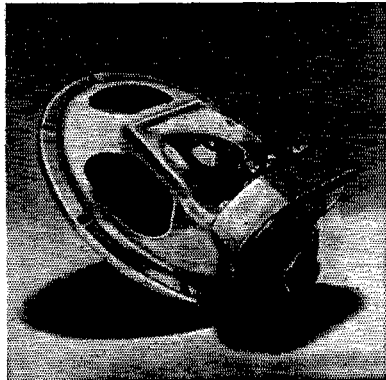

The "Hyflux"

- High Efficiency
- Wide Frequency Range
- Permanent Dust Proofing
- Rugged Construction

Write for Complete Details, Specifications, Prices

WRIGHT-DECOSTER, INC.

2259 University Avenue

St. Paul, Minn.

Export Dept.: M. Simons & Son Co.

Cable Address: SIMONTRICE, New York

Canadian Office: Wright-DeCoster, Inc., Guelph, Ont.

GULF RADIO SCHOOL

Radiotelegraphy

Radiotelephony

Radio Servicing

SECOND FLOOR } 1007 Carondelet Street
U. S. A. } NEW ORLEANS, LA.

BRUSH Headphones

● Meet every headphone requirement. They bring in weak signals strong and clear and will handle excessive volume without overloading. Response 60 to 10,000 cycles. No magnets to cause diaphragm chatter. Specially designed cases minimize breakage. Light in weight. Only 6 oz., complete with headband and cords. A quality product at a low price. Details, Data Sheet No. 10. Copies on request. Send for one.

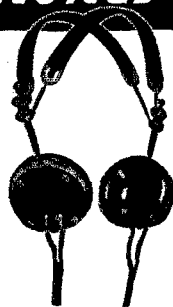

The **BRUSH** DEVELOPMENT COMPANY
1893 E. 40th St. PIERCE ELECTRIC CLEVELAND, O.
MICROPHONES • MIKE STANDS • TWEETERS • HEAD PHONES • LOUD SPEAKERS

Your Nearest Dealer Is Your Best Friend

Your nearest dealer is entitled to your patronage. You can trust him. He is equipped with a knowledge and understanding of amateur radio. He is your logical and safe source of advice and counsel on what equipment you should buy. His stock is complete. He can supply your needs without delay. His prices are fair and consistent with the high quality of the goods he carries. He is responsible to you and interested in you.

Patronize the dealer nearest you — You can have confidence in him

<p>ALLENTOWN, PENNSYLVANIA Radio Electric Service Co. 1024 Hamilton Street Complete stocks transmitting equipment</p>	<p>PHILADELPHIA, PENNSYLVANIA Eugene G. Wile 10 S. Tenth Street Complete Stock of Quality Merchandise</p>
<p>BALTIMORE, MARYLAND Radio Electric Service Co. 303 W. Baltimore Street Everything for the amateur</p>	<p>PROVIDENCE, RHODE ISLAND W. H. Edwards Co. 32 Broadway National — Hamarlund — RCA — and other leaders</p>
<p>BIRMINGHAM, ENGLAND Radio Mart 19 John Bright Street Drop in and meet Bill Nightingale—G5NI</p>	<p>PROVIDENCE, RHODE ISLAND Kraus & Company 89 Broadway Everything for the amateur and serviceman</p>
<p>BUFFALO, NEW YORK Dymac Radio 216 E. Genesee St. — Tel. Cl. 2080 Complete Stock Amateur Parts — Standard Discounts — W8AWK</p>	<p>ROCHESTER, NEW YORK Radio Service Shop 244 Clinton Avenue, North Complete stock amateur-BCL parts. Standard discounts. W8NUC</p>
<p>BUFFALO, NEW YORK Radio Equipment Corp. 326 Elm Street W8GJ — Ham, service and sound equipment — W8BTS</p>	<p>SYRACUSE, NEW YORK Roy C. Stage, W8IGF Complete stock of standard Ham & BCL parts Standard Discounts. Free technical service</p>
<p>MANCHESTER, NEW HAMPSHIRE Radio Service Lab. of N. H. 1187-1191 Elm Street — Tel. 218-W Branches — Portland, Me. and Barre, Vt.</p>	<p>SPRINGFIELD, MASS. S. S. Kresge Company 1540 Main Street Standard discounts on standard lines. Advisory service: W1JQ, W1FOF</p>
<p>MONTREAL, CANADA Canadian Elec. Supply Co., Ltd. 285 Craig St., W. Quality parts and equipment for discriminating buyers</p>	<p>WASHINGTON, D. C. George's Radio Co. 816 F Street, N.W. Washington's largest distributor of radio parts</p>
<p>PHILADELPHIA, PENNSYLVANIA Consolidated Radio Corp. 612 Arch Street Ham receivers, Transmitting tubes, Collins transmitters, etc.</p>	<p>WHEELING, WEST VIRGINIA Cameradio Company 30 Twelfth Street Complete stock of amateur Equipment at standard discounts</p>
<p>PHILADELPHIA, PENNSYLVANIA Radio Electric Service Co., Inc. N. E. Cor. Seventh & Arch Sts. All nationally-advertised lines in stock</p>	
<p>PITTSBURGH, PENNSYLVANIA Cameradio Company 601-3 Grant Street "Ham" Headquarters for Pennsylvania-Ohio-W. Virginia</p>	

You Are Protected When You Buy From QST Advertisers

“Advertising for QST is accepted only from firms who, in the publisher’s opinion, are of established integrity and whose products secure the approval of the technical staff of the American Radio Relay League.”

Quoted from QST’s advertising rate card.

Every conceivable need of a radio amateur can be supplied by the advertisers in QST. And you will know the product has the approval of the League’s technical staff.

For Your Convenience

QST’S INDEX TO ADVERTISERS IN THIS ISSUE

Aerovox Corporation	79
Amperite Corporation	82
Asstic Microphone Laboratory	71
A. R. R. L. Calculators	87
Handbook	69
How to Become a Radio Amateur	92
License Manual	83
Special Offer	61, 67
Birnback Radio Company	85
Billie Electric Company	71, 79
Brush Development Company	92
Bud Radio, Inc.	75
Burgess Battery Company	95
Candler System Company	75
Capitol Radio Engineering Institute	80
Cardwell Mfg. Corp., Allen D.	66
CentraLab	60
Collins Radio Company	Cov. 2
Cornell-Dubilier Corporation	81
Eitel-McCullough, Inc.	90
Freck Radio & Supply Company	81
General Electric Company	77
General Radio Company	62
General Transformer Company	80
Gross Radio, Inc.	59
Gulf Radio School	92
Hallcrafters, Inc., The	1
Hammarlund Mfg. Company	4
Harvey Radio Laboratories	82
Heintz & Kaufman, Ltd.	75
Henry Radio Shop	81
Instructograph Company	85
Jacobs, Chas. F.	75
Leeds	78
Marine Radio Company	2
Massachusetts Radio School	71
McElroy, T. R.	85
McGraw-Hill Book Co.	64
National Company	57, 65, 79, Cov. 3
Newark Electric Company	68
Ohmite Mfg. Company	84
Pacific Radio Publishing Co.	84
Port Arthur College	79
Precision Piezo Service	85
Radio Equipment Sales Company	81
Radio Receptor Corporation	90
Radio Shack	81
Radio Supply Company	81
Radio Transceiver Laboratories	83
Raytheon Production Corporation	58
RCA Institutes, Inc.	83, 90
RCA Manufacturing Company	Cov. 4
Sargent Company, E. M.	86
Scientific Radio Service	82
Shure Brothers Company	86
Sickles Company, F. W.	83
Solar Manufacturing Company	70
Sundt Engineering Company	84
Teleplex Company	83, 90
Thordarson Electric Manufacturing Co.	69
Triplett Electrical Instrument Corp.	74
Turner Company	85
United Transformer Corporation	96
Universal Signal Appliance	85
Utah Radio Products	83
Valpey Crystals	81
Vibroplex Company	71
Western Electric Company	63
Wright-DeCoster, Inc.	92

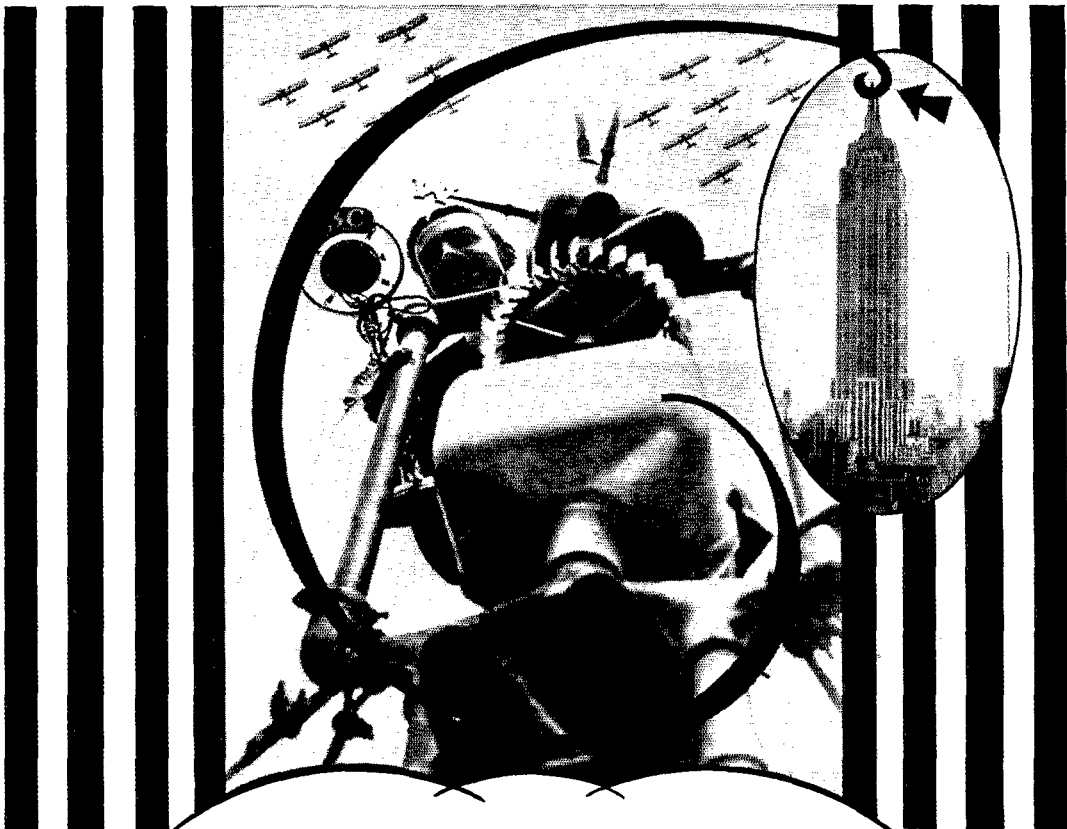

COURTESY NBC

Helping Ears to "See" Farther Burgess Portable Power

America goes to war. "Enemy planes" dive on New York. A "protecting fleet" wraps the city in smoke and soars on to victory.

Below on the ground it's impossible to tell what's happening — but at the tip of the Empire State Building, James Wallington watches every move. He draws the maneuvers in his "mike" scene by scene. Even thousands of miles away *this spectacular broadcast* enables

us to "see" our air army in battle.

Burgess Batteries were there, too. They furnished radio power to the voice that commanded the squadrons. Their portability aided the nation-wide broadcast.

Use the portable power the veterans use in your own experimental or radio work — Burgess Batteries.

BURGESS BATTERY COMPANY
 Freeport, Illinois



BURGESS



Say You Saw It in *QST* — It Identifies You and Helps *QST*

New . . . UTC **ULTRA COMPACT AUDIO UNITS . . .**

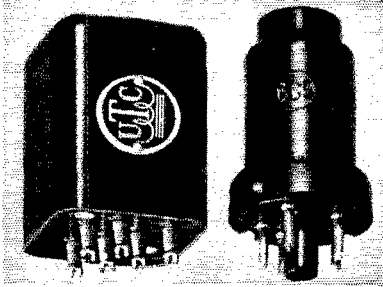

Designed as companion units for acorn and metal type vacuum tubes. They measure up to good broadcast standards, having a response of plus or minus 2 db from 30 cycles to 20,000 cycles. The average weight is $6\frac{1}{2}$ ounces, and the overall dimensions are $1\frac{7}{8}$ x $1\frac{7}{8}$ x $1\frac{1}{8}$. These units are primarily intended for noise meter, aircraft and remote pickup work. Full description of these units is contained in the new U1100D bulletin.

THREE TYPICAL ULTRA COMPACT AUDIOS

Type	Application	Primary Impedance	Secondary Impedance	List Price
A-12	Multiple line or microphone to 2 grids	500, 333, 250, 200, 125 or 50 ohms.	80,000 or 20,000 ohms.	\$10.00
A-16	Single plate (6C6, 955, 262A, etc.) to single grid	15,000 ohms.	60,000 ohms.	8.00
A-24	Single plate (6C6, 955, 262A, etc.) to multiple line	15,000 or 3,750 ohms.	500, 333, 250, 200, 125 or 50 ohms.	10.00

Ask your distributor for U1100D bulletin describing all of the new **ULTRA COMPACT AUDIOS.**

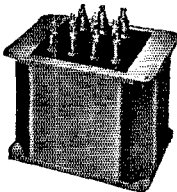

VM-4

VARIMATCH transformers are designed to match all available modulation tubes to a class C, RF stage

TYPE	VARIMATCH Modulation Transformer	List Price	Net Price
VM-1	Will handle any power tubes to modulate a 20 to 60 watt Class C stage	\$8.00	\$4.80
VM-2	Will handle any power tubes to modulate a 40 to 120 watt Class C stage	12.50	7.50
VM-3	Will handle any power tubes to modulate a 100 to 250 watt Class C stage	20.00	12.00
VM-4	Will handle any power tubes to modulate a 200 to 600 watt Class C stage	32.50	19.50
VM-5	Will handle any power tubes to modulate a 450 watt to 1 KW plus, Class C stage	70.00	42.00

The secondaries of all Varimatch transformers are designed to carry the class C plate current.

THE VARIMATCH TRANSFORMER NEVER BECOMES OBSOLETE

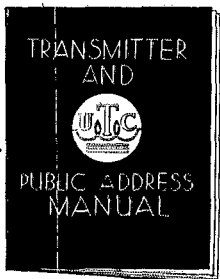

GOING TO PRESS! Our Research Department has just completed a thorough study of Transmitter and Public Address hookups, circuits and applications. This valuable information has been compiled into an attractive 44-page illustrated bulletin. A limited number of copies will soon be available at your local distributor. **ORDER YOURS NOW . . . SPECIAL PRICE25c**

UNITED TRANSFORMER CORP.
76 SPRING STREET NEW YORK, N. Y.
EXPORT DIVISION - 15 LAIGHT STREET, NEW YORK, N. Y.

DIFFERENT ONLY IN VERSATILITY AND IN PRICE

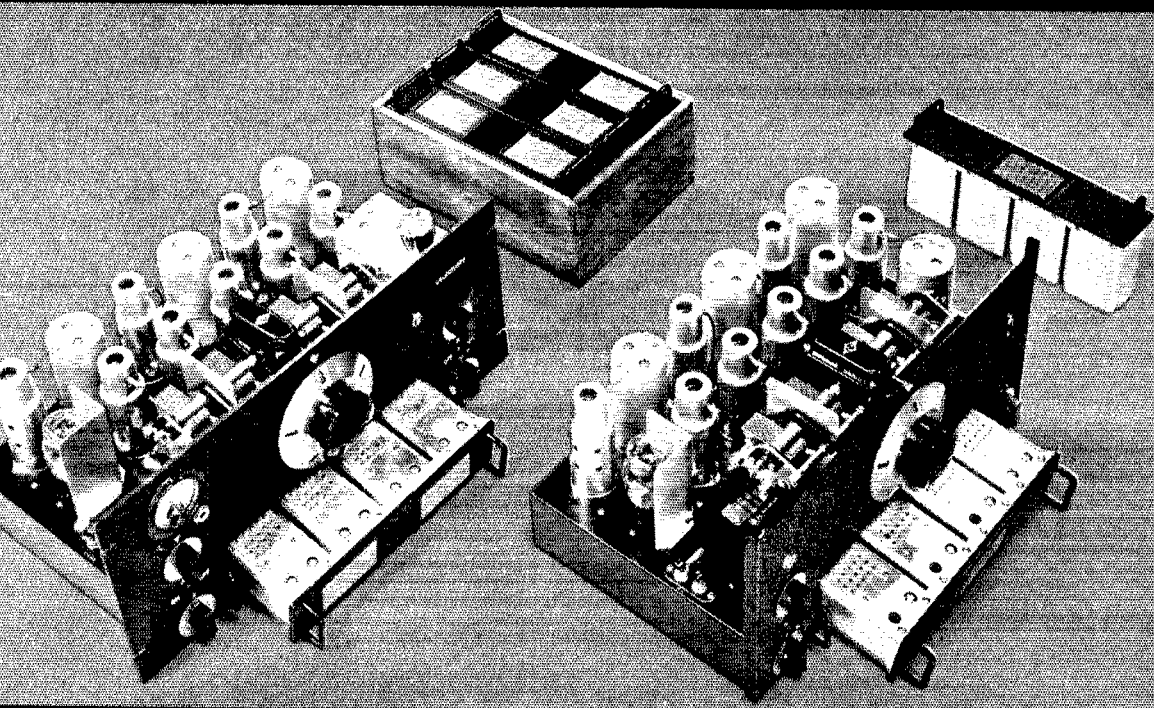

THE STANDARD HRO :: THE HRO JUNIOR

ANY night on the amateur bands you will hear a better advertisement of the Standard HRO than we could write. The unqualified enthusiasm of men who have spent years mastering the fine points of high frequency communication counts for more than a long list of unusual details, even though those details include such items as the PW Precision Condenser, calibrated band spread and a crystal filter as effective on phone as c.w. The demands of modern radio are rigorous, and the proof of the pudding is in the eating.

THE attractively priced HRO Junior is the Standard HRO stripped down to its straight superheterodyne circuit by omission of the calibrated S-meter (and associated circuit), the single-signal crystal filter, the extreme electrical band spread, and the engraved aluminum relay rack panel. The chassis, all other parts, and the fundamental circuit are identical. The general performance of the HRO Junior is in every way equal to the magnificent performance of the HRO. The crystal filter and the S-meter, may be added at any time.

An illustrated folder describing both receivers will be mailed on request

NATIONAL



COMPANY

FOR BEST RESULTS AT HIGHER FREQUENCIES USE

RCA Transmitting Tubes



During the summer months interest in the higher frequencies is at a peak. For full enjoyment of ultra-high frequency operation you must use the right tubes. RCA offers a wide variety for both 5 and 10 meter operation. Use this table in selecting the type to meet your particular requirements.



Type	Rated Maximum Plate Input Watts (Class C Telegraphy)			Amateurs' Net Price
	at 20 Meters	at 10 Meters	at 5 Meters	
RCA-800	100	100	100	\$10.00
RCA-801	42	42	42	4.50
RCA-802*	30	30	22	3.90
RCA-803*	350	290	200	38.50
RCA-804*	120	95	70	15.00
RCA-805	315	315	210	18.00
RCA-830-B	150	112	75	10.00
RCA-834	125	125	125	12.50
RCA-838	220	220	155	16.00
RCA-852	300	300	245	16.40

* Indicates Pentode Type



In addition there are the RCA-955 acorn triode at \$3.75 and the RCA-954 acorn pentode at \$5.80 for the ultra-high frequency receiver or "flea-power" transmitter. For information on the RCA types mentioned or any other RCA tubes see your distributor or write to



AMATEUR RADIO SECTION

RCA MANUFACTURING CO., INC. CAMDEN, NEW JERSEY

A Service of the Radio Corporation of America