

QST

February, 1937
25 cents

devoted entirely to

amateur radio

In this Issue—
More DX per Dollar
Solving the Harmonic Problem
The Doherty Amplifier



Collins 202B Multifrequency Transmitter



The 202B is representative of the new Collins 200 Series Transmitters, having outputs from 300 watts to 2,000 watts and employing the most efficient quick frequency shift arrangement developed for high frequencies. A desired frequency in a predetermined group of channels can be selected from the panel. Performance on each frequency is equal to that obtainable in a single frequency transmitter. The many important design features of the 200 Series Transmitters have been thoroughly proved in the laboratory and in actual service. Brief specifications of the 202B are:

POWER OUTPUT: 600 Watts telegraph and telephone

FREQUENCY RANGE: 1.5 mc. to 30 mc.

R-F TUBES: C-100A, 6L6, 6L6, 803, 2-C2

A-F TUBES: 4-2A3, 2-C200

POWER TUBES: 2-5Z3, 2-872A

DIMENSIONS: 24" x 24" x 78"

The 300 watt models are similar in appearance to the 202B, use C-805 output tubes and are constructed in a six inch shorter cabinet. The 1,000 watt and 2,000 watt models are also similar in appearance, but use two cabinets side by side for the telegraph models and three cabinets for the telegraph-telephone models. Many design features and components are standardized for all 200 Series Transmitters.



Collins Radio Company

CEDAR RAPIDS
New York
11 West 42nd St.



IOWA, U. S. A.
Mexico City
Edificio "La Nacional"

Announcing the SKY CHALLENGER

A New Hallicrafters
Communications Receiver
of a
Sensationally Low Price

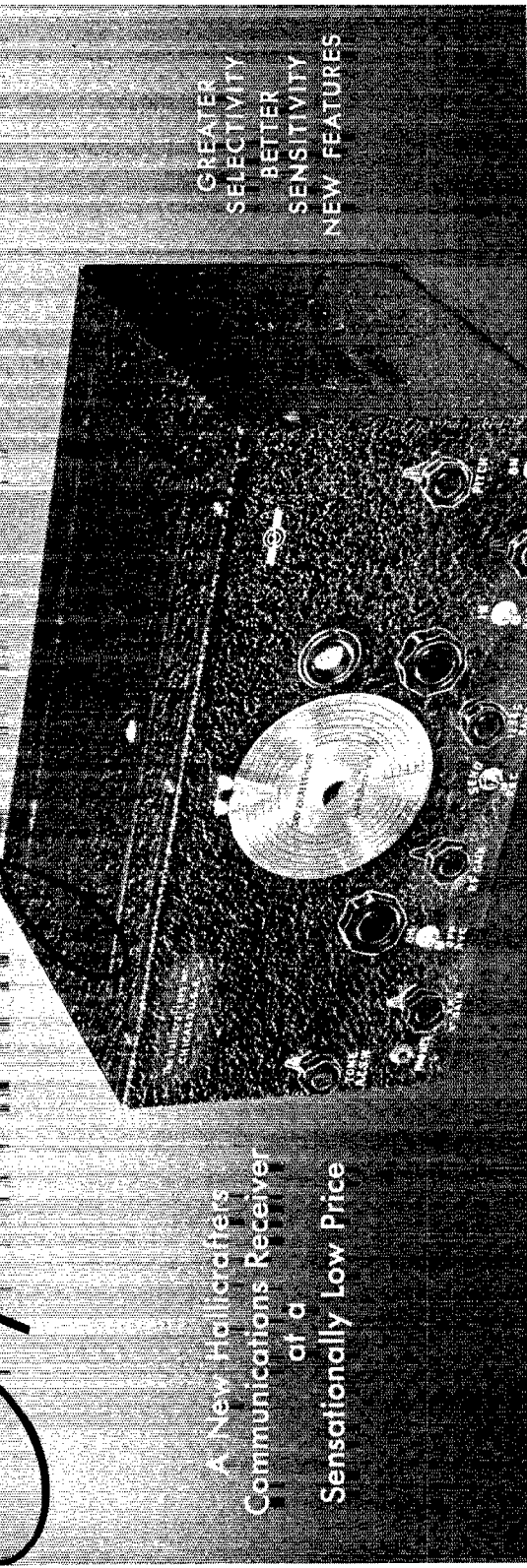

**GREATER
SELECTIVITY
BETTER
SENSITIVITY
NEW FEATURES**

The Sky Challenger fills a very definite need for a communications receiver with the desirable features for efficient reception — at a price every amateur can afford. It provides complete coverage from 7.5 to 540 meters (no gaps), including not only the amateur radio bands in this range but short wave broadcast, police, aviation and

the regular broadcast bands as well.
With finer sensitivity and greater selectivity, Electrical Band Spread, 5 Band Dial with a simple and convenient Band Switch, the Sky Challenger answers every reasonable requirement for amateur and short wave reception. Available on Time Payments through your dealer.

FEATURES

- 6 Metal — 3 Glass Tubes
- 40 M C to 535 K C in 5 Bands
- 338° Main Tuning Dial
- Electrical Band Spread
- Iron Core I. F. for Improved Selectivity
- Direct Calibration Tuning — No Charts or Tables

SEE IT AT YOUR DEALER'S OR WRITE FOR COMPLETE DETAILS

the hallicrafters inc.

2611 INDIANA AVENUE, CHICAGO, ILLINOIS..... CABLE ADDRESS "HALLICRAFT" CHICAGO

WE HAVE IT!

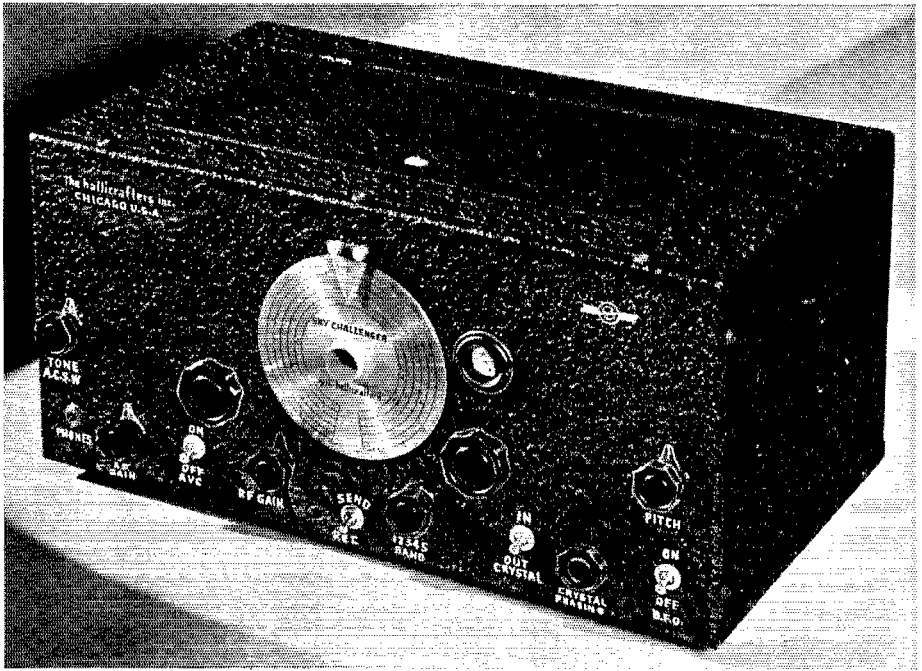

THE NEW HALLICRAFTERS SKY CHALLENGER

ONCE again Hallicrafters have achieved the remarkable! Here's the Sky Challenger, a new 9-tube superheterodyne with those features needed for efficient short wave reception, offered at an amazingly low price.

Never before have we offered such an outstanding value to the radio amateur. It has finer sensitivity, truly amazing selectivity, Electrical Band Spread — each feature and control to suit amateur needs — features ordinarily found only in receivers sold at higher prices.

As amateurs and dealers in amateur receivers and transmitters exclusively, we have long felt the need for a truly efficient receiver at this price level.

Every amateur regardless of the condition of his purse, can afford this fine and truly outstanding receiver designed especially for communications and short wave reception.

Send in the coupon today! Get complete information on this amazing receiver.

AVAILABLE ON EASY TIME PAYMENTS

Enjoy the splendid performance of the new SKY CHALLENGER as you pay for it on Hinds & Edgerton Easy Time Payments.

\$69⁵⁰

Features —

- 6 Metal — 3 Glass Tubes
- 40 M C to 535 K C in 5 Bands. No Gaps.
- 338° Main Tuning Dial
- Electrical Band Spread
- Iron Core I. F. for Improved Selectivity
- Direct Calibration Tuning — No Charts or Tables

----- MAIL THIS COUPON -----
HINDS & EDGARTON ESTABLISHED 1914

19 South Wells Street, Chicago, Illinois

Please send me complete information on SKY CHALLENGER.

Name _____ Call _____

Address _____ City _____ State _____

OPERATED BY W9APY AND W9WR

QST

devoted entirely to

AMATEUR RADIO

PUBLISHED, MONTHLY, AS ITS OFFICIAL ORGAN, BY THE AMERICAN RADIO RELAY LEAGUE, INC., AT WEST HARTFORD, CONN., U. S. A.; OFFICIAL ORGAN OF THE INTERNATIONAL AMATEUR RADIO UNION

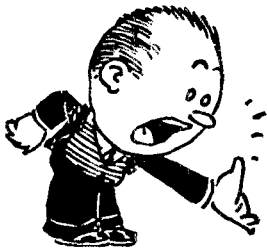

FEBRUARY

1937

Volume XXI

Number 2



Kenneth B. Warner (Secretary, A.R.R.L.), *Editor-in-Chief and Business Manager*; Ross A. Hull, *Associate Editor*; James J. Lamb, *Technical Editor*; George Grammer, *Assistant Technical Editor*; Clark C. Rodimon, *Managing Editor*; David H. Houghton, *Circulation Manager*; F. Cheyney Beekley, *Advertising Manager*; Charles Brunelle, *Assistant Advertising Manager*.

Editorial and Advertising Offices

38 La Salle Road
West Hartford, Connecticut

Subscription rate in United States and Possessions and Canada, \$2.50 per year, postpaid; all other countries, \$3.00 per year, postpaid. Single copies, 25 cents. Foreign remittances should be by international postal or express money order or bank draft negotiable in the U. S. and for an equivalent amount in U. S. funds.

Entered as second-class matter May 29, 1919, at the post office at Hartford, Connecticut, under the Act of March 3, 1879. Acceptance for mailing at special rate of postage provided for in section 1103, Act of October 3, 1917, authorized September 9, 1922. Additional entry at Concord, N. H., authorized February 21, 1929, under the Act of February 28, 1925.

Additional second-class entries to cover sectional editions authorized March 20, 1935. Copyright 1937 by the American Radio Relay League, Inc. Title registered at United States Patent Office.

The Contents

Editorials	9
The Hiram Percy Maxim Memorial Award	10
Announcing — The Maxim Memorial Relay	11
Practical Organization and Equipment for Emergency Operation <i>John P. Tynes, W6GPY</i>	13
Medium-Power Pentode Transmitter for Smooth Break-in Operation <i>Byron Goodman, W1JPE</i>	17
What the League Is Doing	20
About This Harmonic Radiation Problem <i>R. W. Woodward, W1EAO</i>	22
A.R.R.L.'s Ninth International DX Competition	25
All-Continent 'Phone Round Table	28
The Doherty High-Efficiency Amplifier Applied to Amateur 'Phone <i>Bruce Montgomery, W9AHH</i>	30
Radio Fadeouts Through 1936 <i>J. H. Dellinger</i>	35
Hamdom	36
More DX Per Dollar. Part I <i>Charles D. Perrine, Jr., W6CUH</i>	37
A Simple Directive Antenna <i>Manfred Asson, ES2D</i>	42
Operating Notes on Power Crystal Oscillators <i>J. M. Wolfskill, W8QKT</i>	43
Amateur Applications of the Static-Type Velocity Microphone <i>Paul von Kunits</i>	47
How Would You Do It?	50
Technical Topics	51
Hints and Kinks for the Experimenter	
Output Coupling Method — Meter Switching — Tuning Indicator — Another Use for the Auto Transformer — The Two-Tube Receiver on Ten Meters — A Modified Crystal Oscillator Circuit	52
I.A.R.U. News	56
Operating News	58
Correspondence	67
Educational Radio Broadcast over W1XAL	88
Standard Frequency Transmissions	90
The Hudson Division Convention	98
Book Review	108
Hamads	123
Index of Advertisers	126

New

TRANSMITTING CONDENSERS *Type "MTC"*

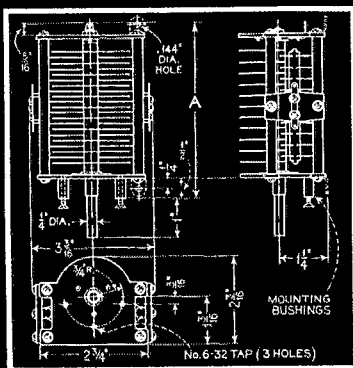
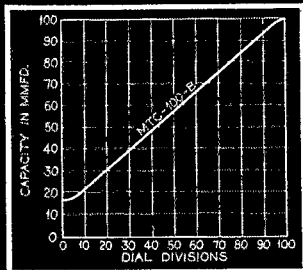
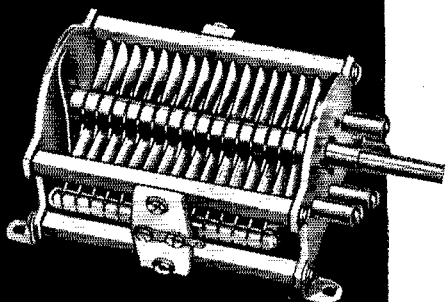

A NEW popular series of transmitting condensers for high frequency and ultra-high frequency medium and low powered units. The construction of these condensers is so rugged that even rough handling will not damage them. Though low in price, these condensers include all constructional features necessary in quality transmitters of all kinds. High operating efficiency has been attained by extensive research in materials and design plus careful workmanship.

Made in both single and split-stator styles, with end frames of heavy aluminum sheet. Rotor and stator plates of heavy aluminum are firmly anchored in place by wedging them into deep slots and then by further staking. An accurately ground stainless steel shaft is carefully fitted to a long bronze front bearing mounted on a Beryllium cushion disc. The free floating action thus afforded provides for a perfect bearing and consistently smooth operation. Rear bearing is of the steel ball and cup type. Isolantite insulation and silver-plated Beryllium contact wiper assures lowest losses and lowest series resistance. Noiseless operation and complete stability under all conditions guaranteed!

Produced in 19 different sizes — 20 to 530 mmf. — 1000 to 6000 volts — panel or base mounting. Prices range from \$2.40 to \$8.50!

Here is the ideal transmitting condenser for your quality transmitter. For complete details send for the special "MTC" bulletin. Write for it to-day!



HAMMARLUND MANUFACTURING CO., INC.
424-438 West 33rd Street, New York City

HAMMARLUND'S 25TH YEAR

MAIL THIS COUPON

HAMMARLUND MFG. CO., 424-438 W. 33rd St., N. Y. City
 Please send me the new "MTC" bulletin. Q2

Name.....

Address.....

*for tube
excellence*

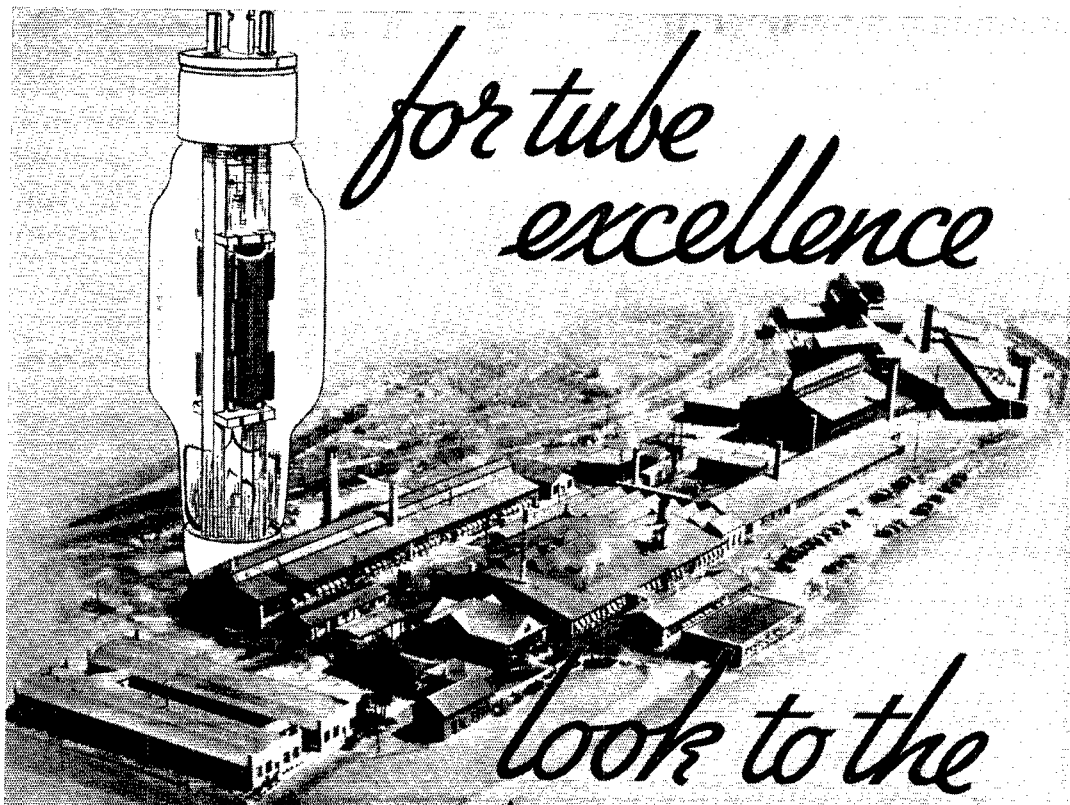

Plant of Speer Carbon Co. for 39 years an ever-dependable source of Quality-graphite products.

look to the
A N O D E

SPEER graphite anodes are used by leading manufacturers to produce radio tubes having qualities superior to those obtainable with other materials. And that's not all . . .

Constant characteristic values throughout long life, higher wattage dissipation, with absence of hot spotting or warping, and ability to resist damage from accidental overloading, are qualities inherent in tubes made with SPEER graphite anodes. Further, the accuracy with which SPEER graphite anodes are machined permits the construction of tubes of remarkable uniformity.

The extra service and satisfaction you can get by using tubes with SPEER Graphite Anodes are important enough to justify a prompt trial.

Write for booklet on graphite radio anodes. It gives detailed facts. Names of well-known tube producers using SPEER Graphite Anodes will be sent on request.



**SPEER CARBON COMPANY
ST. MARYS, PA.**

**S P E E R G R A P H I T E
R A D I O T U B E**

A N O D E S

TRIPLET

Pocket Volt-Ohm Milliammeter D.C. and A.C.

Size
3 1/16" x 5 7/8" x 2 1/8"



MODEL 666

DEALER \$15.00
PRICE **15.00**

A complete instrument for all servicing needs. Can be used for all A.C.-D.C. voltage, current and resistance analyses.

LEATHER CARRYING CASE
Model 669, supplied extra.

Very attractive. Of black, heavy leather with finished edges and strap.

- Uses Large 3" Sq. Triplet Instrument.
- A.C.-D.C. Voltage Scales Read: 10-50-250-500-1000 at 1000 ohms per volt.
- D.C. Milliampere Scale Reads: 1-10-50-250.
- Ohms Scale Reads: Low 1/2-300; High 250,000.
- Black Molded Case and Panel.
- Low Loss Selector Switch.
- Complete with Alligator Clips, Battery and Test Leads.

Dealer Price . . . \$15.00

SEE YOUR JOBBER WRITE FOR CATALOG



THE TRIPLET ELECTRICAL INSTRUMENT CO.
252 Harmon Ave., Bluffton, Ohio

Without obligation please send me More information on Model 666. I am also interested in.....

Name

Address

City.....State.....

Section Communications Managers of the A.R.R.L. Communications Department

All appointments in the League's field organization are made by the proper S.C.M., elected by members in each Section listed. Mail your S.C.M. (on the 16th of each month) a postal covering your radio activities for the previous 30 days. Tell him your DX, plans for experimenting, results in phone and traffic. He is interested, whether you are an A.R.R.L. member or get your QST at the newstands; he wants a report from every active ham. If interested and qualified for O.R.S., O.P.S. or other appointments he can tell you about them, too.

Eastern Pennsylvania	W3EZ	ATLANTIC DIVISION James M. Bruning	339 W. Lancaster Ave.	Haverford
Maryland-Delaware-District of Columbia	W3BAK	Edgar L. Hudson		Laurel, Delaware
Southern New Jersey	W3ZX	Carroll D. Kentner	1107 Park Ave.	Collingswood
Western New York	W8DS	Charles Smith	310 E. Walnut St.	Onesida
Western Pennsylvania	W8OFO	Kendall Speer, Jr.		Lowber
		CENTRAL DIVISION		
Illinois	W9KTY	L. John Huntoon	327 Brandon Ave.	Glen Ellyn
Indiana	W9TE	Arthur L. Braun	530 East Morris St.	Indianapolis
Kentucky	W9AUH	G. W. Mossbarger	Box 177	Camp Taylor
Michigan	W8DPE	Harold C. Bird	R.E.D. 2	Pontiac
Ohio	W8AQ	E. H. Gibbs	300 High St.	Wadsworth
Wisconsin	W9ATO	E. A. Cary	3922 No. 19th Pl.	Milwaukee
		DAKOTA DIVISION		
North Dakota	W9OEL	Hartwell E. Burner		Hope
South Dakota	W9SEB	Andrew J. Kjar	221 West Prospect Ave.	Pierre
Northern Minnesota	W9OWU	Leonard Hofstad		Elbow Lake
Southern Minnesota	W9DCM	Webster F. Soules	3549 36th Ave., So.	Minneapolis
		DELTA DIVISION		
Arkansas	W5ABI	H. E. Vette	2918 West 15th St.	Little Rock
Louisiana	W5DWV	W. J. Wilkinson, Jr.	1523 Laurel St.	Shreveport
Mississippi	W5CWQ	J. H. Weems, Jr.	P. O. Box 244	State College
Tennessee	W4DEF	B. G. Lowrey Smith	673 Hillcrest St.	Memphis
		HUDSON DIVISION		
Eastern New York	W2LJ	Robert E. Haight	511 South Holmes St.	Scotia
N. Y., C. & Long Island	W2AZV	E. L. Baunach	102 Central Ave.	Massapequa, L. I.
Northern New Jersey	W2FOP	Charles J. Hammersen	92 Claremont Ave.	Verona
		MIDWEST DIVISION		
Iowa	W9NNM	Owen Williams	108 No. Johnson St.	Iowa City
Kansas	W9PB	Harry E. Leeder	304 Miami St.	Hiawatha
Missouri	W9CJR	J. Dewey Mills	Box 205	Mount Vernon
Nebraska	W9FAM	Samuel C. Wallace	Green St.	Clarks
		NEW ENGLAND DIVISION		
Connecticut	W1CTI	Frederick Ellis, Jr.	19 Merrill Rd.	Norwalk
Maine	W1CDX	John W. Singleton	73 Allen St.	Wilton
Eastern Massachusetts	W1ABG	Albert N. Giddis	128 Crawford St.	Lowell
Western Massachusetts	W1JAH	William J. Barrett	239 Columbia St.	Adams
New Hampshire	W1BFT	Carl E. Evans	80 No. State St.	Concord
Rhode Island	W1HRC	Clayton C. Gordon	192 Washington Ave.	Providence
Vermont	W1GNF	Alvin H. Battison	1 Central St.	Windsor
		NORTHWESTERN DIVISION		
Alaska	K7PO	Richard J. Fox	Box 301	Ketchikan
Idaho	W7NH	Nellie H. Hart	Box 0	Twin Falls
Montana	W7CRH	Russell U. Richmond		Somers
Oregon	W7AJV	Eugene E. Lovejoy	5013 N. E. Clackamas	Portland
Washington	W7WY	Robert H. Votaw	Route 1, Box 398	Vancouver
		PACIFIC DIVISION		
Hawaii	K6EWQ	Atlas O. Adams	21st Infantry Brigade	Schofield Barracks
Nevada	W6BIC	Edward W. Heim	509 Claremont St.	Reno
Santa Clara Valley	W6FBW	Elbert Amarantes	475 So. 11th St.	San Jose
East Bay	W6FTV	Harold J. Burchfield	2240 106th Ave.	Oakland
San Francisco	W6GSC	Stan D. Whittaker, Jr.	79 Elinor Ave.	Mill Valley
Sacramento Valley	W6DVE	Geo. L. Woodington	716 Redwood Ave.	North Sacramento
Philippines	KA1GR	George L. Rickard	Box 849	Manila
San Joaquin Valley	W6LPE	Angelo V. Astone	729 Safford	Fresno
		ROANOKE DIVISION		
North Carolina	W4QG	H. S. Carter	115 Crafton St.	Winston-Salem
Virginia	W3UVA	Charles M. Waff, Jr.	P. O. Box 1212	Univ., Charlottesville
West Virginia	W8KEG	Dr. Wm. H. Riheldaffer		Lost Creek
		ROCKY MOUNTAIN DIVISION		
Colorado	W9FA	Glen Glasscock	2164 So. Corona St.	Denver
Utah-Wyoming	W7COH	Townsend J. Rigby		Midwest, Wyoming
		SOUTHEASTERN DIVISION		
Alabama	W4DGS	James F. Thompson	2248 S. Arlington Ave.	Birmingham
Eastern Florida	W4ASR	William C. Shelton	556 Westmoreland Drive	Daytona Beach
			"Hillcrest", P.O. Box 652	
Western Florida	W4MS	Edward J. Collins	1517 East Brainard St.	Pensacola
Georgia-So. Carolina-Cuba-Isle-of-Pines-Porto Rico-Virgin Islands	W4CE	Bannie L. Stewart	C.C.C. Camp MP-1	York, S. C.
		SOUTHWESTERN DIVISION		
Los Angeles	W6GXM	Don M. Draper	4421 West 63 St.	Los Angeles
Arizona	W6LVG	C. C. Day	"La Posta Quemada"	Vail
San Diego	W6EOP	Harry A. Ambler	4101 Hamilton St.	San Diego
		WEST GULF DIVISION		
Northern Texas	W5BII	Richard M. Cobb	Box 185	Dodd City
Oklahoma	W5CEZ	Carter L. Simpson	2010 So. 4th St.	Ponca City
Southern Texas	W5BDI	Ammon O. Young	4803 Eli St.	Houston
New Mexico	W5CGJ	Joseph M. Eidott		Chamita
		MARITIME DIVISION		
Maritime	VE1DQ	A. M. Crowell	69 Dublin St.	Halifax, N. S.
		ONTARIO DIVISION		
Ontario	VE3SG	Fred H. B. Saxon	302 Lee Ave.	Toronto, Ont.
		QUEBEC DIVISION		
Quebec	VE2EE	Stan Comach	780 Brault Ave.	Verdun, P. Q.
		VANALTA DIVISION		
Alberta	VE4LX	Alfred D. Kettenbach		Rockyford
British Columbia	VE5EP	D. R. Vaughan-Smith	1221 Burnaby St.	Vancouver
		PRAIRIE DIVISION		
Manitoba	VE4BG	A. J. R. Simpson	71 Thelmo Mansions	Winnipeg
Saskatchewan	VE4EL	Wilfred Skaife	2040 McTavish St.	Regina

* Officials appointed to act until the membership of the Section choose permanent S.C.M.'s by nomination and election.

The American Radio Relay League



THE AMERICAN RADIO RELAY LEAGUE, INC., is a non-commercial association of radio amateurs, bonded for the promotion of interest in amateur radio communication and experimentation, for the relaying of messages by radio, for the advancement of the radio art and of the public welfare, for the representation of the radio amateur in legislative matters, and for the maintenance of fraternalism and a high standard of conduct.

It is an incorporated association without capital stock, chartered under the laws of Connecticut. Its affairs are governed by a Board of Directors, elected every two years by the general membership. The officers are elected or appointed by the Directors. The League is non-commercial and no one commercially engaged in the manufacture, sale or rental of radio apparatus is eligible to membership on its board.

"Of, by and for the amateur," it numbers within its ranks practically every worth-while amateur in the nation and has a history of glorious achievement as the standard-bearer in amateur affairs.

Inquiries regarding membership are solicited. A bona fide interest in amateur radio is the only essential qualification; ownership of a transmitting station and knowledge of the code are not prerequisite. Correspondence should be addressed to the Secretary.

HIRAM PERCY MAXIM, FOUNDER

OFFICERS

President.....EUGENE C. WOODRUFF, W8CMP
State College, Pa.

Vice-President.....GEORGE W. BAILEY, W1KH
Weston, Mass.

Secretary.....KENNETH B. WARNER, W1EH
West Hartford, Connecticut

Treasurer.....ARTHUR A. HEBERT, W1ES
West Hartford, Connecticut

Communications Mgr....F. EDWARD HANDY, W1BDI
West Hartford, Connecticut

General Counsel.....PAUL M. SEGAL
1010 Shoreham Building, Washington, D. C.

Address all general correspondence to the administrative headquarters at West Hartford, Connecticut

DIRECTORS

President
EUGENE C. WOODRUFF.....W8CMP
234 W. Fairmount Ave., State College, Pa.

Vice-President
GEORGE W. BAILEY.....W1KH
74 Webster Road, Weston, Mass.

Canadian General Manager
ALEX REID.....VE2BE
169 Logan Ave., St. Lambert, P. Q.

Atlantic Division
WALTER BRADLEY MARTIN.....W3QV
Box 612, Roslyn, Pa.

Central Division
R. H. G. MATHEWS.....W9ZN
100 East Ohio St., Chicago

Dakota Division
CARL L. JABS.....W9BVH
1822 James St., St. Paul, Minn.

Delta Division
E. RAY ARLEDGE.....W5SI
P. O. Box 286, Pine Bluff, Ark.

Hudson Division
KENNETH T. HILL.....W2AHC
115 Willow St., Douglaston, L. I., N. Y.

Midwest Division
FLOYD E. NORWINE, JR.....W9EFC
120 South Fourth St., St. Louis, Mo.

New England Division
PERCY C. NOBLE.....W1BVR
37 Broad St., Westfield, Mass.

Northwestern Division
RALPH J. GIBBONS.....W7KV
c/o United Air Lines, Pendleton, Ore.

Pacific Division
S. G. CULVER.....W6AN
2962 Russell St., Berkeley, Calif.

Roanoke Division
H. L. CAVENESS.....W4DW
State College Station, Raleigh, N. C.

Rocky Mountain Division
EDWARD C. STOCKMAN.....W9ESA
618 So. Williams St., Denver

Southeastern Division
BENNETT R. ADAMS, JR.....W4APU
1512 Grove Place, Homewood, Ala.

Southwestern Division
CHARLES E. BLALACK.....W6GG
443 Main St., El Centro, Calif.

West Gulf Division
WAYLAND M. GROVES.....W5NW
Box 118, Talco, Texas

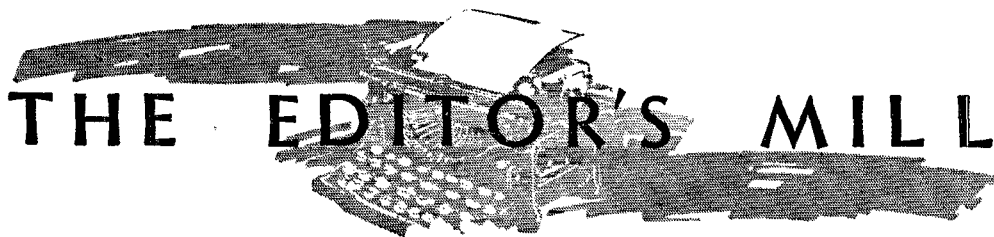

THE EDITOR'S MILL

In Memoriam

HIRAM PERCY MAXIM

SEPTEMBER 2, 1869—FEBRUARY 17, 1936

CHARLES H. STEWART

JULY 11, 1873—FEBRUARY 12, 1936

AMATEUR radio this month sadly observes the first anniversary of the passing of those two fine old gentlemen who between them gave nearly sixty years to its service. President and vice-president, respectively, of both the International Amateur Radio Union and the American Radio Relay League, and the first the founder of both organizations, it is to be said with no exaggeration that our art of to-day owes its status to the quality of leadership, the character of organization and the principles of conduct which they personified.

Hiram Percy Maxim was the original relay man of modern-day organized amateur radio. Around the theme of relaying the League was first set up. With what we think is peculiar fitness, the anniversary of his passing—February 17th—is to be commemorated by a great A.R.R.L. relay. The details are announced elsewhere in this issue by the Communications Manager. They involve the transmission of an appropriate message from the President of the League by some selected stations, the interception of that message by amateurs everywhere, the transmission of a message to League headquarters by each interceptor, and the relaying of these messages to West Hartford by the amateur body generally. The President will send a souvenir QSL to every participant. The relaying of messages is one of the chief outward manifestations of amateur service. It is the League's thought in arranging the relay of February 17th to provide a medium by which each of us can participate in honoring the memory of our founder.

In this issue we also report the establishment of an annual award in memory of Mr. Maxim by his son and daughter. It is confined to the younger amateurs, in token of Mr. Maxim's great and warm-hearted interest in the struggling experimenter. It seems to us that it will very aptly perpetuate that interest, by seeking to recognize each year's outstanding young amateur. Father Time has already barred most of us from eligibility; the part that most of us can play is to bring meritorious young folks to the attention of our

Section Communications Managers, who will make nominations for the award. Each year's award will consist of a sum of cash and an engraved miniature reproduction of the original Wouff Hong which is preserved at A.R.R.L. headquarters. When *The Old Man*, that genial pirate who was none other than H.P.M. himself, unearthed and forwarded to the A.R.R.L. Board the first and only known authoritative specimen of the awesome Wouff Hong, it straightway attained top eminence in our traditions. It is a fitting ornament for one who has been chosen best amongst us. Any authorized custodian of a Wouff Hong is automatically a person who has made his mark. We shall envy the young man or young woman who receives the Hiram Percy Maxim Memorial Award.

One more Maxim item is to be reported this month. We have pleasure in announcing that the Federal Communications Commission, with the special approval of the Maxim heirs, has changed the call of the A.R.R.L. headquarters station to W1AW. This station, the common property of us all, is in process of being rebuilt as a permanent radio memorial to Mr. Maxim. No more fitting aid to this memory could be devised than that it should perpetuate his famous old call. We believe this is the first instance of the F.C.C. authorizing a change in an amateur call. It was done in this case as a mark of special esteem for the founder of the amateur's own national organization. It must be regarded as a very gracious act on their part, and one of which we should all be appreciative. The new call will be used from headquarters for the first time on the memorial relay of February 17th.

Bracketed with *T.O.M.* in our affections must be the memory of Charles H. Stewart, who passed on in the same month a year ago. With the passage of the months he looms the more as a man of wisdom and stature in our regulatory problems and of the qualities of true friendship. A.R.R.L. this month salutes the memory of Stewart and Maxim, salutes anew the things for which they stood.

K. B. W.

The Hiram Percy Maxim Memorial Award

Our Founder's Daughter and Son Offer Annual Award for Best Contribution or Record by Young Amateurs

IN MEMORY of their father, Hiram Percy Maxim, the two children of the founder of the American Radio Relay League have established an annual award which will perpetuate in an effective manner the warm and vital interest which he had in the welfare and the activities of the young radio amateur. Mr. Maxim had a really great interest in the young amateur, particularly the one struggling under handicaps. It is singularly appropriate that the Hiram Percy Maxim Memorial Award will be given annually to that member of the League who is under twenty-one years of age at the end of the year and who has made the greatest contribution during the year to amateur radio, or who has the best all-around record for the year.

This award has been created in loving memory of our founder by Mrs. John G. Lee (Percy Maxim), his daughter, and Hiram Hamilton Maxim, his son. It will consist of a gift of one hundred dollars in cash and a miniature reproduction of the "Wouff Hong" bearing suitable engraving. As every amateur now knows, Mr. Maxim himself was "The Old Man," author of *QST*'s famous "Rotten" stories, in one of which the Wouff Hong was given birth.

This award does not involve a competition. This is no contest. It is an occasion for seeking out and recognizing the best young amateur amongst us. Candidates for the award are to be nominated by the Section Communications Managers, and from these the judges will select the winner.

One outstanding feature of this award is that it is to be made to amateurs who have not yet attained the age of twenty-one years. Equally significant, however, is the fact that it is to be for contributions and accomplishments in *amateur radio*, not in other fields. The scope of this field is very broad and there is opportunity for all young amateurs. What is sought is the outstanding one who, by his works, ought to have this recognition

and encouragement. The award may be given for a single outstanding contribution, such as a technical development of far-reaching effect or some particularly meritorious communication, or for any similar specific accomplishment. Or it may go to that young amateur who has the best all-around amateur record for the year. In the latter event, the judges would doubtless take into account numerous factors that enter naturally into the determination of a good record: such items as the general excellence of the station and the ingenuity employed in constructing it, the message traffic handled, the participation in emergency communication, the quality of the sending, participation in the organized communication work of the League, the amateur's technical developments and contributions to *QST*, his similar contributions to the technique of operating or of club work or to the public relations of amateur radio, the cleanliness of his record in complying with government regulations, his cooperation with the broadcast-listening public, his versatility with different forms of amateur radio such as both telegraphy and 'phone and both domestic and DX communication, his observance of the Amateur's Code as concerns his attention to school work or his other normal duties as a young citizen, and so on. Any or all of these factors may enter, or the award may go for a single superb accomplishment.

In the future years of this award, arrangements will be made late each year for choosing the winner so that he may be announced early in the new year. However, there will be an award to the best young amateur of 1936, the search for whom is now under way, and the announcement will be made as soon as possible. At the special request of the donors, the judges for the first award are the radio members of the League's headquarters staff. The terms of their offer, however, alternatively provide that in future years the

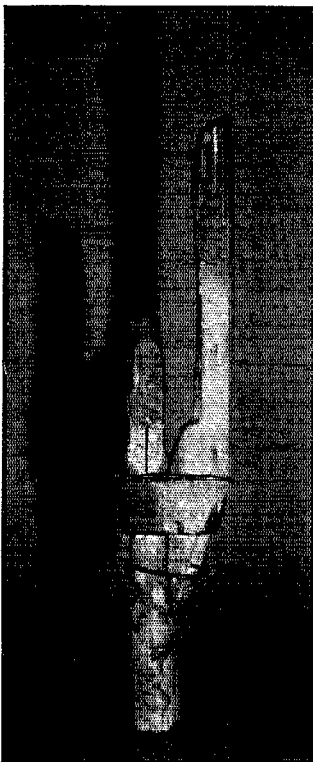

THE WOUFF-HONG

Board of Directors may name a special committee of its members for this purpose if it so prefers.

There are a few simple rules:

1. The award is available only to members of the American Radio Relay League in good standing who reside in the United States or its territories or possessions or in the Dominion of Canada, and who hold amateur licenses issued either by the Federal Communications Commission or by the Canadian government.

2. To be eligible, the member shall not have reached his or her twenty-first birthday by the last day of the calendar year in respect of which an award is being made.

3. There is no competition, no "entries" by

"contestants." Nominations will be made by the League's S.C.M.'s, the judges selecting the winner as the best of those thus nominated. Members of the League are invited to suggest likely candidates to the S.C.M.'s. Members of the headquarters staff of course are not eligible.

We are grateful to Mrs. Lee and Mr. Maxim for making this award available. It seems to us an altogether fitting way to keep green the memory of the Old Chief who gave so much to the amateur radio he loved. And we are quite delighted at the idea of a reproduction of the sacred and honorable Wouff Hong because it so successfully brackets those two delightful personalities, H. P. M. and T. O. M.

—K. B. W.

Announcing—The Maxim Memorial Relay

President Woodruff, W8CMP, to Send Commemorative Message February 17th—Following Reception from A.R.R.L. OBS—OPS You are Invited to Respond by Radiogram

ONE year ago, on February 17, 1936, amateur radio suffered the loss of the man whose energy and vision resulted in amateur organization, in the creation and up-building of the American Radio Relay League dedicated to mutual advancement, representation, fraternalism, and progress in communication and experimentation. It is fitting that on this anniversary date, all of us who benefit from the institution of amateur radio that his vision made possible, should pay our respects to the memory of our founder, his ideals, and the fine tradition of our amateur service. President Woodruff, in keeping with this thought, has a commemorative message for amateurs which will be addressed to us all by radio through the League's Official Broadcasting Stations and Official 'Phone Stations on February 17th.

The value and meaning in this message lies in our individual participation in reception and thoughtful observance of the occasion. Our president invites us each to acknowledge the reception of his words by sending to Headquarters a brief amateur radiogram giving the call and frequency band of the station from which you received the message on one of the scheduled transmissions . . . a radio activity such as honors to the utmost the memory of the Original Relayer, and such as we know would have appealed to him. There follow the definite plans for this observance on the evening of February 17, 1937.

1. Transmissions of President Woodruff's message to you will be made from W1AW, and by

c.w. and 'phone, in all amateur bands, from all A.R.R.L. O.B.S. and O.P.S., some hundreds of stations well distributed geographically throughout the 69 A.R.R.L. Sections. On February 17th at 6:00 P.M. EST, the first transmission, from W1AW,* will be made, by tape sending on 3825, 7150, and 14,300 kcs. The identical message will be repeated, addressed to you through each one in the League's nationwide chain of Official Broadcasting and Official 'Phone Stations, on each following hour, *your local time*, for five consecutive transmissions. Look for the message on any band, at

7:00 P.M. 8:00 P.M. 9:00 P.M.
10:00 P.M. 11:00 P.M.

2. After hearing the message from any station, you are invited to start a reply or acknowledgment message addressed to A.R.R.L. In this message please give the call and frequency band of the station you heard with the message. It is understood that you will have a word by mail from President Woodruff for each radio acknowledgment received at Hartford. If your station is not active, try to send radio word of participation through another local amateur station. Message preambles should be sent in proper form—the

* W1AW, for many years H.P.M.'s personal call, has just been assigned the Headquarters' station, in lieu of W1MK, by very special F.C.C. action. This 6:00 P.M. transmission of President Woodruff's message is the first official transmission in the Relay. It is also the very first use of W1AW on the air as your Headquarters Station. The "memorial" occasion seems appropriately one in which to rededicate operation in the spirit of service and inspiration of our founder. Further details of W1AW operation are given in the Operating News department.

same as the order of parts in the message you hear bearing Dr. Woodruff's signature. Start all messages (or give them a filing time) before midnight your local time, i.e. on February 17th. Observance of the relay is on this date. Traffic will of course be on the air until it reaches destination.

Some suggestions about the reply messages: Make them brief. It is not necessary to give your response directly to WIAW or even to a Connecticut station. It may be better to give to intermediate stations, to O.R.S. and members of Section Nets and Trunks for a real relay depending on operator-coöperation. "CQ MM" will be the general call used by stations with Connecticut bound traffic. "CT" or "CONN" after calls will identify stations on the delivery end ready for your traffic. Of course voice operated stations will not use telegraph abbreviations but will be "Calling any Connecticut station." After your message is off, you may be able to help in relaying several others if you like.

A large number of Connecticut stations will be on the air on every active amateur band, both c.w. and 'phone bands, and frequencies all through the bands, on February 17th and also the 18th to get this traffic addressed to A.R.R.L.—A special 30-hour watch at WIAW will be kept for incoming traffic. Look especially for the following stations whose operators have pledged coöperation to get your messages.

1715-2000 kc.

'PHONE W1IMV JYX KAB KDK

3500-4000 kc.

3500-3633: WIAW BAW BDI BGJ BUE CEJ DEP EH
ES FE FKQ GC GME GVV HAX HSX HYF IKE
JFN JMY JTD KAT KAY KBJ KHM TD TS UE
JBS IYB

3633-3766: WIAW CTI GME HSX HTS ITI JMY JTD
JWN JXP TS UE AJB KV AFB APZ FAJ FRK HXL
3766-3900: WIAW BDI BFS BHM BNB CJZ CTI FE
FKQ GC GME GVV HAX HSX HXZ HYF ITI
JFN JTD TS UE INP HXL KV AJB FRK GKM
APZ FAJ

3900-4000 kc. 'PHONE: WIDWP EAO EEP GC HVF
IMV SZ

7000-7300 kc.

7000-7150: WIAW BDI CJZ FKQ HYF IBT IKE JIR
JIL JPE JXV KBJ TS CSC HPI GKM FIY

7150-7300: WIAW BIH EAO EH HSX JAM JHN JXV
JYW TS HPI IGZ

14000-14400 kc.

G.W. WIAW BGJ DF EH IGR IKE JPE JWW
JXV KBJ TS HPI

'PHONE: W1SZ

28 Mc.

G.W. W1JPE GOP

"Activity" in a radio operating sense always appealed to Mr. Maxim, our founder, as a significant way to observe events. The "relay" idea was the basis of founding our association and still means the ultimate in universal coöperation and friendship between amateurs. Commemoration is a thing of the heart. Let us as we take part, pause to reflect. Let us dedicate our purposes anew.

Amateurs not members of A.R.R.L. should become mindful of the need for their full support of and membership in "the group working for the

individual" as President Woodruff so aptly refers to our organization. Membership of every amateur lends true strength to our national body.

Recently licensed amateurs should review (in Chapter One of the *Handbook*, or *Two Hundred Meters and Down*) the tradition and honorable history of achievement of amateurs, to familiarize themselves with what has gone before and make a true commemoration possible for them.

Active amateurs, let us all renew our ideals and rededicate our purposes even beyond the bound of this relay activity in which we will honor the memory of Hiram Percy Maxim. The vast body of amateurs who are full fledged members of the A.R.R.L. will pledge themselves to renewed purpose in their amateur operation and endeavors. The spirit of constructive contributions to others in our amateur work must not and will not die. It was ever present in the efforts of Mr. Maxim. This spirit lives and is renewed through such practical media as our individual determinations to take part in and strengthen all fields of amateur work.

Let us each make it our purpose to be a constructive member, to get a member, to be a contributing member through experiments and articles; to operate actively—helping others as well as ourselves, to make and keep schedules, to become ORS or OPS, to give words of help and kindness to fellow amateurs, to be watchful of adjustments and testing which may affect our fellow amateurs' enjoyment, to build modulation monitor or c.w. monitor listening equipment to improve our signal and sending for the general welfare (which includes our own), to join the A.E.C., to be active in A.A.R.S. or N.C.R. contributions to our country, to build and have ready to use emergency-powered equipment . . . or otherwise to make ourselves more capable of serving the public (and amateur radio's) true welfare. Let us make this commemorative occasion a time of new resolution, and purpose, for each and every good radio amateur, in all our accomplishment mindful of the perpetuation of the spirit and ideals of T.O.M. that make for the strongest amateur radio and strongest A.R.R.L.

—F. E. H.

— . . . —

Attention, W2 Hams!

An extra-special joint meeting of the A.R.R.L. Hudson Division and the Hudson Phone Assn. will be held at the Wurlitzer Auditorium, 120 West 42d St., Manhattan, at 8 p.m., Thursday, Feb. 25th. Chance to meet everybody in the division. The program will include two good technical speakers, one supplied by each organization. It is likely that one of the speakers will talk on harmonic troubles and practical, understandable methods of avoiding them. There will probably be an open forum discussion in addition. No admission charge. All amateurs invited.

Practical Organization and Equipment for Emergency Operation

S.A.R.O. Experience in Preparation for Amateur Service in Times of Disaster

By John P. Tynes,* W6GPY

This account of the development of amateur emergency communication organization and equipment in Oakland, California was sent us via A.R.R.L. S.C.M. Burchfield, W6JTV, of the East Bay Section. He says: "Every member of the Society of Amateur Radio Operators has a specialized job, and every man is doing that job when and where needed. These fellows have more on their minds than just contacts over the air, DX, or personal QSO's. The article indicates the progress and development of less than two years." Needless to say, members of the S.A.R.O. are also members of the A.R.R.L. Emergency Corps. Prepare now for emergencies—and it is not too early to get equipment going for use in the coming June Field Day dedicated to emergency testing of portables. We feel sure all hams can profit from the constructive information forwarded by the S.A.R.O.—EDITOR.

AMATEUR radio is one of the finest of hobbies; on that all amateurs are agreed. Its existence as a hobby, however, depends on factors which make it of value to the people as a whole. One of these factors, and the one we'll talk about here, is the use made of our stations in the event of a major disaster. Amateur radio has furnished the principal, and on several occasions, the only means of outside communication in over one hundred emergencies. All amateurs are proud of this record of public service. So much for what has already happened. The purpose of this article is to show what is being done in one locality, in preparation for the rendition of public service should a major disaster occur.

On several occasions in the past few years, hurricanes, floods and earthquakes have given the amateur an opportunity to more than justify his existence. The history of these events will show without doubt that the amateurs who gave the best service were those who were the best prepared. Realizing this, about a year ago several amateurs in the San Francisco Bay Area banded together for the purpose of establishing an organization that could function as a unit in the event of a major disaster. The Society of Amateur Radio Operators (S.A.R.O.) was formed, a constitution adopted, officers elected and a general plan of action laid out.

A study of the possibilities of the 56-Mc. band for emergency purposes was carried on. Field tests were held on week-ends and holidays by the various members of the Society. Complete coverage tests were made in San Francisco and the East Bay cities. Some of the best locations on both sides of the Bay were chosen for the main control stations and excellent communication channels were obtained between these selected

*Secretary, The Society of Amateur Radio Operators, 3044½ Telegraph Avenue, Berkeley, Calif.

sites. But the old bugaboos of the ultra-highs came into the picture when contacts with the mobile units were tried. Shadow effects, transceiver QRM and general instability of the signals made it obvious that some other solution to the problem must be sought, pending further improvement of 56-Mc. technique.

The problem was discussed in a meeting, at which a general list of requirements was set down

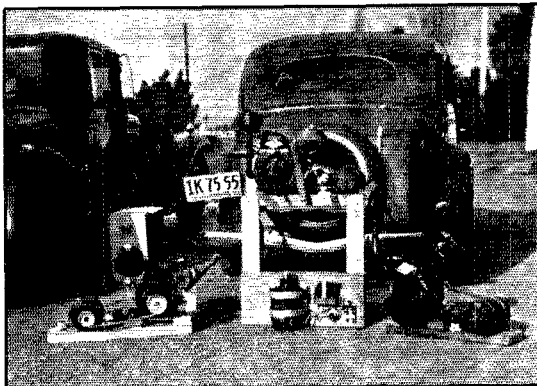

SOME OF THE EMERGENCY 110-VOLT A.C. POWER UNITS

The units on the ground, at left and right, are ½ H.P. types. A 1-H.P. unit is mounted on the rear of the car. The unit shown tilted up, in the center, driven from a pulley on the hub of the car's rear wheel. The jack that holds the wheel off the ground also holds down the generator unit.

as an objective to work toward.

1. Stable transmitter frequencies (crystal control).
2. Selective receivers (superhets preferable).
3. Sufficient power in the carriers to insure reliable communications at all times.
4. Portable power supplies capable of furnishing power for both the transmitter and receiver at the same time, as well as an emergency light or two.

It was felt that while mobile operation had many advantages, portable operation could be made very effective if the equipment was made really portable. We finally decided to try the 1750-kc. band for local contacts, and 3500 and 3900 kc. for contacts with outside stations.

The 1750-kc. band was chosen for the local contacts because it was felt that in an emergency where the local lighting supply had failed, there



ANOTHER OF THE EMERGENCY TRANSMITTER UNITS, MOUNTED ON THE TRUNK RACK OF A CAR, SET UP IN THE FIELD

The superhet receiver is on the folding operating table at the left.

would be little or no QRM to interfere with the network operation.

Several committees were appointed to concentrate their efforts on the various phases of the work.

1. A crystal committee obtained the necessary quartz and set about the job of slicing, grinding and finally "spotting" AT-cut crystals for each member of the organization.

2. A technical committee was appointed to the task of investigating the various transmitter and receiver designs, and drawing up a set of specifications to be followed in general by the members in building portable equipment. A number of the transmitters in use at present has been built along the lines set down by this committee. They have proved very satisfactory in use.

3. One of the members reported to the Society the existence of published descriptions of the conversion of a 12-volt automobile starter-generator into a 110-volt 60-cycle generator with a capacity of several hundred watts. Another member offered to investigate this possibility and attempt one of the conversions. The story of this development is given later on in this article.

All of these things took time, but the start had been made.

The crystal committee finally distributed a few "rocks" to those members who were prepared to get on the air. The first network stations

were home stations operating on 3500 kc. c.w. Each week a few new stations reported at the roll call, and the others were busy getting equipment together in shape to work portable.

Summer time provided an opportunity to try out the network with several of the members who had taken their equipment with them on vacations. One of these stations maintained nightly schedules with the net, from a distance of about 400 miles. Another, using emergency power equipment, put in an S9 signal from his location in the mountains 200 miles away.

About this time it was found that the crystal frequency of 1900 kc., which had been selected as the network frequency, put the 3800-kc. harmonic used for c.w. directly on the Central California Traffic Net. Since we were the newcomers, we volunteered to move our frequency to a little higher spot. The emergency net frequency is now 1907 kc. We have had several individual cases of interference since the change, but by offering to supply a new crystal at a lower frequency or move the one in use to a higher spot, we have practically solved the interference problem. We have had excellent cooperation in this effort by the other amateurs on the band.

ANTENNA SYSTEMS

The rewinding of the generators proved a great success, so several of them were rushed to completion. Several portable stations were also completed about this time. Thus far nothing had been done about antennas, so it was decided that we hold a field day for the purpose of determining the best type antenna to use for our portable work. All types of sky-wires and coupling devices were tried. The location selected for these tests

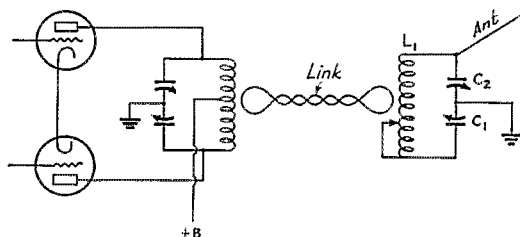

FIG. 1—THE LINK-COUPLED ANTENNA NETWORK WHICH PROVED MOST ADAPTABLE

was a flat piece of land with no close obstructions. Three receiving sets at three widely separated locations were used as signal strength measuring points. The closest of these was about 5 miles and the farthest around 40 miles. These tests proved both interesting and instructive.

The pi-section antenna matching filter is without doubt the answer to the coupling problem. It gave the best results of any of the coupling devices used. One variation of the filter was tried, however, with very gratifying results when coup-

ling to the plate tank of a push-pull stage. As diagrammed in Fig. 1, this variation consists of a link between the tank coil and the network coil, L_1 , no other changes being made. When this circuit is tuned to resonance and the proper loading arrived at, a neon bulb will show a cold spot at some place on the coil L_1 . The link from the transmitter should be moved to this spot. The loading can be easily adjusted by varying the number of turns on each end of the link as well as the condensers and taps in the filter.

Antennas as short as ten feet can be matched with these units provided sufficient capacity is available in the condensers C_1 and C_2 , and provided there are enough turns on the matching coil. The experience so far has shown that if 250- to 350- μ fd. condensers are used with a coil of between 40- and 50-microhenry inductance, most any antenna can be made "hot."

The half-wave horizontal antenna gave the best results on the day of the field tests. This was not surprising; in fact it was the thing we expected. The difficulty of keeping 265 feet of wire available, and the inability to find always the required amount of space in which to string up such a length of wire, ruled it out for our purpose. We desired to use an antenna that could be thrown up in a jiffy and at the same time be capable of supplying enough radiation to do the job. A length of 30 to 100 feet seemed to be sufficient for use with any of the transmitters with the power output of a pair of 10's. The smaller powered transmitters fare better with a longer antenna.

The first public demonstration of the S.A.R.O. 1.75-Mc. 'phone network took place on Decem-

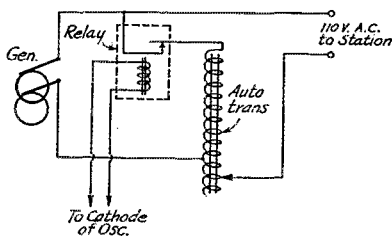

FIG. 2—AUTO-TRANSFORMER ARRANGEMENT FOR IMPROVING THE A.C. VOLTAGE REGULATION

ber 6th, when the Society set up and operated a six-station network as a part of a drill held by the Oakland Red Cross Chapter. On this day, the S.A.R.O. stations worked in conjunction with the Naval Reserve and the fixed and mobile 5-meter stations of the Oakland Radio Club. The results of this demonstration were very gratifying and clearly indicated the desirability of the higher powered emergency equipment.

TRANSMITTERS

There is very little new as far as the circuits of the transmitters are concerned. Most of them have appeared in the regular issues of *QST* and the A.R.R.L. *Handbook*. The main effort of the technical committees' work was to get the equipment required in as small a space as possible and arranged to work with a minimum amount of external wiring. Plugs and jacks are ever so much quicker to use than binding posts, and the cords can be rolled up and put in the transmitter case when not in use.



ONE OF THE EMERGENCY STATIONS SET UP IN A TENT

The transmitter is of the 6L6-p.p. 10 type with 46 modulators. Its case is 14 by 18 by 9 inches.

Dials at the bottom are 6L6 oscillator and push-pull 10 tuning controls. The antenna tuning controls are at the top. The receiver at the left is a standard 10-tube superhet.

The most popular of the transmitters is the "old reliable" push-pull 10's modulated by a pair of 46's in Class-B. These transmitters vary only in the type of driver stages used. The first built used either a 47 or 59 Crystal oscillator, followed by either a 46 or 59 buffer-doubler. The more recently built rigs have a single 6L6 crystal oscillator loosely coupled to the push-pull 10's. The elimination of the buffer stage made it possible to decrease the size of the transmitter materially without sacrificing any power output. No noticeable frequency modulation has been detected on the transmitters using this circuit. These transmitters operate with 500 volts on the plates and 125 to 150 ma. plate current.

Another type of transmitter that has worked well is the 6A6 and 802, or RK25 combination with suppressor-grid modulation. Three of these transmitters are now in use at network stations.

One transmitter, consisting of a 47 crystal oscillator, 10 buffer and a 203A final, is grid modulated with a 56 and 45 in the speech portion. The 1500 volts, stepped up from the 110 a.c. supplied by the emergency power generator unit and used to supply the plate power for this transmitter, seems a far cry from the low voltages usually employed for portable work.

One of the members of the Society undertook to make low-loss coils for the network transmitters. These coils compare favorably with the regularly manufactured ones, and are supplied to members at cost. Individual specifications as to turns and spacing are used and special antenna

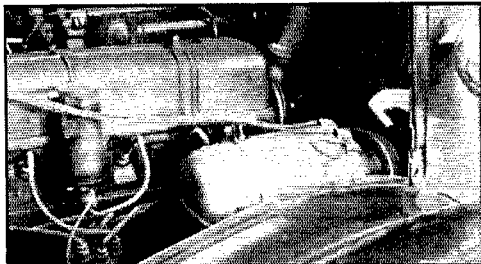

A CONVERTED GENERATOR UNIT MOUNTED TO DRIVE FROM THE CRANK SHAFT OF THE AUTOMOBILE ENGINE

coupler coils designed to work with the short antennas, have been made available.

EMERGENCY GENERATOR UNITS

The requirements for emergency power supplies are definite and numerous. Reliability and universal adaptation are of primary importance. Portability is another requirement. Some of the units must be capable of being transported by foot to locations inaccessible to automobiles, in order to be used at a semi-fixed location. Others are built into automobiles so that they may be transported quickly to remote points which are still accessible to auto travel.

The requirement of universal adaptability is best met, we believe, by the 110-volt a.c. type of supply. It means that should anything happen so that the portable transmitters and receivers are put out of commission, any standard receiver or transmitter that is available can be used. The S.A.R.O. has several of these a.c. supplies at present, some of them driven by small gasoline engines and some from the fan belts of cars.



S.A.R.O. GANG AND EQUIPMENT USED IN THE RED CROSS DRILL
One of the telescoping antenna poles stands left of center.

Two types of generators have been used—self-excited and separately-excited. All have been rewound on frames built by the Northeast Electric Company, and originally used as starter-generators on the old four-cylinder Dodge cars. A number of such frames has been purchased from various junk dealers and auto wreckers in the Bay district for as little as \$1.50 each.

The details of rewinding, fitting of the a.c. slip rings, etc., were found in a booklet entitled, "Autopower," by S. W. Duncan, 408 S. Hoyne Avenue, Chicago, Ill. This book will be found of great value to any one attempting the job of rewinding. It has been found, however, that for our type of work, where the loads are heavy and fairly constant, certain slight modifications of the winding design were desirable. The d.c. exciting winding on the armature originally consisted of 5 turns per coil of No. 20 enamel and single-cotton insulated wire. This winding now is being made with only 2 turns per coil. The field windings, which previously consisted of 200 turns per coil of No. 17 enamel and single-cotton insulated wire, are now being wound with No. 15 plain enameled wire.

The field current with these modifications runs in the neighborhood of 2 amperes. The machines run much cooler than they did before the modifications were made and the a.c. output voltage is just the same. These generators, after several hours of continuous running under load, are just warm to the touch. The cost of materials with the usual amateur discounts is about \$4.00, and this added to the junk cost of the frame makes a total of \$5.50 exclusive of the labor.

At the present time, all of the generators driven by separate gasoline engines are self-excited, thus eliminating the necessity of carrying a storage battery as part of the station equipment. The generators which are driven from the auto fan belts are all excited from the car battery, and the engine speed and variable excitation control are used to adjust the a.c. voltage to the proper value. The pulley ratios are computed so that the engine speed while driving the generators is slightly faster than the low idling speed of the motor. It has been found that an engine speed equivalent to a car speed of about 25 miles an hour gives very good results. Both types of generators turn at approximately 2000 r.p.m. This speed with the four-pole generator insures slightly higher than the usual 60-cycle frequency.

Good voltage regula-
(Continued on page 78)

Medium-Power Pentode Transmitter for Smooth Break-In Operation

Improved Suppressor Keying in a Shielded Tri-tet Oscillator—Pentode Amplifier with Suppressor Modulation for 'Phone

By Byron Goodman,* W1JPE

THIS transmitter started out to be a simple c.w. transmitter, capable of working near-perfect break-in on three bands; but like Topsy, it just grew, until it ended up as a medium-powered c.w. transmitter, a low-powered 'phone, and a proving ground for pentodes.

But let's start from the beginning. One of the logical output tubes for a 100-watt transmitter would be the RK-20 or 804 type, because the low excitation requirements permit the use of but one other stage, the crystal oscillator. To permit break-in operation, the suppressor-grid of the oscillator would be keyed,¹ and the oscillator stage would be shielded to reduce the radiation from the continuously-running crystal to a minimum. An 89 gives sufficient excitation for an RK-20 or 804, so when the oscillator was first built it used an 89. However, tests showed that the 220 volts available for suppressor bias was not sufficient to cut off the oscillator output completely. This leads us to conclude, rather obviously, that if you wish to utilize the suppressor grid for much in a pentode type tube, a tube should be used in which some attention has been given to the control characteristics of the suppressor grid. Apparently receiver-type tubes are not satisfactory for 100% suppressor-grid modulation and transmitting-type pentodes should be used.

An RK25 (an 802 could be used with no circuit changes) was substituted for the 89. Now perfect cut-off of output was obtained, and break-in could be employed up to within about 2000 cycles of the working frequency. Obviously this type of operation is not suitable for spot-frequency net operation, but proves quite satisfactory for general use. The keying is clickless, and has no tendency to chirp, as is the case with many keyed oscillators. This results, of course, from the

fact that the crystal in the Tri-tet oscillator is running continuously.

Since the pentode is easy to modulate through the suppressor grid, a modulator unit was added; most everyone likes to take a fling at 'phone once in a while, and the additional equipment represented no large investment.

The transmitter is built in two units, the upper portion carrying the radio-frequency section and the bottom half the low-voltage plate supply, bias supply, and the modulator unit. The high-voltage

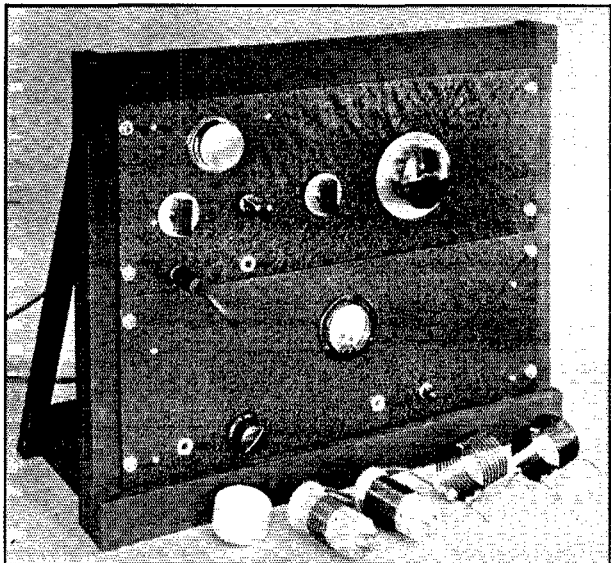

FRONT VIEW OF THE TRANSMITTER

The crystal is plugged in from the front of the panel, and is shielded in operation by the can shown next to the extra coils. The jack on the left of the bottom panel is for the microphone plug, the one on the right takes the plug for the key. The small rotary switch at the bottom is for changing from c.w. to 'phone.

plate supply was already available, so it was not included in the transmitter, although it could easily be made an integral part by adding it below the low-power supply. Rack and panel type construction is used, employing 8 $\frac{3}{4}$ -inch panels of crackle-finished Masonite. The sub-panels are also made of crackle-finished Masonite, fastened

* Assistant Secretary, A.R.R.L.

¹ "Suppressor-Grid Keying of Oscillator Tube for Break-In Operation." "Hints and Kinks," *QST*, Nov., 1936.

securely to the front panels by brackets in the case of the power supply unit, and to the oscillator shield compartment and tuning condensers in the case of the radio-frequency section.

The construction of the transmitter is perfectly straightforward in every respect. The only

inches square. A shield to fit over the crystal holder was improvised from an old i.f. transformer shield can cut down to cover the usual crystal holder. If some form of crystal holder was used that included its own shield, this precaution would not be necessary. The care taken in shielding and

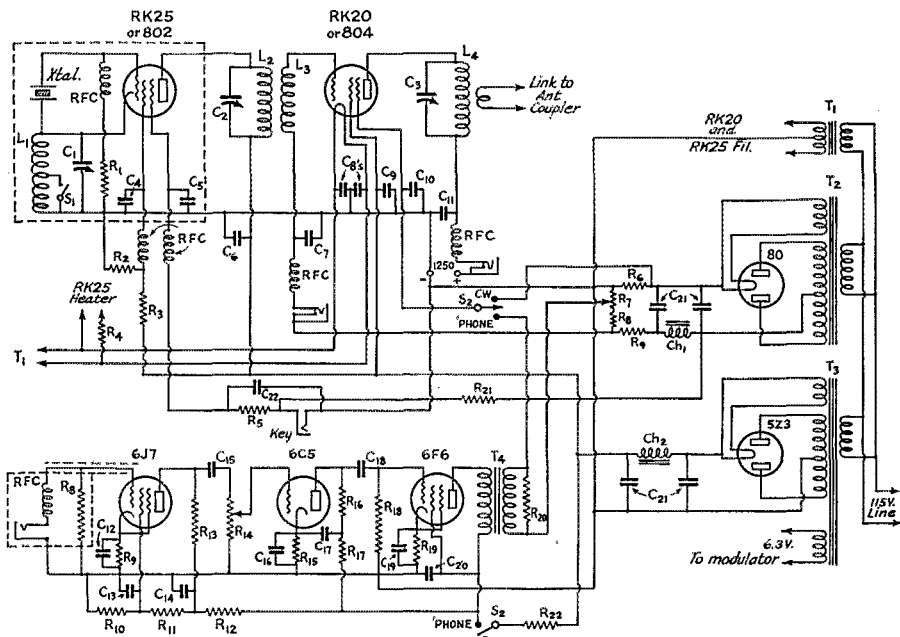

FIG. 1—CIRCUIT OF THE R.F. AND AUDIO SECTIONS, INCLUDING THE LOW-POWER PLATE AND BIAS SUPPLIES

- | | | | | | | | | | | | | | | | | | | | | | | | | | | | | | | | | | | | | | | | | | |
|---|--|------------------------------------|----------------------------------|-------------------------------|--|--|---|---|--|--|---|--|--|--|---|--|---|---|---|---------------------------------|-----------------------|--|------------------------|---------------------|------------------------------------|---------------------|--------------------------|------------------------|-----------------------------------|--------------------------------|---------------------|------------------------|----------------------------------|---|--|---|--|---|--|----------------------------|--------------------------------------|
| L1—19 turns No. 18 d.c.c., 1 inch diam., 1 inch long. Tapped at center. | L2—All wound on 1½ inch diam. forms with No. 18 enameled wire: | 3.5 Mc.: 28 turns, 2½ inches long. | 7 Mc.: 18 turns, 1¾ inches long. | 14 Mc.: 7 turns, 1 inch long. | L3—Interwoven between turns of L2 with No. 30 d.c.c. in each case. | L4—3.5 Mc.: 21 turns No. 16 enam., 2¼ inches diam., 2 inches long. | 7 Mc.: 14 turns No. 14 enam., 2 inches diam., 1¾ inches long. | 14 Mc.: 8 turns No. 12 enam., 2 inches diam., 1¾ inches long. | C1—325- μ fd. midjet variable (Hammarlund MC-325-M). | C2—100- μ fd. midjet variable (National ST-100). | C3—100- μ fd. transmitting variable (Cardwell MT-105-GS). | C4, C5, C7—0.01- μ fd. 400-volt paper. | C6, C8, C9, C10—0.002- μ fd., mica receiving type. | C11—0.002- μ fd. mica, 5000-volt rating. | C12, C16, C19—10- μ fd. 25-volt electrolytic. | C13, C15, C18—0.1- μ fd. 400-volt paper. | C14—2- μ fd. 200-volt electrolytic. | C17, C20, C22—0.25- μ fd. 400-volt paper. | C21—Double 8- μ fd. electrolytic, 450-volt working. | R1, R12, R16—50,000-ohm 1-watt. | R2—25,000-ohm 1-watt. | R3, R5, R20—10,000-ohm 10-watt wire-wound. | R4—1.5-ohm wire-wound. | R6—1500-ohm 2-watt. | R7—5000-ohm adjustable wire-wound. | R8—5-megohm ¼-watt. | R9, R15—3500-ohm 1-watt. | R10—50,000-ohm ½-watt. | R11, R13, R18—0.25-megohm ½-watt. | R14—0.5-megohm volume control. | R19—450-ohm 1-watt. | R21—50,000-ohm 2-watt. | R22—1500-ohm 10-watt wire-wound. | T1—7½-volt filament transformer (UTC LM-2). | T2—560-volt c.t., 30-ma. transformer (Thorndarson T-6049). | T3—745-volt c.t., 145-ma. (Thorndarson T-7062). | T4—Grid modulation transformer (Thorndarson T-6773). | Ch1—22-henry 35-ma. choke (Thorndarson T-1892). | Ch2—12-henry 130-ma. choke (Thorndarson T-1700-B). | S1—S.p.s.t. rotary switch. | S2—D.p.d.t. rotary or toggle switch. |
|---|--|------------------------------------|----------------------------------|-------------------------------|--|--|---|---|--|--|---|--|--|--|---|--|---|---|---|---------------------------------|-----------------------|--|------------------------|---------------------|------------------------------------|---------------------|--------------------------|------------------------|-----------------------------------|--------------------------------|---------------------|------------------------|----------------------------------|---|--|---|--|---|--|----------------------------|--------------------------------------|

deviation from normal practice is the shielded Tri-tet oscillator unit. The oscillator tube, cathode coil and condenser, and all oscillator by-pass condensers (except the plate blocking condenser C₆) are mounted inside the shield can. The shield can, made from sheet aluminum and supported in the corners by ¼-inch brass rod, measures 5

filtering the oscillator supply circuits will determine the extent to which reception will be bothered by the continuously-running crystal. In any event, it should not amount to more than an S9 signal with the receiver at normal gain. The cathode coil is tapped, the tap being brought to the switch S₁. Thus for operation with a 7-Mc.

crystal, it is only necessary to plug in the new crystal, turn the switch so that part of the cathode coil is shorted out, and retune.

The plate circuit of the oscillator is coupled to the grid of the amplifier by means of a coil interwoven between the turns of the plate coil. This type of coupling eliminates any possibility of loss of excitation because of a poor choke (such as would be used if capacity-coupling was employed), and does away with the second tuned circuit necessary when link coupled is used. It is quite satisfactory for coupling pentodes.

The pentode amplifier tube is mounted horizontally, supported at one end by the tube socket and at the other by the plate lead made of heavy wire. A shield partition is used to eliminate possibility of self-oscillation, and in many cases might not be necessary, because of the isolation of the circuits. However, it is well to include it, especially if higher-frequency operation is contemplated.

The plate tank circuit of the amplifier is conventional. The tuning condenser helps support the front panel. The plate coils are plugged into two jack-top stand-off insulators. A link for coupling to a separate antenna is shown in Fig. 1, but this will be determined by the type of antenna system used. This particular rig, when used on 3.5-Mc., uses a single long wire, which is coupled through a variable condenser to the plate end of the coil. On 7- and 14-Mc. link coupling to an antenna tuning unit is used.

The power supplies and modulator unit are strictly straightforward. A piece of aluminum is secured to the Masonite base under the modulator unit to provide a good ground. The microphone jack is shielded by means of a portion of an old i.f. transformer shield can to prevent stray pick-up; and for the same reason the grid lead to the first amplifier tube is run through shielded cable. The speech amplifier is so designed as to have adequate amplification for communication type of crystal microphones and in most cases the gain control will not have to be opened very far.

One of the power supplies furnishes 350 volts for the oscillator screen and plate, amplifier screen, and, through a dropping resistor, plate voltage for the modulator unit. The other pack gives a little over 200 volts, supplying bias to the final amplifier and keying bias for the oscillator. The

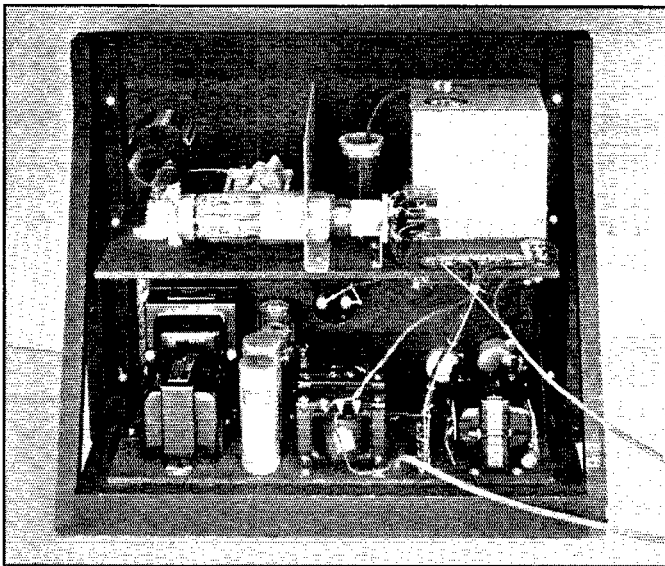

A REAR VIEW OF THE TRANSMITTER, SHOWING THE ARRANGEMENT OF PARTS

The modulation transformer is shown at the extreme right of the lower shelf.

keying bias for the oscillator is taken off ahead of the filter choke, because it was found that sometimes there would be too much keying lag, as the result of the action of the filter choke preventing the rapid building up of the voltage when the key is opened. An 80 tube is used as the rectifier in the bias pack and a 5Z3 takes care of the greater demands of the plate supply pack. Filament voltages for the radio-frequency end of the set are supplied by a single 7.5-volt transformer, the voltage being dropped to 6.3 for the oscillator through a 1.5-ohm resistor.

When the set has been built and the wiring thoroughly checked, the voltages should be tested. The voltage on the oscillator plate and final amplifier screen grid should be between 300 and 400 volts, and when the modulator is switched on, the voltage on the plate of the 6F6 modulator tube should be approximately 250.

No provision has been made for metering the plate circuit of the oscillator tube, grid metering the following stage being considered sufficient. The crystal oscillator stage is tuned exactly as any Tri-tet oscillator is tuned, except that when working on the fundamental frequency of the crystal the cathode coil is not shorted out, as is usually done. Instead, the cathode condenser is set at almost minimum capacity. A little experimenting will give the best cathode and condenser setting. The keying should be clean and complete. A neon bulb touched to the plate of the oscillator tube should show no glow with the key up and, with the key up, the signal in the receiver should

(Continued on page 106)

What the League Is Doing

League Activities, Washington Notes, Board Actions—For Your Information

Election Results

Two new directors and five new alternate directors were elected by the members of eight A.R.R.L. divisions in the 1936 elections, while six of the present directors and three of the present alternates were returned to office for two additional years. The new directors are R. H. G. Mathews, W9ZN, who succeeds Edward A. Roberts, W8HC, in the Central Division; and Edward C. Stockman, W9ESA, of Denver, who becomes the Rocky Mountain's new director in the place of Russell J. Andrews, W9AAB. The story by divisions is given below.

CENTRAL DIVISION

In A.R.R.L.'s largest division, the Central, three candidates battled it out with some spirited campaigning. The result is a new director, by an overwhelming vote replacing Mr. Roberts, who has served the division for the past two years, but who did not campaign for reelection. The figures:

R. H. G. Mathews, W9ZN	1179
J. B. Wathen, III, W9BAZ	360
Edward A. Roberts, W8HC	157

Since Alternate Director Wathen was running for director, there was but one nomination for alternate and he was declared elected by the membership without balloting: Adam F. Moranty, W8CZT, of Cleveland.

The new director, although not old, has been in amateur radio for twenty-seven years. Ralph H. G. Mathews is a former director and vice-president of the League and was for many years the Central's Division Manager, a sort of super-S.C.M. of the earlier days of our operating department. He is very active in N.C.R. work, being a Lieutenant-Commander in the U.S.N.R. and executive officer of the Ninth Naval District Communication Reserve. He was one of the organizers and the first chief engineer of Zenith Radio Company, shortly after the war. His present business association is as a member of the firm of Ford, Browne and Mathews, advertising agents. His old calls, 9IK and 9ZN, were famous in the earlier days. He returns to our Board now after an absence of about sixteen years.

HUDSON DIVISION

The Hudson reelected both its director, Kenneth T. Hill, and his alternate, Robert M. Morris, each winning handily over a single contestant:

For Director:	
Kenneth T. Hill, W2AHC	478
Charles J. Hammersen, W2FOP	293

For Alternate:

Robert M. Morris, W2LV	584
Herbert C. Florance, W2IXQ	183

NEW ENGLAND DIVISION

The New England returned Mr. Noble, its director since August when he was elected to fill the remainder of Mr. Bailey's term. His two opponents had also run against him in August. The result:

Percy C. Noble, W1BYR	323
Joseph A. Mullen, W1ASI	236
Raymond W. Woodward, W1EAO	194

Frederick A. Ells, Jr., W1CTI, becomes the new alternate director without balloting, having been the only candidate. The office had been vacant since August, when Mr. Mullen resigned to run for director.

NORTHWESTERN DIVISION

The Northwestern returned both its director and his alternate, the latter without competition. Mr. Gibbons won handily as director, while A. L. Smith, W7CCR, was the only candidate for alternate and succeeds himself. The balloting:

Ralph J. Gibbons, W7KV	210
Wallace N. Wintler, W7KL	163
John P. Gruble, W7RT	81

ROANOKE DIVISION

The Roanoke's story is the same as the Northwestern's. Mr. Caveness was returned over his opponent, while J. Frank Key, W3ZA, was declared reelected as alternate, without competition. The story:

Hugh L. Caveness, W4DW	174
William H. Riheladaffer, W8KKG	76

ROCKY MOUNTAIN DIVISION

The Rocky Mountain did no balloting, naming but a single candidate for each office. Mr. Andrews, the incumbent for long years since Paul Segal's Colorado days, was not a candidate for reelection. The new director is Edward C. Stockman, W9ESA, also of Denver. The alternate directorship has been vacant since W6BTX moved from the division. The new alternate is Eddie L. Heyer, W9GBQ.

Mr. Stockman is not now actively engaged in business, but was previously in the automobile business in Denver. He is one of the real old-timers, having been in radio since 1909, and served as S.C.M. for Colorado during 1930-1932.

SOUTHWESTERN DIVISION

The Southwestern would have none but its present director, so Charles E. Blalack, W6GG, the only candidate, was returned for two additional years without membership balloting. There was competition for the post of alternate, however, resulting in the selection of John E. Bickel, vice-chairman of the Federation of Radio Clubs of the Southwest.

The tally:

John E. Bickel, W6RKY.....	130
Perry F. Backus, W6HUX.....	106

WEST GULF DIVISION

The West Gulf clung to its present director, Wayland M. Groves, over two other candidates, but selected a new alternate, William B. Hollis, the recent alternate having been one of the unsuccessful candidates for director. The count showed:

For Director:	
Wayland M. Groves, W5NW.....	220
Frank M. Corlett, W5ZC.....	89
David H. Calk, W5BHO.....	49
For Alternate:	
William B. Hollis, W5FDR.....	182
J. Pronto Poston, W5AJ.....	177

— . . . —

Since May of 1934, new members of the League may vote in A.R.R.L. elections only if they are at the time licensed amateurs. Unlicensed amateurs who were members prior to that date may vote, but only if their membership has been continuous. Lapses in membership and the dropping out of those who are not active in the game have caused a steady reduction in the percentage of the voting that is done by those who are not licensed amateurs. The average for the seven divisions in which balloting took place this year was 6.21% and in most divisions was well below that figure, comparing with about 8% in the previous year's elections and over 18% the year before that. Believing these figures interesting, we cite them:

<i>Division</i>	<i>Licensed Amateur</i>	<i>Relying Upon Prior Membership</i>
Central.....	94.23%	5.77%
Hudson.....	91.19	8.81
New England.....	93.54	6.46
Northwestern.....	95.16	4.84
Roanoke.....	95.60	4.40
Southwestern.....	94.50	5.50
West Gulf.....	94.42	5.58
Average.....	93.79%	6.21%

Perpetual Survey

In editing *QST* it is our constant effort to make it most useful to the largest number of its readers. To do this well, we must have the criticisms and suggestions of our readers and certain statistical information. We have, therefore, devised a questionnaire which is sent to each new member and to every old member as he annually renews his

membership. Its prime purpose is to guide us in making *QST* exactly what you want it to be. Its aim is to produce a constant flow of opinions and statistics that can be analyzed to show continuously just what members need and want, and what they don't like and don't want, within those spheres of activity that are administered by the headquarters.

The data, in addition to applying to *QST*, of course also will be particularly helpful in the activities of the Communications Department and will also be of assistance to other headquarters departments. They are extremely important to us. We most earnestly ask our members, then, to fill out the questionnaire when it is received and return it promptly to us in the envelope that will be enclosed. Some of the questions may not seem to you to be pertinent, but we assure you that the answers to each one will help us to analyze problems and serve our members better. We express our thanks in advance for your cooperation.

Cairo

The Department of State has rejected our appeal from the decision of the Federal Communications Commission which had denied our plea for the inclusion of a proposal for more amateur frequencies in the representations to be made by the United States Government in preparation for the Cairo Conference. The formal proposals of the United States have now gone forward to the Berne Bureau for international distribution, proposing no changes in the amateur bands. The Department of State advises the League that, after reexamination, the administration's views remain the same and that it is accordingly impracticable to accede to our wishes. This makes three appeals that we have taken to successively higher authorities, and we seem now to have exhausted the possibilities. The reports are much the same everywhere. The request of Canadian amateurs has been similarly rejected. The Radio Society of Great Britain does not seem to expect favorable action. Amateur societies in some of the smaller nations continue hopeful that they will receive favorable consideration, but it does not seem that we shall be able to induce any administration that really "drags water" to put forward or to back a proposal for an amateur increase.

Strays

Another scheme for making a bug stay put: W7EQC glues small pieces of coarse sandpaper on each of the feet. These stick to the large blotter which covers the operating table and the bug does not walk under any keying speed.

W9AXL says that W9HHT tunes his transmitter by holding his tongue to the antenna lead!

About This Harmonic Radiation Problem

Practical Measurement and Suppression of R.F. Harmonics—Results with Pi-Network and Linked-Tuner Antenna Couplings

By R. W. Woodward,* WIEAO

HOW many of you have received an Official Observer's notification card informing you of a strong harmonic radiation from your transmitter? How many have done anything about it or even replied to the O.O. who sent the notice? Well, a short time ago the writer sent out 100 such notices, 60 to 'phone stations and 40 to c.w. operators, during the course of two or three days—and kept a record of the replies received. Two of the 'phone stations, or 3%, replied, indicating they were taking corrective steps; 22, or 55%, of the c.w. stations likewise replied. Most of the c.w. fellows were newcomers on the air and eager to abide by the regulations; the 'phones were mostly of longer experience and as a lot apparently indifferent to the situation. And one of the replies was, "Wish you had told me of this sooner—received a notice from Grand Island in the same mail."

Harmonic radiation from amateur transmitters really is a serious matter and its interference to other radio services but invites restrictions on our operation. It would be a revelation to many operators if they would listen on the second, third or fourth multiples of our busiest bands. For instance, from 7800 to 8000 kc. the QRM from harmonics is often as bad as on the 75-meter 'phone band itself.

Replies received from stations reported having harmonics over a period of two years or so show one fact to stand out as significant. Approximately 70% of these stations were using a pi-network (Collins) for coupling the transmitter to the antenna and believed themselves secure in view of the claims for this network to suppress harmonics. This system was first suggested for the purpose by W. L. Everitt¹ and later adapted to amateur needs by A. A. Collins.² It is intended to provide an impedance match between the final amplifier and the antenna system, and also to vary the coupling and power output. The inductances and capacities are arranged to form a pi-network which is supposed to be a low-pass filter which should attenuate harmonics—when properly applied.

* O.O., O.P.S., 849 Farmington Ave., West Hartford, Conn.

¹ Everitt, W. L., "Output Networks for Radio Frequency Power Amplifiers," *Proc. I.R.E.*, May, 1931, p. 725.

² Collins, A. A., "A Universal Antenna Coupling System for Modern Transmitters," *QST*, Feb. 1934, p. 15.

But apparently theory and practice are not always in harmony, either through mis-application or maladjustment, and it was thought desirable to make a practical study of the pi-network type coupler from a harmonic standpoint and also to reach general conclusions for reducing harmonics in amateur transmitters.

How much harmonic radiation may be permitted? From the very nature of vacuum tube amplification, particularly in power r.f. circuits, some harmonics are generated. The F.C.C. regulations

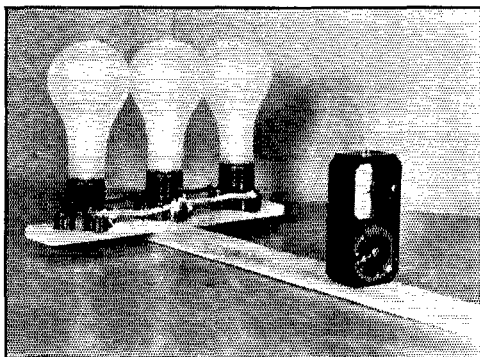

DUMMY ANTENNA LOAD AND WESTON EXPOSURE METER USED IN MEASURING TRANSMITTER POWER CIRCUIT

are not quantitatively specific as to the permissible limit. Rule 381 states that spurious radiations, which include harmonics, "shall be reduced or eliminated in accordance with good engineering practice and shall not be of sufficient intensity to cause interference—outside the frequency band of emission . . ." Because of the high frequencies at which harmonics of amateur emissions occur, skip effect may propagate even a very small radiation for considerable distance. Preliminary experience indicated that a second harmonic output of less than one watt falling in the 7-Mc. band could be copied at a distance of 150 miles or more.

Several methods are available for measuring harmonic content of transmitting output, most of which are complicated and beyond the scope of ordinary amateur equipment. Measurement of received field strength at a remote location, while permissible at low (broadcast) frequencies, may produce erroneous results at high frequencies

because of constantly changing skip conditions. Measurements in the r.f. transmission line to the antenna present the possibility of upsetting the conditions being investigated. The method adopted by the writer, while making certain assumptions not entirely valid, gives results

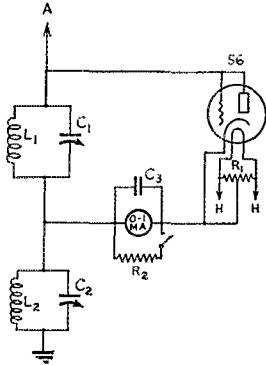

FIG. 1—SCHEMATIC CIRCUIT OF THE SIMPLE FIELD-STRENGTH METER USED IN DETERMINING HARMONIC RADIATION

- L1, C1—Coil and condenser to tune to frequency (fundamental or harmonic) being measured. An absorption wave meter is convenient.
- L2, C2—Coil and condenser tuned to fundamental output frequency. Shorted when measuring fundamental output.
- C3—0.01- μ fd. by-pass condenser.
- R1—20-ohm filament center-tap resistor.
- R2—Shunt to give 10-ma. meter range.
- A—6-inch or 4-foot pick-up antenna. (See text.)

which are reasonably accurate and most certainly significant. Since it can be carried out with a reasonable amount of effort by any operator it will be described in more or less detail.

CALIBRATION PROCEDURE

Briefly, the method was to set up a field-strength meter directly under the antenna but far enough away from the transmitter so that the meter is not directly affected by radiation from the exciter unit. At the writer's location the transmitter is in the rear of the house. The 122-foot flat-top of the antenna system passes directly over the roof, so that by setting the field strength meter near the front of the house, under the center of the antenna, the above condition was met. A location nearer the far end of the antenna might have been preferable, since at the center the fundamental field strength would be

TABLE I

Condenser movement from resonance for minimum harmonic. Fundamental 3520 kc.

Harmonic	Frequency	C1 Change
2nd	7040 kc.	+
3rd	10,560 "	+
4th	14,080 "	0
5th	17,600 "	+
6th	21,120 "	+ or -
7th	24,640 "	0
8th	28,160 "	+
9th	31,680 "	-

maximum and, because of the pattern of the antenna, the strength on even harmonic frequencies a minimum.

In order to calibrate the field-strength meter the output of the transmitter was determined for various inputs through a lamp-load dummy antenna which, in turn, was calibrated through commercial frequency electrical instruments, the brilliancy of the lamps being measured by a Weston photographic exposure meter. Ham radio and amateur photography seem to go hand in hand and if you do not already possess an exposure meter (or Weston photonic cell) no doubt a nearby ham has one that can be borrowed.

The dummy antenna is set up as shown in the accompanying photograph. It is important that the exposure meter be kept in exactly the same position when once calibrated. In this case it was about 10 inches from the center lamp socket. With these 100-watt lamps in the sockets this gives nearly full-scale deflection at rated lamp voltage.

The lamps are connected to a regular 110-volt power supply with a variable resistor or Variac for controlling the input which is measured by a watt-meter. Simultaneous readings of electrical

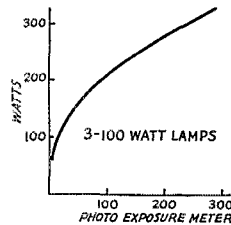
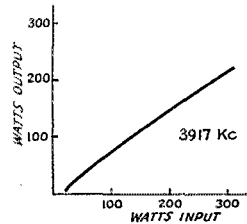

FIG. 2—TYPICAL DUMMY ANTENNA CALIBRATION CURVE

power input and exposure meter are taken down to about one-half the rated voltage of the lamps, beyond which the sensitivity of the exposure meter is too low. In like manner two 100-watt lamps, one 100-watt, a 50, 25 and 15 are calibrated, giving a continuous range from over 300 watts down to about 4 watts. Of course, more or

FIG. 3—TRANSMITTER INPUT-OUTPUT CURVE MADE USING DUMMY ANTENNA



larger lamps should be included for higher powers. Each lamp should always be used in the same socket and it is well to label them and keep them out of reach so they do not get used for general household purposes.

The dummy antenna is then connected to the transmitter in place of the regular antenna, including any antenna coupling device which is

regularly used so that its losses will not be ignored. Naturally, here, as well as in calibrating the lamps, the exposure meter must be shielded from daylight or any strong illumination. The transmitter is then operated on its fundamental frequency and simultaneous readings are taken on the exposure meter (power output) and power input to the final amplifier, as the input is gradually reduced by varying coupling to the dummy antenna or by adjusting the plate voltage, but keeping excitation to the final at a constant reproducible value as indicated by grid current. Smaller and smaller lamps are used as the power decreases.

The same procedure is now repeated with the transmitter operating on the higher frequency bands so as to obtain data for calibrating the field strength meter at the harmonic frequencies. In these cases particular attention should be directed to operating the transmitter at low power levels.

While making these measurements you will probably have made some interesting observations on transmitter efficiencies. Using a pair of 203A's in push-pull with Class-C operation, a maximum efficiency of 74% was obtained. Under grid modulation conditions this dropped to 35% and for real low-power Class-C operation to around 20%. Different combinations of plate voltage and current to arrive at a given power input show different efficiencies; with this particular transmitter better efficiency was obtained using currents near the rated values rather than high voltage and low current.

The field strength meter can now be set up in its operating location and calibrated. Fig. 1 shows

FIG. 4—FIELD STRENGTH METER CALIBRATION IN TERMS OF TRANSMITTER WATTS OUTPUT AT 3917 KC., 6-INCH PICK-UP ANTENNA

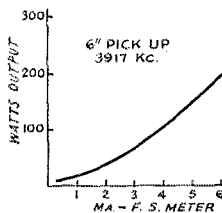

the diagram of connections for this meter. A 56 tube with grid and plate connected together is used as a diode rectifier. L_1 and C_1 are conveniently an absorption type wave-meter which assists in positively identifying the harmonic frequency being measured. The 0-1 milliammeter must be by-passed for r.f. currents. A 10-times shunt is necessary when measuring fundamental output but is disconnected for harmonic measurement. Likewise, when measuring harmonics it is necessary to include the trap circuit L_2C_2 to suppress the fundamental. With L_1C_1 tuned close to but not on a harmonic frequency, L_2C_2 is tuned exactly to the fundamental as indicated by a minimum reading on the milliammeter with the transmitter operating. For high transmitter

power levels a 6-inch vertical rod is used for pick-up; for low power or harmonics a four-foot vertical wire can be used. These two pick-ups and the two meter scales serve for a wide range of field strengths.

The transmitter, connected to regular antenna, is operated at various power levels and the maximum readings on the milliammeter observed as

FIG. 5—FIELD STRENGTH METER CALIBRATION AT 7283 KC., 4-FOOT PICK-UP ANTENNA

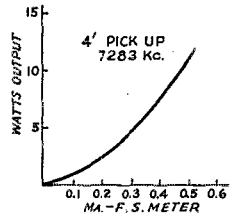

C_1 is tuned through resonance. On the higher frequencies particular attention must be paid to low power levels so as to calibrate the meter adequately at harmonic field strengths. The 56 tube will show a small space current of the order of 0.30 ma. without signal input. This must be subtracted from all readings.

The transmitter must, of course, be operated in exactly the same manner as when the dummy antenna was calibrated. Figs. 2, 3, 4 and 5 show the types of curves that are obtained during the calibration process.

HARMONICS AND COUPLER TUNING

Since preliminary experiments had indicated that improper tuning of the pi-network had a large effect on the transmission of harmonics, a more detailed study of this was made. Fig. 6 shows the constants of the network that was used. The antenna had 45-foot feeders. The first tests were made with the input of the network connected across 13 turns of the total of 24 in the final tank inductance. Each of the L_1 coils had $18\frac{1}{2}$ active turns. Resonance in the network occurred with C_1 at about $150 \mu\text{mfd.}$ after C_2 had been adjusted to give an input of 100 watts. Under the conditions of operation the tube efficiency was only about 50% and the output about 50 watts.

In Fig. 7 are given the final plate current, antenna current and percentage of second harmonic power output for small changes of the setting of C_1 either side of resonance.

The prescribed method of tuning this circuit is to set C_1 for minimum plate current after the tank has been tuned to resonance with the network disconnected. This minimum occurs at a C_1 setting of 33.5 at which point there is 0.2% or 0.1 watt second-harmonic content. On either side of this minimum the plate current rises rapidly, as does the harmonic output, until at settings of 31 and 37 there is 14% output on the harmonic. The antenna current also rises because of the harmonic

(Continued on page 22)

A.R.R.L.'S Ninth International DX Competition

March 6th¹ to 14th, Radiotelegraph Contest—March 20th¹ to 28th,
'Phone DX Contest

All the World with W/VE—Advance Entry Not Required—Swap Number Groups (RST² Report³+Self-Assigned Serial Nr.) in DX QSOs—Operating Time, 90 Hrs. in the Nine Days—Points from DX Contacts to Be Multiplied by Number of W-and-VE Districts Represented or Countries (Prefixes) to Give Total—Gaval Trophy to Winning Club!—Certificates for CW DX Winners—For 'Phone DX Winners in Each Section

By F. E. Handy*

SINCE many amateur stations utilize 'phone as well as telegraph transmitters, it has been decided to provide two separate periods for competitive work by each method of operation this season. Both periods should be at the same time of year with but a brief intermission so as to give both modes of operation the same opportunity at the ultimate in DX that the season affords! The time-tested rules for contest exchanges will be the same for both periods, except that no quota plan will apply in the 'phone period. This can be added in the future if 'phone participants ask for it. Whether or not a two-period DX competition is continued will depend entirely on participation and results submitted in one or both sections of this activity. We expect entries to fall in one period or the other—but any ham can take part in both periods if he likes. Scores are entirely independent, for each period.

Last season's A.R.R.L. DX Contest had by far the widest participation of any DX tests to date. This is indicative of the general satisfaction and enjoyment in the rules for contest exchanges inaugurated at that time. Suggestions for changes have been carefully considered, but few changes are announced since greater general approval was accorded the competition than ever before. We reason that when suggestions for more restrictive quotas closely balance those for less restrictive quotas in numbers that the figure set

last time was just about right, and satisfactory with the majority. And so it goes with other factors. The "quota" of 3-stations-per-country for W/VEs (telegraph period) is designed to give more time to look for new countries and reduce the QRM level so DX work and new countries will be easier to get. Since U.S.A. stations number several to each foreign station, participants at a distance need have no fears in regard to a scarcity of contacts.

To forget 23-, 3.5- and 1.7-Mc. bands will be to give your DX competitor the edge on building up the all-important multiplier. Use all bands that you can! Operating points, personal efficiency, and the "man behind the station" (most of all) count! Wise W/VE hams will avoid use of "CQ DX" like poison. Distant stations will not waste time answering such calls when one call from "outside" will bring hundreds of answers from more efficient operators. All stations should try to work BREAK-IN for real operating efficiency. Hams outside W/VE urge more speed, asking W/VEs to shoot the number along first before anything else. U. S. and Canadian amateurs approve continued use of CQ by all stations in remote localities, but plead that these CQs be made shorter—when a flock of U.S.A.-Canadian stations are so eagerly competing for each one! Everybody agrees that CQ DX is "out" for W/VEs and ought to disqualify 'em. Remotely located participants: Please sign often in CQs or calls. Use QHM, QML, QLM, QMH⁴ as a guide of when or how long to call!

⁴QHM—Will start to listen at *high* frequency end of band and tune towards *middle* of band.

QMH—Will start to listen in the *middle* of the band and tune toward the *high* freq. end.

QLM—Will start to listen at the *low* frequency end of band and tune towards *middle* of band.

QML—Will start to listen in the *middle* of the band and tune toward the *low* frequency end.

*Phone operators should *not* use Q code or telegraph pro-

* Communications Manager, A.R.R.L.

¹ 6:01 P.M., C.S.T., March 12th, see discussion under "the contest period."

² For R-S-T definitions of "readability, strength and tone" in that order; See 1937 A.R.R.L. Handbook, page 363, or drop postal for list. Scales correspond to W-R-T of European systems approximately.

³ In 'Phone exchanges only two numerals will be given in the report, the first always the "readability" and the second the "strength." In other words, telegraph entrants will receive six figure groups, and 'phone entrants will receive five figure groups.

Time	Starts		Ends	
	March		March	
Greenwich	6th	20th 0001 (12:01 A.M.)	14th	28th 2359 (11:59 P.M.)
A.S.T.	5th	19th 3:01 P.M.	14th	28th 7:59 P.M.
E.S.T.	5th	19th 7:01 P.M.	14th	28th 6:59 P.M.
C.S.T.	5th	19th 9:01 P.M.	14th	28th 5:59 P.M.
M.S.T.	5th	19th 5:01 P.M.	14th	28th 4:59 P.M.
P.S.T.	5th	19th 4:01 P.M.	14th	28th 3:59 P.M.

For those who swear by 'phone, this competition will be one for DX laurels, competing in the second period with fellow 'phone operators. For those working c.w., competition for DX will be in the first period, and largely with fellow hams using the same mode of communication. In either period 'phone stations may work c.w. stations and vice versa, claiming points for one or two-way exchanges of six figure for five figure groups if such exchanges are possible. It must be realized that such 'phone-c.w. contacts, always involving one non-participant, will be almost nil, but such work is perfectly acceptable where such contacts are made, and the non-participant assumes a serial number (for his records and your report). Separate certificates will be awarded the c.w. winner, and the 'phone winner, for each country, and likewise for each A.R.R.L. Section. It's a chance for 14- and 28-Mc. 'phone hams to do their stuff in the second period—but it will in no sense be a competition of 'phone with c.w. operators. Choose any mode of communication you like; *try your luck and DX, and report results one and all!*

Logs on the first period will all be marked "C.w. station work," and those for the second period, "Phone work." The transmitter must be kept on c.w. or 'phone, too. It is unethical to shift to c.w. to call a station, or send numbers, when taking part in the 'phone period (and vice versa), and disqualification will be made of offending stations. Likewise, whistling of code for numbers (or similar means) is regarded as improper. Counting of consecutive numbers, spelling of the letters that constitute numbers, using word lists from the Handbook, etc., are regarded as the proper methods.

GENERAL CONTEST PLAN

Amateurs with the prefixes W and VE will be taking part in a QSO Party with stations in all parts of the world. When they effect DX QSOs, they will exchange self-assigned serial numbers (two³ or three-figure reports plus three self-assigned numbers that stay the same for all stations). This whole group is entered in the con-

cedure when a few properly chosen words will inform the transmitting operator in what part of the band they will be listening first! The idea also is to make the 'phone report part of the five numeral groups, so it will be quite unnecessary to say "readability" and "strength" or other indication before the first two numbers in the serial number group.

test report. From this record each station will submit its score. From the scores (which the Contest Committee will verify by cross-examination of logs) the winners will be determined for each locality, and certificates awarded. Three points can result from a full exchange in any band, but no more can be obtained from the same station unless both stations connect in another band for additional exchanges.

Stations outside⁵ the U. S. and Canada will try to work as many W and VE stations as possible to exchange serial numbers. Stations in all localities need only take part on the dates announced and report results at the end of the tests to receive credit in QST, and be eligible for awards.

The main competition each operator must consider comes from operators in his immediate A.R.R.L. Section in the case of W and VE stations,⁶ and in the case of all other amateurs it comes from the individual operators in their country or locality using the same prefix.⁷ The W/VE awards are for the operator running up the best record for each Section under the Rules.

THE CONTEST PERIOD

To avoid misunderstanding and possible confusion, the exact local starting and ending time for our DX competition is given in the above table. These times are based on "Greenwich" and should be computed for any part of the world from the Greenwich meridian. The contest runs (First Period) from Saturday, March 6th, through Sunday, March 14th (until Monday, March 15th, G.T.); (Second Period) from Saturday, March 20th, through Sunday, March 28th (until Monday March 29th, G.T.).

SERIAL NUMBERS

The first digits of the serial number sent shall constitute the Readability³—Strength³ and Tone³ reports of the station to which the number is sent. Every operator taking part in the contest

⁵ Alaska, Hawaii, Philippine Islands, Cuba, Porto Rico, and Newfoundland, in fact, all localities using PREFIXES other than W or VE will receive QST mention and awards based on their work with W/VE stations.

⁶ Page 7 of this QST carries a complete list of the Sections of the A.R.R.L. Field Organization.

⁷ Consult the list of call-prefixes for different countries of the world as given in Jan. '37 QST, page 52. This will be used as the official list. Also see I.A.R.U. this month.

assigns himself a distinctive three-numeral group, used by him throughout the contest as the last part of each number exchanged (sent). Try to send and receive one complete serial number with each DX station.

TIME LIMIT

Up to and including 90 hours' total contest operation (for *either* period) there is no penalty, (Continued on page 76)

LOG, NINTH A.R.R.L. INTERNATIONAL RELAY COMPETITION (Example, W5XYZ, Serial No. 649)

C.W. Entry		March 6th-14th	Bands:					
			1.7	3.5	7	14	28 Mc.	Total
Call Signal.....	Logs from W or VE, show, for each band:							
Name.....								
Address.....	Nr. DX Stations QSOed.....			3	4	1	1	9
Transmitter Tubes.....	Nr. Countries (prefixes) QSOed..			2	3	1	1	7
Plate watts (input last stage).....	Logs from remote points indicate; for each band:							
Nr. Hours Station Operation ⁸ (14 h. 29 m.)	Nr. W/VE stations QSOed.....							
A.R.R.L. Section (for W/VE's).....	Nr. U. S. A.—Canada licensing areas worked.....							

Station Time Record	Operating Time	Date and Time	Station Worked	Country	Worked Record of New Countries ⁹ for Each. Freq. Band					Serial Nrs.		Points
					1.7	3.5	7	14	28	Sent	Received	
On 7:01 P.M.		Mar. 13th 7:02 P.M. E.S.T. (or 002 G.T.)	G6RB	G. B.		1				568,543	478,001	3
		Mar. 14th 7:15 P.M. E.S.T.	G2SZ	G. B.		1 ¹⁰					578,988	2
Off 10 P.M.	2 h. 59	9:40 P.M. E.S.T.	ON4AU	Belgium		2				488,543	488,111	3
On 7 P.M.		Mar. 14th 7:38 P.M.	VK3WL	Aust.			1			579,543	579,287	3
		8:50 P.M.	ZL2CI	N. Z.			2			487,543	398,657	3
Off 11:55 P.M.	4 h. 55	11:50 P.M.	J2GX	Japan				1		349,543	588,984	3
On 12:00		Mar. 17th 12:05 A.M. E.S.T.	VK7RC	Aust.			2 ¹⁰			586,543	577,000	3
Off 4:05 A.M.	4 h. 05	3:10 A.M. E.S.T.	VK5PK	Aust.					1	499,543		1
On 1:30 P.M.		2 P.M. E.S.T.	PY2BN	Brazil			3			487,543	468,852	3
Off 4 P.M.	2 h. 30											

14 h. 29

Multiplier = 2 + 3 + 1 + 1

24 × 7 (countries—prefixes) = 168 Score

"Points" multiplied by the number of

1) Countries or localities (prefixes) for all bands

OR

2) U. S. and Canadian licensing areas for all bands equals the SCORE..... (This is the final score unless the operating time exceeds 90 hours).

I hereby state that in this contest, to the best of my knowledge and belief, I have not operated my transmitter outside any of the frequency bands specified in, or in any manner contrary to, the regulations my country has established for amateur radio stations; also that the scoring points and facts as set forth in the above log and summary of my contest work are correct and true.

.....
Signature of operator(s)

⁸ Add second column in log to give total operating time.

⁹ "Countries" for W/VE Participants. Change this to read "Districts" or "Licensing Areas" on all reports from other parts of the World.

¹⁰ A progressive record of the number of new countries (or licensing areas) is kept in these columns. A notation is made for each station worked but the figure increases numerically only as additional prefixes (or lic. areas) are added on a certain band. These columns are not added, but the last number notation in each column added to similar numbers in other columns gives the "multiplier." Counting the "number of notations" in each of these columns gives the number of different contacts with "DX stations" or "W/VE stations" on each band, as the case may be, so the information at the beginning of the log-record may be filled in.

All-Continent 'Phone Round Table

W4DLH Establishes New WAC Record

KING ARTHUR was a piker when it came to Round Tables. W4DLH, VU2CQ, SU1CH, HK1Z, G5ML and VK4LO have got it over him and his knights like Garbo and Taylor have it over the original Camille and her boy friend.

Getting down to details, "four dark lean horses" broke the barrier down in Florida at 1237 GT on the morning of December 30th, swung around the turn at Bombay two minutes later, cleared Cairo, Egypt, in another four lengths, doubled back to Cali, Colombia, in a hundred seconds more, rode with the whip to Kenilworth, England, and finally clicked the shutter away off in Brisbane, Australia, in a total elapsed time of 21 minutes.

All of which mixed metaphors—plus as many superlatives as one could hope to garner in an afternoon's *Thesaurus* hunt—are derived from the

A 100% record of success—each continent turning it over to the next, and each answering in turn. Each station was able to hear each of the others with satisfactory signal strength—and all on 'phone!

After the chain was complete VK4LO turned it back to W4DLH, who gave a report on the time required to complete the 'round-the-world radio tour. After congratulations and thanks for the hearty and effective cooperation, Bill started it around once more. Whereupon each station voiced further congratulations, and all settled down to a nice, friendly rag-chew!

HOW IT WAS DONE

Such a feat as this represents no coincidence, with the ham bands as they are to-day. On the contrary, it represented many days of hard work and watchful waiting. The story goes like this:

Quite by accident, on December 14th W4DLH got into a four-continent round table involving G5PP, SU1KG, HK1Z and SU1GP. From that moment he was determined to try for an all-continent round table, convinced that, with the right conditions, it was an entirely reasonable expectation. This conviction was strengthened when, on December 23rd, another four-continent hook-up was accomplished, with SU1CH, VU2CQ and VK4LO. W4DLH realized that the missing continents, Europe and South America, were the easiest to contact, and that they were both coming in during the early morning (the Dec. 23rd tie-up began at 1246 GT). He lost no time in making schedules with stations in each of the continents, and for two weeks an attempt was made practically every day.

Too much cannot be said for the cooperative spirit of the stations participating. Every operator must have suffered considerable inconvenience in the common cause. HK1Z and W4DLH were on at daybreak each day for nearly two weeks. VK4LO similarly stood by until well after midnight on many occasions, with VK5AW serving as alternate station. The VU2CQ sked must have broken into his dinner hour more than once. And imagine the excuses SU1CH made to get on the air at 2 P.M. every afternoon—and G5ML's lunches at the operating table. Frequently success seemed right at hand. On one occasion there was only a slip-up on an European sked between success and failure; on another VU2CQ suffered the misfortune of having his transmitter break down at a crucial moment.

But on December 30th the break came. Condi-

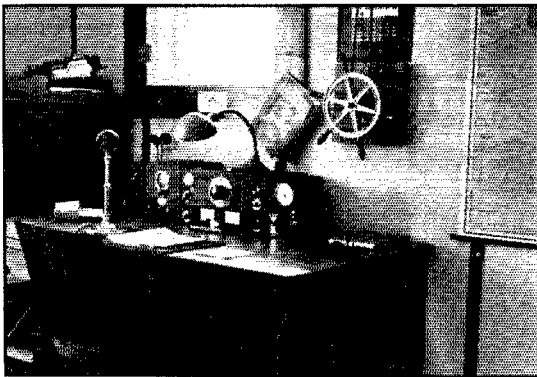

OFFICIAL 'PHONE STATION W4DLH, GOULDS, FLA.
Sitting at the operating position in comfort, Bill Burkhart picks his direction and turns his Signal Squitter to it by means of the boat wheel mounted above the desk.

following quotation from the log of W4DLH, a gentleman who specializes in growing potatoes and 'phone records down in sunny Florida:

- "1237 GT—W4DLH, Goulds, Florida, officially called the 'All-Continent Round Table' to order and turned it over to VU2CQ.
- "1239 GT—VU2CQ, Bombay, India, checked in to the round table and turned it over to 'Ed', SU1CH.
- "1243 GT—SU1CH, Cairo, Egypt, checked in to the round table and turned it over to 'Tony', HK1Z.
- "1245 GT—HK1Z, Cali, Colombia, checked in to the round table and turned it over to 'Fred', G5ML.
- "1252 GT—G5ML, Kenilworth, England, checked in to the round table and turned it over to 'Frank', VK4LO.
- "1258 GT—VK4LO, Brisbane, Australia, checked in to the round table, making the all-continent chain complete in 21 minutes elapsed time."

tions were right—that became apparent as the zero hour drew near. Indeed, so confident was W4DLH that he QSO'ed W8RL just before the sked was due so that he would have the North American leg on a quick 'phone WAC if things went right. And they did—every man was on the job, every transmitter worked perfectly, the operators moved through the contacts with precision and speed—the history-making deed was done!

TIME WAS CAREFULLY CHOSEN

A great deal of care was taken in choosing the exact time of the schedule, for conditions had to be such that each continent was able to hear every other continent if success was to be had. When the round table finally went through it was 7:30 A.M. in North and South America, G5ML was home for lunch, it was 2:30 P.M. in Egypt, 6 P.M. in India, and 10:30 in the evening at VK4LO—making the contacts not only 'round the table and 'round the world but 'round the clock as well.

Equal care was taken in choosing the stations and operators, for a maximum of efficiency in each. No—the “all-continent radiotelephone round table” did not just happen; it took the finest kind of cooperation, confidence, equipment, planning and work on the part of all concerned.

SIDELIGHTS

W4DLH's foresightedness in contacting W8RL prior to the sked won him a 'phone WAC in 36 minutes—the fastest on record, and *on 'phone!*

The relative mileages covered on each leg were: Florida to India, 9062; Bombay to Cairo, 4712; Egypt to Colombia, 7612; South America to England, 5437, and, finally, the extra spurt of r.f. G5ML put in his antenna landed him in Australia 12,325 miles away. Qualifying the first figure above, the W4DLH-VU2CQ mileage is given for the short-way-'round; but Bill Burkhart is convinced through numerous tests made with his “Mims' Signal Squirrel” that the Indian and Egyptian stations arrive at Goulds, Florida, not over the Great Circle route but by the long-way-'round. As a result, he shoots SW when working into that region, except at about 2000 GT when the Great Circle Route is effective.

Anyway, a minimum total of 39,148 statute miles were traversed by the “Knights of the Radio Round Table” in making their history-making tour of the globe.

W2IXY'S RECORDINGS AND REBROADCAST

Perhaps the crowning thrill of all that exciting morning was the surprise tendered the successful world-girdlers by Mrs. Dorothy Hall, W2IXY, of Long Island, New York. She had been greatly interested in the outcome of the tests, and had followed the attempts on each successive morning. Standing by and “turning over” each time

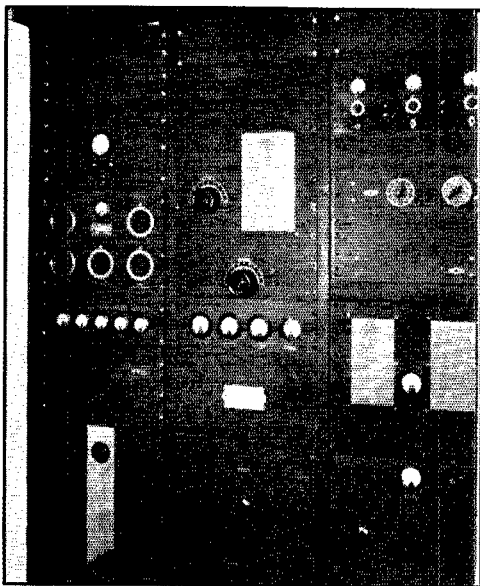

NORMALLY 500 WATTS ARE RUN AT W4DLH THOUGH THE TRANSMITTER HAS A 1-KW. CAPACITY

A pair of HD203A's modulate the 300T in the final stage

was her recording equipment, which operates directly from the station receiver. On the successful morning she was able to hear the participating stations with good signal strength and—got several transmissions permanently logged on the recorder! After the round table broke up, W2IXY rebroadcast to G5ML, HK1Z and W4DLH their transmissions while the six-way had been in session. G5ML's surprise at hearing his own voice come bouncing back from the States a few minutes after it left his own transmitter can be imagined.

Well, that's the story. Do you check with us on the metaphors and the superlatives, now? It's getting hard to think of any stunt in ham radio still left undone. . . .

May these modern Knights of the Round Table live in radio legend as long as King Arthur and his pals, say we. They deserve it!

—C. B. D.

Operating Data on the 100TH and 100TL

COMPLETE characteristics and recommended operating conditions on the new Eimac 100TH and 100TL have now been released by the manufacturers. These tubes, which both supplant the 50T and augment the Eimac line, are respectively high- and medium- μ triodes with

(Continued on page 102)

The Doherty High-Efficiency Amplifier Applied to Amateur 'Phone

Practical Circuit Design and Experimental Results at 3950 Kc.

By Bruce E. Montgomery,* W9AHH

LAST Spring, preliminary to the annual I.R.E. convention, notices were released concerning a new high-efficiency type linear amplifier for modulated r.f., developed in the Bell Laboratories, which was to be described at the convention; a linear amplifier that gave efficiencies twice as high as the well known Class-B type. Every ama-

grid is continuously variable from zero to the maximum obtainable. As the excitation is increased from zero, the antenna current increases in exact proportion to the r.f. grid voltage. But finally a point is reached at which little increase in antenna current occurs with a large increase in excitation. At about this same point the grid meter begins to show direct current flow.



GENERAL VIEW OF THE EXPERIMENTAL HIGH-EFFICIENCY AMPLIFIER SET-UP IN THE COMMUNICATIONS LABORATORY, ELECTRICAL ENGINEERING DEPARTMENT, IOWA STATE COLLEGE

The breadboards, from left to right, are the crystal oscillator on 3950 kc. and the RK20 suppressor modulated amplifier, the high-efficiency amplifier, and the pi-section load matching network. All oscillograph pictures were taken from the screen of the oscilloscope.

When the r.f. excitation is zero, there is no alternating r.f. voltage present on the plate of the tube. As the excitation is started and increased, an alternating voltage appears superimposed on the d.c. plate voltage and increases linearly with increase in excitation just as the antenna current does. When the peak value of this alternating voltage reaches about 0.85 of the d.c. plate voltage, this increase ceases to be linear, and more excitation causes little increase in this alternating voltage. The antenna current and alternating plate voltage component, of course, depart from linearity at the same point.

teur who read these notices hoped for more practical information on the amplifier, and the sooner it appeared the better. When the first brief article¹ on the subject did appear, however, it was immediately evident that things were not as rosy as they seemed. The difficulty was in the apparent complexity and adjustment of the circuit. It was very definitely not an amplifier on which the beginner should cut his teeth.

To use the Class-B amplifier with 100% modulation, it is therefore necessary to reduce the unmodulated excitation until the antenna current is half of maximum. This means that the alternating plate voltage is also one half of its maximum value, and that the power output is one fourth of the maximum output. The

Now that we have been a little pessimistic, we will say that the amplifier does have definite possibilities for the advanced amateur who likes to make complicated things work, especially if powers in the neighborhood of 1 kw. are contemplated. But before plunging into the operation of the high-efficiency linear amplifier, it will be desirable to review the operation of the conventional Class-B linear.

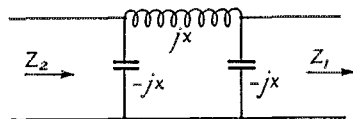

FIG. 1

Suppose we have such an amplifier, grid bias adjusted to cut-off, the circuit neutralized, and the proper load coupled into the plate circuit. Suppose further that the r.f. excitation to the

efficiency of the amplifier when receiving maximum excitation is about 60%. When the excitation is reduced to half for 100% modulation, the carrier efficiency drops to about 30%. If the excitation is adjusted to give maximum antenna current and the modulation is applied, the average antenna current will decrease; and, on an oscilloscope screen, the negative peaks of modulation will appear quite as usual, but the positive peaks will be cut off at the carrier value. (See the oscillograph picture illustrating this.) However, the efficiency is high, being about 60% or more.

At about this point, Doherty shows how a tube

* 159 Washington St., Edgewood, Pa.
¹ W. H. Doherty, "A New Power Amplifier of High Efficiency," *Bell Laboratories Record*, XIV, 10, June, 1936.

may be used in the above condition of high efficiency to supply the carrier and negative peaks of modulation. Then, by interposing a quarter-wave filter between this tube and the output load and connecting directly to the load another tube biased to about twice cut-off, it is possible to fill in the positive peaks of modulation and at the same time maintain high efficiency.

THE IMPEDANCE-INVERTING FILTER

This necessary filter has an interesting impedance inverting characteristic, and an understanding of its operation is absolutely essential to understand the operation of the amplifier. So it will be necessary at this point to delve into the intricacies of the gadget. What will be said will apply equally well to a pi or T filter, but only the pi low-pass type will be considered here.

The diagram of Fig. 1 shows the filter under consideration.

Each leg of the pi-section has a reactance of X ohms, either inductive or capacitive, as the case may be.

Further, this relation is true

$$Z_o = \sqrt{Z_1 Z_2} = X, \quad (1)$$

where Z_o is the characteristic impedance of the filter section.

Solving (1) for Z_2 ,

$$Z_2 = \frac{X^2}{Z_1} \quad (2)$$

If the filter is terminated in a resistance, R_1 , instead of impedance, Z_1 , then

$$Z_2 = \frac{X^2}{R_1} = R_2, \quad (3)$$

or the filter appears as a resistance of magnitude R_2 when terminated by R_1 . So if R_1 varies, R_2 will vary in the *opposite* direction. An analogy to this action, while not exact, will help us visualize what happens in the filter. Imagine a teeter-totter—a saw horse with a board balanced across it. The height of the saw horse represents the characteristic impedance $Z_o (= X)$ of our filter. The heights of the ends of the board from the ground represent the resistances in which the filter is terminated. When the board is horizontal, this condition exists,

$$Z_o = R_1 = R_2 = X.$$

Depressing one end of the board raises the other end, and likewise decreasing R_1 increases R_2 . This analogy can be carried too far. Pushing one end of the board to the ground raises the other end to twice the height of the saw horse, but dropping R_1 to zero does not increase R_2 to twice the characteristic impedance. Instead, R_2 goes to infinity!

Relations (1), (2), and (3) may be proved without great difficulty by applying complex

algebra to Fig. 1, and solving for the input impedance.

In addition to the peculiar impedance inverting characteristic, the filter introduces a lagging phase shift of 90° , or is a "quarter-wave long." This phase shift is not necessary for the operation of the amplifier, but is an inherent and unavoidable characteristic of the filter.

Now proceed to Fig. 2. Going back to equation (3) and replacing R_1 by $R/2$, it is seen that VT_1 , which shall be called the "carrier tube," is working into a resistance of $2R$. $R/2$ represents the

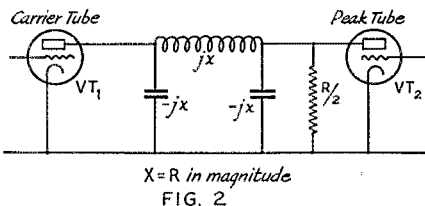

output load. The carrier tube is operating Class B with just enough r.f. excitation to drive the grid positive. In this condition, the carrier tube is operating at maximum output for a load resistance of $2R$ and its efficiency is 60% or better. The filter, having no resistance elements, must pass all the power output of the carrier tube into the load resistance, $R/2$. An application of the power relation, $P = E^2/R$, shows that the r.f. voltage $R/2$ is one-half that developed at the input of the filter by the carrier tube.

Assume now that the carrier tube and VT_2 , the "peak tube," are the same type, that the same d.c. plate voltage is applied to each, and that each has the same value of grid excitation in proper phase. The carrier tube is biased to cut-off and the grid is driven to zero or slightly positive. The peak tube is biased to about twice cut-off and so will have little or no plate current flowing. *This is the unmodulated carrier condition.* As the excitation is increased beyond this value, no increase in r.f. voltage on the plate of the carrier tube occurs and so this tube can not contribute more power to the load by virtue of increasing r.f. voltage. But this increase in excitation is also applied to the peak tube and its plate current rises from zero.

This tube now begins to send power into the load. With any given value of resistance, the only way to increase the power into it is to raise the voltage across it. The peak tube is now contributing power to the load, and to do this the voltage across this fixed load must increase. This increase in power and rise in voltage at the load, caused by the increased excitation to the peak tube, appears to the filter as a rising resistance load. That is, as far as the filter is able to tell, the load resistance is actually increasing. Now the impedance inverting characteristic of the filter

comes into play. So, remembering the teeter-totter analogy, the resistance presented to the plate circuit of the carrier tube is decreasing as the load resistance is increasing. On this action hangs the whole operation of the amplifier.

This decreasing resistance in the plate of the carrier tube allows it to give more output without an increase in r.f. plate voltage. As the excitation continues to increase, the power contributed to the load by the peak tube also increases. This causes the effective load resistance to continue to



(Left) OSCILLOGRAPH OF A CLASS-B LINEAR AMPLIFIER WHEN THE EXCITATION IS TOO HIGH

The antenna current decreases with modulation. Note how the positive peaks are cut off. (Right) Oscillograph picture of the high-efficiency amplifier incorrectly adjusted. The positive peaks are not filled out because the peak tube is unable to contribute its share of the power.

increase and thus to decrease further the resistance presented by the filter to the carrier tube, which in turn allows the output of this tube to increase.

The maximum value of excitation is that which drives the grid of the peak tube to approximately zero. When this occurs, the r.f. plate voltage on the peak tube has become equal to the voltage on the carrier tube, and the effective resistance that each tube is working into is R . Since the carrier tube was operating into a resistance of $2R$ and this resistance has been cut in half, the output must have doubled. And since the peak tube is operating into R ohms also and at the same r.f. plate voltage, this tube must contribute the same power to the load as does the carrier tube. This means that the power to the load is four times as much as when the excitation was just enough to cause the carrier tube only to supply power. This, then, fulfills the requirement that on the peaks of 100% modulation the instantaneous power must be four times the carrier value.

CORRECTING FOR THE PHASE SHIFT

It has been stated that the filter network introduces a 90° lagging phase shift. It is, therefore, obvious that the r.f. voltages on the plates of the carrier and peak tubes are 90° out of phase. It is equally obvious that the grids of the two tubes therefore can not be excited in phase, but must also be 90° out of phase. This is accomplished by inserting a filter, similar to the one in the plate circuit of the carrier tube, in the grid circuit of the peak tube. Fig. 3 shows the grid circuit. A

loading resistor, R , is necessary to fix the input and output resistance of the filter. If $R = X = Z_0$, then the input resistance at the carrier tube end of the filter will be R ohms also, and the same excitation voltage will appear at the grids of both tubes.

Putting Figs. 2 and 3 together, we get a more complete diagram in Fig. 4. This figure looks very much like the familiar push-pull amplifier; but it is only the skeleton of the real diagram.

NEUTRALIZATION

This amplifier must be neutralized for the same reason that any other triode amplifier requires neutralization. The simple cross-connection of neutralizing condensers can not be used because the plates and grids of the tubes are 90° out of phase and not 180° , as would be the case for the usual method of neutralization. It is necessary therefore to add a tuned tank circuit across each plate and to add a neutralizing winding so that the tubes may be neutralized separately. The condenser of the tank circuit and that of the filter may be combined into a single condenser to simplify the circuit.

Tank circuits were also added in the grid circuit, and the condensers of the tank and filter again combined. This was done so that link coupling could be used, and so that a more satisfac-

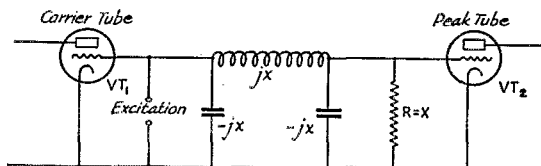

FIG. 3

tory way of securing the grid loading resistor was at hand if a tank circuit was used. The circuit, as finally developed for 3950 kc. is shown in Fig. 5.

CIRCUIT VALUE CALCULATIONS

It is necessary to calculate the characteristic impedance of the plate circuit filter, basing it on the output expected. L_4 is the critical element in the plate circuit and must have a reactance equal to the characteristic impedance of the filter. C_1 is a blocking condenser included so that the plate currents of the tubes may be measured separately. The following calculations show the method used to arrive at the inductance of L_4 :

Given: $E_p = 1000$ volts d.c.
 Assume: Carrier power = 60 watts
 Efficiency = 60%

From which:

$$\frac{0.9}{\sqrt{2}} E_p = \frac{\text{Maximum r.f. plate voltage} = (0.9)(1000)}{\sqrt{2}} = 636 \text{ volts r.m.s.}$$

$$\text{Input} = \frac{60}{0.6} = 100 \text{ watts}$$

and $I_p = 100 \text{ ma.}$

Under these conditions, the carrier tube must "see" the following resistance:

$$R = \frac{E^2_{r.f.}}{P} = \frac{636^2}{60} = 6750 \text{ ohms.}$$

As has been shown, this resistance is twice the characteristic impedance. So $Z_o = 3375 \text{ ohms.}$

The load resistance to be coupled into the output of the filter is $Z_o/2 = 1687 \text{ ohms.}$

Since the reactance of L_4 must be equal to Z_o , from $X_L = 2\pi fL$ is found the value of L_4 at 3950 kc. or, $L_4 = 136 \mu h.$

The correct number of turns and size of coil, given in Fig. 5, were found by using the *Lightning Radio Calculator.*

The capacitance that must be present to complete the filter was calculated to be 12.3 $\mu\text{mfd.}$ In choosing the tank circuits (L_2C_4), C_4 should be large enough to allow for this additional capacity.

The flashlight bulbs in series with L_1 provide the load resistance on the grid circuit instead of using a parallel load resistor. They take about 3 watts at full brilliancy. It is only necessary that the bulbs take the same power that a parallel resistor would take to provide the correct load. A lamp tapped across a part of the coil instead of in series with it would also work.*

Since the amplification factor of 211-D is about 11, something of the order of 100 volts peak can be expected at the grids for carrier excitation, or 70.7 volts r.m.s. The bulbs take about

$$X_L = \frac{70.7}{0.15} = 471 \text{ ohms,}$$

$$\text{and from } X_L = 2\pi fL, \\ L_1 = 19 \mu h.$$

If the bulbs dissipate 3 watts with 70.7 volts across L_1 , and 0.15 amp. flowing, the equivalent parallel resistance is

$$R = \frac{E^2}{P} = \frac{70.7^2}{3} = 1667 \text{ ohms.}$$

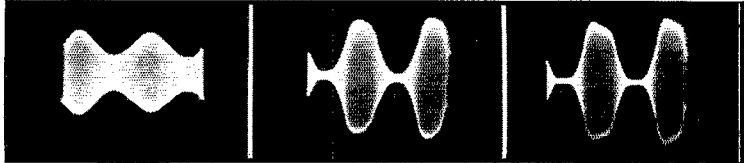

CATHODE-RAY OSCILLOGRAPH PICTURES OF THE WAVE FORM OF THE HIGH-EFFICIENCY LINEAR AMPLIFIER WHEN CORRECTLY ADJUSTED
Left, partially modulated; center, completely modulated; right, over-modulated.

Then, for the grid circuit filter, $Z_o = X_{L_1} = 1667 \text{ ohms.}$ Because of the change in the resistance of the bulbs as their temperature varies, the value of $R = 1667$ varies considerably. Therefore it would be desirable to be able to vary X_{L_1} over a limited range. This was accomplished by first determining the correct coil size for $X_L = 1667 \text{ ohms}$ in the same manner as was done for the plate circuit, taking off about a third of the turns, and connecting the 25- $\mu\text{mfd.}$ condenser, C_8 , across the coil. Starting with the plates all out, and then increasing the capacitance of C_8 , the inductive reactance of L_7C_8 will increase from a value less than 1667 ohms to one considerably greater until resonance may be reached. At this point L_7C_8 becomes a pure resistance of high value. Somewhere in this range is the correct setting for C_8 .

ADJUSTMENT PROCEDURE

Next comes the interesting, but sometimes exasperating, job of tuning up. With no plate voltage applied, it will first be necessary to bring the grid circuit into approximate adjustment. Adjust the grid bias on both the peak and carrier tubes to about cut-off for the plate voltage used, and apply excitation. Set C_8 at minimum capacity, and tune the two grid tank circuits for maximum brilliancy of the grid loading bulbs. Increase excitation until a small amount of grid current flows through one of the tubes. Now by resetting C_8 , and retuning the tank circuits, a setting will be found that will cause the same grid current to flow through each tube. Keep the grid currents down as low as possible so that no more additional load than necessary will be put on the filter. With this adjustment both grids are receiving the same r.f. voltage.

At this point, the amplifier can be neutralized. Each tube is neutralized separately in quite the

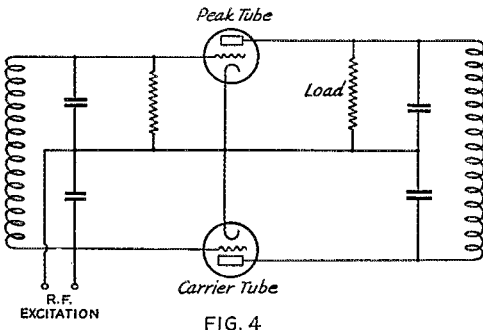

0.15 amp. at normal brilliancy, so the reactance of L_1 should be of such a value as to allow 0.15 amp. to flow with 70.7 volts at 3959 kc. present.

from the familiar relation, $I = \frac{E}{X_L}$,

usual manner. Simply adjust the neutralizing condenser belonging to the tube to be neutralized until tuning the plate tank circuit belonging to that tube causes no flicker in the brilliancy

The voltages across the two tank circuits in both the plate and grid circuits are supposed to be 90° out of phase. If the voltage across one plate tank coil is applied to one set of deflection plates, and

the voltage across the other plate coil to the other set of deflection plates, an ellipse will appear on the screen with the axes horizontal and vertical when the voltages are 90° out of phase. Using this method, the carrier-tube plate tank circuit should first be tuned for minimum plate current and the other tank tuned for the 90° phase shift. The full r.f. voltage cannot, of course, be applied directly to the oscilloscope, but by use of a condenser voltage divider. When the oscilloscope is removed, the circuit must be retuned to compensate for the capacity of the instrument. The first method seems to give good results and is simpler, so the oscilloscope can be dispensed with for this adjustment.

To secure the proper load resistance, the cathode-ray tube, through a condenser voltage divider, may be of help in making sure the voltage on the output side of the filter is one-half the voltage on the carrier tube side.

The plate voltage to the peak tube may now be applied. The plate current to this tube should be small, perhaps 10% of the current to the carrier tube.

From this point on, a cathode-ray tube on the output wave is essential. The audio voltage doing the modulating may be used on the sweep circuit, or a linear sweep should be equally satisfactory to show the wave form. Whatever method is used, it is necessary to see what effect the various tuning adjustments have on the wave form. 100% sine-wave modulation may now be applied to the exciter. The 60-cycle a.c. mains may be used if no audio oscillator is available, and if the modulation equipment will pass that frequency.

If the positive peaks of modulation do not come up as high as they should, the peak tube is not contributing its share of the power. (See oscillograph picture.) This may be the result of a too-high load resistance, too much bias on the peak tube, or the grid filter may not be adjusted to give the peak-tube grid enough excitation. To increase the excitation to the peak tube, the combination L_7C_5 should be adjusted to a lower

(Continued on page 118)

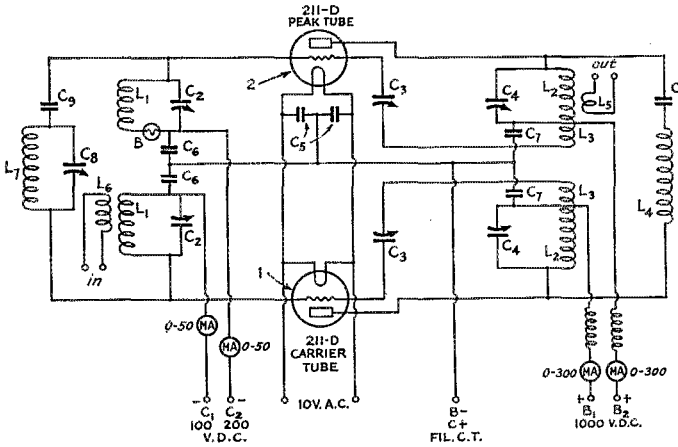

FIG. 5—THE FINAL CIRCUIT FOR 3950-KC. OPERATION

- L_1 —19- μ h. coil, 19 turns No. 20 d.c.c., 1 $\frac{3}{8}$ -inch diameter, $\frac{3}{4}$ inch long.
- L_2 —11- μ h. coil, 10 turns No. 14 enameled, 2 $\frac{3}{4}$ -inch diameter, $\frac{1}{16}$ inch long.
- L_3 —Neutralizing winding, 8 turns No. 22 enameled, close-wound.
- L_4 —136- μ h. coil, 62 turns No. 14 enameled, 2 $\frac{3}{4}$ -inch diameter, 4 $\frac{1}{2}$ inches long.
- L_5 —Output coupling coil, 4 turns No. 20 d.c.c. wound over L_2 .
- L_6 —Input coupling coil, 4 turns No. 20 d.c.c. wound over L_1 .
- L_7 —26 turns No. 28 d.s.c., 1 $\frac{1}{8}$ -inch diameter, close-wound.
- C_1 —0.002- μ fd. 2500-volt mica condenser.
- C_2 —100- μ fd. midget variable.
- C_3 —50- μ fd. 3000-volt neutralizing condenser.
- C_4 —330- μ fd. 3000-volt.
- C_5 —0.006- μ fd. mica.
- C_6 —0.005- μ fd. mica.
- C_7 —0.002- μ fd. 2500-volt mica.
- C_8 —25- μ fd. midget.
- C_9 —0.002- μ fd. mica.
- B—Three 6.3-volt 0.15-amp. flash bulbs in series.

Except for the input and output link couplings to L_1 and L_2 , no coupling should exist between any of the coils.

of the grid loading bulbs (or change in the grid current).

The bias on the peak tube should now be raised to about twice cut-off (Class-C); and the plate voltage may be applied to the carrier tube. It is necessary to keep the proper load on the amplifier at all times, so it is advisable to reduce the excitation somewhat until somewhere near the correct load resistance has been coupled in. A pi low-pass filter section with a 100-watt bulb on the output served as a load in our case.

The tank circuits in the plate circuit should be set at the points that caused the grid loading bulbs to flicker before neutralization, as this is very close to the correct adjustment. The load may now be brought into resonance and the excitation increased until the plate current is about normal, or grid current just starts to flow.

Touch up the tuning of the plate circuit. The tank on the carrier tube should be tuned for minimum plate current and the one on the peak tube should be tuned for maximum output. To be more exact in tuning the plate circuit (also the grid circuit), a cathode-ray tube may be used.

Radio Fadeouts Through 1936*

By J. H. Dellinger**

Amateur reports on the radio fadeout phenomenon known as the "Dellinger effect" have been especially helpful in collecting useful data throughout the past year. Further reports from amateurs fortunate enough to encounter these lapses in high-frequency propagation will be greatly appreciated. Be sure to give the exact time of the beginning and end of the fadeout observed and send your report to A.R.R.L., West Hartford, Conn.—EDITOR

IN THE January and June numbers¹ of *QST* last year I reported on the remarkable phenomenon of high-frequency radio fadeouts which I have had the privilege of studying with the cooperation of amateurs and others. From the data then available it was concluded that the fadeouts occurred simultaneously over wide areas and were confined to the hemisphere illuminated by the sun. The indication that they were caused by something happening on the sun was corroborated by the observation of visible eruptions on the sun simultaneous with several of the fadeouts. It was also found that small but sharp changes in terrestrial magnetism and earth currents occurred at the precise times of some of the fadeouts. Finally, it was concluded that the effects were caused by absorption in the ionosphere caused in turn by electromagnetic waves (probably ultra-optical) from a solar eruption.

Data accumulated since the June article have verified all these conclusions and give considerable further light on the phenomena. The June article reported fadeouts through April 8th, and showed that the approximately 54-day period which had been observed at first was obscured by additional fadeouts on other dates. Since April 8th many fadeouts have occurred. There appears an approximately 54-day recurrence tendency in the intensity of fadeouts, but the dates of occurrence of the fadeouts are not predictable. While the phenomenon has not been under study long enough to permit a definite conclusion about this recurrence tendency, it appears to be rather more definite than, for example, the 27-day recurrence tendency of ordinary magnetic disturbances.

The fadeouts became more and more numerous, up to May of last year. From about May 25th to June 19th a most extraordinary series of solar outbursts occurred, of the type which produce radio fadeouts. This seems to have been a climax of some form of activity in the sun which produced a few fadeouts in 1934, more in 1935, and still

more in 1936. In the three months, April to June of 1936, there were 54 reported fadeouts, more than the total number reported previously (in the two years during which the phenomenon had been isolated from other effects). Then in the following three months, July to September, there were only 16 reported fadeouts.

Of the 54 fadeouts in April to June, 21 are known to have been simultaneous with visible eruptions on the sun, duly observed and chronicled by astronomers. Also, 10 of the 54 were accompanied by simultaneous sharp fluctuations in the terrestrial magnetism.

In the entire period of two years from July 1934 to June 1936 there were 94 reported radio fadeouts; 39 of these are known to have been accompanied by a simultaneous visible eruption on the sun; 15 of them are known to have been accompanied by simultaneous fluctuations of terrestrial magnetic elements; and for 4 of them simultaneous fluctuations of earth currents have been reported. The fluctuations in terrestrial magnetism and earth currents are abrupt pulses of about the same duration as the radio fadeouts, not similar to the fluctuations characteristic of magnetic storms. In none of these fields has there been an opportunity to make a thoroughly comprehensive study of world-wide data, and there is good reason to suppose that the number of coincidences has been greater than is known at this time.

The occurrence of visible effects in the causative solar eruptions is probably more or less fortuitous. The cause of the fadeouts and the related terrestrial phenomena is a sudden outburst of highly penetrating solar radiation of ultra-violet (i.e., ultra-visible) frequencies. This produces sudden ionization of the atmosphere below (or possibly in) the *E*-layer of the ionosphere, where the air density is great enough to insure numerous collisions of moving ions and hence rapid absorption of the radio wave energy during the few minutes it lasts. The degree of absorption is less for the higher radio frequencies than for lower ones, and so the lower radio frequencies fade out first, remain out longer, and return last. The critical frequencies for the F_2 -layer are not affected.

(Continued on page 86)

* Publication approved by the Director of the National Bureau of Standards of the U. S. Department of Commerce.

** Chief, Radio Section, National Bureau of Standards, Washington, D. C.

¹ J. H. Dellinger, "A New Cosmic Phenomenon," *QST*, Jan., 1936; "High-Frequency Radio Fadeouts Continue," *QST*, June, 1936.

H A M D O M



PERHAPS the most remarkable angle on W9ERU's winning of the Chicago amateur code speed contest is that in eight years of big-time traffic-handling he never used a mill. Yet



W9ERU

Eugene A. Hubbell (27, single) says that, except for plenty of practice, high-speed typing is the most important requirement for record-breaking code work. His typing training occurred in high school and in radio school; code speed came from C.D. traffic work, plus N.C.R. and A.A.R.S. experience. Old "GL" at WLM gets the credit for teaching W9ERU the ropes. Since Nov. 22, 1927, he has been a continuously active amateur, serving as O.R.S., R.M. and O.B.S., high in freq. measuring contest, Sweepstakes, HPM birthday relay, Navy Day Honor Roll, and so on. In 1933 W9ERU reached the World's Championship finals with McElroy, Chaplin and five or six others. In 1936, in a strictly amateur contest, he won. He does not at present claim the world's amateur championship—but anyone who thinks they can beat 52.7 w.p.m. with one error is welcome to step up and try it!

WHEN George Bailey, W1KH, was elevated to the vice-presidency of A.R.R.L. the New England Division had to choose a new director. From a field of seven candidates it picked a well-known native son: Percy C. Noble, W1BVR-WLG, who, while born in 1905, only began to live in 1920 when the bug first bit! His radio activities and appointments, itemized, total more than two dozen (including being S.C.M.

and Acting 1st C.A. Radio Aide); list all you can think of (except 'phone) and add a few more, and you'll have them. He smokes Camels by the barrel, enjoys rifle practice, boxing, wrestling and books, doesn't know how to dance and isn't par-

ticularly interested. He is principal of the Blandford Consolidated School, drives 25 miles each day to work. Since 1921 W1BVR has experienced just seven complete rebuildings; now, concentration is on traffic, rag-chewing and DX, in the order named.

FLORA LOUISE CARD HOOVER

became an amateur in August, 1931, with the call W6EK, and the past five years have been the most eventful in her life. Since she is just 21 this seems quite reasonable. She is also 5 feet 6 inches tall, has light brown hair and hazel eyes, and is a beauty operator. She started in amateur radio with low power, but now she has an 860 in the final and a husband. Romance entered her life in the person of Sergeant J. F. Hoover ("CV" of W6ZG-WLV) when they were introduced over the air on Corps Area frequency. They were married in San Francisco in January, 1935. The OM, who is working for Mackay now, will be remembered for winning one of the three 100% accuracy cups last year. W6EK's chief interest is traffic-handling; she is B.P.L., O.R.S., N.C.R. and A.A.R.S. The Army receives a great deal of her attention: she has worked up from local to Alternate Corps Area Control as WLVK, which isn't bad for a YL soldier.



W6EK



W1BVR



W5DNE

AS A boy James M. Chambliss was well-known around Hamilton, Texas, for his playing in the local brass band. At 16 he became a telegraph operator, "doubling in brass" as a black-face comedian in minstrel shows. In 1903 he created a great sensation by being the only person in the county to own a motorcycle. Thirty years later, after a period of b.c. set-building, he acquired his ham ticket and the call W5DNE. For a year he chased DX; then he turned to traffic, and became O.R.S., A.A.R.S., on T. L.

(Continued on page 102)

More DX Per Dollar

Facile Frequency Control in a Three-Band Transmitter of 1-Kw. Capability

By Charles D. Perrine, Jr.,* W6CUH

If you have indulged in a rag-chew with W6CUH during the past few months you won't rest until you have read every word of this article. We raised him on the high-frequency edge of "twenty," one night recently, and asked him if the new rig was finished. We can imagine his satisfaction as he demonstrated by shifting his kilowatt to any one of four frequencies faster than we could tune the receiver—which convinced us that this is the form our next transmitter must take. It sets a new standard for facile performance. We give you instantaneous frequency change by W6CUH.—EDITOR.

Part I—The Exciter and Automatic Driver Stages**

FOUR years ago it was "Thirty Three Watts per Dollar" and 1-kw. 852's.¹ Now it is more DX, more QSO's, and more enjoyment per dollar, no matter what the power. New tubes and practice have largely solved the power problem; therefore the next logical step is increased frequency flexibility with its limitless opportunities. For flexibility can accomplish more than 10 or even 50 kw. ever could in the way of DX, QSO's and general fun—and above all it places the low-power man on a much more nearly even basis with the high-power competition.

The 1936 DX Contest forcibly drove home the need of flexibility—of being able quickly and accurately to shift to any frequency in as many as three bands. With three bands often "open" at once, a terrific advantage could be gained by being able to shift into whichever band a CQ was spotted. Or, when a short "band-edge" call is made with no luck, snap the crystal-controlled frequency into the band and call again so the choosy DX'er will have to hear you again—or, if he uses QLM or QHM, you can instantly match his intention.

And if your competition down the street beats you to VSSAA in spite of all this, just switch to electron-coupled control and wind the transmitter over on his frequency (your pal's) and you will have VSSAA hooked the moment he finishes. Then again, how often have you heard two of your friends QSO and wished to get into the discussion? The synchronized e.c. will get you in no matter what part of the band they are in. And

still another stunt is to help two stations hook up with each other by shifting to each of their frequencies in turn, literally leading them to each other. But the most surprising part is that you will never know how often you find reasons to change frequency until you can do it automatically and without effort.

So we come to this story of a transmitter that places flexibility on an automatic basis. The final input is 1 kw., but the ideas used are even easier when applied to lower powers. Entirely controlled

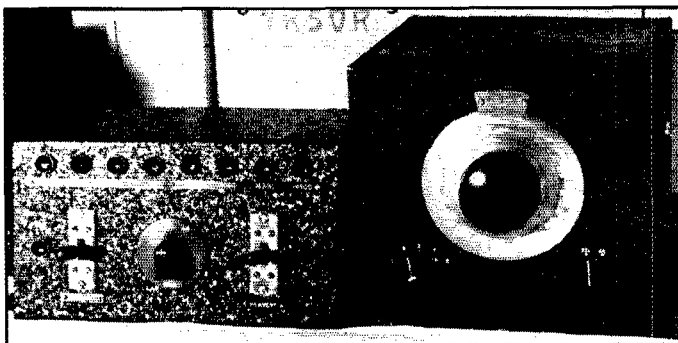

THE TRANSMITTER IS COMPLETELY CONTROLLED FROM THE OPERATING POSITION BY THESE TWO UNITS

The power stages are controlled from the panel at the left, while excitation frequency is controlled by the crystal-e.c. unit at the right.

from the operating position, the twist of a switch puts the output on the 28-, 14-, or 7-Mc. band; a second switch places this output on any one of five crystal-controlled frequencies in any one of the three bands (for instance, 7000, 7010, 7060, 7160, and 7200 kc. in the 7-Mc. band); and a third switch cuts over to e.c. oscillator control which, by means of a single dial, allows the use of any frequency in the 7- or 14-Mc. band and in the lower half of the 28-Mc. band. The operator thus has a multitude of frequencies available in three bands without even having to get out of his chair or interrupt his DX hunting.

The transmitter is in unit construction and

* 52 20th St., Hermosa Beach, Calif.

** The first of two parts. The second part will appear in a future issue of QST.

¹ Charles D. Perrine, Jr., "Thirty-Three Watts Per Dollar from a Type '52," QST, Sept., 1932.

represents the author's attempt to solve the problem of having a "permanent" transmitter—everything is in finished form except the 28-Mc. amplifier which has been retained as the "guinea pig" for the inevitable future experiments. The five units are made up of the crystal-e.c. oscillator-doubler unit on the operating desk; the main rack containing the automatic driver, 7-Mc. final amplifier, and low-voltage power supplies; the separate high-voltage power supply in another

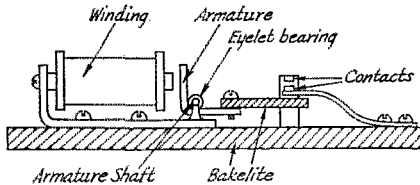

FIG. 1—CONSTRUCTION OF THE HOME-MADE PADDER RELAYS

frame; and the 14- and 28-Mc. final amplifiers, the last two being separate units.

Other important features of the transmitter include a new compact design for the 14-Mc. push-pull final amplifier. The high efficiency 28-Mc. power doubler utilizes to the full the possibilities of the new Eimac 250TH high- μ tubes. The tank coils are all wire-wound and unusually small. Lastly, there is an improved method of primary keying that gives perfectly clean signals at any speed no matter what amount of filter is used, yet retaining all the important advantages that make primary keying so indispensable to high power.

As is necessarily the case in most articles of this nature, many of the small details must be left to the reader. Furthermore, most of the ideas will probably be applied to transmitters already in operation; hence no detailed mechanical specifications are given except in the case of the band- and frequency-changing relays.

BAND AND FREQUENCY CHANGE

The tube line-up was chosen to give excess excitation at every point. Each stage does its job in easy, straightforward fashion without resort to any trick circuits. Automatic operation requires absolute dependability comparable to that of commercial jobs. An 802 serves either as crystal or electron-coupled oscillator driving a 6L6 as a doubler to 7 Mc. The 6L6 is linked to a 100TH plate neutralized buffer working also on 7 Mc. The 100TH is followed by a capacity-coupled 250TH driver, the output of which can be switched automatically from 7 to 14 Mc. as described later, the tube working as a power doubler to 14 Mc. Three separate final amplifiers are used for the three bands, each link-coupled to the above driver. A pair of paralleled 250TH's, grid neutralized, do the job on 7 Mc.; another pair in

push-pull handle 14 Mc.; and a third pair power-double to 28 Mc. An attempt was originally made to have one amplifier do the job—three paralleled 250TH's worked straight through on 7 Mc., doubled handily to 14 Mc., and even handled close to 1 kw. quadrupling to 28 Mc. But that set-up proved unfeasible because of the difficulty of coupling three antennas to one tank circuit; not to mention the interlocking adjustments of all three bands.

So much for the general band-change method. Of greatest interest is the automatic frequency change which enables the output frequency to be shifted over ranges of 7000–7250, 14,000–14,400, and 28,000–29,000 kc. in the three bands. This means that the eleven tank circuits involved in the transmitter must cover a frequency range amounting to about 3% of the resonant frequency (100 kc. on 3.5 Mc., 200 kc. on 7 Mc., 400 kc. on 14 Mc., etc.). To help this coverage, advantage was taken of the fact that loading greatly broadens the tuning of any tank circuit, a high L/C ratio also helping in this respect. Seven of the tank circuits have been loaded sufficiently (tight load coupling) so that no tuning is required over the 3% range. For this reason the 802 and 6L6 plate tanks are tightly coupled to their loads. The grid tank of the 100TH is well loaded because of the low bias used on it. And the plate tank of the 250TH is broad because of tight coupling of the 7- and 14-Mc. links. Hence all these tank circuits are fix-tuned to the center of the 3% range. In spite of the broad tuning in these circuits, some variation in output takes place; but this has little effect because the excitation is more than ample at every point. Furthermore, none of the tubes is being overloaded, so that the slight off-resonance rise in plate current is not damaging.²

The final amplifiers present a bit different picture, since adjustments are more critical. Nevertheless, it was found possible to operate the 7-Mc. final plate tank fix-tuned because of the close antenna coupling (lower load impedance) required to load the tubes properly when working in parallel and at low plate voltage. The grid and plate tanks on the parallel 28-Mc. stage were also found broad enough to allow coverage of the lower half of that band. The tuning of the four remaining tank circuits is too critical to cover a 3% range, but they can cover up to 1½% of the

² In addition to considerations of output and efficiency, possible generation of spurious components as the result of off-resonance tank circuits must be recognized. Aggravation of r.f. harmonics is especially likely with circuits which are critical as to tuning, especially in the final stage. (See WIEAO's article on harmonic radiation, elsewhere in this issue.) Therefore, the practices regarding loading and tube operation described by W6CUH should be carefully observed—and certainly not misapplied in amplifiers working under different conditions. In any case, the final output should be carefully checked for spurious harmonic radiations over the various frequency ranges before putting the transmitter into regular operation.—EDITOR.

resonant frequency effectively. These four tanks include the plate of the 100TH which is only lightly loaded because of the high bias required on the following 250TH as a doubler; also critical is the tuning of the 7-Mc. final grid tank which must be held closer to resonance to compensate for running its plate fix-tuned. The other two are the grid and plate tanks of the 14-Mc. push-pull stage—both relatively sharp because push-pull grids present a higher impedance to the grid tank than parallel ones; the same thing being applicable to push-pull plates which require looser antenna coupling than when paralleled.

A very simple method is used to keep these four tanks close to resonance. All are first tuned to operate fix-tuned over the high-frequency half of each band in question. Then it is an easy matter to bring them all into correct resonance for fix-tuned work over the lower half of these bands by means of small receiving type midget condensers connected across one or two turns at the center of each coil. About 70 to 100- μmf . have been found sufficient in each case. It is thus possible to use such low voltage padding condensers even in the 14-Mc. final tank (requiring a 15,000-volt main condenser) because the voltage across one turn is relatively low. Once these padder condensers are set, change from one end of the band to the other is accomplished automatically by small relays that cut the padders in or out of action.

CONTROL RELAYS

The four relays in question are controlled by an extra set of contacts on the crystal selector switch. Thus the relays remain open for the two high-end crystals (3580 and 3600 kc.) and are closed when any of the low-end crystals are used (3500, 3505, and 3530 kc.). It is therefore only necessary to operate the one crystal selector switch to place the entire transmitter on that frequency. When using e.c. control instead of crystal, the same relays are controlled by a multi-point switch that is ganged on the same shaft with the e.c. tuning condenser. The switch contacts are arranged to cut in the relays and their associated padders when the e.c. oscillator is tuned (decreasing frequency) past the middle of the band. As a result, the entire transmitter

frequency is continuously variable by means of a single dial.

The padding relays, as well as the separate antenna change-over relay and receiver input shorting relay, are operated by the plate current of the 802-6L6 exciter unit. Thus the four relays



LOOKING INTO THE CRYSTAL-E.C. EXCITER UNIT

The 802 is on the right, the 6L6 on the left. Between them is the shaft ganging the e.c. tuning condenser on the front panel with the Yaxley switch attached to the back of the cabinet. At the lower left is the large condenser used to obtain high-C in the e.c. oscillator, and just behind it is one of the temperature-maintaining resistors. The knob controlling the 6L6 plate tuning condenser is just in front of the 6L6. On the lower right is the oscillator tank coil with the tuning condenser above it. The e.c. grid tank is in the back corner, to the right of the 802.

shown in the diagrams ($Re_1, 3, 4, 5$) are connected in series, Re_1 going to the Re_1 terminal in Fig. 2 and Re_5 to ground. The crystal and e.c. switches, Sw_2 and Sw_3 mentioned above, control the four relays by shorting them when it is desired to have the relays remain open. The band change relay, Re_2 , is operated from the keying relay supply as somewhat more contact throw is required.

The relays are all homemade, as is the antenna change-over relay, and merit description before going on with the rest of the transmitter. Fig. 1 shows the relay details. The magnets, one-inch long and a half-inch in diameter, are made from 3/16-inch stove bolts and 1/2-inch fibre washers (though almost any electromagnet core will do), wound full with No. 32 enameled wire for operation on the current of 100 ma. The magnets are mounted on a heavy strip of sheet metal (steel) bent at right angles as shown. Near the end of the

strip, a piece of No. 12 wire is supported by a bit of solder at each end so as to act as a bearing shaft for the sheet steel armature. The armature is a 1/2-inch strip of steel bent at right angles with the body of a 1/2-inch eyelet soldered to it in the vertex of the bend. The eyelet fits snugly over the No. 12 wire and provides a bearing for the armature. The vertical half of the armature comes op-

armature assembly, contact spring strips, padding condenser, and terminals are all mounted on a common bakelite base.

THE EXCITER UNIT

The complete circuit of the 802-6L6 exciter is shown in Fig. 2. The 802 operates as a conventional pentode crystal oscillator with switch

Sw_1 in the "xtal" position, and as a standard electron-coupled oscillator with the switch thrown to "EC." Sw_1 is a single-gang two-point four-circuit selector switch; it switches the grid and cathode of the 802, the crystal and e.c. indicating pilot lights, and the padding relays from the crystal switch Sw_2 to the e.c. condenser switch Sw_2 . When working e.c. the oscillator portion of the 802 is on 1.75 Mc. for increased stability, and the plate of the 802 is tuned to 3.5 Mc. to give satisfactory oscillation with the highest frequency crystal (3600 kc.).

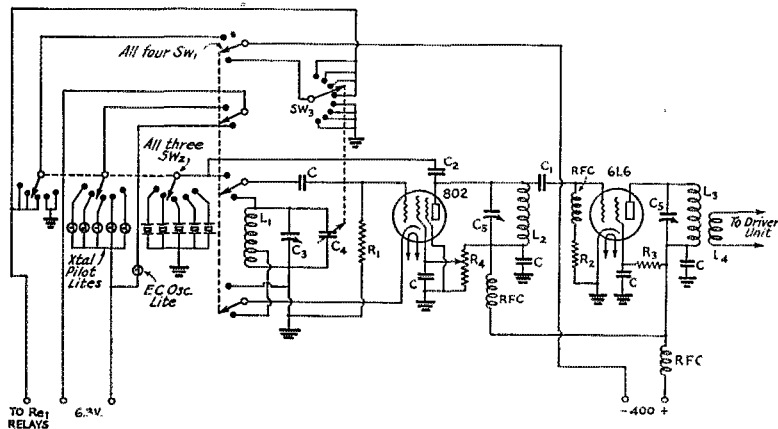

FIG. 2—CIRCUIT OF THE CRYSTAL-E.C. EXCITER UNIT

- L_1 —23 turns, No. 28 d.c.c. 3/4-inch diam. (See text.)
- L_2 —33 turns No. 28 d.c.c. on 1-inch diam. tubing.
- L_3 —25 turns, same as L_2 .
- L_4 —4-turn link around cold end of L_3 .
- C —0.002- μ fd. mica receiving type.
- C_1 —100- μ fd. mica receiving type.

- C_2 —3- μ fd. (See text.)
- C_3 —0.001- μ fd. three-gang BCL-type variable.
- C_4 —50- μ fd. midget (Hammerlund MC-50M).
- C_5 —50- μ fd. midget (General Radio).
- R_1 —100,000-ohm 1-watt.
- R_2 —50,000-ohm 1-watt.
- R_3 —20,000-ohm 10-watt.
- R_4 —20,000-ohm 25-watt.

- Sw_1 —Single-gang two-point four-circuit selector switch (Yaxley).
- Sw_2 —Three-gang three-circuit five-point selector switch (Yaxley).
- Sw_3 —Single gang single-circuit 11-point selector switch (Yaxley).
- RFC—2.5 millihenry r.f. choke (National R100).

posite the magnet pole piece and, when attracted to it, raises the other end to which is attached the bakelite strip that actuates the contact on a phosphor bronze spring strip. In the padding relays, these strips extend straight back from the armature about one inch to give the contacts sufficient throw, and also furnish enough insulation to withstand the full plate voltages on the contacts. All contacts are 1/8-inch diameter coin silver. The band-change relay has a two-inch bakelite strip to give a greater contact throw (1/4 inch) required to stand the r.f. between contacts when open for 7 Mc. The antenna relay is d.p.d.t. with a 3-inch bakelite strip mounted crosswise on the armature to actuate the contact-carrying springs located on each side of the magnet. The springs are fairly long and have the contacts soldered to their ends in order to obtain a contact throw of 1/4 inch. The magnet winding in both the antenna and band-changing relays is 2 inches long to give the greater pull required for the increased contact movement. The bakelite insulation in the antenna relay has proved sufficient; the r.f. developed across the 600-ohm line is not excessive. In each case the magnet-

The small feedback capacity C_2 consists of an insulated wire from the Sw_2 switch arm wrapped around the 802 plate lead, just enough capacity being used to obtain stable crystal oscillation. Note that when Sw_1 is on "EC," C_2 no longer couples the 802 grid to the plate, a condition which would be detrimental to stable e.c. operation. The 6L6 doubles to 7 Mc. and is quite conventional. Its output is carried through the link L_4 to the power stages by means of a 15-foot twisted-wire line cabled in with the power leads.

The two stages of the exciter are entirely contained in a National SRR cabinet with the exception of the crystals and the two switches, Sw_1 and Sw_2 . The five crystals are in a combination holder on the back of the cabinet which consists of a common bottom plate (2 by 6 by 1/4 inch aluminum) and five top plates. Sw_1 and Sw_2 are mounted just under the crystals and connected to the knobs on the front panel by extension shafts—a type of construction that gives short crystal leads. A box-like metal cover is arranged to screw on the back of the cabinet to protect crystals and switches from dust. A measure of temperature control is obtained by a small

10-watt wire-wound 1000-ohm resistor mounted on the under side of the aluminum crystal bottom plate. This resistor, and another just like it located inside the cabinet, are permanently connected to the 110-volt power line, and continuously maintain the crystal and entire oscillator at near operating temperature. The crystals especially are kept well above room temperature so that ordinary variations have little effect on the frequency.

The photographs show clearly the general physical layout of the 802-6L6 unit. Everything is solidly mounted and wired. The oscillator coil L_1 is particularly rugged; it is wound on a National GS-3 insulator and thoroughly doped. The switch Sw_3 can be seen attached to the inside back of the cabinet directly lined up with the oscillator condenser shaft. The mounting plate, shaft, and detent mechanism were removed from the switch, so that it is now operated by the metal fin soldered into the end of the extension shaft coupled to the e.c. tuning condenser. One of the photos also shows the transmitter control box carrying the main filament switch, send-receive

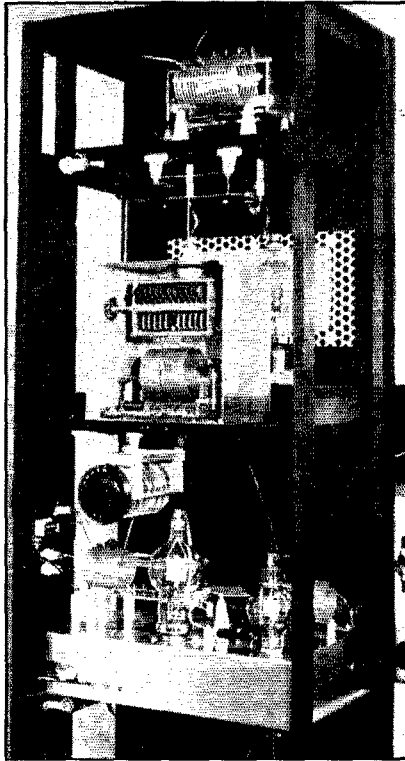

switch, band-changing switch, and the frequency indicating lights. Only two sets of lights are used, the 14-Mc. set doing duty for 28 Mc. also, because there was hardly room for more lights on this particular control box.

The performance of this unit leaves little to be desired. However, one or two precautions are in order. A shock absorbing mounting for the whole unit (four small sponge rubber pads glued to the bottom of the cabinet) is necessary to prevent vibration pick-up. The adjustment of the oscillator screen voltage by R_4 is important in reducing

REAR VIEW OF THE MAIN TRANSMITTER FRAME CONTAINING THE AUTOMATIC POWER DRIVER

The two-band tank of the 250TH is at the left, with the two links and the band-change relay mounted on the upright opposite the coil. The two 250TH's are behind the 7-Mc. grid tank. The condensers of the two-band tank are one behind the 250TH, the other just above it to the left.

frequency shifts resulting from line voltage changes (especially important if the keyed load "blinks" the lights excessively). Thus it has been easily possible to obtain e.c. controlled signals

(Continued on page 116)

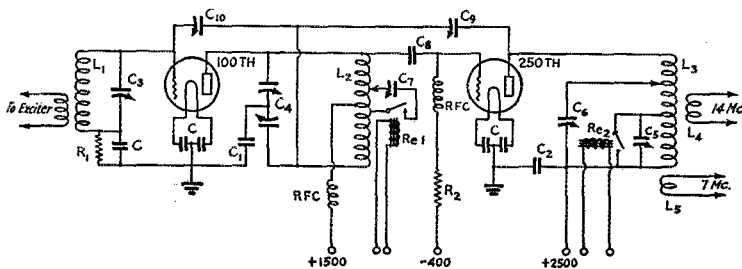

FIG. 3—THE AUTOMATIC DRIVER CIRCUIT

L_1 —14 turns No. 18 enameled, 2-inch diameter, unspaced.
 L_2 —23 turns No. 12 tinned, 2½-inch diameter, 3 inches long, air-wound.
 L_3 —18 turns, same as L_2 . C_5 tap at 11th turn, C_5 at 8th.
 L_4 —1 turn No. 12 tinned.
 L_5 —Same as L_4 .

L_6 —4 turns insulated wire over cold end of L_1 .
 C —0.002- μ fd. mica receiving type.
 C_1 —0.002- μ fd. 2500-volt mica.
 C_2 —0.002- μ fd. 5000-volt mica.
 C_3 —100- μ fd. midget (Hammarlund MC-100S).

C_4 —35-35- μ fd. 3000-volt (Cardwell MT35GD).
 C_5 —50- μ fd. 12,000-volt (National TMA50C).
 C_6 —Same as C_5 .
 C_7 —100- μ fd. midget (Hammarlund MC-100S).
 C_8 —Same as C_2 .

C_9 —Two plates, 2 by 3 inches.
 C_{10} —5- μ fd. (National NC800).
 R_1 —5000-ohm 3-watt.
 R_2 —30,000-ohm 50-watt.
 RFC —2.5-mh. r.f. choke (National R100).
 Re_1 —Padder relay. (See text.)
 Re_2 —Band changing relay. (See text.)

A Simple Directive Antenna

By Manfred Asson,* ES2D

AMATEURS living in the forlorn wilds of Eastern Europe usually have great difficulties in purchasing even the simplest short-wave equipment. Long-distance contacts actually carried out with flea-power, and the re-

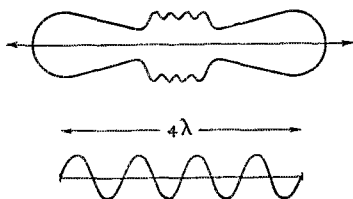

FIG. 1—CURRENT DISTRIBUTION AND APPROXIMATE FIELD PATTERN (FOR 25-DEGREE VERTICAL ANGLE) OF A FOUR-WAVELENGTH ANTENNA

ceivers are of almost prehistoric design. So it is only natural that in such conditions amateurs take refuge in more effective antenna systems.

As it may be of certain interest to some of the amateur fraternity in the U. S. what kind of gear we are using here, we jot down a few lines concerning an inexpensive unidirectional array for 14 Mc. with simple means for reversing its directivity. The basic idea is simple to understand. A long wire antenna of four wavelengths gives intensive low-angle radiation in line with its ends, the radiation angle being approximately 25 degrees (Fig. 1). This long wire makes by itself an effective bi-directional antenna. Still, to increase its efficiency and to reduce interference from the unwanted side we have to add a reflector.¹ This is done in a simple manner by placing a similar wire near it, so that its distance from the radiator is a quarter of a wave when viewed from the beam direction, that is, 25 degrees from the horizontal. It is evident from Fig. 2 that radiation will be greatest at the right side when the reflector is shifted to the left, and *vice versa*.

* Kloostri, 9-3, Tartu, Estonia.

¹ The principle of operation resembles that of the RCA Model B antenna. See Carter, Hansell and Lindenblad, "Development of Directive Transmitting Antennas," *Proc. I.R.E.*, October, 1931.—EDITOR.

That means, we may reverse the system's directivity by simply moving the reflector from the left to the right.

Now for the practical details. The radiator is 260 feet long, of hard-drawn enameled No. 14 wire, this gauge having proved sufficient to stand the strain when the location is not extremely stormy. This radiator was hung up about 40 feet above ground and its one end connected to the usual tuned feeder system. Ample space was provided between the antenna poles to allow sufficient reflector shift. Because a rather tight coupling resulted, the reflector wire had to be given a greater length; 268 feet was chosen, a length which while theoretically perhaps not the best, yet gives satisfactory results. The reflector was made of the same gauge wire and hung up exactly 8 feet below the radiator. Two halyards, a couple of pulleys and a weight made a simple arrangement for moving the reflector from the shack (Fig. 3), the ropes being adjusted so as to allow a total shift of 28 feet.

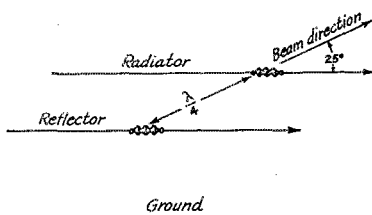

FIG. 2—ARRANGEMENT OF ANTENNA AND REFLECTOR FOR CONCENTRATING RADIATION IN ONE DIRECTION

No attempt was made to change the data given above, as the results were most gratifying when compared with the simplicity of the system. With the free end of the array pointed to northeast, Japanese and Siberian stations came in sometimes with S8 on a two-tube receiver, similar reports being obtained when the antenna was used on the 25-watt m.o.p.a. transmitter. On the other hand, South American stations came in con-

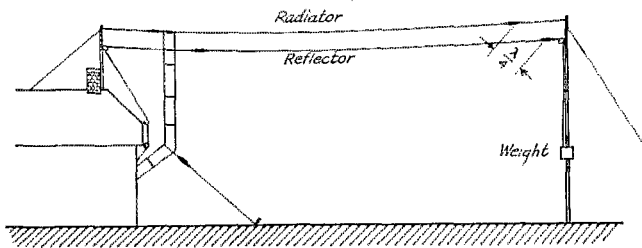

FIG. 3—SKETCH OF THE INSTALLATION AT ES2D, SHOWING THE METHOD OF MOVING THE REFLECTOR

sistently with the antenna directivity reversed. An S9 report was received from CX2AK and an S8 report from CPIAC, both with 25 watts.

(Continued on page 110)

Operating Notes on Power Crystal Oscillators

Safe Crystal Conditions for High-Power Beam, Pentode and Triode Tube Circuits

By J. M. Wolfskill,* W8QKT

THE oscillator circuits and tubes to which crystals may be applied are many and varied. The tubes used range from all types of receiving tubes to expensive pentode transmitting tubes. The receiving type tubes have many advantages insofar as having respect for the crystal, and frequency stability, is concerned; but because of their low-power output, a high-power transmitter using them in the oscillator stage is of necessity quite complicated. With the general trend being towards higher-power crystal oscillators, many high-power triodes as well as pentodes are being used in conventional oscillator circuits, as well as in less conventional circuits. This in a way is unfortunate, because many who try these tubes and circuits do not take adequate precautions in protecting the crystal.

It must always be remembered that a crystal is, of necessity, a frequency-control device, and, although it is generally advantageous to obtain just as much power from the crystal oscillator as reasonable, the crystal is often endangered by doing so. Improvements in tubes and newly developed tubes have greatly increased the available power from the crystal stage without driving the crystal very hard, especially if the rated voltages of the tubes are not exceeded. Tubes like the 2A5, 59, RK-23, RK-20, etc., have sufficient shielding between the grid and plate to prevent excessive feedback.

In an attempt to obtain high power from the crystal oscillator, amateurs have attempted to use tubes with low amplification factors and high inter-electrode capacities, such as the 210, with high plate voltages. Needless to say, the crystals were badly fractured. These experimenters did not give consideration to the characteristics of the tube, and the factors which determine its performance as a crystal oscillator.

Now the ability for a crystal to drive a given tube, and stand up under oscillation, depends on:

1. Amplification factor of the tube.
2. Plate-to-grid capacity of the tube.
3. Bias required.
4. Grid driving power required.
5. Activity of the crystal.

The amplification factor of a tube to be used as a crystal oscillator should be fairly high, since it determines the amount of energy which has to be fed back to the grid (assuming constant grid circuit losses) to start and sustain oscillations.

The amount of energy actually fed back to the grid circuit is determined by the plate-to-grid

capacity of the tube, and the r.f. voltage developed by the plate tank. Because of the high Q or low decrement of a crystal, very little feedback is required, and the plate-to-grid capacity of a high-power tube may be as low as $0.1 \mu\text{fd.}$ and the crystal will still start oscillating. It sometimes may be necessary with such tubes to add external feedback, in which case it can be controlled and varied until the crystal receives proper excitation.

An oscillator, whether crystal-controlled or

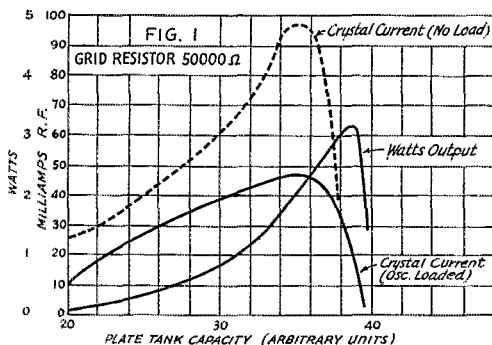

self-excited, has the ability to adjust itself to varied conditions. When the circulating current in the grid circuit is not important, as in a self-excited oscillator, the bias adjustments are not critical and the oscillator will adjust itself to wide variations. Naturally, there are optimum conditions for best operation and highest efficiency; but in attempting to obtain them we need give little consideration to bias adjustments and over-excitation.

In a crystal oscillator the bias on the tube and the method of obtaining it become important. The crystal current, for instance, can be fairly well controlled by varying the grid resistor and controlling the bias. In general, the lower the grid resistor, the higher the output and the lower the crystal current; and *vice versa*. As the result of zero bias in the non-oscillating condition, the crystal is often hard to start and will not key well when using too low a value. By resorting to cathode bias, in addition to a grid-leak bias, the crystal starts oscillating under a bias condition. This initial bias, if not too high, has a tendency to increase the effective plate-to-grid feedback, and also gives the tube a higher gain; all resulting in easier and more rapid starting of oscillations. At the same time, the low grid resistor acts to keep the crystal current and increases the power

* Billey Electric Company, Erie, Pa.

output. Too high a value of cathode bias will have the opposite effect, and make starting of oscillations difficult. The best resistance value to use varies from 200 to 500 ohms, depending on the tube characteristics.

This applies generally to pentode type tubes; for triode oscillators slightly different conditions

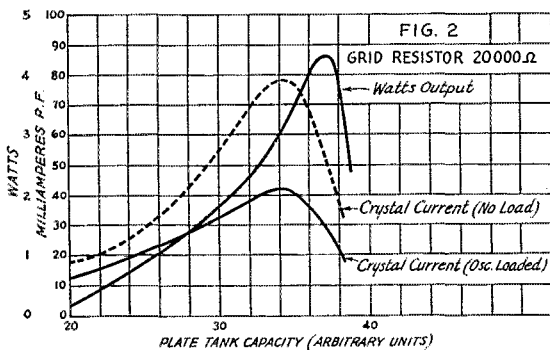

exist because the amplification factor of the triode increases with increasing plate current. For the pentode tube, the amplification factor passes through a maximum when the plate current is at a fairly low value. If plate current is increased beyond this point, amplification decreases rapidly. This will be discussed more in detail later.

PENTODE OSCILLATOR PERFORMANCE DATA

In Figs. 1, 2, 3 and 4, are shown curves of the crystal current and power outputs of a conventional pentode oscillator using a 2A5 tube under various conditions of both grid-leak and cathode-resistor bias. Although these curves were taken with a low-power pentode, they are generally representative of what happens with the higher power tubes under different conditions of bias. All measurements were made with a 7-Mc. crystal, with 200 volts on the screen and 350 volts on the plate of the tube. An r.f. choke was used in series with the grid resistor and, in the case of cathode bias, the choke was connected directly across the crystal. It will be noticed from Fig. 1 that the crystal current is higher than for any other condition, and that the current in the loaded condition is approximately half the no-load current. This is roughly true for conditions of Figs. 2 and 3. However, for Fig. 3 the current has been greatly reduced. Fig. 4 is interesting in that the crystal current remains practically the same in both the loaded and no-load conditions. Power output from the oscillator is greatest for conditions of Fig. 2. However, the oscillator in this condition did not key as well as when cathode bias was added. In Fig. 3, the power output is almost as high, and the oscillator keyed much

more readily, even with the low value of 10,000 ohms across the crystal. It will also be noticed that as soon as cathode bias is added, the plate current no longer has the familiar dip as the tank is tuned through resonance. The power output curves also broaden out as soon as cathode bias is added. This makes tuning and coupling to the plate tank less critical.

With a proper combination, then, of cathode and grid leak bias, the crystal current can be reduced and still maintain practically the same output. The fact that the crystal current drops as soon as a load is coupled to the oscillator shows how closely the crystal current is related to the r.f. plate voltage. These factors should be borne in mind when making measurements of crystal current. If the load should be removed at any time, the crystal current still should be below its rated value.

The grid driving power required by a tube furnishes another criterion for determining its suitability as a crystal oscillator. The lower this value, the lower can be the crystal current for rated output from the oscillator. Little, if any, gain in power output will result if the crystal current is increased beyond that normally required to excite the tube.

CRYSTAL ACTIVITY

Another factor which affects the performance of a crystal oscillator is the activity of the crystal itself. This often misconstrued term has been the source of controversy for some time, and to date

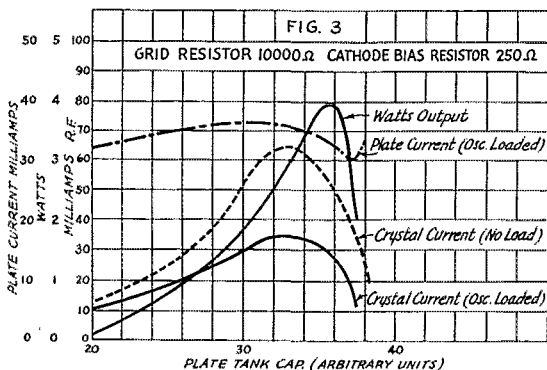

no definite standards have been set by which it may be defined. There are three separate and distinct quantities which determine the overall activity of a crystal and its consequent performance as an oscillator. First, the Q or decrement; second, freedom from coupling to other vibrations, and spurious frequency response; and third, its piezo-electric activity, or charge developed per unit of pressure. The last is dependent entirely on the manner in which the crystal is cut with respect to the crystallographic axis, and the

freedom from inclusions in the quartz. The first two can be well controlled by proper mounting and grinding.

In the manufacture of crystals, every attempt is made to make this overall activity as high and as uniform as possible. This has done much toward clearing up variations in characteristics which may occur between crystals of different manufacture. Uniformity in crystal characteristics is most important in transmitter design. A sluggish crystal might, for instance, require several times more feedback than an active one because of its higher equivalent resistance and consequent higher grid circuit losses. This same crystal might drive a given tube without excessive crystal current. But if it be replaced by a more active one, the crystal current may become high enough to shatter it. This seems contradictory and it would seem that the sluggish crystal would be the one to be desired. However, it will be found that the power output or the efficiency as well as the ability to key the oscillator will be much better with the active crystal if the excitation is, in some way, reduced. It is for these reasons that whenever a high-power tube is used as the crystal oscillator, some precaution should be taken to see that the crystal current does not exceed its rated value.

The best way to check the current through the crystal is to use a thermo-galvanometer in series with the crystal. This will give a constant check on the current flowing through it. The cost of such an instrument makes its use almost prohibitive to most amateurs. Alternatively, an approximation of the current may be made by connecting a low-current pilot lamp in series with the crystal. Standard radio pilot lamps with ratings of 6.3 volts at 150 ma. or 2 volts at 60 ma. can be used quite effectively. The 60-ma. lamp should be used for crystals rated under 100 ma. and two of these 60-ma. lamps in parallel for crystals rated over 100 ma. These lamps will then act as a protective device as well as give a rough check on the crystal current at all times. A 60-ma. lamp will burn out at about 75 ma. and two in parallel will burn out at about 140 ma. The resistance of these lamps is low enough so that neither the power output nor keying is materially affected.

A summary of the above discussion follows:

1. By varying the grid-leak resistor, it is possible to vary the crystal current over a wide range.
2. When driving a high-power tube, the grid-leak resistance should be reduced to a low value. If difficulty in keying results, cathode bias in addition to grid-leak bias will facilitate rapid starting of the oscillator.
3. Always use some means of measuring the current through the crystal. A small low-current pilot light will serve to indicate the approximate

amount of current and will act as a fuse as well. If difficulty with keying results, because of this added resistance, the lamp may be shorted out after preliminary adjustments.

4. Driving a crystal harder than normally required to drive the tube is simply a waste of power and endangers the crystal unnecessarily. Practically no increase in power output results by increasing the crystal current (with external

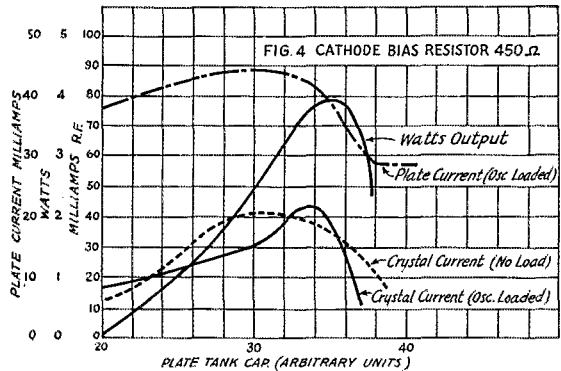

feedback) if the oscillator keys well at the lower value.

5. Always measure crystal current at no load and see that it does not exceed its rated value in the no-load condition.

TUBES AND CIRCUITS GENERALLY

It is to be expected that practically the only type tubes which would have large power outputs as crystal oscillators, and still have low inter-electrode capacities, would be the pentode types. Several triodes, however, have recently appeared on the market which can be used satisfactorily as higher-powered crystal oscillators if proper precautions are taken.

The 6L6 beam tube has fired the enthusiasm and started the trend towards high-power crystal oscillators with low plate voltages, more than anything else. Before that, the only means of getting large amounts of power from the crystal stage was by using high voltages and tubes such as the RK-20 803, etc. Another method of obtaining high power from the crystal oscillator was by using the lock system, in which a self-excited oscillator was locked to the crystal frequency over a small range of the tank tuning capacity. The locked oscillator never enjoyed much usage because of the difficulty of correct coupling to the crystal and the danger of crystal fracture. Also the oscillator was held in step over only a small range of tuning capacity; consequently, variation of load or too tight coupling tended to pull the oscillator out of step with the crystal. Such methods were obviously dangerous for the crystal. However, many of the high-power tubes now being used as crystal oscillators are just as

dangerous, unless proper precautions are taken. The 6L6 tube, for instance, has been used by many as a crystal oscillator and, because of its high-power output possibilities, it appears naturally adapted to simple and compact transmitter design. The plate-to-grid capacitance, however, is rather high, the shielding effect of the screen

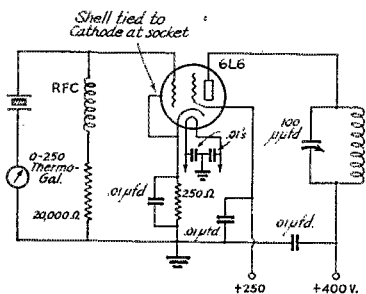

FIG. 5—THE BEAM TUBE CIRCUIT USED IN THE TESTS

being none too effective. This is evidenced by the necessity of neutralization when the tube is used as an amplifier; even as a doubler, trouble has been experienced with self-oscillation. It is an easy tube to excite, but because of its high amplification factor, difficulty with self-oscillation is encountered and this makes it difficult to use in some circuits.

Many other new tubes, as well as circuit variations, are making their appearance; when trying these new tubes and their circuit applications, anything which is a departure from a familiar setup requires every precaution possible to protect the crystal. This is true because of the difficulty of duplicating results with one setup, another with supposedly the same circuit may have his crystal shattered, unless he has it protected. In high-power crystal oscillators, if the crystal leads are just slightly longer or the position slightly different relative to the tank circuit, a large increase in feedback may result. Because of the high r.f. potential at the plate of the tube, variation of socket capacities may cause a wide variation in feedback to the crystal. For several of the newer tubes, the manufacturers state that external feedback should be used. Every attempt should be made to see that the circuit is working properly before this feedback is added. If the oscillator is properly constructed, with the correct voltages applied, practically all crystals will oscillate without external feedback.

THE 6L6 TUBE AS A CRYSTAL OSCILLATOR

The first tests conducted on the beam type power tube were made with the 6L6G. The performance curves were similar to those of any

pentode crystal oscillator, with the exception that the crystal current was abnormally high. The crystal current on a 7-Mc. crystal was 100 ma. with 400 volts on the plate and 250 volts on the screen. This was in the loaded condition and a power output of 25 watts was obtained. The normal rated crystal current through a 7-Mc. crystal is 100 ma., and as long as the oscillator was loaded this value was not exceeded. But as soon as the load was removed, the current rose to 175 ma., which is just about the breaking point of the crystal. With a 14-Mc. crystal, the r.f. current rose to 150 ma. when loaded, which is the rated r.f. current for this type of crystal. In all cases, with the load removed, the crystal current was anywhere from 50 to 75% over rated values.

Considerable difficulty was encountered in attempting to duplicate results, and the tube showed a tendency at times to go into self-oscillation. In order to remedy some of these troubles, all leads were made as short as possible, particularly the cathode connection to ground. The screen voltage was taken directly from a bleeder resistor in the oscillator power supply and was, at all times, kept below 275 volts. Any voltage above this caused the screen to run red, and in this condition the crystal would not start oscillat-

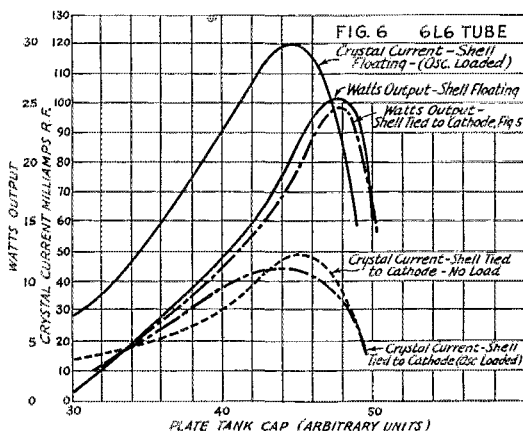

ing. Maintenance of the proper screen voltage remedied the tendency to go into self-oscillation and results were fairly consistent. However, the crystal current was still above rated values. The only safe bet with this tube is to reduce the plate voltage to 350 and screen voltage to 200 volts, using a cathode resistor of 250 ohms and a grid resistor of 10,000 ohms. Under these conditions, an output of 16 to 18 watts may be expected with either 7- or 14-Mc. crystals. Because of the greater thickness of 3.5- and 1.75-Mc. crystals, the crystal current did not exceed rated values even with the higher voltages on these lower frequencies.

If a metal-type tube is used, something can be

(Continued on page 66)

Amateur Applications of the Static-Type Velocity Microphone

Automatic Low-Frequency Restriction on Close Talking; Experimental Feed-Back Control Circuits

By Paul von Kunits*

THE amateur searching among the family of receiving tubes available to-day is apt to hold his head in his hands and long for the good old days when the 201-A was about all there was. Nevertheless, he is glad to find the tube which exactly fits his needs. He is coming to be faced with the same situation when he sets out to choose a microphone. There are available the single- and double-button carbon, condenser, dynamic, non-directional dynamic, magnetic velocity type in high- and low-impedance, the crystal sound cell, and crystal diaphragm type microphones. Now we have another member added to this family: a velocity microphone employing a static instead of a magnetic field and with many distinct characteristics of its own. The new type is known as the "Velotron." This microphone shows much promise in its application to the ham field and there is a great deal of experimental work to be done with it in this direction.

In the magnetic type velocity microphone a ribbon is suspended between the poles of a magnetic system. When speech energy causes the ribbon to move it cuts the magnetic lines of force and thus a voltage corresponding to its movement is induced in it. Since the ribbon has an extremely low impedance, it works into an immediately adjacent step-up matching transformer, the secondary of which may be of whatever impedance it is desired to have.

In the static velocity microphone there is neither magnetic field nor transformer. A number of ribbons, rather than a single ribbon conductor, are rather loosely laid across a perforated and totally insulated conducting back plate in such a manner that certain parts of each ribbon are free to move. A voltage difference is maintained between the ribbons and back plate by means of the d.c. supply circuit as shown in Fig. 1. When the ribbons move they alter the capacity between themselves and the back plate, varying the charging current through the resistor R_1 and causing a voltage drop across it which is proportional to their movement. Their movement is proportional to the velocity component of the sound input. Hence, the voltage across the resistance will

be an electrical translation (of the speech) which may be applied to the grid of any tube at the output of the microphone. It may be noted that whereas in a dynamic or magnetic type velocity microphone the only energy available in the circuit is the actual energy of speech, in this case the microphone is acting as a valve which controls the energy available from the d.c. supply. Therefore, it is possible to get considerably greater electrical output from the device than there would be if it were a direct translator of the incoming acoustic

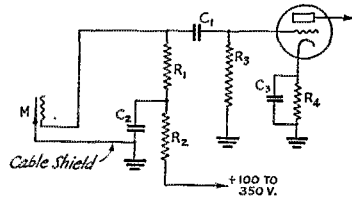

FIG. 1—STANDARD INPUT CIRCUIT FOR THE STATIC-TYPE VELOCITY MICROPHONE

- R_1 —5- to 10-megohm input coupling resistor.
- R_2 —5- to 10-megohm polarizing voltage filter resistor.
- R_3 —1- to 5-megohm grid coupling resistor.
- R_4 —Cathode resistor to suit tube used.
- C_1 —0.006- to 0.02- μ fd. mica coupling condenser.
- C_2 —0.1- to 0.5- μ fd. polarizing voltage filter condenser (paper).
- C_3 —Usual cathode by-pass condenser.
- M—Velotron microphone.

energy into electrical energy. The output level is at present on the order of -45 db.

The static type is a true velocity microphone having the typical characteristics of high directivity and uniform frequency response. In a velocity microphone it is necessary that the sound waves be allowed free passage through the unit; thus, if the back of the microphone is closed off the output is very materially affected. The unit is responsive on two sides in the familiar "figure-eight" pattern of the velocity microphone but has a slightly wider angle of response than most velocity types and a very sharp cut off beyond this point. It may be brought out here that in a true velocity microphone the frequency characteristic of the output does not change materially with the angle of incidence of the sound to its face as it does in a pressure type using a diaphragm. This makes its use less critical in ham

*Bruno Laboratories, Inc., 30 West 15th St., New York City.

work, since it is not necessary for the sound to hit the microphone directly or at any special angle in order to retain high-fidelity characteristics. Its highly directional response makes it very applicable to use in noisy locations, since sounds approaching from either side of the microphone are not effective. Such a response pattern is almost

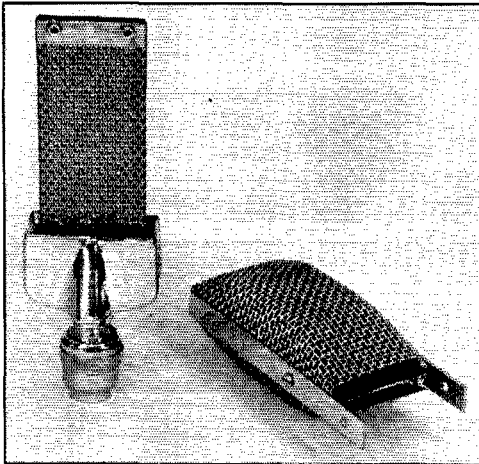

THE OUTSIDE PROTECTING GRILLE REMOVED TO SHOW CONSTRUCTION

essential in public address work where the "dead" sides of the microphone may be placed towards the loud speakers in order to minimize acoustic feedback.

AUTOMATIC LOW-FREQUENCY RESTRICTION

The ordinary ribbon microphone suffers from one difficulty in that it cannot be used for close talking without an unnaturally great increase in the low-frequency output. This may take place when the source of sound approaches nearer than 3 feet from the unit. Thus when a person speaks too closely to a typical ribbon microphone, the low frequencies are brought up to such an extent above the highs that the output becomes "boomy." Manufacturers faced with this problem in p.a. work have resorted to greatly reducing the low-frequency response of the microphone purposely. Thus when the speaker "climbs" into the unit the output is still passably clear because the unnatural reinforcing of the low frequencies which results from the pressure component of the sound, makes up for the deliberately curtailed low-frequency response of the microphone itself. The Velotron is able to overcome this difficulty because it has an adjustable frequency characteristic, the behavior of which is very peculiar and rather interesting. At low-polarizing voltages of approximately from 50 to 150 volts, the ribbons are barely attracted by the static pull

between themselves and the back plate, and thus are very free to move even at the relatively great amplitudes required by the low-frequency components of the sound. In other words, the movement of the ribbons is unrestricted; therefore, the microphone behaves as a true velocity microphone having a frequency response extending from lower than 20 cycles to higher than 14,000 cycles. (There is no transformer to affect the fidelity of the output of the ribbon.) But if, under these conditions, the microphone is used for close talking, it will give an unnaturally exaggerated low-frequency response. However, if the polarizing voltage is increased the ribbons are attracted with some force to the back plate at predetermined raised points which break them up into a number of smaller ribbons whose amplitude of movement is restricted at the low frequencies. Therefore, the low-frequency output of the microphone cannot be driven above a certain point. Thus on close talking a natural output is obtained without sacrifice of normality in output when the same microphone is used for relatively weak sound inputs. It is important to note that this is a restriction on *maximum* low-frequency output and that the restriction does not occur until such a maximum has been obtained. The effect to the ear is as if the high-frequency output had been raised. If the polarizing voltage is further increased the restriction becomes such that there is an actual increase of the high-frequency output over that of the low end of the scale. It might be remarked that as the polarizing voltage is increased the output of the microphone is also increased because of the greater electronic charge accumulated between the ribbons and back plate. In normal operation,

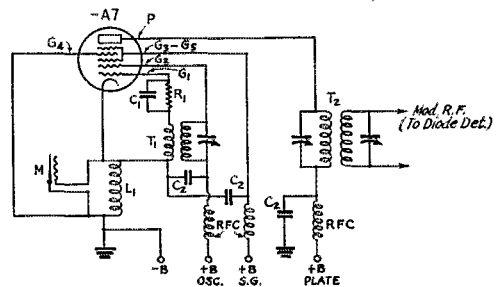

FIG. 2—EXPERIMENTAL R.F. FEED-BACK CONTROL CIRCUIT

- M—Velotron microphone used as feed-back control.
 - The average capacitance of the microphone with its cable is approximately 800 μfd .
 - L₁—Cathode coil having inductance to resonate to oscillator frequency in combination with capacitance of M. Approximately 1 millihenry for 175 kc.
 - T₁ and T₂—Standard i.f. transformers tuned to the desired working frequency (175 kc. in experimental tests).
 - C₁—Oscillator grid condenser, 500- μfd . or so.
 - C₂—R.f. by-pass condensers, 0.01- μfd . or larger.
 - R₁—Oscillator grid leak, 50,000 ohms or so.
 - R.F.C.—125-millihenry r.f. chokes.
- As suggested in the text, the oscillator might be crystal controlled for better stability and worked at a higher frequency.

a voltage of from 200 to 300 volts is recommended and voltages as high as 400 volts may be used.

The action of the microphone with close talking is of great importance to the amateur because the usual practice is to minimize the number of audio stages, making it necessary to speak relatively close to the microphone in order to get sufficient output for modulation; and it seems to be a perverse human habit (probably fostered by the

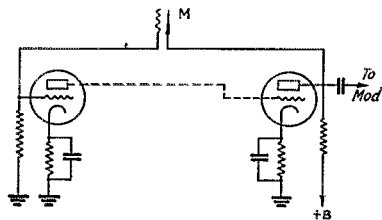

FIG. 3—ILLUSTRATING THE METHOD OF USING THE VELOTRON IN AN AUDIO-FREQUENCY FEED-BACK CIRCUIT, BETWEEN THE OUTPUT AND INPUT OF A SPEECH AMPLIFIER

use of the telephone) to "climb" into a microphone and yell, a procedure which in these days is certainly far from necessary. It has been shown by the Bell Telephone Laboratories that roughly 90% of the energy in speech occurs at frequencies below 500 cycles and that roughly 90% of the intelligibility of speech is carried by the frequencies above 500 cycles. Therefore, when modulating a transmitter, the high-amplitude swings are brought about by the low frequencies and the swings caused by the high-frequency components are quite small. If a microphone on close talking gives an abnormally great low-frequency output, the high frequencies which carry the intelligence of the speech may be considered as proportionately reduced. Therefore, with 100% modulation as our limit the effectiveness of the transmission is cut down below what it would be if the low frequencies were not unduly accentuated because it is these low frequencies which are swinging the r.f. output to its maximum amplitude—which automatically limits the permissible swing for the lower-energy high frequencies. If under these conditions we substitute a microphone having a normal or slightly less than normal low-frequency response, the proportionate difference between the low-amplitude high-frequency swings and the high-amplitude low-frequency swings will be greatly reduced. Since our maximum energy is limited, we have thus increased the energy available in the high frequencies which, after all, are doing the principal work in carrying the intelligence.

The restriction of the possible low-frequency output is also of great help in avoiding over-modulation as the distance between the speaker and the microphone is varied. Suppose yourself to

be talking into the microphone at a distance of three inches and producing 100% modulation. You relinquish the microphone to your friend who talks at the same voice level but decreases the distance between himself and the microphone by one inch. In a microphone having unrestricted low-frequency output, the low-frequency energy reaching the microphone thereby could be increased, and might cause over-modulation—which immediately calls down all the curses of the fellows on adjacent frequencies. However, with restricted low-frequency output this would not occur, presuming that the limit of low-frequency response has already been reached in the first instance. Before leaving the subject, it might be noted that the velocity microphone is not the only type to suffer abuse through close talking, since in the diaphragm-type microphone this practice may result in acoustic pressure-doubling on the diaphragm and severe harmonic distortion.

THE INPUT CIRCUIT

In Fig. 1 is shown the standard Velotron circuit. The values of resistance and capacity given are not in the least critical. For maximum output and best frequency response, high values of coupling resistance should be used, although a change from a 10-megohm to a 5-megohm resistance will be hardly noticeable, and change from a 5-megohm to a 1-megohm resistance will cause only a minor reduction in output. In figuring the effect on frequency response of the coupling resistances and the coupling condenser, the circuit may be thought of as a normal resistance-coupled amplifier with the high impedance of the microphone substituted for the plate impedance of a tube.

The microphone has no current drain and, therefore, the polarizing voltage can be very easily filtered. The purpose of R_2 and C_2 in the diagram is to accomplish this filtering of the voltage. With the values shown, the filtering is so effective that it is often possible to take the polarizing voltage for the microphone directly from the output of the rectifier of the amplifier with which it is being used. Lower values of resistance and capacity may be used with decrease in efficiency of the filter circuit. The values are not critical.

It is important that the filter condenser used be a good paper condenser and that the coupling condenser be a good mica condenser. Leakage in these circuits resulting from faulty condensers will cause very noisy operation. The quality of the low-capacity cable used is also of great importance, since the microphone has a high impedance. With a good low-capacity cable, it is possible to run a 500-foot length between the microphone and its associated amplifier without a very noticeable loss in high-frequency response, although the overall output of the microphone is

(Continued on page 82)

How Would You Do It?

Announcing the Second in the Series of Prize Practical Problems

IF SOLUTIONS and would-be solutions to the first problem of our problem contest continue to arrive at the present rate, the editorial staff will have to quit producing a magazine and devote all of its time to a study of the material. We always thought the ham really got geared up the moment he had a problem to battle with. Now we know it. Maybe the first problem looked too easy. Perhaps the response to number two of the series will not be as heavy. In any case, we are in for a tough job picking winning solutions from the first batch. They will be announced, however, in March *QST*.

And now, gang, the second in the series, with the lurid details given in the adjoining column.

And here is the dope on the rules and prizes, repeated for the benefit of those who may have missed the last issue:

1. Solutions must be mailed to reach West Hartford before the 20th of the publication month of the issue in which the problem has appeared. (For instance, solutions of problem given in the February issue must arrive at *QST* before February 20th.) They must be addressed to the Problem Contest Editor, *QST*, West Hartford, Conn.

2. Manuscripts must not be longer than 1000 words, written in ink or typewritten, with double spacing, on one side of the sheet. Diagrams and sketches may be in pencil, but must be neat and legible.

3. All solutions submitted become the property of *QST*, available for publication in the magazine.

4. The editors of *QST* will serve as judges. Their decision will be final.

Prizes of \$5 worth of A.R.R.L. station supplies or publications will be given to the author of the solution considered best each month, \$2.50 worth of supplies to the author of the solution adjudged second best. The winners have the privilege, of course, of stating the supplies preferred.

—R. A. H.

Problem No. 2

OUR hero, feeling certain that a good solution to his receiver protection problem will be forthcoming, has decided to build a new push-pull final amplifier. It must have, as its main feature, front-of-panel band switching, preferably operating with a single knob although two are permissible. He does not intend to switch to any predetermined frequency in each band but merely to shift the tuned circuits to any of three bands, then tuning to the exact frequency by means of the usual tank condensers. The amplifier will have a tuned grid circuit, transmission line coupled to the driver and a transmission line from the output circuit to the antenna tuner.

Our friend is anxious to reduce harmonic radiation to a minimum and insists that the transmission lines must be coupled to a low-potential point on each tank. The transmission lines may be coupled either inductively or tapped across the tank coils, but balance must be kept with respect to the center of the tank. Further, he insists that the band switching must be accomplished without introducing undue losses in the switching system. Hence if sections of the tank coils are shorted the shorting must be done at the center of the coils where the r.f. potential is lowest.

The method must be simple, easy to build, and must use the smallest possible number of switches. The obvious method, using eight switches, is, he thinks, too expensive and too complicated mechanically. He is willing to make special switches if they are easy and cheap to build. The amplifier is to use triodes and it is imperative that the neutralizing be undisturbed by band changing. The system must be capable of carrying at least 500 watts of r.f. power and the transmission lines must be insulated from the grid and plate d.c. Lastly, the amplifier must not take up a great deal more room than one with plug-in coils and, since it is a panel job, must be arranged to fit a relay rack.

Our pal is hoping for some really hot idea. It is his personal problem but he realizes that it is a very general and a very important one.

Silent Keys

It is with deep regret that we record the passing of these amateurs:

John W. Greig, Dayton, Ohio.
George J. Holt, W7EJO, Portland, Ore.
Franklin Huzzard, W3FNB, York, Pa.
Howard C. Maus, W6KOA, Ganado, Ariz.
Th. Wilmlink, PAØTW, Groningen, Netherlands.

Pi Harmonics

When is a pi-network not a low-pass filter? Well, one answer is, "when it is designed to be a high-pass filter"; and another is, "when it is designed to look like a low-pass filter but transmits harmonics away up and beyond its supposed cut-off frequency." In other words, low-pass pi on paper in a schematic diagram doesn't necessarily stay low-pass when something other than the intended termination is tied onto the network coupling a transmitter to its antenna. Dr. Ray Woodward, W1EAO, tells the interesting and illuminating story in his article on spurious harmonic radiation elsewhere in this issue. "Doc" works days researching on noise-silencing for typewriter tapping and such things in Underwood Elliott Fisher Company's laboratory, (he's a doctor of the scientific variety, not medico), and uses his home time in constructive efforts to silence some of the spurious emanations of ham transmitters. Don't pass up his article. It may save you a pink ticket.

Hi Efficiency

Amateur radio is full of "hi" these days; high power, selectivity, directivity, from C to Z. High efficiency has become something of a fetish, and anything contributing to its attainment is of high interest to all of us. One such thing is the high-efficiency linear amplifier for 'phone, developed in the Bell Telephone Laboratories and presented by that organization's Mr. Doherty at the 1936 annual I.R.E. convention. Pre-convention releases were instrumental in whetting everyone's thirst for more information. And the Doherty paper got more attention at its delivery than any other on the program. We followed it closely always with an eye to the ham angle, but must admit that we left the meeting with some misgivings as to the practical possibilities of the new circuit in amateur 'phone transmitters. Undoubtedly it looked fine for high-power (50-kw. and up) broadcasting on the medium frequencies. A big saving on the power bill, as compared to the operating cost of a conventional Class-B linear of equivalent output, meant money in the pocket to station operators who must think in terms of revenue per hour *versus* kilowatt hours. The fact that the installed tube capacity must be practically the same as the peak power capacity in a Class-B linear of the same carrier output was not, apparently, a factor of major importance to broadcasting people. But what of the amateur point of view? Wasn't tube first cost of major

moment to us, and power consumption, even with our 1-kw. maximum final input, a secondary matter? The obvious advantage of obtaining twice the carrier power output (600 watts) that could be obtained with low-level modulation and conventional Class-B linear amplification, with maximum input restricted to 1 kw., seemed to be its real justification in our field. Against this there stood considerable circuit complication, and no specific information concerning the feasibility of the new amplifier for frequencies higher than the broadcast band. Would it work at all for us? Well, it will work—has been made to work, in fact—at amateur 75-meter 'phone frequency. W9AHH gives the details, and an excellent explanation of the principles involved, in his article elsewhere in this issue. As he says, the job isn't one for a beginner to cut his teeth on. Even though it may develop that the high-efficiency linear will not attain immediate adoption and cannot overcome the competition of plate-modulated Class-C systems in our field, every progressive amateur must give it consideration and know something about its operation. It is not too much to hope that from it we may realize simpler modifications of wide utility and equal performance. This is a serious article deserving the serious consideration and study of advanced amateurs.

Tuning DX

When most of us think of DX success, we visualize a 1-kw. rig working at almost the smoking point in one corner of the shack, permanently parked on a "good" frequency on 40 or 20. Not all of us, however. Take Charlie Perrine, sleepless wonder at W6CUH. Certainly, Charlie likes his high power, diamond antennas and Squeezed-Selectivity receivers. But, he insists, that isn't all. You can't work them with all the power in the world if your frequency isn't right where they are tuning. So he adds another prerequisite for successful DX working—the kind that measures results in contacts per hour, not hours per contact. It's frequency flexibility in the transmitter, and darned convenient operating flexibility at that. It may take more effort to build it into the transmitter than most of us would make without urging. But look at all the operating effort we'd have to spend plugging in and out coils, retuning tanks and tipping over chairs if we tried to get the same results *without* having it built into the rig to start with. He tells all in his article starting in this issue.

—J. J. L.

HINTS and KINKS

for the Experimenter



Output Coupling Method

THE coupling system of Fig. 1, suitable for working into an antenna or feeder system or into any type of load for a power tube (dummy antenna for testing, or feeding the grid of a following stage, etc.) is suggested by Walter Van B. Roberts, W3CHO. Outlined below are his adjustment procedure and a résumé of the advantages of the arrangement. To adjust:

1. Reduce M (the mutual coupling between the plate tank coil, L_1 , and pickup coil, L_3) to a negligible value and adjust C , the amplifier tank condenser, for minimum plate current.

2. With Z (any impedance such as that represented by antenna or feeders, a following tube grid circuit, etc.) disconnected and M very small, tune A , the secondary variable condenser, to resonance, as evidenced by a slight increase in plate current.

3. With Z connected across a small part of the secondary inductance, retune A to cause an increase in plate current. Connecting Z increases the effective resistance of the secondary so that M may have to be increased to obtain a noticeable increase in plate current as A is varied to retune the secondary circuit (which now includes the effective reactance introduced by Z).

4. Connect Z across more of the secondary and retune. Continue this process until Z is across the whole coil or across so much of it that the circuit can just be tuned comfortably by A .

5. Finally, increase M until rated plate current is drawn and make a final readjustment of C to be sure the plate current is minimum with respect to the setting of C . If at maximum M the plate current is still too low, it may be brought to normal value by bringing the taps for Z on L_2 closer together. The preferable method, however, is to increase M , either by closer physical coupling between L_3 and L_1 or adding a turn or so to L_3 .

The reason for the fourth step in the outline above is to reduce the circulating current in the secondary. If there were no resistance in the secondary circuit except that introduced by Z , it

would not matter where the taps were placed so long as the secondary could be tuned by A .

The system has the following desirable features:

1. It will match a wide range of complex impedances to the optimum tube plate load resistance; that is, it permits using nearly any sort of load for Z .

2. The antenna and matching network are isolated from the high-voltage d.c. without requiring expensive blocking condensers.

3. It works equally well from a single-ended tank to a balanced load or vice versa, or from balanced tubes to balanced load or single-ended stage to unbalanced load. A small amount of incidental capacity coupling between tank and secondary is not objectionable since it merely increases or decreases the effective M slightly.

4. It requires only one condenser in addition to the regular tank condenser.

5. Since the secondary is tuned to give maximum plate current, any accident to the antenna (short circuit or the like) which detunes the secondary causes the plate current to drop rather than increase, as can happen in some arrangements. This protects the tubes.

6. The adjustments are substantially independent rather than interlocking—as in the low-pass filter type of impedance-matching network, for example. Thus it is easier to understand and carry out the adjustments.

The only drawback to the system is the variable mutual coupling. At W3CHO, the coil L_3 consists of two turns of heavy wire mounted on a hinged block of bakelite, the hinges acting as connections to the rest of the circuit. The same coil is used for 20-, 75- and 160-meter operation. The diameter of the turns is large enough to allow them to swing off the tank coil (a 1½-inch diameter plug-in form) for very loose coupling. With larger-diameter tanks the coupling coil could be slid inside. In push-pull circuits, for complete symmetry the tank coil could be split into two parts, with L_3 a spider-web type coil slid or hinged into the slot between the two halves of the tank coil.

Regarding circuit constants, the prime requisite is that the secondary should be tunable to the

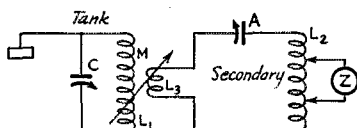

FIG. 1—AN OUTPUT COUPLING SYSTEM WHICH PERMITS MATCHING A WIDE RANGE OF COMPLEX IMPEDANCES TO THE OPTIMUM TUBE LOAD RESISTANCE

Adjustment and constants are discussed in the text.

transmitter frequency. A 100- μ fd. condenser should suffice for practically all bands at *A*, and the inductance of the coil L_2 should be chosen so that the unloaded resonance setting of *A* does not

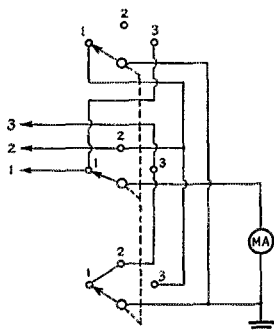

FIG. 2.—A METER-SWITCHING CIRCUIT FOR HANDLING THREE STAGES

A three-pole, three-gang switch is required.

fall too near either minimum or maximum capacity. This will give some leeway in adjustment as the load is increased and thus permit compensating for the reactance, if any, introduced by the load. With a purely resistive load, the setting of *A* should be practically the same either loaded or unloaded, provided the loading is not carried beyond the optimum point.

— . . . —

Meter Switching

THE circuit of Fig. 2 shows a meter switching arrangement used by Ted Hansen, W9IX, for shifting a milliammeter to any one of three circuits. A three-pole, three-gang switch does the job. The meter is connected in the cathode circuit of each tube, the extra gangs being needed to complete the cathode circuits of the un-metered tubes.

In common with all circuits in which the meter is in the cathode circuit, in this arrangement the current reading is that of the total tube

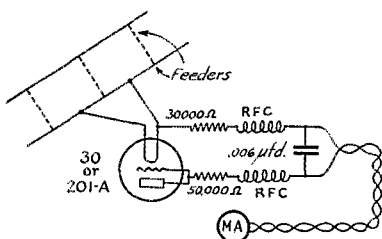

FIG. 3.—AN R.F. CURRENT INDICATOR USING A VACUUM TUBE AND D.C. MILLIAMMETER

A 0.1 ma. meter will be most sensitive, although larger sizes may be used. With instruments of greater range, a "B" battery may be needed to increase the sensitivity.

space current. With triodes, the sum of grid and plate currents is read; with screen-grid tubes, the screen current also registers simultaneously with the grid and plate currents.

Tuning Indicator

THOSE who have low-range d.c. milliammeters but lack r.f. ammeters will find this kink, contributed by Norman Bush, VE3KW, of interest. It uses the aforesaid d.c. meter in combination with a tube and a few spare parts to provide comparative indications of r.f. flowing in feeders.

The circuit diagram is given in Fig. 3. Note that the filament of the tube (any type which will work on fairly low filament current) is clipped across a short length of feeder. The rectified current, therefore, depends to a considerable extent on the filament temperature as well as upon the difference in r.f. potential between one end of the filament and the diode element consisting of grid and plate tied together. The chokes and by-pass are for the purpose of keeping r.f. out of the meter; VE3KW also found the resistors indicated to be necessary to prevent overheating of the chokes. The arrangement has worked out to be quite sensitive indicating instrument for tuning purposes.

The most pronounced change in meter reading for a small change in feeder current will occur when the filament is somewhat below normal operating temperature. The spread between the clips attaching to the feeder should preferably be such that the maximum current will cause the filament to come up to approximately normal temperature. Naturally, the spread will depend upon the type of tube used and the magnitude of the feeder current, and must be determined by experiment.

— . . . —

Another Use for the Auto Transformer

PROBABLY a good many of our readers, especially those troubled with poor line voltage regulation, will recall the article on using an auto-transformer for matching up filament voltages and compensating for line-voltage changes.¹ We now have a letter from W4IS in which he describes another use to which he put the same auto-transformer. Here it is:

"I wanted sufficient bias to key the transmitter (the oscillator and buffer are simultaneously keyed) with complete blocking of the final and preceding amplifier when the key was raised. Now the 805 final draws some 40-80 mils grid current and therefore calls for a supply of good regulation. About 60 volts or maybe as much as 80 volts with full plate voltage is needed to cut off the 805. Additional bias for Class-C 'phone operation was needed and is readily obtained with a grid leak. That is to say I employ combination bias, but it was requisite that the 'C' supply be sufficient completely to block the

¹ Blitch, "An Improved Method of Voltage Control," QST, August, 1936.

805 (and 804 driver). Now the very first obstacle was the proper transformer to supply this bias. It was evident that a heavy 'C' supply using a heavy-duty receiver transformer would be all

line only, the meter would not read as the return circuit would be through the earth. Under these circumstances, the voltage would be low unless both grounds were low resistance contacts to earth. Most power company services, today, are three-wire and designed to forestall such theft of current."

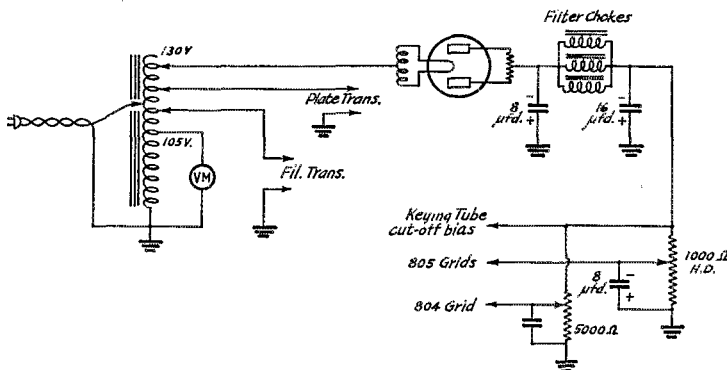

FIG. 4—USING THE AUTO-TRANSFORMER TO PROVIDE "C" BIAS FOR THE TRANSMITTER

Using an auto-transformer giving a maximum of 130 volts, bias voltages up to 130-150 will be available at good regulation under varying grid currents. This order of voltage will be ample for the high- μ tubes now becoming popular.

The diagram of the "C" supply used by W4IS is given in Fig. 4. A 5-volt transformer of course is necessary to supply the filament of the 83. Enough b.c.-type filter chokes are used in parallel to carry the current safely; this current should be between 125 and 150 ma. with the 1000-ohm bleeder resistor. The voltage input to the filter can be adjusted over a rather wide range by selecting suitable taps

too wasteful of power. To make a long story short, I got the bias off the regulating transformer. This led me to ground the grounded side of the a.c. line to the frame (cabinet) of the transmitter. I connect to the power line with a H.D. polarized plug. Every steel panel is soldered or heavily bonded to every sub-panel, and every panel is securely connected to the frame which in turn is securely grounded to earth. I have found no objection in practical operation or in theory to

on the auto-transformer.

The Two-Tube Receiver on Ten Meters

ANTENNA coupling to a regenerative detector on 28 Mc. often can be quite critical, as many users of such receivers have found out. A suggestion from Adolfo Dominguez, Jr., CM2AD, should be of help. Using the two-tube receiver described in June, 1934, *QST*, and in the *Handbook*, he had difficulty in making the detector oscillate with an antenna connected, although the set functioned normally without the antenna. The cure was to connect a 50- μ fd. variable in the antenna lead, as close to the antenna post on the set as possible. Adjustment of the condenser will result in a setting which will give good coupling and strong signals with the detector in a satisfactory oscillating condition. It was found necessary, however, to have the condenser right at the antenna post—connecting it in the antenna lead even but two feet away from the set brought on the same trouble again, evidently because the short length of wire loaded the detector so heavily that it could not oscillate.

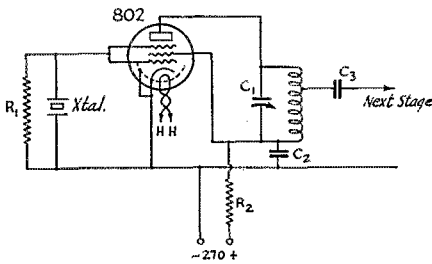

FIG. 5—MODIFIED CRYSTAL OSCILLATOR CIRCUIT

- C₁—50- μ fd. variable.
- C₂—0.03- μ fd. bypass for plate and screen.
- C₃—0.001- μ fd. coupling condenser to following stage.
- L₁—For 160 meters, 55 turns on 2-inch diameter form, tapped 30 turns from bottom for coupling to following stage.
- R₁—175,000 ohms.
- R₂—1000 ohms, 1-watt (protective resistance).

this connection. However, I want to call attention to the fact that it might possibly be objected to by power companies in some localities. If the service to the house is two-wire and if the transmitter is connected to the 'hot' side of the a.c.

A Modified Crystal Oscillator Circuit

THE crystal oscillator circuit used in conjunction with pentode tubes often requires the use of a feed-back condenser from plate to control grid, particularly at the lower radio frequencies, for stable oscillations. In certain tubes such as the 802, which has the grid pin on the base and the plate clip at the top of the glass envelope, this requires a rather messy mechanical construction.

Further, the optimum feedback coupling capacitance is quite definite; too low feedback lowers the tube output and too large a feedback unduly strains the crystal.

In the circuit shown in Fig. 5, these objections have been overcome. The suppressor-grid is connected directly to the control grid, the suppressor-to-plate capacitance acting as the feedback condenser. This eliminates the feedback condenser and simplifies mechanical layouts. A further function of the suppressor grid, however, is to limit the amplitude of oscillation: strong crystal oscillations imply a large negative bias on the suppressor-grid as well as on the control grid, thus tending to reduce the tube transconductance and gain, and lowering the amplitude of oscillations until an equilibrium position is obtained.

The constants shown in Fig. 1 are quite satisfactory at 1650 kc. and the oscillator provides more than sufficient excitation to a pair of RCA 802 tubes in parallel as suppressor-grid modulated class C r.f. amplifiers.

—P. M. Honnell, W2AIA, ex-5KG

Operating Notes on Power Crystal Oscillators

(Continued from page 46)

done about overloading these higher-frequency crystals. Practically all available information about this tube suggested that the metal shell be left floating. When this is done, the tube performs exactly like the glass tube. However, by connecting the shell to cathode, at the socket, the effective feedback to the crystal is greatly reduced and the crystal current is cut almost in half. Using the circuit as shown in Fig. 5, the crystal current with both 14- and 7-Mc. crystals was reduced by more than 50% over what it was when the shield was floating. Apparently the fact that the shield when floating was at a high r.f. potential, caused excessive feedback to the crystal. At the same time that this reduction in crystal current was obtained, the output remained practically the same, the crystal was still oscillating strongly enough to drive the tube, and there was no increase in plate current. In other words, the efficiency remained the same as in the floating condition. When used in this manner, 250 volts

FIG. 7—HIGH POWER TRIODE CRYSTAL OSCILLATOR DATA

Tube	Plate Voltage	Frequency	Crystal R.F. Current, Loaded	Normal Rated Crystal Current	Output Watts
35T	1000	3.5 Mc.	40 ma.	100 ma.	40
35T	1000	7 "	100 "	100 "	38
35T	1000	14 "	150 "	150 "	35
800	750	3.5 "	50 "	100 "	35
800	750	7 "	120 "	100 "	33
800	750	14 "	170 "	150 "	30
808	1000	3.5 "	50 "	100 "	45
808	1000	7 "	100 "	100 "	41
808	1000	14 "	160 "	150 "	39

Transatlantic 56-Mc. Reception Reported

The following cable was received at Headquarters on January 10th: MY FIVE METER SIGNALS RECEIVED BY W2HXD DECEMBER TWENTYSEVENTH HIS REPORT CHECKS EXACTLY PARTICULARS FOLLOWING (Sig.) OHEFFERNAN G5BY

The news, naturally, comes under the head of genuinely hot stuff. We put it in the record along with the reported reception by Cecil Mellanby, N. Wales, of W2JCY (on May 10 and November 1, 1936) and of W2IIQ (on September 12, 1936). Strangely enough, while the Mellanby reports are of reception over an all-darkness path, the reported W2HXD work was done with an all-daylight condition prevailing.

The indications all point toward the early accomplishment of the first two-way Transatlantic 56-Mc. band working in history. Who is to be first?

may be applied to the screen and 400 volts to the plate without danger to the crystal. In fact it was necessary to increase the grid resistor to 20,000 ohms, in addition to the cathode bias, in order to key the crystal rapidly. It was also possible when using the tube in this manner to remove the load from the oscillator without having the crystal current go above rated values.

The curves in Fig. 6 show the performance of the tube under the two conditions, shell grounded

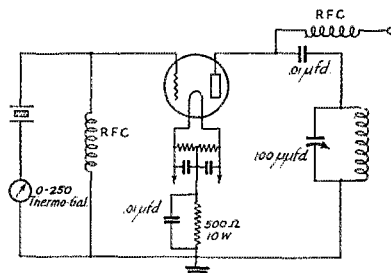

FIG. 7—CIRCUIT OF THE HIGH-POWER TRIODE TESTS

and floating, as the plate tank is tuned through resonance. These curves were taken with a 7-Mc. crystal and the circuit constants as shown in Fig. 5. Notice the marked decrease in crystal current

(Continued on page 114)

• I. A. R. U. NEWS •

Devoted to the interests and activities of the

INTERNATIONAL AMATEUR RADIO UNION

Headquarters Society: THE AMERICAN RADIO RELAY LEAGUE, West Hartford, Conn.

MEMBER SOCIETIES

American Radio Relay League
Associazione Radiotecnica Italiana
Canadian Section A.R.R.L.
Československi Amatéri Vysilací
Deutscher Amateur Sende-und-Empfangs
Dienst
Experimenterende Danske Radioamatører
Irish Radio Transmitters Society
日本アマチュア無線聯盟
Liga Colombiana de Radio Aficionados

Liga Mexicana de Radio Experimentadores
Magyar Rövidhullámú Amatőrök Országos
Egyesülete
Nederlandsche Vereeniging voor Internationaal Radioamateurisme
Nederlandsch-Indische Vereeniging voor
Internationaal Radioamateurisme
New Zealand Association of Radio Transmitters
Norsk Radio Relæ Liga
Österreichischer Versuchssenderverband
Polski Związek Krotkofalowcow

Radio Club Venezolano
Radio Society of Great Britain
Rede dos Emissores Portugueses
Reseau Belge
Reseau des Emetteurs Français
South African Radio Relay League
Suomen Radioamatööriliitto r.y.
Sveriges Sandareamatörer
Unión de Radioemisores Españoles
Union Schweiz Kurzwellen Amateure
Wireless Institute of Australia

Conducted by Byron Goodman

Calendar:

The December, 1936, issue of the I.A.R.U. Calendar, the bi-annual medium through which I.A.R.U. business is transacted, proposals formulated, presented, and voted upon, has, at the time of writing, just been completed. Known as Calendar No. 18, it contains items of general interest to amateurs everywhere, and will therefore be reviewed briefly.

The Union continues its march of progress. During the year its membership has increased, both in terms of member-societies and the number of individual amateurs represented by these societies. Its influence and prestige have also increased, through the filing of advanced technical studies in connection with the Bucarest C.C.I.R., through the representations of member-societies to their governments in connection with Bucarest (notably by the R.E.F.) and Cairo matters, as well as by recording in international bureaus and lists and in other less important ways.

One of the notable accomplishments by a member-society during the year has been the securing after years of struggle of governmental legislative recognition for amateur radio in Colombia by the L.C.R.A. (see December, 1936, I.A.R.U. News). In other countries modifications of the regulations have been secured, in some instances tending to liberalize existing restrictions, in others imposing new requirements necessitated by growth and changing technique. For the most part, the fight of amateur radio to secure adequate

legislative recognition has been successfully waged; the alternative objective of securing adequate administration and control is now foremost in many countries.

During the year two new member-societies

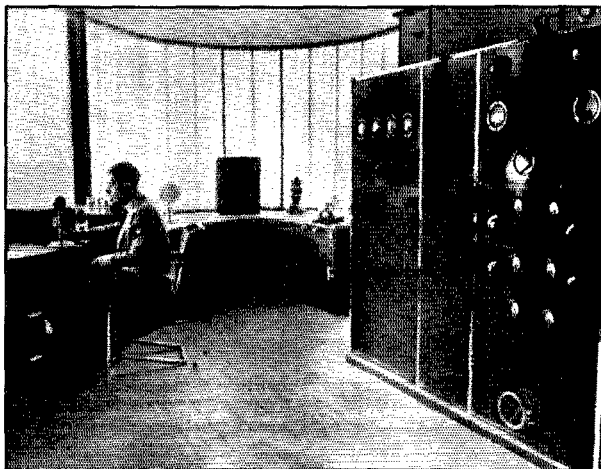

NOT A BROADCAST STATION, BUT THE 14-MC. 'PHONE LAYOUT OF MAURICE KONINCKX, ON4VK, OF BRUSSELS, BELGIUM

The final runs 300 watts to an '03A, modulated by Class B '03A's. Found on 14,076 kc., ON4VK is WAC on 'phone.

were admitted to membership: the R.C.V. (Venezuela) and the M.R.A.O.E. (Hungary), bringing the total to 28. Both of these societies have already displayed a commendable initiative with regard to Union affairs, and constitute valuable additions.

Among the suggestions of the past year was

that of the D.A.S.D. in which they voiced the opinion that a "Contest Calendar" would be of great help, in view of the fact that an increasing number of member-societies are conducting international contests, and a calendar would avoid any possible conflicting of dates such as took place last year. The Contest Calendar would also include the rules of the various DX awards (WAC, WAS, WBE, DSM, HBE, etc.), and all in all should prove useful as a clearing-house for competitive work of all kinds. The headquarters society has formulated the Contest Calendar, and it is urged that all societies contemplating international contests of any sort, as well as special awards, inform the headquarters society well in advance so that the information can be included in the next Calendar.

Clarification of the QSL-forwarding problem was achieved through Proposal No. 27, adopted, which states that "each member-society shall cease all forwarding of QSL cards to non-member societies in countries where there exists a member-society."

Other matters discussed were planned use of the 7-Mc. band, Cairo preparation, and the serious problem created by amateur interference to the transatlantic telephone service by off-frequency operation.

Germany:

A new series of D.A.S.D. broadcasts, designed particularly for amateurs, will start shortly, according to a letter received from Wolf Franczok, D4GZF. The first regular transmission will be as follows:

Zone 2 (East Asia) February 20, 1315 GT

Zone 3 (Africa) February 19, 2015 GT

Zone 4, 5, 6 (South America, North America, Central America) Feb. 19, 2200 GT (5 P.M. EST.)

The transmissions will be from DJD, 11,770 kc. and DJC, 6020 kc. Reports on the broadcast will be appreciated.

F. W. Behn of the D.A.S.D. reports that *QST* has been included in the list of eligible printing matter issued by the German postal authorities, and may therefore be ordered direct by simply going to the nearest postoffice and placing the order at the current rate of exchange. This obviates the general restriction against the importation of goods from abroad into Germany insofar as *QST* is concerned, and should be a useful privilege for the D's.

Spain:

The news from Spain this month is from Ray

Farwell, W2BJ, who says that ON4EF told him that EA1AN, EA1AR, EA1BE and EA1BF had all been killed in the war.

South Africa:

Excerpts from a letter from R. C. H. Taylor, secretary of the S.A.R.R.L.:

"The Ross Kent DX Trophy which is awarded annually to the S.A.R.R.L. member obtaining the highest score in the B.E.R.U. Contest, has gone this year to Mr. L. R. Arnott, ZE1JO. The C & B Trophy, awarded for the most meritorious feat of the year, goes to Mr. Shoyer, ZS1H, for his extremely fine work on ten meters. Mr.

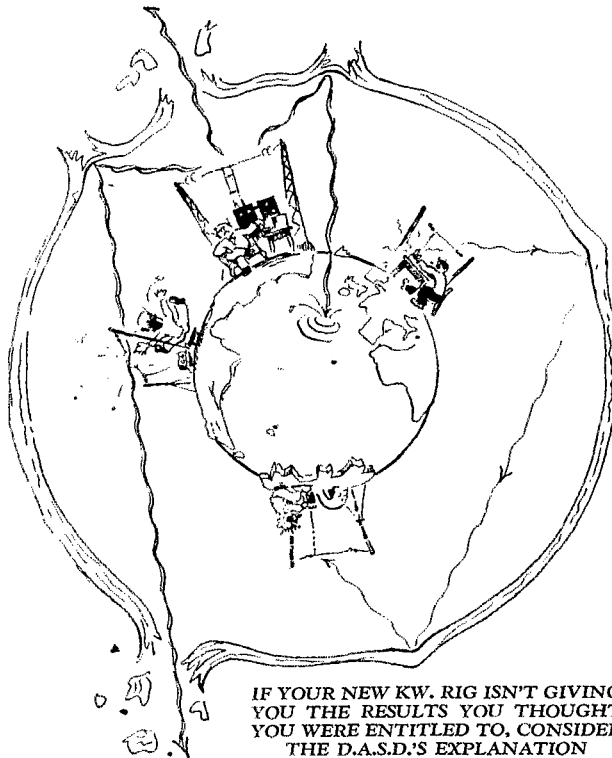

IF YOUR NEW KW. RIG ISN'T GIVING YOU THE RESULTS YOU THOUGHT YOU WERE ENTITLED TO, CONSIDER THE D.A.S.D.'S EXPLANATION
The QRP rig is gentle, safe and sure.

Shoyer has established an enviable international reputation, and the award is a particularly happy one.

"The Annual Conference of the League was held in Johannesburg during October, Mr. Joseph White presiding. Members scattered throughout the Union attended for the double purpose of meeting old friends and visiting the Empire Exhibition. The most outstanding feature of Conference was the falling into line with other societies on the part of the S.A.R.R.L., in that the work of the League is now being carried by paid part-time Secretaries.

(Continued on page 70)



OPERATING NEWS

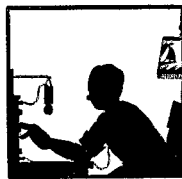

Conducted by the Communications Department

F. E. Handy, Communications Manager

E. L. Battey, Asst. Communications Manager

A new record! On the morning of December 30th, six stations got together on 14-Mc. phone for a round-table all-continent rag chew, to the tune of all continents worked in 21 minutes. The stations in the QSO were W4DLH, SU1CH, G5ML, VK4LO, HK1Z and VU2CQ. These stations have worked toward this objective for some time. On December 15th W4DLH WACed in four hours 47 minutes, working VK2ACO VU2CQ SU1CH G8CL WIARC and HK1GK. On the morning of the 30th this was done in 36 minutes. See additional details concerning Official Phone Station W4DLH, elsewhere in this issue. What next?

Broadcast listener interference complaints and amateur requests for information on elimination of such interference receive prompt attention at A.R.R.L. Headquarters. Two different types of mimeographs available with suggestions on alleviation of interference have been combined into one, with the exhaustion of the supply of the older form and the very complete treatment of the subject now given in Chapter Ten of the *Radio Amateur's Handbook*.

Write for assistance if we can help. In any case do your part to keep down the number of complaints made to us and to the F.C.C. by thoroughly checking your own station and taking steps to stop complaints from individual listeners at their source—by canvassing them—and handling them efficiently as found necessary. Our interference mimeograph contains many general facts regarding interference suitable for study by our neighbor—B.C.L. The large number of possible sources of electrical noise difficulties is mentioned as well as an approach made to the subject of interference determination and elimination of “blanketing” due to proximity to amateur stations. Ask us for two or three of these one-page mimeographs to pass along to your particular listener neighbors who will most profit from the outline, if you like.

Our first duty to ourselves is to prevent complaints by cooperation and action. The F.C.C. handled 2342 complaints in twelve months covering the previous season, a number high enough to be dangerous to the general ham welfare. We also understand complaints are far too numerous in some districts this season. Something must be done. It is an individual responsibility. Every

transmitter built should have as an integral part of it suitable key click suppressors and indicators to prevent modulation beyond the capabilities of the transmitter for linear response. Speaking of individual responsibility, making friends of listeners near your station is a desirable first step. Regardless of such responsibility as may be placed on B.C.L. receiving equipment, most listeners need certain misunderstandings and misapprehensions tactfully straightened out. Cooperation pays big dividends, and it is good to know that the folks next door are friendly and will work with you before running to outsiders in case of future difficulty. It is good for you, and it is good for amateur radio.

The New Year brought some B.C.L. complaints to our desk from different cities. We informed the hams concerned and made suggestions to all parties. We don't wish to discuss the cases, but we do wish to stress the importance of preventing the start of complaints *at the source*. We have seen legal trouble develop. It is easier than one thinks to get into, expensive to bear, important as can be, requires a record of “right” facts to win, can be avoided by care usually. Let every amateur ask himself—if his transmitter and monitoring equipment could stand searching inspection and analysis, thorough investigation by the F.C.C.,—if his log is a model for system, and is neat and complete, fulfilling government requirements. If produced in court would it be up to the standard set by F.C.C. regulation? Would it impress the court favorably or otherwise? Would your record of practical cooperation with listeners and other services stand full recital? We respectfully suggest that every amateur owes it to himself, and the fraternity as a whole, to be fully and adequately covered on all these points.

In the course of a self-conducted inquiry regarding receiving conditions in your neighborhood you will often be able to pass along some radio information of interest—whether interference exists or not. Even if interference has been observed, a courteous approach and helpful attitude will pave the way to a mutually satisfactory relation. In stubborn low-frequency cases discretion may indicate a transfer of activities to higher frequency bands until time permits application of an adequate remedy. In any case where general

interference to modern receivers is noted the regulations require quiet hours. Voluntary exercise of discretion, observance of quiet periods, etc., is much better than official trouble, not only for you personally, but for the ham fraternity, and it is the best good of the whole we have in mind in penning these remarks. It is too often the case that when interference is cured by application and *Handbook* reading after official action on complaints, that the personal feelings are slower to mend. Advance consideration avoids this part, and reduces that complaint total that is held against the amateur service as a growing threat. Is it not better to investigate, and know the facts, and avoid trouble and F.C.C. notices? It certainly is better to have our B.C.L.'s ring us on the 'phone when suspecting trouble than to go to airing and exaggerating interference stories to friends, local newspapers and service men—not to mention the Federal Communications Commission itself!

It is always much better to prevent trouble in advance, than to face the consequences of inattention to these matters. We have seen quiet hours officially required, and what should have been ordinary cases capable of technical solution flower into legal proceedings over the subject of interference. Let us avoid such things. Consider yourself the local ambassador of the whole amateur fraternity, charged with the responsibility of maintaining public good will which is essential to you and all amateurs. The whole amateur service may be judged by your action and fair-minded attitude. "An ounce of prevention is worth a pound of cure."

—F. E. H.

Code Practice

THE following additions have been made to the stations sending code practice on "160 meters": W2DSH (White Plains, N. Y.), 1777 kc., transmits code practice at 8:00 P.M. EST each Thursday. . . . W3RL (Herndon, Va.), 1971 kc., sends code lessons daily from 6:15 to 8:30 P.M. EST. . . . W9FTP and W9HUI (Springfield, Mo.), 1957, 5 kc., are cooperating in giving code practice each Tuesday from 6:30 to 7:30 P.M. CST. . . . W9RIE (Lincoln, Nebr.), 1803 kc., transmits code practice daily except Sunday at 8:00 P.M. CST. . . . A complete list of stations taking part in A.R.R.L.'s Program of Code Practice on 1715 kc., together with other code-learning helps, will be mailed to anyone requesting same by postal card to A.R.R.L., 38 LaSalle Road, West Hartford, Conn.

Stations Needed to Send Code Practice

Many new stations are needed to send code practice on the 1715-kc. band. With the code speed requirement now 13 w.p.m., beginners find the service of even greater assistance than in the past. 'Phone stations can perform this service well, since announcements may be made on voice, shifting to the key for actual code lessons. Any amateur working on "160 meters" who is willing to volunteer regular schedules of code practice is invited to drop a card to A.R.R.L. Headquarters. Please state the days and hours you would like to send code lessons, and list your exact frequency. Helpful

hints on the work are furnished to all volunteers. What say, OM, will you help the newcomers master the code?
CORPS, p. 1.

Brazilian DX Contest

Major G. Vidal, PY1AT, Communication Manager LABRE, society of Brazilian radio amateurs, announces an LABRE-sponsored International DX Contest to be held from January 30th (10 P.M. EST) to February 13th (10 P.M. EST). The 3.5-, 7-, 14- and 28-Mc. bands will be used. Contacts must be by code (c.w.). Scoring will be as follows: For each QSO on 7 Mc., 15 points; on 14 Mc., 30 points; on 28 Mc., 45 points; on 3.5 Mc., 35 points. Only one QSO with each station will count. The LABRE will issue a certificate award to the highest scorer in each country. Mail results to Liga de Amadores Brasileiros de Radio Emissao, Caixa Postal 2353, Rio de Janeiro, Brazil.

WIAW

ON FEBRUARY 17TH, at 6:00 P.M. EST, is scheduled the first use of an authorization by the F.C.C., assigning WIAW (in lieu of W1MK) to your A.R.R.L. Headquarters station. Some explanation seems due, with information on our current schedules. Last May your League's Board of Directors appropriated money for a new Headquarters station, building, and site, this to become an active memorial to the League's founder. Full progress on this station has been held up, pending a decision on location of the Headquarters, by the Board, which probably will not act on its committee reports until the May 1937 meeting. After the '36 floods, the old station site was abandoned. Many of the inundated W1MK units were torn apart, and reconstruction and building of new units has been progressing slowly. Operating for this season has been carried on from W1INF, the station of the Headquarters Radio Operators Club. On February 17th, with the new license and units completed to date, WIAW, temporarily located in the Hq. office building itself, will carry on as your station. W1INF will "QRX" operations (in favor of WIAW) until space again permits it to enjoy separate quarters.

It seems fitting that regular operation as WIAW be inaugurated on the date, and for the event, in which all amateurs honor and revere the memory of our founder, and his accomplishments for amateur radio. The call signal WIAW is a perpetual reminder to all amateurs of the identity of our founder, and a stimulus to us to aim at his ideals of A.R.R.L. service and radio operating perfection. The exceptional F.C.C. action changing our call to WIAW permits fullest realization of the desires of League members, expressed through their Board, for making their station a truly memorial-station.

WIAW addresses information to all amateurs on the following schedules:

Sunday	8:30 P.M. EST 15 w.p.m. 3825 7150 and 14,300 kc. 10:30 P.M. EST 25 w.p.m. 3825 7150 and 14,300 kc.
Monday	8:30 P.M. EST 20 w.p.m. 3575 7150 and 14,300 kc. 10:30 P.M. EST 15 w.p.m. 3575 7150 and 14,300 kc.
Tuesday	8:30 P.M. EST 15 w.p.m. 3575 7150 and 14,300 kc. 10:30 P.M. EST 25 w.p.m. 3575 7150 and 14 300 kc.
Thursday	8:30 P.M. EST 15 w.p.m. 3825 7150 and 14,300 kc. 9:30 P.M. EST 20 w.p.m. 3825 7150 and 14,300 kc. 10:30 P.M. EST 25 w.p.m. 3825 7150 and 14,300 kc.
Friday	8:30 P.M. EST 25 w.p.m. 3825 7150 and 14,300 kc. 10:30 P.M. EST 15 w.p.m. 3825 7150 and 14,300 kc.

Regular schedules are kept with W1INW, W1IP, W1JAH, W2DXO, W3BWT, W8JTT, W8KWA and W8CSE, and traffic connections exist with all A.R.R.L. Trunk Lines.

Join the Emergency Corps

A.R.R.L.'S Emergency Corps now has a membership of 438. The A.E.C. is open to all amateurs and every amateur is urged to register in one of the two groups, (1) Emergency Powered Stations, or (2) the Supporting Division. For membership in the first group it is necessary to possess equipment suitable for operation in an emergency when regular power facilities are disrupted. Auxiliary power must be on hand or must be obtainable from a reliable source upon a few minutes' notice. Membership in the Supporting Division is open to all amateurs who will pledge themselves to assist in the event of failure of regular communication facilities as long as normal power is available; these members do not have to have auxiliary power, although all members are urged to join the Emergency Powered group at the earliest opportunity.

To join the A.E.C. simply send a postal to the Communications Department, A.R.R.L. (or write for application blank), listing what equipment you have. Applicants for Emergency-Powered membership should list fully all emergency apparatus, especially auxiliary power facilities. An Emergency Manual now in the course of preparation will contain definite suggestions and rules relative to emergency work; this will be furnished free to all A.E.C. members. Send your application NOW!

ARTICLE CONTEST

The articles by Mr. G. H. Johnstone, W9CRU, and Eugene A. Hubbell, W9ERU, win C.D. article contest prizes this month. Each month we print the most interesting and valuable article received marked "for the C.D. contest." Contributions may be on any phase of amateur operating or communication activity (DX, phone, traffic, rag-chewing, clubs, fraternalism, etc.) which adds constructively to amateur organization work. Prize winners may select a 1937 bound *Handbook*, QST Blinder and League Emblem, six logs, eight pads radiogram blanks, DX Map and three pads, or any other combination of A.R.R.L. supplies of equivalent value. Try your luck. Send your contribution to-day!

"You Must Hear Them First"

By G. H. Johnstone, W9CRU *

IT IS a known fact that a receiver is not one of high or low power in the sense that we rate transmitters. It is equally well known that the sickly 201-A putting out its undernourished watt and a half at Gopher City, can be heard in Asia. If the Asiatic has a sensitive and selective enough receiver. The above statement deserves thought by all hams. Why? We are constantly endeavoring to make our contacts more reliable, our trunk line skeds as near fool proof as possible. To go back a bit—Schnell proposed a "high power holiday" which didn't seem to take hold very well. I think that the idea had merit. Am I suggesting another? Nay, brother, stuff that sky wire as full of healthy nourishing watts as you wish. We will still hear that little one and a half watter in Gopher City. How?

What is this solution? This—when little Johnny Ham decides to brave the possible wrath of all the BCL's within five square miles (to say nothing of T.O.M. if his sig isn't just rite-hi) and put many watts into the overloaded ether, and dollars on the O.M.'s light bill, let him pause and consider what follows.

You can't work 'em if you can't hear 'em. That is a sad truth. What avail a ham if he has the limit of the FCC regs, and a small, insensitive, non-selective inbaler? Will he hear that South American burning up a tube to tell him that he is RST 599X in Magellan Straits? Not by Ohm's beard! He will get his report from some brasspounder about a thousand miles off at best. Then he will wonder, why don't I get out better. All I get is S-9 reports, but no DX. When

* Box 85, Milford, Kansas.

this condition exists, look to your receivers ye brethren of the glass arm.

Ah, but let us look at the other course that Johnny Ham could follow. He figures up the cost of the high-power stage, its cost of operation, and the effort and knowledge required to keep it out of the BCL's receivers. Cannot the same results be obtained some other way? Yea, brother, it can be done. Instead of building a high-powered final, invest in a really good receiver. The next time your aged 210 does a startling bit of DX, ask the op what his receiver is. You will usually find that it is an "SS," or at least a Super.

Getting the receiver will do two things for you—eliminate the "QRM" from existing hi-power rigs, and give you greater opportunity for DX QSO's. It is surprising what a properly handled rig with 25 watts output will do, IF you can hear the ones that answer you. And don't forget, there are as many low powered foreigners as there are Hi-powered domestic rigs.

It is the opinion of the writer that the purchase of a good receiver is far wiser than the addition of a couple of hundred watts to the antenna, as the receiving range has not been increased in accordance with the transmitting range. Receivers can be purchased now from reliable houses on the deferred payment plan, so think it over, OM's and see if it isn't so.

Pulling 'Em Thru

By Eugene A. Hubbell, W9ERU *

A WELL-TRAINED pair of ears are the biggest advantage a ham can have, and the amount of interference necessary to make a message unreadable is astounding. All of us, however, know the exasperation of having QRM that completely wrecks communication, even though the crystal filtered superheterodynes do wonders. Breakin reduces the time lost. But doesn't make it possible to get the message thru the QRM. So the final solution seems to be to shift the transmitter frequency.

A simple solution of this shifting would seem to be two or three crystals ground to frequencies only a kilocycle or two apart. A small shift usually suffices to allow the receiving operator some adjustment where he can hear the signal distinctly, while any great change makes the new location hard to find, as well as making it necessary to retune the transmitter. A shift of a kilocycle or so will not produce any appreciable difference in tuning or output, and the shift can be accomplished in a few seconds. Remote control enthusiasts can manage with a relay switch designed to shift grid connections to the second crystal, while others can arrange a simple manual switch for a number of crystals all in the same vicinity.

Incidentally this removes the sinking feeling occasioned when the clock indicates schedule time and one realizes that he took that crystal over to W-'s house the night before and forgot to bring it back, or dropped it while cleaning it, or some other one of the many accidents always liable to happen to the lone rock for that important frequency.

Good reliable crystals are now available at bargain prices, so all good traffic-handlers should lay in an extra rock for their traffic frequency, even the boys on the one-spot nets, since rarely do these single-frequency networks maintain any precise frequency, but rather, operate within a narrow band. A single holder can be rigged up with a heavy metal plate, ground on both sides, for the grounded side of the circuit, and a crystal and top-plate put on each side of this, with three connections taken off. Not long ago I saw a commercial holder advertised with provision for no less than six crystals, all in one holder, designed to plug in to a seven prong socket.

A bit of doggerel may point the moral.

"Johnny Ham, if very wise,
Fools the interfering guys.
Switches crystals, one, two, three.
Goes on sending merrily."

* 227 N. 4th St., Rockford, Ill.

Briefs

On December 2d, Wayne University of Detroit and Carnegie Tech at Pittsburgh played chess via amateur radio. Two games were started at 7:30 p.m., Wayne U. winning the first at 10:30 p.m. The second game was finally called off, to be played later, when the clock got around to 2:30 A.M. without an ending. W8CUG sent the plays for Carnegie and W8OQF, with W8FZ at the key most of the evening, handled the plays for Wayne.

Marine Corps League Convention

An amateur radio station was installed and operated under the call W1GEX at the National Convention of the Marine Corps League held at the Parker House, Boston, Mass., in August, 1936. The Parkway Radio Association was in charge of the installation. Operators were W1GEX, W1HOB and W11XL. The station went on the air August 4th although real activity didn't start until the 17th, when greetings were transmitted to all Marine Corps League Detachments throughout the country. About 60 messages were handled, all but two being originated. 25% of this traffic was handled on 3.9-Mc. 'phone, and thanks are due W2GEE and W2ILR for assisting in this. The remainder of the traffic was moved on 3.5 and 7-Mc. c.w. A deep interest was shown by those who visited the station and amateur radio received a definite boost.

W8PLA was QSO W8PWU early one morning and discussing their equipment. PLA uses 250 watts input to a T-55, while PWU uses a pair of 6L6's in the final. PWU, however, has a more modern receiver than PLA, and hit upon the idea of combining their resources and trying for some DX. It should be stated here that these operators were using break-in; without this, it wouldn't have been readily possible to accomplish the stunt. W8PWU heard W6HEZ calling CQ near PLA's frequency. PLA gave W6HEZ a call and raised him and, by having PWU relay the dope received from HEZ (PLA remained tuned to PWU all the time), they had an FB QSO. PLA has promised PWU half of the QSL card when it arrives from W6HEZ!

W8QV calls attention to a common fault in amateur operating—that of repeating back, or OK-ing bit by bit every item of information received, especially after saying "OK, solid." W8QV gives as a typical example of this poor practice: "W8QV de W9XXXX R R OK solid FB—OK on your QRA OM—OK on your WX—OK on your rig—and OK on your wife thinking radio is a darn nuisance—" When you say "R all OK," or "R solid," or just plain "R" for that matter, it means you have received everything all right, so let's cut out the superfluous chatter and save (1) money on our light bill, (2) useless QRM and (3) the other fellow's nerves!

Additional W.A.S. Members

At this writing there are 229 members in the Worked All States Club. Sixty-eight operators have qualified for W.A.S. certificates since September 1, 1936, as follows: W8IMS (No. 162) W1GME W9AWP W9SNP W3BGD W9OWQ XE2C W3BET W7CMO W1GOU W4DVO W9JNB W1AFU W8OQF W9TAD W8LHH W4DDQ W9RSE W8BFG W8KPL W1EZ W9CWW W4CYY W8NCJ W9POP VE3ER W9RJP W1BBN W8HRD VE4IG VE4KZ W4CXO VE5HQ W8HD W4CYC W3CHH W4CEN W9HQH W6MPY W4APU W6KFC W2FF W8OCQ W2EQF W1UE W6GK W3BXE W1TS W1LED W4VB W9VVR W9NBD W9BAZ W2AGU W6CUZ VE4JV W9RCQ W3OP VE4PG W7DJS W6NIK W8NQD W9KJP W4DFB W8OFO W6MPK W8LGU W9AHA (No. 229).

XE2C is the third amateur outside the United States and Canada to qualify for W.A.S., the other two being OA4J and K6CGK.

It is a real operating feat to work all states. As W9AHA

BRASS POUNDERS' LEAGUE

(November 16th-December 15th)

Call	Orig.	Del.	Ret.	Extra Del. Credit	Total
K6QGD	533	270	1300	—	2103
W1FFL	128	134	970	17	1249
W3FTK	63	39	873	11	991
W7DUE	19	36	860	29	944
W3EOP	33	21	876	3	933
W5CEZ	96	110	632	37	875
W5MNN	62	162	570	76	870
W1IP	14	49	780	17	860
W6CDU	112	369	4	369	854
W8JTT	20	47	636	34	737
W6ITH	302	346	24	42	714
W9ILH	11	18	658	20	707
W6KFC	21	42	619	21	703
W2HZY	40	24	632	4	700
W9AJJ	102	155	421	3	681
W2BCX	11	77	585	—	673
W9PVZ	25	15	594	23	657
W2HYC	90	43	503	—	631
W9LXX	75	41	532	—	648
W8KWA	30	30	582	—	642
W9RMN	10	64	513	46	633
W9SGP	47	55	520	3	625
W6MTP	8	8	571	6	593
W4TL	46	56	140	44	386
W1UE	85	175	242	101	603
W6MQM	32	76	400	64	572
W1GOJ	196	74	227	44	541
W1F8V	98	67	338	36	539
W1IOR	304	98	124	13	539
W1AKS	91	64	374	8	537
W8FO	26	203	113	162	507
W8RR	55	19	452	11	537
W3BWT	61	50	393	31	535
W9IQI	54	58	390	21	523
W8HMH	7	21	462	12	507
W1EIL	88	45	360	12	505
W7COH	32	27	448	—	505
W9OUD	54	48	392	10	504

MORE-THAN-ONE-OPERATOR STATIONS

Call	Orig.	Del.	Ret.	Extra Del. Credit	Total
W5OW	178	321	603	268	1373
W9BNT	253	389	499	—	1141
W3SN	155	107	548	—	810

These stations "make" the B.P.L. with totals of 500 or over. One hundred deliveries + Ex. Del. Credits also rate B.P.L. standing. The following one-operator stations make the B.P.L. on deliveries. Deliveries count!

W6JTV, 296	W5DXA, 121	W1INF, 111
W6IOX, 234	W9PTU, 121	W9KJY, 107
W9ESA, 193	W5AAJ, 115	W2GGE, 105
W8FQJ, 175	W7AAS, 113	W6BWC, 104
W8QAN, 161	W8QAN* 114	W8HCS, 102
W2KI, 143	W9FLG, 113	W2IBT, 101

A.A.R.S. STATIONS

Call	Orig.	Del.	Ret.	Extra Del. Credit	Total
WLNF (W2BCX)	16	60	513	—	589

WLMI (W6GXM) made the B.P.L. for delivering 137 messages.

MORE-THAN-ONE-OPERATOR STATIONS

Call	Orig.	Del.	Ret.	Extra Del. Credit	Total
WLM (W3CXL)	130	157	1822	—	2109

A total of 500 or more, or 100 deliveries + Ex. D. Cr. will put you in line for a place in the B.P.L.

* Oct.-Nov.

puts it, "Working all states is the best training one can get in the effective use of the amateur bands." Have you made "WAS"? There is nothing like "purpose" to make your operating interesting. Make one of your goals "to work all states." Will you be among the first 250 WAS? . . . the first 300?

Forty-eight cards or other confirmations submitted to the A.R.R.L. Communications Dept. as proof of contacts with the forty-eight United States will make you eligible for the W.A.S. certificate. Sufficient postage must be sent with the confirmations to finance their return. Contacts may be made on any of the amateur bands and at any number of different addresses, provided no two addresses are more than twenty-five miles apart. A special rule permits either a confirmation from the District of Columbia or one from Maryland itself to count for the state of Maryland. Send your confirmations as soon as you can qualify!

How's DX?

How:

The office was treated to a visit the other day by Mr. Robert Lang, XURRL of Shanghai, China, here for a brief stay with his family in Massachusetts. He intrigued us for hours with his stories of conditions in China, radio and otherwise. We learned plenty about radio over there, and of some of the handicaps under which they work. But it has its compensations, too. He told how one sits down on an evening, knocks over a few east coast W's until the west coast QRM blots them out, then turns to South America until the ZL's and VK's start roaring through—working a few PK's, VU's, and the like until Europe and Africa open up, finally turning in at 17 A.M. with the world in his log. But it isn't DX; it's rag-chewing, and that's what makes it so different from the particular brand of cut-throat DX-chasing indulged in around these parts. These rag-chews often mean a lot to amateurs in countries considered DX, so the next time you have decent signals at both ends, see if you can't do a little more than find out if he has had any

as: M. Mozoomder, Hindu Colony, Plot No. 9, Second Floor, 164 Vincent Road, Dadar, Bombay, India. VU2CQ has been coming through well recently on 14,378-ke. 'phone, and asks that W, VE, and South American 'phones be on the watch for him from 1200-1300 GMT. Heard but not worked by W2HMD was VS2AK (14,300-ke., 'phone) A new station in the B.W.I. is VP2SL, operated by Cyril F. L. Volney, Hillside, Castries, St. Lucia, B.W.I. A pair of '45 tubes is used on 7 Mc., and most of the operating is done from 6-10 P.M. and 4-6 A.M., E.S.T. . . . W1CDX would like to know the QRA of NX1UU, heard recently on 14 Mc., and I1KN would like to know if VC1KR, supposedly Newfoundland, is authentic. Something odd there.

When:

The nice thing about DX is that you never know which band is the hottest at any one time. For example, if CNSMQ spent all of his time on one band he wouldn't have heard the 56-Mc. signals of G5CM. And if ZT6K spent all of his time on ten he wouldn't have heard the 6-meter television signals from England so often. All of which is a tip-off that the first 56-Mc. transoceanic QSO is not far off On the other hand, if W9ROQ in Illinois hadn't called "CQ DX" early one morning on 160 'phone, he might never have been heard by W6IGA-K6 down there at Jarvis Island in the South Seas 3.5 Mc. shouldn't be overlooked, either. W3AWH has worked HB9AD with only 15 watts to a 6L6 oscillator. W1INW worked HB9Y and W1CDX worked D3CDK, OZ5M, and OZ5K. But the lad who has been working overtime is W2BMX, Prose Walker, in Dover Plains. That is, if you call week-ends overtime. During the last month, Prose has worked a flock of G's, D's, HB's, F, K5 and OZ, and has heard CX, ON, ZU, HAF, VK, K7, PAØ, VO, OK, LA, TI and ZL. Most all of these stations were operating at the low-frequency end of the band, and start to come through around 11 P.M., lasting until nearly 3 A.M., E.S.T. W8CNC claims to have heard a couple of J's on 80, but we didn't hear it directly from him so we won't pass it on W1ET and W1SZ have worked VK3KX on 3.9-Mc. 'phone And if still you are not convinced, W2BGO kept a schedule for 24 consecutive days on 80 with G8GM, who blasts through with 9 watts. W2BGO's "California k.w." amounts to 28 watts.

On ten meters, Japan has started to come through again on the east coast. W1WV, W1EWD, W1BUX, W1TW and W1ANA have all worked J21N (28,100 kc., T9) at around 6 P.M. . . . European and African signals are being worked from all over the States, and another good season is predicted for ten Reg. Tibbits, W6ITH, sends a few frequencies that may help you to find 'em: VS2AJ, 28,044 kc.; VS8AH, 28,044 kc.; J21S, 28,150 kc.; J3FZ, 28,285 kc.; VK2XF, 28,050 kc.; VK3YP, 28,040 kc.

Good 7-Mc. DX from the east coast is the Philippine Islands. W3QP at Philadelphia, who handles plenty of transpacific traffic via W6CUU-KA1HR, worked I1ER the other morning for his first KA contact. Listen around 7120 kc. some morning for W6CDU working break-in with KA1HR—you'll hear 'HR come back on exactly the same frequency if it's a good morning If you lack Greece on your list of countries worked, look for SV1SM (7125 kc., T6) who has been worked by W1FH and W1APA, SX3A (7015 kc.), worked by W9BPU at 0500 GMT, or

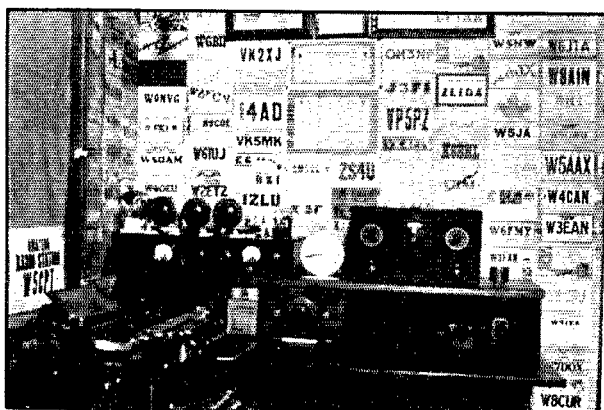

THE QRP STATION OF EMMETT SIMMONS, W5CPT, OF CLARENDON, TEXAS

The transmitter is a 78 Tri-tet oscillator driving a '12A final, with 8 watts input from B batteries. With it Mr. Simmons has worked WAC four times, WAS, and has worked five continents with .1 of a watt at 45 volts! There is nothing unusual about the installation except that a 2-wavelength "Vee" beam is used. W5CPB, who sends the information, says, "And I'll tell you it gives one an odd feeling to hear Europeans giving an 8-watt station better reports than you get with your 500 watts. One is forced to admire a fellow that makes 8 watts do the work of 800."

QSL cards printed yet. Who knows? It may even turn out to be interesting

Where:

Speaking of China and stuff, a station active in Tibet should be good news for those who have worked every other country. Using 100 watts on 14 Mc., AC4YN has already worked all continents, and would like suggestions re the best time to be on for W contacts! The station is operated by Lieut. S. J. Dagg and Lieut. E. Y. Nepean, Political Officer's Camp, Lhasa, Tibet, via Gyantse Post Office, Tibet J. R. Miller, W9CP, has practically given up on VS7AI, worked last year on 7 Mc. A letter from VS7AP discloses that VS7AI was quite probably a fraud, not located in Ceylon at all. VS7MB is believed to fall in the same category W2HMD worked VU2CQ for his 'phone WAC, and gives the new QRA of the Indian station

SV1AZ (7100 kc., T9), heard by W1EWD at 2 A.M.
UESYN, with a T7 signal, has been heard by W2IOP at
around 3 A.M., E.S.T., while U5OF (7200 kc., T9x) was
worked by W1BFT at 11 P.M., E.S.T.

The east coast gang, with some exceptions, of course,
has been getting a minor thrill out of working VS7RF
(14,280 kc., T8) at Lindula, Ceylon, who comes through in
the afternoon and evening Another one good for
a new country is HR7WC (13,995 kc., T7), heard at the
same time And don't go past 14,050 kc. too
rapidly. W4CQR found YA2R, Afghanistan, there the other
day at 2 P.M., sporting a T6 note as pretty as you please
. Ken Bishop, W1EWD and just an old seller-
outer, contributes a list of frequencies and times. Some of
them: U9AZ (14,400 kc., T6) 7 P.M.; VQ8AA (14,350 kc.,
T5) 9:20 P.M.; PK1MO (14,400 kc., T9) 8 A.M.; VU2DY
(14,325 kc., T9) 8:30 P.M. U9MI (14,420 kc.)
has been very consistent around midnight at W8DOD, and
gave DOD and W8KAU their first Asians. Others worked
include CN8MQ (13,390 kc., T9) at 2:30 P.M., J8CD (14,300
kc., T9x) at 4:30 P.M., and ZB1C (14,300 kc., T9x)
XU8HW is on 20 with 100 watts each day from 4:30 to
7 A.M. E.S.T. From W6JMR, we learn that
G5RV has been keeping a sked time weekly with HS1PJ
on 14 Mc. They sked on Wednesdays and Saturdays at 1730
GMT; HS1PJ is T8x at 14,200 kc. For 20-meter
'phone info, we refer you again to W6ITH. If it's Africa,
listen in around 8 A.M. or P.M. for ZU6E (14,116 kc.),
ZU6AS (14,380 kc.) and ZELJF (14,090 kc.). South America
seems best in the early evening, with VP6TR, LU5CZ,
PY2CK, CE3DW, VP6YB, OA4AB, LU1DA, LU7AG,
LU6KE, CE1BC operating in the low-frequency half of
the 14-Mc. band, and LU1DA and LU4BH in the high-
frequency end. Reg has a rhombic pointed at London in an
effort to wangle a few more European countries.

Who:

Consider for a minute the pleasures of low power. G5CM,
for example, worked ZS1H, VK2JU, U9ML, VE4PH,
W6KBD, W6HB, W6JJU (three times), and W9's galore,
on 28 Mc. with 7.5 watts input to an E. C. 59, and has suc-
cessfully worked W3PC with only 2 watts input!
And Miss Barbara Dunn, G6YL, is WAC and WBE on ten
with only from 8 to 10 watts input. Miss Dunn chooses a
frequency higher in the band than most, so don't be afraid
to go looking for her The "Ford-powered" sta-
tion, W7AEX, now boasts a rhombic antenna which,
during the first two days, was good enough for G2JF,
G6NX, O2ZB and O2ZFK W3AWH and
W8EDP, of "unorthodox antenna" fame, are both FBTOC
with G6WY. Yardley says XU3FK (14,120 kc.) comes
through around 4 A.M. I1KN needs Oceania for
his 28-Mc. WAC, and asks the VK's to listen around for his
T6 signal ZS4J (14,306 kc.) has worked all states
on c.w. and asks, via W5FDI, that the 'phone men give him
a listen ZS1AH needs Delaware for his WAS
and, via W3FIL, asks that Delaware stations look for him
on 14,380 kc. around 2-5 P.M., E.S.T.; and J2KJ (14,255
kc., T9x) needs Vermont for his WAS What
is believed to be the first Venezuela-New Zealand QSO took
place when YV5AJ, the R.C.V. station at Caracas, worked
ZLABQ Because of slow mail service, W6AM
reads QST to CE1BC via 14-Mc. 'phone skeds. A month
later, CE1BC can check on Don's reading During
a 'phone QSO with VE1JR, W6LLQ suggested that they
look around for some DX, whereupon VE1JR said he was
satisfied, and asked for a card. W6LLQ finally got the
QRA, which proved to be Salisbury, Southern Rhodesia,
and the station was ZE1JR. Suffice it to say, "Zed E" and
not "Zee E" is signed now.

WAC:

Eroniously reported here was the 'phone WAC of
Joseph Robertson, VE2GA, who, by an office oversight,
received a 'phone WAC instead of the earned one for c.w.
He returned it, saying that he still needs Asia on 'phone
. Latest 28-Mc. WAC's are W1EWF and E3KH
. If it weren't for the "Round-the-World Round
Table," Harold Hobler, VK4DO, might have the record for

WAC. His was made on last Oct. 9th, in the amazing time
of 50 minutes, with 40 watts to a '10! It is, to the best of our
knowledge, the record on c.w. Larry Le Kash-
man, W2IOP, has comment on his WAC: "It was great
fun working the DX, but I think the real victor is the power
company. I wish to thank the W's who made a habit of
tuning up on the Asians, the elevator boy for blotting out
the South Americans, the driver of car f567t80 N. J. for
knocking YV7AA out of the picture, and V02J for not com-
ing back. Otherwise it was one swell party"
—W1JFE

— —

Santa Clara 1.75-Mc. 'Phone Net

A new "160-meter" 'Phone Traffic Net has been orga-
nized in the Santa Clara Valley A.R.R.L. Section, covering
that Section and San Francisco and East Bay as well.
W6JRU, W6NMT, W6LOS, W6JUQ, W6HWP, W6MJT,
W6OAW and W6NAL comprise this net, which meets daily
at 6:45 P.M. PST on 1804 kes. Connections are maintained
with the Central California Net and excellent traffic outlets
are available to any point in the United States, Canada,
Alaska, etc. More stations are needed. Those interested in
some real operating fun on 1.75-Mc. 'phone should get in
touch with W6JRU, Pacific Grove, California, or with
W6LLW, R.M., or W6FBW, S.C.M.

— —

New A.E.C. Members

Emergency-Powered: W1AGM W1EHT W1FGO
W1GUL W1KEC W2AZM W2BNJ W2GVZ W3FUT
W3GHL W4BGO W5ANR W5CIJ W5EKV W5FFR
W6BGY W6BUY W6CBX W6HEW/HEX W6HJN
W6HOW W6ICR W6IPK W6JTV W6NDF W6OBJ
W6QJW W8ZA W7EMT W8JYO W8LYF W8MAH
W8MTE W8NUR W8PTJ W9HL W9LX W9LNI
W9OPG W9PTW W9TXS W9YQG VE3QC VE4AEB
VE4IM.

Supporting Division: W1BB W2HRH W2JDM W2JLW/
JXN W4DDJ W4DFJ W6MXE W8EQ W8FLA W8KLP
W8NPQ W8PSR W8PUN W8QDF W9UWX W9VJZ
W9VUY W9WIT W9WMI.

Briefs

160-Meter DX

As reported elsewhere in this issue 56-Mc. signals have
at last spanned the Atlantic! Likewise, the first report of
"160 meter" trans-Atlantic signals this season comes from
W1BMW, who reports hearing G2FM on approximately
1755-ke., RST 359, at 9:12 p.m. EST, January 10. Who else
is hearing or working "160 meter" DX this year? Let us
have your reports.

— —

R. C. C.

THE Rag Chewers' Club is going strong. If you like to use
your amateur radio station to make and maintain real
friendships, if you are a disbeliever in the "Hello-Goodbye"
brand of contacts, get into the R.C.C.—fraternize with
this group of operators who know how to mix the human
element into their QSO's. Many early R.C.C. members are
still on the air and express delight at the revival of the club's
activity. W3DGC writes, "I held 3VT at the time I was
made a member of R.C.C., which was in the first month it
was formed in 1925. My contact was with 3BVZ, who was
a charter member. I am very glad to see a revival in the Club
and will do my best to boost it. It is going over big now."
"Have been in the R.C.C. since 1925."—W8EU. "I became
a member of the R.C.C. in 1927."—W8DED. "When the
R.C.C. was organized I qualified for membership under the
call of 2DZ. I was glad to see this club revived."—W2DXX.
"Find enclosed one R.C.C. certificate issued to us in Sept.
1925. This one is pretty well worn and battle scarred. Would
appreciate a new type certificate, but wish to have this old
one to keep."—W8DGL. "Note in December QST that the
R.C.C. is being resurrected. Same meets with my hearty
approval as the rubber stamp type of QSO's are getting me

down. Records will show that my old station 2AFV was awarded membership in about 1925 by working old 2CPD of Brielle, N. J."—W9VDQ.

"I have one of the old R.C.C. tickets which A.R.R.L. issued in the days 'way back when.' It still hangs on the wall of the shack and seems to be a source of envy to a lot of young squirts who apparently are cutting their eye teeth on crystal filters and noise suppressors instead of the ole E.I. 'bible' and Duck's catalogue."—W2LG. "I am one of the early day R.C.C. members and still have one of the blue membership certificates signed by 'The Old Sock' on the wall of my shack."—W7SY. "I certainly was more than pleased to read about the resurrection of the R.C.C. I think it is one of the finest pieces of 'machinery' that was ever turned out of the A.R.R.L. factory. I have one of the R.C.C. tickets dating from 1926 when I was operating 9AJV. Here's lots of power to the Chief Rag Chewer, assuming he is still signing 'The Old Sock.'"—W8MSL. "I became a member of R.C.C. in about 1925."—W2BZJ. "My R.C.C. certificate is issued to 1AAC-120, about 1925-26. How about a fresh one?"—W8AQ. "Please put me on the list as still active in the R.C.C. at W8TS and W9WVP. I was initiated by C3FU in 1925 and still have my certificate which I value highly."—W8TS/W9WVP. Here are the calls of some more of the earlier R.C.C. members who are still active: W1ABG W1AFB W1BVR W1CH W3OP K4KD W9CAA.

What some of the newer members say: "Rag chewing and lengthy and interesting QSO's are my greatest pleasure in amateur radio."—W9RKF. "My dear Old Sock: Am only a newcomer to the ranks of Rag Chewers, but already am ready to challenge your right to the office of Chief Rag Chewer. What did you ever do to earn such a title? As for myself, proof of my eligibility is a QSO with W8OUH on Dec. 10th from 6 P.M. until 10:35 P.M."—W8PLA. "When I start chewing the good of rag I chew it on both sides, inside and out. When another ham and I get finished we know all about each other. I don't think I know the meaning of QRU, WX Hr, CUL. Sure I'm loquacious, but I get some fun out of my brass-pounding and get a chance to handle some traffic during these long chews. It got in my blood before the war (ex-2AKA) and I just can't stop chinning at the least provocation on the air. Hi."—W2JRG. A would-be R.C.C. member writes, "Being plagued with low power and poor antenna facilities, I never hope to have WAC or WAS. My main pleasure must be derived from rag chews with those nearby chaps whom I may happen to contact. The R.C.C. therefore supplies a very urgent need."—W3QY.

How to join the R.C.C.: Simply chew the rag for a solid thirty minutes—or longer—with an amateur who is already a member of the club. Then report the conversation by card to the Rag Chewers' Club, A.R.R.L., West Hartford, Conn., and ask the operator you talked with to do the same. Be sure the member you work sends in the confirmation! See December '36 QST (page 52) for complete details on R.C.C. A list of active R.C.C. members follows. Any early members of the club who are still active on the air and who do not find their calls listed are requested to send a QSL card or message to A.R.R.L. with this information so that they may be included in the Roster.

Active R.C.C. Members

W1ABG AFB BAW BDI BFT BTA BVR CH GKM HSC HSX IIC INF INW JAH JFN JMY JQD JPE JTD JWG JWT JYW JZB KAW KFN TS UE W2BCR BZJ DXO DXZ GZF HLB HYQ ITK JEJ JPC JRG JWE LG W3AKB AQN BWT CDQ DGC DNU EDC ETM FHT FKO FWB GPC OP W4AFI AKJ DWB W6ALQ CIS HEW NLZ NSK RZ W7CRH SY WY W8AQ BKE BRS DED DGL DHQ EQ EU GVB GXX HEC IOI KUN KWA MIW MPG MSL MUR NCJ NDG OFO OUH PCL PCW PIT PLA PNL PQQ PSM QMJ TS W9AB AYH CAA EBX RLB RKF TYF VDQ WKC WVP VE3AU 3JT 3MB 3WB K4KD 111R

ADDITIONAL RCC MEMBERS

W1FPP GMM HRN IIN JCR JHN KAY W2AFI BMX HUG W3RL W4ECH W6MCG W8APD BWF DCG FYH MU NDE OSA PGI W9DXX PWV TWC TWQ VLN VTO YCV VELEY VE3AEY

OBSERVERS' HONOR ROLL

Cairo Commercial Occupancy Survey For November¹ and December² 1936

4000-4500 kcs.

W1ABG^{2,1}

6000-8000 kcs.

D3DBN¹ (DE2255N)

21000-21900 kcs.

W. R. Faries^{2,1} W1ABG^{3,1} W1EPP¹ W8NQ²

ELECTION NOTICES

To all A.R.R.L. Members residing in the Sections listed below: (The list gives the Sections, closing date for receipt of nominating petitions for Section Manager, the name of the present incumbent and the date of expiration of his term of office.) This notice supersedes previous notices. In cases where no valid nominating petitions have been received from A.R.R.L. members residing in the different Sections in response to our previous notices, the closing dates for receipt of nominating petitions are set ahead to the dates given here-with. In the absence of nominating petitions from Members of a Section, the incumbent continues to hold his official position and carry on the work of the Section subject, of course, to the filing of proper nominating petitions and the holding of an election by ballot or as may be necessary. Petitions must be in Hartford on or before noon of the dates specified.

Section	Closing Date	Present SCM	Present Term of Office Ends
San Francisco	Jan. 5, 1937	Alan D. Whitaker, Jr.	Jan. 18, 1937
Manitoba *	Feb. 1, 1937	A. J. R. Simpson	Feb. 15, 1937
No. Jersey	Feb. 1, 1937	Charles Hammersen	Feb. 15, 1937
Idaho	Feb. 15, 1937	Nelle Hart	Mar. 1, 1937
No. Carolina	Feb. 15, 1937	H. S. Carter	Mar. 1, 1937
Arkansas	Feb. 15, 1937	Henry E. Veite	Dec. 15, 1936
Calif.	Feb. 15, 1937	Bannle L. Stewart	Dec. 14, 1936
Cuba-1. of E.-P. R.-V. I.			
Oklahoma	Feb. 15, 1937	Carter L. Simpson	Feb. 15, 1936
Hawaii	Feb. 15, 1937	Atlas O. Adams	Apr. 23, 1936
Indiana	Feb. 15, 1937	Arthur L. Braun	July 19, 1936
Western Fla.	Mar. 10, 1937	Edward J. Collins	Mar. 21, 1937
No. Texas	Apr. 1, 1937	Richard M. Cobb	Apr. 15, 1937
East Bay	Apr. 1, 1937	Harold J. Burchfield	Apr. 15, 1937
New Mexico	Apr. 1, 1937	Joseph M. Eldodt	Apr. 15, 1937
Rhode Island	Apr. 1, 1937	Clayton C. Gordon	Apr. 15, 1937
Sacramento Valley	Apr. 1, 1937	George L. Woodington	Apr. 15, 1937
N. Y. C. & L. I.	Apr. 1, 1937	Edward L. Baunach	Apr. 15, 1937
So. New Jersey	May 3, 1937	Carrol D. Kentner	May 8, 1937
Maine	May 17, 1937	John W. Singleton	May 25, 1937

* In Canadian Sections nominating petitions for Section Managers must be addressed to Canadian General Manager, Alex Reid, 169 Logan Ave., St. Lambert, Que., as such petitions must be filed with him on or before the closing dates named.

1. You are hereby notified that an election for an A.R.R.L. Section Communications Manager for the next two year term of office is about to be held in each of these Sections in accordance with the provisions of By-Laws 5, 6, 7, and 8.

2. The elections will take place in the different Sections immediately after the closing date for receipt of nominating petitions as given opposite the different Sections. The Ballots mailed from Headquarters will list the names of all eligible candidates nominated for the position by A.R.R.L. members residing in the Sections concerned. Ballots will be mailed to members as of the closing dates specified above, for receipt of nominating petitions.

3. Nominating petitions from the Sections named are hereby solicited. Five or more A.R.R.L. members residing in any Section have the privilege of nominating any member of the League as candidate for Section Manager. The following form for nomination is suggested: (Place and date)

Communications Manager, A.R.R.L.,
38 Le Salle Road, West Hartford, Conn.

We, the undersigned members of the A.R.R.L. residing in the Section of the Division, hereby nominate as candidate for Section Communications Manager for this Section for the next two-year term of office.

(Five or more signatures of A.R.R.L. members are required.)

The candidates and five or more signers must be League members in good standing or the petition will be thrown out as invalid. The complete name, address and station call of the candidate should be included. All such petitions must be filed at the headquarters office of the League in West Hartford, Conn., by noon of the closing date given for receipt of nominating petitions. There is no limit to the number of petitions that may be filed, but no members shall sign more than one.

Members are urged to take initiative immediately, filing petitions for the officials for each Section listed above. This is your opportunity to put the man of your choice in office to carry on the work of the organization in your Section.

—F. E. Handy, Communications Manager

ELECTION RESULTS

Valid petitions nominating a single candidate as Section Manager were filed in a number of Sections, as provided in our Constitution and By-Laws, electing the following officials, the term of office starting on the date given.

Quebec	Stan Comach, VE2EE	Dec. 14, 1936
San Joaquin Valley	Angelo V. Astone, W6LPE	Dec. 15, 1936
Colorado	Glen R. Glasscock, W9FA	Dec. 17, 1936

In the Iowa Section of the Midwest Division, Mr. Owen Williams, W9NNM, and Mr. Edward P. Alberts, W9CWG, were nominated. Mr. Williams received 90 votes and Mr. Alberts received 38 votes. Mr. Williams' term of office began Dec. 1, 1936.

STATION ACTIVITIES CANADA

MARITIME DIVISION

MARITIME—SCM, A. M. Crowell, VE1DQ—VE1GL between schedules is hard at work finishing the new rig. HH received the R.M. appointment and is doing an FB job. GK, new O.R.S., schedules HH in the net. EV, in addition to schedules with HJ and IB for net traffic, does some nice 3.5-Mc. 'phone work and shoots in swell dope on the Moncton gang. EA had the ill luck to have his Johnson Q ant. blow down in storm. Over 20 hams recently met at Wolfville and organized the Valley Radio Club. Monthly meetings, with lectures, drawings and rag-chews are scheduled for the future. Ex likes his new rig—RK-23's in final. BW, Falmouth, is again active on 3.9-Mc. 'phone. CV gets congrats on new Jr. op. IW worked lots of VK's and ZL's during the October competition. GD has the rig going with series mod. 'phone and gets out well. Valley hams and "near hams" greatly appreciate the code practice transmissions voluntarily carried out so well by GD, EX and BC. ID is on 1.75-Mc. 'phone with an FB 250-watt rig. CU works real DX with a '45—including ZT and VK. AD is QRL operating CJLS. BU is working on a new 3.9-Mc. 'phone. DW is very active on 3.9-Mc. 'phone and 7-Mc. c.w.; he has new 1000-volt power supply on the '03A. GD was home for the Christmas holidays. DN is comm. op. in South America after trip to England, etc. JY has returned on 3.5-Mc. c.w. FE schedules EH regularly. Moncton news via EV: CX is using remote control on 14 Mc. DC is well pleased with his new RME69. GS is using Collins tuning on his antenna and is getting out FB. GI is swatting DX on 7 Mc.—8 countries so far. JU has put up a new skyhook. FF is on quite regularly in afternoons. IJ says some trouble with the buffer. DI is back after a rebuilding job. IK is kept busy running an auto sales garage. EL says the rig is perking along FB. IL gets a chance to visit the local gang once in a while. AP has the new rig on 7 Mc. most of the time. BE plans to put on a bit more power. BZ, an old O.R.S., is back in harness again, and active in net work. CO has a new superhet receiver. AC has his new rig on the air. CW is building a new shack—will have plenty of room for visitors. BD is QRL service work. GK, new O.R.S., schedules HH for net traffic. JF has new rig on 3.5 Mc. using an 804 in final. KJ has hit the air on 7 Mc. CB and BV are both doing some rebuilding. EQ is using both c.w. and 'phone on 3.5 Mc. Interesting dope on "VO" gang via VO1W, who schedules HJ: IP is now using remote control; the rig, using an 849 in the final, is located at his mother's place. IC is now VE1KH and going strong, too. IO is active on 14 Mc. with pair of '45's; ditto IK. ZL has the Gross 200-watt rig. A new VO ham is 3P. 1M has a comm. rig using a pair of RK-25's in final—70 watts. II has been working Europeans on 3.5 Mc. with 12 watts c.w. IJ has been making the rig do its stuff on 14-Mc. 'phone, working all the DX the new HRO can pull in. IN has been doing quite a bit of work on 28 as well as 14 Mc. 4Y is going strong on 3.9-Mc. 'phone. IA, the chief builder, is still building. IH is considering getting a Collins transmitter. IX is building rig with 6L6's, but is QRL lot of the time as chief op at VOGY. 1L has taken unto himself a YF—congrats. IF is rebuilding to use 6L6's. Also quite active are 3F, 3O, 3R, 3X (ex-3HM) and 4K. 6Q is still active commercially. It has been decided to discontinue "VO News" for the time being, as the gang do not seem to have the time to report or contribute.

Traffic: VE1GL 87 HH 52 GK 20 EV-EA 12 EX 4.

ONTARIO DIVISION

ONTARIO SECTION QSO CONTEST

Sunday, February 21, 1937

2:30 P.M. to 10:30 P.M.

Frequency: 3.5-Mc. Band

All Ontario amateurs are invited to take part in a contact contest, beginning at 2:30 p.m. and ending at 10:30 p.m., on Sunday, February 21st, as the guests of the R.M.'s, P.A.M. and S.C.M. of your Section. Only one amateur band will be used, 3.5 Mc. One point will be allowed for each contact, which must be made up of the usual reports between stations. Copies of logs must be mailed to the S.C.M., Fred H. B. Saxon, 302 Lee Ave., Toronto, not later than midnight, February 28th. A 3.5-Mc. crystal will be awarded for the best log submitted.

Get in the contest and get to know your own Section amateurs better.

ONTARIO—SCM, Fred H. B. Saxon, VE3SG—R.M.'s: 3WX, 3QK, 3TM, 3DU, 3GT, 3MB, 3GG, 3WK, 3ABW. P.A.M.: 3NX. LI has lifted his O.R.S. ticket from the inactive list after a year's leave. ZE and SD battled it out for the Sweepstakes Club certificate and also special prize offered by Queen City Club to its members. The Section has a new Official Observer—let us hope his job amounts to nothing. GT is back in harness handling daily traffic schedules with Texas, Wisconsin, and Montreal. Better get carbon and valve jobs done on your rigs, fellas, and be ready for VE/W contest in April—more later. OI, Kingsville, and ZE, Toronto, are newest O.R.S. ACI says that no one is borrowing his NC100 for the contest. ALX, AJE, KC and PA are new hams in London. DU's best DX in first two weeks of December was ZS1H and ZU1T. Ex-HB is back under call AJQ, and GY of ten years ago is now AJK. MB (Route Manager) tells me that outside of 17 schedule periods a week, he does nothing except fit "specs," act as secretary to Board of Education, Town Treasurer, go to church occasionally and take XYL to the show! AGM and ZE are scheduling for traffic on 7 Mc. A message was left on the S.C.M.'s operating desk which reads: "DEAR SANTA CLAUS: PLEASE SEND ME ANY OF THE FOLLOWING: ZU, XU, US, U9, HS OR J." It is signed VE3UF. Queen City Club Executive for 1937 is: Pres., WU; 1st Vice-Pres., ZE; 2nd Vice-Pres., AID; Treas., TH; Secy. ACI. DH, O.R.S. ten years ago, is active again. WX is back on 3.5 Mc. after a sojourn on the higher frequencies. VD is handling schedules on 7 Mc. The Toronto clubs have formed a "Council" with representatives from each club. The idea—better and bigger audiences for speakers. This looks like a step in the right direction. AFR has QSL from VQ8AB, his first VE contact, and incidentally it made him W.B.E. AGM's schedules went haywire for short time through illness in family, but everything under control now. VD reports 7-Mc. DX for first two weeks of December as G6, FT4, LA2, HR4, OE3 and D4. TA has FB antenna at new QTH. AJM is working on new analyzer. If the XYL or YL would like info on making knitted suits, ask WK or 2BU for full instructions via radio. QC, AEV, ADT, ADC and AAN are on 3.9-Mc. 'phone and MR on 1.75 Mc. from London. AEK is now LO. ZA has pair of T55's. YQ, HX, DB and RB certainly keep Brantford on the air. CI has new receiver. VT is looking for cathode ray tube. IB can be heard any time, day or night. "Marge" does most of the operating at EE. WV works 14- and 3.9-Mc. 'phone and has designs on 28 Mc. GO has separate 'phone rigs on 14 and 3.9 Mc. KR is on 'phone in Windsor and sends in a nice traffic report. FP keeps CKOC boiling. ZR has new crystal mike. HK has new RK-20 to push a T814. LI is using 6L6 and 242A amplifier. 9AL has installed heterotone osc. in HRO and is adding a noise silencer. Via the grapevine telegraph we are informed of a very interesting international situation developing in the Niagara peninsula. Will 3YL please let us have something official? NX has 50T. SX has

T55's. JT reports working 5 continents in 3 hours and having 25 consecutive QSO's off of the American continent in ten days, all on 7 Mc.; now he is making European DX on 3.5 Mc. MB visited XS and UO. Add new club name—Cardinal Quintuplet Club—five members.

Traffic: VE3ABW 247 GG 129 WK 92 MB 70 HV 59 KR 38 MA 50 UO 34 DU 32 AGM 31 GT 28 SG 26 VD 13 WX-ZE 11 SS 9 LI-PL 7, VE9AL 17. (Oct.—Nov.: VE3ABW 204 GG 31 HV 28 QB 17 OI 14.)

QUEBEC DIVISION

QUEBEC—SCM, Stan Comach, VE2EE—AH has been having trouble with a 6L6. HT has been staying with BW in Clova and visiting the Quebec gang. LJ has overcome the troubles in his modulator. EX will be on 'phone by the time this appears. FG is remotely controlling his transmitter across Westmount. BN has been doing his share of traffic handling and has built himself a pre-selector for the FB7A. LU is another new O.R.S. DV has gone North to join LQ on the staff of Dominion Skyways. IY has a peach of an exciter unit, from 3.5 right up to 28 Mc. IN has been having his share of troubles on B.C.L. sets. DR has at last hooked all states for his W.A.S. BU, BB, LC, DX and EE are new members of the A-1 Operator Club. The boys and myself desire to thank those members who nominated us for this honor. DU is getting rid of his speech equipment. CA had the misfortune to blow his HD203A. GA has received his W.A.C. parchment. DY has practically recovered from his somewhat lengthy indisposition. Glad to hear you on again. AX has worked a few more J's and has a card from XU. BV has found the 14-Mc. band at last. CO is doing FB with his new Sky-Buddy. DA is very active on the 3.5-Mc. band, and BE and BG have deserted 14 Mc. to operate on the same band. EW is progressing steadily with his new rack job. GO has been building dolls' houses, two in series. We ask HM to accept our rather belated congrats on the new operator. HY and FK are practically neighbors. LE is back on the air in Quebec City. HL is doing his share of the traffic handling. The Quebec Radio Club has applied for affiliation with the A.R.R.L. LL is rebuilding. FA won a club transmitting contest. Congrats. AB is rebuilding his modulator and speech equipment. CW has a Patterson receiver. EY is on 3.9-Mc. 'phone. LC blew his transmitter and was forced to rebuild. HG is getting out very well on 14-Mc. 'phone. DR was top scorer in Quebec Section in the recent Sweepstakes Contest. KZ is having trouble with an FBXA on 28 Mc. BG has been handling HT's schedules during Ralph's absence. DQ has installed a 59 as an oscillator and is adding a 6L6. JK still needs New Mexico for his W.A.S. Your S.C.M. would take this opportunity to thank all the members for his nomination and return to office to serve you for another period.

Traffic: VE2LU 12 JK 31 AB 15 DR 207 LC 33 BU 47 IN 19 KM 4 HL 23 HT 105 DG 380 HH 20 EE 11.

VANALTA DIVISION

ALBERTA—SCM, Alfred D. Kettenbach, VE4LX—LQ has Class AB modulator using 6L6's ready for 1.75-Mc. 'phone. VJ is using 6L6G in final. AEN popped crystal. BV is getting active again. BP is on 3.5 Mc. QX is on 3.9-Mc. 'phone. LQ, AEV and IN keep daily 'phone-c.w. schedule. MH and ZP have gone North with McInnis Fish Co. as ops. YF at EC is on the air more consistently than the OM. EX is active again after a busy summer. QE is on the air with battery rig. JO has a 6L6 to replace 2A5 osc. AAZ is very proud of home-made bug. XW has good flea-power rig on 7 Mc. XX is active again at Sylvan Lake with c.c. M.O.P.A. KI is still tracking down key clicks. GD is on the air with another new rig. LA says farming and amateur radio fit in well together. GM has his new shack all fixed up for the winter season. JJ is active on 3.9- and 14-Mc. 'phone with the new rig and antenna. The Alberta Net is functioning smoothly; at present all net stations are working on frequencies near 3650 kc., but the net expects to have spot frequency operation soon. There is room for a few more good ops in this net, and Route Manager GE would like to hear from any Alberta hams who are interested in traffic. SN continues to be the mainstay of the Breakfast Club; his

comments on the daily news and his willingness to do favors for amateurs living outside of Calgary are much appreciated by the gang. OD is again on the air with 6L6 exciter unit driving a pair of tens. PK and GV are on 'phone from Calgary. DV has new exciter and is building new receiver.

Traffic: VE4LX 122 GE 42 HM 34 LQ 24 WX 13 QK 6.

MANITOBA—SCM, A. J. R. Simpson, VE4BG—Trunk Line Station GC has a good total and reports full activity on the Trunk Line through Winnipeg. AG will no longer be able to hold the job as R.M. for Manitoba and alternate Trunk Line station through Winnipeg. Cliff has worked hard at traffic and has been the chief factor the last two years in bringing this Section well up in this respect. His activity on the traffic nets will be missed a great deal. 'Phones are very active, and we find NI spending considerable time on both 14 and 28 Mc. QV puts out a strong 'phone signal on 14 Mc. IS is also heard on this band. QA has been having considerable B.C.L. trouble with his 14-Mc. 'phone, but this is now satisfactorily cleared up with all those concerned. LL has been heard a few times on 14-Mc. 'phone with a nice quality signal. AG will be heard most on the 3.5-Mc. band for 'phone and c.w. contacts. BQ has a '52 final on 14 Mc. SS is changing his T55 final over to a higher powered tube and is building a 23-tube receiver to go along with it, incorporating everything from a speech amplifier to a modulation indicator. EJ is on 1.75-Mc. 'phone. EK's RK-20's on 14 Mc. are still going FB. ER is still finding the 6L6 a problem. FT is looking around for Class B equipment. FU hails the arrival of twin junior operators. HI. GL spends his time on 14- and 28-Mc. 'phone. IP is changing his RK-20's over to plate and screen modulation. MW has his 14-Mc. difficulties cleaned up. MY pulled a surprise on the gang and has joined the benedicts. NM keeps on 14-Mc. 'phone. NT, with his plate and screen-modulated RK-20's, has a very FB job. QC thinks his RK-23 will soon stop emitting. QF is on 14 Mc. once again and finds the 6L6 exciter very FB. QO is experimenting with push-push crystal exciters. RC lost a crystal and 6L6. RO had a T155 go bad and is now back to the '52's. SB finds little time to finish rebuilding due to business. TJ has FB quality and power on 14-Mc. 'phone. TO went W.A.C. by contacting U9MJ. FB. UX finds that home-made bakelite sockets for a 276A are not so hot. ZK has a preselector for his RME receiver. KX works 14 and 28 Mc. with a 150T final. Visitors to Winnipeg last month were VE3EN and VE3ADP. ADP was passing through on his way to the coast. The M.W.E.A. is in full swing and the Winnipeg Radio Club transmitter, JI, is on the air.

Traffic: VE4GC 103 MW 3.

SASKATCHEWAN—SCM, Wilfred Skaife, VE4EL—KJ, CQ and AAA are enrolled in the A.R.R.L. Emergency Corps. AEF is rebuilding and hopes to be heard on 3.9-Mc. 'phone shortly. The S.A.R.C. lost RB as president; he is now nursemaid to mechanical birds. MB says his metal tube super is the berries for DX. TW's 'phone has T55 final mod. with four '46's Class B. QZ and PQ think they live too close for their own comfort. XB is running 100 watts to two '10's for a little while. BF is making FB contacts on 23-Mc. 'phone. Stan., Sen. Op. at QP, expects own call letters soon. YX uses remote control on his P.P. 6L6's with 150 watts input. UD has been trying 28-Mc. 'phone. UH is on 7 Mc. with single '10 final. TN, PR, ACR and EL are all doing well on 3.9-Mc. 'phone. CQ, QZ, ABB and ACR are all asking for O.R.S. appointments. Local Traffic Net is slowly taking shape. Any others interested, write S.C.M. QD has fist and note worth copying. BD puts out a sock and a half. Regina Club had interesting and informative lecture on sound distortion. CQ wants more schedules. QM, using portable while moose hunting, sends traffic through UL. YC and FM are going in for second-class commercial tickets. XY QSO'ed UL at 150 miles with half-watt input on 3.5 Mc., and came in well. FW is doing well holding down the Trunk and has a new 7-tube Halliocrater super. KJ is getting very good results with his increased power. YM has receiver trouble. XM got his electrolitics frozen.

Traffic: VE4QZ 13 PQ 6 UD 2 UL 6 EL 5 FW 124 KJ 3 ACR 29.

(Continued on page 100)

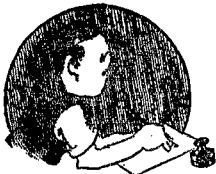

CORRESPONDENCE

The Publishers of QST assume no responsibility for statements made herein by correspondents

Flea-Power Association

58 Thorndyke St., Springfield, Mass.

Editor, QST:

This letter is to introduce to you the "Flea Power Association", a new organization of radio amateurs to stimulate flea power activity on the amateur bands as a definite help in solving the QRM problem. We think that the use of flea power on the more crowded amateur bands by a good percentage of amateurs will do much toward helping to eliminate the excessive QRM on those bands, which at times is intolerable. We are soliciting your cooperation in this matter.

There is on the air to-day a large number of amateur stations operating with flea power, 25 watts or less; but these stations are greatly handicapped by the number of high-powered stations, which cause most of the QRM. Nor can it be denied that many of these low-powered stations are owned by operators who are unable to afford higher power, and also by those who operate low-powered stations for the enjoyment and satisfaction they get from DX on low power. We would like to see these fellows get a break, not be crowded off the bands altogether. I believe the A.R.R.L. is well aware of the accomplishments of flea-powered transmitters. For the past six months here at W1EXZ I have had in operation a transmitter with an input power of only 1.64 watts, and with it I have worked VE1, VE3, W1, W2, and W3 on 3600 kc.

It is our aim, if the cooperation of enough stations can be enlisted, to have a portion of the 80-meter band set aside for flea-power work. The band from 3600 to 3700 kc. has been suggested as a possible range. If this aim could be realized it would certainly give the low-powered fellows a break, and also leave a good portion of the band to the high-powered signals. I think you will agree with me that this will be to the advantage of all. It is not impossible to copy a signal through QRM of approximately equal signal strength, but try and do it through QRM caused by a kilowatt or even a half-kilowatt station.

Furthermore, in the construction of flea power the ham must utilize his ingenuity to the fullest. His transmitter should be made to operate at the peak of efficiency, for, with flea power, it takes a well-made outfit to go places. Is it any great accomplishment to work DX on a high-powered rig? Even with losses and poor operating efficiency a high-powered rig can send out a good

signal for hundreds of miles, but consider the thrill you get when you are sending a signal out a few hundred miles with each watt input.

The F.P.A. is not anti-high power, but we would like the cooperation of the amateur fraternity in bettering conditions on the amateur bands so that the fellows with flea power can get more enjoyment from their efforts in amateur radio as a hobby.

—Robert A. Curtis, W1EXZ

Young Squirts Club

901 West Virginia Ave., Peoria, Ill.

Editor, QST:

I'm writing this letter after a very fine and interesting QSO I had with a fellow my own age on 7 Mc. We young squirts in high school have the greater majority of our QSO's with fellows many years our senior. However, I know that now and then we QSO with someone our own age without even knowing it. Well, this contact is probably "just another QSO," when it could be made in to a very interesting rag chew if we only knew the other fellows age.

So the purpose of this letter is to try to form a sort of 40-meter "young squirts" club for all hams of high school age or younger. When a member graduates from high school he automatically graduates from the club. The only members to date are W3GOU and myself. Any of you young fellows interested in this club can write either to W3GOU, 4711 Lafayette Ave., Merchantville, N. J., or to me, and we will be very glad to send you the dope. Meetings will probably be held twice a week on 40-meter c.w.

We know there are plenty of you so let's . . . get together and have a big ragchew and discuss our YL's to our heart's content. Lord knows that soon enough we'll blossom into OM's and have to talk about our "mojulashun" down on twenty. Then we will always have the OW on our neck with the ten or twelve young'un's. . . .

—Kenneth Bruce, W9VFI

And Now Religion

53 East 7th St., Holland, Mich.

Editor, QST:

Religion is one subject hams seldom mention and it never appears in any amateur publication,

so I think it is about time something is said in regard to religion.

Some of the finest people any person could find any place in the world are amateur radio operators. Any person who has met any number of amateurs will readily agree to that. However, it seems that a rather small percentage of these fine fellows are interested in religion in any way. Perhaps the reason is that they are too busy with other things to bother about religion. However, as any person knows or should know, religion is a vital thing in a person's life because some time during everyone's life it will be found wanting. Besides, with religion a happier and finer life is actually possible. Whatever faith it may be, it is a necessity to a complete life.

The fellows interested in religion should get together and organize a club which any person who professes his faith can join. This same club can do much to help along unfortunate hams in many ways.

I am not a religious fanatic, but I do think that the amateurs could organize a club which would be of great benefit, as the ranks of amateurs is steadily increasing, and we should all try to get together and make the most of amateur radio.

Those fellows who are interested can write to express their interest, and perhaps a club can be organized which would be of great help to the fellows who are "down in the dumps," etc. Let's try to make amateur radio the finest and cleanest hobby in U.S.A. and the hobby that offers the most benefits to its participants.

—Rus Sakkers, W8DED

• Elizabethtown, Lancaster County, Pa.

Editor, *QST*:

It is my object to organize a league of Masonic amateurs, throughout the U.S.A. I wish that you would please publish in *QST* some notice to this effect.

I would like to correspond with, and arrange schedules with, all amateurs located in Masonic Institutions, who would be interested in exchange of athletic material, messages, or other social activities which are being carried on at various institutions.

—Charles Snyder, W3GQJ

"Two Hundred Meters and Down"

99 Hudson St., New York City

MR. CLINTON B. DeSOTO
American Radio Relay League
W. Hartford, Conn.

Dear Mr. DeSoto:

My editorial department has recently shown me a copy of "Two Hundred Meters and Down," which I have carefully looked over.

I notice the various comments which you have made on my early days in amateur radio, but I was rather surprised to see that the one thing in which I always took greatest pride did not get any mention at all in your book.

For historical purposes, I presume you wish to have correct information. . . . On page 31, paragraph 3, you have the following line: "The legislators—or someone capable of lending them inspiration—had had a new idea."

The inspiration of which you speak was given them by the writer—and no one else. You speak on page 30 of my editorials in "Modern Electrics" which were the cause for individual amateurs to rise up in arms against the Depew Bill. But the important consideration was that no one took the trouble to decide what wave band the amateurs should occupy, also what power they should use.

All of this was suggested by the writer in his editorial in "Modern Electrics" where the frequency of two hundred meters first was mentioned, as well as the power. A photostat of this editorial is attached hereto referring to this phase. Also a number of other photostats giving you the complete history of the case are attached as well. . . .

This, however, was not the only contribution to amateur

radio made by the writer. He personally made a number of trips to Washington and personally put the amateur angle up before the legislators, and some good must have come of it because when the Radio Act of 1912 finally was enacted, you will find that the writer's recommendations were practically copied *in toto*, and were incorporated into the Radio Law of 1912.

—H. Gernsback

EDITOR'S NOTE.—The photostatic copies mentioned constitute an account of the legislative activities of "Modern Electrics," as recorded in "Two Hundred Meters and Down." The significant paragraphs in connection with the point raised in the above letter follow, from the February, 1912 issue "There should be a bill passed restraining the amateur from using too much power, say, anything above 1 K.W. The wave length of the amateur wireless station should also be regulated in order that only wave lengths from a few meters up to 200 could be used. Wave lengths of from 200 to 1,000 meters, the amateur should not be allowed to use, but they could use any wave length above 1,000. If this is done, all interference with Government, as well as commercial station, will be done away with and the wireless situation will then be the same as to-day. The amateurs will have the same liberty and perhaps greater liberty than to-day, and complaints against them from Government or Commercial stations will cease automatically."

The Radio Act of 1912, as finally passed on August 13th, provided: "No private or commercial station not engaged in the transaction of *bona fide* commercial business by radio communication or experimentation in connection with the development and manufacture of radio apparatus for commercial purposes shall use a transmitting wavelength exceeding two hundred meters, or a transmitter input exceeding one kilowatt. . . ."

Simple Television Methods

1309 E. 4th South St., Salt Lake City, Utah

Editor, *QST*:

Certainly the amateurs are able to advance the interesting art of television, if only there were a more noise-free band for its use. For the present frequencies the apparatus itself would be no problem. The lenses need not be achromatic.

If you are lucky and own a cathode-ray tube your reception troubles are nearly over, but if not, an ordinary neon bulb behind a disk will make a fair receiver, and the inexpensive photo-cells are sensitive enough for thirty or sixty line pictures.

The side-bands on high definition transmissions are too broad at 1.7 Mc., but they would keep within reasonable limits at 56 Mc.

Two twenty-five-cent 750-watt photo-flood lamps are sufficient for scanning a frame up to about 8" x 10".

Any one can learn the fundamentals within a short time, and the amateur would have no trouble. . . .

—H. R. Hagan, W6LKG

Danger—High Voltage

Riesel, Texas

Editor, *QST*:

Being nearly electrocuted may not be news to amateur radio but it gives one much to think about, especially on the importance of caution and safety.

We will not dwell on the horribleness of the experience except to try to see why it did happen.

The transmitter here is in a metal rack and I was trying to load up the final to a dummy antenna. The tank coil was copper tubing and I was using a one-turn wire loop as a pick-up coil, pushing it in or pulling it out to vary loading.

I formerly operated 'phone without a key in the circuit, but recently I changed things and put in a key, and here is

(Continued on page 70)

Miscellany:

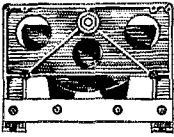

ABOUT CONDENSER INSULATION: High grade ceramic insulators (such as the best quality of Isolantite) are properly regarded as second only to fused quartz for high frequency insulation. Quartz is so very expensive that it is out of the question for most uses. Fortunately it makes but little difference, because the best ceramics give results almost equally good, when properly used. "When properly used" is a big phrase however, and covers

a multitude of things. As far as the user is concerned, the main thing is to keep the insulator clean. Dust (and particularly the sooty dust of industrial districts) causes a marked reduction in the breakdown voltage as well as an increase in losses. The best cure is to inclose the rig in a dust cover, but where this is not practical all insulators should be cleaned periodically. Carbon tetrachloride is usually used for this purpose, but it leads to unfortunate results unless proper precautions are taken. Unglazed ceramic insulating materials of the highest grade are quite porous and consequently absorb moisture readily. To prevent this absorption it is usual to impregnate the material with a low-loss wax. As carbon tetrachloride dissolves the wax, cleaning by this method leaves the insulator at the mercy of atmospheric conditions unless reimpregnated or otherwise protected. Probably the best treatment that the amateur can use is simply to paint the surface, after cleaning, with National Victron Coil Dope. This gives excellent results in every way.

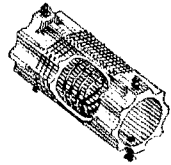

ABOUT PICK-UP COILS: Pick-up coils for antenna or link coupling are often constructed by winding ordinary rubber covered wire around the outside of the coil. Although convenient, this method has serious objections. It is definitely not safe, since the low breakdown strength of the rubber often allows lethal voltages to appear in unexpected places. Further, losses at high frequencies are unreasonably great. A better scheme is to wind the pick-up coil of heavy bus wire, and mount it *inside* the coil form. To do this, wind the pick-up coil with a diameter slightly greater than the inside of the form. Then, holding one end of the coil in each

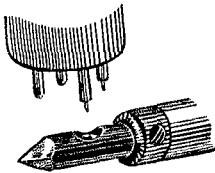

hand, twist it as if you were winding up a spring. As you twist the turns of wire will grow smaller in diameter. When small enough, insert the pick-up coil in place, and release the ends. As it unwinds it will expand again until it fits snugly in the form. The ends of the coil are brought out to terminals on the coil form. The result is a neat, efficient, and well-insulated job.

ON SOLDERING COIL PRONGS: Many plug-in coil forms have hollow terminals similar to tube prongs. We are sometimes asked how to solder wires in these terminals without leaving lumps on the side of the prong. Answer: Dip the prong in a small pool of solder, and withdraw it slowly. This is the only practical method. It is handy to have a small cup drilled in the tip of your soldering iron for this purpose. It should be about $\frac{1}{4}$ " diameter and $\frac{1}{4}$ " deep. Though less convenient, the same results can be secured by melting a lump of solder in an iron spoon.



ON LEAD-THROUGH BUSHINGS: Occasionally also we are asked why we do not make a small lead-through bushing. We do. A GS-8 Stand-off, mounted through the panel, leaves nothing to be desired either for efficiency or neatness.

JAMES MILLEN



LEADERSHIP

has to be

EARNED

NO other radio book has ever sold a tenth or a twentieth as many copies as the Radio Amateur's Handbook. Of course it's the biggest book on radio in the world. And of course it's painstakingly complete in every detail. But the important thing is that it is accurate, honest, carefully written by experts who know what they are talking about. Anybody can write a book and call it a "Handbook," but it takes time and ability and costs money to produce the Radio Amateur's Handbook. As a matter of fact, it cost us fifty thousand dollars — but it's yours for

\$1 POSTPAID
\$1.25 OUTSIDE
CONTINENTAL
U. S. A.

American Radio Relay League

West Hartford, Conn.



where the slip-up came. When I released the key in the buffer stage the current on the final dropped to zero, but of course the voltage (1000 v.) was still there. Several times before I caught myself reaching into the final compartment, but stopped. This time I didn't, and when I touched the tank coil—wow!—my wrist was against the metal frame and my fingers on the coil, and I couldn't get away.

The XYL saved the day. She happened to be at the desk writing a letter and jumped to the switch. Otherwise, I might not be here to tell the story.

My analysis brought out these thoughts:

1. Subconscious habits developed through continued operation become fixed.

2. When a new method of operation is introduced one must be doubly careful because of the tendency to fall back into the old habit. In my case, when the current dropped the mind-set was, "The power is off."

... Why not practice safety—even if you have to cut off the filaments? They will heat up again.

Before you do anything in or near the transmitter, get into the habit of cutting off the power. It means only an extra motion and may spell life or death to you.

I intend to talk about it on the air. It's an important subject that we forget so easily. Next time you are out of soup, in a rag chew, why not bring up safety practices? It will remind you and also the other fellow that it isn't pleasant to be caught between 1000 volts.

—Rev. Alex Greeb, W5ETK

I.A.R.U. News

(Continued from page 57)

"The League is extremely proud of the confidence reposed in it by the Postmaster-General of the Union. At the present moment amateur regulations are being revised and the S.A.R.R.L. has been called upon to submit its proposals in this connection. It is hoped thereby to secure legislation which will be both favorable to amateurs and fair to other users of the ether.

"Recently there occurred an event which has enhanced considerably the status of our League in the eyes of the Government. The Minister of Posts and Telegraphs addressed members from an amateur station in Durban and was replied to by stations throughout the Union. This practical demonstration of the efficiency of amateur equipment created an extremely favorable impression which will certainly have beneficial repercussions on the amateur cause."

Countries:

Crowded last month in this department with our list of countries, we were unable to include the method for using the list. Upon inspection of the list, you will find that some countries are cross-indexed, e.g., "Abyssinia, see Ethiopia," and "Ethiopia (Abyssinia)." In every case like this, the alternative name is given in parentheses.

Note also that there are two countries using the prefix VP2, the Leeward Islands, which include Antigua, and the Windward Islands, which include Grenada and St. Lucia. Five countries use the prefix K6: Guam, (unofficial OM), Hawaii, Midway Island, U. S. Samoa, and Wake Island. VK4 should not be passed up, since it can be either Australia or Papua Territory.

1937 EDITION

The radio amateur's handbook

THE STANDARD MANUAL OF RADIO
COMMUNICATIONS



PUBLISHED BY THE AMERICAN RADIO RELAY LEAGUE



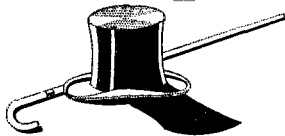

Let's check the
"Silk Hat" and
talk frankly . . .

We are proud of the fact that CARDWELL condensers are recognized as the finest available anywhere. But, at the same time, we do not believe in "ballyhooing" our products with meaningless superlatives or exaggerations.

CARDWELL RATINGS are
CONSERVATIVE and DEFINITE

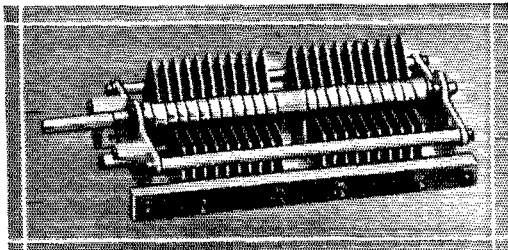

MT-100-GD Very popular for high power buffer stages or medium power final tank circuits. Especially desirable for 20 meter push pull arrangements, where the General Electric mycalex insulation proves its worth. The advantage of the small compact Midway frame is apparent when used in exciter units, limited in width to the standard rack and panel size.

Capacity, per section . . . 100 Mmf.
Airgap070"
Voltage Rating, peak . . . 3500
Insulation General Electric
Mycalex

Net Price
\$4.70

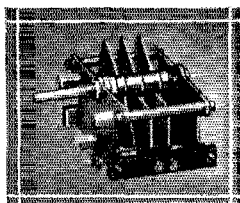

XG-25-KS Neutralizing condenser for 203-A's, 211's and similar tubes. Probably the lowest priced neutralizing condenser of this voltage rating available on the market.

Capacity, maximum . . . 25 Mmf.
minimum . . . 8 Mmf.
Airgap171"
Voltage Rating, peak. 5000
Insulation Radion

Net Price **\$1.76**

NP-35-GD A special high frequency double section condenser for 5 and 10 meter medium powered tank circuits. Also widely used in the manufacture of 6 meter short wave diathermy machines. No closed loops to absorb energy parasitically. Minimum surface leakage losses due to small area of stator block in contact with insulation. Not a double spaced "midget" but a better than medium power double section capacitor, designed for high frequency circuits.

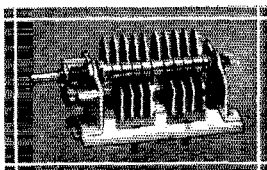

Capacity, per section . . . 35 Mmf.
Airgap084"
Voltage Rating, peak . . . 4800
Insulation Isolantite
Net Price **\$3.53**

The plates of these condensers are buffed and polished, with a resultant increase in peak flashover rating of approximately 25 percent over and above what would be obtained if the plates were plain.

See your distributor for catalog listing other "Ham" units

**THE ALLEN D. CARDWELL
MANUFACTURING CORPORATION**
83 PROSPECT STREET, BROOKLYN, NEW YORK

In error on the list was the prefix of Zanzibar; it should be ZK1.

More on the "High-Frequency" Hiss:

Further data on the hiss observed by G6DH, and reported in the December issue, is furnished by Frank Valentich, W6MEK. He has "also noticed this phenomenon on the frequencies above 14 Mc. The hissing oscillations usually occur from about 6:30 to 7:30 A.M., at various intervals, and cover approximately 10 kc. The hissing will start at the higher frequencies and proceed slowly to the lower frequencies. There may be as many as ten different resonant points for the noise. It usually

(Continued on page 110)

Practical Organization and Equipment for Emergency Operation

(Continued from page 16)

tion in small generators cannot be expected from no load to full load unless special means of assuring good regulation is provided. In the case of d.c. generators this is usually accomplished by means of compound fields or third-brush systems. The maintenance of a constant voltage in a.c. machines is not so easy.

The situation has been handled in a very satisfactory manner on the generators used by the S.A.R.O., in two ways. The first of these methods is the most obvious; if the voltage fluctuates with a changing load, don't change the load. This has been done in several of the transmitters by balancing the cathode and grid resistors in such a manner that the plate current drain of the transmitter is nearly the same whether the key is down or up. This method of course cuts down the effective plate voltage applied to the tubes, but the constant load feature is certainly worth something. The second method has been applied to one of the larger transmitters with only the addition of a small auto-transformer to the rest of the equipment. A booster transformer is employed, which is automatically connected to the line by means of a cathode-current operated relay. The generator voltage is adjusted to the proper value with the entire station connected to the line, but with the key open. When the key is then closed, putting the carrier on the air, the voltage is brought to normal by means of adjusting the booster transformer to the proper value. The circuit for this arrangement is shown in Fig. 2.

Several makes of small gasoline engines are being manufactured and no doubt would serve well for driving portable equipment. Some of them suggest possible lack of mechanical strength, while others are of the water cooled variety and appear to be heavy and bulky. The engines used by the S.A.R.O. are Briggs & Stratton single-cylinder four-cycle air-cooled machines. Both 1/2-H.P. and 1-H.P. engines are now in use by members of the Society. These engines have a very liberal rating as to power output. The 1/2-H.P. unit, on test driving one of the self-ex-

Taylor HEAVY **CUSTOM BUILT** DUTY Tubes

AGAIN IT'S TAYLOR!

866 JR.

For trouble free, economical performance the 866 Jr., a medium voltage half wave rectifier can't be beat. Here is truly the answer to that rectifier tube problem.

CHARACTERISTICS

Half-Wave Mercury Vapor Rectifier

Fil. Volts.....	2.5
Fil. Current.....	2.5 amps.
Max. R.M.S. A.C. Volts.....	1250
Max. D.C. Current per pair with choke input.....	250 M.A.

\$1.00



T-20

Here is Taylor's latest contribution to the amateur world. This tube is truly a revelation in characteristics and price.

CHARACTERISTICS

Fil. Volts.....	7.5
Fil. Current — Amps.....	1.75
Plate Volts — max.....	750
Plate Current — M.A. max.....	75
Max. D.C. Grid Current.....	25 M.A.
Amp. Factor.....	20
Grid to plate capacity.....	4 Mmf.

CLASS B

Output at 800 Volts.....	70 Watts
Plate to Plate load.....	12,000 Ohms.

\$2.45

Your favorite distributor stocks these new Taylor Tubes. For complete data on all Taylor Tubes, consult your Taylor catalog and handbook. If your distributor cannot supply you, write Dept. Q72 today — FREE.

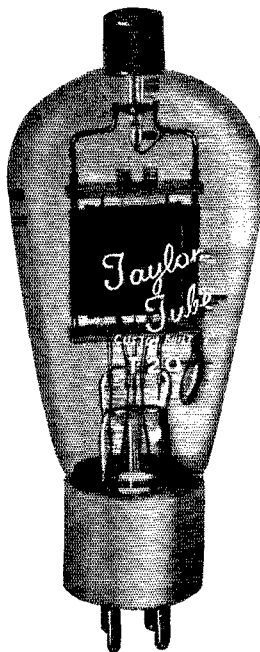

• TWO NEW TAYLOR TUBES •

"More Watts Per Dollar"

TAYLOR TUBES, INC., 2341 WABANSIA AVE., CHICAGO, ILLINOIS

THE "BULLET" DYNAMIC MICROPHONES

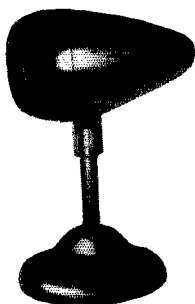

AT LAST an
ALL-PURPOSE

Microphone . . .

With a sensitivity that provides sufficient power to permit almost unlimited lines. . . . Different impedances to match any amplifier having from five to five hundred thousand ohms input impedance. . . . A perfect microphone for indoors yet rugged enough to meet every outdoor purpose. . . . Tone quality equal to much higher priced instruments of similar type.

Consider these SEVEN outstanding "BULLET" features combined in one microphone:

- Maximum sensitivity
- Attractive, modern appearance
- Effective at long distance from amplifier
- Unequaled for severe outdoor work
- Wide choice of impedances
- Remarkable tone quality

● Moderately priced

*A few territories are still open
for exclusive distribution*

TRANSDUCER CORPORATION
30 Rockefeller Plaza
New York, New York

cited generators, developed 420 watts, continuously, and consumed fuel at the rate of about 10 hours to the gallon. The 1-H.P. unit developed 600 watts with a fuel consumption of around 7 hours to the gallon. No continuous tests have been made on the car-driven units; however, one of them was tested for a short period at 800 watts.

The ½-H.P. engines retail for about \$40.00 and the 1-H.P. engine for \$50.00. The total cost of the 400-watt plant is near \$50.00 and that of the 600-watt plant, \$60.00. These prices, of course, are exclusive of labor costs.

GOOD RECEIVERS NECESSARY

None of the strictly portable receivers has been completed to date, so no data can be given at this time concerning their performance. However, there are a few points found in the experience of operating the receivers on hand that may be of interest. One of these is the desirability of having complete shielding, in order to keep down the noises from the engine and commutator. The receivers used in the field have clearly demonstrated this necessity on several occasions. Noise silencers on the receivers used with the car-driven units have also been found of great advantage. Crystal filters, while not an absolute necessity, have proven their worth at times.

The idea we are trying to convey in these few remarks is this: *A portable receiver does not necessarily mean one with two tubes in a cigar box.* It should mean one that contains all of the features of a good home receiver with the addition of the items mentioned above if they are lacking. The reason for this is that the conditions found at portable locations are seldom as good as at a good home location where an excellent antenna helps out. A receiver of this type is hard to find. Not all are able to acquire such an operating aid. There is no harm, however, in dreaming about that ideal portable receiver. There are a lot of us who are doing just that.

It is hoped that the ideas presented in this article will be of some help to those who would like to prepare themselves to be of service to their fellow men in times of disaster. The S.A.R.O. will be glad to work with other organizations in an exchange of ideas which will be of mutual benefit and for the good of the people as a whole.

Strays

Mr. George E. Sterling, for many years the Radio Inspector in Charge at Fort McHenry, Baltimore, has been promoted to assistant chief of the field section of the engineering department of the F.C.C. at Washington. This section handles the administration of the 21 field offices and the several monitoring stations of the Commission. Its chief is the amateur's old friend, Mr. W. D. Terrell. Mr. Sterling himself is well known to amateurs as the author of Sterling's Manual, famous textbook of a few years back, as well as by his personal ham activity. He is succeeded at Baltimore by Mr. C. A. Ellert, located there for several years as Radio Inspector.

In response to popular demand

RCA PRESENTS

TYPE

806

Amateur's net price \$24.50

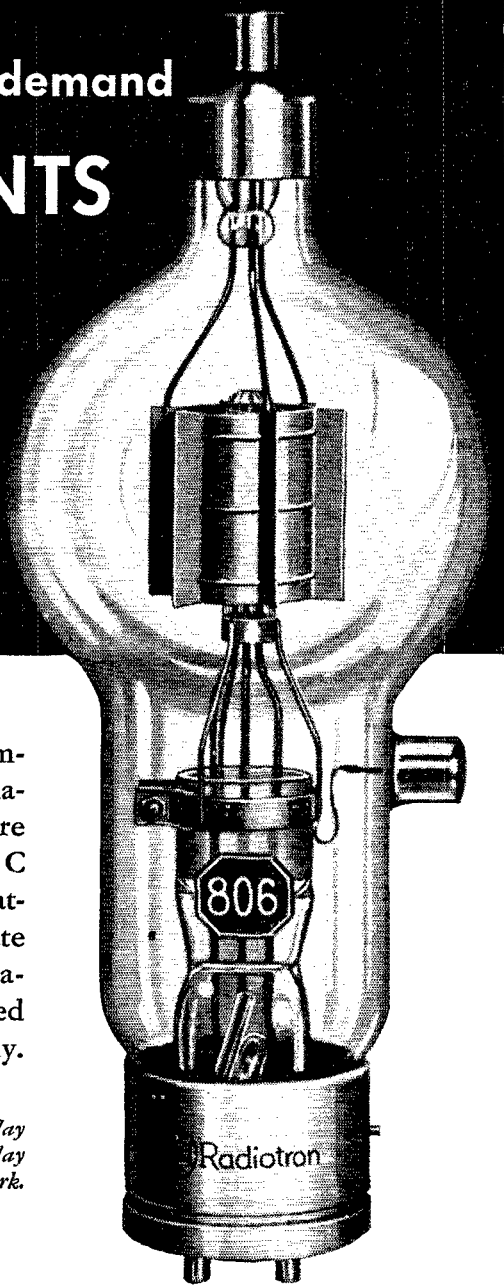

THE tantalum-plate RCA-806 employs an improved grid and filament structure which results in a more rugged mount assembly. For Class C telegraph service the maximum ratings are 3,000 plate volts, 200 plate ma., and 150 watts plate dissipation. Your supplier will be pleased to fill your requirements immediately.

RCA presents the Metropolitan Opera every Saturday afternoon. And "Magic Key of RCA" every Sunday 2 to 3 P. M., E. S. T. Both on NBC Blue Network.



for Amateur Radio

RCA Manufacturing Company, Inc., Camden, N. J.
A Service of the Radio Corporation of America

DX Contest

(Continued from page 27)

and nothing to do when computing your score. Should you find that you operated a total of 100 hours (for example); your gross score should be multiplied by the fraction $\frac{100}{100}$ to give your net or "corrected score."

You can operate 6 hours per day, 12 hours each Saturday, and 16 hours each Sunday, working DX in the contest, and come out about right. This plan permits the average ham to plan for his working day, for meals, for 8 hours' daily sleep, etc. Cross examination of logs makes it possible to check the operating time submitted as may be necessary, of course. The time limit puts contestants on a fair basis whether employed or having full time to apply to the contest.

Operate as much as you want to during the contest period. Keep track of the time you start and stop operating your station. This must be shown in your log report. In counting up your total contest time, please be fair and honest. We know you will. What constitutes "contest operating hours"? Not hours spent keeping local skeds with each other within the U.S.A. and Canada. Not the time spent in local rag chews, swapping DX results, scores, and other dope. If you *listen* for DX with the *ability to call DX* stations if, as, and when, you hear them, that time counts, whether you do any calling or working or not. The whole period is to be charged against "contest operating time," and not just the time after you started transmitting.

AWARDS

Certificates handsomely lithographed and imprinted will be awarded: (1) Two in each remotely located country or territory, to one 'phone and one c.w. winner—all hams using the same prefix compete for an award, and (2) two in each of the 64 A.R.R.L. Sections, mainland U.S.A. and Canada (see page 5, *QST*), one to the 'phone, and one to the c.w. winner.

All operators in the same country⁷ will be in competition with each other—and similarly each A.R.R.L. section-boundary circumscribes a competing group. DX-transmission characteristics being the same for all operators in each award-area, and in each period, the chances of being a winner depend on operating ability and stations and are equally fair to all.

CLUB PARTICIPATION

To encourage local participation, additional certificate awards (besides the A.R.R.L. Section awards) will be made through each club where three or more individual club members, or new local hams invited by such a club, take part. For a club to rate a c.w. winners certificate awarded on behalf of the club group, at least three reports from c.w. club-member (First Period) partici-

⁷ The official list of prefixes was published in January '37 *QST*, page 52. See tabulation of the last A.R.R.L. DX Contest results showing classifications of prefixes and geographical-political distinctions observed.



Ceiling unlimited for Ol'Man Centralab

He's flying high these days . . . and the service man who is throttled to Centralab's speed is bound to be well satisfied with 1937's possibilities. '36 has been a big year for Old Man CENTRALAB.

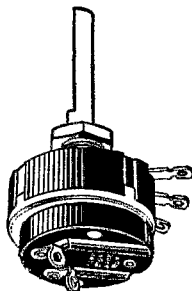

The famous smooth control with the long resistor has the place of honor on thousands of service benches and in as many service kits. Fly with CENTRALAB again in '37.

Centralab

Milwaukee, Wisconsin

British Centralab, Ltd.
Canterbury Rd., Kilburn
London N.W.6, England

French Centralab Co.
118 Avenue Ledru-Rollin
Paris XI, France

**VOLUME CONTROLS
FIXED RESISTORS
SELECTOR SWITCHES**

The New Amateur CLASS "B" TUBE

Low-Distortion Zero Bias Amplifier

NEW AMPEREX ZB 120

A high current low voltage tube with the following general characteristics and ratings:

Amplification Factor.....90
Grid to Plate Transconductance at 100 ma.....5,000
Filament Voltage.....10 volts
Filament Current.....2 amps
Maximum Allowable Plate Dissipation.....75 watts

The combination of an amplification factor of 90 and a transconductance of 5000 is only approached in one or two of the larger transmitting tubes. This combination of characteristics in a low cost tube is made possible by exclusive Amperex design features (covered by pending patents). It is these design elements which invest the ZB 120 with the properties that enable it to deliver, under similar operating conditions, at zero bias, power outputs of an amplitude equivalent to larger and costlier tubes, with such a greatly reduced distortion factor, that the tube may be practically termed "DISTORTIONLESS."

The excellence of its performance in various classes of service can be judged from the following paragraphs.

PERFORMANCE AS CLASS B AUDIO AMPLIFIER-MODULATOR

Zero Bias for Plate Voltages up to 1250 volts. Power output up to 300 watts per pair of tubes. Straight line dynamic transfer characteristics, and practically constant and high input resistance, minimize circuit requirements and make possible practically distortionless operation with exceptionally low driving power.

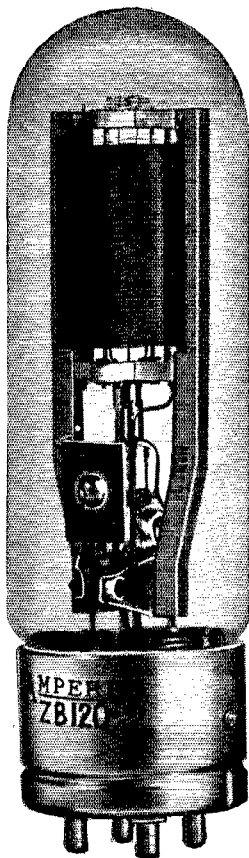

PERFORMANCE AS LINEAR RF POWER AMPLIFIER

The special characteristics of this tube that result in its ideal operation as a Class B Audio amplifier, also afford superior performance with minimized circuit requirements in Class B RF amplifier service. Carrier output in the order of 40 to 50 watts per tube are readily attainable in this service.

CLASS C — RF POWER AMPLIFIER

In this class of service the ZB 120 will deliver up to 150 watts of r.f. power with lower driving power requirements and at economical plate voltages.

FREQUENCY MULTIPLYING POWER AMPLIFIER

The exceptionally high μ coupled with a high r.f. grid voltage tolerance, makes practical the use of the ZB 120 as a frequency multiplying final amplifier, with consequent savings in total tube costs and elimination of neutralization requirements.

GRID MODULATED POWER AMPLIFIERS

The characteristics of the ZB 120, ideally adapt it for use as a grid or bias modulated class C amplifier, or doubler amplifier. In this class of service, fully modulated carrier outputs of the order of 40 to 50 watts may be obtained even while doubling, with exceptionally low modulation distortion.

\$10

Additional engineering information and typical performance data may be obtained by writing to our engineering department.

AMPEREX ELECTRONIC PRODUCTS, Inc.
79 WASHINGTON STREET • BROOKLYN, NEW YORK

STUCK?



CANDLER'S Scientific Code System Will Help You "Over the Hump!"

Don't be discouraged if you're stuck or have failed your code exam! Maybe you've spent hours in faithful practice — maybe you've tried again and again without progress — yet the *Candler System* can help you "over the hump" that seems to be your limit.

It's not how *much* you practice but *how* you practice that counts in learning code or gaining speed — and Candler can show you *how*.

Thousands of high speed radio ops — men like Champion Ted McElroy and other skilled amateur and commercial operators — can testify to the effectiveness of Candler System Code Training. It's different — you learn to read code by sound as you read print by sight. It's sure — Candler guarantees you whatever ticket you're working for, amateur or commercial. It's quick — the rapid progress of Candler students is amazing — in a few weeks time they accomplish what years of undirected practice failed to give them. It's easy — only a short time daily will suffice. And last but not least, it's inexpensive.

Don't be satisfied to be a "LID" when it's so easy to be a skilled radio operator. Let Candler train you the *right way* — the *quick way*. Ask any skilled operator about the Candler System! Who knows — it may be your start in a well-paid profession. Write today for the *Free Book of Facts* that tells you all about the Candler System.

COURSES for BEGINNERS and ADVANCED STUDENTS

Candler takes you right through from the very beginning to your amateur or commercial license. There's a course for beginners that teaches you all the necessary fundamentals scientifically — a course for operators who want to prepare themselves for the commercial radio field — and a Telegraph-Touch Typewriting course for those who want to become expert in the use of the typewriter, in receiving fast stuff. Remember, Candler trained operators are in demand for attractive commercial jobs. Send the coupon today for complete details.

CANDLER SYSTEM CO.
DEPT. Q-2, ASHEVILLE, NORTH CAROLINA

MAIL THIS COUPON TODAY!

CANDLER SYSTEM CO.
Dept. Q-2, Asheville, North Carolina

Please send me *Free Book of Facts*.

Name.....

Address.....

City.....State.....

Code Speed.....WPM

pants must be sent to Hq. Similarly, a club 'phone winner's certificate will be issued only when three 'phone (Second Period) entries mentioning the club have been received. Reports must be made direct to A.R.R.L., West Hartford, mentioning the name of the club, to be eligible for the affiliated-club-award. Entrants who mention their club will be eligible for both club and Section certificate awards.

Besides this, the sum of the scores of all club participants ('phone and c.w.) may be added, and reported by the club secretary, to count for the club itself. A genuine gavel, with engraved sterling silver band, is offered as an award to that club whose officers or activities manager submits the greatest collective score in A.R.R.L.'s 9th International DX Competition. The club station may be operated as one of the group of club member-stations, but the idea is not to operate that station so much as to have individual members all working at their own stations.

RULES

1. All contest work must take place in the contest period.

2. Reports must show each time of starting and stopping station operation in the log submitted to A.R.R.L., and if the total time of station operation exceeds 90 hours (in either period) the proper factor must be applied to the gross score as shown under "time limit."

3. Logs must include date, time of QSO, call of station worked, serial numbers exchanged and other information required tabulated neatly with the claimed score. (See the log examples for required data.)

4. Scoring: Both the W/VE station, and the station in the remote locality receive one point when the W or VE serial number is acknowledged by the station in the remote locality. Each operator, similarly, may add two points further when a serial number (to U.S.A./Canada) is acknowledged by a W/VE station.

(a) For W/VE entries. In computing points, each "received" serial number group counts 2. Each serial "sent" and properly QSL-ed counts 1.

(b) For entries from stations using any prefixes other than W or VE. In computing points, each serial number "received" counts 1 point, and each number "sent" (with proper acknowledgment) counts 2 points.

5. Logs must be marked for "phone" or "c.w." transmissions with work in a single entry all by one method for one period. Separate entries may be made for both periods if desired. This is optional.

W/VEs:

First Period (C.W.). Quota of three stations per country (prefix) may be worked in each different band and is the limit to count points toward the score, except that if *one way* exchanges with some of these three have been made, more stations can be worked to give not more than 9 points (basic) per country. This quota shall be permitted in *each different band*.



Still Following Orders from Headquarters Thanks to Burgess Portable Power!

In war time or peace time—policing or protecting—the U.S. Coast Guard is always ready to serve in any emergency.

Fortunately, they can be contacted and directed from headquarters—with the help of two-way radio communication.

It almost goes without saying that here—where the communication equipment must be completely dependable—they turn to Burgess Batteries as a source of power.

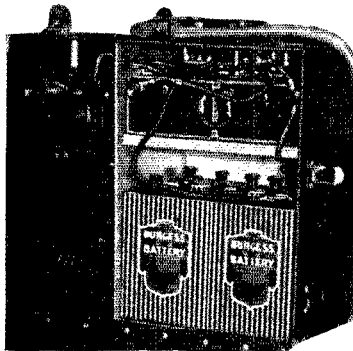

They, too, have proved Burgess Batteries, as we have proved them in our own laboratories—where they give amazingly long life and stand up under most adverse and trying conditions.

Use Burgess Batteries in your own experimental work. A fair test will convince you

of their economy and dependability for any and all battery services.

BURGESS BATTERY COMPANY
FREEPORT ILLINOIS



BURGESS



NEW — a low cost Cathode-Ray Oscillograph

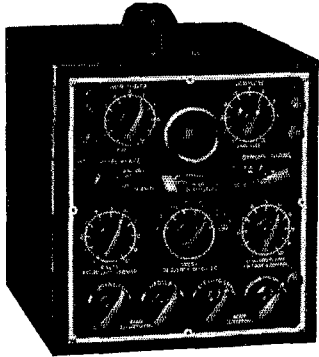

ClOUGH-BRENGLE MODEL 105

complete with
five tubes

Net cash **\$48.90**

(\$5.50 down, bal.
10 mo.)

The surest, quickest check on
**MODULATION
DISTORTION
EXCITATION, etc.**

Employs the new Type 913 Cathode-ray tube, yet retains every feature of the most expensive instruments, such as: Linear Sweep with Type 885 Thyatron in synchronizing circuit, separate high gain amplifiers for horizontal and vertical plates, beam centering controls, etc.

Makes every test needed to secure the maximum performance from your rig and assures operation within FCC regulations.

Compact, easily portable — yet the most complete instrument ever offered using the Type 913 tube. Not one of these features can be omitted without limiting the use of the oscillograph.

Get the Complete C-B Catalog

Use the coupon below to secure a copy of the new 1937 Clough-Brengle catalog, describing the MODEL 105 oscillograph in detail, as well as the complete C-B line of audio oscillators, r-f signal generators, and all-purpose volt-ohm-milliammeters.

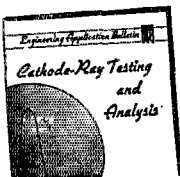

FREE — 24-page Booklet

"Cathode-Ray Testing and
Analysis," by
Kendall Clough

For a limited time only. Get your
copy of this valuable booklet today.

The ClOUGH-BRENGLE Co.

2813-C W. 19th St., Chicago, U. S. A.

Send at once a copy of "Cathode-Ray Test and Analysis,"
the complete C-B Catalog and Time Payment order blank.

Name.....

Address.....

Second Period ('Phone). No quota limit on stations per country.

6. Multiplier shall consist of the number of countries (prefixes) worked on one band plus those worked on a second band, plus those worked on a third band, etc.

All Others:

7. No quota limit on stations.

8. Scoring points shall be multiplied (for total) by the number of U. S. A. and Canadian licensing areas contacted (a possible 14). The multiplier is also increased further by working the same areas on additional frequency bands. (Example: All districts are worked on two bands, possible multiplier is 28; 10, 8, 6, and 5 lic. areas are worked on four bands. The sum, 29 licensing areas, is the multiplier to use to get the gross score.)

9. All entrants agree to be bound by the Rules and Contest Announcement and the regulations of their licensing authority. In a contest of this magnitude, no correspondence can be entered into regarding Award Committee Decisions.

10. The highest scoring individual operators score is the official score for all awards. Other operator scores must also be submitted separately if more than one operator worked a station. The station score (all points by all countries) may be stated for purposes of comparison, but will not have official significance in making awards.

11. More than one receiver and receiving operator in use at one time to log available DX is not permissible and shall be grounds for disqualification.

12. The same station can be worked in more than one band, provided the quota of three (per country, per band) which applies in the first period only is not exceeded.

13. Cross band work does not count in this contest.

14. Reports and logs from participating stations must be received at A.R.R.L. Hq. from all W/VE stations on or before noon, April 23, 1937, to be considered for awards. From all outlying localities, reports must be received on or before May 28, 1937. Play safe . . . mail your report immediately at the end of each contest period to avoid delay and insure that your results are credited in QST. Show your claimed-score in full, following a tabulation of points in the log-form indicated with this announcement.

15. The entries received after the competition will be passed upon by an A.R.R.L. Award Committee whose decision will be final in all cases.

WARNING!

Good notes, not ragged ones are advisable. The F.C.C. monitoring station personnel are well acquainted with the dates of our DX contest, and will be on the job as usual to mail a bunch of those discrepancy reports for poor notes and overmodulated signals! You don't want to be a recipient of one of those colored slips for a bum note or a parasitic—better lose out in some operating hours rather than jeopardize your amateur license. Let's make it a contest with *no bum*

The TEMCO 1000 WATT TRANSMITTER

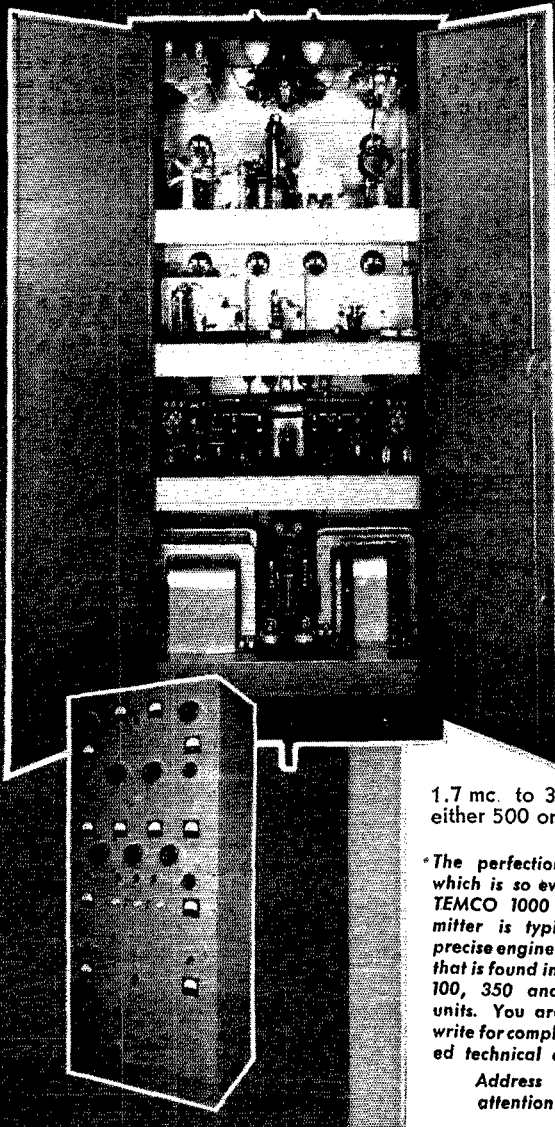

The Perfection of detail found in this de-luxe transmitter is typical of all Equipment by
TEMCO

Efficiency of operation is largely dependent upon attention to detail. That is why TEMCO Engineers have worked untiringly to approach perfection of design. For example, note the TEMCO Automatic Plug in Chassis with conduit-protected intercabling illustrated below. This is but one of many innovations which distinguish TEMCO Transmitters, as being distinctly superior. Other features ■ Band switching up to and including grid circuit of final amplifier stage ■ Full remote control ■ Complete relay protection ■ Separate high fidelity speech amplifier unit including 2 channel mixer ■ 100% high level modulation ■ 6 position crystal selector switch ■ Operation from

1.7 mc. to 30 mc. ■ Power control switch permitting inputs of either 500 or 1000 watts.

**The perfection of detail which is so evident in the TEMCO 1000 watt transmitter is typical of the precise engineering design that is found in the TEMCO 100, 350 and 500 watt units. You are invited to write for complete illustrated technical data sheets.*

Address inquiry attention W2KR.

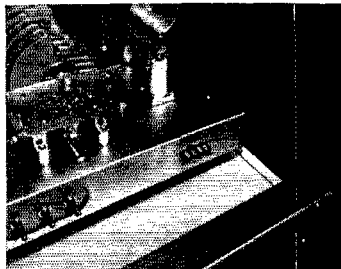

Transmitter Equipment Manufacturing Co., Inc.

130 CEDAR STREET • NEW YORK, N. Y.

Designers and Manufacturers of Radio Transmitting and Accessory Equipment

Now—a high-powered—

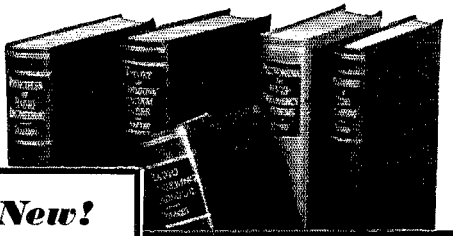

New!

The Library now comprises a revised selection of books culled from latest McGraw-Hill publications in the radio field.

RADIO ENGINEERING LIBRARY

— especially selected by radio specialists of McGraw-Hill publications

— to give most complete, dependable coverage of facts needed by all whose fields are grounded on radio fundamentals

— available at a special price and terms

These books cover circuit phenomena, tube theory, networks, measurements, and other subjects—give specialized treatment of all fields of practical design and application. They are books of recognized position in the literature—books you will refer to and be referred to often. If you are a researcher or experimenter—if your interest in radio is deep-set and based on a real desire to go further in this field—you want these books for the help they give in hundreds of problems throughout the whole field of radio engineering.

5 volumes, 3064 pages, 2000 illustrations

1. Glasgow's **PRINCIPLES OF RADIO ENGINEERING**
2. Terman's **MEASUREMENTS IN RADIO ENGINEERING**
3. Chaffee's **THEORY OF THERMIONIC VACUUM TUBES**
4. Hund's **PHENOMENA IN HIGH-FREQUENCY SYSTEMS**
5. Henney's **RADIO ENGINEERING HANDBOOK**

Special Low Price and Easy Terms

Bought singly, the five volumes comprising this library would cost you \$25.00. Under this offer you save \$1.50 and, in addition, have the privilege of paying in easy installments beginning with \$2.50, 10 days after receipt of the books, and \$3.00 monthly thereafter. Already these books are recognized as standard works that you are bound to require sooner or later. Take advantage of these convenient terms to add them to your library now.

SEND THIS ON-APPROVAL COUPON

McGraw-Hill Book Co., Inc.
330 W. 42nd St., New York, N. Y.

Send me Radio Engineering Library, 5 vols., for 10 days' examination on approval. In 10 days I will send \$2.50, plus few cents postage, and \$3.00 monthly till \$23.50 is paid, or return books postpaid. (We pay postage on orders accompanied by remittance of first installment.)

Name

Address

City and State

Position

Company *QST-2-37*

(Books sent on approval in U. S. and Canada only.)

signals. At any rate, don't let your station come in for F.C.C. trouble!

All competitors are requested to submit their lists, even if they only show a small score. In so doing they are supporting claims made in logs from other stations, and they will receive full credit for their work in *QST*.



Amateur Applications of a New Static-Type Velocity Microphone

(Continued from page 49)

reduced. The output of -45 db is given for normal cable length of 8 feet. Any leakage in the cable circuit will, of course, result in noisy operation, and all soldering should be made using rosin flux. The additional two condensers and resistances needed to adapt the microphone to its amplifier should be placed, if possible, under the chassis or in an individually shielded can. The microphone has no hum pickup from magnetic fields, since there is no transformer to be affected. The whole unit may be laid with its cable on top of a working power transformer without the slightest indication of hum. Its radio-frequency pickup should be negligible, since the construction places a double static shield around the ribbon which effectively protects it from r.f. pickup when used with a well-shielded cable.

SPECIAL CIRCUITS

During the early development of the microphone numerous experimental circuits were worked out in an effort to overcome the cable losses resulting from the very high impedance which it had at that time. In later development the problem was solved by increasing the output and inherent capacity of the unit to such an extent that special circuits were not necessary. Although these experimental circuits were all tried out and made to work, they were never developed to any final stage because it was evident that the solution of the problem at hand should be as simple as possible. However, they offer possibility for experiment in the ham field, especially in reducing the amount of equipment necessary for modulation purposes. Whatever their eventual worth, they do offer intriguing opportunities which open a new field for the experimenting ham.

The circuit given in Fig. 2 shows how the microphone may be used without any polarizing voltage to modulate an oscillator output directly by means of feed-back control in an associated circuit. The circuit employs a pentagrid converter tube, the oscillator section of which is oscillating at the desired frequency and is as independent as it can be made of the amplifier or mixer section of the tube. Grid 1 is acting as the oscillator grid, Grid 2 as the oscillator plate and the r.f. cathode return of the oscillator section is made directly to the cathode. It will be noticed that Grid 4, the control grid, is returned to ground. The tuned circuit consisting of the microphone and L_1 , in the cath-

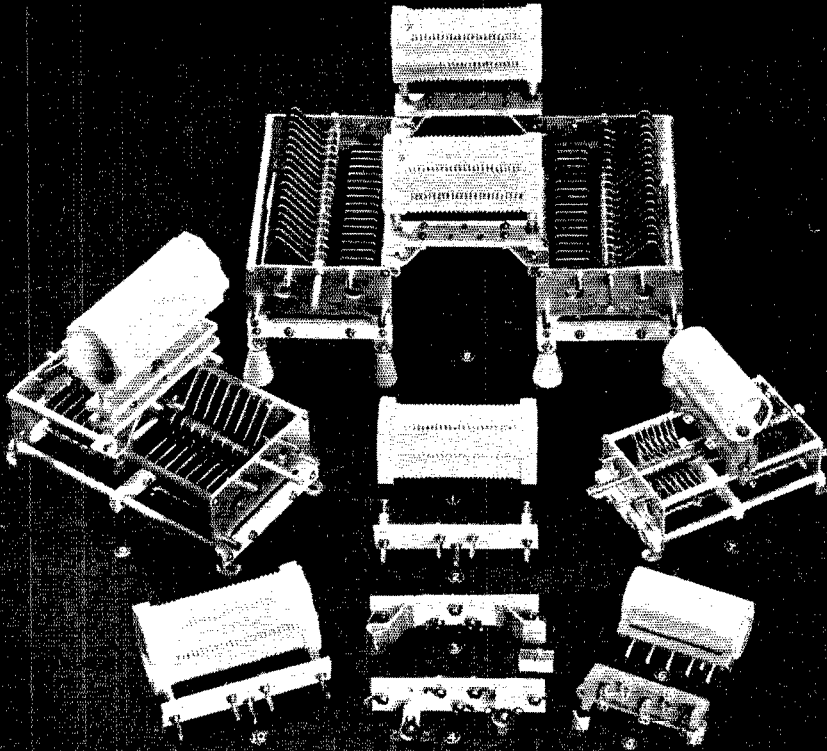

PARTS for ASSEMBLIES

Coils and condensers go together electrically, but sometimes not so well mechanically. To see how nicely National parts combine in assemblies, consider the photograph above.

The rigid, well-insulated structure for a "Collins-type" network is made entirely of standard National parts. XR-10A Coil Forms and Jack Bases (1 and 3) clamp rigidly on the tie bars of the TMA Condensers, which in turn mount on GS-5 stand-offs. For tanks, a single coil and condenser may be assembled with equal ease (9), with a plug base (2) for coil changing if desired. In similar fashion, the UR-13 and TMC assemblies for other purposes and of different power ratings can be built up readily (as in 7).

Next time you plan construction, thumb through the National Catalogue and plan your layout as a complete National Assembly.

{ All parts shown above are in the #260 National Catalogue,
 except the plug base (Fig. 2, Type PB-15, Net Price \$.81)
 and the jack base (Fig. 3, Type XB-15, Net Price \$1.05) }

NATIONAL CO., INC.



MALDEN, MASS.

FREE

A NEW ILLUSTRATED
BOOK EVERY ONE
INTERESTED IN
RADIO SHOULD OWN

"THE
INSIDE STORY
OF
RADIO BATTERIES"

It tells, and shows, how batteries are made, how they should be used to best advantage, what you should expect from them. It contains performance curves, charts and helpful technical information. Profusely illustrated.

If you want to be "up" on the latest in battery-operated sets, get this book. There's dope in it every ham will want.

SEND US THE COUPON
—WE'LL SEND YOU THE BOOK

NATIONAL CARBON COMPANY, INC.
P. O. Box No. 600, Grand Central Station
New York, N. Y.

Please send me free of charge the new book:
"The Inside Story of Radio Batteries."

Name _____

Address _____

QSTI

ode return circuit, is resonated at the oscillator frequency with no speech input to the microphone; therefore, this circuit offers a high impedance to the r.f. output from the plate, returning to the cathode through ground, and a degenerative voltage appears across it. This is impressed on Grid 4 and decreases the r.f. plate current in the output circuit. When the microphone is talked into, variations in its capacity occur which swing the degenerative section to either side of resonance. Although the change in capacity is relatively small, the change in impedance of the circuit is relatively great and modulation of the oscillator output occurs as the voltage appearing across the combination controls the r.f. output circuit through Grid 4.

All we can say from experimental results is that in a quick set-up which was made just to find out whether the idea worked, using 175-kc. components as the handiest obtainable, a good deal of modulation did take place; so much so that the output of this unit fed into a diode rectifier gave about the same audio output as the microphone used in the circuit shown in Fig. 1. There were no means at hand, at that time, to check the percentage of modulation or efficiency, and the work was carried no further. However, the circuit did show possibilities; and it may be noted that there is no reason why the oscillator section should not be crystal-controlled. What the interaction is between the elements of the tube during modulation at higher oscillator frequencies and how much, if any, frequency modulation occurs is yet to be determined experimentally. There is also no reason why a regenerative rather than a degenerative control could not be worked out, probably with greater efficiency. The degeneration is not taking place in the oscillator circuit proper but in the amplifier circuit associated with it.

There are also some very interesting circuits which were worked out experimentally in which the microphone was used in a polarized circuit with it and its associated cable forming a series feed-back link between an output stage and the input of the audio amplifier. It might seem at first glance that, with the ordinary high-gain amplifier, establishment of regeneration in the circuit would make it extremely unstable, since it usually has a tendency to instability in any case. But this did not prove to be true. Using the microphone as a coupling capacitance to provide regeneration, as was done here, gives a circuit which is much more efficient at the high frequencies than at the low. It seems, however, that the amplifier tends to be unstable at fairly low audio frequencies but has sufficient losses at the high frequencies to prevent it from going into oscillation easily. The microphone in such a circuit, because of its relatively low capacity, feeds back practically no energy at the low frequencies but a comparatively high amount of energy at the higher frequencies. Thus, the high-frequency response of the amplifier is very greatly increased without sacrifice of stability and without the losses usually associated with equalizing circuits. This circuit worked very well indeed and it has everything to recommend it except that the

FOR "PEAK"

ALL-STAR
TRANSMITTER

PERFORMANCE



★★★ REFINED

Thordarson Laboratories offer new suggestions for getting "Peak" performance from the All-Star Transmitter. Send at once for your copy of Bulletin SD-262.

100% Excitation Increase

Following the suggestions given in Bulletin SD-262 the excitation of the All-Star line of transmitters can be increased 100% and still retain all original efficiency.

New Developments for All Bands

These tested and approved suggestions apply to 10, 20, 40, 80, 160 meter operation of All-Star Transmitters. Don't delay. Send now for your free copy of Bulletin SD-262. Write Dept. Q-72 or see your parts distributor.

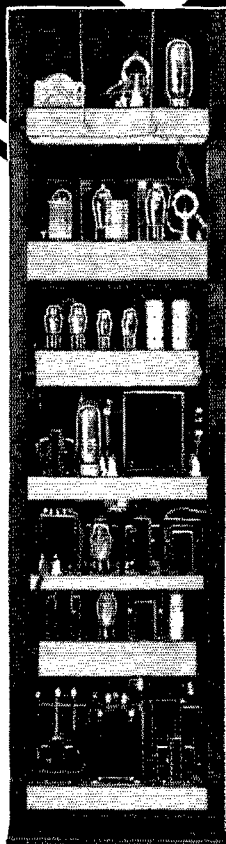

THORDARSON ELECTRIC MFG. CO.

500 W. HURON ST., CHICAGO, ILL.

Demand "Power by Thordarson"

New! UNEXCELLED AS COMPACT LOW COST TRANSMITTING CONDENSERS

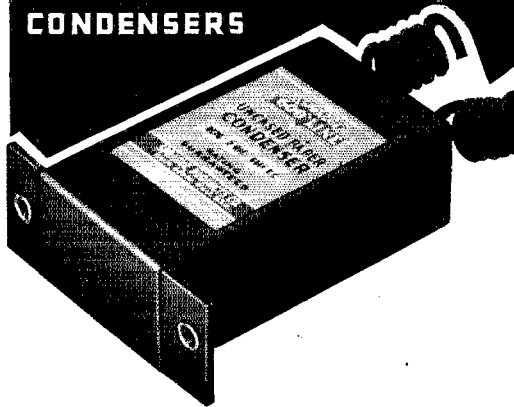

SPRAGUE

Type UC "CASED" Uncased Paper Sections

*Sealed in Heavy Cardboard Containers
Save the Cost of Metal Cans*

WHETHER you're an amateur interested in building a reasonably priced Transmitter, or a serviceman replacing an old condenser block, you'll find these new Sprague Paper Sections unexcelled.

It is hard to describe in words the vastly improved appearance of these Condensers. That's why I urge you to go to your jobbers and see for yourself. Note how cleverly we seal the units so the wax cannot melt and so moisture cannot possibly creep in.

Available in capacities of 1 and 2 mfd., in voltages of 400, 600, 800 and 1,000 volts. You have my personal guarantee that they're honestly rated and WILL NOT BREAK DOWN if operated according to their ratings.

If you don't like these condensers after a fair trial you have my full permission to return them personally to me for full credit.

Try them today! If your jobber does not have them, send me your orders direct. Prompt shipment will be made. Ask for our new Catalog describing the complete Sprague line including our new fixed mica 600 working volts condensers.

Harry Kalkreuth
Sales Manager,

Cat. No.	Capacity Mfd.	D.C. Voltage	Dimensions	List Price	Your Price
UC-54	.5	400	2 x 1 x 1 1/2	\$.50	\$.30
UC-14	1	400	2 x 1 1/2 x 1 1/2	.75	.45
UC-24	2	400	2 x 1 1/2 x 1 1/2	1.15	.69
UC-34	2	400	3 1/4 x 1 1/2 x 1 1/2	1.15	.69
UC-16	1	600	2 x 1 1/2 x 1 1/2	.90	.54
UC-26	2	600	3 1/4 x 1 1/2 x 1 1/2	1.35	.81
UC-18	1	800	3 1/4 x 1 1/2 x 1 1/2	1.25	.75
UC-28	2	800	4 1/4 x 1 1/2 x 1 1/2	2.00	1.20
UC-11	1	1000	4 1/4 x 1 1/2 x 1 1/2	1.50	.90
UC-21	2	1000	4 1/4 x 2 x 1 1/2	2.50	1.50

SPRAGUE PRODUCTS CO.

North Adams, Mass.



USE SPRAGUES . . . and Note the Difference

combination must be determined experimentally. Hence the circuit can hardly be used "commercially" where it would be in the hands of the layman; but to the amateur wishing to improve the high-frequency characteristics of his equipment without sacrifice of gain, it is well worth trying.

Radio Fadeouts Through 1936

(Continued from page 35)

With the sudden ionization below (or in) the E-layer, sudden changes occur in the currents flowing there, currents which are the cause of a certain part of the earth's magnetism. The changes in these currents directly cause the special magnetic fluctuations which are observed, and also inductively produce changes in earth currents.

The absorbing ionization and the radio fadeouts are produced on the illuminated side of the earth and do not occur on the dark side. They are most intense where the sun's radiation is perpendicular (i.e., around noon and at low latitudes). This distribution is also true of the special terrestrial magnetic variations, and probably of the earth-current and other phenomena if any. The effect is thus quite distinct from ordinary magnetically-disturbed periods, sometimes called magnetic storms, whose effects are much more marked at high than low latitudes. Ordinary magnetic disturbances and the special effect here reported have no necessary connection with each other, except for a general tendency to occur more frequently when sunspots are more numerous. Ordinary magnetic disturbances occur simultaneously with lowered ionization density in the F_2 layer, as shown by my colleagues.² Thus magnetic storms and the special magnetic effects simultaneous with radio fadeouts are associated with different levels in the atmosphere. It is believed that certain rare observations reported in the past by astronomers, of magnetic pulses simultaneous with visible solar effects, such as the coincidences reported by Prof. C. A. Young as occurring on August 3 and 5, 1872, were the special type of magnetic effect now found to be associated with radio fadeouts.

I wish to record my appreciation of the valuable assistance given by the amateurs in this investigation. The importance of the part they have taken can be judged by the fact that amateurs observed and reported the fadeouts of November 28, 1934; December 17 and 23, 1935; and the following in 1936: Feb. 6, 8, 14, 16, April 8, May 25, 26, 28, June 3, 9, 10, 19, Aug. 25, Nov. 6. In every case the times of the phenomenon as reported by different observers agreed within a few minutes. The amateurs gave data for locations not otherwise reported.

As there is reason to suppose that radio fadeouts (and the associated magnetic and other phenomena) are caused by one type of ultraviolet

² Kirby, Gilliland, Judson, Smith, Reymers, *Phys. Rev.*, 48, p. 849, Nov. 15, 1935; and 50, p. 258, Aug. 1, 1936.

EIMAC 250TL and 250TH TUBES

The Practical Answer to Amateur High Power

AT ANY PLATE VOLTAGE AND AT ANY FREQUENCY THE 250TL AND 250TH TUBES PROVIDE AN ECONOMICAL ANSWER TO THE PROBLEM OF OBTAINING HIGH POWER

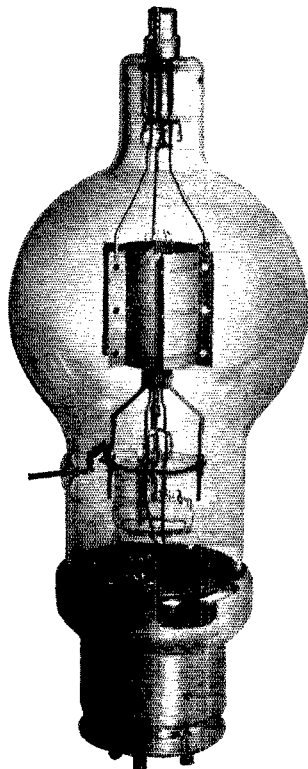

EIMAC
250TL
AND 250TH

▲ A kilowatt of class "B" audio power from a pair of 250TL or 250TH tubes.

▲ A single 250TL or 250TH tube will permit a carrier power of 125 watts in a conventional class "B" R.F. linear amplifier. (33% eff.) Higher carrier powers with more efficient circuits.

▲ A kilowatt input to a pair of 250TL or 250TH tubes with plate voltages as low as 1500. Higher inputs and efficiencies can be obtained at higher plate voltages.

▲ More than a quarter kilowatt of output power can be obtained from a 250TL or 250TH operating as a frequency doubler.

▲ The 250TL and 250TH tubes make excellent class "C" amplifiers for the ultra high frequencies. Outputs of more than a half kilowatt can be obtained from a pair of these tubes at 100 megacycles.

Why Guess at Your Transmitter Efficiency?

The use of tantalum for anodes in EIMAC tubes has given to the amateur a useful method of visually checking transmitter efficiency. The color of the anode of the newer EIMAC tubes at ratings is best described as a bright orange-red. Coloring of the anode is first noted at about 40 to 50% of maximum ratings. It is suggested that users of

EIMAC tubes, by means of a variable power supply, dissipate various wattages on the anodes of their tubes. Either by making a mental note of the color at various dissipations or better still by calibrating a photometer as used for home cinema work, a fairly accurate method of estimating plate dissipation is obtained. On the lower frequencies the power input minus the plate dissipation gives a close approximation of transmitter outputs. An instant check on the balance of loading, neutralizing, and excitation on push-pull amplifiers is obtained by noting the variation of color on the anode of EIMAC tubes.

SEE THE NEW 250TL AND 250TH TUBE AT YOUR DEALERS TODAY. NET PRICE TO THE AMATEUR ONLY..... \$24.50

EITEL-McCULLOUGH, INC.

San Bruno, California, U. S. A.

Say You Saw It in *QST* — It Identifies You and Helps *QST*

NEW as 1937

The *Utah*

ADD-A-UNIT AMATEUR TRANSMITTER KIT

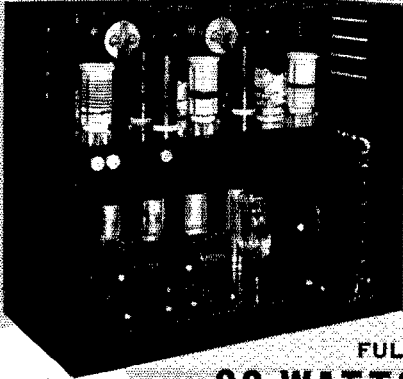

\$49.75

TWICE THE OUTPUT
AT TWO-THIRDS
THE COST.

FULL
80 WATTS
INPUT

A C W TRANSMITTER
that operates on 20-40
80 and 160 Meter Bands
MODERN—POWERFUL

EFFICIENT—EASILY ASSEMBLED

BUILD this Utah Add-a-Unit Transmitter yourself! Here's your opportunity to obtain a 80 Watt input C. W. Unit at an amazingly low cost. Every part you need, with the exception of meters, tubes and crystal, the complete equipment for a fraction of the cost of an assembled unit. It's a new, simple circuit, easily assembled.

Build this unit, and you have a powerful 80 Watt input C. W. Transmitter complete with built-in power supply to which you can add other units that will be available in kit form so that eventually you can have a complete Half K. W. phone transmitter at a fraction of the cost you would otherwise pay.

TELL ME about how I can easily assemble my own transmitter with the possibility of adding to it later.

Name _____

Address _____

CHECK HERE for information on UTAH replacement parts

UTAH RADIO PRODUCTS CO.
CHICAGO, U. S. A.

TORONTO
Ontario, Canada

BUENOS AIRES
(Ucoa Radio Products Co.)

15 YEARS OF LEADERSHIP

(i.e., ultra-visible) solar radiation, and that ordinary magnetic disturbances, auroras, etc., are caused by a solar emanation of different character, these phenomena present powerful means of keeping track of two different and very interesting types of events on and in the sun. Although these events are sometimes accompanied by visible radiation, nevertheless the emanations which cause the terrestrial effects are outside the visible spectrum and probably do not penetrate through the atmosphere to the earth's surface at all. Further study of radio fadeouts is thus eminently worth while, as it furnishes information of value to astronomers and geophysicists as well as those of us whose primary concern is radio transmission.

Educational Radio Broadcasts Over W1XAL

YOU have achieved the impossible . . . being both entertaining and instructive." ". . . just about the finest thing that has been put on the air." "Please send the blueprints and drawings you spoke about so I can enroll in the club. . . ."

And in they pour, the requests to "join up" with the most distinctive vocational educational broadcast program on the air—the lectures on "Modern Radio" over W1XAL at 7 P.M. EST each Monday evening. This is an instruction course conducted by C. Davis Belcher, instructor in Commercial Radio Operation, Massachusetts University Extension, member of the staff of Eastern Radio Institute and of the staff of W1XAL.

In conjunction with this course there has been worked out a unique plan of combining visual and aural instruction by mailing to enrolled students blueprints and circuit diagrams illustrating the various lectures. The instructor in Boston uses a large blueprint to which he constantly refers during the lecture as a professor would to a blackboard in the classroom. The same blueprints in the hands of listeners really act as miniature blackboards all over the world. Listening to the broadcasts is, of course, free; an enrollment fee of one dollar covers the cost of preparing and mailing the blueprints, which are mailed upon request.

Following the lectures there is given a course in International Morse code in which the speeds are graded to suit all different classes of listeners. This feature is particularly valuable to amateurs. W1XAL's frequency on these broadcasts is 6:04 Mc.

These broadcasts are carried on a non-profit basis, as are all the activities of W1XAL. The station is operated by the World-Wide Broadcasting Foundation, of which Walter S. Lemmon is founder and president, an organization maintained by individual subscriptions and largely sponsored by a group of leading educa-

A. C. RELAYS

Made by

Allen-Bradley

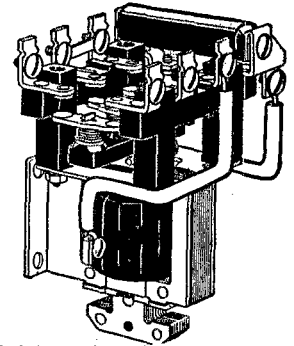
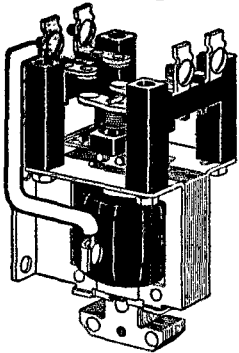

These A. C. solenoid relays are ideal for remote control of transmitters, for control of crystal ovens, and for any general remote control application except for keying. THESE RELAYS WILL NOT OPERATE IN KEYING SERVICE. Silver-to-silver double-break contacts are used throughout.

The maximum contact rating is 10 amp. at 220 v. or 3 amp. at 550 v. The relay coils are wound for 115 volts 60 cycle alternating current. Relays for other voltages can be supplied on special order. Use coupon below.

Type No.	Poles	Nor- mally	Action	Circuit Diagram	Price		Type No.	Poles	Nor- mally	Action	Circuit Diagram	Price	
					Open	In Cab.						Open	In Cab.
A107	1	Open	SP ST		\$3.50	\$4.50	A177	1	Closed	SP ST		\$7.50	\$8.50
A117	1	Closed	SP ST		4.50	5.50	A207	2	Open	DP ST		4.00	5.00
A127	1	Open and Closed	SP DT		5.00	6.00	A217	2	Closed	DP ST		6.00	7.00
A137	1	Open	SP ST		4.00	5.00	A227	2	Open and Closed	DP DT		7.00	8.00
A147	1	Closed	SP ST		5.00	6.00	A237	2	Open	DP ST		4.50	5.50
A157	1	Open and Closed	SP DT		5.50	6.50	A247	2	Closed	DP ST		6.50	7.50
A167	1	Open	SP ST		6.50	7.50					 <p>Radiostat—A stepless graphite compression rheostat for primary of 550 watt filament or plate supply transformer. Range 4 to 150 ohms. Price \$6.50</p>		

ORDER BLANK—MAIL WITH REMITTANCE TO

Allen-Bradley Co., 108 W. Greenfield Ave., Milwaukee, Wis.

Enclosed find money order for \$..... for which please send me, shipping charges prepaid, the following items:

..... for..... Volts..... Cycles

Name.....

Address.....

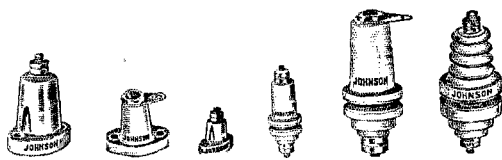

Headquarters for STAND-OFF and THRU-PANEL INSULATORS

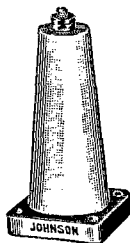

Why have discriminating amateurs standardized on JOHNSON Insulators?

Because . . . there is a better JOHNSON insulator for every application.

Because . . . JOHNSON insulators combine effective insulation with high mechanical strength, without excess bulk.

Because . . . exclusive JOHNSON features give you the most in utility and convenience.

Because . . . JOHNSON insulators cost no more than substitutes.

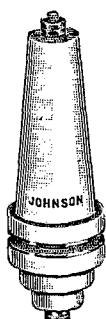

Ask your Jobber for JOHNSON Stand-Off and Thru-Panel Insulators.

Free Catalog 961 describes these and other Johnson Transmitting Equipment Parts.

Export Office: 25 Warren St., New York, N. Y.
Cable: "SIMONTRICE"

E·F·JOHNSON·COMPANY
MANUFACTURERS OF *Radio Transmitting Equipment*
● WASECA MINNESOTA U.S.A.

NOW HEADSET ADAPTER KIT by TRIMM

The Trimm Headset Adapter Kit fills a long felt need for a simple means of adding a headset to the present day radio. No longer need the family be kept awake at all hours of the night with a loudspeaker; and in addition, weaker signals can be more clearly heard.

Write for full information

TRIMM RADIO MFG. CO.
1770 W. Berteau Ave. Chicago, Ill.

tors in the Boston area. Information concerning the scope and activities of the organization is gladly mailed to all requesting it.

Standard Frequency Transmissions

Date	Schedule	Station	Date	Schedule	Station
Feb. 10	C	W9XAN	Mar. 10	C	W9XAN
Feb. 12	B	W9XAN	Mar. 12	B	W9XAN
	A	W6XX		A	W6XX
Feb. 17	BB	W9XAN	Mar. 17	BB	W9XAN
Feb. 19	BB	W6XX	Mar. 19	BB	W6XX
	A	W9XAN		A	W9XAN
Feb. 20	BX	W6XX	Mar. 20	BX	W6XX
Feb. 21	C	W6XX	Mar. 21	C	W6XX
Feb. 26	A	W6XX	Mar. 26	A	W6XX
Mar. 5	B	W6XX			
	B	W6XX			

STANDARD FREQUENCY SCHEDULES

Time (p.m.)	Sched. and Freq. (kc.)		Time (p.m.)	Sched. and Freq. (kc.)	
	A	B		BB	C
8:00	3500	7000	4:00	7000	14,000
8:08	3600	7100	4:08	7100	14,100
8:16	3700	7200	4:16	7200	14,200
8:24	3800	7300	4:24	7300	14,300
8:32	3900		4:32		14,400
8:40	4000				

Time (a.m.)	Sched. and Freq. (kc.)
6:00	7000
6:08	7100
6:16	7200
6:24	7300

The time specified in the schedules is local standard time at the transmitting station. W9XAN uses Central Standard Time, and W6XX, Pacific Standard Time.

TRANSMITTING PROCEDURE

The time allotted to each transmission is 8 minutes divided as follows:

2 minutes—QST QST QST de (station call letters).

3 minutes—Characteristic letter of station followed by call letters and statement of frequency. The characteristic letter of W9XAN is "O"; and that of W6XX is "M."

1 minute—Statement of frequency in kilocycles and announcement of next frequency.

2 minutes—Time allowed to change to next frequency.

W9XAN: Elgin Observatory, Elgin National Watch Company, Elgin, Ill., Frank D. Urie in charge.

W6XX: Don Lee Broadcasting System, Los Angeles, Calif., Harold Perry in charge.

Schedules for WWV

EACH Tuesday, Wednesday and Friday (except legal holidays), the National Bureau of Standards station WWV will transmit on three frequencies as follows: noon to 1:00 p.m. E.S.T., 15,000 kc.; 1:15 to 2:15 p.m., 10,000 kc.; 2:30 to 3:30 p.m., 5000 kc. On each Tuesday and Friday the emissions are continuous unmodulated waves (c.w.); and on each Wednesday they are modulated by an audio frequency. The audio frequency is in general 1000 cycles per second.

Strays

Here's one that looks as though it might be a world's record for miles-per-watt on 'phone: K6LTZ, using a home-made 56-2A5 five-meter transceiver revamped for ten meters, worked W6KPR on two-way 'phone, April 10th. The distance is about 2400 miles. Power input was between 1.3 and 1.5 watts. Has anyone done better over a distance of a thousand miles or more?

WARDS ANNOUNCE

HALLCRAFTERS

HAMMARLUND

RCA

CARDWELL

TAYLOR

BRUSH

ELECTRO-VOICE

AIRLINE

TOBE

KEN-RAD

YAXLEY

APPOINTMENT OF
"Dixie Dave" Elam - W9FPP
 AS DIRECTOR OF WARDS
 AMATEUR RADIO
 ACTIVITIES



MR. ELAM is shown here at the controls of the new Super Sky Rider. Long a Ham himself, he will be able to give you expert help.

● In order to better serve its thousands of amateur radio customers, Ward's have appointed Mr. David Elam (W9FPP) as director of its amateur radio activities. Prominent as a Ninth District amateur, his work as Business Manager of last September's "Ham Fest" in Chicago (biggest amateur affair ever held) will long be remembered. At present he is chairman of the Chicago Area Radio Club Council; is generally recognized as an outstanding authority on 5-meter work and writes extensively on short wave matters.

Mr. Elam is now at your service; he will give you the expert service and advice that you would expect from an unbiased brother Ham. Don't hesitate to write him of your problems. *In addition*—Wards have issued the finest radio catalog they ever printed. Experts—manufacturers, writers, editors of radio magazines agree on this. It has the sensational new developments in ham transmitters, receivers, parts, P. A. equipment and servicemen's supplies. *Everything can be bought on monthly payments*; terms as low as \$3 Down, \$4 a Month. If you haven't yet received your copy, send coupon for it TODAY!

MONTGOMERY WARD

9 Great Mail Order Houses • More than 500 Stores
 CHICAGO • BALTIMORE • ALBANY • KANSAS CITY
 ST. PAUL • DENVER • PORTLAND • OAKLAND • FT. WORTH



Have
 You
 Your
 Copy
 Yet?

Every active licensed amateur in the U. S. has sent a copy of this book. If for any reason, however, you didn't get yours, send coupon AT ONCE... they're going fast.

Montgomery Ward, Dept. RA1

Name

Street

Postoffice

State

DON'T READ THIS

IF YOU LIVE IN PETROPAVLOVSK OR KHABAROVSK

Smart hams in all USA districts have purchased new equipment on the DEL *RAD payment plan. Write at once for complete price list and details. Down payments as follows—

New NC-101X	\$13.75
NC-100	13.00
NC-100X	15.50
HRO	18.45
1937 Super Pro	26.75
RME 69	14.75
Breting 14	11.50
1937 Super Sky rider	10.25

Time Payments on Transmitters and Parts Orders

A-1 Used Sets 50% to 75% Off Original List Prices

W3DQ has been a ham since 1910, and takes a personal interest in your radio problems. Reasonable trade-in allowance for your old receiver.

WILLARD S. WILSON—W3DQ
DELAWARE RADIO SALES CO.
 405 Delaware Ave., Wilmington, Delaware

About Harmonic Radiation

(Continued from page 24)

output. If an attempt were made to tune for maximum antenna current a harmonic content of 4% could well be attained. The minimum harmonic content, in fact too small to measure, occurs at a setting of C_1 of 34 or slightly on the

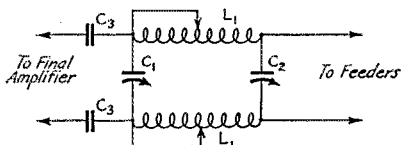

FIG. 6—CIRCUIT OF THE PI NETWORK USED IN THE TESTS

L_1 —24 turns, 3 $\frac{3}{4}$ inches long, 2 $\frac{1}{4}$ -inch diameter.
 C_1, C_2 —500- μ fd. variable condensers.
 C_3 —0.004- μ fd. blocking condensers.

capacitive reactance side of resonance. At this point the antenna current is also a minimum.

Fig. 8 shows the effect of decreasing the number of turns coupling to the final amplifier inductance. In this case the network was connected to only three turns of the 24 in the coil. Input was slightly less than in Fig. 7 and the output about 42 watts. Note that the harmonic content is much less in this case and does not rise as rapidly either side of minimum plate current. The plate current also rises more slowly. Harmonics are undetectable only at the exact minimum plate current. At 10 divisions off resonance they rise to

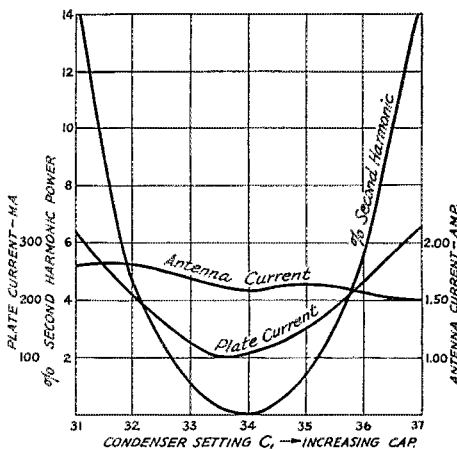

FIG. 7—THE EFFECTS OF MISTUNING THE PI NETWORK WITH CLOSE COUPLING TO THE FINAL TANK

Note the rapid rise in harmonic output with apparently slight misadjustment.

3% (not shown in Fig. 8). The antenna current again shows an increase because of harmonic content.

Similar production of harmonic radiation was obtained in both cases by slightly disturbing the resonance setting of the condenser in the final amplifier tank circuit and curves like those in Figs. 7 and 8 obtained.



A Division of L. S. Brach Mfg. Corp.

BRACH DeLuxe ANTENNA

Type BD-400

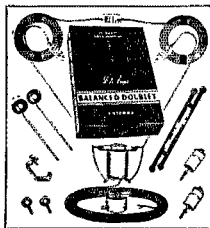

The remarkably improved performance, the greatly increased signal strength and the ultimate in noise reduction, has made this aerial outstanding in popularity.

Leading set manufacturers use and recommend this antenna with their deluxe radio sets.

Licensed under patents of Amy, Aceves & Kings.

Write Today for Our New Catalog

Equip Your Antenna with LYNCH GIANT KILLER CABLE
 The Perfect Transmission Line or Down-Lead

World's Largest Makers of Antenna Systems

L. S. BRACH Mfg. Corp.

Newark, N. J.



Est. 1906

STATION OPERATING SUPPLIES

For full enjoyment of your operating activities
you will want these forms designed to meet
your needs

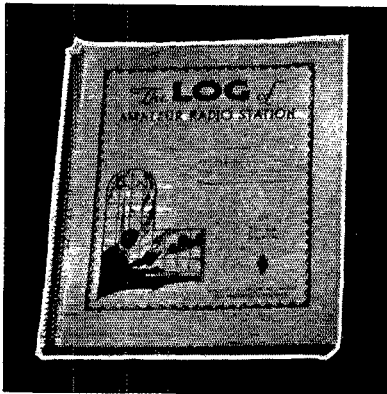

HANDY TO USE

The most interesting feature of the new LOG BOOK is the incorporation of spiral binding. This permits the book to be folded back flat at any page, requiring only half the amount of space on the operating table and making it easy to write on. The log-sheet has been re-designed by the Communications Department so that there is space provided for recording the number of messages handled and QSL's sent and received. General log information (prefixes, etc.) has been brought up-to-date. The LOG BOOK price has been reduced and is now 35c per book, 3 books for \$1.00, postpaid.

FOR PRESTIGE

The radiogram blank is now an entirely new form, designed by the Communications Department to comply with the new order of transmission. All blocks for fill-in are properly spaced for use in typewriter. It has a strikingly new heading that you will like. Radiogram blanks, $8\frac{1}{2} \times 7\frac{1}{4}$, lithographed in green ink, and padded 100 blanks to the pad, are now priced at 25c per pad, postpaid.

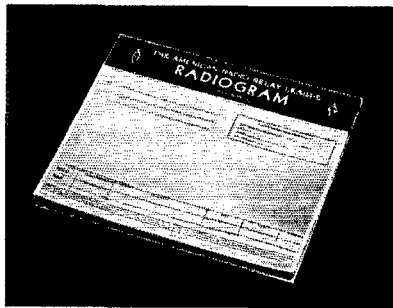

FOR CONVENIENCE

Radiogram delivery cards embody the same design as the radiogram blank and are avail-

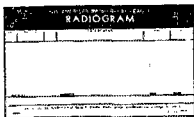

able in two forms — on stamped government postcard, 2c each; unstamped, 1c each.

AMERICAN RADIO RELAY LEAGUE, INC.
WEST HARTFORD, CONNECTICUT

Still TOPS

TYPES 4 AND 9 MICA X-MITTING CONDENSERS

Back in the early days of "Brass Pounding" Cornell-Dubilier Mica Transmitting Condensers were the "Tops." Today . . . in the estimation of thousands of "Hams" and Broadcast Engineers, they are still head and shoulders above the condenser crowd!

Compact . . . convenient . . . and dependable . . . the types 4 and 9 mica condensers are hermetically protected against all adverse atmospheric conditions.

See them at your local jobber, or write direct for catalog number 133A

Wet & Dry Electrolytics : Mica : Dykanol : Paper
CORNELL-DUBILIER CORPORATION
 1013 Hamilton Blvd., South Plainfield, N. J.



CORNELL-DUBILIER

LINK-COUPLER TUNER

Using the same excitation condition, the final amplifier was next coupled to the antenna system by a simple link coupling and antenna tuner, the feeders being tuned by series condensers. Coils L_1 in Fig. 6 were used to load the feeders to permit series tuning and an additional 12-turn coil with two-turn link was inserted between them. The link was connected across four or less turns of the final, depending upon the power output desired.

The harmonic output then was measured at various fundamental outputs up to 225 watts and the tank condenser varied either side of resonance as before. *In no case was the harmonic output greater than 0.2 watts or a maximum of*

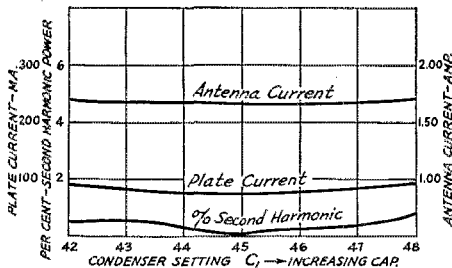

FIG. 8—EFFECTS OF MISTUNING WITH LESSER COUPLING OF THE PI NETWORK TO THE FINAL TANK

The fundamental output is practically the same as with the tighter coupling, but the harmonic radiation is tremendously reduced.

about 0.1%; and lack of perfect resonance did not increase this value as with the pi-network.

OTHER FACTORS

In all of the above tests the exciter was purposely operated under conditions known to favor harmonic production. The second buffer or driver, using a pair of 10's in parallel, had a tank circuit with a capacity of only 67 μfd . By changing to a smaller inductance requiring a capacity of 280 μfd , the exciter harmonic output was reduced to about one-tenth of its former value. Under this condition of exciter operation, and coupling the final to the antenna with link coupling, the radiated harmonics were too small to measure. Likewise, with the pi-network properly adjusted they could not be measured; but if either C_1 or the plate tank were disturbed harmonic radiation of a somewhat less degree was again obtained.

For those who do not wish to go to the trouble of constructing and calibrating a field strength meter very good indications of harmonic strength and the effect of various adjustments can be obtained by observing the R- or S-meter on the receiver. The receiver should be some distance from the transmitter and, of course, should be well shielded and only a very small pick-up used. By this means the exact setting of C_1 in the network for minimum harmonic can be observed. Also, it will be found often that a reduction or increase in excitation voltage will change the harmonic content.

MR. E. H. RIETZKE



PRESIDENT OF CREI

IF YOU ARE ONE OF THE **69%**
 ". . . CREI Training Will Improve Your Present Position" . . .

A recent survey discloses that despite the late depression, 69% of CREI graduates now have IMPROVED positions, and the average salary has increased 37.4%. TECHNICAL TRAINING will not only help YOU acquire the ability to succeed, but is necessary to keep pace with the many new developments in the industry. Take definite steps to insure your future by writing for—

A FREE COPY OF THE CREI "TESTED PLAN"
 An informative and illustrated 48-page booklet for professional radiomen who are not satisfied with their present positions in the radio field.

**CAPITOL RADIO
 ENGINEERING INSTITUTE**

Dept. Q-2
 WASHINGTON, D. C. NEW YORK CITY
 14th and Park Road 29 Broadway



It's Always LEEDS Who Leads

Rack Panels



By LEEDS are furnished with black shrivel finish in the standard 19" length, 1/4" thick. Mounting slots are spaced according to Bureau of Standards specifications, insuring freedom from all trouble in mounting or interchanging panels.

Steel	Price	Width	Aluminum	Price
PS-1	\$.52	1 3/4"	PA-1	\$.74
PS-2	.57	3 1/4"	PA-2	1.03
PS-3	.68	5 1/4"	PA-3	1.30
PS-4	.71	7 1/4"	PA-4	1.55
PS-5	.95	8 3/4"	PA-5	1.90
PS-6	1.15	10 1/4"	PA-6	2.45
PS-7	1.30	12 1/4"	PA-7	2.90
PS-8	1.50	14"	PA-8	3.35
PS-9	1.70	15 3/4"	PA-9	3.70
PS-10	1.90	17 1/4"	PA-10	3.95
PS-11	2.05	19 1/4"	PA-11	4.45
PS-12	2.30	21"	PA-12	5.20

Brass panel mounting screws 1/4" long 10/24 thread, 15c per dozen.

Masonite Crystalline finish panels, sizes as above, prices slightly lower.

NAVY TYPE TELEGRAPH KEY



List \$3.60. Navy knob — 1/4" Tungsten contacts. While they last. . . . \$1.15
With regular knob. . . . \$1.95

AEROVOX

OIL FILLED AND IMPREGNATED CONDENSERS

1 mfd. 1000 v. . . . \$1.59	1 mfd. 1500 v. . . . \$1.67
2 mfd. 1000 v. . . . 1.97	2 mfd. 1500 v. . . . 2.30
4 mfd. 1000 v. . . . 2.85	1 mfd. 2000 v. . . . 2.09
	2 mfd. 2000 v. . . . \$2.79

Electrolytic and tubular condensers in stock

HAMMARLUND "STAR" MIDGET CONDENSERS

A dandy variable condenser for receiving, transmitting, short wave tuning, verniers, etc., — the usual Hammarlund high quality, at unusually low prices.

Type	Mmf	Price
SM-15	15	.50
SM-25	25	.50
SM-50	50	.55
SM-100	100	.59
SM-140	140	.73
SM-35-X	35	.59
SM-50-X	50	.73

TRIMM 2000 ohm phones	\$.18
4000 ohm	\$.25
TRIMM featherweight	\$.58
DX 20,000 ohm imp.	\$.65

NOISE SILENCER ADAPTERS are a great help on reducing natural static too. LEEDS "QUIET CAN" and "SILENT CAN" also provide freedom from ignition noises and afford an ideal arrangement for push to talk phone and break-in CW.

LEEDS "Quiet Can" for receivers with 2 IF stages; complete with tubes and instruction. . . . \$7.95

LEEDS "Silent Can" illustrated herewith, for receivers with 1 IF stage; complete with tubes and instructions. . . . \$9.95

We Are Headquarters for the Following

Hammarlund — Meisner — Alladin — Triplett — Littelfuse — United Transformer — Cornell-Dublier — Thordarson

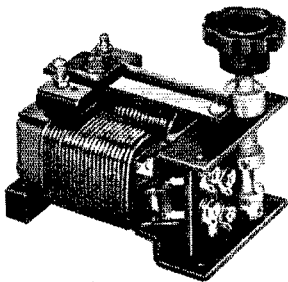

GENERAL RADIO Variac Transformers

A wonderful line voltage control, that is smaller, more convenient to use and furnishes high current over a narrow voltage range.

Type 70-B — 115 v. at 2 amps. . . . \$10
Type 80-B — 115 v. at 7.5 amps. . . . \$15

Write for Bulletin 67-Q for complete data

Here are two handy G.R. forms for that multiband transmitter.

Type 677-U — 21 turns, 2 1/4" diameter, resonant on 3.5 mc with 100 mfd. capacity; shipping weight 2 lbs. Price. . . . 50c

Type 677-Y — 30 turns 4" diameter, resonant 1.7 mc with 100 mfd. capacity; shipping weight 3 lbs. Price. . . . 75c

Also 7-pin base to fit above forms at 70c and a matching base with jacks at 65c.

G.R. 247M — .00025 condensers. . . . 49c

G.R. Amateur accessories always in stock

LEEDS

Completely shielded High Voltage

Transformer

Made for us by one of the most reputable manufacturers in this field.

300 MA

750-1000 v. each side. . . .	\$5.70
1000-1250-1500 v. each side. . . .	7.35
1500-2000-2500 v. each side. . . .	11.95

Thordarson Neon Transformers, 115 v. primary — 1500 volts at 20 mills. . . . \$1.45

Thordarson Cased Transformer, 600 volts each side of C.T. 200 ma 2 1/2 v. 10 amps. C.T. 5 v. 3 amps. 7 1/2 v. 3 amps. C.T. . . . \$2.45

Thordarson Choke, 12 H. 250 ma. . . . \$1.95

We carry the complete Thordarson line at 40% and 2% from list price.

COTO-Coil Low Loss Inductors

We have them for immediate shipment



LEADS THE FIELD

World Wide Service to Amateurs

45 Vesey Street
New York City

Tel. COlrand 7-2612

Cable Address: "RADLEEDS"

BASES and DEMI-BASES



By LEEDS for use with rack panels are now available in a greatly increased variety at lower prices. Crystalline finished units of 20 gauge steel; each base is finished with a bottom cover plate, so that apparatus underneath the chassis may be kept free from dust and at the same time electro statically and electro magnetically shielded.

8 1/2 x 8 x 2 \$65	10 x 17 x 2 \$1.10
8 1/2 x 10 x 270	10 x 17 x 3 1.30
8 x 17 x 295	12 x 17 x 2 1.30
8 x 17 x 3 1.15	12 x 17 x 3 1.40
	4 x 17 x 2 \$70



GOING LIKE WILD FIRE

Our NEW LD-5 \$10 Value Mounted Crystals

These low drift plates, factory sealed in the new LEEDS metal holder are outstanding from the standpoint of stability, accuracy, high output and low cost. Low Drift — 5 cycles per million per degree. Accuracy of calibration — better than .05%. Orders filled plus or minus two kc. of specified frequency. Last but not least, the price of the mounted crystals, anywhere in the 160, 80 and 40 meter band is only. . . . \$3.50

Money back guarantee if you are not completely satisfied.

LEEDS type A.L. metal crystal holder, as illustrated above, fits standard 5-prong socket.89c

NATIONAL

C R M Oscilloscope

Employing a 913 RCA tube; net \$11.10 (without tube). RCA 913 tube. . . . \$5.60

NC 100 — NC 100 X and 101 X Hammarlund "Pro" and "Super-Pro"

Sold on time at cash prices in Metropolitan area. No down payment.

Liberal allowance on your old set.

We carry the complete line of NATIONAL and HAMMARLUND.

The Bullet T.R. 2 Electro-Dynamic Microphone, made by Transducer Corp. Special. . . . \$23.23

Write for folder

TAYLOR Custom Built TRANSMITTING TUBES

T55 — 55 watt plate dissipation. . . .	\$8.00
T55 — 155 watt plate dissipation. . . .	19.50
T200 — 200 watt plate dissipation. . . .	21.50
866 Mercury Vapor Rectifying tube. . . .	1.65

All other types in stock

TRIPLETT METERS

All standard ranges; 0-10 to 0-1000 MA 3 1/2" bakelite case. . . . \$3.75

2" bakelite case. . . . \$2.94

READRITE milliammeters 15 to 400 mills; any range, each. . . . 59c

All Triplett testers at regular wholesale prices.

The record is 100% perfect. Thousands of microfans of LEEDS OIL FILLED CONDENSERS are in use without one case of failure.

1 M F 1000 volt D.C. working. . . .	\$1.10
2 M F 1000 volt D.C. working. . . .	1.45
4 M F 1000 volt D.C. working. . . .	2.00
1 M F 1500 volt D.C. working. . . .	1.45
2 M F 1500 volt D.C. working. . . .	1.95
4 M F 1500 volt D.C. working. . . .	3.25
1 M F 2000 volt D.C. working. . . .	1.75
2 M F 2000 volt D.C. working. . . .	2.45
4 M F 2000 volt D.C. working. . . .	4.65
1 M F 3000 volt D.C. working. . . .	2.50
2 M F 3000 volt D.C. working. . . .	4.95

LEEDS has the most complete line of Antenna Wire found in any shop. Hard and soft drawn wire — enameled copper — tinned copper — tinned wire — any length, at lowest prices.

Help

For the AMATEUR

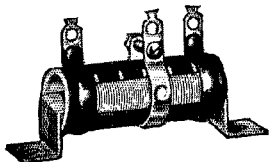

USE Electrad "Variohm" Dividers and get exactly the right plate, screen and suppressor voltages for those new pentodes. Five sizes from 25 to 200 watts to suit all power packs. 85c to \$3.75 each, list.

Write Dept. Q-2 for Complete New Catalog of Resistors for All Purposes



DO YOU WANT TO LEARN WIRELESS and TELEGRAPHY?

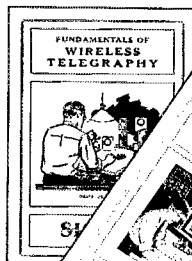

TWO BOOKS EVERY AMATEUR
SHOULD HAVE —

Send Now!

25¢
COIN, MONEY ORDER
OR STAMPS
Each
POSTPAID

Hundreds of amateurs have learned from these books, so can you.

These books give you the fundamentals of wireless and telegraphy. They contain the codes and how to learn them. Mail your order now to:

SIGNAL ELECTRIC MFG. CO., Menominee, Michigan

ESTABLISHED
1892



Harmonics higher than the second do not always have their minimum at the same condenser setting as does the second. The accompanying table shows in which direction C_1 has to be changed (slightly from resonance) for minimum harmonic output up to the ninth harmonic. A "plus" sign indicates a higher capacity setting and a "minus" sign lower capacity. "Zero" indicates resonance, as shown by minimum plate current. It should be pointed out that this table refers to a particular set of conditions and might not hold true for other transmitters and antennas. Harmonics higher than the third are generally weak and unimportant although occasionally do give trouble.

Oftentimes the strength of harmonics will change for no apparent reason. For instance, two local broadcasting stations have harmonics that fall in the amateur bands (3rd at 3900 and 7th at 7280) and consequently are often observed. At times these may be so weak as to be scarcely detectable and at other times are loud enough for program reception. The two extremes may change abruptly from one to the other; and yet the station operators have stated that no adjustments to the transmitter were made at the time.

SOME CONCLUSIONS

As a result of the tests that have been made a few general conclusions for reduction of harmonics from amateur stations can be made.

1. Harmonics will not be radiated if they are not generated in the transmitter. Low-C circuits and high efficiency operation of vacuum tubes tend to create strong harmonics. In exciter stages particularly, it is better to use larger tubes and operate them at low efficiency. A reasonable factor of safety is always good engineering practice. In this connection note the F.C.C. ratings of tubes for broadcast purposes wherein, for instance, a 203A is given a rating of 75 watts output. Remember that it takes about a ten-times increase in power output to increase the useful received signal strength noticeably, and that squeezing a few more watts out of the rig will not help the signal but may bring a "pink ticket" for interfering harmonics.

2. Do not use a pi-network unless you have a meter in the plate circuit of the final amplifier to indicate exact minimum plate current.

3. With the pi-network, do not tune for maximum antenna current.

4. The use of pi-network with tuned (Zepp.) feeders is not advised because a match cannot be obtained except under certain critical conditions which seldom exist.

5. Variable QSY systems such as variable air-gap crystals, e.c. oscillators or other means of rapidly changing frequency should not be used, particularly with a pi-network, unless the final circuits are retuned exactly with each frequency change.

6. If in any doubt about possible harmonic radiation, use a simple inductive coupling system such as the link-and-tuner arrangement rather than a pi-network.



Special Values

The Receivers listed below are the best money can buy. Our Time Payment Plan, at the new low rates, makes it easy to own one. Compare our rates with others. THE EASY WAY. Send in your Down Payment with your order. Sets will be shipped as soon as credit is okayed. Entire Transaction one week. Try us.

NEW HAMMARLUND PRECISION RECEIVER

Many new and unusual features include directly calibrated "band width" panel control; graduated sensitivity and audio gain controls. Cam operated knife switch has five shielded sections with silver plated knives and contacts. Band spread system with 12-gang condenser. 12 to 1 ratio direct reading dial calibrated in megacycles and kilocycles, accurate to within 1/4 of 1%. Signal to noise ratio on 14 megacycles is 8 db at .7 micro-volt input. Real high fidelity—30 to 7500 cycles within 6 db. Image ratio at 14 megacycles is 1900 to 1 and at 800 kilocycles it is 350,000 to 1.

The receiver covers five ranges of from 2.5 to 5; 5 to 10; and 10 to 20 megacycles and from 540 and 1160 and 1160 to 2500 kilocycles. Uses 16 tubes, 8 metal and 8 glass, including a 6F6 as a class "A" driver; and two (2) 6F6's operated as triode class "AB," as well as an 80 and a 5Z3 in the special power unit.

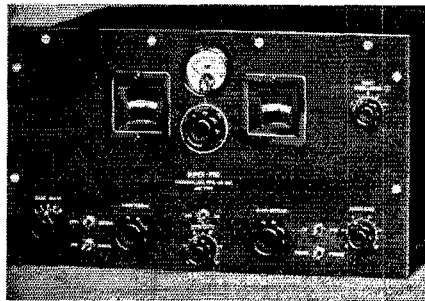

Complete with tubes, crystal and speaker... **\$255.70**

WATCH OUR LIST OF SPECIALS GROW

TRANSFORMERS

Thordarson No. T6878 Plate and Filament Transformer, 600-0-600 V. at 200 MA. 2 1/2 V. at 10 amp. 5 V. at 3 amp. 7 1/2 V. at 3 amp. **\$2.45**

High Voltage Transformer, 1000-750-500-0-500-750-1000-300 MA. 3 3/4 x 4 3/4 x 5 3/4 **\$5.95**

These transformers are heavy cast Iron Frame open mounting type. Heavy Insulation. Heavy Rockbestos leads. Fully Guaranteed.

1600-1335-0-1335-1600 A.C. R.M.S. 1250-1000 V. DC — 400 MA. 7" w. x 6" d. x 5" h. **\$13.25**

1950-1600-0-1600-1950 A.C. R.M.S. 1500-1250 V. DC — 500 MA. 8 1/2" w. x 7" d. x 7" h. **\$17.50**

2350-1950-0-1950-2350 A.C. R.M.S. 1800-1500-0-1500-2000 — 500 MA. 8 1/2" w. x 7 1/2" d. x 11" h. **\$22.50**

Filament Transformers

If you like to save money on quality merchandise here's some real bargains.
2.5 Volts 10 Amps — 2500 Volts Insulation — No. 2510 **\$0.95**
6.3 Volts, 3 Amps — 1600 Volts Insulation — No. 63S **\$0.95**
7.5 Volts, 3 Amps — 1600 Volts Insulation — No. 75S **\$0.95**

CHOKES

18 Henries, 125 M.A., \$1.15
A real quality choke. Resistance 130 Ohms. No. NS115 **\$1.15**
Thordarson No. T6877 Heavy Duty Choke. 15 henries at 250 MA. **\$1.95**

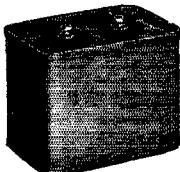

(Prices and Terms on These and Other Sets Listed Below)

	Cash Price	Down Payment	6 Months Payments	9 Months Payments	12 Months Payments
HAMMARLUND SUPER PRO complete with tubes, crystal and speaker.	\$255.70	\$55.70	\$34.62	\$23.44	\$17.86
NATIONAL NC-101X complete.	\$125.00	\$25.00	\$17.74	\$11.93	\$9.02
NATIONAL NC-100 complete with tubes and speaker.	\$118.10	\$23.10	\$16.90	\$11.37	\$8.59
NATIONAL NGX-100 complete with tubes, crystal and speaker to match.	\$140.60	\$25.60	\$20.26	\$13.64	\$10.36
NATIONAL HRO less power supply and speaker.	\$167.70	\$37.70	\$22.78	\$15.35	\$11.69
NATIONAL HRO with power supply.	\$183.60	\$43.60	\$24.46	\$16.51	\$12.57
RCA — AGR-175 complete receiver, speaker separate.	\$119.50	\$24.50	\$16.90	\$11.37	\$8.59
RME-69 — complete with tubes, crystal, speaker housed in baffle.	\$151.20	\$31.20	\$21.10	\$14.21	\$10.80
HALLIGRAFTERS SX-11 speaker in cabinet \$12.00 extra.	\$99.50	\$24.50	\$13.52	\$9.09	\$6.87

We will have new receivers, as released by manufacturers, on our deferred payment account.
Full details of any set listed, mailed immediately upon request.

Oil Filled, Oil Impregnated FILTER CONDENSERS

All well known makes. Guaranteed at rated voltages. A "lucky" purchase of a 10,000 lot enables us to offer a few remaining items at these low prices. Hurry before they're all gone!

Cap.	Voltage	Size	Weight	Price
1 mfd.	2000 V. DC	5 1/4 x 3 1/2 x 1 1/2	1 1/2 lbs.	\$1.25
2 mfd.	2000 V. DC	5 1/4 x 3 1/2 x 2 1/2	3 lbs.	1.50
8 mfd.	2000 V. DC	5 1/4 x 3 1/2 x 4	4 lbs.	2.75
9 mfd.	3000 V. DC	5 1/4 x 3 1/2 x 11	9 lbs.	7.25
(including 2 1/2" bakelite standoffs)				
4.4 mfd.	1500 V. DC	5 1/4 x 3 1/2 x 1 1/2	1 1/2 lbs.	1.75
5 mfd.	1500 V. DC	3 1/4 x 3 1/2 x 1 1/2	1 1/2 lbs.	1.90
3 mfd.	1500 V. DC	3 1/4 x 2 1/2 x 1 1/2	1 1/2 lbs.	2.00
10 mfd.	1500 V. DC	5 1/4 x 3 1/2 x 3	2 1/2 lbs.	2.75

Use the 10 mfd. for perfect filtering in class B modulation Power Supply.

ORDER DIRECT FROM THIS AD — NOW

Receivers listed in this ad are best values anywhere. Order today on EASY TERMS. Send your down payment with order. Set will be shipped immediately upon approval of your credit. Entire transaction in 1 week. No red tape. Full details of any item, with complete NEW CATALOG FREE upon request.

Bliley Crystals

BC3... \$3.95
LD2... 4.80
HF2... 6.50

EIMAC

35T... \$3.80
50T... 13.50
100T... 13.50
150T... 24.50

Taylor Tubes

866... \$1.65
756... 4.95
203B... 7.50
203A... 12.50
814... 18.50
822... 18.50
T200... 21.50

High Frequency Tubes

T55... \$8.00
T155... 19.50

FREE JUST OUT! BIG NEW CATALOG!

Big Bargains in Parts, Equipment and Supplies for Hams, Servicemen and Dealers. Lowest wholesale prices. Write quick!



NEWARK ELECTRIC COMPANY

226 W. MADISON ST. Dept. Q CHICAGO, ILL.

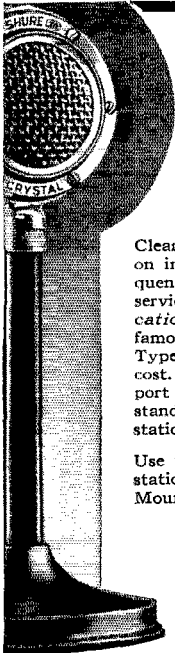

Communications Experts CHOOSE THE SHURE 70S

Clear, crisp speech . . . *double power* on important intelligibility speech frequencies . . . dependable 24 hour-a-day service . . . that's the *real communications performance* you get with the famous Shure 70S "Communications-Type" crystal microphone . . . at low cost. That's why a well-known air transport company installed a Shure 70S as standard equipment in each of its ground stations.

Use the 70S for hi-efficiency in your station. List Price, complete with Desk Mount and cable **\$25**

Also available in the Shure "4-Way Utility" model. At your Jobber . . . or write for Bulletin 129QC today.

Licensed under patents of the Brush Development Company.

SHURE MICROPHONES
SHURE BROTHERS • MICROPHONE HEADQUARTERS
225 WEST HURON STREET • CHICAGO, U. S. A.

Neobeam OSCILLOSCOPE Foundation Kit

Kit—Ready to assemble
\$24.50
Factory assembled—
Ready to operate
\$40.00

What it does: Checks modulation, locates distortion. Good for checking amplifier, microphone and speaker response. *Makes Sound Visible.* This kit makes a high grade, invaluable experimental instrument that every radio amateur should have. **FOUNDATION KIT** includes cabinet, etched chrome front panel, chassis, visor shield, front and rear terminal strips, special power and output transformers, variable speed scanning motor, mirror, and special neobeam tube. Accurate and reliable — an advanced instrument of advanced engineering design. *Easy to assemble.* Fully guaranteed.
ORDER TODAY

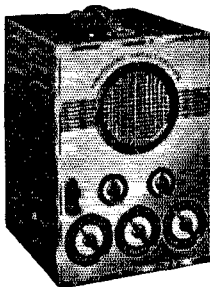
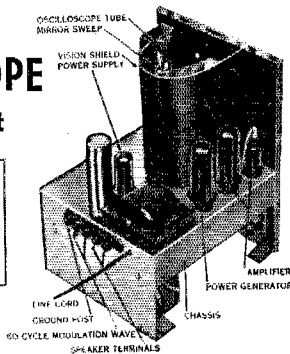

SENDT ENG. CO.

(Affiliate of Littelfuse Laboratories)
4246 Lincoln Avenue, Chicago, Ill.

"Makes Sound Visible"

7. In any system, use as small coupling to the antenna as possible. Stations have been contacted on their second harmonic, advised of the fact, and a reduction in coupling has immediately cleared the trouble.

8. Listen for your own harmonics on your own receiver and use a tuning indicator to adjust for minimum harmonic radiation.

The reason that the pi-network can increase harmonic radiation rather than suppress it is another story. For the present suffice it to say that a mathematical analysis of the situation indicates that a perfect impedance match is seldom, if ever, attained as this coupler is generally used in amateur stations. This applies particularly with feeder systems such as the Zepp which require tuning to resonance.

The Hudson Division Convention

THE Eleventh Hudson Division Convention, held at Schenectady on October 2nd and 3rd, attracted 340 amateurs from many sections of the country. Early arrivals Friday morning, after registration at the Hotel Van Curler, were treated to an extensive tour through the General Electric Company's shops, followed by a demonstration of u.h.f. police radio by Mr. H. Duval. The afternoon saw many conducted trips made through transmitting stations WGY, W2XAF, and W2XAD. On Friday evening the local engineers were provided with an opportunity to show the wonders of the "House of Magic," and their demonstrations will long be remembered. A party followed, featuring entertainment and plenty of refreshments.

Saturday morning gave the members of the Hudson Division Phone Association a chance to get together for their regular meeting. The afternoon meeting featured talks on various radio subjects, including "A.A.R.S." by Capt. David Tally, "N.C.R." by Lt. John L. Reinartz, "Antennas and Transmission Lines" by L. M. Leeds of the General Electric Company, "Heterotone C. W. Telegraph Reception" by James J. Lamb of A.R.R.L. Headquarters, and "A Substitute for Crystal Control" by John L. Reinartz of RCA. An A.R.R.L. meeting, presided over by Director Kenneth T. Hill, introduced President E. C. Woodruff and Vice-President George W. Bailey, and the many questions asked were answered by the League officials present. An A.A.R.S. meeting conducted by Captain Tally concluded the afternoon program. The YL's had not been neglected, during the afternoon meeting, their minds having been temporarily taken off radio by a sight-seeing trip around Schenectady and vicinity and a theatre party.

Director Hill acted as toastmaster at the banquet Saturday night, and introduced many notables, including Dr. E. C. Woodruff, George W. Bailey, Mayor Robert Baxter of Schenectady, Lt. Colonel S. W. Stanley and Lt. John L. Reinartz. The banquet was followed by a well-conducted prize drawing at which over 200 prizes were awarded.

—G. S. H.

FAIR DEALINGS *plus* FAIR PRICES

We "know what it's about" and go to no end of bother to get numerous specials to give QST readers many money saving values. Our customers of Foreign Shores find it profitable to buy direct from one of the world's greatest radio markets. We know just what declarations, etc., your country requires for prompt and economical delivery of your goods. We realize you are far away and fill your orders most carefully.

SPECIAL! WHILE THEY LAST The "EAGLE" Three-Tube Short-Wave Receiver

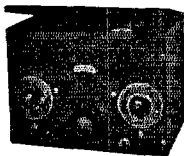

"Band Spread" over any portion of the tuning range — only finest material used thruout. Employs one '32 R.F., one '32 detector and one '33 Pentode Audio — 15 to 200 meters — four coils, supplied. The "EAGLE" is economical — two dry cells will operate the filaments.

"Eagle" completely wired and tested **\$9.95**
Three tubes tested in your receiver **\$2.50**

New CB-80 Radiophone and C.W. Crystal Controlled Transmitter

OUTPUT 100 WATTS
Goes down to 10 meters

Special Low Price — Literature on Request

Gross Value on U.T.C. Transformers

Cased, Stand-Off Bushings, Universal Mounting
Type A — Delivers 750/1000 volts A.C. at 300 M.A. **\$5.70**
Type B — Delivers 1000/1250/1500 volts A.C. at 300 M.A. **\$7.35**
Type C — Delivers 1500/2000/2500 volts A.C. at 300 M.A. **\$11.95**
Type D — Delivers 1000/1250/1500 volts A.C. at 500 M.A. **\$11.75**

AT LAST! PREMIER CRYSTALS

Gross Radio, realizing the needs of the ham for a real crystal, brought pressure to bear on Premier Laboratories, caterers to Government, Laboratory, Broadcast, and other commercial users of fine exact crystals.

Premier crystals now available at prices you pay for ordinary crystals. Formerly these crystals could only be bought by the lucky few able to pay the regular price 2 to 2½ times our price.

When you buy Premier crystals, you are getting the finest crystals money will buy, real power oscillators, full size approx. 1" x 1" (not small chips, etc.), expertly finished and guaranteed accurate calibrations.

Mounted in new No. 400 Holder of new PL-39 with hand-lapped plates. Available exclusively from Gross Radio in New York. Supplied for the 40-80 meter bands at a new low price.



Within 5 KC of specified KC
\$4.35

RECEIVER HEADQUARTERS!

We Are Authorized Distributors

RME 69, complete with tubes, .. \$134.90
RME DB-20 RF amp-selector... 39.90
Hallcrafters Sky Buddy complete 29.50
Hallcrafters Ultra Skyriders S-10 99.50
Hallcrafters Super Skyrider S-12 99.50
Hallcrafters Sky Chief complete 44.50
Hammarlund Super Pro..... 223.44

Come in for demonstration. Liberal allowances on your old set. Time payments arranged

GROSS TRANSMITTER KITS

CW-25 Output 25-30 watts (Crystal Controlled). Complete kit less tubes and crystal. **\$14.95**

P-25 power supply kit for above — 450 volts at 200 MA. **\$11.00**

CW-60

(Uses New Eimac 35T)

Output — 100 watts. Crystal Control Transmitter

Coils can be supplied for 30, 14, 7, 3.5, and 1.7 Bands. Complete Kit, with one set Coils, less tubes **\$20.95** and crystal.

Descriptive Bulletins on request

NEW!!

CW-50—Uses 6L6 Tubes

FB for 30 MC

Output — 50 watts

42 osc., 6L6 Buffer

2-6L6 amp.

Coils can be supplied for 30, 14, 7, 3.5, and 1.7 MC Bands. Complete Kit, with one set Coils, less tubes and crystal. **\$16.95**

Descriptive Bulletins on request

MODULATORS

**30 Watt (Beam Power)
4 Stages — \$29.50**

**60 Watt (Beam Power)
4 Stages — \$42.50**

*See December Issue Page 69
for Complete Information*

SPECIAL

6L6G.....\$99
6L6.....99
6L6G with Isolantite base.....1.75

NEW! "THE STANDBY" (2 TO 2000 METERS) 3-TUBE A.C. AND D.C. RECEIVER

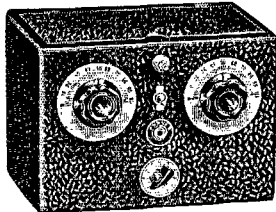

This excellent 2 to 2000 meter receiver is offered with full realization of the present-day need of the amateur for a dependable "standby" receiver which will cover practically all of the radio bands in use today. Super regeneration, which is the most efficient form of detection at these frequencies, is used from 2 to 15 meters. The R.F. stage is effectively used over the entire tuning range. Throughout the entire tuning range, there are no skips or dead spots. Loud speaker volume is available from practically every station received.

- 1000 to 1 tuning ratio ● Super regeneration below 15 meters
- Automatic change over from straight to super regeneration.
- Power supply incorporated
- Individual antenna tuning for high and low wave ranges
- 1-615C detector, 1-6J7 R.F. stage, 1-12A7 audio amp and rectifier.

Complete kit of parts, less coils, tubes, cab. **\$7.59**
2-5-10-meter coils (set of 3) **.95**
9½ to 15 meter coil **.39**
15-200 meter coils (set of 4) **.95**
200-310 meter coil **.39**
310-550 meter coil **.39**
550-1050 meter coil **.60**
1000-2000 meter coil **.60**
Metal cabinet... **1.50**
Kit of three tubes **2.40**
Wired and tested in our lab., add. **2.00**

WRITE IN FOR FREE NEW CATALOG ON HAM AND P.A. EQUIPMENT

20% DEPOSIT WITH ALL C. O. D. ORDERS

REMIT BY M. O. INCLUDE POSTAGE

Cable Address: GROSSINC

GROSS RADIO, INC., 51 VESEY STREET, NEW YORK CITY

STATION ACTIVITIES

(Continued from page 66)

DAKOTA DIVISION

NORTH DAKOTA—SCM, Hartwell B. Burner, W9OEL—DM at Rock Lake on T.L. "A" keeps daily schedules with 7CRH and 9WLL. SWC reports hearing 7EHH calling QRR Calgary on Dec. 14th on about 7150 kcs.; made attempt to hook him but failed; nevertheless, the old Amateur Spirit to the rescue. RPJ of Fargo will be on with a pair of 807's modulated by pair of 6L6's and is interested in O.P.S. appointment. TQZ of Maddock secured press operator's job at KOVC, Valley City. DWB and YHF are new 1.75-Mc. 'phones in Bismarck. YXB is new call at Watford City and YWC new Hope call. WWL has moved to Williston. PMI, formerly of Mylo, is now running radio shop in Dunseith. WME is C.O. C.C.C. Company at Medora. NZG and KZL, to pass time, engage in little friendly code competition. DYA spent Christmas holidays with folks in Minnesota. RQX is now working Break-in and likes it. FB. FKY of Valley City dropped in on the S.C.M. for a visit and plans low-powered rig to keep in touch with the gang. WLI, Grand Forks, now has crystal for 3605 kcs. on T.L. "H." RZA of Thompson is new O.R.S. and is looking for traffic. OEL is trying to get 6L6 rig to work. North Dakota A.A.R.S., District 1, is now divided with northern members transferred to ND2, taking big load off BMR and PQW. YIZ attends Science School in Wahpeton and will be on with 6L6 rig soon. And from YNX, our Grand Forks reporter, comes the following: WWU is working portable from W6 district where he is teaching school. YRD attends University and is new ham. YJK also attends University. JMW worked BTJ, now on the west coast. WFO is working portable 1.75-Mc. 'phone in Grand Forks. YCJ and WLI engaged in personal QSO contest with WLI winner. An N.C.R. unit has been organized in the near vicinity of Grand Forks with the following amateurs recruited: RZA, TSB, YCJ, WLI, WFO. We are thankful to YNX for this information and trust he continues as our Grand Forks reporter. Remember, you can clear your traffic via RZA, WLI and DM, who are O.R.S.

Traffic: W9KZL 165 DM 45 SWC 35 RQX 6 OEL 25.

SOUTH DAKOTA—SCM, Andrew J. Kjar, W9SEB—HEW, formerly at Ft. Meade Army station, is now located at Sioux Falls. TJX has sold his rig. OQV will be back on the air soon. DRB has new R.C.A. receiver. YNW has trouble locating SEB on 3.5 Mc. DRB is active on 3.5 Mc. PFI has swell-looking rig. BKK hopes to be on in a month or so. DIY has been having antenna troubles. CRY has been QRL Christmas trade and new job. SMS is building a new 6L6 rig. SOB is putting an 807 in final. WBSJ and YNW won 6L6 at Sioux Falls Radio Club banquet. ALO wants some of the gang on 1.75-Mc. c.w. evenings. VQN is building receiver around a De Jong tuning unit. Miller Club held election of officers: Pres., WGN; Vice-Pres., YLG; Secy., LDU; Publicity, PGV; Activities, Scofield. OED and WGN report a swell time at Sioux Falls Club banquet. PGV visited the Huron gang. WAJ is building a new 6L6 exciter unit. FOQ works 3.9- and 14-Mc. 'phone on Sundays. YOB is new member in Section Net from Rapid. Although living in different blocks, RWY and SEB are using same bell tower on a church to support far end of transmitting antennas. OXC is building a special rig for 28 Mc. PLF has transmitting antenna up. LBU says an 83 doesn't last very long in 1600-volt power supply. WLP is on 3.5 Mc. once in a while. Understand CFU is now working at Fargo, No. Dak. airport weather station. AZR reports traffic good on Trunk Line "G." Fifty attended the annual banquet sponsored by the Sioux Falls Amateur Radio Club. Hams were present from Miller, Brookings, Lennox, and Valley Springs, So. Dak.; Adrain and Luverne, Minn. The gang from Brookings nailed the best prizes. 9PFI acted as master of ceremonies. 9OED contributed a little talk representing the gang from Miller.

Traffic: W9AZR 453 WAJ 219 FOQ 103 SEB 86 VOD 45 PGV-OED 16 YOB 9 YNW 4.

SOUTHERN MINNESOTA—SCM, W. F. Soules, W9DCM—KUI reports that bugs in his rig prevented him from getting a decent score in the Sweepstakes. YNQ had the local power company set him a couple of poles. VRY is going places with 10-watt 'phone on 1.75 Mc. EYL has a new rig working on 7 and 14 Mc. OVN is having trouble getting that last continent for W.A.C. MZN has trouble keeping his antenna up. OGU left for sunny Florida. UBY finds that 242A does not work any more DX than his old '46's. EPD is putting up 14-Mc. array. POK is building a rack and

panel job with 6L6 exciter. FNK spends most of his time on 14 Mc. ragchewing. At last GLE got back on the air, EFFK still pounds brass from SJK. VJA has been experimenting on 56 Mc. DGH is putting in an Eimac 100T. KDI asks for O.P.S. FB. OT. GCZ goes to St. Olaf. LXC, KMN, SJH, IDF and SNF go to Careton. LEN is getting back on 7 Mc. HRH is QRL bowling and YL. DBC is back at DX after getting hitched, but finds new QTH lacking in DX punch. HGN bought back his rebuilt transmitter. KKM is QRL U. of Minn. FAE just got hitched and has new QTH. School takes up a lot of time for TKX, but still he has two new schedules. WEQ has a new rig on 1.75 Mc. BN is still going hot with same old schedules. DH is back on 'phone after rebuilding. IFT goes to Dunwoody. RKB is on 7- and 3.5-Mc. c.w. OVQ is experimenting with "¼ meter" rigs. ERT has been trying 56 Mc., but expects to be on 14 Mc. soon. FHH got on the air, but found the rig full of bugs. IJN received a listener's card from England for 28-Mc. 'phone. DCM is going to lose his radio room due to the new junior op., so consequently is building a shack in the basement.

Traffic: W9MZN 13 BN 6 DCM 5 TKX 3 KDI 2.

NORTHERN MINNESOTA—SCM, Leonard Hofstad, W9OWU—PTU made the B.P.L. on deliveries this month; he works on Trunk Line "A" daily. ORQ is buzzing around with a resonant filter. KQA sent an FB report. AZJ has gone to Detroit, Mich., to look for a job. RRN was married recently. Congratulations. He expects to live in Chicago. CWB won a Sky Buddy at the Duluth Hamfest; says it was due to his YL; she was late (hi) so he got a higher number. YKD is hard at work on new rig. KQA still has "haywire" antenna. YKD and KQA tried to grind a crystal, but so far nil. KQA has AZJ's, RVU's and GBN's equipment besides his own. RJF wants to sell his Hallicrafters Super Seven to the highest bidder. RJF has been acting DNC85 for RBA lately because RBA is troubled with QRN. VTH reports for the Willmar gang. VTH has a ten in the final with 175 watts input. VVA worked his first F8 on 7 Mc. MOW started a service shop in Benson. BFV is usually on noons and Sun. WVD will have an '03A going soon. MOV gets on 7 Mc. once in a while. VTH took Class A exam. TEF has a Sky Chief; he has received permission to put transmitter at the Sanitarium. He says, "Please tell the boys I'm not a patient." He is a night engineer. FUZ has 1.75-Mc. 'phone on the air. IGZ has received the Min-Dak Club's A.A.R.L. affiliation charter. HEO is going in for high power at last; going to have a pair of T55's with half a kilowatt input. YAP gets out nicely on 1.75-Mc. 'phone. OTW put in bridge rectifiers. Your S.C.M. blew all his money on a new Super Skyrider. 73. CU next month.

Traffic: W9FTJ 24 SXM 33 IGZ 9 ORQ 206 RTN 22 HDP 20 RJF 70 KQA 2 PTU 433 OWU 150.

CENTRAL DIVISION

ILLINOIS—SCM, L. John Huntoon, W9KJY—R.M.'s: I 9ILH, 9RMIN. P.A.M.: WC. Congratulations to ZN on Directorship! FTX caught flu from putting up new mast. Our Ex-S.C.M. WR was sick in bed for a week with gripe. SKR is helping school station UEU with nightly QST's. Jo tries to get out from under that mountain of QST's to rebuild his rig. Elmwood will be new QTH for TAD. DBO, besides being interested in 28 Mc., wants to join the R.C.C. Local hams "munching the bacon" with some punk in the next state causes QRN and headaches for SCH, who wonders why they don't use 3.5 or 7 instead of 14 Mc. After being at same location with same call fifteen years, BRX moved to Elmhurst. ACU enjoys 28-Mc. work. The "Old Buzzards" Club, on 1.75-Mc. 'phone, has as its object the raising of amateur 'phone operation efficiency and ethics; see ONR if interested. MCC is getting the ½ kw. under way. LIV thinks the new SS scoring system is the berries. ILLI-NOISE has discontinued publication due to lack of time by the publishers; thanks a million to you fellows who supported us. DOU (SPNG), now back in the Chicago area, reports JZY will return from the west coast shortly. (Maybe we can have some good traffic totals now, even if they both are "ball and chain" members.) NMZ is spending all available time with N.C.R. B.C.L. service keeps TAY hopping. SKF is holding down his Trunk (L) FB. HPG is back on Line "K." PNV is working G's with his new single-wire-fed antenna. DDO is another person on the sick list—hope OK soon. OM. ULO is going out for DX on 3.5 Mc. in between traffic schedules. VNW's travels limit his time on the air. GPK is trying to work up some traffic on 14 Mc.—14,064

kc. SG writes, "Awful busy." VEE's Christmas merchandising was hard on the traffic totals. NUF has 38,400 points in SS. All the summer's DX work was quite a strain on ANQ's rig, so he is rebuilding. MRH/SEU has pair of T-200's in final. MIN and BPU like their new HRO's. NHF endorses movement for clean language on 'phone stations. LLH really has a big line-up of schedules, all working nicely. The Johnson Q at COW was replaced with a 14-Mc. matched impedance outfit, with apparent good results. TZV asked Santa for a T-55. HOY from Iowa is operating portable at the U. of Illinois, handling traffic for students. VES finds he has been going at too high a pitch, so will have to cancel schedules temporarily. UHQ is now stationed at Fort Sheridan, reports RWS. RBR, former secretary of the "Hamfesters" Club in Chicago, is doing nice job of traffic work. AA, MCS, YSV and SUW were among those who heard 8CVQ (Kalamazoo) on 56 Mc. during the quiet hour on December 15th, about 120 miles airline, though no two-way contacts resulted. Thanks for the Christmas greetings, gang. We hope all of you enjoyed the Holidays.

Traffic: W9LH 707 RMN 633 EBX 487 TZV 158 KJY 131 (WLTK 15) HOY 106 SKF 87 NXG 84 VES 76 RWS 59 RBR 53 HPG 45 PNV 42 CGV 41 (WLTK 21) DDO 40 ULO 27 VNW 23 GPK 14 KMN 13 LIV 12 SG-VEE 7 NUF-MCC 5 ANQ-NTU 4 AA-BPU 3 CEO-NHF-PLL 2 FTX 1.

INDIANA—SCM, Arthur L. Braun, W9TE—"So few reports were received and tlc. so small, I am not sending in a Section report this month."—A. L. Braun.

MICHIGAN—SCM, Harold C. Bird, W8DPE—R.F.D. 2, Pontiac, Mich. J. Lessard, W9PDE, Ass't S.C.M., Box 223, Munising, Mich.; R.M.'s: 8RR, 8LSF. MICHIGAN EIGHTS: FWU is still minus his power pack. EGI is back with new antenna and pair of 46's and 80 watts. NGC is handling QMN Net and A.A.R.S. Net nicely. NQ is building oscilloscope for 'phone use, but is coming back on 3.5-Mc. c.w. for traffic. FX is handling Naval Net and is planning on coming on QMN Net. NXT says plenty of activity on 56 Mc. NQI is sure doing a nice job of traffic handling. NCB is pounding away on N.C.R. BRS is still pecking away on 7 Mc., but will be on 3.5 Mc. QGD says the city didn't want skywire across street so will have use 66-footer. FTW is doing nice job on Army and State Net. SH is interested in State Net. CSL moved into new home, and no skywire yet. DSQ is recovering nicely from recent illness. CFU is back after 3-year absence. Basketball keeps PXY QRL. DYH is using single 6L6 feeding ant. and is sure getting into fine. MV has rig on the air now. RR makes the B.P.L. First in Michigan for some time, I believe. Fine work, Jim. Keep it up. PDB is working 56 Mc. OEG is new reporter from up state; he works on 56 Mc. OXM is on 1.75-Mc. 'phone with pair of T65's. FQW is QRL service work. DLM is QRL electrical contracting. After taking a wife recently, best that DIV can do is work 28 Mc. BQC is new reporter from Ohio. OLD, another new reporter, expects to be on 3.9 Mc. soon. BQG has a nice new rig on 14 Mc. MPX made W.A.C. on 14-Mc. 'phone and is now back trying on 1.75 Mc. NIT, new reporter, says he expects to be on 14 Mc. soon. IOR is back! MICHIGAN NINES: 9PDE has a pair of '52's perking in final U.P. Net is working smoothly. CE suggests a map for entire state showing both nets. CWR says talk about crowded bands: CWR, SQG and CG all slept in one bed at Duluth Hamfest. CUC is working 28 Mc. PDE reports working a W7 station in the extreme northwest; while QSO he heard a VE2-calling him; he told W7 to QRX and took two messages from VE2 that happened to be for W7—district—this traffic all handled in about two minutes. A report on your activities will be appreciated.

Traffic: W8RR 537 DYH 14 PXY 21 CEU 1 FTW 113 OCU 165 BMG 10 BRS 9 JKO 38 NCB 15 NQI 36 NXT 3 FX 30 NCG 67 DPE 53. W9EGI 6 PDE 132 CE 21 CWR 56 (WLTK 87).

OHIO—SCM, E. H. Gibbs, WSAQ—In the All-Ohio QSO Party held December 13th, NKU won the C.W.T. prize with 135 points, and GMI the 'phone prize with 105 points. Fifteen logs were received, but many more took part. Look for another party in the near future. HMH is still the Section's star traffic man, making the B.P.L. for second successive month. HCS made the B.P.L. on deliveries and has moved to Stow. Report from ISK shows a nice bunch of traffic. New Jr. op at DVL, and this makes CIO a grandpa. FB. BBH will handle Ohio Gov. to Pres. message. LZE applied for O.R.S. Things are unsettled at RN until he can find work. IAW expects to plunge into the sea of matrimony in the spring, but claims we won't lose

him from our ranks. Time will tell. UW is now working a little DX on 14 Mc. along with A.A.R.S. and traffic work. NAL keeps five daily traffic schedules. BAH works special Traffic Net three times a week, and spends some time on 1.8-Mc. 'phone. WE is getting settled at new location and handled some traffic on temporary set-up. LCY is N.C.S. of the Ohio Regulars Net on 3710 kc. nightly. KIM works A.A.R.S. and Regulars Net. EEQ schedules four stations. NYY has new RME69 and preselector, and worked twelve VE's one morning on 1.8-Mc. 'phone. GSO is active in Regulars Net. LZK reports for Toledo gang and is taking Ohio position in Trunk Line "M." NUO, BZD and NKU are DX-ing on 14 Mc. KEV is building new Super Gainer. LAU is trying for W.A.S. on 3.5 Mc. MUR returns after an absence for rebuilding. KNF has new relay rack and is revamping rig to reach 14 and 28 Mc. HFR schedules five stations daily on 3946-kc. 'phone. An old-timer, VP, is back again on 3.5 Mc. and ready for traffic. MXW is on 3796 kc. regularly with pair of 46's in final. DXB is spending more time on 3.9 Mc. this season. LVW is building 28-Mc. rig: 6L6-6L6-T55. QHP's rig is being used as headquarters station of local 4-H Radio Club on 1817-kc. 'phone. OFN did fine work in SS with about 30,000 points. ARF, Toledo, is new O.P.S. active on 1.9, 3.9, 14 and 46 Mc. New tower at JTI is ready to be raised. Akron Progressive Club has new club house and an acre of ground. LUD is back on with T-55 final on 14 Mc. and is a charter member of OOOEB. GMI has been rebuilding for 14 and 28 Mc. JFC, Sharonville, is still working the world on 28-Mc. 'phone; he has two arrays to help the signals along. MDQ of Dennison applies for O.P.S. JLQ divides time between locals on 56 Mc. and DX on 28 Mc. ORM rebuilt again so as to work 14 Mc., and now looks for the elusive DX. Cincinnati gang reports en masse. NMS has new 50T, OII saved for an \$60 and is now saving for something to drive it with. HI. The first snow-storm took down BTT's vertical array. JIN thinks his new "Q" antenna is FB. NLQ discarded the faithful '10's, graduating to an HF-100. BKE wants more Ohio parties. KLP seeks comm. opr. job. LRV uses 7 and 56 Mc. BRQ has 3.5-Mc. rig, 6L6-211, nearly ready to go. OPT is increasing power and changing receiver to metal tubes. FFK's lake job ends January 15th. MFV is rebuilding rig for all bands. OED reports that the gang in Willoughby, Painesville, Waite Hill and Gates Mills are active on 56 Mc.; they are on regularly every Monday and Thursday evening after 7 P.M. and want to arrange for outside contacts.

Traffic: W8HMH 507 HCS 433 ISK 345 CIO 142 (WLHC 56) BBH 84 LZE 69 CMI 67 (WLHH 53) RN 69 IAW 55 UW 52 (WLHI 50) NAL 51 BAH 50 WE 48 LCY-KIM 33 EEQ 25 NYY 24 GSO 20 AQ 16 LZK 11 DVL-LAU-MUR 7 KNF 6 HFR 3 VP-MXW 1.

WISCONSIN—SCM, E. A. Cary, W9ATO—SES leads the state in traffic and is building new transmitter using 6L6G. GWK is back in Madison and using 53 and RK-20 on 3.5, 7 and 14 Mc. HSK has RK-20 in final. AKT is QRL work. ZNB is peddling papers to make money for more equipment. SZL joined A.A.R.S. RQM blew several new tubes and has '10 final now with 85 watts input. WSY is QRL school and trying to get rig going. WWO joined N.C. R.; he is operating on 3.5 and 7 Mc. UTH's YF presented him with a new YL opr. whose initials are RST! GYQ and TJG are entertaining the neighbors on 1.75-Mc. 'phone. Better be careful of QRM, boys! OUL added a few more fleas to his flea power rig. HKL says he is experimenting with wireless antennas (?). WGP is on 1817-kc. 'phone and worked 12 surrounding states. ESM has his new final amplifier finished, using '52 with 300 watts input on 7 and 14 Mc. TFS, O.O. at Green Bay, reports fewer r.a.c. notes. Let's find out who they are and help them clean 'em up. PBG is on every evening in Fond du Lac on 7 Mc.; he is ex-9CJG and has 56 osc. and 59 final. T. O. Jorgensen of Superior says he received XEN of Mexico on a galena crystal det. RBV's shack burned down while he was away from home. PSC got a new analyzer and took it over to TPO's to check the transmitter; they found that TPO was putting 225 watts into a pair of tens. Some '10's! UIR has trouble getting out. WYT is getting new parts for his rig. DXI has his rig all set up again. RZY is keeping schedules. FII is rebuilding. DPR has 5-watt rig going. ONI is looking for used 50-watt generator for emergency rig and also looking for new members for the State Traffic Net, in Northern Wisconsin. CLUBS: Green Bay Amateur Radio Club will soon be affiliated. TFS has charge of the arrangements. The Northwest Wireless Association held its annual Christmas party, Dec. 17th,

(Continued on page 104)

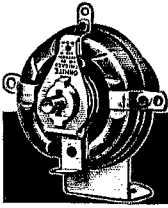

OHMITE BAND-SWITCH

For Easier Operation on Crowded Channels

More licenses issued daily — more amateurs on the air all the time — it's more often necessary to change frequency for clear transmission. Now, more than ever, you need OHMITE Band-Switches to avoid cumbersome coil changing. These modern accessories, mounted on your control panel, give you instant, flick-of-the-wrist QSY (frequency change). Ask your dealer or write for Bulletin 104 with diagrams for all basic circuits.



OHMITE MANUFACTURING CO.

4831 Flounoy St. Chicago, Ill.

HANDBOOK PAGES
518-519
CATALOG SECTION

Operating Data on the 100TH and 100TL

(Continued from page 20)

the well-known high-frequency features of the older Eimac tubes, plus some constructional changes which are said to improve the operation of the tubes at the very high frequencies.

Ratings and characteristics of the 100TH and 100TL are as follows:

	100TH	100TL
Filament voltage.....	5 to 5.1	5 to 5.1 volts
Filament current.....	6.5	6.5 amp.
Amplification factor.....	30	12
Grid-plate capacitance.....	2	2.3 μ fd.
Input capacitance.....	2.2	2 μ fd.
Output capacitance.....	0.3	0.4 μ fd.
Maximum plate voltage.....	3000	3000 volts
Maximum plate current.....	225	225 ma.
Maximum grid current.....	50	35 ma.
Normal plate dissipation.....	100	100 watts

As Class-B audio amplifiers the outputs obtainable at various plate voltages, with the optimum load resistance chosen in each case, are as follows:

Plate Voltage	Load Impedance Plate to plate	Power Output (# tubes)	
		100TH	100TL
1000	5200 ohms	210	170 watts
1250	7200 "	260	230 "
1500	9600 "	300	270 "
2000	16,000 "	380	350 "
2500	22,000 "	460	430 "
3000	30,000 "	500	465 "

A pair of 6L6 tubes will deliver more than enough power for driving purposes. The bias on the Class-B tubes should be adjusted to give normal plate dissipation (indicated by a bright orange-red color) under no-signal conditions. The 100TH can be operated at zero bias with plate voltages up to 1250.

Following is typical operating data on the tubes as Class-C amplifiers.

	100TH			100TL		
	1000	2000	3000	1000	2000	3000
Plate voltage....	1000	2000	3000	1000	2000	3000
Plate current (ma.).....	200	150	135	200	150	135
Grid current (ma.)	45	45	45	30	30	30
Grid bias voltage.	-70	-140	-210	-200	-400	-600

For r.f. power amplification, the 100TH is recommended in preference to the 100TL because its higher amplification factor makes it easier to excite. For the same reason, the 100TH is particularly suitable for frequency multiplication. Parenthetically, it may be noted that the 100TL can be used for direct replacement of the 50T in existing equipment, although the tube carries higher ratings than the type it supersedes.

Hamdom

(Continued from page 36)

"D", and president of the North Texas Radio Amateur Club. Currently in poor health, he still devotes every minute the doctors will allow to his radio. True to form, his other favorite hobby is telling fish tales. He likes a good clean fist, dislikes the lad who mishandles a bug. An ardent worker for amateur radio, he is an inspiration and guiding genius for his Texas radio friends.

ALADDIN

The new inductance-tuned i-f transformer (Type L)

TUNING is accomplished by changing the position of the Polyiron cores in the fields of the respective coils. High quality fixed capacitors are used instead of variable trimmers of the compression type.

Greater stability is afforded with this type when used under extreme conditions of temperature, humidity and vibration.

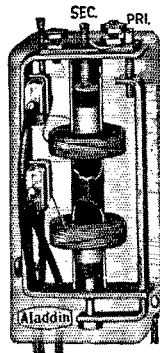

	List Price
L 150 converter for 262 kc.....	\$2.50 each
L 250 diode for 262 kc.....	2.50 "
L 101e converter for 465 kc.....	2.50 "
L 200e diode for 465 kc.....	2.50 "

ALADDIN RADIO INDUSTRIES, INC.
466q W. Superior St. Chicago, Illinois

Licensee of Johnson Laboratories, Inc.

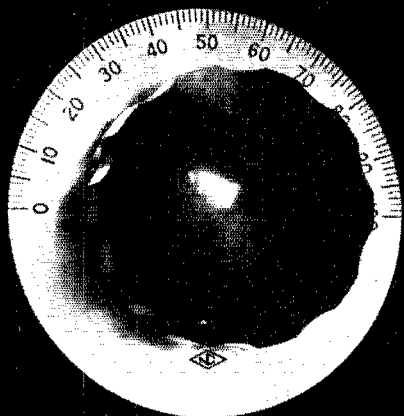

NET PRICE
\$.90

TYPE O DIAL

The National Type O Dial is definitely a handsome piece of equipment. The circular-grained, solid nickel-silver dial is $3\frac{1}{2}$ inches in diameter. Numerals and division lines are clean-cut and accurate. The large bakelite knob is well proportioned and comfortable to the hand. For safety, the dial is positively insulated from the hub by a large bakelite boss. Ask to see the National Type O Dial at your dealers.

NATIONAL COMPANY, INC., MALDEN, MASS.

ANNOUNCEMENT

The Bellefonte Radio Engineering & Manufacturing Co., Inc. is pleased to announce that they have entered into and are continuing with the business formerly conducted by the Bellefonte Radio Eng. Lab. and Bellefonte Crystal Lab. We wish to assure the friends of the old Companies the same courteous and prompt service and solicit their valued patronage.

We will forward you price lists upon request and offer all information concerning any type of quartz crystals

Bellefonte Radio Eng. & Mfg. Co., Inc.

(Continued from page 101)

and had lots of fun. Thanks to those who donated prizes. Now that the holidays are over, let's get together and put Wis. on top. What say, boys? Let me hear from you.

Traffic: W9SES 192 GWK 87 HSK 83 (WLTD 52) AKT 56 ZNB-SZL 46 RQM 31 GNT 9 WSY 3 HKL 2 GYQ 1.

MIDWEST DIVISION

IOWA—SCM, Owen Williams, W9NNM—Your new S.C.M. assumes the guidance of Iowa's activities with traffic handling in the eastern half of the state about zero. Live stations willing to maintain schedules and handle traffic are needed in all of the Mississippi River cities as well as in the larger inland towns. Reliable schedules will be arranged for those of you who will apply. Excellent trunk line service to and from the state is now in operation. We also need traffic men in Sioux City and Fort Dodge. Let's hear from you! LCX leads the state in traffic with a fine B.P.L. total. REH is up there too. NVF applies for O.R.S. CWG works locals on 7 Mc. VUS has moved to Ames. BUZ returned to Iowa City after a year in Davenport. PGG bemoans the loss of his buddy, GMM, who has moved to Los Angeles. DEA reports at length; he runs a half k.w. on 7 and 14 Mc., but B.C.L. trouble keeps him off of 3.5 Mc. VUQ worked his first DX, a ZL. The University of Iowa Radio Club shack suffered a Turkish bath from a burst steam pipe. The state A.R.R.L. Convention will be held at Newton this spring. The Iowa-Illinois Amateur Radio Club meets every Wed. evening on 1.75-Mc. c.w.; a good time is being had by all. FSH is going high power on 3.5 Mc. NLA is using Reinartz beam on 14-Mc. 'phone. MME likes his 66-ft. vertical. IPC is rebuilding. Four moves and a fire have kept PJR off the air. RZV is busy with traffic. SHY and WTD are very busy on 56 Mc. Have got rest of the club 56-Mc. conscious. UDR is practically on the air now. WNL works DX on 1.75-Mc. c.w.

Traffic: W9LCX 648 NNM 147 REH 143 PGG 92 NVF 54 VUS 37 VUQ-TTO 26 YBK 22 PAH 14 CWG 6.

KANSAS—SCM, Harry E. Legler, W9PB—Nice bunch of report cards received this month, but where are the other 200 that were sent out with the S.C.M.'s letter to all members? IQI is the new R.M., and provides an excellent outlet for traffic on Trunk "H" and National Trunk Net. WRK is new O.R.S. and can handle schedules all day long; pass your traffic through him if you want it to go places. Old faithful FLG reports nice total from activities on Trunk "K." LGR says the J's roll in fine on his new Breting 12. MFH and PLK copied Navy Day message, and MFH says Wichita N.C.R. Unit is building new headquarters station with 6L6's in final. OWZ handles some traffic, plus DX on 14 Mc. and rag chews on 3.5 and 1.75 Mc. AWP is teaching a code class of 25 would-be hams for W.A.R.C. YAH reports some traffic and his first DX in 88 contact. BYV inquires about O.B.S. and O.O. and is putting up 3 new 50-ft. poles. First reporter YFE is going after W.A.S., R.C.C. and traffic schedules. TVU says his 55-watt 'phone cannot compete with high-power boys at night. UEG applies for O.R.S. and sends nice account of activities around Hutchinson. HL sends application for emergency-powered A.E.C. and is arranging for daytime traffic schedules. 7FHZ is operating portable at Parsons for indefinite period. PHY wishes us luck in our new S.C.M. duties. A newcomer from Missouri is KCG who copies Trans-radio Press for KFBI. YRN is new ham in Salina and already reports traffic. CWW handled messages from Norway and asks about O.B.S. and O.O. LQW wants the dope on O.P.S. UWV keeps schedules with W6 on 28 Mc. and wants dope on O.P.S. PZA has new NC100X. UPH sports new Class A ticket. EJD worked Texas on 3.5 Mc. with A.E.C. portable rig using 6L6 and 6 watts input. Your S.C.M. heartily endorses the League's program to improve procedure and standards of 'phone operation and expects to promote this work in the Section. Get in touch with IQI, the R.M., for traffic schedules so your traffic will not have to be mailed.

Traffic: W9IQI 523 FLG 370 WRK 119 MFH 15 UEG 12 UPH 9 YAH 6 CWW-OWZ 4 YRN 2.

MISSOURI—SCM, J. Dewey Mills, W9CJR—ARH is QRL radio sales and service. GBJ is selling stamp collection to get cash for transmitter parts!! NNZ reports WEC, WBQ, WEM and WKF all active in Kirksville. DHN worked G5ML on 3.5 Mc. with 55 watts!! EDK is DXing on 28 Mc. LBA had his "Call Book Neighbor" LBB for visitor. JAP wants schedules with K.C. and St. Louis. EFC is again reporting active. KEI is keeping 5 daily schedules in addition to O.B.S. schedules. TGN is keeping A.A.R.S. schedules.

Miss OUD again makes B.P.L. with A.A.R.S. and Trunk schedules. AIJ is also hitting on high with A.A.R.S. schedules. SGP takes a poke at the S.C.M. for inactivity . . . said S.C.M. will fish the antenna outta the cabbage patch right soon now . . . that's a promise.

Traffic: W9AIJ 681 SGP 625 (WLUK 32) OUD 504 TGN 196 KEI 52 EFC 34 JAP 32 LBA 18 EDK 3 DHN 2.

NEBRASKA—SCM, S. C. Wallace, W9FAM—POB is going fine on Trunk Line "E" and keeping things moving in good shape. FAM is confining all activities mostly to Trunk Line "L." DI is keeping a bunch of schedules and doing his stuff on Trunk "B." UHT is busy pulling teeth and running out to the ham shack in the evenings and keeping nice bunch of schedules. UDH, newly appointed O.R.S., promises to be a real traffic man. KJP, BQR and TBF report. RWN is looking for some more good Nebraska schedules. YDZ reports for Norfolk gang: YDZ and YNO are in school; YRM exhibited his rig to local Kiwanis Club; VQO completely rebuilt on 1.75 Mc. 'phone; GFI is on and off; YHN at Pierce is going strong; YDZ is praying for a communication receiver; YRF is building super; YDZ, YHN and YNO are hard after W.A.S. VUG is planning new rig with T-55 in final. SGQ will soon have new rig with pair of 212D's in final on 3.9- and 1.75-Mc. 'phone. BBS is having good luck on 28 Mc. SMH returned to California.

Traffic: W9BNT 1141 (WLU 296) POB 310 FAM 289 DI 229 UHT 71 UDH 40 EHW 6 KJP 4 BQR 3 RWN 7.

WEST GULF DIVISION

NORTHERN TEXAS—SCM, Richard M. Cobb, W5BII—W5DXA, Route Manager, leads in traffic this month; he needs cards for W.A.C. and W.A.S. CIJ is using a 6L6 crystal and a 211-D now. EES is running several good schedules. BCW has six daily schedules and is going to try for the B.P.L. next month. FAJ reports DNE is feeling better. DNE's house burned, but his radio shack was undamaged. DVD sends totals by radio via DXA. CXW has just moved to Fort Worth; he is working for American Airlines. CPB reports from Austin; the Radio Club at the University is building a transmitter. FZJ is now O.R.S. and O.B.S.; his appointments being transferred to this Section. CPT finally got his W.A.C. certificate. AID is mostly on 3.9-Mc. 'phone; he is president of the 36th Division Radio Club. FBQ is proud of a new W.A.C. certificate. GBC wants some good traffic schedules on 7 Mc. AZB is experimenting and chewing the rag about fifty-fifty. ARV has been ironing out kinks in the rig. BXA reports from Gulfport, Miss.; he is now PX operator at WGCN, on the coast. FZU is 15 years old and likes to chew the rag on 7 Mc.

Traffic: W5DXA 427 CXJ 314 EES 223 BCW 216 FAJ 161 BAM 59 DVD 214 DW 27 EAV 13 FZJ 4 AID 3 FBQ 2 GBC 1.

OKLAHOMA—SCM, Carter L. Simpson, W5CEZ—CEZ discovered a crack in the envelope of his '03A; looks like a new one will be needed soon. EXZ has the Okla. Net working; it's all O.R.S. BTZ sent traffic report for the A.A.R.S. 'Phone gang. FOJ is working as A.A.R.S. Alt. 'Phone Net Control and in the C.W. Net, too. EGP has been appointed D.N.C.S. for Okla. 2nd Dist. A.A.R.S. CVA is now A.-D.N.C.S. for Okla. and Dist. A.A.R.S. FSK is going to make the B.P.L. before the season is over; he needs 3 states and 1 continent for W.A.S. and W.A.C. FFK is awaiting that new Breting 14. DWB has had his hands full taking care of his daddy-in-law's business and his own, too. FFC is a new member of the A.A.R.S. 'Phone Net. ADC is studying N.C.R. procedure and trying to keep from mixing Army and Navy Z sigs. BLT is Okla.'s movingist ham; yep, he moved again. GAQ is another new member of the A.A.R.S. 'Phone Net. EMH is expecting some DX cards from the QSL Bureau. EMD is having to do all of Okla.'s cipher busting; so far he is batting 1,000. FXG received O.R.S. appointment and is interested in N.C.R. AMT is building 56-Mc. Mobile job. ASQ is the proud possessor of an SX11 receiver. BJG is moving the rig and OW to a new QTH. FBI wants to know who is bootlegging FBI on 14 and 7 Mc., and says thanks for the nice DX QSL's, but he can't use 'em. FQN got O.P.S. appointment. FX got the rig back on the air and is ready for action. FRB is Okla.'s newest A.A.R.S. member. FFH is rebuilding his rig. AJF reports from Rochester, N. Y., where he is attending school, and reports that ex-5COT is now 3FQN. FKL needs 12 more for W.A.S. FWQ is a new ham at Ft. Sill. FDP is now in Tulsa with portable rig. AIR received O.P.S. appointment and is still hunting a suitable QTH.

Traffic: W5CEZ 875 EXZ 301 BTZ 285 FOJ 276 EGP 198

CVA 126 FSK 107 FFK 100 DWB 80 FFC 50 ADC-BLT 31 FRC 28 GAQ 25 EMH 19 EMD-FLY 16 FXG 16 AMT-ASQ 13 BJC-ENN-FBI 12 BLJ-FQN 8 FX 3 FRB-FFH 2. SOUTHERN TEXAS—SCM, Ammon O. Young, W5BDI—OW turns in the regular high traffic total. MN is keeping busy also. BEF handles his share of traffic. EWZ has a new receiver which uses a 6J7 and a 6C5. DWN hopes to be back on with his regular schedules soon. FGP has '52 on 14-Mc. 'phone. ETR is building a rig with a T55. FFM and FGP were hosts to 8GMI on his visit to Beaumont. FDI has heard some FB DX on 28 and 14 Mc. EWJ has moved to a new QTH and hopes to be able to work some DX, as he left his old noise behind. EKP is experimenting with preamplifiers. BHO is building a new ham shack over his garage. The Houston Amateur Radio Club promoted a very successful ice skating party and is working on plans for the next West Gulf Convention. CLZ is back on 7 Mc. BDI hopes to have the transmitter working on all bands and a 6-tube home made superhet for reception.

Traffic: W5OW 1373 MN 870 BEF 32 DWN 14 BHO 7 CPB 11 CPT 4.

NEW MEXICO—SCM, Joseph M. Eldodt, W5CGJ—DGP leads with traffic this month; we expect him to make the B.P.L. soon; he has ten regular schedules daily and says he can handle as many more. Here is a chance for anyone wanting a regular contact down this way to get it. The Carlsbad gang is getting pretty active. DWP attended the West Gulf Division Convention and got a Class A ticket. Ex-5CY, now 5FVA, will soon be on the air again. LC is working on a rig and expects to be hammering brass soon. EBO, Chief Engineer of the B/C station in Carlsbad, will soon be on 1.75-Mc. 'phone with a pair of T-55's. BGN stays up all night listening to DX. ZM was away on Christmas vacation. DLG had to resign as R.M. for business reasons. ENI has been appointed in his place. DLG has but little time for brass pounding, but even that little has been impaired by the neighborhood pole transformer going out several times recently. DZY is still holding down Trunk Line "D." Someone down in Albuquerque drop me a line, please. FRH is a new ham in Taos. We want more items. The S.C.M. would like to have the name and address of every active ham in the state. Let's keep our traffic growing.

Traffic: W5DGP 446 ENI 206 ZM 100 (WLJG 108) DZY 70 CGJ 54 (WLJE 4) DLG 34 FSP 26.

ROCKY MOUNTAIN DIVISION

COLORADO—SCM, Glen R. Glascock, W9FA—PVZ carries off the traffic honors again this month with his string of 10 daily schedules. ESA is getting back into the traffic swing too, principally A.A.R.S. work. Speaking of A.A.R.S., Eddie is looking for more members, so any of you fellows who feel inclined to join, just get in touch with ESA and he will give you all the dope. GBQ and ESA have been attempting some 56-Mc. tests with 3FPL, but so far the results have been nil. EKQ is another of the A.A.R.S. gang who keeps the key hot with traffic on one of the A.R.R.L. Trunks. TDR in Pueblo has been QRL at the Airport. PWU has been keeping the mike hot on four bands: 1.75, 3.5, 14, and 28 Mc., and he's not neglecting the traffic angle either. WWB in Pueblo is making good use of his O.R.S. appointment. CAA expects to be going full blast by the time this is published. SVL plans to be on all bands, 'phone and c.w., with about 80 watts. YYH is a new Arvada ham. The C.C.R.A. held a New Year's Party at the home of ODF, with prizes and refreshments. . . . The Rocky Ford Amateur Rdo. Assn. has joined the Candler System Code Guild to build up the general operating of the gang. TDS gave a talk on amateur radio as a hobby at a recent P.T.A. meeting in Rocky Ford. TTD is holding code practice sessions to a number of hams-to-be in and around Las Animas. SBB is going to school at Gunnison, but took the rig along to handle N.C.R. drills from there as well as to keep in touch with home thru MDN. GPP is on the air again at Manzanola. In the A.A.R.S. group will be heard CDE, TDS, MDN and EOQ. EHC turns in a swell report for the Colorado Springs gang. Carl is awaiting delivery of a new receiver. A general meeting of all the gang in the Springs was held recently to spur winter activity; the following attended: DYP, FXQ, HDI, HDU, KNZ, LFE, NRZ, TFT, UEK, YLT, YYO. AMS is working at an Airways station in Kansas City. DYP spends his working hours at the BC station KVOR. TFT, LJF and HDI are also QRL KVOR. HDU is active on all bands from 56 to 1.75 Mc. inclusive. Service work keeps JAU's tools busy. KI is heard on 7 Mc. from

time to time. KNZ is moving to Denver. LFE is active on 3.5, 7, and 14 Mc. NHI is on 7 and 3.5 Mc. quite a bit. NRZ is going to sell out and quit the game for a while. PRF is in a C.C.C. Camp and can't get permission to put up a station. SWM is on 3.5-Mc. c.w. USP moved to Durango to operate at KIUP. VHN is on now and then with low-powered rig. YAE is active on 3.5-Mc. c.w. and takes a crack at 1.75-Mc. 'phone now and then. YLT will be on 1.75 and 3.5 Mc. very soon. YYO is a new ham in the Springs. FXQ has changed QTH again; he is holding schedules with PVZ. EHC is going to replace two stages in his rig with a 6L6 and still cover 28 to 1.75 Mc. MKN finds himself all tangled up in N.C.R. work. UYS and PTI were issued uniforms at N.C.R. meeting. JFD has been shifted to night work, and the N.C.R. Net suffers. GCM, PWO and SJT with his pair of '71's and a flock of "B" Batts, put good signals all over the state on 1.75-Mc. c.w. VTF is a new member of the N.C.R. EBW recently found out how heavy his rig is when he pulled the whole thing over on top of himself; luckily it also pulled out the a.c. connection at the same time. TSQ, TEJ and NLG, as well as the two new members, WTW and WUE, have been making things plenty interesting for the N.C.R. in Pueblo. NLD is QRL school in Ft. Collins, but keeps up with the home folks via N.C.R. connections. GLI has been having his troubles with skip in his N.C.R. Unit, but the 1.75-Mc. shift solved the problem. Any of the fellows in the state interested in joining the N.C.R., drop a line to the S.C.M.—also the Section Commander—and full information will be forwarded. Let's have bigger and better reports for 1937.

Traffic: W9PVZ 657 ESA 422 EKQ 255 PWU 97 WWB 67 TDR-MKN 22 CAA 2.

UTAH-WYOMING—SCM, Townsend J. Rigby, W7COH—Utah: 6BLE has new QTH. 6ETB is QRL college. 6FYR has new ant. 6GRB is getting out on 3.9-Mc. 'phone with a ten in final stage. 6LWY is building an FB 1 KW job. 6LLH joined the A.A.R.S. and is having fun bumping unknown key ciphers. 6MDP also joined A.A.R.S. 6MPU is on 3.5 Mc. with '45. 6HTN is remodeling his QTH. 6JUE is on N.C.R. drill nights. 6KNC was completing new transmitter and broke one of the tubes in final. 6NLX is QRL power plant job. The O.A.R.O. Club had Christmas Party on 22nd. 6MLP made first report from Provo. 6DTB wants to know why Wyoming gang don't get 28 Mc. 6KOP built new antenna for SS contest and sure gave an FB account of himself. Wyoming: 7DIE is pinch hitting on T.L. "G" for "Rig" while he is QRL in Montana. 7EUJ and BFC are on for A.A.R.S. drills. 7AEC got hot fighting fire in Pinedale, but is still on the air for A.A.R.S. work, and is putting out "Wyoming Bull" for A.A.R.S. members. It's an FB job. Hank, OM, 7AXG is still QRL in Montana. 7DGU is pinch-hitting for 7HX who is QRL in California for the winter. 7AAT is QRL work. 7ASX is QRL radio beam station. 7EYC gets on for A.A.R.S. drills and T.L. "E" traffic, also O.B.S. schedules on 7 Mc. 7AMU is keeping A.A.R.S. gang pepped up. 7EOT has new rig parking OK. 7CBL is on for schedules and A.A.R.S. 7ADF is QRL in Montana. 7EVN is getting ready for 7-Mc. work. 7BXS is on occasionally. Casper Radio Club is lined up for the winter. 7CUG and 7COH are busy with A.A.R.S. 73 and Happy New Year to all.

Traffic: W6MLP 30. W7EYC 28 COH 505.

DELTA DIVISION

MISSISSIPPI—SCM, J. H. Weems, Jr., W5CWQ—GEA, ex-4BMM, is chief op at the new Government station in Greenwood—WWHV; he ran up 15,000 points in SS with low power. EWD and FCH visited BID, Armistice Day; the trip was made on motorcycle. FCH is rebuilding. EGGE and EKV visited BWD. BXA is an O.R.S. in Gulfport who transferred from the North Texas Section; he is operating at WGCM. KF made score of 2800 in SS. CUU says tooth-pulling is so good now he has no time for radio. DEJ's new hobby is amateur photography. EZA changed QTH from State College back to Redwood. GQ is QRL work.

Traffic: W5DEJ 62 BXA 12 KF 6.

TENNESSEE—SCM, B. G. Lowrey Smith, W4DEP—The S.C.M. would appreciate anyone in any part of the state sending in an activity report. AKJ and AFI have been trying their luck on code speed, and are both very good. CXY has taken over the A.A.R.S. in Tenn. as boss.

THANK YOU, HAMS!

The many enthusiastic reports which we have received from leading amateurs from coast to coast concerning the VT-73 voice transmission microphone are greatly appreciated.

The VT-73 and other Turner crystal microphones are completely described in a new six-page Kolor bulletin soon off the press. It is yours for the asking. Just say "Send me Bulletin 10-B".



MODEL VT-73

THE TURNER CO.

CEDAR RAPIDS, IOWA

Licensed Under Patents of the Brush Development Company

LIST—

- MIKE
- STAND
- PLUG

\$27.50

Medium Powered Pentode Transmitter

(Continued from page 18)

be no louder with the oscillator plate coil in the socket than with it out. But be careful when you pull the plate coil out—the voltage is on all the time. If you do not get complete cut-off of output with the key up, it indicates that the suppressor

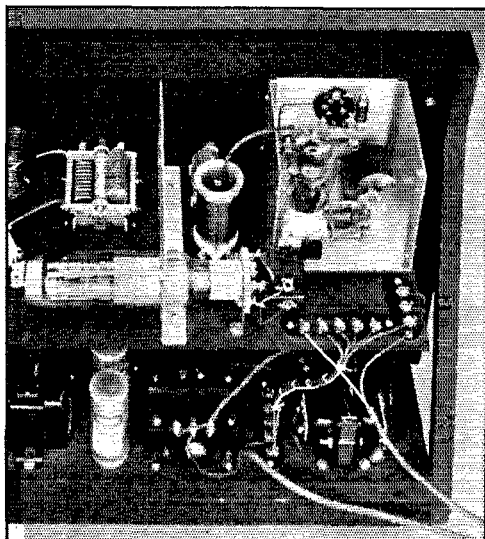

THE SHIELD CAN HOUSES THE OSCILLATOR TUBE AND CATHODE COIL

negative bias voltage is not high enough. As mentioned previously, the amount of radiation picked up in the receiver will be determined by the completeness of shielding and filtering, but this will not be given a chance to work unless the electrical cut-off is complete.

The final amplifier is tuned in the usual manner. When the oscillator has been adjusted, the grid current of the amplifier should be from 7 to 10 milliamperes. The plate tank condenser is tuned for minimum current and the antenna is connected. Normal current for the amplifier is from 75 to 90 milliamperes. With the key up, the final amplifier should show neither plate nor grid current. If some plate current is drawn, it indicates that the fixed bias on the amplifier is not high enough and it should be checked with a voltmeter. Between 100 and 150 volts is correct. If grid current shows with the key up, it indicates that the keying is not complete.

The method of adjusting the transmitter for 'phone is just as simple. Throw the switch to "Phone" and tune the oscillator. When the excitation has been adjusted for maximum, the suppressor grid lead to the final amplifier stage is opened and a 45-volt battery inserted, connecting the suppressor grid to the positive side and returning the negative side to ground. The load is then adjusted until the tube draws normal plate current (80 to 90 milliamperes). Remove the battery and reconnect the suppressor grid

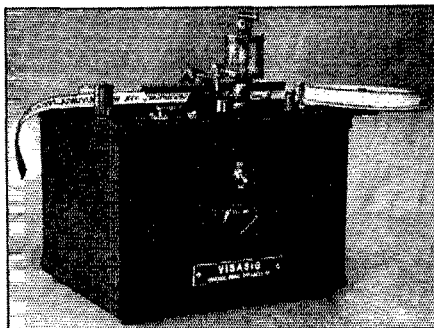

VISASIG Full Automatic Siphon Tape Recorder

for Amateur and Commercial use

Will record code signals from the air up to and in excess of 100 WPM. Use it to make a record of your own fist or the fellow's you work. Make a permanent record from your receiver of weather reports, press news, speed contests, etc. See how it helps improve your fist!

VISASIG — with electrically driven tape puller complete in one unit \$49.00

VISASIG — without tape puller . . . \$35.00

PRICES F.O.B. NEW YORK CITY

Commercial Station Managers and Executives write for particulars of professional 200 WPM model

UNIVERSAL SIGNAL APPLIANCES

64 West 22nd Street New York City

Visasig Blueprints \$1.00

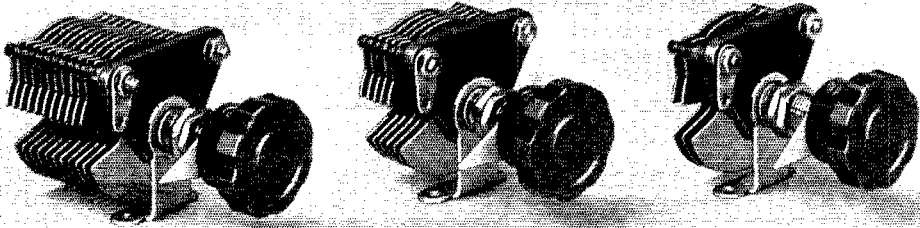

CONVENIENT SIZE • LOW LOSS • INEXPENSIVE

These condensers are used widely by amateurs in all circuits requiring small, simple-to-mount, low-loss units. They can be used either as single hole panel or bracket mounting. The insulation is a small end-plate of hard rubber placed in a weak field. Rated at 500 volts, peak, they are very suitable for use in low power transmitters. The plate shapes are straight-line capacitance. The Type 368 Condensers are supplied in three sizes:

- Type 368-A: 15 $\mu\mu\text{f}$ maximum, 2 $\mu\mu\text{f}$ minimum, \$0.75
- Type 368-B: 50 $\mu\mu\text{f}$ maximum, 3 $\mu\mu\text{f}$ minimum, \$1.00
- Type 368-C: 100 $\mu\mu\text{f}$ maximum, 4 $\mu\mu\text{f}$ minimum, \$1.50

Write for bulletin 94-Q for a description of the many General Radio amateur parts and accessories

GENERAL RADIO COMPANY
Cambridge, Massachusetts

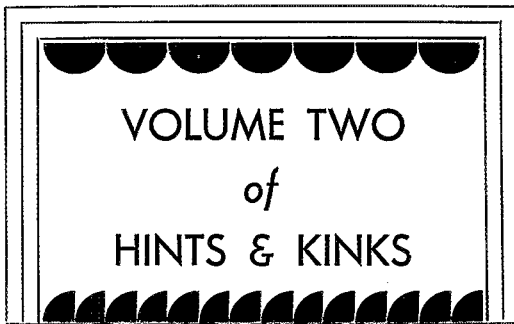

lights!
 curtain!

Has Just Appeared!

A personal appearance, too — nothing impersonal, because *Hints & Kinks* always has been a collection of personalities — because it is again a collection of practical ideas gleaned from personal experiences in ham shacks the world over.

128 pages in attractive paper covers. Price: 50 cents (no stamps, please), postpaid anywhere

THE AMERICAN RADIO RELAY LEAGUE
 WEST HARTFORD, CONNECTICUT

ASTATIC RELEASES A NEW QUALITY CRYSTAL PICKUP

TRU-TAN

MODEL B-10

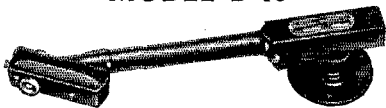

BETTER REPRODUCTION LONGER RECORD LIFE

Its scientifically designed offset head reduces needle tracking error from the 10° to 15° prevalent with regular straight arm pickups to a maximum never exceeding 1.5° with the TRU-TAN. Plus absolute freedom from mechanical resonance. Plus a reversible head for easier needle loading.

ASTATIC MICROPHONE LABORATORY, INC.
Youngstown, Ohio, U.S.A.

Licensed
under
Brush
Development
Company
Patents—
Astatic
pending

ASTATIC

Write for
Bulletin
Giving
Complete
Details

How Old Is Your LICENSE MANUAL ?

You know that the F. C. C. makes frequent changes in amateur regulations? That many of these changes deal with the rules for getting new licenses and renewals? That when the regs are changed, the appropriate questions are changed in the license examination, and the answers have to be different?

- To keep pace with these changes, The Radio Amateur's License Manual is frequently revised. It is now in its seventh edition. Moreover, each copy is, when necessary, accompanied by a change sheet summarizing any changes that have been made since it went to press. ■ The License Manual is as invaluable to the practising amateur as it is to the aspirant—but only if it is the current edition. **Price 25c postpaid**

American Radio Relay League
West Hartford, Connecticut

lead, and adjust the tap on R₇ until the plate current of the final amplifier is half the normal value (40 to 45 milliamperes). Talk into the mike and open the gain control on the modulator unit until the plate milliammeter pointer no more than flickers on voice peaks—and the adjustment is made. When using 'phone it will probably be necessary to ground the negative side of the set to a water pipe or other ground, as is usually the case with all high-gain audio amplifiers. Monitoring the transmission will reveal any hum or other undesirable characteristics; but if reasonable care has been exercised in construction, no such trouble should be encountered.

A few results and sidelights. Used on c.w. during the last Sweep Stakes contest, the outfit proved useful and effective—break-in speeded up contacts, and the simplicity of tuning made frequency changing quick and simple. On several occasions stations within 500 cycles of the transmitter frequency were worked by the simple expedient of turning off the b.f.o. of the receiver and allowing the crystal oscillator of the transmitter to furnish the heterodyne note.

The transmitter has not been tried on 28-Mc., since the writer is of the opinion that a transmitter designed for use on "ten" should incorporate somewhat different design. However, it is possible that it could be done by doubling from 14 Mc. in the final amplifier.

BOOK REVIEW

Telecommunications: Economics and Regulation, by James M. Herring and Gerald C. Gross. 544 pages, including index. Published by the McGraw-Hill Book Co., New York. Price \$5.00.

This book, written by acknowledged authorities on the subject, will doubtless be the standard reference work in its sphere in years to come. It is a complete, detailed, authoritative and scholarly treatment of the entire telecommunications field, covering both economics and regulation. It commences with chapters detailing the development of the telegraph, cable, telephone, radiocommunication and broadcasting industries, proceeds with an analysis of the economics involved, including a detailed examination of rate-making procedures, and then carefully examines the regulation of these forms of communication from the local, national and international standpoints. There is a particularly penetrating chapter on communications and national policy.

The amateur, of course, will find only incidental direct interest in a volume as comprehensive as this. Yet there is no amateur who could fail to read it without deriving a measurably fuller understanding and appreciation of amateur radio in its relationship to other radio services. Many of the self-anointed prophets of a new legislative deal in amateur radio might do that with benefit. As for any serious student of the machinery of telecommunications administration and regulation, this book is definitely required reading.

—C. B. D.

Strays

In connection with the warning regarding mounting of beam power tubes on page 76 of the December issue, RCA-Radiotron advises that their beam tubes can be operated in any position without danger of grid misalignment.

Convenient!

Hundreds of hams, all over the country, are rejoicing at the convenience of their RADIOLAB CLUB PLAN MEMBERSHIPS. They buy whatever they need from the huge Radiolab stock and pay out of monthly income.

Why not you too? A penny post card will bring complete details

RADIOLAB 1515 GRAND AVE. KANSAS CITY, MO.

Read this page from the Saga of Amateur Radio

Then get your copy and read the whole story. price \$1. postpaid. A. R. R. L. W. Hartford, Conn.

THE HUNDRED METERS AND DOWN

At this time that the first successful broadcasting was... later addressed primarily to amateurs and to operators on ships... the pre-war broadcasts, amateur radio grew up with the most notable... in prizefighting, but did not tag along with it.

By March, 1911, *Modern Electric* was claiming a circulation of 50,000. Someone said there were ten thousand amateurs in the country, 40 per cent. of whom had transmitters. On October 21, 1911, the Junior Wireless Club Limited, which had more than doubled its membership, changed its name to the Radio Club of America. By the end of 1911 the membership had increased to twenty-five.

At about this time the range of amateur transmitters had increased to the point where the fellow with several kilowatts was sometimes heard three or four hundred miles in favorable sections of the country; after all, by 1912 the Panama station was being heard consistently in New York, the Middle West, and California. But the average radio amateur contented himself with moderate distances—five miles, for small sets, up to one hundred for the bigger fellows—and used his station for the most part in conversing with friends in other parts of the city.

One important activity was baiting the commercials. If a commercial station wanted to do any work, it was usually necessary to make a polite request of the local amateurs to stand by for a while. If the request was not granted, if an amateur-commercial feud happened to exist, the amateurs did not stand by and the commercial did not work. Times without number a commercial would call an amateur station and tell him to shut up. Equally as often the reply would be, "Who the hell are you?" or "I've as much right to the air as you have." Selfish? Undoubtedly. And yet, the amateur did have equal station interrupting important traffic—contrary to accusations ever made about interrupting important traffic.

Scattered all over this hemisphere and building new and better manufacturing plants and apparatus, ever enthusiastic were the following in their searching for...

HARVEY 700-R

The 700-R is a new transmitter comprised of our standard 80-T and 700-A units assembled in a single rack cabinet. Such a combination is especially desirable for present 80-T owners who wish to increase power at nominal cost and for prospective 80-T purchasers who are assured that their first investment will be well protected when higher power is contemplated in the future.

● **POWER OUTPUT**
— 150 watts. Phone, 450 watts CW.

● **R.F. SECTION** — 6L6 crystal oscillator, RK-20 modulated amplifier, two Eimac 150-ts as class B linear amplifier.

● **FREQUENCY RANGE** — 1500 to 30,000 kilocycles.

● **SPEECH AMPLIFIER** — Designed for single diaphragm crystal microphone input

● **FREQUENCY Shift** — Plug in coils are used on all bands.

● **INSTRUMENTS** — A complete complement of meters is furnished as well as built-in modulation monitor and carrier shift indicator for constant checking of transmission characteristics.

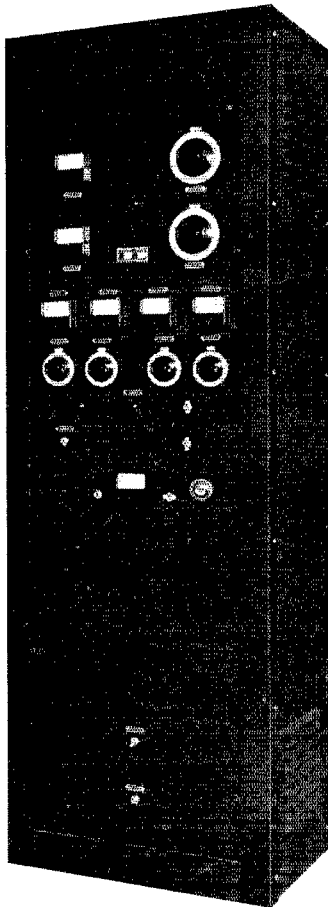

Free Data and Prices on Request

Time Payment and Trade In Plans Also Available

HARVEY RADIO LABS., INC.

12 Boylston St., Brookline, Mass.

Export: 25 Warren St., New York City

CABLE: "SIMONTRICE"

A Simple Directive Antenna

(Continued from page 48)

How does that sound to the low-power boys? It was extremely thrilling to move the reflector with the receiver on and to watch the DX signals weaken and fluctuate, while signals from the opposite side rose out of the background. The array was tested for a whole month and was then given up due to leaving the place. The new antenna, a vertical half wave, does not stand any comparison with the old one, although it is known as a not bad DX radiator. It is hoped, however, to resume the experiments with long wire antennas in the summer of 1937.

I.A.R.U. News

(Continued from page 78)

occurs just before sunrise, and seems to tie in with the appearance of the sun's rays."

The phenomenon still intrigues us.

Boy Scout:

We feel rather good at this point, in view of a letter received from Gordon Kempton, VK2CI. Says Mr. Kempton: "I am pleased to give you a big 'Thank you' for being the means of reuniting me and my long-lost cobbler (VK for 'pal') Bill McCutcheon, W2CET. He saw the bear and self in QST (October) and I got a letter from him before I got my QST. He was at one time ZL2JX and VK2OX, and I had not heard from him since he went back to the U.S.A."

Does anyone know the bear?

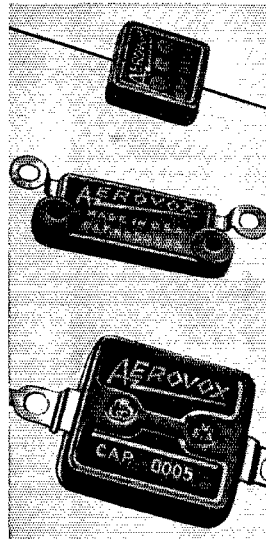

Mica CONDENSERS

AEROVOX offers you 13 types of mica condensers to choose from — tiny "postage-stamp" unit to large cast-metal-case high-voltage type.

Widest choice of bakelite-molded units for any receiving or transmitting circuit use.

Available in voltages from 500 to 7000 D.C. Capacities from .00004 to .1 mfd. All units plainly stamped with capacity.



Top: Postage-stamp unit for extreme compactness.

Center: Insulated mounting unit.

Bottom: Unit with combined mounting holes and terminals.

New Catalog: Covers most extensive line of condensers and resistors. Sent on request.



BEST

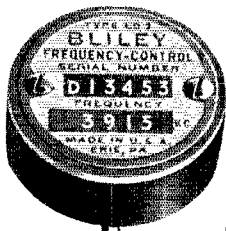

for
40-80-160
METERS

BLILEY offers the amateur the only complete line of crystal units for 20-40-80-160 meter band operation. The Type LD2 is the most popular low-drift crystal unit (less than 4 Cycles Mc./C.) on the market today. It

for 20
METERS

is outstanding in power, activity, ability to key well, frequency and stability. The Type HF2 Unit is the *only* crystal unit on the market specifically designed for 20 meters. It makes possible more efficient high frequency work, eliminates expensive doubler stages and gives a clean sharp note that goes a long way in breaking through QRM. You don't have to take our word for it; trust the judgment of the thousands of amateurs all over the world who say that BLILEY'S ARE BEST.

BLILEY ELECTRIC CO.

ERIE, PA.

BLILEY *for* DEPENDABILITY



OK2AK

GAMMATRONS WIN ON BOTH SIDES OF THE WATER!

Hans Plisch, OK2AK, winner of W VE...DX contest for Czechoslovakia with 46,560 points.

A new 20-page brochure is now available containing data for the latest Type 154 Gammatron as well as a revision of the Type 354 Gammatron literature. Request the new Catalog 5357.



Power
X cut

**O. C. L.
Control Crystals**

High
Output

Unconditionally Guaranteed

7000 KC \pm 5 KC . . \$1.85 3500 or 1750 \pm 5 KC \$1.50

ATCUT — 40-80-160 \pm 5 KC 2.25

OMAHA CRYSTAL LABORATORIES

Jobbers write: W9JRY, NORTH PLATTE, NEBR. W9CPM

RADIO ENGINEERING



RCA Institutes offer an intensive course of high standard embracing all phases of Radio. Practical training with modern equipment at New York and Chicago schools. Also specialized courses and Home Study Courses under "No obligation" plan.

Illustrated Catalog on request

RCA INSTITUTES, INC. Dept. ST-37

75 Varick St., New York 1154 Merchandise Mart, Chicago
Recognized Standard in Radio Instruction Since 1909

Insignia

OF THE

Radio Amateur

► In the January, 1920 issue of *QST* there appeared an editorial requesting suggestions for the design of an A.R.R.L. emblem — a device whereby every amateur could know his brother amateur when they met, an insignia he could wear proudly wherever he went. There was need for such a device. The post-war boom of amateur radio brought thousands of new amateurs on the air, many of whom were neighbors but did not know each other. In the July, 1920 issue the design was announced — the familiar diamond that greets you everywhere in Ham Radio — adopted by the Board of Directors at its annual meeting. It met with universal acceptance and use. For years it has been the unchallenged emblem of amateur radio, found wherever amateurs gathered, a symbol of the traditional greatness of that which we call Amateur Spirit — treasured, revered, idealized.

Do You
Wear
the
A.R.R.L.
Pin
?

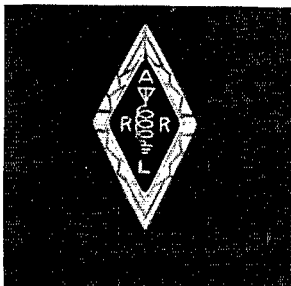

THE LEAGUE EMBLEM, with both gold border and lettering, and with black enamel background, is available in either pin (with safety clasp) or screw-back button type.

In addition, there are special colors for Communications Department appointees.

- Red enameled background for the SCM.

- Blue enameled background for the ORS or OPS.

(Red available in pin type only. Blue may be had in either pin or button style.)

THE EMBLEM CUT: A mounted printing electrotype, $\frac{3}{8}$ " high, for use by members on amateur printed matter, letterheads, cards, etc.

ALL EMBLEMS PRICED THE SAME

50 cents, *postpaid*

AMERICAN RADIO RELAY LEAGUE
West Hartford Connecticut

The 1936 Northwestern Division Convention

THE Marcus Whitman Hotel at Walla Walla, Wash., served as headquarters for the group of over 200 northwestern amateurs and YL's that attended the Eleventh Annual Northwestern Division Convention on Aug. 21st, 22d, and 23d.

On Friday evening, Director Ralph Gibbons, committee chairman, introduced Nick Foster, W7RX, of Seattle, who gave an interesting illustrated talk on the development of the vacuum tube, from the early models up to the modern metal tube.

At the business meeting Saturday morning, a welcome to Walla Walla was extended by the mayor, after which President Woodruff and Assistant Secretary Goodman of A.R.R.L. spoke on amateur affairs. After lunch, the technical meeting was opened with an interesting talk by John Reinartz, W1QP, who demonstrated his new oscillator circuit and universal exciter. Dr. Woodruff proceeded to open his "bag of tricks," and explained a few of his famous gadgets. Don Wallace, W6AM, spoke on "Directive Antennas," followed by Byron Goodman, W1JPE, and "Single-Side-Band Telephony."

The banquet, Saturday evening, was run off smoothly, under the capable handling of the toastmaster. A feature of the entertainment, which included short talks by the guests of honor, was the capable singing of George Peckham, W7ABD. Prizes were distributed, and the floor was cleared for a dance that left nothing to be asked for by the attending devotees of terpsichore.

Sunday morning the code speed contest was held; J. Gruble, W7RT, winning in the amateur class at better than 36 w.p.m. (copying with a pencil), and Conrad Schmidt, W7BEX, topping all others in the open contest at 41 w.p.m. 'Tis said Schmidt can do much better, but no one present could send any faster! At Pioneer Park soft-ball games were held, a picnic lunch distributed, portable equipment was demonstrated by the Third Signal Corps and by W. Miller, W7AAN, and general rag-chewing was indulged in until the delegates reluctantly said their goodbyes.

Much credit is due Ralph Gibbons, Wilbert Beal, Alex Halverson and the other members of the committee that made possible a carefully-planned and well-balanced convention.

Strays

Out of several entrants for the "most-calls-held" honor, Ed Raser, W3ZI, RM for Southern New Jersey, heads the list by a wide margin. Starting in 1913 with self-assigned "RE" on spark coil, he's had 3NG, 3CS, 3AEC, 3XAN, W3AOV, W3ZZB, W3ZZH, W3ZZJ, W3ZI, W3CMH, WOAX, WMAL, WWAB, KUJQ, KEBR, NAI, NSD, 99A, CD1, UG3, AX3, BE9, WLNE—ham, commercial, navy and army.



..... WE CAN HELP *You*

TO

Fill the Holes in Your QST Files

The December, 1936, issue of *QST* marked its twenty-first anniversary. It especially reminded us of the increasing value of back copies. You will note from the list below that copies covering the first ten-year period (1915-1924) are no longer available. Vol. 1, No. 1 in particular, and other pre-war copies in general, are so rare that they command high prices when available. Copies issued since the war (beginning with the June, 1919, number) up to the beginning of 1925 are becoming increasingly rare — as soon will be many of the copies from 1925 on. In fact, as the list shows, many since 1925 are already out of print.

(SUBJECT TO CHANGE)

1925 copies — (except Jan., Mar., May and July)	\$2.00
1926 copies — complete	2.50
1927 copies — (except January, July and October)	2.25
1928 copies — (except Jan., Feb., Mar., Aug., Sept.)	1.50
1929 copies — complete	2.50
1930 copies — (except January, February and July)	2.25
1931 copies — (except November)	2.50
1932 copies — (except Feb., July, Aug., Sept., Oct.)	1.75
1933 copies — (except January and February)	2.50
1934 copies — complete	2.50
1935 copies — complete	2.50
1936 copies — complete	2.50
1937 copies — as issued, each 25c — complete year	2.50

Single Copies, 25c Each, and Yearly Sets at
Price Indicated, Postpaid

Foreign add 50c for Yearly Sets

TO

Keep Your QST's In Order

The value of your *QST* file for reference purposes will depend entirely upon how readily you can find the issue which you want, and the appearance of the station will depend upon how you keep them. The binder fills both of these needs. Designed to hold twelve issues of *QST* and an index, it permits the copies to be placed in as they are received, or removed at will without mutilating the copies. It is a binder that you can be well proud of, and with each binder is furnished a set of labels, with the year marking, so that you can designate your yearly files. The binder is available only in the United States and its possessions, and the price is \$1.50, postpaid.

THE AMERICAN RADIO RELAY LEAGUE

West Hartford, Connecticut

Be Wise— KENYONIZE

If you contemplate building a 913 Oscilloscope specify KENYON Audio and Power Units specially designed for this purpose.

Synchronizing Transformer T-1 Power Transformer T-207

For complete catalog of amateur audio and power components see pages 67, 68, 69 and 70 in the January issue of this magazine.

Kenyon Transformer Co., Inc.

Export Dept.: 25 WARREN STREET

Amateur Section: 840 BARRY STREET

NEW YORK, N. Y.



NEW HOLDER DESIGN

15 SECONDS
TO INSTALL
CRYSTAL

For All Bands

GREATER
STABILITY

Plugs in 5 prong
tube socket

Beautiful
Appearance

MODEL AH HOLDER \$1.00

At your dealer or direct

HIPOWER LOW DRIFT CRYSTALS:

within 10 kc. or Choice of stock

AH-10, 1700-3500 Kc. bands \$2.35

AH-10, 7000-7300 " band 3.90

write for new Literature

Hipower "Low Drift" Broadcast and Commercial
Crystals Are Approved by F.C.C.

Hipower Crystal Co., 2035 Charleston St., Chicago

LEARN RADIO

New Classes Now
Forming! Send for 40-
page catalog, explains

fully, 300 licensed graduates placed in past 4½ years in broadcasting, shipping, police radio, aviation, etc. We teach all branches. Oldest, largest and best equipped school in New England. Equipped with Western Electric sound and broadcasting equipment and RCA marine transmitter. Course prepares for United States Government telegraph or telephone license.

MASS. RADIO SCHOOL, 18 Boylston Street, BOSTON

High-Power Crystal Oscillator

(Continued from page 55)

and the small drop in power output. With 3.5- and 1.75-Mc. crystals, the shell may be left floating since tests show that the crystal current was not excessive at these frequencies. Because of the tendency for this tube to self-oscillate when a tank circuit is connected in the cathode, caution should be used in Tri-tet operation. With all beam power tubes the screen voltage preferably should be obtained from a dividing resistor, and not from a series dropping resistor.

THE 807 TUBE

A relatively new tube to take the place of the 6L6 as a transmitting tube has been announced recently. This glass tube has the same beam power operating principle as the 6L6, and gives large power outputs with low plate voltages. It has considerably better shielding and requires less driving power than the 6L6. Since the shielding is more effective, the tendency toward self-oscillation and erratic performance is greatly reduced and this type is much to be preferred to the 6L6. When used in a conventional pentode oscillator with 20,000-ohm grid leak and 250-ohm cathode bias resistors, outputs of 25 watts may be obtained with a 14- or 7-Mc. crystal without overloading.

The data sheet supplied with this tube gives valuable suggestions on circuit design at the higher frequencies, and should be carefully read before planning the layout.

THE 8K39

This tube is similar to the 807 type and also operates on the beam power principle. It is designed to stand a higher plate voltage and consequently a larger output may be obtained.

When used as a crystal oscillator with 750 volts on the plate, a cathode bias resistor of about 350 ohms should be used and a grid leak resistor of 15,000 ohms. Under these conditions, outputs of 30 watts may be obtained with 3.5- or 7- or 14-Mc. crystals. Crystal current, even in the no-load condition, was well below rated values.

35T, 800 AND 808 TRIODES

Of the triode high-power tubes used as crystal oscillators, the 35T, the 800 and the 808 were tested. These tubes were used in the circuit shown in Fig. 7 and the table gives the output and maximum crystal current for different crystals and tubes. It will be seen that all crystals except the 3.5-Mc. were worked to their rated value, even with the circuit heavily loaded. Attempts to remove the load resulted in currents of 200 ma. and several blown 7-Mc. crystals. The lowest crystal current was obtained by using 500-ohm cathode-resistor bias. Any attempt to add grid leak bias increased the drive on the crystals. The plate voltage was reduced in order to decrease the crystal current; however, when reduced much below its rated value, the crystal was driven just as hard and the output was con-

FOR YOUR

transmitter!

SQUARE OR ROUND ANTENNA METERS

Use these good looking instruments for measuring the output of your transmitter. The movements are of the rugged hot-wire type and are not affected by frequency changes. You will like these meters because they are built for service and the prices are easy on your pocketbook. The round style No. 576 comes in a 3 1/4" flush bakelite case and the square one No. 577 is supplied in a semi-flush bakelite case 4 1/4" square. Ranges furnished are: 0/1.5; 0/3; 0/5 amps. Milliammeters to

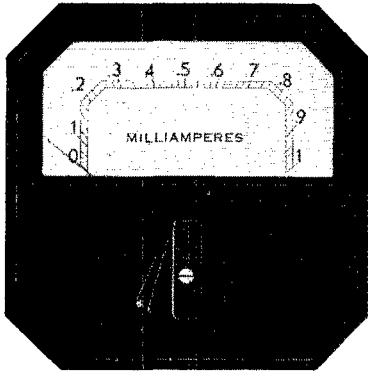

match, both square and round types are available. Ask for these modern meters at your jobber's or check the handy coupon below.

Gentlemen:

- Send me full information about the Hoyt R. F. Antenna Meters.
- Send me catalog RM-3 with information about the complete line of Hoyt Radio Meters.

Name.....Street.....

City.....State.....

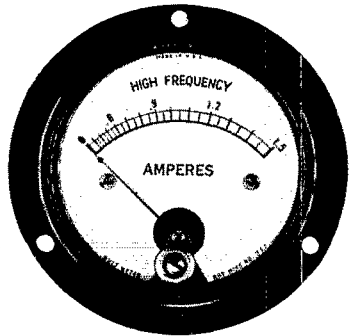

THE BURTON-ROGERS COMPANY
 SALES DIVISION HOYT ELECTRICAL INSTRUMENT WORKS
 755 BOYLSTON STREET BOSTON, MASS.

Gone Like the Wind!

are all your mathematical problems with these LIGHTNING CALCULATORS. Flip a dial, take a turn, set the indicator, — and there you have it!

Type A, \$1.00

For problems involving frequency, inductance and capacity, in design of radio frequency circuits. Direct reading answers for size of coils and condensers for any range between 400 kc. and 150 mc.

Type C, \$.50

More information on electrical conductors than you could find in a book full of tables.

Type E, \$.50

Direct reading total resistance of resistors connected in parallel, and total capacity of condensers connected on series.

Type B, \$1.00

Gives direct reading answers to calculations involving current, resistance, voltage and power with scale for resistance of copper wire and scale for calculating decibel gain or loss.

Type D, \$.50

Gives decibel gain or loss when input and output voltages, currents or power are known.

Type F, \$.50

Permits measurement of resistance, from 1 ohm to 1 megohm by use of a voltmeter. Makes an ohm-meter of your voltmeter.

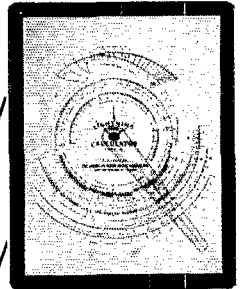

PRICES INCLUDE POSTAGE FROM THE
AMERICAN RADIO RELAY LEAGUE
 West Hartford, Conn.

swish!

TURN SCRAP INTO MONEY

AUTOPOWER tells you how in plain, easy, simple, and illustrated instructions that anyone can follow. Change auto generators into useful, practical A C and D C generators and motors with voltage from 2 to 1,000 volts, for power, light, welding, radio, sound, etc. No previous experience nor special tools needed. Generators can be driven by wind, water, fan belt, etc. Already used and endorsed by thousands. Send today for your copy, and also receive FREE a copy of PRACTICAL ELECTRIX, the new publication for the man who wants to KNOW, BUILD, REPAIR and READ about electrical apparatus and machinery. Book and magazine postpaid only \$1.00.
 AUTOPOWER, INC., Dept. R

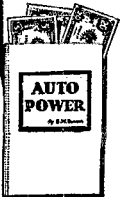
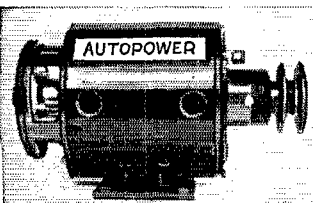

Say You Saw It in QST — It Identifies You and Helps QST

THE RADIO AMATEUR'S *Library*

For some time our advertising in *QST* has carried a by-line reading "Number..... in the series entitled Radio Amateur's Library." Many requests have been received for copies of this list and now we present it in *QST* in its complete form — to give a comprehensive picture of our publishing services to the amateur.

No.	Title	Price
1.	<i>QST</i>	\$2.50 per year*
2.	List of Stations	Pre-war <i>Out of Print</i>
3.	Map of Member Stations	Pre-war <i>Out of Print</i>
4.	Operating an Amateur Radio Station (Formerly called Rules & Regulations of Communications Dept.)	Free to members; to other 10c
5.	The Story of The A.R.R.L.	<i>Out of Print</i> See No. 13
6.	The Radio Amateur's Handbook	\$1.00**
7.	The Log	35c each; 3 for \$1.00
8.	How to Become a Radio Amateur	25c
9.	The Radio Amateur's License Manual	25c
10.	Hints & Kinks for the Radio Amateur	50c
11.	Lightning Calculators:	
	a. Radio (Type A)	\$1.00
	b. Ohms Law (Type B)	\$1.00
	c. Wire Data (Type C)	50c
	d. Decibel (Type D)	50c
	e. Parallel Resistance — Series Capacity (Type E)	50c
	f. Resistance Calculator (Type F)	50c
12.	Amateur Radio Map of the World	\$1.25
13.	Two Hundred Meters and Down: The Story of Amateur Radio	\$1.00

*In the United States and Possessions and Canada.
Other Countries \$3.00 per year.

** Postpaid in Continental U.S.A. — \$1.25, postpaid, elsewhere.

**THE AMERICAN
RADIO RELAY LEAGUE, INC.
West Hartford, Connecticut**

siderably less. This condition exists because the amplification factor of a triode decreases rapidly with decrease in plate current. Therefore the best operating point for these tubes is near their rated plate voltages. Because of the lower amplification factor of the 600, however, the plate voltage could not be increased much above 750 volts.

No attempt should be made to use any of these tubes as crystal oscillators unless the crystal is adequately protected either by a low-resistance fuse designed to blow below the rated current of the crystal or by a small pilot lamp, in series with the crystal.

If high-voltage tubes are to be used to obtain high-power outputs from the crystal stage, it is best to stick to high-power pentodes. In any case, the crystal must be adequately protected by one of the above mentioned methods.

More DX Per Dollar

(Continued from page 41)

that hardly can be distinguished from crystal control.

AUTOMATIC DRIVER

From the 6L6 we go to the two-stage automatic driver shown in Fig. 3. A plate neutralized 100TH is capacity coupled on 7 Mc. to a grid neutralized 250TH operating either straight through on 7 Mc. or doubling to 14 Mc. The capacity balanced plate tank, L_2-C_4 , of the 100TH thus serves to neutralize both tubes. Grid neutralization is used on the 250TH so that changing its plate tank from 7 Mc. to 14 Mc. will have no detuning effect on L_2-C_4 . Re_1 and C_7 constitute the padder used to shift L_2-C_4 from the 7100-7200 region to 7000-7100 kc. The bias resistor on the 100TH is low to suit the excitation of about 6-8 watts available from the 6L6; some power is lost in the long link, but even 5 watts are sufficient drive for the 100TH. And with everything tuned right on the nose, a little over 1 watt excitation is enough for better than 100 watts output from the 100TH. The bias on the 250TH is left at a high value for doubler operation; this is away high for straight 7-Mc. work, but there is no need for full output on this lower-frequency band. The 100TH provides about 100 watts of drive to the 250TH to assure a reserve of excitation when the 250TH is doubling (especially as the latter's plate tank is operated fix-tuned over the whole 14-Mc. band). Under the above conditions, the 250TH will deliver 400 watts on 7 Mc. and 300 watts on 14 Mc.—making it a respectable automatic two-band transmitter.

The chief point of interest in the circuit is the "two-band" plate tank, $L_5-C_5-C_6$. With the band-change relay Re_2 closed, C_6 tunes the upper portion of L_3 to 14 Mc. and the link L_4 couples it to the 14-Mc. final amplifier. Then, when Re_2 opens, the lower portion of L_3 is added to the circuit along with C_5 which is used to bring the combination into tune on 7 Mc. (C_6 remaining un-

**How to
Become**

A RADIO AMATEUR

Published by the AMERICAN RADIO RELAY
LEAGUE, INC. • West Hartford, Connecticut



Price 25 Cents

“ “ “ “

Price 25¢ postpaid
(no stamps, please)

AMERICAN RADIO RELAY LEAGUE
WEST HARTFORD, CONNECTICUT

NOT to Make More Amateurs But to Make GOOD Amateurs

is the purpose of the League's beginner's booklet

HOW TO BECOME A RADIO AMATEUR

There is, inevitably, a constant flux of newcomers to the amateur game; it takes thousands of beginners each year to make up the annual 40% turn-over in our numbers. The policy of the F.C.C. and the League is to maintain, as nearly as possible, the status quo.

It is also the policy of the League to insure that these newcomers are competent, adequately-trained amateurs by supplying authentic instruction and trouble-proof beginner's designs. Such information is provided in the beginner's booklet.

Keep the beginner - QRM down — start your beginning amateur friends with **HOW TO BECOME A RADIO AMATEUR.**

Learn AVIATION RADIO

at an approved Aviation school. Send for particulars regarding Radiotelephone and Radiotelegraph Operators' licenses for Aviation ground and flight duty.

STEWART TECHNICAL SCHOOL

Aviation Dept. 132, Stewart Tech Bldg.
253-5-7 West 64th Street New York City

Approved by Bureau of Air Commerce as an
AIRPLANE AND ENGINE MECHANICS' SCHOOL

"The Crystal Specialists Since 1925"

PIEZO-ELECTRIC CRYSTALS

Guaranteed Accurate to BETTER than .01%

SCIENTIFIC RADIO SERVICE

UNIVERSITY PARK, HYATTSVILLE, MD.

The "G" Beam Transmitter

All parts, chassis and lay-outs in stock for the "G" Beam Transmitter described in the December, 1936, *QST*, page 23.

Write for Prices on Phone or C.W. Units. Write for New 1937 Catalog, Now Ready.

M & H Sporting Goods Co.

512 MARKET ST.

PHILADELPHIA

1709 Atlantic Ave.

Atlantic City

WE OFFER —

Specialized personal service of genuine value that is not available from other jobbers.

Time sales of all receivers and transmitters with terms arranged to suit you and 6% interest charge. We finance our own paper. Trade in your equipment for the down payment.

Complete stock of all amateur apparatus at net prices. Export orders given individual attention too.

TRADE IN YOUR RECEIVER

All receivers shipped on ten day trial. You need send but \$5.00 with order, balance C.O.D. These receivers in stock:

RME-69s	\$134.40
DB-20 signal intensifiers	39.95
The new 1937 Breting 14s	99.00
RCA ACR-175s	119.50
The new 1937 Super Pro when ready	238.14
Hallicrafters Sky Buddys	29.50
Hallicrafters Sky Chiefs	44.50
Hallicrafters 1937 Super Skyriders S-11	89.50
Hallicrafters Ultra Skyriders S-10	99.50
The new Patterson PR-15 when available	109.50

TRADE IN YOUR TRANSMITTER

All Collins, Harvey, RCA, RME, Marine, All Star transmitters at net prices. Sold on terms to suit you with two years to pay and 6% interest charges.

HENRY RADIO SHOP

211-215 North Main Street

BUTLER, MISSOURI

JUST WHAT THAT NEW RIG NEEDS TO MAKE IT COMPLETE — Why Bother with Messy Haywire Links When You Can Use

B. & W. LINKED "AIR INDUCTORS"

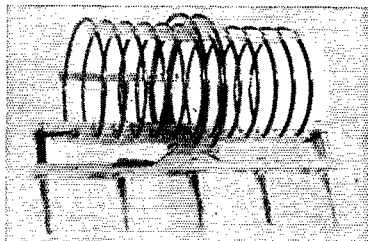

- Completely plug in
- 49 Types for every purpose
- Neat appearance
- Reasonably priced

STANDARD TYPES \$1.00 — \$6.25

Most complete line of transmitting coils on the market
See them at your local jobber or write direct for catalog

BARKER & WILLIAMSON
RADIO MANUFACTURING ENGINEERS
ARDMORE, PENNA.

READ SEND CODE LIKE AN EXPERT!

Learn Quickly at Home, Get Real Speed

It's easy, fascinating, to become a good op with the NEW ALL ELECTRIC MASTER TELEPLEX Code Teacher to help you.

Only instrument ever produced which records your sending in visible dots and dashes — then sends back to you at any speed you desire.

Also sends practice work, recorded by an expert. That is why so many schools teaching code prefer Master Teleplex.

That is why thousands agree this method is surest, quickest — has taught more ops in the past few years than

other methods. We furnish Complete Course, lend you Master Teleplex, give you personal instruction with a MONEY-BACK GUARANTEE. Low cost. Send today for booklet Q-2; no obligation.

THE "HAM" SPECIAL

Standard Teleplex — a highly efficient code teacher using heavy specially prepared waxed paper tape, having two rows of perforations. Write for Free folder Q1-2.

We are the originators of this type instrument

TELEPLEX CO. 76 CORTLANDT STREET
NEW YORK, N. Y.
TELEPLEX — "The choice of those who know"

SICKLES COILS

ALL TYPES OF RF AND IF WINDINGS

Manufactured by

F. W. SICKLES COMPANY

300 Main Street

Springfield, Mass.

T. R. McELROY

WORLD'S CHAMPION RADIO TELEGRAPHER

23 Bayside Street, Boston, Mass.

MAC KEY @ \$7.95 a real speed key.
MAC KEY DELUXE @ \$15.00.
MAC CORD @ \$1.00 speed key cord.
MAC CASE @ \$3.95 speed key case.
MAC OSC @ \$3.95 ac/dc oscillator. Tone control.

If u hv Mac Key wri me fo xmy ipt & dsrb inf.
All my stuff emcy god best pdnts obl. 73 Mac.

touched after once being set for 14 Mc.) Link L_5 then comes into action to couple the exciter to the 7-Mc. final, L_4 having no effect since it goes only to the 14-Mc. amplifier grid tank.

This driver unit is mounted on a cadmium plated steel chassis 12 by 17 by 4 inches. The general layout is shown in the photo of the main transmitter frame. The tube sockets are set below the chassis level. The grid tank of the 100TH is located entirely under the chassis, effectively isolating it from the other two driver tanks. All by-pass condensers and r.f. chokes are also under the chassis. Power is brought in through the row of lead-through insulators on the back edge of the chassis. The unit is thus easily removed for inspection and servicing.

Part II, describing the 7-, 14- and 28-Mc. final amplifiers, as well as the keying system and antennas, will appear in an early issue. — Editor.

The Doherty High Efficiency Amplifier

(Continued from page 53)

reactance by decreasing the capacity of C_8 and readjusting the grid tank circuits.

If the positive peaks of modulation are too high, the troubles are the reverse of the above. The grid circuit is quite critical to adjust, and all changes in the tuning of this part of the circuit should be observed on the oscillograph screen.

When the amplifier is correctly adjusted and 100% modulation of sine-wave form is applied, the plate current of the carrier tube will remain substantially constant, and the current to the peak tube will increase by an amount equal to a little more than $\frac{1}{2}$ of the current to the carrier tube. The fact that the plate current increases about $\frac{1}{3}$, and not $\frac{1}{2}$, indicates that the amplifier increases in efficiency as the modulation is applied. That has been our experience in regard to the efficiency. The unmodulated efficiency was measured as 57% and increased several percent at 100% modulation. On the other hand, Doherty² states that the plate current increases about $\frac{1}{2}$ and that the efficiency remains practically constant for different percentages of modulation.

² W. H. Doherty, "A New High Efficiency Power Amplifier for Modulated Waves," *Proc. I. R. E.*, 24, 9, Sept., 1936.
(Continued on page 122)

NOW! A compact Portable Transmitter and Non-Radiating Receiver for the popular Ultra-High Frequencies . . .
● AN IDEAL FIXED OR MOBILE STATION ●

"Type TR-6A6"

- Better Than Ever
- 7 Tubes — Jensen Dynamic Speaker
- New 6E6 Unity Coupled
- 10 Watt Carrier
- 100% Modulation
- Duplex Operation—PHONE ● ICW

F.O.B. FACTORY
Less Tubes

\$39.75

RADIO TRANSCIVER LABORATORIES
8627 — 115 Street, Richmond Hill, New York

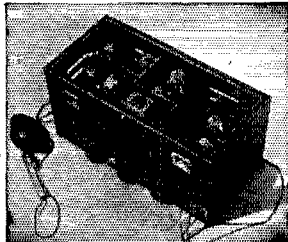

AMATEUR RADIO Map of World

I.A.R.U.—W.A.C.

All known districts and sub-divisions

Principal cities of the world

Divisions

Six colors and black

Countries designated by prefixes

U. S. inspection districts and examining points

180 prefixes in large red letters

230 countries indexed

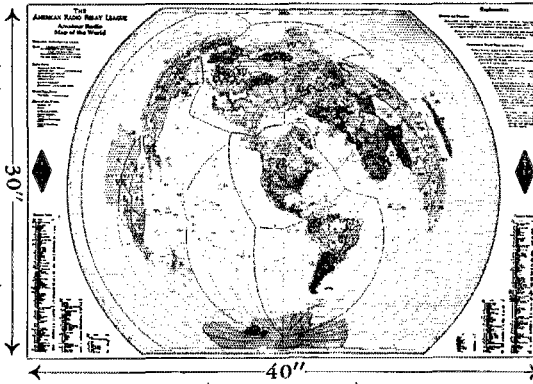

2% accuracy for distance measures in miles and kilometers

Time zones — legal and Greenwich

PRICE
\$1.25
POSTPAID

A. R. R. L.
W. HARTFORD
CONNECTICUT

Radio Operator's Course
Complete in
Telegraphy—
Telephony

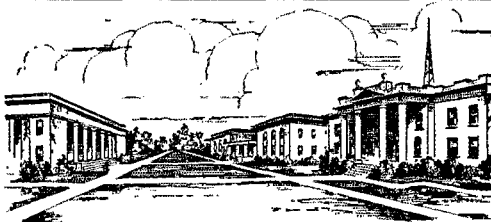

Practical
Experience
Studio—
Transmitter—
Announcing

P. A. C. is an endowed, educational institution — not privately owned, not operated for profit, maintaining college rank. Tuition rate \$15.00 a month; Dormitory room and board \$23.00 a month. The Radio Course consists of the maximum knowledge necessary to secure Commercial Telegraph Second-class and Radio Telephone First-class government licenses. The course includes Police and Aeronautical Radio, Service, actual experience in Wireless Code, Radiophone, Announcing, Microphone-Studio Technique. We are authorized to teach RCA texts. You receive practical studio experience in our commercial broadcast studios located in the administration building, and experience as an operator on K P A C (500-Watt Commercial transmitter located on the campus, owned and operated by the college), and inter-departmental marine communication experience.

If interested, write for Bulletin R

PORT ARTHUR COLLEGE

PORT ARTHUR (World-known port) TEXAS

Mims SIGNAL SQUIRTERS

ROTARY BEAM ANTENNAS
20 and 10 METERS ONLY

Full descriptive information, pictures and details of our kits making it easy for you to "PUT YOUR SIGNAL WHERE YOU WANT IT—WHEN YOU WANT IT THERE." Send 5c for your copy.

Mims Radio Co.

[M. P. Mims, W5BDB]

P. O. Box 504

Texarkana, Ark.

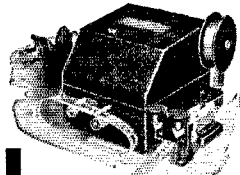

At Last!
A Perfected
**AUTOMATIC
SENDER**

Save your fist. Let the Automatic Sender raise your stations for you. Repeats calls or messages indefinitely. Length of messages unlimited. Sends from 2 to 70 words a minute. Motor driven. Entirely automatic. Built-in tape perforator. Absolute uniformity in spacing of characters. Used with buzzer or oscillator, makes excellent code teacher for novice and speed-builder for the advanced amateur. Complete with 4 rolls of tape and full instructions. No extra equipment needed. If your dealer can't supply you, write us.

only
\$12.50

Postpaid
in U. S. A.
Patent
Pending

MONEY-BACK GUARANTEE

Gardiner-Levering Co. Haddon Heights
New Jersey, U. S. A.

Say You Saw It in QST — It Identifies You and Helps QST

Where to buy it

A directory of suppliers who carry in stock the products of these dependable manufacturers.

ASTATIC
Crystal Microphones and Pickups

ASTATIC MICROPHONE LABORATORY, Inc. YOUNGSTOWN, O.
Pioneer Manufacturers of Quality Crystal Products

- AKRON, OHIO 110 E. Market Street
Brighton Sporting Goods Corp.
- CHICAGO, ILL. 833 West Jackson Blvd.
Allied Radio Corporation
- CHICAGO, ILL. 601 W. Randolph St.
Pioneer Automotive Supply Co.
- CHICAGO, ILLINOIS 226 W. Madison Street
Newark Electric Company
- CHICAGO, ILL. 901-911 W. Jackson Blvd.
Wholesale Radio Service Company, Inc.
- KANSAS CITY, MO. 1012-14 McGee St.
Burstein-Applebee Company

super skyrider
hallicrafters
ultra skyrider

- AKRON, OHIO 110 E. Market Street
Brighton Sporting Goods Corp.
- CHICAGO, ILL. 833 W. Jackson Blvd.
Allied Radio Corp.
- CHICAGO, ILLINOIS 415 S. Dearborn Street
Chicago Radio Apparatus Company
- CHICAGO, ILLINOIS 19 S. Wells St.
Hinds & Edgerton
- CHICAGO, ILL. 901-911 W. Jackson Blvd.
Wholesale Radio Service Company, Inc.
- CINCINNATI, OHIO 633 Walnut St.
Steinberg's, Inc.
- COLUMBUS, OHIO 61 E. Goodale St.
Bell Radio Parts Co.
- DETROIT, MICHIGAN 5027 Hamilton Ave.
Rissi Brothers, Inc.
- DETROIT, MICH. 171 E. Jefferson Ave.
Radio Specialties Co.
- DULUTH, MINN. Northwest Radio 109 E. 1st St.

- INDIANAPOLIS, IND. 34 W. Ohio St.
Van Sickle Radio, Inc.
- KANSAS CITY, MO. 1012 McGee Street
Burstein-Applebee Company
- OMAHA, NEBRASKA 2855 Farnam St.
Radio Accessories Company
- ST. LOUIS, MO. 927 Pine Street
Gordon Radio Company

RCA Amateur Products

- AKRON, OHIO 110 E. Market Street
Brighton Sporting Goods Corp.
- BUTLER, MO. 211 N. Main St.
Henry Radio Shop
- CHICAGO, ILL. 226 W. Madison Street
Newark Electric Company
- CHICAGO, ILL. 833 W. Jackson Blvd.
Allied Radio Corporation
- CHICAGO, ILL. 901-911 W. Jackson Blvd.
Wholesale Radio Service Company, Inc.
- CHICAGO, ILLINOIS 25 North Franklin Street
Electric & Radio Supply Co., Inc.
- CHICAGO, ILLINOIS 415 S. Dearborn Street
Chicago Radio Apparatus Company
- CINCINNATI, OHIO 633 Walnut Street
Steinberg's, Inc.
- CLEVELAND, OHIO 2073 West 85 Street
Northern Ohio Laboratories
- CLEVELAND, OHIO 610 Huron Road
Goldhamer, Inc.
- COLUMBUS, OHIO 178 N. 3rd Street
Hughes-Peters Electric Corp.
- DAYTON, OHIO 140 E. 3rd Street
Burns Radio Company
- DETROIT, MICH. 171 E. Jefferson Ave.
Radio Specialties Co.
- FLINT, MICH. 203 W. Kearsley St.
Shand Radio Specialties
- KANSAS CITY, MO. 1012 McGee St.
Burstein-Applebee Company

Where to buy it

A directory of suppliers who carry in stock the products of these dependable manufacturers.

MINNEAPOLIS, MINN. 1124-6 Harmon Pl.
Lew Bonn Co.

TORONTO, CANADA 1137 Bay St.
Wholesale Radio Company, Ltd.

RME
RECEIVERS -- PRE SELECTORS
AMATEUR RADIO EQUIPMENT
RADIO MFG. ENGINEERS, Inc.
PEORIA ILLINOIS

BUTLER, MISSOURI 211-215 N. Main Street
Henry Radio Shop

CANTON, OHIO 620 Tuscarawas Street, W.
Radio Electric Supply Company

CHICAGO, ILLINOIS 19 South Wells Street
Hinds & Edgarton

CHICAGO, ILLINOIS 226 West Madison Street
Newark Electric Company

CHICAGO, ILLINOIS 415 South Dearborn Street
Chicago Radio Apparatus Company

CINCINNATI, OHIO North Bend Road, Mt. Airy
Jos. N. Davies

INDIANAPOLIS, INDIANA 34 West Ohio Street
Van Sickle Radio Shop

MINNEAPOLIS, MINNESOTA 1124-26 Harmon Place
Lew Bonn Company

RAYTHEON
TRADE MARK
AMATEUR TUBES

AKRON, OHIO 110 E. Market Street
Brighton Sporting Goods Corp.

CHICAGO, ILLINOIS 226 W. Madison Street
Newark Electric Company

CINCINNATI, OHIO 633 Walnut Street
Steinberg's, Inc.

CLEVELAND, OHIO 2073 West 85th Street
Northern Ohio Laboratories

Use **SHURE**
MICROPHONES
Microphone Headquarters

AKRON, OHIO 110 E. Market Street
Brighton Sporting Goods Corp.

CHICAGO, ILL. 226 W. Madison Street
Newark Electric Company

CHICAGO, ILL. 833 W. Jackson Blvd.
Allied Radio Corp.

CHICAGO, ILL. 901-911 W. Jackson Blvd.
Wholesale Radio Service Company, Inc.

CHICAGO, ILLINOIS 25 North Franklin Street
Electric & Radio Supply Co., Inc.

CLEVELAND, OHIO 610 Huron Road
Goldhamer, Inc.

DETROIT, MICH. 171 E. Jefferson Ave.
Radio Specialties Co.

MINNEAPOLIS, MINN. 1124-6 Harmon Pl.
Lew Bonn Co.

TRIPLET
INSTRUMENTS

AKRON, OHIO 110 E. Market Street
Brighton Sporting Goods Corp.

ANN ARBOR, MICH. 331 S. Main St.
Purchase-Radio

CHICAGO, ILL. 833 W. Jackson Blvd.
Allied Radio Corporation

CHICAGO, ILL. 226 W. Madison Street
Newark Electric Company

CHICAGO, ILL. 901-911 W. Jackson Blvd.
Wholesale Radio Service Company, Inc.

CHICAGO, ILLINOIS 25 North Franklin Street
Electric & Radio Supply Co., Inc.

CINCINNATI, OHIO 633 Walnut Street
Steinberg's, Inc.

CLEVELAND, OHIO 610 Huron Road
Goldhamer, Inc.

INDIANAPOLIS, IND. 34 W. Ohio St.
Van Sickle Radio, Inc.

MINNEAPOLIS, MINN. 1124-6 Harmon Pl.
Lew Bonn Co.

TORONTO, CANADA 1133-1137 Bay St.
Wholesale Radio Company, Ltd.

NEW X BIRNBACH 'mitting sockets AT LOW PRICES

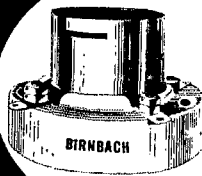

featuring

- SIDE WIPING CONTACTS
- BRASS, NICKEL PLATED SHELL
- HIGHLY VITRIFIED, LOW ABSORPTION
- ALL BRASS HARDWARE
- LOW PRICES

No. 434. 50 watt.
\$1.25 list ea.

No. 435. 10 watt.
90c list ea.

SPECIAL LOW PRICES IN LARGE QUANTITIES

Improved Cone Standoff Insulators

Made of STEATITE, the better ceramic. Complete range of heights. Condenser, coils, tube sockets, etc., can be mounted with minimum labor. White glaze only.

No.	Heights	List	See your jobber. If he cannot supply you, write direct to Dept. Q-2.
430	5/8"	10c	
431	1"	15c	
431J (Jack Type)	1"	20c	
432	1 1/8"	20c	
432J (Jack Type)	1 1/8"	25c	
433	2 3/4"	25c	
433J (Jack Type)	2 3/4"	50c	



BIRNBACH RADIO CO.
145 HUDSON ST. BIRCO NEW YORK, N. Y.

PRECISION CRYSTALS

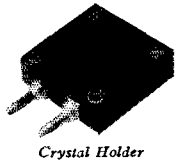

Highest quality crystals one-inch square, carefully ground for frequency stability and maximum output. Be sure of your transmitter frequency—use PRECISION CRYSTALS.

X cut PRECISION Crystals carefully ground for maximum power supplied within 0.1% of your specified frequency and calibrated to within 0.03% are priced as follows: 1750, 3500 and 7000 kc. bands—

\$3.00 each. Add \$1.00 to above price if plugin, dustproof holder is desired. (Holder as illustrated to fit G.R. jacks or round holder to plug into a tube socket can be furnished.) G.R. jacks to plug illustrated holder into — \$1.5 pair.

Low frequency drift crystals (Type LTC) having a drift of less than 5 cycles per million per degree C. are supplied at the following prices: 1750 and 3500 kc. bands — \$3.50 each; 7000 kc. band — \$4.00 each. Holder \$1.00.

AT cut crystals for commercial use quoted on at your request. When ordering our product you are assured of the finest obtainable. Now in our sixth year of business.

PRECISION PIEZO SERVICE
427 Asia Street Baton Rouge, La.

GULF RADIO SCHOOL

Radiotelegraphy Radiotelephony
Radio Servicing
SECOND PORT } 1007 Carondelet Street
U. S. A. } NEW ORLEANS, LA.

An explanation of this difference and in the slightly lower efficiency than expected probably lies in the relatively "hi-loss" tank circuits used in the experimental model. The tank circuit across the carrier tube has full r.f. voltage across it at all times and gets quite warm in operation. Losses in both plate tank circuits are supplied by the carrier tube when no modulation is present. When modulating, the peak tube supplies loss to its tank circuits only. On 100% modulation peaks, the carrier tube would be supplying more than twice the carrier output to the filter, while the peak tube is supplying just twice the carrier power.

The W. E. 211-D tubes used in the experimental model are old timers of the type recently advertised for sale at bargain prices. After our experience with them, we most emphatically do not recommend them for use in this amplifier, at least not at as high a frequency as 3900 kc.

As to the possibilities of this amplifier at higher frequencies, frankly we do not know. We would like to try our hand at it on 14 Mc., but not being able to do that, we hope that amateur-engineers will see what can be done about it at that frequency.

In conclusion, I wish to thank faculty members of the Electrical Engineering Department of Iowa State College for their aid during this project, and also to thank W. E. Stewart, chief engineer of WOI, for his criticisms during the preparation of this paper.

Strays

"Enamel-on," a bakelite paint sold in the dime stores, looks great on tempered Masonite panels.
—W11KC

W2CLM apparently doesn't believe in the use of radio frequency. He spent half an hour the other day at W2HEU trying to raise someone with the entire r.f. unit turned off and the Class-B modulator working into a dummy load. The diligence with which he combed the 20-meter band after a CQ looking for an answer to his 60 to 5000 cycle transmissions was quite amusing.
—W2HEU

AMATEURS EVERYWHERE

Use VALPEY Crystals

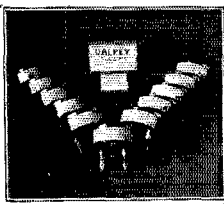

The type VM2 mounted crystal employs a power type X cut crystal, precision ground to its finished frequency, supplied to within 5kc's. of your specified frequency in the 1.7, 3.5, 7Mc. bands—\$3.00. Exact frequency \$5.00.

The type VM2A mounted crystal employs a power type crystal, frequency drift less than 4 cycles /M/°C precision ground to its finished frequency, supplied to within 5kc's. of your specified frequency in the 1.7, 3.5, 7Mc. bands — \$4.50. Exact \$6.50.

Our products may be obtained from your dealer or by ordering direct
THE VALPEY CRYSTALS, 377 Summer St., Medway, Mass.

HAM-ADS

(1) Advertising shall pertain to radio and shall be of nature of interest to radio amateurs or experimenters in their pursuit of the art.

(2) No display of any character will be accepted, nor can any special typographical arrangement, such as all or part capital letters be used which would tend to make one advertisement stand out from the others.

(3) The Ham-Ad rate is 15¢ per word, except as noted in paragraph (6) below.

(4) Remittance in full must accompany copy. No cash or contract discount or agency commission will be allowed.

(5) Closing date for Ham-Ads is the 25th of the second month preceding publication date.

(6) A special rate of 7¢ per word will apply to advertising which, in our judgment, is obviously non-commercial in nature and is placed and signed by a member of the American Radio Relay League. Thus, advertising of home made surplus equipment owned, used and for sale by an individual or apparatus offered for exchange or advertising inquiring for special equipment, if by a member of the American Radio Relay League takes the 7¢ rate. An attempt to deal in apparatus in quantity for profit, even if by an individual, is commercial and takes the 15¢ rate. Provisions of paragraphs (1), (2), (4) and (5) apply to all advertising in this column regardless of which rate may apply.

Having made no investigation of the advertisers in the classified columns, the publishers of *QST* are unable to vouch for their integrity or for the grade or character of the products advertised.

QUARTZ—direct importers from Brazil of best quality pure quartz suitable for making piezo-electric crystals. Diamond Drill Carbon Co., 719 World Bldg., New York City.

RADIO engineering, broadcasting, aviation and police radio, servicing, marine and Morse telegraphy taught thoroughly. All expenses low. Catalog free. Dodge's Institute, Byrd St., Valparaiso, Ind.

NATIONAL—Hammarlund, RCA-RME used sets, 60% off list. W3DQ, 405 Delaware Ave., Wilmington, Del.

QSL's, W2SN, Helmetta, N. J.

CLASS B transformers—Universal for two or four 46's, 6L6's, 210's, 800's, etc., \$7.75 pair postpaid. 70 watts audio from 46's, 100 watts from 10's. Write for details. W8UD, Douglas, Mich.

CALBOOKS—new DX calls, new prefixes, thousands of new W and VE calls, in the Winter 1936 Radio Amateur Call Book. Sent postpaid \$1.25, or a whole year (four issues) for \$4. (In foreign countries \$1.35 and \$4.35.) Your call and QRA printed in large type \$1 per year. Radio Amateur Call Book, 610 S. Dearborn, Chicago.

TELEGRAPH speed keys in kit form, only \$2.89. A post card brings full information. Electric Specialty Mfg. Co., PO Box 645, Cedar Rapids, Iowa.

GENERAL Electric Dynamotors 24/750 volt 200 mills \$25. Operate on lower battery delivering 30 v per input volt. 500 cycle 500 watts with exciters \$10, slightly used \$6. Henry Kienzle, 215 Hart Blvd., Staten Island, N. Y.

OFFER \$5 for good copy December 1916 *QST* with both covers. Sumner B. Young, Maplewoods, Wayzata, Minn.

CALL pins for lapel or vest—rhodium plated—very neat say satisfied customers. \$1.50. W2CZR.

QSL's. Free samples. Printer, Corwith, Iowa.

TRANSMITTER 53 osc, 53 pp final. 20 watts. Mounted on rack coils 2 bands. Less tubes, power supply. Neat job on crackle chassis, \$18. Superadio, 464 E. 117th, Cleveland.

QSL's. Cartoons. Free samples. Theodore Porcher, 7708 Navaho St., Philadelphia, Penn.

STILL printing those fb QSL's. Stamp for samples. W8CUX. QSL's. No cheap trash. Finest printed. Samples? (stamp) W8DED, Holland, Mich.

CRYSTALS? Bliley, Hi-power? Patronize W8DED.

SWAP—New Shure 5B mike for Mac-Key, Speedy, or good automatic bug. W9SMV.

FIRST \$45 takes SX5 Super Skyriders with crystal. W9N9F, 3119 N. Summit Ave., Milwaukee, Wis.

CRYSTALS: X-cut 80-160, \$1.25. Y-cut \$1. Guaranteed. W9KDE, 538 Wyandotte St., Laurium, Mich.

SELL—*QST's* 1914-1933, Wireless Age, Electrical Experimenter, Radio News, Everyday Engineering, QTC, Pacific Radio News, Science and Invention, 1907 Popular Mechanics, How to Conduct a Radio Club—1916, old call books, vacuum tubes, radio parts. Make offer or ask price. W8BBK, 48 Glenwood, Buffalo, N. Y.

QSL's, 100—75¢. Lapco, 344 W. 39 St., Indianapolis, Ind.

SAMPLES. QSL's—SWL's distinctly better. Fritz, 203 Mason, Joliet, Ill.

FBXA, C, E, 20, 40, 80 coils, power supply; transmitter, 6F6-RK20, crystal switching, power supplies. W1GTX, Wesleyan, Middletown, Conn.

SKYRIDERS, prepaid, easy payments, LaPierre's, Roundup, Mont.

CRYSTALS: 80m X within five kilocycles. \$1.95. 160-80m V, \$2.25. Beautiful holders, \$1. Pyrex bowl antenna-feed insulator sets, \$1.20. Catalog. Ham Crystals, 1104 Lincoln Place, Brooklyn, N. Y.

QSL's. 300 one-color cards, \$1. Samples. 2143 Indiana Ave., Columbus, Ohio.

QSL cards, two color, cartoons, snappy service. Write for free samples today. W1BEF, 16 Stockbridge Ave., Lowell, Mass.

SELL: 50 watt C.W. 20 watt fone, four bands. Receiver photos. Parts list. Price. Real bargain. W8FVU.

INSIGNIA pin with your call letters, compact and beautifully hand finished—\$1.25. Kalina & Kamens, Inc., 42 W. 48 St., N. Y. C.

CRYSTALS: Zero cut. Guaranteed to compensate at near zero without oven. 80-160 meters, \$1.85. Forty meters, \$2. Holders, 75¢ postpaid. Fisher Lab., 4522 Norwood St., San Diego, Calif.

QSL's, SWL's. Stationery. Quality. Samples? Stamp. Connell, Box 144, Geneva, N. Y.

QSL's by Maleco, 1512 Eastern Parkway, Brooklyn, N. Y. 3,000,000 our cards in use.

QSL's—Special introductory offer. Radio Headquarters, Ft. Wayne, Indiana.

CRYSTAL mikes: Complete ready for mounting on stand, \$4.75. Tibbetts Labs.

CRYSTALS: Eidson T9 X cut, dependable, powerful. Ground to resist fracture. Accurately calibrated, close frequency supplied: 40, 80, 160 meters \$1.50 postpaid, fully guaranteed. Superlapped T9 ceramic plug-in holders \$1.10 postpaid. C. O. D. orders O.K. Eidson's, Temple, Texas.

AT cut crystals with mountings \$2.35 each. Forty meter plates \$2. Holders 60¢. Special 80 and 160 meter plates 95¢. White Radio Lab., Standpoint, Idaho.

CRYSTALS in small round bakelite plug-in (socket) mountings. X-cut, 160-80m \$1.75, 40m \$2. AT, Y-cut, near zero drift, 160-80m \$2.25, 40m \$2.50. Free gift. Money back guarantee. C. O. D. if desired. Premium Crystal Co., Box 2250-B, Kansas City, Mo.

TRANSFORMERS 1 K.W. 1200-2200-3000 each side \$20. Frank Greben, W9CES, 2012 S. Peoria St., Chicago, Ill.

MICK-MACK Telesketch outfit now 58¢ postpaid. Transmit sketches. Wide use. Mick-Mack, 115 Clay St., Wollaston, Mass.

CRYSTALS: X-cut; 80m within 5 kc. \$1.10; 40m \$1.40. AT, Y-cut 160-80m \$1.60, 40m \$1.85. Unconditionally guaranteed. Large, round molded bakelite plug-in holders 90¢. C.O.D.'s accepted. Star Crystal Co., 1324-F Georgia, Kansas City, Kansas.

WESTON D.C. milliamperemeters, Model 506, 0-300 scale, \$3. General Electric A.C. ampere meters, Type AO, 0-30, \$2. Miller Surplus, 2553 Madison, Chicago.

QSL's—New designs. Finest yet. Samples on request. W2AEY.

HALLICRAFTERS 1937 Skyriders. W9ANZ.

1000 volt Motorgenerator, \$25. W9ANZ.

1000 volt Generator, \$15. W9ANZ.

SURPLUS parts list. W9ANZ.

HALLICRAFTERS 1937 Skyriders. W9ANZ.

RME-69 practically new, perfect condition—\$110 cash. Dr. Stauch, Herman Kiefer Hospital, Detroit.

SARGENT Super 9-33 complete, Preselector, speaker. Highest offer takes it. W6JZZ.

QSL's: Better designs; better stock; better workmanship. Free samples to Hams only. W2FJE, 143 DeKalb Ave., Brooklyn, N. Y.

CRYSTALS: Unconditionally guaranteed, small X cut, 80-160 meters, within ten kilocycles, \$1.50. Approximately 17' spot frequency \$2.50. Small X cut, 80 meter semi-finished blanks, including carborundum, three for \$1.20. Dustproof plug-in holders, 85¢. William Threm, W8FN, 4021 Davis Ave., Cheviot, Ohio.

QSL's—2 color—\$1. hundred. W8NOS.

PLATE transformers—Hilet 2 1/2 kw. new and guaranteed, all voltages, \$39. Send for circular. Leitch, Park Drive, W. Orange, N. J.

LARGE stock Eidson's X cut, accurately calibrated, 40 meter crystals \$1.50. 80's and 160's ground on order, \$1.50. Efficient ceramic holder standard banana prongs \$1.10 postpaid. Hieronymus Radio, 88-34 209th St., Queens Village, N. Y. Postcard C.O.D. orders O. K.

SALE—Fort Wayne type KIK W. H. meters. 60 cycle, 110 or 220 volts. \$2 each. W1D0H

REBUILT vibroplexes \$6. New large base bugs \$9. Guaranteed. Lydeard, 14 Temple, Mattapan, Mass.

TELEPLEXES, instructographs, omnigraphs, vibroplexes, meters, receivers, tubes bought, sold, traded. Ryan Radio Co., Monroe City, Mo.

CRYSTALS: 1" square, X cut 80-160 meters \$1.40, 40 meters \$2.50. Within 3 kc. of desired freq. Naval Reserve Freqs., \$1.40. Guaranteed the very best. The Ransom Lab., N. Syracuse, N. Y.

SUPERHET—wanted—cheap. W3FYV.

USED RK20's. W8ANT.

USED receivers. W8ANT.

USED tank condensers. W8ANT.

ALL lines of new equipment. W8ANT.

NEW receivers, all makes. W8ANT.

NEW 42A. Cheap. W8ANT.

ALL lines of new transmitting tubes. W8ANT.

W8ANT—1 kw.—14376 kc. psc QSL. W8ANT.

ALL lines of new and used amateur equipment for sale. Parts bought, sold, and exchanged. Write to Southern Ohio's only amateur owned amateur business, Jos. N. Davies, W8ANT, 2767 N. Bend Rd., Sta. A, Cincinnati, Ohio.

SALE—Complete code machine, Homestudy Radio Course, Hyatt, Van Deusen, Kingston, N. Y.

WE are specialists supplying precision cut blanks to many grinders of fine crystals. Write for prices. Faberadio, Sandwich, Ill.

8000V GE transformers center-tapped. Type KD950; 110 or 220V; 4.25KVA; Primary switch gives RAC 4000, 3650, 3300, 2950, 2600, 2250, 200V; round steel cases; 15 gallons oil; perfect condition, \$20. Write details. WIBES, 143 Eastwood Ave., Prov., R. I.

SELL: National SW5's and SW45's with tubes \$12, any coils \$1 a pair, National power packs \$7; FB7A's with tubes \$26, any coils \$4 a pair, Super Skyriders S5 \$37.50, SX5 \$40, SX6 \$40, S9 \$59.50, SX9 \$64.50; ACR-136's \$45; Peak P11 and Miller preselectors with tubes \$12.50. Other receivers. W9ARA, Butler, Mo.

SELL: Brand-new GE211's \$6.95; carbon plate RCA203-A's \$6.95, RCA860's \$9; WE276A's, 261A, 242A's \$6.95; WE251A's \$50. Other tubes. W9ARA, Butler, Mo.

HUNDREDS of new and rare electrical items, replacement parts and supplies. Send 10¢ for new 60-page wholesale catalog. Autopower, 408 S. Hoyne, Dept. R, Chicago.

GUARANTEED first class condition complete with tubes and speaker. First come first served. Patterson PR10 \$39, Hallcraft Super 7 \$29, Hallcraft Sky rider 9 \$49, RME-9D \$75, All-Star Jr. \$19, Sargent 20 \$30. W9KJF, 34 W. Ohio St., Indianapolis.

25¢ prepaid—Second edition transmitting manual and fifteen manufacturers parts catalogs. Van Sickle Radio, Inc. (W9KJF) 34 W. Ohio St., Indianapolis, Ind. Distributors of all leading transmitting lines.

WLEWD selling xmtr, 210 final, plenty excitation, fine DX record. Price \$50. Send for photo and details. Kenneth Bishop, 230 Kelsey St., New Britain, Conn.

COMPARE Before You BUY QUALITY and PRICE of BUD RADIO PRODUCTS

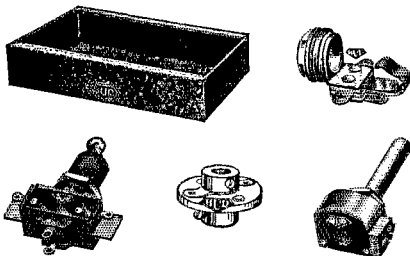

Secure Them From Your Jobber
Free 32-Page Catalog Sent You Upon Request

Bud Radio Inc., Cleveland, O.



STAND BY!

I'M GOING
UP 3 KC'S -
THERE'S LESS
QRM THERE

BLILEY VF1 Price
Variable
CRYSTAL UNIT \$8⁰⁰

Why 100,000 Operators

New

GENUINE
MARTIN

VIBROPLEX
SEMI
AUTOMATIC KEY

JUNIOR

Weight 2¾ lbs.

ONLY \$12.50

Smaller and
more compact.
Large contact
points. Black
japaned base. A low
priced key with world
famous Vibroplex
quality.

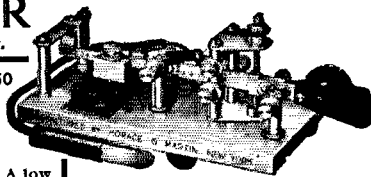

More than 100,000 experienced Radio and Morse operators prefer the Vibroplex key because its semi-automatic style produces a higher quality signal . . . a more uniform style of sending

. . . 50% easier manipulation and a degree of sending proficiency seldom attained by users of the regulation telegraph key. So if you want the best, be sure to insist on the Genuine Martin Vibroplex key. Accept no substitute. Order yours TODAY! Money order or registered mail. Other models \$17 and \$19. Write for FREE Illustrated Catalog.

FREE
Catalog

The
Martin
Vibroplex

THE VIBROPLEX CO., INC.

832 Broadway

New York, N. Y.

LEARN CODE RIGHT

—the practical, easy way—



And Now — Airways Tapset
Tapes to teach you every type
of sending are available through
INSTRUCTOGRAPH.

Radio amateur code exams now require 30% more speed. And experts agree: "It pays to learn from a perfect teacher — Instructograph." It's easy to become a real operator when you can practice Radio or Morse at your convenience — at any speed you want. Comes in two models — Senior or Junior. Economy. You may buy or rent, at low cost. Just send post-card for complete details now to —

INSTRUCTOGRAPH CO.
Dept. Q-2

912 Lakeside Place Chicago, Illinois
Representatives for Canada
Radio College of Canada
863 Bay, Toronto

Also Hallcrafters Receivers —
Cash or Terms

RADIO COURSES

RADIO OPERATING: Prepare for Gov't License Exam. ●
RADIO SERVICING: including Short Wave ● AMATEUR
CODE ● ELECTRONICS ● TELEVISION ●

Day and Evening classes — Booklet upon Request
NEW YORK YMCA SCHOOLS
4 West 63rd Street, New York City

Your Nearest Dealer Is Your Best Friend

Your nearest dealer is entitled to your patronage. You can trust him. He is equipped with a knowledge and understanding of amateur radio. He is your logical and safe source of advice and counsel on what equipment you should buy. His stock is complete. He can supply your needs without delay. His prices are fair and consistent with the high quality of the goods he carries. He is responsible to you and interested in you.

Patronize the dealer nearest you — You can have confidence in him

CHICAGO, ILLINOIS

Allied Radio Corporation
833 West Jackson Blvd.

Complete standard lines always in stock—W9PVH—W9IBC—W9RZI

CHICAGO, ILLINOIS

Chicago Radio Apparatus Company
415 South Dearborn Street (Est. 1921)

W9RA and W9PST — Amateurs since 1909

DENVER, COLORADO

Inter-State Radio & Supply Co.
1639 Tremont Place

Amateur Radio Headquarters in the Rocky Mountain Region

DETROIT, MICHIGAN

Radio Specialties Company
171 E. Jefferson Avenue

Ham Supplies — National & Hammarlund Sets and Parts

DETROIT, MICHIGAN

Rissi Brothers
5027-31 Hamilton Ave. at Warren
WBKXK Manager Amateur Department

DETROIT, MICH.

Serlin Stores
1419 Broadway, near Grand River
Amateur parts — receivers — transmitters

FRESNO, CALIFORNIA

Ports Manufacturing Co.
3265 E. Belmont Ave.

Wholesale: RCA-Thordarson-Bliley. All Standard Lines

DES MOINES, IOWA

Iowa Radio Corp.
1212 Grand Avenue

Complete amateur stock, W9OCG—W9EMS—W9KAY

KANSAS CITY, MISSOURI

Burstein-Applebee Company
1012-14 McGee Street

"Specialists" in supplies for the Amateur and Serviceman

KANSAS CITY, MISSOURI

Radiolab
1515 Grand Avenue

Amateur Headquarters in Kansas City

MILWAUKEE, WISCONSIN

Radio Parts Company, Inc.
538 West State Street

Complete stock Nationally Known products

MINNEAPOLIS, MINNESOTA

Electric City
1607 Hennepin Street

Headquarters for standard lines of amateur and servicemen parts

MINNEAPOLIS, MINNESOTA

Lew Bonn Co.

1124-26 Harmon Place

W9BP—W9TLE—W9HOP—W9DKL—W9LEX

OAKLAND, CALIFORNIA

Offenbach Electric Company
2085 Broadway

"The House of a Million Radio Parts"

SALT LAKE CITY, UTAH

Felt Radio Company
150 South Main Street

W6IAL—W6HVU—Intermountain Distributors—W6ENI—W6EPN

SAN FRANCISCO, CALIFORNIA

Offenbach Electric Company, Ltd.
1452 Market Street

"The House of a Million Radio Parts"

ST. LOUIS, MISSOURI

Van Sickle Radio Company
1113 Pine Street

W90WD invites you to amateur headquarters in St. Louis

TORONTO, CANADA

A & A Radio Service Supply
101 Queen Street, West

Canada's foremost radio supply house

WINNIPEG, CANADA

Electrical Supplies, Ltd.
306-10 Ross Avenue

Western Canadian Amateur Headquarters for leading lines

You Are Protected When You Buy From QST Advertisers

“Advertising for QST is accepted only from firms who, in the publisher’s opinion, are of established integrity and whose products secure the approval of the technical staff of the American Radio Relay League.”

Quoted from QST’s advertising rate card.

Every conceivable need of a radio amateur can be supplied by the advertisers in QST. And you will know the product has the approval of the League’s technical staff.

For Your Convenience QST’S INDEX TO ADVERTISERS IN THIS ISSUE

Aerovox Corporation.....	110
Aladdin Radio Industries, Inc.....	102
Allen-Bradley Company.....	89
Amperex Electronic Products.....	77
Astatic Microphone Laboratory.....	108
Autopower, Inc.....	115
A.R.R.L. Back Copies & Binders.....	113
Binders.....	113
Calculators.....	115
Emblem.....	112
Handbook.....	70, 71
Hints & Kinks.....	107
How to Become a Radio Amateur.....	117
License Manual.....	108
Barker & Williamson.....	118
Bellefonte Radio Eng. & Mfg. Co., Inc.....	103
Birnbach Radio Company.....	122
Bliley Electric Company.....	111, 124
Brach Mfg. Company, L. S.....	92
Burl Radio, Inc.....	124
Burgess Battery Company.....	129
Burton-Rogers Company.....	115
Candler System Company.....	78
Capitol Radio Engineering Institute.....	94
Cardwell Manufacturing Corp., Allen D.....	72
Centralab.....	76
Clough-Bremble Company.....	80
Cohen's Sons, Ltd., L. S.....	109
Collins Radio Company.....	Cov. 2
Cornell-Dubilier Corporation.....	94
Delaware Radio Sales Company.....	92
Etitel-McCullough, Ltd.....	87
Electrad, Inc.....	96
Freek Radio & Supply Company.....	109
Gardiner Levering Company.....	119
General Radio Company.....	107
Gross Radio, Inc.....	99
Gulf Radio School.....	122
Hallcrafters, Inc., The.....	1
Hammjarlund Manufacturing Company.....	4
Harvey Radio Company.....	112
Harvey Radio Laboratories, Inc.....	110
Harty & Young.....	116
Heintz & Kaufman, Ltd.....	111
Henry Radio Shop.....	117
Hinds & Edgerton.....	2
Hipower Crystal Company.....	114
Instructograph Company.....	124
Johnson Company, E. F.....	90
Kenyon Transformer Company.....	114
Leeds.....	95
Massachusetts Radio School.....	114
McElroy, T. R.....	118
McGraw-Hill Book Company.....	82
M & H Sporting Goods Company.....	117
Mims Radio Company.....	119
Montgomery-Ward & Company.....	91
National Carbon Company.....	84
National Company.....	Cov. 3, 69, 83, 103
Newark Electric Company.....	97
New York Y. M. C. A. Schools.....	124
Ohmite Manufacturing Company.....	102
Omaha Crystal Laboratories.....	111
Port Arthur College.....	119
Precision-Piezo Service.....	122
Radiolab.....	109
Radio Mfg. Engineers, Inc.....	127
Radio Shack.....	113
Radio Supply Company.....	113
Radio Transceiver Laboratories.....	118
RCA Institutes, Inc.....	111
RCA Manufacturing Company.....	Cov. 4, 75
Scientific Radio Service.....	117
Shure Brothers.....	98
Sickles Company, F. W.....	118
Signal Electric Manufacturing Co.....	96
Spier Carbon Company.....	5
Sprague Products Company.....	86
Stewart Technical School.....	117
Sun Radio Company.....	109
Sundt Engineering Company.....	98
Taylor Tubes, Inc.....	73
Teleplex Company.....	118
Terminal Radio Corporation.....	117
Thordarson Electric Mfg. Company.....	85
Transducer Corporation.....	74
Transmitter Equipment Mfg. Company.....	81
Trimm Radio Manufacturing Company.....	90
Triplett Electrical Instrument Co.....	6
Turner Company.....	106
United Transformer Company.....	128
Universal Signal Appliance Company.....	106
Utah Radio Products Corporation.....	88
Valpey Crystals.....	122
Vibroplex Company.....	124
Willard S. Wilson.....	92

RME - 69

Details Count!

In designing and assembling communication type equipment too much stress cannot be laid on individual details.

Sturdy frames, adequate and well bonded shields, rigid mounting of coils, and correct location of parts for electrical efficiency throughout the circuit spell the difference between just an ordinary receiver and an RME-69 Single Signal Super.

RME has always invited rigid inspection and knows from past experience in the Ham game that—details count!

Write for Bulletin 69

Radio Mfg. Engineers, Inc.

Peoria, Illinois

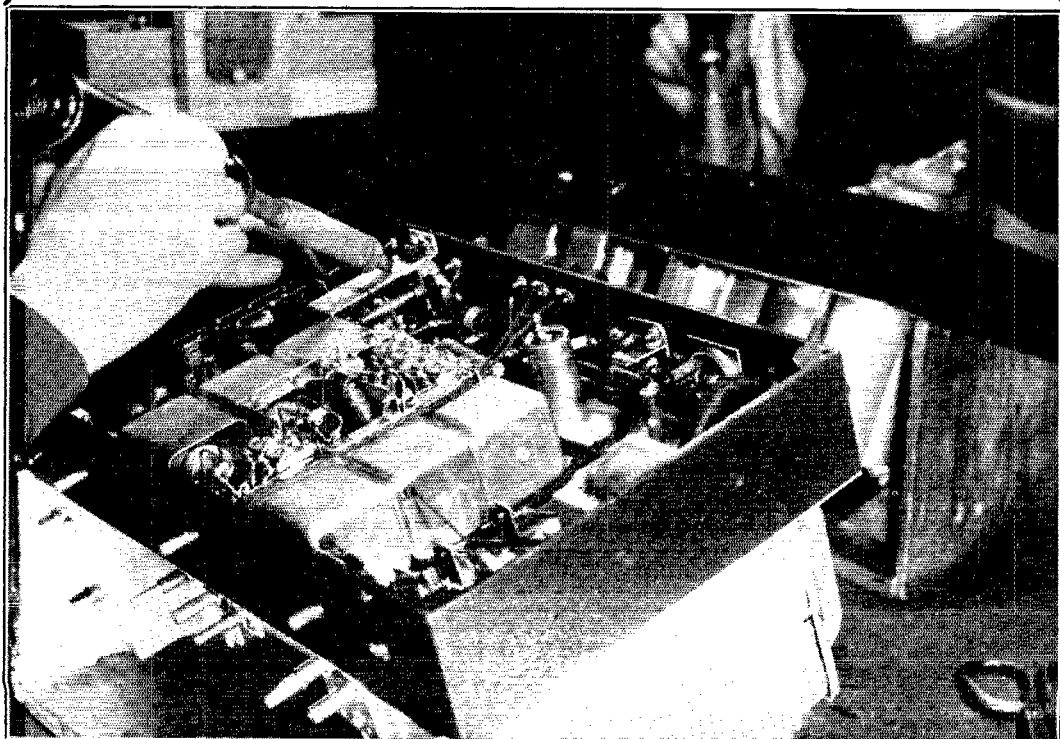

Power Equipment is NEVER OBSOLETE with UTC VARIPOWER AUTOFORMERS

These UTC Varipower Autoformers are being put to new uses daily. In addition to the many amateur applications, they are being used for testing and measuring work . . . soldering iron and electrical heat control . . . illumination control for theatre and photographic use . . . motor speed and welding current controls.

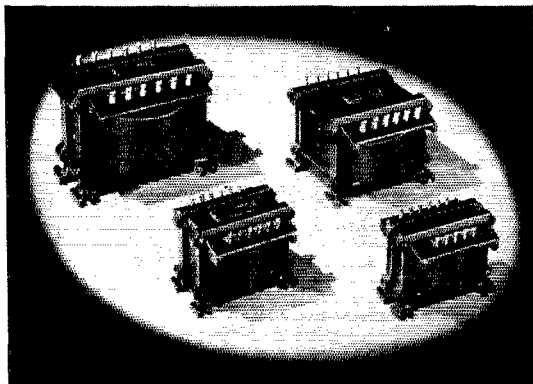

For amateur service, they may be used for:

LINE VOLTAGE CONTROL — Using the Varipower Autoformer, any line voltage from 60 to 130 volts can be corrected to within $2\frac{1}{2}$ volts of desired value.

VARIABLE VOLTAGE UNIT — UTC Varipower units are arranged so that simultaneously with line voltage correction any output voltage can be obtained from 0 to 130 volts in 5 volt steps. Using the autoformer with a standard plate transformer a very wide range in plate voltage can be obtained. Power can be cut down for local service, or a plate transformer intended for one application can be used for another. An 801 plate transformer can be used for 6L6's, or a plate transformer for HF300's or 250T's can be used with 203A's till the larger tubes can be bought.

FILAMENT CONTROL — It is very important for long tube life that the tubes be operated within 5% of their rated filament voltage. If tubes are operated above manufacturers' plate dissipation rating, it is desirable to have filament voltage 5% to 10% above rated voltage. The Varipower Autoformer permits control of filament voltage at the tube socket to within $2\frac{1}{2}\%$ of any desired value simultaneously with the line voltage and plate voltage control mentioned above. Filament transformers can be connected to supply other than rated voltage . . . an 872 transformer can be used for 866's . . . a 203A transformer can be used for 800's, 6L6's, 83's, or what have you . . .

AMATEURS: The value of the UTC Varipower Autoformer cannot be over-emphasized from the angle of universal application when tube types or operating conditions are changed. As a typical example, let us see what can be obtained from the UTC PA-112 plate transformer:

PA-112 Primary, 105, 115, 220, 230 volts/Sec.
voltage 1250 or 1500 each side—500 MA
net \$21.00

FULL WAVE RECTIFIER — 500 MA D.C.
D.C. output voltages 275, 320, 330, 365, 380,
410, 435, 455, 485, 500, 540, 550, 595, 640,
650, 685, 705, 730, 760, 775, 815, 820, 860,
870, 910, 920, 960, 970, 1000, 1020, 1100,
1140, 1150, 1250, 1300, 1360

BRIDGE RECTIFIER — 300 MA D.C.
D.C. output voltages 100 to 1000 volts in
approximately 80 volt steps, then 1100, 1190,
1280, 1300, 1370, 1410, 1460, 1520, 1550,
1630, 1640, 1720, 1740, 1820, 1840, 1920,
1940, 2000, 2040, 2100, 2160, 2200, 2280,
2300, 2380, 2500, 2600, 2720

Using a **DUPLEX RECTIFIER**
In addition to the voltage obtainable from the
bridge portion, half that voltage can be ob-
tained simultaneously from the full wave section.

UTC VARIPOWER AUTOFORMERS

Net to hams

VA-1	150 watt output rating	\$3.60
VA-2	250 watt output rating	4.50
VA-3	500 watt output rating	6.00
VA-4	1000 watt output rating	9.00
VA-5	2000 watt output rating	12.00

See your distributor for data sheet VA-10 showing circuits on Varipower application for line voltage regulation, automatic line voltage regulation, power and voltage control and modification of regular transformers for universal application

UNITED TRANSFORMER CORP.

72 SPRING STREET

NEW YORK, N. Y.

EXPORT DIVISION: 100 VARICK STREET NEW YORK, N. Y. CABLES: "ARLAB"

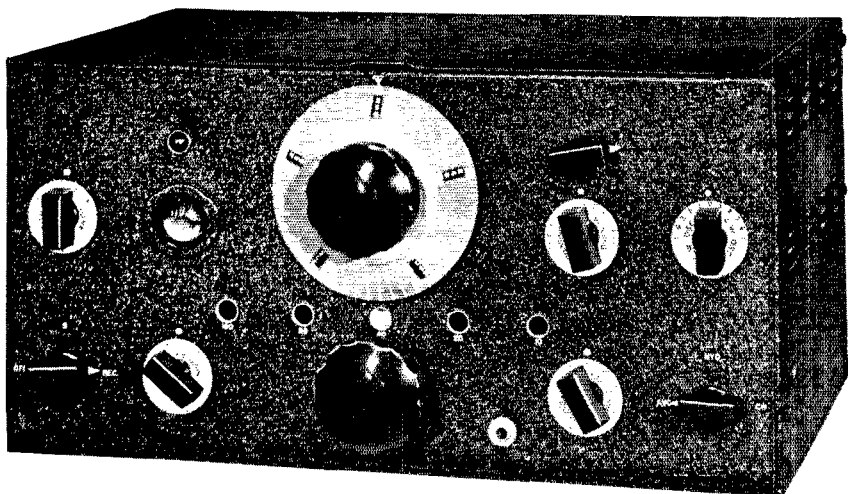

FOR AMATEURS:

The NEW NC-101X

The new NC-101X is strictly an amateur receiver, combining the more popular features of the HRO and the NC-100. Like the HRO it provides extreme electrical bandspread, with each of the amateur bands padded to span a uniform 400 dial divisions. Like the NC-100, it employs the Movable Coil Tuning Unit which makes plug-in coils as rapid and convenient as a coil switch, without sacrifice of electrical efficiency.

The general chassis design is similar to that of the NC-100. Details include variable band width crystal filter*, built-in power supply, CW oscillator, micrometer dial, amplified and delayed AVC, tone control, B-supply switch, AF and RF gain controls and tuning indicator. Coils cover the amateur bands only (10, 20, 40, 80, and 160 meters). Net Price, Type NC-101X Receiver, including power supply, tubes, speaker, and crystal filter*, \$125.00.

* U. S. Patent 2,054,757

Now at your dealers
Battery model now also available

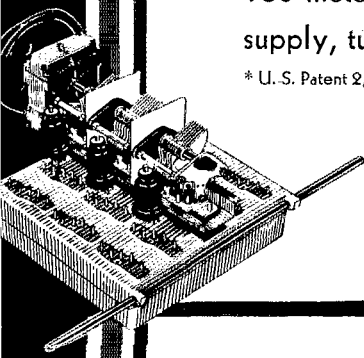

NATIONAL COMPANY, INC., MALDEN, MASS.

ACR-155

A new, moderately-priced, General Purpose Communication Receiver

The ACR-155 answers the need for a moderately-priced communication receiver capable of superior performance under modern operating conditions. Like its predecessor, the ACR-136, it provides a number of features not usually found in receivers of its price class, but a new design makes the ACR-155 an even greater value per dollar than the ACR-136. Outstanding features are tabulated for your convenience.

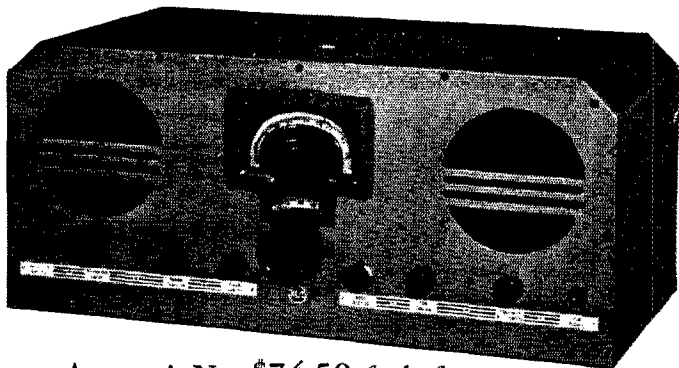

Amateur's Net \$74.50 f.o.b. factory

- 1 Continuous frequency coverage from 520 to 22,000 kilocycles.
- 2 Nine Metal RCA Radiotrons for improved high-frequency performance.
- 3 Improved, large tuning knob with crank handle for smooth, easy tuning.
- 4 Easily read, accurately calibrated selector dial.
- 5 Calibration-spread dial for accurate logging.
- 6 100 to 1 Vernier Tuning Drive.
- 7 Adjustable, air-dielectric r-f trimmer capacitors for greater sensitivity and permanent alignment.
- 8 Magnetite-core i-f transformers for greater sensitivity and permanent alignment.

- 9 Heterodyne oscillator for c-w reception.
 - 10 Headphone or loudspeaker operation.
 - 11 Two-point audio-tone control.
 - 12 Antenna rejection filter reduces interference.
 - 13 Attractive, two-tone, gray-wrinkle finish.
 - 14 Rugged metal cabinet.
 - 15 A. V. C. at will.
 - 16 Six-inch, dustproof electrodynamic speaker for high-quality reproduction.
 - 17 Preselection for better signal to noise ratio, lower image response.
 - 18 Built-in power supply.
- . . .

For further information see your supplier or write for descriptive folder. Complete operating instructions; performance data, and service notes will be sent upon receipt of 25 cents to cover costs of handling and mailing.

RCA presents the Metropolitan Opera every Saturday afternoon.
And "Magic Key of RCA" every Sunday 2 to 3 P. M., E. S. T.
Both on NBC Blue Network.



for Amateur Radio

AMATEUR RADIO SECTION

RCA Manufacturing Co., Inc., Camden, N. J. • A Service of the Radio Corporation of America