

QST

march, 1937
25 cents

devoted entirely to

amateur radio

In this Issue—
**More on
Antenna
Directivity
Band
Switching
Exciter
Design**

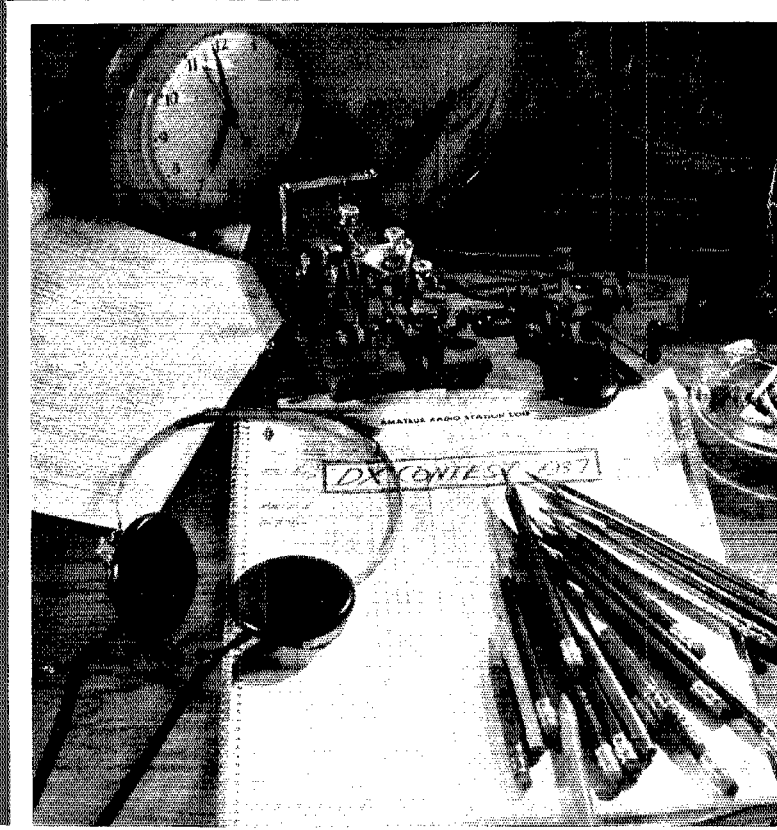

We Shot the Works ---

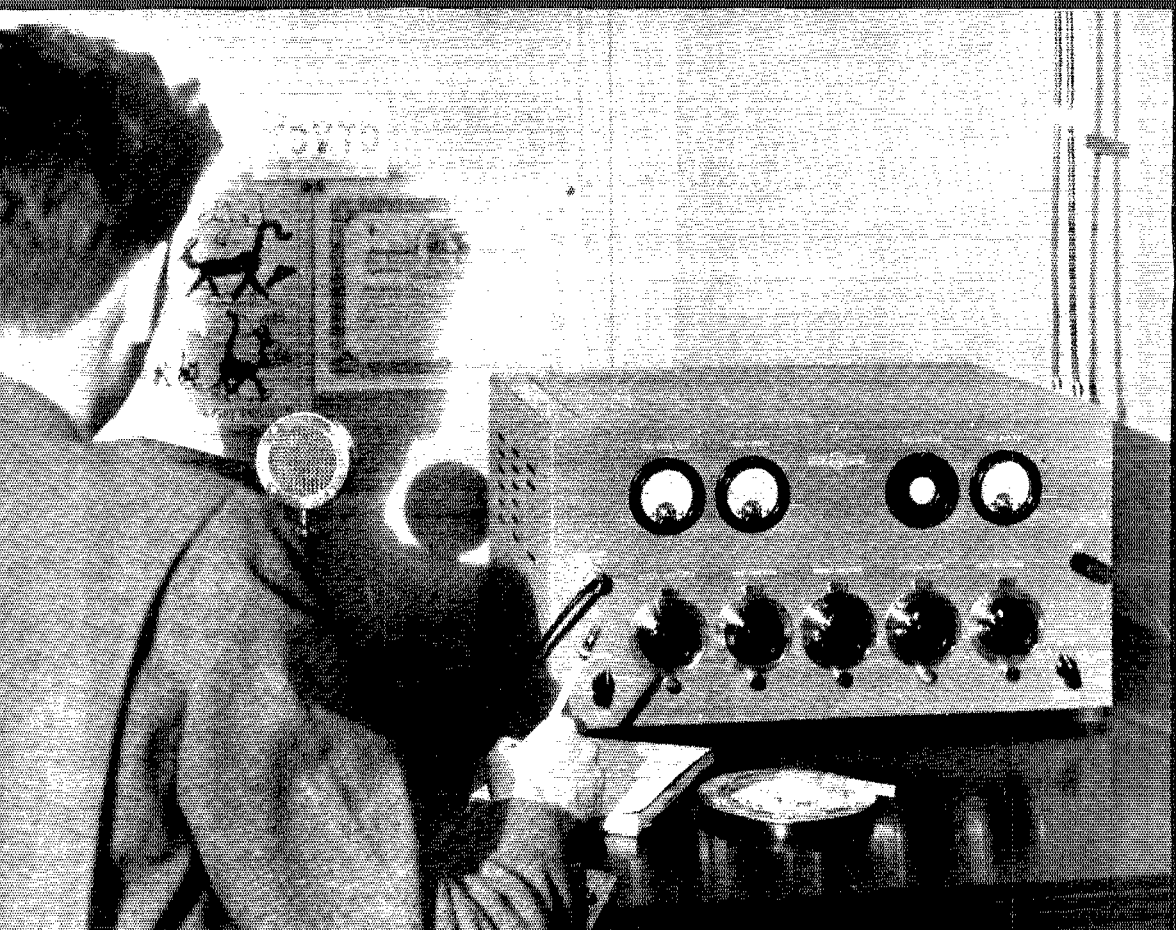

Now 40 Watts Output Phone and CW.

The boys in the laboratory had a lot of good ideas for the 32G. Instead of saving them for special uses we decided to put them all in the new STANDARD MODEL. Increased power output is just one accomplishment. Others are:—

- UNIVERSAL OUTPUT for grounded or balanced antenna systems accomplished with a new pi tank circuit.
- CATHODE RAY MODULATION INDICATOR. (The oscilloscope may also be used for experimental purposes.)
- STAGE BY STAGE METERING assuring correct adjustment.
- CONVENIENT SWITCHING with provision for remote control.
- CONVENIENT FREQUENCY CHANGE with new design plug-in units.
- METAL DUCT WIRING and a fully engraved aluminum panel.

The 32G is a general purpose transmitter intended for many uses on frequencies up to 40 Mc. The tube complement is: 1—C100A oscillator; 2—6L6 doubler stages; 2—6L6 final amplifiers; 4—6L6 modulators; 1—6J7 and 1—6C5 speech amplifier stages; 1—5Z3 and 1—83 rectifiers; 1—913 oscilloscope.

The 32G features compactness, low power consumption, efficiency and is very modestly priced.

Collins Radio Company

CEDAR RAPIDS
New York
11 West 42nd St.



IOWA, U. S. A.
Mexico City
Edificio "La Nacional"

Congratulations A.R.R.L.!



Roland Long, W9NLP, who performed outstanding service during the flood, with Ulmer Turner W9UG and Lt. Com. R. G. Mathews, USNR, Central Division Director A R R L.



DG9H, Centralia, Ill., with M. E. Overholt, C.R.M. and Carl Harris, RM2C on the job during the crisis.



NDS, Chicago Naval Reserve Armory Station, with John Nyerek, Larry Lazar and Emmet Jacobsen on duty, handled a huge volume of official communications.

To amateurs everywhere, we extend our congratulations for their splendid work during the recent flood.

To you fell the task of maintaining the vital link of communications when practically all other means were destroyed.

The entire nation knows how unstintingly you gave of your time and skill. In the words of Anning C. Prall, Chairman of the Federal Communications Commission "you were called upon and were not found wanting."

The nation knows, too, where to turn in any future time of stress — the A.R.R.L. stands ready!

For the opportunity to have helped in a small way, the Hallicrafters are grateful!

the hallicrafters inc.

2611 Indiana Ave., Chicago, Ill.

Cable Address: "HALLICRAFT" Chicago

AMERICA'S LEADING MANUFACTURERS OF COMMUNICATIONS RECEIVERS

Say You Saw It in QST — It Identifies You and Helps QST

THE SUPER SKY RIDER

EVERYTHING you need in a COMMUNICATIONS RECEIVER

at an
amazingly
low price



the NEW SKY CHALLENGER ★



\$69.50

The Sky Challenger is a positive inspiration in receiver design, an outstanding achievement in radio engineering. It's packed with value — the equivalent in performance of many receivers at twice its sensationally low price. No amateur who has not operated this amazing new receiver can fully appreciate its remarkable sensitivity and selectivity, its ease and simplicity of tuning.

Don't let its amazingly low price fool you! See it! Operate it! Compare it! Hallicrafters have created an entirely new set of values in this outstanding new receiver.

Mail the coupon today for full details, or better, stop in for a demonstration today.

FEATURES

- 6 Metal — 3 Glass Tubes
- 38 M C to 535 K C in 5 Bands
- 338° Main Tuning Dial
- Electrical Band Spread
- Iron Core I.F. for Improved Selectivity
- Direct Calibration Tuning — No Charts or Tables



THE SKY BUDDY
A Hallicrafters' Engineered Junior Communications Receiver.

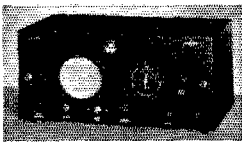

THE SKY CHIEF
An exceptionally fine receiver at a moderate price.



THE SUPER SKY RIDER
America's Most Popular Communications Receiver.

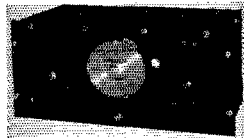

THE ULTRA SKY RIDER
Designed for Ultra High Frequency Reception.

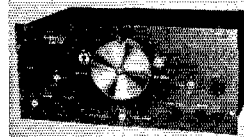

The Sky Rider Commercial
A "Professional" Type Communications Receiver.

All these receivers are now available on exceptionally favorable terms through the NEW HALLICRAFTERS' TIME PAYMENT PLAN.

THE RADIO SHACK

46 Brattle Street, Boston, Mass.

the hallicrafters inc.

QST

devoted entirely to

AMATEUR RADIO

PUBLISHED, MONTHLY, AS ITS OFFICIAL ORGAN, BY THE AMERICAN RADIO RELAY LEAGUE, INC., AT WEST HARTFORD, CONN., U. S. A.; OFFICIAL ORGAN OF THE INTERNATIONAL AMATEUR RADIO UNION

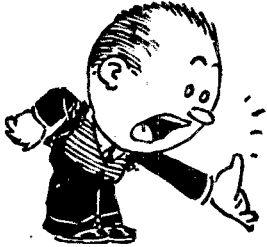

MARCH
1937

Volume XXI
Number 3



Kenneth B. Warner (Secretary, A.R.R.L.), *Editor-in-Chief and Business Manager*; Ross A. Hull, *Associate Editor*; James J. Lamb, *Technical Editor*; George Grammer, *Assistant Technical Editor*; Clark C. Rodimon, *Managing Editor*; David H. Houghton, *Circulation Manager*; F. Cheyney Beekley, *Advertising Manager*; Charles Brunelle, *Assistant Advertising Manager*.

Editorial and Advertising Offices

38 La Salle Road
West Hartford, Connecticut

Subscription rate in United States and Possessions and Canada, \$2.50 per year, postpaid; all other countries, \$5.00 per year, postpaid. Single copies, 25 cents. Foreign remittances should be by international postal or express money order or bank draft negotiable in the U. S. and for an equivalent amount in U. S. funds.

Entered as second-class matter May 29, 1919, at the post office at Hartford, Connecticut, under the Act of March 3, 1879. Acceptance for mailing at special rate of postage provided for in section 1103, Act of October 3, 1917, authorized September 9, 1922. Additional entry at Concord, N. H., authorized February 21, 1929, under the Act of February 28, 1925.

Additional second-class entries to cover sectional editions authorized March 20, 1935. Copyright 1937 by the American Radio Relay League, Inc. Title registered at United States Patent Office.

The Contents

Editorials	13
Flood Relief Communications <i>R. H. G. Mathews, N9ZN</i>	14
A 75-Watt Output Transmitter or Exciter Combining Band-Switching and Plug-In Coils . . . <i>George Grammer</i>	16
Electrostatic Shielding in Transmitter Output Circuits A Symposium	19
Push-Pull and Push-Push Operation Without Complications <i>Clark C. Rodimon, W1SZ</i>	22
How Much C? <i>John L. Reinartz, W1QP</i>	25
More DX Per Dollar. Part II <i>Charles Perrine, Jr., W6CUH</i>	27
What the League Is Doing	32
Dixie Jones' Owl Juice	33
An Earth-Model for Showing Daylight-Darkness Distribution <i>Byron Goodman, W1JPE</i>	34
How Would You Do It? Announcing the Third Problem	35
More on the Directivity of Horizontal Antennas <i>George Grammer</i>	38
A 56-Mc. Crystal-Controlled Transmitter With 6L6 Output <i>C. Harold Campbell, W2IP</i>	41
Strays	42
Navy Day Competition — 1936	43
The 1937 Governors' to President Relay <i>E. M. Williams, W3ER</i>	45
Amateur Radio Stations <i>W5ZA, W9WV</i>	46
Calls Heard	47
Hints and Kinks for the Experimenter Screen Voltage for the 6L6 — Excitation-Controlled Keying Monitor — A Simple Audiometer — B.C. Interference from Code Practice Oscillators — Electronic Mixing for Monitoring — Simple Band-Change Switch	48
I.A.R.U. News	50
Operating News	52
Correspondence Department	61
A.R.R.L. QSL Bureau	112
Standard Frequency Transmissions	118
Silent Keys	122
QST's Index of Advertisers	126

THE SUPER SKY RIDER

The SKY CHALLENGER



★
\$69.50
LESS
SPEAKER

A MODERN AND COMPLETE COMMUNICATIONS RECEIVER AT A SENSATIONALLY LOW PRICE

FEATURES

- 9 Tubes—6 Metal, 3 Glass
- 38 Mc to 535 kc. in 5 Bands
- 338° Main Tuning Dial
- Electrical Band Spread
- Iron Core I. F. for Improved Selectivity
- Direct Calibration Tuning — No Charts or Tables

Here's a receiver that every amateur would be proud to own—with every necessary feature for outstanding performance under all conditions—at a sensationally low price. We consider it a value that cannot be equalled in all amateur radio.

The Sky Challenger provides full coverage from 38 Mc. to 535 kc. including the 10 meter band in 5 Bands providing better L C ratios. It has such features as Electrical Band Spread, Direct Calibration Tuning, Iron Core I. F. Transformers and others found on much higher priced receivers.

See the SKY CHALLENGER in our store! Compare its operation—its performance—its value with other receivers. If you cannot come in—

Write to-day for full particulars

THE SKY CHALLENGER NOW AVAILABLE THROUGH THE NEW HALLICRAFTERS' TIME PAYMENT PLAN FOR AS LITTLE AS \$13.90 DOWN

GROSS RADIO INC.

51 Vesey Street, New York City

the hallicrafters inc.

THE SKY BUDDY THE SKY CHIEF THE ULTRA SKY RIDER

THE SKY RIDER COMMERCIAL THE SKY CHALLENGER

THE SUPER SKY RIDER

THE SKY CHIEF
THE SKY BUDDY
THE SKY RIDER
THE ULTRA SKY RIDER

THE SKY RIDER COMMERCIAL
THE SKY CHALLENGER

CQ—CQ

The SKY CHALLENGER is here!

★
**HALLICRAFTERS'
NEW PRECISION-
ENGINEERED RE-
CEIVER.**

**Greater Sensitivity
Better Selectivity
Amazing Value**

\$69.50

★
FEATURES

- 6 Metal — 3 Glass Tubes
- 40 M C to 535 K C in 5 Bands
- 338° Main Tuning Dial
- Electrical Band Spread
- 2 Iron Core I. F. for Improved Selectivity
- Directly Calibrated — No Charts or Tables
- Built-in Preselector
- Optional Crystal Filter



● We're proud to offer the New Sky Challenger as an outstanding achievement in communications receiver design. Never before have we been able to offer the amateur so much for so little. Just imagine, a receiver with the things you need for efficient short wave reception, with full coverage from 38 M C to 535 K C including the 10 meter band, all on a 5-band, Direct Calibrated, easily tuned dial, with Electrical Band Spread. It has other features you wouldn't expect to find on a receiver at so low a price — Iron Core I. F. Transformers, continuously Variable Tone Control, Nine Tubes, (6 Metal — 3 glass), Single Signal Crystal operation and separate speaker. Stop in at Harvey's — see the new SKY CHALLENGER today or write for complete particulars.

HARVEY RADIO COMPANY

103 WEST 43rd Street, New York City

CABLES: "HARRADIO"

ASK ABOUT THE NEW HALLICRAFTERS' TIME PAYMENT PLAN

the hallicrafters inc.

THE SUPER SKY RIDER

See the
NEW

SKY CHALLENGER



The New SKY CHALLENGER is an outstanding development of the year in amateur radio equipment. We believe that never before has so much ideal value been offered for so little. With marvelous sensitivity and selectivity, — with the necessary controls for precise and accurate tuning, — with Hallicrafters' precision engineering and quality construction throughout — it would still be an amazing value at double its sensationally low price. And now, with the NEW Hallicrafters' Time Payment Plan, you can own and operate the splendid NEW Sky Challenger on terms as low as \$13.90 down and \$5.00 per month. Come into any of the Radio Electric Service Stores and see the SKY CHALLENGER or write for complete information.

\$69.50

- 9 Tubes — 6 metal — 3 glass
- 38 Mc. to 535 kc. (7.9 to 540 meters)
- 5 Band 338° Main Tuning Dial
- Electrical Band Spread
- Iron Core I. F. Transformers for improved selectivity
- Direct Calibration Tuning — No Charts or Tables
- Automatic Volume Control
- Single Signal Crystal Control
- Beat Frequency Oscillator
- New Low Price
- Time Payment Plan

ALL HALLICRAFTERS RECEIVERS NOW AVAILABLE ON NEW MORE FAVORABLE TIME PAYMENTS

RADIO ELECTRIC SERVICE CO.



Corner 7th and Arch St.
Philadelphia, Pa.
5133 Market St.
Philadelphia, Pa.

811 Federal St.
Camden, New Jersey
107 W. 6th St.
Wilmington, Del.

1042 Hamilton St.
Allentown, Pa.
3145 N. Broad St.
North Philadelphia, Pa.

the hallicrafters inc.

THE SKY BUDDY THE SKY CHIEF THE ULTRA SKY RIDER

THE SKY RIDER COMMERCIAL THE SKY CHALLENGER

THE SUPER SKY RIDER

AMATEUR RADIO'S OUTSTANDING VALUE The "SKY CHALLENGER"

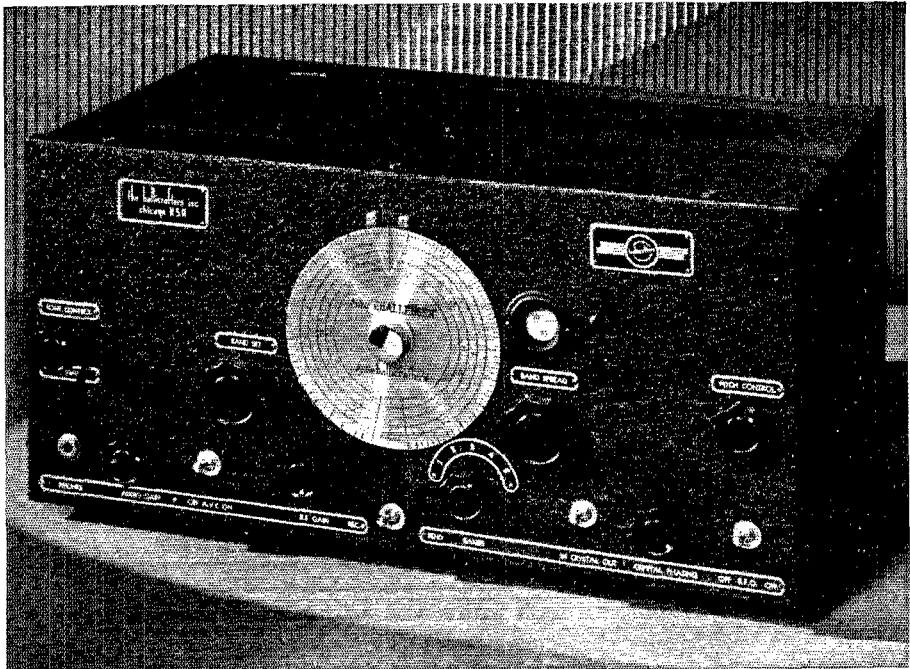

A PRECISION ENGINEERED COMMUNICATIONS RECEIVER
at a sensationally low price **\$69.50**

We predict that the New SKY CHALLENGER will be the most popular receiver in amateur radio. We believe it establishes a new standard of value — sets a new high in performance. We cannot conscientiously do otherwise than recommend it to every amateur.

The SKY CHALLENGER will do the things a fine communications receiver should do, and do it as well or better than many much more expensive receivers. It has all the refinements, and necessary controls for good short wave reception. In sensitivity and selectivity, it is far above the average of most receivers regardless of price.

Hinds and Edgerton specialize in receivers and transmitters and are in a position, as amateurs, to judge amateur equipment. We declare the SKY CHALLENGER Amateur Radio's greatest value! Send the coupon for complete details.

AVAILABLE ON TIME PAYMENTS

All equipment handled by Hinds and Edgerton is available on exceptionally favorable terms. Write for details!

FEATURES

- 9 Tubes, 6 Metal—3 Glass
- 38 M C to 535 K C in 5 Bands
- 338° Main Tuning Dial
- Electrical Band Spread
- Iron Core I. F. for Improved Selectivity
- Direct Calibration Tuning—no Charts or Tables

MAIL THIS COUPON FOR COMPLETE DETAILS

HINDS & EDGARTON

19 South Wells Street, Chicago, Illinois

Established in 1914

Please send me complete information on SKY CHALLENGER.

Name..... Call.....

Address..... City..... State.....

OPERATED BY W9APY and W9WR

the hallicrafters inc.

THE SUPER SKY RIDER

THE ULTRA SKY RIDER

THE SKY RIDER COMMERCIAL

It's Sensational—

The SKY CHALLENGER

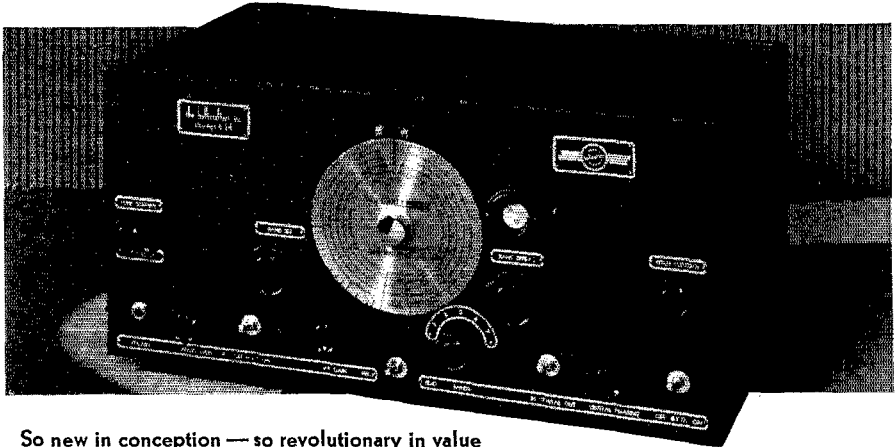

So new in conception — so revolutionary in value — so perfect in performance — the SKY CHALLENGER is amazing. We believe that it is without question the greatest communications receiver value ever offered the radio amateur.

Here's a receiver that has features and controls required for fine accurate tuning, sensitivity and selectivity equal to much more costly receivers — all at a price that makes it possible for every amateur to own one no matter how limited his purse. With the new Hallicrafters' Time Payment Plan it is possible to enjoy the outstanding performance of this new SKY CHALLENGER for as little as \$5.33 per month. Mail the coupon today for complete details.

\$69.50

Only \$13.90 DOWN
\$5.33 per MONTH
with the NEW
Hallicrafters'
Time Payment
Plan



Check These Features of This Amazing New Receiver

- 9 Tubes, 6 Metal—3 Glass.
- 38 M C to 535 K C (7.9 to 540 meters)
- 5 Band 338° Main Tuning Dial
- Electrical Band Spread
- Iron Core I. F. Transformers for Improved Selectivity
- Direct Calibration Tuning—No Charts or Tables
- Automatic Volume Control
- Single Signal Crystal Control
- Beat Frequency Oscillator
- New Low Price
- Time Payment Plan

MAIL THIS COUPON

LEW BONN COMPANY

1126 HARMON PLACE

MINNEAPOLIS, MINN.

Please rush me complete information on NEW SKY CHALLENGER

NAME.....CALL.....

ADDRESS.....

CITY.....STATE.....

the hallicrafters inc.

THE SKY BUDDY

THE SKY CHALLENGER

CHALLENGER THE SUPER SKY RIDER THE ULTRA SKY

THE SKY BUDDY THE SKY CHIEF

RIDER THE SKY RIDER COMMERCIAL

Come in and listen to the NEW HALLICRAFTERS

RECEIVERS

We have them all in stock

See the new **SKY CHALLENGER**
AT A NEW LOW PRICE



the hallicrafters inc.

THE SUPER SKY RIDER

THE SKY BUDDY THE SKY CHIEF THE SKY RIDER COMMERCIAL THE SKY CHALLENGER

Let us show you
Hallicrafters New

SKY CHALLENGER

"AMATEUR RADIO'S GREATEST VALUE"

\$69.50 It has the things you need for
efficient short wave reception
at this sensationally low price.

Available on Hallicrafters New Time Payment Plan
for as little as \$5.33 per month.

THURLOW RADIO DISTRIBUTING COMPANY

110 East Cass St.
Tampa, Florida

23 12th St.
Miami, Florida

"Headquarters for Ham Supplies"

the hallicrafters inc.

THE SUPER SKY RIDER

THE SKY BUDDY THE SKY CHIEF THE SKY RIDER COMMERCIAL THE SKY CHALLENGER

An Instant Hit!

The SKY CHALLENGER

• Hallicrafters Newest
Communications Receiver
at a NEW LOW PRICE

★
\$69.50

★
TIME PAYMENT
TERMS AS LOW
as \$5.33 Per Mo.

- 9 Tubes — 6 metal — 3 glass
- 38 M C to 535 K C (7.9 to 540 meters)
- 5 Band 335° Main Tuning Dial
- Electrical Band Spread
- Iron Core I. F. Transformers for improved selectivity
- Direct Calibration Tuning — No Charts or Tables
- Automatic Volume Control
- Single Signal Crystal Control

SPECIALTY DISTRIBUTING COMPANY

(Wholesale Only)

601 SPRING STREET N W
ATLANTA, GEORGIA

"We do not compete with our customers"

the hallicrafters inc.

THE SUPER SKY RIDER

AMATEUR RADIO'S BIGGEST HIT



\$69.50

We have the NEW SKY CHALLENGER

It's new in performance, in value! We believe that amateur radio has never before been offered so much at such a sensationally low price! Here's a nine tube superheterodyne with 5-Band coverage of all active amateur frequencies including the 10 meter band—with Electrical Band Spread, Direct Calibration Tuning, Iron Core I. F. Transformers, and other features usually found only on receivers at twice the price.

See the Sky Challenger, compare it with others, you'll be convinced that it's amateur radio's greatest value!

TIME PAYMENTS

ENJOY THE SUPERLATIVE PERFORMANCE OF THE NEW SKY CHALLENGER FOR AS LITTLE AS \$5.33 PER MONTH

FEATURES

- 9 Tubes, 6 Metal—3 Glass
- 40 M C to 535 K C in 5 Bands
- 338° Main Tuning Dial
- Electrical Band Spread
- Iron Core I. F. for Improved Selectivity
- Direct Calibration Tuning—No Charts or Tables

MAIL THE COUPON TODAY!

E. J. TYDINGS CO.
114 Ninth Street, Pittsburgh, Pa.

Please rush me complete details of NEW SKY CHALLENGER.

Name

Address

City.....State.....

the hallicrafters inc.

THE SUPER SKY RIDER

The SKY CHALLENGER



Hallicrafters NEW Precision Engineered Communications Receiver

\$69.50

See this sensational new receiver! It's got the things you need for efficient short wave reception from 7.9 to 540 meters without skips, 5 Band Dial, Electrical Band Spread, Iron Core I. F. for better selectivity, Direct Calibration Tuning, 9 tubes six of them metal, the features ordinarily found only on receivers at twice the price. Write today for complete specifications or stop in to see it. Available on easy terms.

See it at your dealers or write for complete details.

- 38 M C to 535 K C in 5 Bands (No skips)
- 338° Main Tuning Dial
- Iron Core I. F. Transformers
- Nine Tubes
- Direct Calibration Tuning—No charts or tables
- Electrical Band Spread

W. H. EDWARDS CO.
32 Broadway
PROVIDENCE, RHODE ISLAND

the hallicrafters inc.

THE SUPER SKY RIDER

Ask your Dealer About the NEW

HALLICRAFTERS TIME PAYMENT PLAN!

- Lower Down Payments!
- Lower Monthly Payments!
- More Favorable Terms!

Following Terms Available
on SKY CHALLENGER

	Down Payment	Monthly Payments
4 Months Plan	\$17.38	\$14.07
6 Months Plan	17.38	9.61
10 Months Plan	13.90	6.26
12 Months Plan	13.90	5.33

Equally Favorable Terms
on all
HALLICRAFTERS RECEIVERS

the hallicrafters inc.

Section Communications Managers of the A.R.R.L. Communications Department

All appointments in the League's field organization are made by the proper S.C.M., elected by members in each Section listed. Mail your S.C.M. (on the 16th of each month) a postal covering your radio activities for the previous 30 days. Tell him your DX, plans for experimenting, results in phone and traffic. He is interested, whether you are an A.R.R.L. member or get your QST at the newsstands; he wants a report from every active ham. If interested and qualified for O.R.S., O.P.S. or other appointments he can tell you about them, too.

Eastern Pennsylvania Maryland-Delaware-District of Columbia Southern New Jersey Western New York Western Pennsylvania	W3EZ W3BAK W3ZX W8DSS W8OFO	ATLANTIC DIVISION James M. Bruning Edgar L. Hudson Carroll D. Kentner Charles Smith Kendall Speer, Jr.	339 W. Lancaster Ave. 1107 Park Ave. 310 E. Walnut St.	Haverford Laurel, Delaware Collingswood Oneida Lower
Illinois Indiana Kentucky Michigan Ohio Wisconsin	W9KTY W9TPE W9AJH W8DPE W8AQ W9ATO	CENTRAL DIVISION L. John Huntoon Arthur L. Braun G. W. Mossbarger Harold C. Bird E. H. Gibbs E. A. Cary	327 Brandon Ave. 530 East Morris St. Box 177 R.F.D. 2 300 High St. 3922 No. 19th Pl.	Glen Ellyn Indianapolis Camp Taylor Pontiac Wadsworth Milwaukee
North Dakota South Dakota Northern Minnesota Southern Minnesota	W9OEL W9SEB W9OWU W9DCM	DAKOTA DIVISION Hartwell B. Burner Andrew L. Kjar Leonard Hofstad Webster F. Soules	224 West Prospect Ave. 3549 36th Ave., So.	Hope New Orleans Elbow Lake Minneapolis
Arkansas Louisiana Mississippi Tennessee	W5ABI W5DKR W5CWO W4DEP	DELTA DIVISION H. E. Veite Eugene H. Treadaway J. H. Weems, Jr. B. G. Lowrey Smith	4415 West 12th St. 2749 Myrtle St. P. O. Box 244 673 Hillcrest St.	Little Rock New Orleans State College Memphis
Eastern New York N. Y. C. & Long Island Northern New Jersey	W2LU W2AZV W2GMN	HUDSON DIVISION Robert E. Haight E. L. Baunach Fred C. Read	511 South Holmes St. 102 Central Ave. 1014 North Ave.	Scotia Massapequa, L. I. Elizabeth
Iowa Kansas Missouri Nebraska	W9NNM W9PB W9CJR W9FAM	MIDWEST DIVISION Owen Williams Harry E. Leuder J. Dewey Mills Samuel C. Wallace	108 No. Johnson St. 304 Miami St. Box 205 Green St.	Iowa City Hawthorn Mount Vernon Clarks
Connecticut Maine Eastern Massachusetts Western Massachusetts New Hampshire Rhode Island Vermont	W1CTI W1CDX W1ABG W1JAH W1BFT W1HRC W1GNF	NEW ENGLAND DIVISION Frederick Ellis, Jr. John W. Singleton Albert N. Giddis William J. Barrett Carl E. Evans Clayton G. Gordon Alvin H. Battison	19 Merrill Rd. 73 Allen St. 128 Crawford St. 239 Columbia St. 80 No. State St. 192 Washington Ave. 1 Central St.	Norwalk Wilton Lowell Adams Concord Providence Windsor
Alaska Idaho Montana Oregon Washington	K7PQ W7NH W7CRH W7AIV W7WV	NORTHWESTERN DIVISION Richard J. Fox Nellie H. Hart Russell U. Richmond Eugene E. Lovejoy Robert H. Votaw	Box 301 Box 6 5013 N. E. Clackamas Route 1, Box 398	Ketchikan Pierre Tim Falls Somers Portland Vancouver
Hawaii Nevada Santa Clara Valley East Bay San Francisco Sacramento Valley Philippines San Joaquin Valley	K6EWQ W6BIC W6FBW W6TFV W6SG W6DVE KA1GR W6LPE	PACIFIC DIVISION Atlas O. Adams Edward W. Heim Elbert Amarantes Harold J. Burchfield Alan D. Whittaker, Jr. Geo. L. Woodington George L. Rickard Angelo V. Astone	21st Infantry Brigade 509 Claremont St. 475 So. 11th St. 2340 106th Ave. 75 Elfinor Ave. 716 Redwood Ave. Box 849 729 Safford	Schofield Barracks Reno San Jose Oakland Mill Valley North Sacramento Manila Fresno
North Carolina Virginia West Virginia	W4OG W3UVA W8KKG	ROANOKE DIVISION H. S. Carter Charles M. Waff, Jr. Dr. Wm. H. Riheldaffer	P. O. Box 111 P. O. Box 1212	Winston-Salem Univ., Charlottesville Lost Creek
Colorado Utah-Wyoming	W9FA W7COH	ROCKY MOUNTAIN DIVISION Glen Glasscock Townsend J. Rigby	2164 So. Corona St.	Denver Midwest, Wyoming
Alabama Eastern Florida	W4DGS W4ASR	SOUTHEASTERN DIVISION James F. Thompson William C. Shelton	2248 S. Arlington Ave. 556 Westmoreland Drive "Hillcrest", P. O. Box 652	Birmingham Daytona Beach
Western Florida Georgia-So. Carolina-Cuba- Isle-of-Pines-Porto Rico- Virgin Islands	W4MS *W4PM	Edward J. Collins Charles W. Davis	1517 East Brainard St. 2136 NE Boulevard Dr.	Pensacola Atlanta, Ga.
Los Angeles Arizona San Diego	W6GXM W6LVG W6EOP	SOUTHWESTERN DIVISION Don M. Draper C. C. Day Harry A. Ambler	4421 West 63 St. "La Posta Quemada" 4101 Hamilton St.	Los Angeles Vail San Diego
Northern Texas Oklahoma Southern Texas New Mexico	W5BII W5CEZ W5BDI W5CGJ	WEST GULF DIVISION Richard M. Cobb Carter L. Simpson Ammon O. Young Joseph M. Eldott	Box 185 2010 So. 4th St. 4803 Eli St.	Dodd City Ponca City Houston Chamita
Maritime	VE1DQ	MARITIME DIVISION A. M. Crowell	69 Dublin St.	Halifax, N. S.
Ontario	VE3SG	ONTARIO DIVISION Fred H. B. Saxon	302 Lee Ave.	Toronto, Ont.
Quebec	VE2EE	QUEBEC DIVISION Stan Comach	780 Brault Ave.	Verdun, P. Q.
Alberta British Columbia	VE4LX VE5EP	VANALTA DIVISION Alfred D. Kettenbach D. R. Vaughan-Smith	1221 Burnaby St.	Rockyford Vancouver
Manitoba Saskatchewan	VE4BG VE4EL	PRAIRIE DIVISION A. J. R. Simpson Wilfred Skaife	635 Garfield St. 2040 McTavish St.	Winnipeg Regina

* Officials appointed to act until the membership of the Section choose permanent S.C.M.'s by nomination and election.

The American Radio Relay League



• **T**HE AMERICAN RADIO RELAY LEAGUE, INC., is a non-commercial association of radio amateurs, bonded for the promotion of interest in amateur radio communication and experimentation, for the relaying of messages by radio, for the advancement of the radio art and of the public welfare, for the representation of the radio amateur in legislative matters, and for the maintenance of fraternalism and a high standard of conduct.

It is an incorporated association without capital stock, chartered under the laws of Connecticut. Its affairs are governed by a Board of Directors, elected every two years by the general membership. The officers are elected or appointed by the Directors. The League is non-commercial and no one commercially engaged in the manufacture, sale or rental of radio apparatus is eligible to membership on its board.

"Of, by and for the amateur," it numbers within its ranks practically every worth-while amateur in the nation and has a history of glorious achievement as the standard-bearer in amateur affairs.

Inquiries regarding membership are solicited. A bona fide interest in amateur radio is the only essential qualification; ownership of a transmitting station and knowledge of the code are not prerequisite. Correspondence should be addressed to the Secretary.

HIRAM PERCY MAXIM, FOUNDER

OFFICERS

President.....EUGENE C. WOODRUFF, W8CMP
State College, Pa.

Vice-President.....GEORGE W. BAILEY, W1KH
Weston, Mass.

Secretary.....KENNETH B. WARNER, W1EH
West Hartford, Connecticut

Treasurer.....ARTHUR A. HEBERT, W1ES
West Hartford, Connecticut

Communications Mgr....F. EDWARD HANDY, W1BDI
West Hartford, Connecticut

General Counsel.....PAUL M. SEGAL
1010 Shoreham Building, Washington, D. C.

Address all general correspondence to the administrative headquarters at West Hartford, Connecticut

DIRECTORS

President
EUGENE C. WOODRUFF.....W8CMP
234 W. Fairmount Ave., State College, Pa.

Vice-President
GEORGE W. BAILEY.....W1KH
74 Webster Road, Weston, Mass.

Canadian General Manager
ALEX REID.....VE2BE
169 Logan Ave., St. Lambert, P. Q.

Atlantic Division
WALTER BRADLEY MARTIN.....W3QV
Box 612, Roslyn, Pa.

Central Division
R. H. G. MATHEWS.....W9ZN
100 East Ohio St., Chicago

Dakota Division
CARL L. JABS.....W9BVB
1822 James St., St. Paul, Minn.

Delta Division
E. RAY ARLEDGE.....W5SI
P. O. Box 286, Pine Bluff, Ark.

Hudson Division
KENNETH T. HILL.....W2AHC
115 Willow St., Douglaston, L. I., N. Y.

Midwest Division
FLOYD E. NORWINE, JR.....W9EFC
120 South Fourth St., St. Louis, Mo.

New England Division
PERCY C. NOBLE.....W1BVR
37 Broad St., Westfield, Mass.

Northwestern Division
RALPH J. GIBBONS.....W7KV
c/o United Air Lines, Pendleton, Ore.

Pacific Division
S. G. CULVER.....W6AN
2962 Russell St., Berkeley, Calif.

Roanoke Division
H. L. CAVENESS.....W4DW
State College Station, Raleigh, N. C.

Rocky Mountain Division
EDWARD C. STOCKMAN.....W9ESA
618 So. Williams St., Denver

Southeastern Division
BENNETT R. ADAMS, JR.....W4APU
1512 Grove Place, Homewood, Ala.

Southwestern Division
CHARLES E. BLALACK.....W6GG
443 Main St., El Centro, Calif.

West Gulf Division
WAYLAND M. GROVES.....W5NW
Box 118, Falco, Texas



THE EDITOR'S MILL

AS THIS issue of *QST* began to take shape, we determined that we would write an editorial on preparedness for QRR work. Before we had had time to put a word on paper, a Grade-A emergency was upon us. In the days since then, the institution of American amateur radio has once again written communications history. When the tale of those awful weeks of flood is all told, it will bulk large with the services of A.R.R.L. members to community and nation.

For a thousand miles through A.R.R.L.'s largest division, the mighty Ohio has been bringing hell and high water to innumerable centers of population and a vast rural area. Where it will end nobody knows. We claim to know something of what this means; we ought to, as we have participated in several similar affairs. Our home town, until we came to A.R.R.L. headquarters, was Cairo, the brave little city whose courageous fight has made headlines these many days. We have a very keen appreciation, then, of what these communities are suffering, of the handicaps under which amateur radio has served, and of the value of that service. As we write we do not actually know many details of that performance beyond what any amateur can know by listening and helping from a distance. But that is quite sufficient to show that ham radio is writing another glorious chapter in its book of accomplishment.

At this writing the Federal Communications Commission has piped down our two lowest-frequency bands for all but emergency and relief communication and has asked our League to spread that word and monitor the bands by stations of its own selection. This action was taken to assist us amateurs in work that no one else could do. Wires have remained up to major cities but the Red Cross informs us that there are literally hundreds of smaller places cut off from all other forms of communication, their only hope of succor and relief depending upon the enterprise and ability of a local amateur to get on the air. Under these circumstances we all must agree that there is no place for other kinds of operating in these two bands until the emergency passes. The ban will be lifted as quickly as practicable. Meanwhile the weak signals of emergency transmitters will have a chance, and relief traffic will have precedence over other activity.

The causes of this flood should be of particular interest to radio amateurs. It seems related to solar radiation and the disturbances now occurring on the sun, and the profound effect that those activities have on terrestrial weather and on radio transmission conditions. The Dellinger Effect is cousin to the cock-eyed weather our continent has had all winter; the unusual radio conditions and California's winter are both, we think, manifestations of our position on the curve of solar activity. "Weather" has not been progressing across the continent in its usual orderly manner. A great mass of moisture-laden tropic air was stalled over our Central Division. Held there while cold polar air ran around and under it, it poured down unbelievable quantities of rain for two weeks on end and could not escape to spread its largesse uniformly. We are no meteorologist but we understand that this flood is to be classed as nothing short of an accident in nature. That will be an interesting thought to amateurs, whose raw material is the solar system and its laws.

We are going to learn some lessons from our communication experience with this flood. Naturally it is much too early to say what those lessons are, but a few points stand forth significantly. We are not well enough prepared with emergency and portable apparatus; too many of us are sunk when the local electric company folds up. We must individually endeavor to do something about that. We can perhaps profit by some advance understandings of the types of traffic that different classes of stations should handle. 'Phone has been performing as valiantly in this emergency as c.w. In some nets, where the exchange of conversational reports is sufficient, it is clearly more satisfactory than c.w. In matters of record communication, involving third-party messages, that cannot be said. In this field the A.A.R.S. and the League's one-spot nets have provided models of near-perfection. One lesson all of us can derive: it takes practice to be able to handle traffic. Operators unskilled in this field, both c.w. and 'phone, have made heavy going of it. Our profound admiration has been aroused for the skill of some 'phone men, who usually only "gas" and never handle messages, in now getting over urgent stuff in the most brilliant manner. With never a wasted syllable and with a nice

sense of balance, they have been doing an admirable job. They of course are naturals, born to it. With some others it has been very different and this is equally true of the brass-pounding branch. Unnecessary calling and signing, with a bitter loss of time and a more bitter increase of interference, has been the chief characteristic of both c.w. and 'phone inexperience in message handling; screwy preambles or no preambles at all have been another most noticeable one. These things

of course come chiefly from the application of DX tactics to emergency work, rather than the practices of the one-spot nets. Nobody can criticize these amateurs who are doing their best to help; certainly we do not, for they are our own fellows. But there is a moral: This flood is showing, as nothing else could, how important it is for every amateur to know how to handle messages skillfully. It is the keystone of our ability to serve when disaster strikes. K. B. W.

Flood Relief Communications

By R. H. G. Mathews *

LET me preface this article by stating very frankly that this is by no means a complete report of the part radio communications played in the flood disaster. At this time many stations who did excellent work have not been heard from with detailed reports. It is impossible here to give a complete story at this time. Most of the things which are lacking, however, are details. The main facts are quite obvious, and especially so to one who was privileged to observe the thing from just sufficient distance to give perspective.

The Ohio River Valley flood has written a composite picture. It is one of scintillating brilliance in so far as certain amateur radio performances are concerned and one of pitiful futility in so far as civilian radio in general is concerned. If nothing else, it has taught all of us a lesson which the conclusions of this article will endeavor to show.

In a disaster of this sort, it is naturally the desire of all of us to help in every way possible, and it is also a great American trait at least to not avoid any publicity which may accrue from such efforts. When the flood hit the now devastated areas, a confusion hit radio communication the like of which has never been seen before. Broadcasting stations with no experience in organizing communication networks endeavored to assume charge, and in some cases did yeoman service in the saving of lives and property. In other cases these broadcasting stations assumed authority which was in no way theirs, and attempted to direct the operations of amateur and Naval Reserve communications which they were utterly incapable of directing. Conflicts sometimes arose between the various governmental and state agencies in so far as communications were concerned. In still other cases certain broadcasting chains put the stations of amateurs con-

nected with their organizations on the air and created tremendous confusion in an effort to establish 'phone communications which could be rebroadcast over the chains, apparently not realizing the interference which these arrangements caused with legitimate relief traffic.

Despite all these handicaps, however, amateur radio lived up to its usual traditions; both 'phone and c.w. stations turned to, and with a complete disregard of time, sleep, or money manned their stations on twenty-four hour schedules and cleared thousands of legitimate messages, ordering supplies, directing their shipment, distributing refugees, and, in general, taking care of the communication needs of the duly-appointed agencies of relief.

Although it is impossible at this time to give a complete list of the amateur stations which performed this duty so faithfully, mention of a few of them is possible. W8YX and NEG of Cincinnati handled the bulk of traffic from that city during the emergency, and did a beautiful job. Many stations in Chicago did their best to establish communication with the flooded sections. Probably the most outstanding amateur station in this area in the point of amount of important traffic handled is W9NLP, Rowland Long, whose 'phone station never left the air for a period of over a week. Others who assisted in maintaining this contact were W9AIO, W9UG, W9PSP, W9ETI, W9WC, W9CRS, although the efforts of the latter two stations were somewhat handicapped by their connections with one of the broadcasting chains. In Louisville, W9ELL, the Naval Reserve unit station, did a tremendous job until his power was cut off. On receipt of word of this fact, Ulmer Turner, Chicago *Herald & Examiner* radio editor, arranged for shipment of a gas-engine-driven generator by airplane to Louisville to enable W9ELL to go back on the air. In Harrisburg, Ill., W9HQD maintained a steady watch, as did W9CHN, Shelbyville,

* Lt. Comdr., C-V(S), U.S.N.R., Central Division Director, N9ZN, Chicago.

W9IXN, W8DL and W4DLK, whose land-wire connection to WMC and WSM carried many messages over metallic circuits to WHAS, Louisville. W4DLK constantly monitored W9NLP and gave a continuous record of all the traffic over land wire to WSM, who in turn passed it to WHAS for local delivery in Louisville. Other stations active in handling traffic out of Louisville were W9AZY, W9KBR, W9FQQ, W9EDQ at Ludlow, W9BOF at Winchester, Ky., W9CDA at Danville, Ky., N9PYZ at Denver, Colo., W9LWE at Shelbyville, Ind., W9CIC at Jefferson Barracks, Mo., and many others.

The amateur Naval Reserve circuits functioned particularly well. Organized as they are for just such emergencies, these stations maintained continuous schedules on the special frequencies assigned to them and in cooperation with the stations of the American Airlines handled tremendous amounts of traffic. Chief among such stations was NDS in Chicago, the Ninth Naval District control station, which maintained a 24-hour watch under command of Ensign Sigtenhorst; N8NC and N8CCT in Cincinnati; N9AUH in Louisville; N9ELL; N8ZAE at Pittsburgh, N8AAO (NDE) at Wheeling, N8BAH at Cleveland, and N8WV, N8GKG, N8HZI, N8EEZ, N8INX, N8KIW, N8IAG, all operating on 3600 kilocycles. On 3555 kcs., N8CCT, N8NC, N8EJ, N8PO, N8BAH alternate control station for NID at Akron, although not in the flooded area, provided a contact for Naval Reserve amateur stations in this area. The Centralia (Illinois) unit of the Naval Communication Reserve put eight good Naval Reserve hams on portable outfits and voluntarily sent them into the Southern Illinois flooded area where they moved about, using Naval

Reserve tactical calls and maintaining contact between the Naval Reserve, Coast Guard, and other government agencies. Although without orders to active duty or any hope of remuneration



W9NLP ON THE AIR A SOLID WEEK

Rowland Long, W9NLP contacting flooded Louisville; Lt. Cmdr. R. H. G. Mathews, N9ZN standing by; Ulmer Turner, W9UG, radio editor Chicago Herald & Examiner takes messages over the phone.

or even recovery of their expenses, the entire personnel of this unit turned out to a man. Operating their own transmitters, they loaded them on trucks at their own expense and distributed themselves in the Illinois flood area at Harrisburg, Shawneetown, Eldorado and Ridgeway, standing watch without sleep and many times without food, and maintaining contact with the unit headquarters station at Centralia. They are very proud of the fact that traffic between the various city officials was delivered 100%. Recognition has been given this group of amateurs by their local mayors and city councils.

The amateur stations and particularly those of

(Continued on page 84)

Next Month—

The Entire Flood Story in Detail

A GAIN an Act of God and QST's publication schedule collide. As this issue of QST is being "put to bed" the Ohio River flood is just receding, the Mississippi crisis still approaching. Obviously, the entire story of the herculean task of emergency communications work performed by amateurs in the flooded regions cannot at this time be given.

But from his vantage point in Chicago, as Lieutenant-Commander in the N.C.R., A.R.R.L.'s Central Division Director, R. H. G. Mathews, W9ZN, has pounded out a last-minute survey of the work already done and the situation as it now stands. Necessarily, only a fraction of the amateur work is recounted, only a few of the active stations listed. But it does serve to convey a suggestion of the amateur participation in the greatest national emergency since the World War—a picture in which the details can be drawn next month.

As we go to press a member of the QST staff is en route to the flooded region, intent on gleaming as much of the story as possible. This detailed report will appear in April QST. Meanwhile, every amateur who participated in the flood emergency work in any degree at all is urged to send in a full report immediately—by March 1st at the very latest. Remember—not only you but amateur radio gets the credit!

Read April QST!

A 75-Watt Output Transmitter or Exciter Combining Band-Switching and Plug-in Coils

By George Grammer*

BAND-SWITCHING should not be confused with quick frequency changing, because changing frequencies with a band-switching transmitter is not inherently a rapid process. Essentially, band-switching is a device intended only to do away with the bother of plugging in coils when going from one band to another; it does not involve automatic retuning of circuits to a desired frequency. However, it is a none-the-less desirable addition to any transmitter, because any inconvenience eliminated is so much operating profit. Band-switching is especially appreciated in the exciter stages of a multi-stage transmitter, because, while plugging in a final coil or so perhaps isn't so bad, if four or five coils have to be changed one is likely to think twice before deciding that there really are greener fields on some other band.

On the other hand, band-switching usually has an air of finality about it which does not appeal to those for whom the flexibility of the plug-in coil system is an attraction. It therefore seemed to us that it might be desirable to combine the two systems, thereby providing both convenience and flexibility. This has been done in the unit pictured here—with a rig in which the 3.5-, 7- and 14-Mc. bands can be covered with one set of coils and switching. All the coils, however, are plug-in, and could easily be replaced by sets designed to cover any adjacent three of the usual communication bands. Although primarily intended as an exciter for a high-power stage, it is also a useful transmitter in itself, since the power output is in the vicinity of 75 or 80 watts with a suitable plate supply for the final tube. The various band-changing switches are ganged together so that a twist of one knob is all that is necessary to shift from one band to another. Four crystals are provided, with a switch to select the frequency

desired. In addition, the oscillator readily can be converted from crystal to electron-coupled so that frequencies other than those furnished by the crystal can be used. The whole unit is quite compact and so proportioned that it fits a standard relay rack.

CIRCUIT DETAILS

The complete diagram is given in Fig. 1. Without the switching complications, the circuit is a simple one. An 89 Tri-tet oscillator is capacity-coupled to an RK-25 buffer-doubler, in turn capacity coupled to an RK-20. The use of screen-grid tubes is almost obligatory in a band-switching rig if the switching system is to be as simple as possible. With them, single-ended tank circuits can be used throughout, and a single switch, shorting out sections of the coils for changing inductance, will suffice for each stage. The Tri-tet oscillator is likewise advantageous because of the possibility of successful working either at crystal frequency or doubling, no neutralization being required in either case, and because it is readily convertible into an electron-coupled oscillator.

Three short-circuiting switches are used for band-changing, one to each plate circuit. The wiring is arranged so that the oscillator plate coil gives crystal-frequency output for the two lower frequency bands, and second-harmonic output for the highest frequency. In the actual set-up, 3.5-Mc. crystals are used, since the rig is mostly operated on 80, 40 and 20 meters. To avoid possible oscillation troubles, the second tube is operated as a doubler whenever possible. The final stage, however, is a straight amplifier in all three bands. Shorting is from the low-potential end of the tank coil in every case.

In the oscillator circuit, a five-point switch selects one of four crystals or a fixed condenser, the latter serving as the grid condenser when the

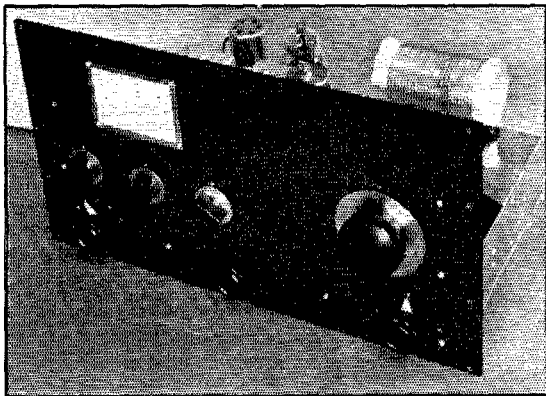

A 75-WATT OUTPUT TRANSMITTER OR EXCITER WITH BAND-SWITCHING, USING PLUG-IN COILS

It is built to fit a standard relay rack, using a 10½ by 19 inch panel.

* Assistant Technical Editor.

89 is used as an electron-coupled oscillator. Since it was not intended that the electron-coupled arrangement be used for routine operation, no provision was made for switching the coils, these (L_1 in the diagram) being plug-in. To give break-in operation, the oscillator cathode is keyed, the key being inserted between ground and the lower end of the cathode tuned circuit. Condenser C_{13} and the r.f. choke are used to keep r.f. from wandering into the keying leads.

Resistors R_3 , R_4 , R_5 , R_6 and R_7 constitute a voltage divider which puts the proper voltages on the various tube electrodes when a 500-volt supply is used for the oscillator and buffer. Screen and suppressor voltages for the RK-20 also are taken from this divider. Under operating conditions, the plate voltage on the 89 is approximately 300 (this is also the RK-25 screen voltage), on the RK-25 screen, 200, on the 89 screen, 100, and on the 89 and RK-20 suppressors, 50. Jacks are provided for measurement of oscillator and buffer plate current.

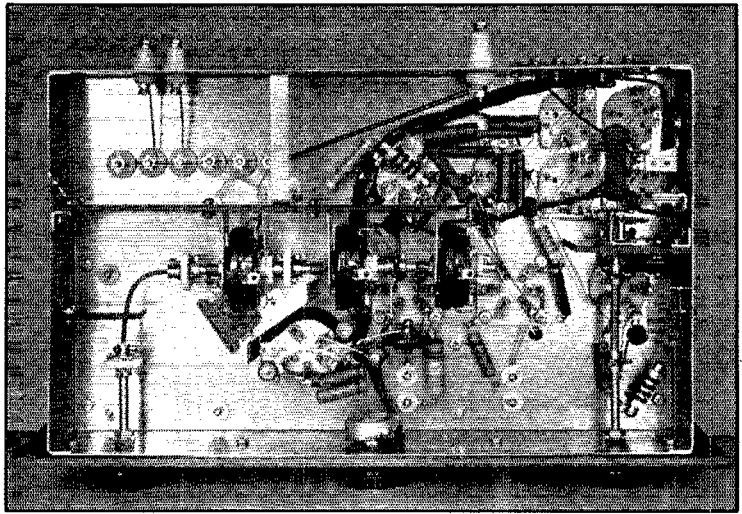

BELOW-CHASSIS WIRING AND LAYOUT

The ganged band-switches and the crystal-selector switch are visible in this photograph.

connected to a prong which is grounded when the assembly is plugged in. Coil forms and sockets having at least five prongs are necessary to take care of the buffer; four will suffice for the oscillator. The final amplifier coil and its coupling link require six contacts for three bands.

It will be noted from the diagram that a single 7.5-volt source handles the filaments of all three tubes. The heater voltage for the 89 and RK-25 is dropped from 7.5 to 6.3 volts by means of R_3 , which should be adjusted, with the aid of a voltmeter, to give the proper voltage.

Since the oscillator is keyed, fixed bias must be used on the buffer and final. This bias is secured from an external source giving about 100 volts. A potentiometer, R_2 , is connected across the bias supply to give variable suppressor voltage for the RK-25. R_2 therefore serves to control the output of the RK-25 and hence the output of the RK-20. This "excitation control" is an extremely useful device, giving smooth reduction of power to any desired value between zero and the maximum output of the transmitter, and permits reducing excitation to a higher-power final stage so that the off-resonance plate current is within reason during the tuning-up process. It should be a tube-saver.

In any band-switching rig, probably more thought needs to be given the physical arrangement of parts than to the electrical circuit itself, if something that is both electrically good and and decent-appearing is to result. The arrange-

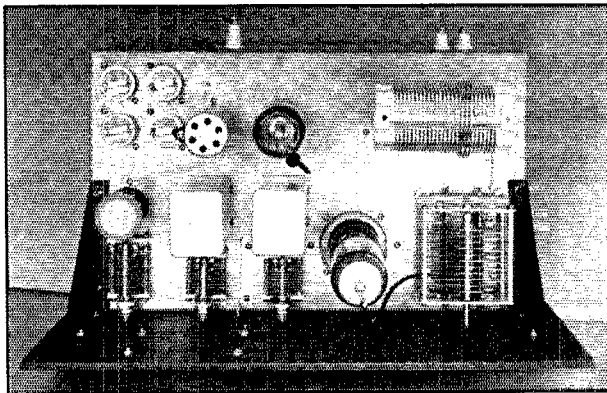

THIS PLAN VIEW OF THE TRANSMITTER SHOWS THE LAYOUT ABOVE THE CHASSIS

The tube line-up is 89 Tri-tet or E. C. oscillator, RK-25 buffer-doubler, and RK-20 amplifier.

In the oscillator and buffer tank circuits, the switch contacts are connected to prongs on the sockets for the plug-in coils. The taps on the coils connect to the appropriate plug-in base prongs. Each coil assembly is shielded, with the shield

ment problem becomes more acute when the switches have to be ganged for single control. Further limitations are imposed when all controls have to be brought to a panel and so dis-

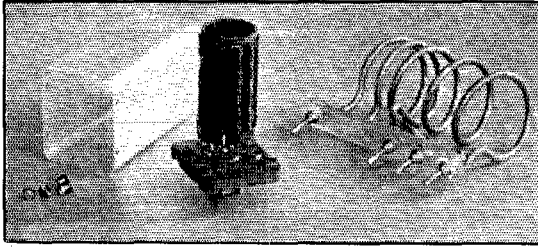

THE BUFFER COIL BEFORE ASSEMBLY

The oscillator plate coil is similarly constructed. The copper-tubing coil at the right is the ten-meter plate tank coil for the RK-20.

posed that the thing looks as though it had been planned to be that way rather than having, like Topsy, "just grown."

How these problems were solved in the present instance is shown by the various photographs. In the panel view, the three knobs along the bottom are, from left to right, the crystal-selector switch, excitation control, and band-

selector switch. The three small dials are, respectively, oscillator cathode condenser, oscillator plate condenser, and buffer plate condenser. The large dial, of course, is the amplifier plate tuning control. The chart frame gives the various dial settings for different frequencies in the various bands so that laborious step-by-step tuning is not necessary when the frequency is changed.

The top-of-chassis layout can be seen in the top-view photograph. The chassis itself is 10 by 17 by 3 inches, made of Electralloy. The oscillator cathode-tuning condenser, C_1 , is at the left front; beside it is the oscillator plate condenser, C_2 , and next, on the other side of the small baffle shield, the buffer plate condenser, C_3 . All three of these condensers are insulated from the chassis by means of small isolantite "butt-in" insulators.

The oscillator cathode (or e.e.o.) coil plugs into a five-prong socket just behind C_1 ; oscillator plate coil, L_2 , is behind C_2 , and buffer plate coil, L_3 , is behind C_3 . The last two coils are enclosed in the new National Type PB-10 plug-in base and shield assembly to provide the needed shielding between stages. The four crystal sockets are at the rear left of the chassis, followed, to the

(Continued on page 78)

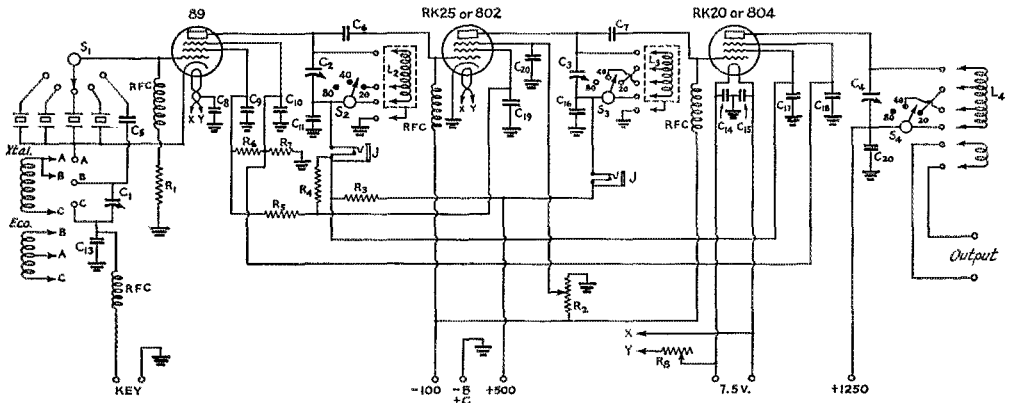

FIG. 1—CIRCUIT DIAGRAM OF THE BAND-SWITCHING TRANSMITTER

- | | | | |
|--|--|--|---|
| C_1 —335- μ fd. condenser, receiving type (National STH-335). | R_1 —50,000 ohms, 1 watt. | E.C.O.: Identical with crystal coil except tapped at 6th turn from ground end. | L_4 —3.5, 7 and 14 Mc.; 29 turns No. 14, diameter 2 1/2 inches, length 3 3/4 inches (National XR-10A form wound full), tapped 15 turns (7 Mc.) and 21 turns (14 Mc.) from ground end. |
| C_2, C_3 —100- μ fd. condensers, receiving type (National ST-100). | R_2 —50,000-ohm potentiometer (Yaxley Y5OMP). | Both coils wound on Hammarlund XP-53 forms, diameter 1 1/2 inches. | Link winding three turns 3 inches in diameter, spaced same as tank coil. |
| C_4 —150- μ fd. transmitting condenser (National TMC-150). | R_3 —3000 ohms, 25 watt. | L_2 —44 turns No. 20 and 1 1/4-inch form, spaced to occupy length of 2 inches; tapped 24 turns from ground end. | 28 Mc.: 4 turns 3/16-inch copper tubing, diameter 2 inches, length 4 inches. Link 1 turn same diameter. |
| C_5, C_6 —100- μ fd. mica condenser, receiving type. | R_4 —1500 ohms, 10 watt. | L_3 —44 turns No. 20 on 1 1/4-inch form, spaced to occupy length of 2 inches; tapped 23 turns (7 Mc.) and 37 turns (14 Mc.) from ground end. | |
| C_7 —250- μ fd. mica condenser, 1000-volt. | R_5 —10,000 ohms, 2 watt. | | |
| C_8 — C_{15} , inc.—.001 paper, 400-volt (Aerovox or Sprague). | R_6 —6000 ohms, 1 watt. | | |
| C_{16} — C_{19} , inc.—.002 paper, 1500-volt (Sprague SW-22). | R_7 —10,000 ohms, 1 watt. | | |
| C_{20} —0.002- μ fd. 2500-volt mica (Aerovox). | R_8 —200-ohm adjustable. | | |
| | RFC—Short-wave chokes, sectional-wound. | | |
| | S_1 —Crystal selector switch (Yaxley 1316L, 5 points used). | | |
| | S_2, S_3, S_4 —Ohmite Type BC-3 transmitting band-switch. | | |
| | L_1 —Crystal: 16 turns No. 20 wire, spaced to occupy winding length of 1 inch. | | |

Electrostatic Shielding in Transmitter Output Circuits

A General Cure for Harmonic and Other Spurious Radiation QRM

A Symposium

RIGHT on the heels of W1EAO's timely article¹ on the harmonic radiation problem in *QST* last month we have two further contributions pointing the practical way to elimination of this affliction and other spurious radiations in one clean sweep. In the two articles which follow, W8ABX and W3EMM describe their findings in the simple application of electrostatic shields between the output tank circuit and the antenna system with inductive coupling. This method is demonstrated to be effective with all types of antenna tuning and feed systems. It requires inductive coupling, of course, and relegates to the junk box direct tapping of the antenna system to the output tank. But that is small sacrifice in apparent convenience for the large gain in operating assurance which is achieved. The ideal type of Faraday shield is described and advocated by W8ABX, while a simpler and somewhat less low-loss type using ordinary copper-wire screen is employed by W3EMM. The first is recommended where a rectangular shield can be placed between coils coupled end-to-end, while the latter is more convenient where a cylindrical shield must be wrapped around one coil coupled to another wound over it. The ends of a cylindrical shield should not overlap or make contact to form a short-circuited turn, however, there should be a small gap. The losses with a split-cylinder shield are relatively small, as we recently learned on a visit to a 50-kw. broadcasting station where a similar-type shield of copper sheet was in use between the final tank circuit and the input coil of the transmission-line feed system. The copper sheet ran barely warm.

* * *

Faraday Shields Cut BCL and Harmonic QRM

By John J. Long, Jr.,* W8ABX

CONSIDERABLE has been written in the past about static shields for cutting down noise in receivers. The use of a static shield with a doublet antenna and a balanced transmission line

inductively coupled to the receiver will prevent stray voltages in the neighborhood of the antenna from getting into the receiver by capacitive coupling. This system works both ways. When a shield is used with inductive coupling on a transmitter, it will prevent unwanted r.f. harmonics, clicks, thumps, and other spurious radiations from getting into the antenna system. Since the purpose of a static shield is to prevent capacitive coupling between two circuits, it should really be called a capacitive shield.

When an antenna and feeder system is properly tuned, it should emit waves only on the frequency

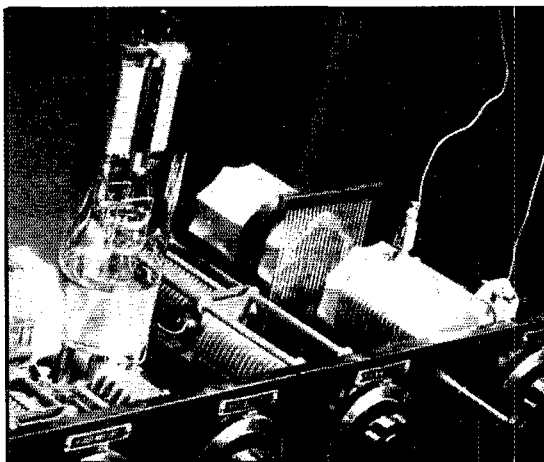

W8ABX FINDS THAT THE FARADAY SHIELD BETWEEN THE TANK COIL AND ANTENNA COIL (AT THE RIGHT) NOT ONLY CLEANS UP HARMONIC RADIATION BUT ALSO ELIMINATES BCL QRM FROM KEY CLICKS AND OTHER SHOCK-EXCITATION EFFECTS

to which it is tuned. Inductive coupling between the output tank circuit and the antenna circuit, will allow us very nearly to approach this condition, *if no capacitive coupling is present*. But there is always capacitive coupling present between two coils which have no grounded shield between them.

* WHAM, Stromberg-Carlson Telephone Mfg. Co., Rochester, N. Y.

** 903 Hanover Ave., Norfolk, Va.

¹ R. W. Woodward, "About This Harmonic Radiation Problem," *QST*, Feb., 1937.

The coupling of an antenna directly to the tank coil with a clip has been the cause of much trouble with the BCL's and it is also a bad offender at putting harmonics out of the amateur bands as well as in the high-frequency amateur bands. A push-pull output stage will suppress even harmonics if perfectly balanced (and there are plenty which are not). It will not suppress odd harmonics. And the odd harmonics fall outside of our bands. Listen sometime around 6000 kc. and 12,000 kc. and check the third harmonics of 160-meter and 75-meter 'phone. Most of this harmonic energy is put into the antenna by conductive or capacitive coupling.

Now for a little explanation on the causes of BCL QRM. Key-click filters and the proper percentage of modulation will do much to cut it down; but when high power is used (anywhere from 200 to 600 watts in the antenna) the thumps from keying and occasional overmodulation on peaks will spill over and cause a type of wave which has been called "shock excitation." Most of this spurious energy can be kept out of the antenna by using an antenna or feeder coupling coil separated from the plate tank coil by

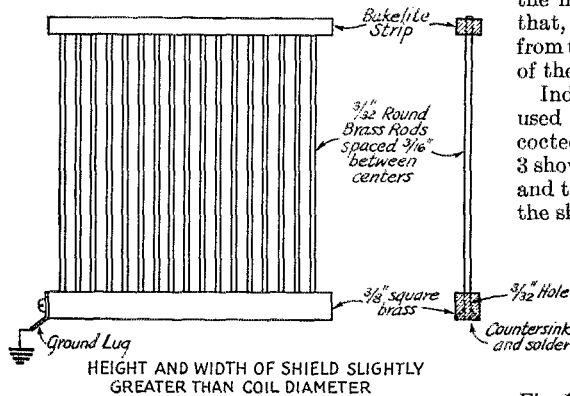

FIG. 1—CONSTRUCTION OF THE FARADAY-TYPE SHIELD USING BRASS OR COPPER RODS

The upper ends of the rods may be fixed to the bakelite strip with Duco cement.

a capacity shield. No matter how sharply a broadcast receiver will tune, if this click or thump type of energy is getting into the antenna it will be impossible to eliminate it. It resembles power-leak and natural static and will come in at any point on the dial. Wave traps and filters will not help. Shocks of this type are usually aperiodic in nature, and will usually excite the whole antenna and feeder system against ground, as the result of either conductive or capacitive coupling to ground via the output tank circuit.

With a static shield installed it has been possible to operate a broadcast receiver at any point on the dial and on weak stations, at a distance of only four feet from a transmitter using 600

watts input. A key click filter was not used because the keying was done in the screen lead of an electron-coupled oscillator which derived its voltage from a resistance voltage divider. There was no inductive or capacitive components in the circuit so no sparking or arcing occurred at the keying relay. The only clicks heard were from the relay battery circuit and these were cleared by putting some resistance in series with the relay coil. But take the static shield out of the transmitter and the clicks come in all over the dial on the broadcast receiver.

The shield also makes it possible to tune the antenna tank circuit without having to retune the output tank circuit appreciably. This is a help when you change frequency often, as it simplifies tuning. Static shields are an aid when working with push-pull stages because only one coupling coil need be used. With capacitive coupling eliminated, a single coil at one end will not throw the two sides of the circuit out of balance. Two shields, one at each end of the tank coil, should be equidistant from the ends of the push-pull coil, however. If only one shield is used (on one end of a push-pull coil) it will be necessary to balance the neutralizing with the shield in place. After that, the coupling coil can be varied in distance from the output coil without changing the balance of the stage.

Inductive coupling and a static shield can be used with any kind of an antenna system concocted by the "Rube Goldbergs of Radio." Fig. 3 shows typical schemes now in use by amateurs, and the method of using inductive coupling with the shields.

SHIELD CONSTRUCTION

Several methods of making a shield will suggest themselves to the amateur. The same types that have been described in *QST* and the *A.R.R.L. Handbook* for receivers will work on the transmitter.

Fig. 1 shows one type, which also is shown in the photograph. Fig. 2 illustrates methods of using plug-in shields with plug-in coils, both single-ended and push-pull. Static shields are composed of parallel pieces of wire or rods connected together at one end only. Be sure not to short circuit the rods of the shield on both ends. If you do, you will have an inductive shield as well. Tie the bottom end of the shield to some grounded point on the transmitter.

Another point that will help cut down interference in some cases, is shown in Fig. 3G. Put a ground tap on some point in the antenna circuit which is at ground potential as far as the r.f. is concerned. This can be checked with an antenna meter. When a point is found that does not show any current flowing to ground, or any appreciable change in the output stage plate current, ground this point permanently. This will allow static charges to leak off and will help cut down noises

in your receiver especially during a wind storm. It is also a nice feeling to know that your antenna is permanently grounded when you are miles from the station and a lightning storm comes up.

* * *

Taking the Harmonic Headache Out of 75-Meter 'Phone

By Fenton Priest,
W3EMM

THE seriousness of harmonic radiation and interference cannot be underestimated. The F.C.C. seems to be cracking down on the boys who have harmonics and especially those that interfere with other services. I have listened quite a bit around 8 Mc. recently and have been surprised to find a "second 75-meter 'phone band," with plenty of S7, 8, 9, and 9 + signals originating with some of the most representative stations on the band.

Up until the past year, I haven't done much operating on 'phone and have been on 75 only once or twice until about two months ago. Since then quite a bit of 75-meter 'phone operating has been done. Well, to make a long story short, the first thing I learned about the 75-meter band was that everybody operating there seemed to be having trouble with 2nd harmonics. I laughed heartily when two of the local 75-meter 'phones received two tickets apiece from the F.C.C. about their 40-meter signals. Just poor adjustment or an unbalanced condition in their push-pull amplifier, so said I! But lo and behold! one day I received a card from W1EAO reporting me S7 in Hartford on my second harmonic! After checking with some eight or ten stations, local and otherwise, I received reports varying from S6 to S9 + on my 2nd harmonic. On top of that I got several complaints from local short-wave listeners of a very strong 3rd harmonic right in the 11- to 12-Mc. band.

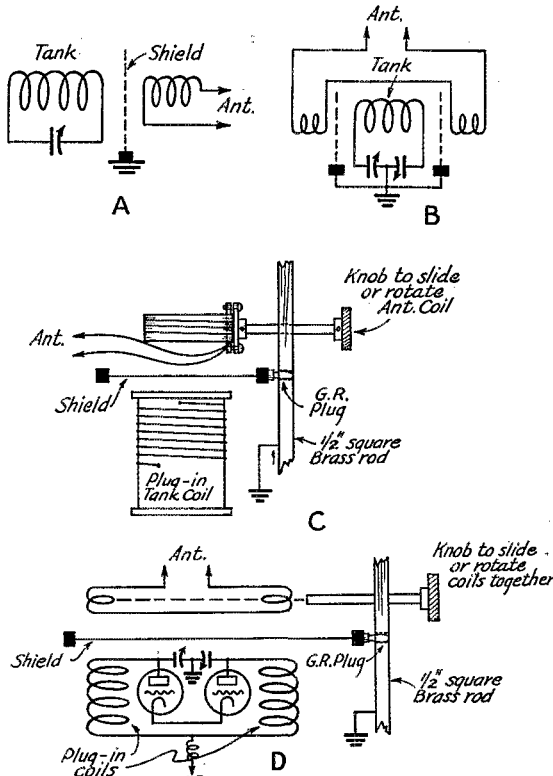

FIG. 2—ARRANGEMENTS FOR USING THE SHIELDS WITH SINGLE-ENDED AND PUSH-PULL CIRCUITS

long with 40-foot feeders in the center and is coupled to the transmitter through a pi-network. The final stage is identical to the one described by C. C. Rodimon in *QST* several months ago, with the exception that several parts are of different manufacture. The final amplifier is absolutely symmetrical, mechanically and electrically, and is in perfect balance as far as can be determined.

Here is what was tried. I cut the bias in half and cut the excitation in half. I tried as much as 125- μ fd. total capacity in the final plate tank circuit. I had any number of pi-network adjustments, a lot of capacity on the antenna side of the coupler, about 250 μ fd. with practically none on the set side, and every adjustment on down to all of the capacity on the set side and none on the antenna side of the network. This was with the coupler clipped right on the plate tank. Every method of coupling my type antenna to the final was tried—several link combinations, several pickup coil combinations and several antenna coil combinations—but no improvement resulted. I lost plenty of sleep and surely was worried about the situation.

(Continued on page 106)

I started to work immediately to eliminate that trouble. Everything was tried; lowered bias and excitation, all sorts of trap circuits, every possible LC ratio in the final amplifier, and every possible method of coupling the antenna to the transmitter; but with absolutely no noticeable difference in this undesirable radiation, as checked from distances of one mile, two miles, seven miles, and ten miles, locally. Also several checks were made from points about one hundred to three hundred miles away.

I will describe the rig here so you will have an idea of what was happening. I am using a pair of 805 tubes with 500 watts input, modulated Class B by a pair of 838 tubes. The antenna is 260 feet

Push-Pull and Push-Push Operation Without Complications

An Intermediate or Final Amplifier Using 808 Type Tubes

By Clark C. Rodimon,* WISZ

UNTIL a year or so ago it was quite a problem to get enough excitation even on 14 Mc. to really drive a Class-C amplifier for plate modulation without running into cumbersome layouts with many stages. However, the tube manufacturers have been on their toes and sufficient excitation in the 14-Mc. band is now a "pipe." With the ten-meter band being so reliable, comparatively speaking, over the last few months and regulations being such that holders of Class-B tickets may use 'phone, it is only logical that this band should attract many operators. At the moment there are many modulated stages that are doubling from 14 Mc. This has proved disastrous in some cases as the fundamental

Last year we built a transmitter that used a pair of 805's in the final amplifier. It would go to ten meters but there was not sufficient excitation for plate modulation.

Another stage was contemplated for this transmitter that would have sufficient driving power for the 805's. This original transmitter was built of sectionalized cabinets so it was merely necessary to procure another of the cabinets and insert it between the exciter stage and final amplifier—another advantage of sectionalized transmitters.

The 808's had just made their appearance and their characteristics appeared to be just what was needed. Construction went apace along standard lines with nothing out of the ordinary in mind save the one problem of going from push-pull to push-push in the plate stage without altering the wiring in any way.

The construction is straightforward and requires few words. The photograph takes care of the layout. Link coupling is used on both grid and plate coils. As has been pointed out before this coupling link should not be made with "push back" wire wound directly over the windings, for the insulation will not stand the d.c. in the event of a possible "ground" at one of several points. In the case of the coil links we spaced 6 thin slabs of Mycalex over the tank

windings and wound the links over these slabs which were held on the windings by Duco cement. Incidentally, Mycalex is fairly easy to work with a hacksaw and a bit of patience. The plate coils were all self-supporting as explained later and the link is likewise self-supporting either inside or outside the coil—but spaced by the Mycalex strips.

Center taps in both grid and plate circuits receive their d.c. underneath the chassis, insulating feed-throughs carrying the potential. Brass

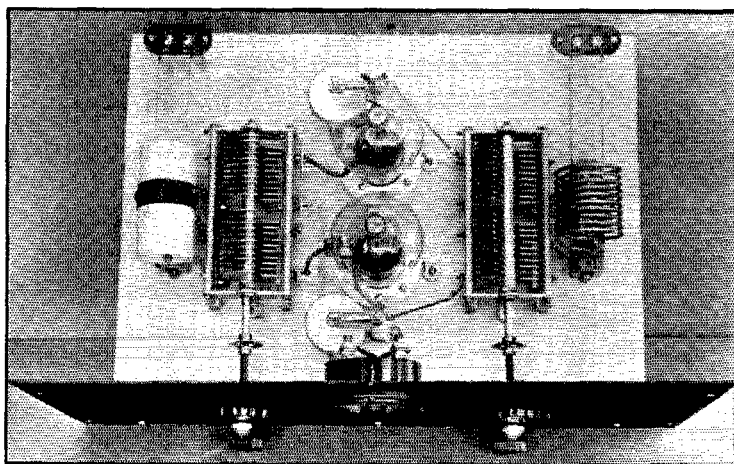

THE 808 AMPLIFIER PULLED OUT OF ITS METAL COMPARTMENT

In practice this unit is incorporated in the sectionalized 805 transmitter described in July '36 QST. As a driving amplifier it is only needed on 28 MC. It delivers enough power either as a straight amplifier or doubler to make a fair sized final amplifier and has been used as such, its output going directly to the pi-section network and the antenna system instead of the 805 amplifier.

energy was appearing on 14 Mc. (out of the 14-Mc. assignment numerous times) as well as on 28 Mc. Foreseeing the latest amateur needs the tube manufacturers have been keeping pace as evidenced by the latest batch of tantalum-plate high-mu (easy to drive) tubes of small proportions. These operate on medium voltages and deliver enough output for the most avid high-power enthusiast.

* Managing Editor.

machine screws and nuts should be used on these feed-throughs.

Unable to dope out a practical method of front-of-panel band switching the plug-in coil arrangement seemed quite logical and certainly a saving of space. The National PB5 and XB5 plugs and bases were used. These allowed five terminals and coil connections. For a push-pull amplifier that is sufficient, three terminals will be needed for the r.f. circuit in both grid and plate, and the remaining two will be needed for the link terminals. However, we want to go from push-pull to push-push without too much complication. With another terminal on the forms or with a switch to close when one desired to put the plates in parallel for push-push doubling there would be no problem. After some preliminary experimenting we decided to take the bull by the horns and unorthodoxly connect the amplifier for push-push and then see what concessions we need make when going to push-pull.

In Fig. 1A will be seen the plate circuit of a push-pull stage. The rotor of the split stator condenser could be grounded directly or through a by-pass condenser as shown with dotted lines. For future purposes it was found necessary to insert the blocking condenser, thus making insulation of the condenser from the chassis a necessity. Fig. 1B shows the same arrangement with the plug-in coil connections in place. This plate circuit would be correct for the use of push-pull operation alone.

Fig. 2A shows the next step. A direct connection has been made from X to Y and the coil connections have been adjusted so the plates are in parallel as well as the two condenser sections. This circuit is complete for push-push operation and works as expected. Let's try push-pull with

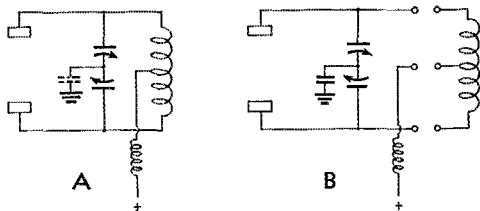

FIG. 1—AT A IS SEEN THE CONVENTIONAL PUSH-PULL PLATE CIRCUIT

At B the circuit is identical and connections have been shown for a push-pull plus-in coil.

the direct connection between condenser rotor and coil as shown in Fig. 2B. Offhand it seems very undesirable as it definitely makes two tuned circuits. However, in practice it works identically with Fig. 1B.

With this connection one will find second harmonic output when tuned to the second. In effect the plate tank is now two separate and complete circuits in series. However, with the

coil tapped in the electrical center there was a single minimum dip showing that the inductance was split evenly. There is no particular advantage in using this push-pull doubling arrangement and the disadvantage is that the coupling has to be done from the center to either end of the coil.

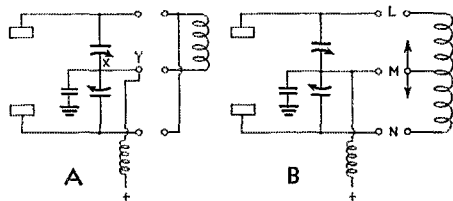

FIG. 2—THE CIRCUIT AT THE LEFT SHOWS THE DIRECT CONNECTION BETWEEN X AND Y (SEE TEXT)

The coil connections at A put the plates in parallel for push-push operation. Thus, connections in the amplifier proper never need be altered when changing from push-pull to push-push operation. The coil at B is a push-pull coil and may be tuned to its second harmonic.

Referring to Fig. 2B it would have to be from M to N or M to L. If one should have occasion to feed two amplifiers simultaneously, allowing use of two bands at once this would be of utility. However, we found the push-push doubling scheme to be efficient and we used it for all doubling. The efficiencies of push-pull and push-push doubling were identical.

Fig. 3 shows the completed amplifier circuit diagram. If anyone shudders at the idea of push-pull with a split coil he may insert a switch at X and open it when desiring push-pull operation. It was found desirable to wind separate 10- and 20-meter coils because of the complication of getting power out of the circuit as shown in Fig. 2B without a separate link. The idea of taking power from only one side of the circuit suggested an unbalanced condition and worried us although it appeared to balance itself fairly well as the plate dissipation in the two tubes was nearly alike. The best solution to such an arrangement probably would be two pancake coils in parallel with a link in between where it would be possible to divide the load evenly. However, such a coil has its complications. Inasmuch as another coil is necessary we decided on the arrangement shown at L_2 in Fig. 3 for push-push work which is identical with the coil in Fig. 2A. The efficiency of push-pull doubling as shown in Fig. 2B is the same as the parallel orthodox arrangement as shown in Fig. 2A.

Self-supporting coils for 14- and 28-Mc. operation were found more efficient than those on forms. No. 12 tinned wire proved very handy and mounted on the XB5 mounting the coil is very stable.

Original tuning up of the amplifier should be done with reduced voltage and with extreme care. Any misadjustment will be apparent immediately as the plates will flare up in no uncertain

manner. In case of excitation failure the plate current will run away out of bounds unless there is some fixed bias. 45 volts of negative bias is recommended at all times, in series with resistor bias. This is sufficient to reduce the plate current

plate tubes. After becoming completely adjusted to the new order the operator will find it decidedly advantageous to have such an immediate indication of a misadjustment. For instance one tube may color considerably more than the other.

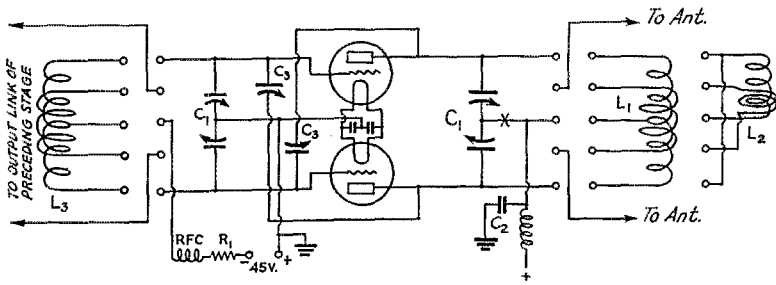

FIG. 3—COMPLETE CIRCUIT OF THE 808 AMPLIFIER

- C₁—100- μ fd. per section (Cardwell MD-100-GD)
- C₂—0.002- μ fd. 2000-volt rating
- C₃—NC800 type, neutralizing at $\frac{1}{2}$ " spacing
- R₁—25-watt 8000 ohm
- Filament by-pass condensers are 0.01- μ fd. receiving type.

This immediately suggests an unbalance in the grid or plate circuit. Probably one grid is getting more excitation than another. This may be remedied by adjusting the link around the grid coil. The tube running cool is getting more than its share of excitation and the link should be adjusted to more evenly balance this excitation. If that does not help

to zero without excitation with 1250 volts on the plates. When used as a straight amplifier a 2000-ohm grid leak was found ideal for maximum output at good efficiency. However, in doubling 8000 ohms was found optimum. For operation as straight amplifier and doubler the 8000-ohm resistor should be a good compromise.

matters the grid coil is unbalanced and the center tap should be moved so the excitation will be evenly divided between the grids. In case one is particularly worried about this, shunt feed could be used in the grid circuits whereby the current in each grid could be measured separately.

COIL DATA

- L₁—Push-Pull Connections for 7- and 14-Mc. Operation 7 Mc.: 28 turns $\frac{1}{8}$ " copper tubing, 5" winding space, self-supporting, $1\frac{3}{4}$ " diameter—link 3 turns at center of coil.
- 14 Mc.: 10 turns $\frac{1}{8}$ " copper tubing, $2\frac{1}{2}$ " winding space, self-supporting, $1\frac{3}{4}$ " diameter—link 2 turns at center of coil. (This coil will also tune to 28 Mc. but it will be impossible to take power out without changing the link.)
- L₂—Push-Push Connections Used When Doubling in Plate Circuit
 - 28 Mc.: 5 turns $\frac{7}{8}$ " diameter, No. 12 tinned wire, self-supporting, winding space $1\frac{1}{2}$ "—link 2 turns at low end of coil.
- L₃—Push-Pull Connections at all Times
 - 7 Mc.: 16 turns No. 18 enamelled wire, winding space $\frac{3}{4}$ " on XR13 form—link 2 turns at center of coil.
 - 14 Mc.: 12 turns No. 12 tinned wire self supporting, winding space 2", $1\frac{1}{4}$ " diameter—link 2 turns at center of coil. This coil is not changed when the amplifier is used on 28 Mc.

However, we have found the coloring of the plates to be a most useful indication of individual tube efficiency. In no case allow the total rectified grid current to run over 70 ma.

Using 1250 volts we could obtain 250 watts output when working as a straight amplifier and 180 watts when doubling, with no strain on the tubes. The tube driving the 808's happened to be an RK-20 running at the same plate voltage. This stage delivered more excitation than was necessary.

The only "bug" we ran into was instability on 20 meters. This was identified as a high-frequency parasite caused by the symmetry of plate and grid wiring. This was cured by inserting a 4-turn self-supporting coil the diameter of a pencil in one grid lead.

When playing with tantalum plate tubes one must be "plate dissipation" and "efficiency" conscious. We found out what shade of brilliance these plates should be at "maximum plate dissipation" by eliminating grid excitation and adjusting the grid bias voltage until the plate current was 270 ma. at 1250 volts. This experiment is in order originally so the individual's life span will not be shortened when the plate flare-ups occur. To one who has used graphite anode tubes in the past, plate coloring of any description is a sorry sight. One's estimate of tube efficiency must be completely readjusted when using tantalum

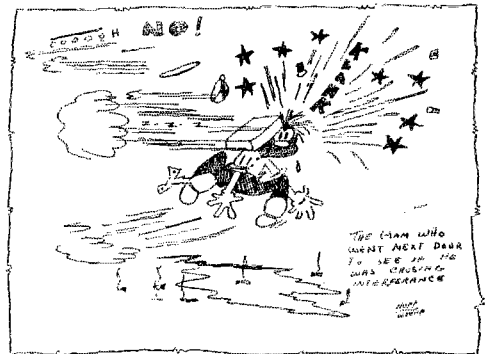

How Much C?

Determining the Optimum L-C Ratio for Transmitter Tank Circuits

By John L. Reinartz,* WIQP

A TUNED circuit containing capacity, resistance and inductance, may have these components in varying values, i.e., the capacity may be small and the inductance large or *vice versa* and still tune to resonance at the desired frequency. The action of the resistance on the tuned circuit will be to decrease the sharpness of tuning as its value is made larger. In actual practice there is a real value for the three components comprising a tuned circuit at resonance which results in optimum operation. This optimum value is not hard to find.

Because the performance of a transmitting tube is definitely tied up with the characteristics of the circuit in which it is used, and because the manufacturer has supplied us with the necessary tube characteristics, it is then entirely up to the user in what manner he makes use of such tube. Here is where the tuned circuit comes into the picture with its *L* to *C* ratio. Especially is this true for the amateur who uses 'phone, since proper values of *L*, *C* and *R* not only reduce the tendency for the generation of harmonics, but will also contribute in no small way to the successful operation of a well-engineered transmitter. Let us analyze the tuned circuit for such a transmitter.

First we must decide upon the output our transmitter shall be capable of supplying to the antenna system. Let us decide on 100 watts. Everything will now center around this value. It is also decided that but one tube will be used. Now the efficiency of a Class-C stage (plate modulated) can be taken as 70% and this automatically tells us our power input requirements, being 143 watts in our case. One of the tubes which comes into this class is the 808, which can be operated at 1250 volts. Assuming this type of tube is to be used in our example, we now have the operating voltage and the power output, two essentials of what is to follow.

When the tube is operating, there is an a.c. voltage component (at radio frequency) superimposed on the d.c. plate supply voltage. We must determine the value of this alternating voltage in order that we may learn what the impedance of the tuned-circuit is, because this then determines the plate current as read from the milliammeter approximately. The alternating voltage is generated in the tuned circuit through the action of the grid voltage applied to the tube from the exciter stage; each time that the grid

of the final stage goes positive, a pulse of current flows in the plate circuit of the tube. The voltage so generated is not sinusoidal and contains much harmonic content. To reduce this harmonic content a certain minimum capacity must be used in the tuned circuit.

From Ohm's Law we know that E^2/watts is equal to *R*, and it is also known that the voltage across the tuned circuit (the r.f. voltage that we find when we touch a neon lamp to the tank circuit) is equal to $0.8 E_b \times$ the efficiency of the tube.¹ In our case this would be $0.8 \times 1250 \times 0.70$, which equals 700 volts r.m.s. Now $700^2/\text{watts}$ equals the impedance of that circuit, or *Z*, in our case $700^2/100$ and is equal to 4900 ohms.

Now the larger the circulating current in the

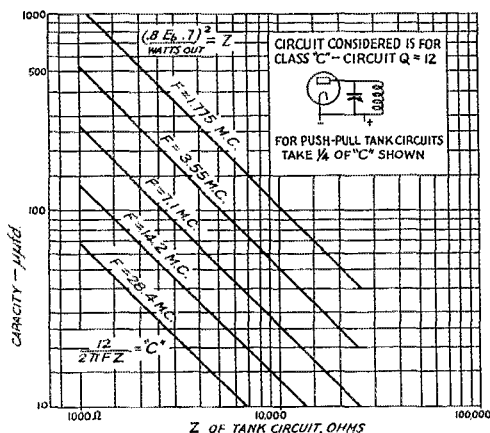

FIG. 1—CHART A—TANK CIRCUIT IMPEDANCE AS A FUNCTION OF TANK CONDENSER CAPACITY IN USE, FOR $Q = 12$

tuned circuit, the less the harmonic content, since the energy-storing effect of the condenser tends to smooth out the peaks in the circulating

¹ This formula, which is derived from the expression for the efficiency of an amplifier, is in the form $n \times E_b \times$ Efficiency, where *n* is a factor depending upon the operating angle (part of the r.f. cycle during which plate current flows). The factor 0.8 used by the author is a compromise value intended to represent average conditions of Class-C operation, where the bias is considerably beyond cutoff. Values of *n* vary between 0.9 for an operating angle of 180 degrees (Class-B operation, grid bias at cutoff) and 0.787 for an angle of 120 degrees. See W. G. Wagener, "Simplified Methods for Computing Performance of Transmitting Tubes," *Proc. I.R.E.*, January, 1937.—Editor.

*176 Wadsworth St., S. Manchester, Conn.

current due to the distortion caused by the plate current pulses occurring over but a short part of the grid voltage swing when it goes positive. The ratio of the circulating power in volt amperes (r.f. voltage times circulating current) to the watts output expected from the tuned circuit determines the value of the harmonic content in the tuned circuit. Terman and many

that $X_c = 415$ ohms, and since X_1 must be equal to X_c we set $415/2\pi fL$ equal to L which gives us 4.65 microhenrys as the proper inductance value for resonance. Also $X_c^2/4900$ will give us the equivalent series resistance of the tuned circuit, so $415^2 \div 4900 = 35$ ohms nearly. Now if we divide the X_c by 35 we will know the Q of the tuned circuit, this being $415 \div 35$ or 11.9. This Q is of course lower than if there were no output from the tuned circuit, being calculated when 100 watts were transmitted to the antenna circuit. It should also be noticed that the Q of 11.9 is slightly lower than the ratio of volt-amperes to true watts, which was 12. If we had taken the condenser capacity as calculated, i.e., 27.4 μmf . then the Q of the circuit would have also been 12. This is then the final check on all the calculations and will tell you if you have made any serious error.

For a push-pull transmitter and for a volt-ampere to watt ratio of 12, the capacity value needs to be but 25% of the value as calculated for a single ended stage for the same power output. But since the condenser needs to be of the split-stator type, the two sections will still have to have the same total capacity as the single-stage condenser. Therefore if we used a 100- μmf . condenser in the single-ended stage, for the push-pull stage

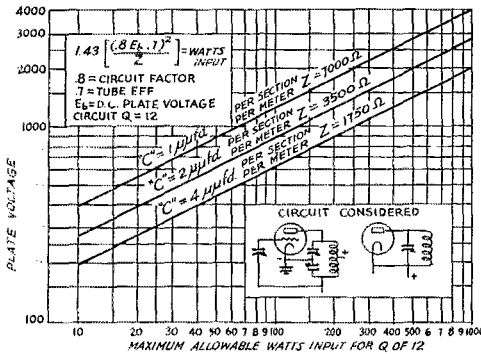

FIG. 2—CHART B—TANK CAPACITY (IN MICROMICROFARADS PER METER) AS A FUNCTION OF PLATE VOLTAGE AND POWER INPUT FOR SINGLE TUBES OR TUBES IN PARALLEL

Note that tank capacities are for each condenser section. In the plate neutralized amplifier using a split-stator condenser, each section should have the capacity indicated by the chart. The total tank capacity is, therefore, half that for screen-grid or grid-neutralized amplifiers, and the tank inductance should be correspondingly greater.

As an example of the use of the chart, suppose the desired input is 250 watts and a plate voltage of 1000 is available. The 250-watt line intersects the 1000-volt line on the curve marked "4 μmf . per meter." At 20 meters, therefore, the tank capacity (per section) in use should be 4×20 , or 80 μmf ., at 80 meters, 4×80 or 320 μmf ., etc. If the intersection of plate voltage and power input lines falls between the curves, the μmf . per meter value can readily be found by interpolation.

others state that for circuit stability and maximum allowable harmonic content, the ratio of volt-amperes to watts output should not be less than 12. In modern broadcasting stations the value runs nearer 25. Let us be satisfied with a ratio of 12.

If we now put C equal to $12/2\pi fZ$ and calculate for 14,200 kilocycles, we have $12,000,000/436,000 = 27.4 \mu\text{mf}$. as the tank condenser capacity. Call it 27 μmf . We multiplied the 12 by 10^3 , then divided 14,200,000 by 10^6 which put us back to 12×10^6 in order that we might obtain the answer in μmf . This 27 μmf . is then the proper value of capacity to use for a volt-ampere component of 12 times the watts output in order that the harmonic content of the tuned circuit may be so little that it can be tolerated.

We may as well continue with the analysis of the tuned circuit and find the value of the inductance that must go with the 27 μmf . for resonance at 14.2 megacycles. Since $1/2\pi fC = X_c$, we find

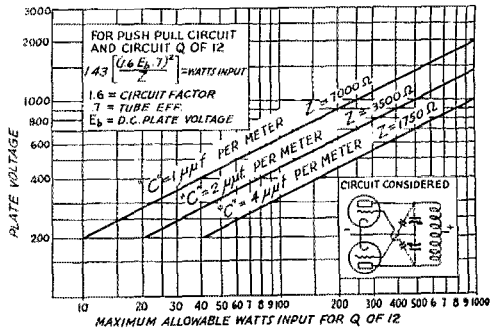

FIG. 3—CHART C—TANK CAPACITY AS A FUNCTION OF PLATE VOLTAGE AND POWER INPUT FOR PUSH-PULL AMPLIFIERS

This chart is used in the same way as Chart B, Fig. 2. The tank capacity indicated is the total capacity of the split-stator condenser. Each section, therefore, should have twice the capacity indicated.

a condenser of two 50- μmf . sections would be correct, and at the same dial setting as the single stage condenser would represent 25% of the single-stage capacity. The L of the push-pull stage then has 4 times the value of the single-ended stage. For an inductance of the same diameter and the same length, this would represent 100% more turns, because the inductance increases as the square of the number of turns. Since the inductance value for the single-ended

(Continued on page 116)

More DX Per Dollar

Final Amplifier, Keying and Antenna Systems

By Charles Perrine, Jr.,* W6CUH

In Two Parts—Part II**

THE 7-Mc. final amplifier is mounted in the top of the main transmitter frame as shown photographically in Part I. This frame is made of surfaced 1- by 2-inch redwood and given two coats of flat black lacquer. It stands 6 feet 6 inches high, is 21 inches wide and 15 inches deep. The front panel is in four sections, each made of 1/4-inch tempered Masonite finished in baked wrinkle enamel. Since all the tuned circuits in this transmitter are fixed, no dials or other controls appear on the panel. Near the top is located a red pilot light (5-watt 110-volt type) that serves as a very conspicuous warning when the plate power is on.

Below is a 6- by 10-inch grill placed in front of the two 7-Mc. 250TH's—the grill is made of perforated sheet metal, sprayed aluminum to contrast with the black panels. A row of four meters (100TH plate, 250TH plate, final plate and grid) complete the equipment on the panel. The result is one of pleasing simplicity.

The lower half of the frame is occupied by the low-voltage plate and bias supplies, as well as the filter for the high-voltage supply. An added improvement is a four-inch wide well or channel that runs the height of the frame

on one side near the back; all wiring between shelves is carried in this well, a stunt borrowed from the commercials that greatly helps neatness.

The circuit of this amplifier is shown in Fig. 4. Conventional in most respects, the 250TH's are grid neutralized with a capacity-balanced grid tank. The plate by-pass lead is tapped a few turns up on the plate coil L_2 to provide balanced r.f. voltage for the two-wire 600-ohm transmission line. Parallel operation was chosen principally because the tube output and input impedances are reduced to one-half that of a single tube. This

means that both plate and grid tanks have heavier loading to make their tuning broader, as pointed out previously. Harmonics are not troublesome because of the relatively low plate voltage.

The general physical layout of the amplifier can be seen in the photograph. The tubes are next to the panel with their filament transformer immediately beneath. Just behind them is the grid tank circuit enclosed in a shield box, 11 by 11 by 8 inches, made of cadmium-plated steel. While not absolutely necessary, this shield completely isolates the grid tank and helps neutralization. The link from the driver enters the bottom of the

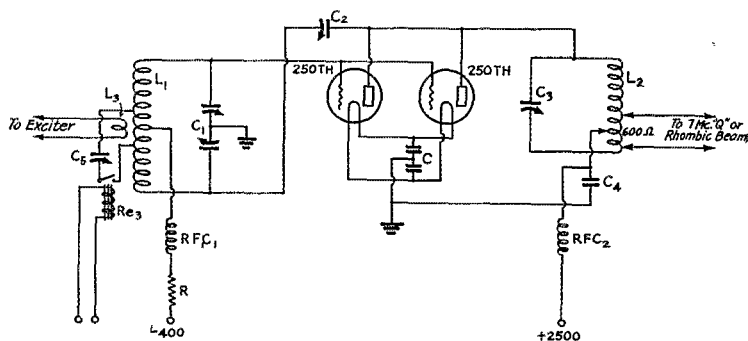

FIG. 4—CIRCUIT OF THE 7-MC. FINAL AMPLIFIER

- L_1 —23 turns No. 12 tinned, 2 1/2-inch diameter, 3 inches long, airwound.
- L_2 —18 turns No. 10 tinned, 3 1/2 inch diameter, 3 1/2 inches long, airwound.
- L_3 —1-turn link around center of L_1 .
- C —0.01- μ fd. mica receiving type.

- C_1 —50-50- μ fd. 6000-volt (Caradwell T183 split).
- C_2 —3-inch by 4-inch plates, spaced 1 inch.
- C_3 —50- μ fd. 15,000-volt (Natl. TML-50D).
- C_4 —0.002- μ fd. 7000-volt mica (C-D Type 86).
- C_5 —100- μ fd. m i d g e t
- (Hammarlund MC-100S).
- R —5000-ohm 200-watt.
- RFC_1 —2.5-mh. r.f. choke (National Type R100).
- RFC_2 —1-mh. amateur-band transmitter r.f. choke (National Type 154U).
- Re_3 —Padder relay. (See text.)

can through two small lead-through insulators that also support the link itself. The grid lead is brought out from the front of the can directly to the grid caps of the tubes. The neutralizing lead goes out the top of the box to the neutralizing condenser suspended on insulators just under the plate tank. The plate tank occupies the top section of the rack where it is handy to the antenna transmission line entering through two heavy lead-in insulators. All the tuning condensers, as in the driver unit, are arranged to be accessible for tuning from either side of the transmitter, which is sufficient since adjustments are seldom required once everything has been tuned up.

* 52 20th St., Hermosa Beach, Calif.

** Part I appeared in February QST.

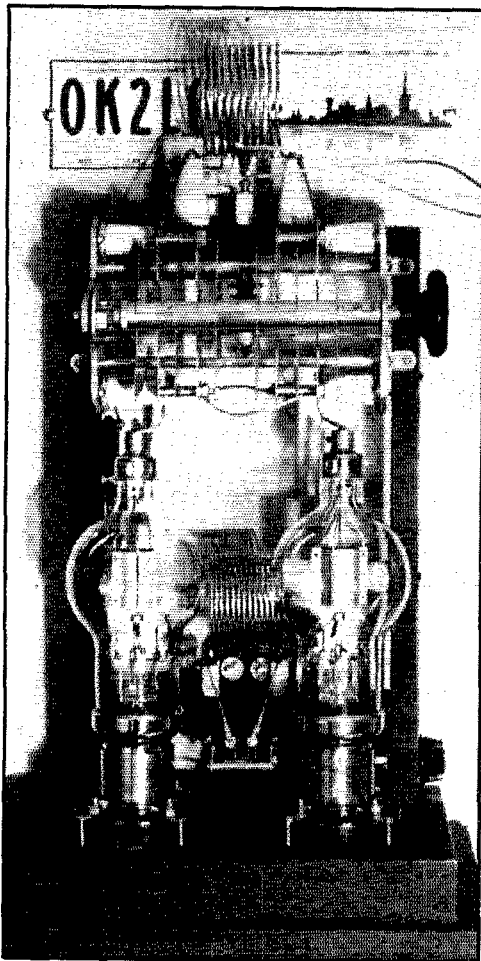

FRONT VIEW OF THE 14-Mc. FINAL STAGE

THE 14-Mc. FINAL AMPLIFIER

Now we come to the "little giant" 14-Mc. final amplifier that measures only 7 by 10 by 23 inches overall, including the two 250TH's. Every effort was

FIG. 5—THE 14-Mc. FINAL AMPLIFIER CIRCUIT

- L_1 —13 turns No. 12 tinned, 2½-inch diameter, 2½ inches, airwound.
- L_2 —10 turns No. 10 tinned, 3-inch diameter, 2½ inches, airwound.
- L_3 —1-turn link around center of L_1 .
- C_1 —25-25- μ fd. 3000-volt (split Curdwell MT-50GS).

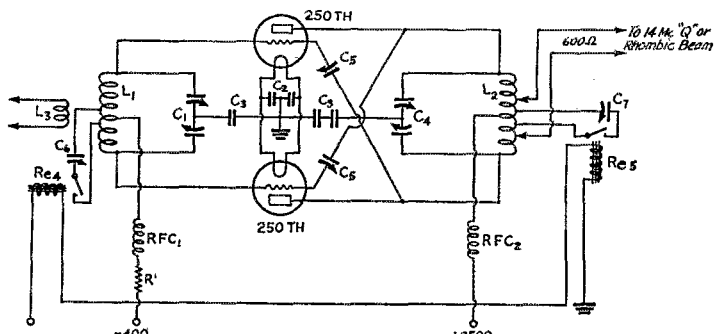

- C_2 —0.002- μ fd. mica receiving type.
- C_3 —0.002- μ fd. mica, 5000-volt.
- C_4 —25-25- μ fd. 15,000-volt. (See text.)
- C_5 —Two plates 2 by 4 inches, spaced ½ inch.
- C_6 —100- μ fd. midget (Hammarlund MC-100S).
- C_7 —Same as C_6 .
- R —5000-ohm 200-watt. RFC₁—2.5-mh. r.f. choke (National R100).
- RFC₂—1-mh. transmitting r.f. choke (National 154U).
- Re₄—Padder relay.

made to obtain perfect symmetry and the shortest possible leads. To this end the neutralizing condensers are especially shaped to fit better into the wiring scheme; and even a special plate tank condenser was built because there was nothing available at the time to meet the requirements of this amplifier.

The circuit of the amplifier is the standard push-pull variety as shown in Fig. 5. Split-stator tank condensers are used in both plate and grid tanks with their rotors by-passed through isolating condensers. Both circuits are Low- C ; and, being designed solely for 14 Mc., the capacities of C_1 and C_4 are accordingly lower than in similar condensers. The padding condensers C_6 and C_7 are connected across one turn at the center of the tank coils. The antenna transmission line is tapped symmetrically on the plate tank and feeds either the rhombic beams or the 14-Mc. "Q." The two padder relays Re_4 and Re_5 shown are connected in series to ground to complete the negative return on the 400-volt exciter power supply.

A look at the two photographs of the 14-Mc. amplifier will give the reader an excellent idea of the constructional features involved. The advantages of this layout combine simplicity with extremely short leads; the parts are placed in almost the same relative positions they occupy in the circuit diagram drawing. This amplifier is a smaller edition of the "open rack" amplifier used by the author some two years ago.

The base is made up of a 7- by 10-inch frame (redwood 1 by 2's) with a piece of ¾-inch plywood set in the front part, and the two vertical members screwed on near the back. The sockets are above the base with all filament wiring and by-passes underneath. The upright part of the frame is 18 inches high—just enough to make the tank condenser clear the tops of the 250TH's. The grid tank is supported on a

level with the tube grid caps by a cross-piece set into the vertical frame about four inches above the base. The grid tank condenser is a 50- μ fd. Cardwell Midway that was split to give about 20 μ fd. per section. It is mounted on the under side of the cross-piece with an extension shaft brought out to the control knob on the right-hand upright. All tank and isolating by-pass condensers are mounted directly on the wood since there are neither r.f. nor d.c. voltages on them during normal operation.

The grid tank coil is mounted above the cross-piece on small standoff insulators. A small bakelite plate mounted vertically on the back edge of the cross-piece carries two lead-through insulators that act as terminals for the link line and as supports for the one-turn link around the center of the grid coil. The automatic grid padder unit, *C_g-Rea*, is mounted on the back of the main base, just to one side of the link terminals.

Just above the grid tank are the two neutralizing condensers, one on each frame upright. The plates used in these condensers were purposely made long and narrow (2 by 4 inches) to make the neutralizing leads as short as possible. The two lower plates are mounted on the shorter insulators (National GS-5) and wire directly to the ends of the grid tank. The two upper plates are supported on longer insulators (National GS-6) because they are much "hotter." The resulting plate spacing is about $\frac{1}{2}$ -inch with a plate overlap of $2\frac{1}{2}$ inches. The two upper plates are on a level with the plate tank condenser terminals, requiring very short leads.

The special plate tank condenser was made up from parts taken from a single-section condenser. New skeleton end plates were made to reduce the minimum capacity as greatly as possible. Each section has only five plates which, with a $\frac{1}{2}$ -inch air-gap, gives 25 μ fd. at 15,000 volts. This is plenty of capacity for 14-Mc. work and will do in a pinch on 7 Mc. The two stator sections are light enough to be supported at one end only, thus saving a great deal of space at the center of the condenser.

Topping off the amplifier is the relatively small plate tank coil. It is mounted at the ends on 2-inch insulators, with the center-tap supported by a 1-inch insulator. The coil is self-supporting and sufficiently rigid because of the solid center-tap support. The plate r.f. choke is suspended from the top cross-piece just behind the tank condenser. The plate automatic padder unit is attached to the back of the cross-piece as can be seen in the back view of the amplifier.

All power leads are brought out the bottom through the shelf that supports the entire amplifier. This shelf is located on the shack wall

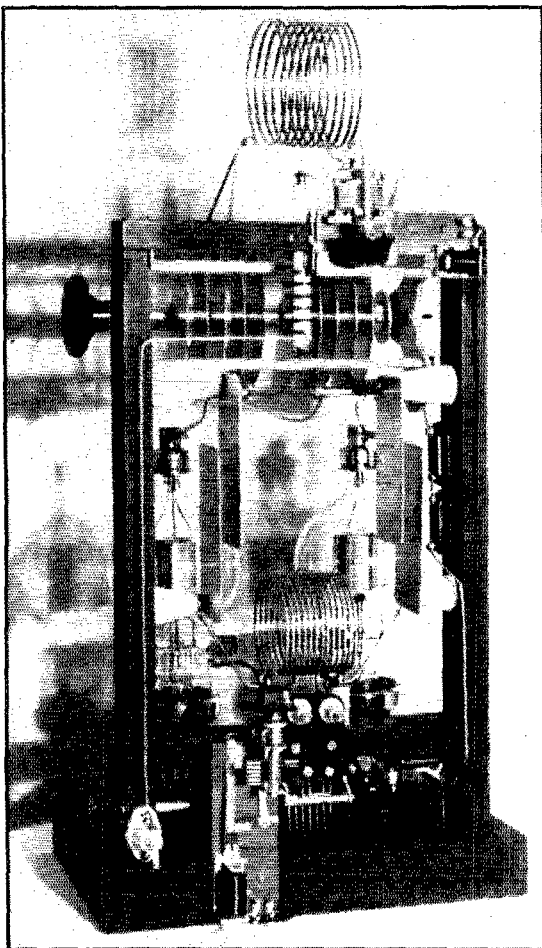

REAR VIEW OF THE 14-MC. AMPLIFIER

beside the main transmitter frame. The power and control leads are cabled together with the exception of the r.f. link which seems to work best separately at this power. To assure proper filament voltage, the filament transformer for this stage is located right under the aforementioned shelf.

THE 28-MC. DOUBLER-FINAL AMPLIFIER

The breadboard 28-Mc. power amplifier-doubler completes the r.f. picture of the transmitter. The circuit, using two parallel 250TH tubes, is given in Fig. 6. 14-Mc. excitation is introduced through the link *L₃*. The single-ended grid tank is novel in that it is tuned by a rather small condenser tapped down on the coil to keep it from arcing. This is necessary because the r.f. voltage on the grids is very high when doubling in this manner. With 50-ma. grid current, the bias totals 2400 volts and the r.f. swing on the

grids approaches 4000 volts. A total bias of 2400 volts represents 24 times cut-off for a plate voltage of 3300 (these 250TH's have a μ of about 32)—and the tubes run "cold" under keying at 300 ma.

as a neutralized amplifier by adding a single neutralizing condenser.

SWITCHING, ANTENNAS, AND POWER SUPPLY

Choice of bands is made by switching filaments to the corresponding finals, plate voltage being on all three permanently. The band-selector switch is a Yaxley three-gang three-point coil switch mounted on the transmitter control box panel. This switch selects the filament voltage for the finals, controls the band-change relay Re_2 , and cuts in the corresponding set of frequency indicating pilot lights. In the case of 28 Mc., a small d.p.d.t. a.c. relay is connected across the primary of the 28-Mc. amplifier filament transformer so as to transfer the driver link from the 14-Mc. amplifier to the 28-Mc. one.

It will be noted from the circuits that several antennas are indicated, each through its 600-ohm transmission line. All transmission lines were purposely made 600 ohms to facilitate antenna interchange. Normally, each amplifier has some one of the antennas connected to it; hence no

automatic antenna change is required when shifting bands. Four antennas have been used, all 65 feet high. Two were standard 7- and 14-Mc. horizontal Q antennas. The others were identical rhombic beams,¹ one aimed at Europe (33 degrees E of N), the other at Africa (8 degrees

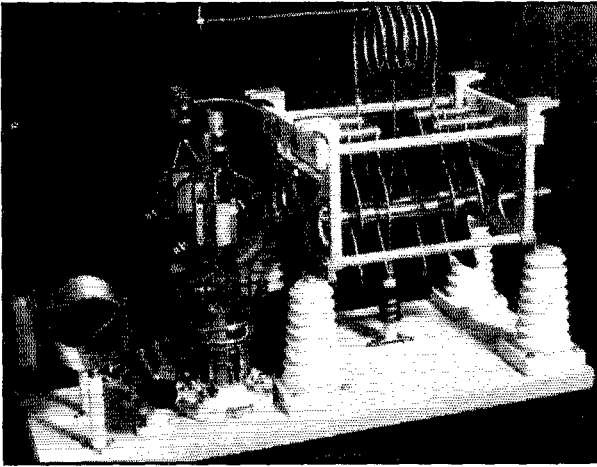

THE 28-MC. 1-KW. POWER DOUBLER

Short direct leads characterize this set-up. The 14-Mc. grid tank is on the left, with the filament transformer for the 250TH's behind it. The plate tank circuit is mounted up in the air to make the plate leads as short as possible. The plate blocking condenser is just to the right of the tubes under one end of the big tank condenser.

Although no neutralization is required or used, the plate tank L_2-C_4 is balanced to ground by the split-stator condenser. This was done particularly to prevent unwanted coupling always present through the ground return when a single-ended output tank is used at such high frequencies. Balancing the tank also simplifies the matter of coupling the two-wire transmission lines.

The layout of the amplifier is simplicity itself. The filament transformer, grid tank, and grid condenser are located at one end of the base. Next are the two tubes mounted as close together as possible. The plate tank condenser is the new National TML-25DD that matches the special condenser used on 14 Mc.; it is mounted in an inverted position on 5-inch stand-off insulators to bring the stator terminals on a level with the tube plate caps. The tank coil is permanently mounted directly on the two stator sections with the center-tap lead dropping down through the tank condenser (between the sections) to the plate r.f. choke below. As previously mentioned, this amplifier is used for experimental work and can be adapted easily

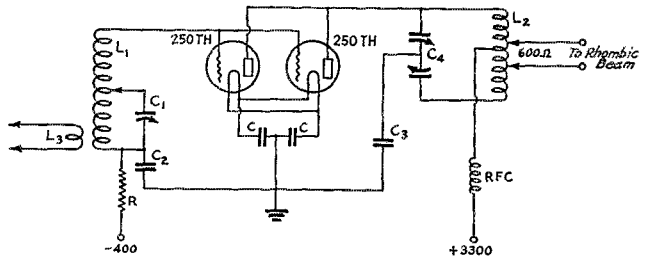

FIG. 6—THE 28-MC. DOUBLER-FINAL CIRCUIT

- L_1 —12 turns No. 12 tinned, 2½-inch diameter, 3 inches long, airwound.
- L_2 —6 turns No. 10 tinned, 2½-inch diameter, 2 inches long, self-supporting.
- L_3 —1-turn link.
- C —0.002- μ fd. mica receiving type.
- C_1 —50- μ fd. double-spaced (Hammarlund MC-50SC) tapped on 5th turn.
- C_2 —0.002- μ fd.
- C_3 —0.002 7000-volt mica.
- C_4 —25-25- μ fd. 15,000-volt (National TML-25DD).
- RFC—1-mh. choke (National 154U).
- R—40,000-ohm 100-watt.

S of W). They are 3¼ wavelengths long on a leg for 14 Mc. with end angles of 63 degrees and side

¹ These rhombic antennas are to be described by W6AUX and W6CNX in a later issue.—EDITOR.

angles of about 117 degrees. Each is terminated by a 750-ohm open-wire line, of high attenuation, 200 feet long ending in a non-inductive 30-watt carbon resistor. Terminated in this manner, the rhombics develop a power gain of 25 in the forward direction, and have a front-to-back ratio on reception of S9 to S1.

Four power supplies, as diagrammed in Fig. 7, are used in the transmitter. First is the well-filtered 400-volt supply for the exciter with a 5Z3 rectifier followed by 50 henrys and 24 μ fd. in the filter. The bias supply uses a 5Z3 followed by 4 μ fd. (no choke) with a 2000-ohm bleeder to give stable bias voltage. The third supply delivers 1500 volts to the 100TH; a pair of 866's and 1 μ fd. of filter doing the job. The big supply for the final amplifiers and the driver 250TH was designed particularly for primary keying. Two transformers are used with secondaries in series and primaries in parallel to deliver 2500-3300 volts

each side of center to the two 857 rectifiers. The transformers have about 50% higher primary impedance than is usual practice—this greatly reduces surges due to core saturation. R.f. chokes (600-ma. current capacity) are used in all secondary leads to the plate transformer, in the positive lead to the 857 cathodes, and in series with the two 2- μ fd. 5000-volt filter condensers (Pyranols). These r.f. chokes clean up the note and prevent possible breakdowns due to r.f. leakage into the power supply.

IMPROVED PRIMARY KEYING

The 1500- and 2500-volt power supplies are both simultaneously keyed in the primary. The small filter on the 100TH, 1 μ fd. and no choke, is sufficient since the following stages are operated Class-C and iron out the 100TH modulation. This means that possible tails due to the heavy

(Continued on page 112)

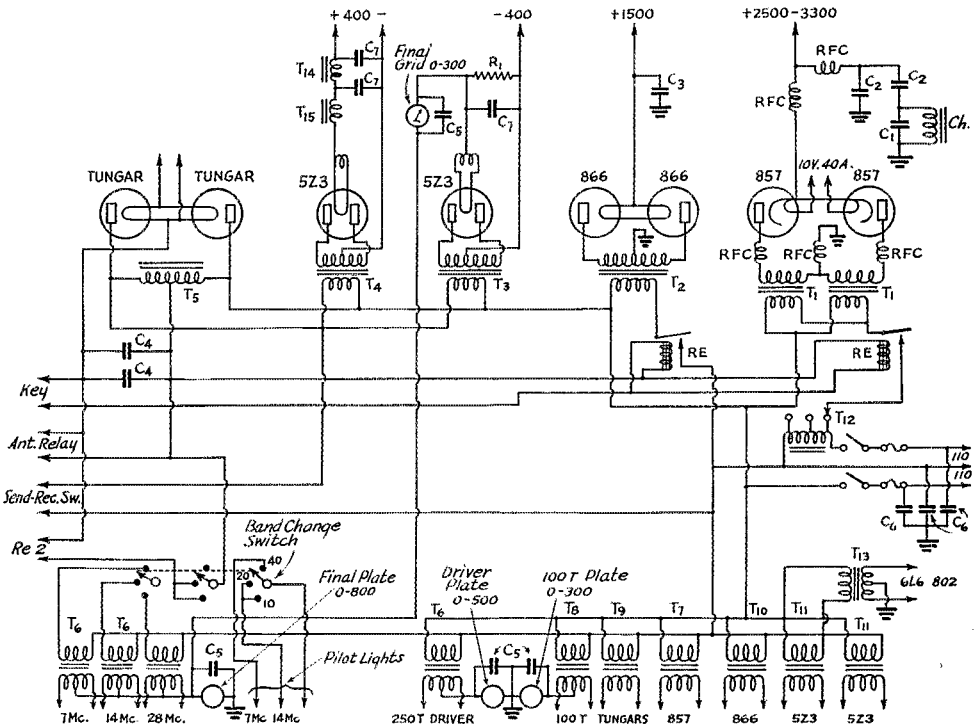

FIG. 7.—POWER SUPPLIES

- | | | | |
|--|--|--|--|
| C ₁ —1- μ fd. 1000-volt (Pyranol). | C ₇ —8- μ fd. 600-volt (Pyranol). | T ₂ —3000-v. c.t. 300-watt. | T ₁₁ —5-volt 3-amp. |
| C ₂ —2- μ fd. 5000-volt (Pyranol). | R ₁ —2000-ohm 200-watt. | T ₃ —700-volt c.t. 100-watt. | T ₁₂ —Auto-trans. 110-volt 1000-watt. |
| C ₃ —1- μ fd. 2000-volt (Pyranol). | RFC—1-mh. r.f. choke (National 154U). | T ₄ —900-volt c.t. 100-watt. | T ₁₃ —6.3-volt 3-amp. |
| C ₄ —50- μ fd. 50-volt (Electrolytic). | Re—Main keying relays. (See text.) | T ₅ —110-volt auto-transformer c.t. 100-watt. | T ₁₄ —30-henry 200-ma. |
| C ₅ —0.002- μ fd. mica 1000-volt (Sangamo). | T ₁ —220-v. primary to 4000-v. sec. 1000-watt (Similar to UTC-PA113). | T ₆ —5.25-volt 20-amp. | T ₁₅ —10-henry 200-ma. |
| C ₆ —2- μ fd. 400-volt paper. | | T ₇ —10-volt 40-amp. | Ch.— $\frac{1}{2}$ -henry for 60 cycles. Modified tuned filter. Second C ₂ condenser prevents higher harmonic ripple. |
| | | T ₈ —5-volt 10-amp. | |
| | | T ₉ —2-volt 14-amp. | |
| | | T ₁₀ —2 $\frac{1}{2}$ -volt 10-amp. | |

• What the League Is Doing •

League Activities, Washington Notes, Board Actions—For Your Information

QSL Cards Don't you fellows *want* your QSL cards? The files of the A.R.R.L. QSL Managers are bulging with unclaimed QSL cards. There are bushels of them, some fancy ones, from all over the world. There are almost unquestionably cards on hand for every amateur who has a station. Cards frequently come through very late, with initial delay on the part of the sender, additional time consumed in the foreign society, and the necessary time for handling on this side. Therefore even amateurs who have not been active on the air for a year or more may expect that there are cards on hand for them. You have to send for them — that is the way the system works. The dope is given elsewhere in this issue (*any* issue), with the simple instructions and the address of your QSL Manager. Claim your cards!

Flood Order We report here as a matter of record the January 26th order of the F.C.C. concerning flood emergency work, a subject of course discussed elsewhere in this issue:

TO ALL AMATEUR LICENSEES:

The Federal Communications Commission has been advised that the only contact with many flooded areas is by amateur radio, and since it is of vital importance that communications with flooded areas be handled expeditiously,

IT IS ORDERED that no transmissions except those relating to relief work or other emergencies be made within any of the authorized amateur bands below 4000 kilocycles until the Commission determines that the present emergency no longer exists.

By the Commission:

JOHN B. REYNOLDS, *Acting Secretary*

26 January, 1937

Headquarters Notes A.R.R.L. Headquarters has never been busier than it has this winter. The place positively bulges. It takes five people half a day to open our Monday mail. Business has been rushing. We are filled with new ideas and plans. Plans progress for the new headquarters station, to be a memorial to H.P.M., but await the decision of the Board as to location. The mimeograph runs overtime with Handy's special bulletins and the Secretary's reports to directors. QSL cards arrive from foreign countries by the bushel. Our shop and laboratory are continually buzzing with something new. Editorial conferences plan carefully the contents of the bigger issues of *QST* that we publish these days. The Executive Committee meets periodically to examine the general course of the League. The Communications Department seethes with operating activities, re-

lief work, plans for relays and contests. Two awards are about to be made in amateur radio. The Columbia Broadcasting System is making its study, having in hand nominations from the A.R.R.L. as well as from other sources; meanwhile the League organization addresses itself to the job of choosing the 1936 winner of the Hiram Percy Maxim Memorial Award. Additional trips to visit affiliated clubs are under way. All in all, it is a great winter around 38 LaSalle Road. Come in and see us!

Cairo Notes The British government has formally advised the R.S.G.B. that, while they view sympathetically the amateur need for widening bands, they consider it hopeless to put forward the proposal, having regard to the requirements of other services, many of which similarly need space which is not available. On the other hand, encouraging news—the first ray of hope—comes from France, where the R.E.F. report their government's probable willingness to support a proposal for amateur widening, if such proposal comes from another administration. The whole Cairo question continues under study by the I.A.R.U., which right now is engaged in particular in resurveying the situation in the light of the information from France.

To keep straight the record of ratifications of the existing treaty, we report the following: Liberia last June ratified the *Washington* convention and regulations. Just a bit slow. The government of Yemen has announced its adherence to the Madrid convention but, having made no declaration with respect to the radio regulations, we do not consider that a binding treaty obligation exists as between the United States and Yemen. Iraq in September last announced adherence to the Madrid convention and regulations.

More For Your Money We recently had occasion to make a statistical comparison of *QST* with all the other American radio journals for a typical month, and the results are interesting. Leave out the fact that *QST* is first with the hot news of new developments. Ignore the fact that it is the organ of your association, with the news of organized amateur activity. Forget that A.R.R.L. also provides (and finances) self-government for amateurs, maintains a communications department, fights the amateur's battles, conducts developments, supplies technical and legal advice. Compare just the magazines:

	Price	Reading Pages	Standing Pages*	Advertising	Total Pages	No. of Major Articles.	Number of Departments	Words of Text
Magazine "A".....	\$0.25	49	2½	84½	60	5	7	41,000
Magazine "B".....	0.35	22	2¼	11½	36	5	4	17,000
Magazine "C".....	0.50	45	2	33	80	11	5	30,000
Magazine "D".....	0.50	149	18½	12½	180	7	2	42,000
Magazine "E".....	0.30	74	3	23	100	13	2	40,000
Magazine "F".....	0.25	40	2	26	68	13	5	33,000
Magazine "G".....	0.25	26	2	10	38	6	4	18,000
Magazine "H".....	0.25	43¾	2	22½	68	8	14	35,000
Magazine "I".....	0.25	53	2	13	68	11	2	28,000
Magazine "J".....	0.25	50	2	28	80	8	7	37,000
"QST".....	0.25	80½	4½	47	132	12	7	60,000

*Such things as contents page, first cover, tabular listings.

Beyond the value of its contents it is also apparent that *QST* offers more in actual words of reading matter—more than any other radio magazine. Its 60,000 words are 43% more than its nearest competitor (higher priced) and about 90% greater than the average of the other ten, which include four selling at a higher price.

A.R.R.L. can produce this kind of a magazine for its members in addition to its other activities because ours is a cooperative society—we don't have to worry about owner dividends, we plow it back in. Thoughtful amateurs support the association that does these things for amateur radio. Canny amateurs save money by joining; they get *QST* delivered to their doors each month—flat, fresh, earlier, cheaper.

Government Reorganization

President Roosevelt's government reorganization program, submitted to the Congress on January 12th, contemplates transferring the functions and personnel of the F.C.C. to the Department of Commerce and abolishing the Commission. It is proposed to divide the Commission into two new units. One would be an administrative section, consisting of all the present F.C.C. personnel except the commissioners themselves; and it would formulate rules, initiate actions and otherwise carry on the present regulatory and administrative activities of the F.C.C. The other part, consisting of the commissioners themselves, would be a judicial section which would sit as an independent body to make decisions on records and findings presented by the administrative section and to hear appeals from rulings of the administrative section. The latter section itself would be headed by a civil-service career man as a director.

The President has asked for discretionary authority to shift bureaus and rearrange government departments. The proposal concerning the F.C.C. is part of a larger plan for government overhauling drafted by a committee appointed by the President. There is objection to the theory of the independent commissions because of their overlapping administrative and judicial functions. On the other hand, these independent establishments are created by the Congress to carry on functions that properly belong to the Congress

but which the latter does not have the technical skill to administer. Some hold that the commissions therefore do not, properly speaking, belong in the executive arm of the government at all. Thus in this matter there is likely to arise a conflict between principle and practicality, and between schools of thought, and the subject probably will receive extensive discussion at Washington in the weeks to come. It doesn't so far seem to be a matter of any great moment to us amateurs. We have got along equally well under numerous shifts of administration.



DIXIE JONES' OWL JUICE

THE trouble with young squirts is they no so much that ain't so. Before they git the egg-shell off thair nose and before they done it enough to no for sure how to button thair britches wye here they come a bulgin' in wild eyed a noin' it all and you can't tell 'em nothin'. Whair they learnt it so quick I'm danged if I no, and old stiffs is the same way. The only difference between young squirts and old stiffs is young squirts think they no and old stiffs no they no and you can't tell either one of them a thing. They no instinctively that them weights don't belong on a bug. "Sappy New Year", they say. "Bev wisses for a sappy new year." It ain't the new year that's sappy. It's the addle pated numbskulls that's thumbn' the bug.

—W4IR of the "Dixie Squinch Owl."

Strays

When your bug won't stay still on the table, apply the business end of a hot soldering iron to the rubber feet. The feet will get sticky and it will take a husky swat to make the bug budge. (Don't mind the odor!)

—W3BES

An Earth-Model for Showing Daylight-Darkness Distribution

By Byron Goodman, W1JPE*

AMATEUR radio is the sugar-coating for many an educational pill. Without being conscious of the effort spent, we learn more of geography than in any other hobby except, possibly, stamp-collecting. To get to first base we have to know something about electricity—and mechanical design as well. The ionosphere becomes our best friend and most constant heckler. But when we start to experience multiple echoes, strange skip effects and kindred phenomena, we realize that not all of the necessary tools are available with which to obtain a better understanding.

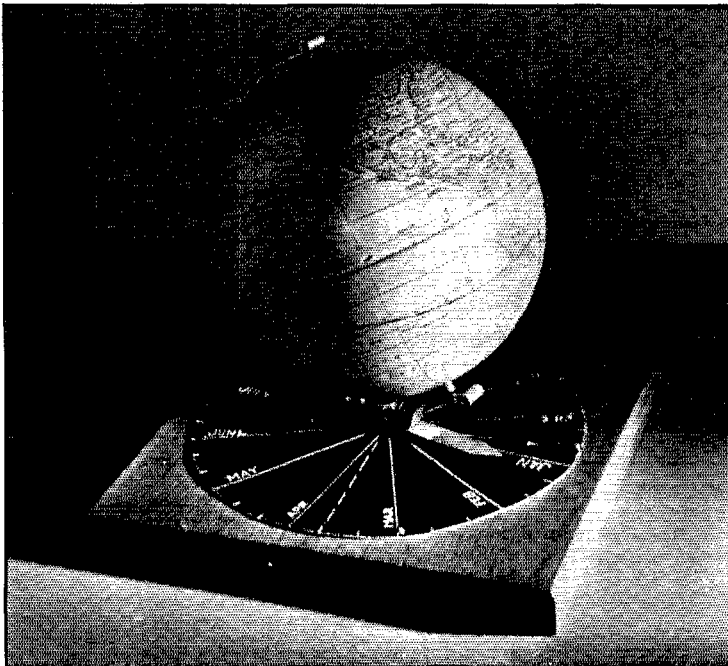

Since signal paths depend on the distribution of daylight and darkness, we decided to build a little gadget which would prove useful in gaining a better comprehension of some of the effects of high-frequency radio propagation. It would be a model of earth and sun, capable of being set to simulate day-night conditions at any time during the year.

The model to be described is simple and inex-

* Assistant Secretary, A.R.R.L.

pensive and will be a useful adjunct to the shack, serving as an instructive instrument that often can be played as a trump card in those endless arguments as to "which way were his signals traveling?" Daylight distribution is often much different than one would suspect, especially in the middle of summer and winter. And the dawn-dusk zones, the critical places, move around during the seasons in an amazing way. Often some startling piece of "daylight" 7-Mc. DX will resolve itself into simple darkness transmission, after inspection of the model shows that there was twilight all along the path. Or perhaps the terrible echo on that VK can be explained by the fact that there were two possible paths of transmission at the time. In any event, here is something to tax your analytical capabilities and whet your imagination.

The thing is easy to build. For twenty-five cents we bought a metal globe at the corner drug-store (they should also be available in department stores and stationery shops) selecting one out of several as being the most properly fitted of the lot. This particular globe had the advantage that the supporting member was cut down to a minimum of material, thus casting as little shadow as possible. The tin base was removed and a small metal pointer, cut out of aluminum, was bolted to the globe support to serve as an index for its annual rotation with respect to the sun. For a "calibration chart," a disk was cut out of cardboard, painted black to reflect less light, and divided into twelve sections by simple geometric methods—or, if you have forgotten your geometry, your watch can be placed in the center of the disk, and a mark made opposite each hour. These twelve equal segments, corresponding to the months of the year, are then

(Continued on page 72)

How Would You Do It?

Presenting the Prize Winners in the First of the Series of Problem Contests: Announcing the Third Problem

WE MIGHT as well come out into the open and be frank about it. No. 1 of the series of Problem Contests proved to be probably more of a problem to *QST*'s editors than to the contestants. We had really a tough time coming to any decision on the winners. After sorting out the obviously imperfect and incorrect "solutions" we ended up with an even hundred manuscripts. With a handful of exceptions the solutions covered the following schemes: Opening or shorting the antenna circuit with a switch or relay; connecting a neon bulb across the input; inserting a grid condenser and high resistance leak in the first grid circuit; opening the cathode circuit of the first tube (simultaneously switching off the plate voltage in some cases); balancing the r.f. picked up by the receiver with some opposing r.f. introduced intentionally; throwing a high negative voltage on the first tube or tubes by rectifying some r.f. picked up intentionally from the transmitter; opening the cathode circuit of the first tube with a thermionic tube controlled from the transmitter. Decision on the winning manuscript was handicapped by the very considerable duplications. As many as twenty papers, for instance, treated exactly the same scheme.

The only possible procedure was to have every technical-minded member of the Headquarters' staff read each manuscript, giving points for novelty of the scheme, its effectiveness, the order of its simplicity, and the completeness of the description. So close were the scores of the first 18 contestants that we felt a desperate need for 18 first prizes. Abiding by the rules, however, we ended up with the following results:

First prize, George J. Lillion, W8JMI.

Second prize, Milton Lowens, W2EZR.

Because almost a hundred others contributed perfectly practical and satisfactory solutions we are obliged to give some sort of honorable mention to the following contestants:

W1ALJ; CT; ICN; JPX; JXN; KFN; LZ
W2AOE; BDJ; DDV; EPZ; EZR; HNS;
HQL; IZG; JUC
W3BES; BUO; BGD; CHO; EAP; FHT;
FSP; GL; VD
W4BNF; BUE; CNY; CXC; DNA; UE
W5AVA; CVO; DHJ; EOO; ERS; EXZ; FDK;
FDQ; FLR
W6CQI; EHQ; JHV; KIA; KZN; LND; NLZ
W7BDL; ETQ
W8BST; CEF; CHT; DPY; FU; HWU; JMI;
JPP; KKH; KNF; MRZ; NCL; NCM;
NLX; NQ; NXX; POA

W9AEN; DKF; PYU; RKV; SPB; SSG
K4DSE
VE2DU
VE3AFT; AGV
VE4DZ; KC
VE5FZ
G5MP

T. J. Barnes; Thomas Coor; Austin Crane;
Stuart Coffe; Louis K. Davis; Marcus Gal-
yeau; Stanley Howell; Allan Hudson; Oliver
Hursh; Gordon Jacobs; Bill C. Muir; Walter
Neal Pike; Richard G. Raymond; Howard
Smith; Harold E. Walker

To clarify the whole situation we shall mention a few of the factors which the judges kept in mind—factors which apply not only to this contest but to the actual business of protecting a receiver. Many of the schemes were adaptable only to single-wire-fed antennas. These were considered unsatisfactory in the general case because of the very desirable trend toward the use of a transmission line of one kind or another between the receiver and antenna and because of the similarly desirable trend toward the use of the transmitting antenna (particularly when it is a directive affair) for reception. Other schemes involved placing neon bulbs or detuning condensers across the first grid circuit. Such methods are usually unsatisfactory because they detune the first circuit and call for realignment which, in a commercial receiver, may be difficult to accomplish. The balancing systems in which r.f. bucks r.f. or where the cathode current of the first tube is bucked with current generated by a separate tube were marked down because of the extreme difficulty of obtaining and maintaining a balance on different frequencies and under different conditions. The business of shorting the antenna or disconnecting it is, of course, by no means novel and on the higher frequency bands is only partially effective. The same applies to the use of neon tubes, particularly when they are connected across a low impedance transmission line or the low impedance input to the receiver. Methods involving opening the cathode circuit of the first tube are effective, but it must be remembered that even with the plate voltage disconnected, a considerable d.c. potential may exist between the cathode and the grounded heater—a condition which is not looked upon favorably by the tube manufacturers.

The scheme suggested by W8JMI has the merit of being sure-fire irrespective of the arrangement of the antenna or the placement of the

receiver. It does involve some monkeying with the innards of the receiver and it requires an extra tube. It is, though, almost the equivalent of pulling out the first tube and wrapping it in cotton wool. The solution offered by W2EZR was had also from about a dozen others (who failed to score as many points with their descriptions). It is, of course, as sure-fire a scheme as one could have. It has the merit of simplicity but suffers because of the need for switching and the resulting inability to allow break-in.

Here, anyway, are the two winning papers:

* * *

First Prize Solution

By George J. Lillion,* W8JMI

HERE is the solution to a problem of mine which parallels that of the hero in your first contest problem. The job was to make life more nearly a bed of roses for the first r.f. tube, which picked up considerable r.f.—150 watts being loathe to leave the room, judging from signal reports. Since break-in is used the fewer relays the better.

The ancient idea of using a relay with contacts to short the grid of the first tube was discarded because of the complications of r.f. and fancy bias networks in the modern receiver. The only solution remaining, as far as I could see, was to apply bias to cut off any grid current during transmission, the bias being obtained from an external source independent of the tube itself.

Dispensing with batteries or tapped power supplies from some other unit, a diode is used to rectify a small portion of soup swiped from the transmitter output either by a pick-up coil near the tank or a tuned circuit with a small antenna. The diode rectifies this r.f. (which would have come out of the speaker anyway) and applies it to the grid of the r.f. stage—or both grids if there are two stages. Fig. 1 gives the idea. L1 is a small pick-up coil near the field of the final tank and fed through a piece of lamp cord to the

* 1238 Tonawanda Street, Buffalo, N. Y.

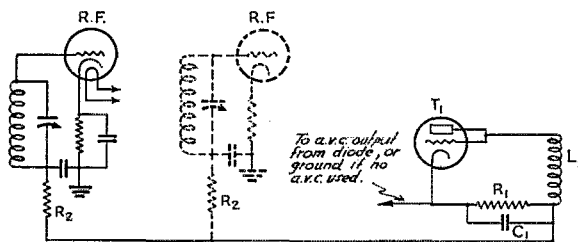

FIG. 1—THE CIRCUIT SUGGESTED BY W8JMI

C1—.002 μ f. by-pass condenser.
R1—100,000 ohms suggested for first trial. Experiment with particular set-up will be necessary.
R2—Decoupling resistors in a.v.c. system.
L1—Pick-up coil. Experiment necessary to decide on size.

diode—which may be any tube with the grid and plate tied together. The rectified current flows through R1 which is in turn connected in series with the a.v.c. lead to the r.f. stage or stages.

Here's how it works: The voltage across the diode from the pick-up coil is rectified and provides a high negative bias for the grid so that any transmitter r.f. getting to the first tube is stymied. The coupling to the transmitter should be rather close—uncomfortably close, it may appear. But the amount of power actually used is extremely small.

The tube may be any old thing in the shack and lit by either a couple of dry cells, a separate small filament transformer or the filament transformer used for the receiver. The unit could be fitted on the receiver itself or built as a separate gadget.

The scheme is, of course, the nerts for break-in or in any case where a separate receiving antenna is left attached.

* * *

Second Prize Solution

By Milton Lowens,* W2EZR

THE unfortunate fellow who is faced with your first problem would, with a little experience and some reading of the *Handbook*, discover the following:

- (a) Resistors generally burn out due to excessive current.
- (b) Tubes may fail for the same reason.
- (c) Modern receivers use cathode biasing almost exclusively.
- (d) The stand-by switch interrupts the high voltage supply and prevents the flow of current through screens or plates.
- (e) There will be no cathode current only when the grid is at the same potential as the cathode or negative with respect to it.

According to (d), (a) and (b) cannot be accounted for by any current flow in the plate or screen circuits. Item (e) remains for consideration.

The receiver input is necessarily in a very strong r.f. field. This naturally causes a high r.f. voltage to be impressed on the control grid of the first tube. This is a set-up almost exactly analogous to what happens to a Class-C r.f. amplifier with grid leak bias and plate voltage off. The rectified grid current will flow in the grid-cathode circuit and the higher the excitation the greater will be the grid current. Also, the lower the value of the grid-leak resistor the higher will be the value of the rectified grid current for a given r.f. voltage, limited only by the saturate current of the cathode. Now the sat-

* 284 East 206th Street, New York.

uration current of the cathode is a lot more than the average grid bias resistor can stand and moreover such rectified grid current values result in power losses at the grid which it (because of its small size) cannot dissipate. The result is that

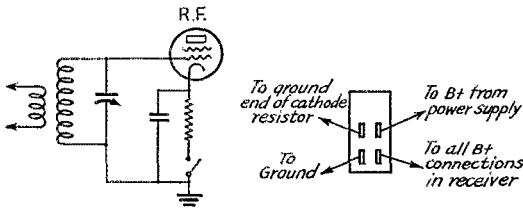

FIG. 2—THE SWITCHING ARRANGEMENT SUGGESTED BY W2EZR

The first sketch shows the placement of the cathode switch; the second, the wiring on the toggle switch.

the grid melts or releases gas or the cathode resistor burns out or both. The solution is to switch open the cathode circuit of the first tube of the receiver or perhaps the first two tubes. In order to eliminate the necessity for an additional switch, the normal stand-by plate voltage switch should be removed and replaced with a double-pole single-throw switch which can be bought for two-bits or so. One circuit of the switch is inserted in the lead from the cathode resistor to ground and the other is placed in the main high voltage feeder.

Of course, this system will not serve for duplex operation, but our hero, in common with most fellows, uses his well-adjusted and perhaps directive transmitting for receiving.

We have already outlined the scope covered by all the solutions received. By far the most popular scheme was the insertion of a condenser and leak in the grid return circuit of the first r.f. tube. Next in popularity was the connection of a switch between the cathode resistor of the first tube and ground. The third big group suggested neon bulbs across the input circuit. From this group we select two examples which might well go on the record. The first, submitted by W3BES, is an example of good practice in coupling the antenna to the receiver as well as a satisfactory method of getting

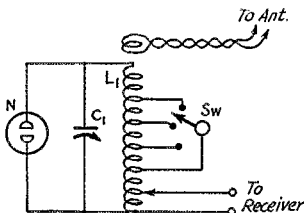

FIG. 3—AN EFFECTIVE WAY OF CONNECTING THE NEON BULB

L_1 and C_1 are any old coil and condenser that will tune over the required range. Bare wire is suggested for L_1 so that the necessary adjustment of taps will be simplified.

the neon bulb across a high impedance circuit without upsetting the receiver itself. The other selected idea, submitted by R. G. Raymond of Chicago, and shown in Fig. 4 indicates how some volts obtained from the bleeder in the receiver could be used to make a neon bulb break down with less r.f. input than it would otherwise take. The voltage on the bulb would be adjusted until it is just below the value at which the bulb extinguishes.

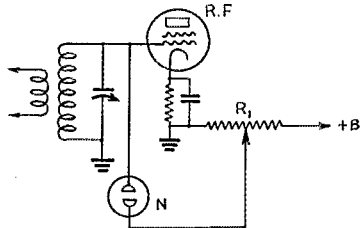

FIG. 4—SHOWING HOW A FIXED VOLTAGE WOULD BE APPLIED TO A NEON BULB TO MAKE IT FUNCTION WITH MINIMUM R. F. VOLTAGE

The idea could be applied, of course, to the circuit of Fig. 3.

And now for the third in the series of problems:

Problem No. 3

OUR hero is sick to death of the floppy push-back-wire links that he has been using between the push-pull driver and the push-pull final and between the final and the antenna tuner. He is in real need of a truly satisfactory method of making link coils and so mounting them on the coils that the coupling may be varied readily. In these tank circuits he is using plug-in coils wound on the heavy ceramic coil forms (the ribbed and notched ones that have a whole slew of holes through the wall). He definitely does not want to vary the coupling by changing the number of turns on the link coil since that would prevent him from playing with circuits of the kind described by W3CHO in the Hints and Kinks Department of last *QST*. Some mechanical arrangement is needed—something that will allow plenty of variation without seriously upsetting the symmetry of the push-pull tanks. The link coils are, of course, part of the coil assembly and the whole business is plugged in as a unit.

And here is the dope on the rules and prizes, repeated for the benefit of those who may have missed the last issue.

(Continued on page 104)

More on the Directivity of Horizontal Antennas

Harmonic Operation—Effects of Tilting

By George Grammer *

THE directivity curves for horizontal antennas given in November *QST*¹ can be useful in a variety of ways to the amateur interested in getting the most out of the antenna space available at his location. As we explained at the time, the directional data were presented in rectangular coordinates, rather than in the more customary form of polar diagrams, the reason being to give the data on as large a scale as possible without taking up an undue amount of page space. For planning antenna layouts, however, the polar diagrams are more convenient to use, especially in conjunction with an azimuthal map. The data can readily be replotted on polar coordinate paper simply by repeating the points given in the curves in each of the four quadrants, since when the wire is horizontal the distribution of field strength is symmetrical with respect to the antenna wire in all four.

By way of review, the useful radiation at the frequencies under consideration is at some angle above the horizontal, and the effective directivity of the antenna depends upon the angle which the arriving or departing waves make with the earth's surface in the vicinity of the antenna. If this is not clear, study Fig. 1 and the accompanying discussion in the November article until it does become clear, because without this concept it is impossible to understand what's going on in the back yard when the key is pressed.

Second, since the vertical angle has such an important part in determining the directivity of the antenna, it is important to know the numerical value of the angle or angles most effective in long-distance communication. We explained in the preceding article that, so far as could be determined from published data, an angle of about 9 degrees represented the optimum for 28-Mc. transmission, 15 degrees for 14 Mc., and 30 degrees for 7 Mc. Since we want to draw diagrams, we

have to pick some definite angle on which to base them, but this must be done with the understanding that no one angle is going to do all the work; rather, each of the figures chosen represents the center of a group of vertical angles, all useful. Thus, on 14 Mc., received signals have been found to arrive at angles as high as 30 degrees on occasions, and at lower angles than 15 degrees at other times.² Because of refraction in the ionosphere, the same signal may arrive at the antenna over several different paths in the vertical plane, so that it is even possible to say that the signal strikes the antenna at a number of vertical angles practically simultaneously.³ We could plot the

directivity pattern on such a basis, showing the directivity curves for the maximum and minimum vertical angles; the resulting plot would indicate that in certain directions the results may be expected to vary to a considerable degree. However, it is simpler and more convenient to plot for the one angle which is taken to represent average conditions, remembering that in practice a certain amount of variation is but natural.

Third, a point in connection with ground effects. When the antenna is horizontal, reflection from the ground does not affect the shape of the directivity curve, but only its amplitude. Waves reflected from

the ground simply reinforce or neutralize the waves radiated directly into space. The reinforcement or cancellation may be partial or complete, but will be the same in all horizontal directions so long as the ground characteristics near the antenna are uniform. It is therefore possible to neglect ground effects entirely in considering horizontal directivity, on the condition that the discussion is on a comparative basis only. By this

² Carter, Hansell and Lindenblad, "Development of Directive Transmitting Antennas by R. C. A. Communications, Inc." *Proceedings I.R.E.*, October, 1931.

T. L. Ecklersley, "Multiple Signals in Short-Wave Transmission," *Proc. I.R.E.*, January, 1930.

³ Bruce and Beck, "Experiments with Directivity Steering for Fading Reduction," *Proc. I.R.E.*, April, 1935.

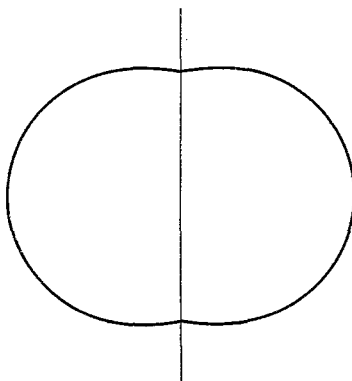

FIG. 1—POLAR DIAGRAM OF RADIATION PATTERN OF A HORIZONTAL HALF-WAVE 3.5-MC. ANTENNA, OVER A RANGE OF 30 DB, FOR A VERTICAL ANGLE OF 30 DEGREES

* Assistant Technical Editor, *QST*.

¹ "The All-Around Radiation Characteristics of Horizontal Antennas," *QST*, November, 1935.

we mean that we can say definitely, for instance, that with a given antenna the field strength to the northeast will be twice the field strength to the east for the vertical angle under consideration. We cannot say, however, that the field strength to the east at a vertical angle of 30 degrees will be a definite fraction of the field strength at 15 degrees. We can discuss the *relative* worth of the antenna at different horizontal directions, but not its absolute worth; it is possible, however, to compare two different antennas directly if they are at the same height above the same ground.

HARMONIC OPERATION

Although it was not specifically mentioned in the November article, the curves show readily the performance, directionally speaking, to be expected from an antenna which is used for work in several bands. The favorite 80-meter Zepp is a good example. On 3.5 Mc., of course, this antenna is a half wave long; on 7 Mc. it becomes a full-wave antenna, and on 14 Mc. a two-wave antenna. Figs. 1, 2 and 3 show polar diagrams of the directivity of such an antenna on the three bands, using appropriate vertical angles in each case. The 14-Mc. diagram is for a vertical angle of 15 degrees, the 7-Mc. diagram for 30 degrees, and the 3.5-Mc. diagram also for 30 degrees. In the last case, the optimum angle may not necessarily be 30 degrees, but is probably not less than that; for higher angles the pattern will change but slightly and will more and more resemble a circle as the angle is increased.

These three patterns cannot be directly compared to each other; that is, it cannot be said that the field strength in a certain direction on 14 Mc. will be a certain fraction of the field strength in the same direction on either of the other two bands. Not only are the vertical angles different, but the heights are also different in each case. Suppose, for instance, that the antenna is 66 feet high. Its height on 3.5 Mc., is a quarter wavelength; on 7 Mc. a half wavelength, and on 14 Mc. a full wavelength. Ground reflection, of course, is a function of the height in terms of wavelength. The patterns are therefore plotted so that the maxima are all the same value; this value has no significance in itself.

In drawing these diagrams it was considered better to plot the points in decibels below the maximum rather than to use arbitrary field strength values. This makes the curves agree more closely with what the ear hears, and also permits spreading out the scale so that it covers the most useful portion of the range rather than the whole. Zero (the center point) on these diagrams represents a signal 30 db below the value in the most favored direction, the range of 30 db being chosen because it represents about the maximum usable signal range (a power ratio of 1000 to 1). With constant conditions, it takes about 5 db to make a definite difference with medium-strength signals; with very weak signals a somewhat smaller difference is noticeable. As a general rule we can assign about 5 db to each S point, so that the full range on each diagram represents about the difference between S9 and S2 or S3.

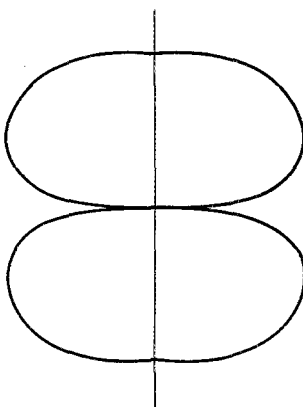

FIG. 2—POLAR DIAGRAM OF THE ANTENNA OF FIG. 1 WHEN OPERATED ON 7-MC. VERTICAL ANGLE AGAIN 30 DEGREES

Taking first the case of the antenna worked on its fundamental, Fig. 1, it is apparent that the directive effects, such as they are, are not very marked. In the direction of minimum radiation, along the line of the antenna, the value is only 8 db down from the maximum, which comes at right-angles to the wire. In practice it is probable that the difference would not be quite so much, since radiation at angles considerably higher than 30 degrees is effective. We might as well consider a half-wave antenna on 3.5 Mc. as being non-directive.

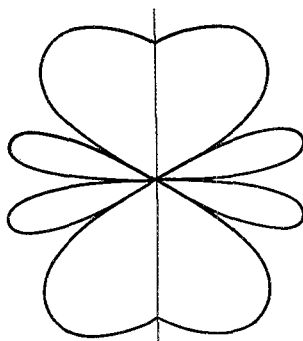

FIG. 3—POLAR DIAGRAM OF THE ANTENNA OF FIG. 1 WHEN OPERATED ON 14 MC. THE VERTICAL ANGLE IS ASSUMED TO BE 15 DEGREES

On 7 Mc., Fig. 2, the situation is changed by the appearance of nulls at right-angles to the wire. These nulls are real enough, but fortunately are quite sharp. Ordinarily they are masked in practice for two reasons; first, it is possible to work well with stations a few degrees on either side of the null, thus creating the impression that the antenna works well broadside; second, there is usually scattered radiation from objects near the antenna which helps fill in the nulls (but not dependably) plus the fact that the path of wave travel often varies a few degrees from the exact great-circle route. Off the ends of the wire, the radiation is down only 4 db from maximum, so that the antenna is practically as good here as at any point. In placing such an antenna (and this

applies to most simple horizontal antennas) it is far more important to line it up so that the nulls will do the least damage rather than to try to place the lines of maximum radiation to cover selected spots—assuming that the most effective performance in all directions, rather than to one particular spot, is desired.

FIG. 4—DIRECTIVITY CHARACTERISTIC OF A HORIZONTAL HALF-WAVE 14-MC. ANTENNA FOR A VERTICAL ANGLE OF 15 DEGREES
The Scale is in Decibels.

FIG. 5—CHARACTERISTIC OF THE ANTENNA OF FIG. 4 WHEN THE WIRE IS SLOPED 5 DEGREES WITH RESPECT TO EARTH

The 14-Mc. pattern, shown in Fig. 3, shows six null points, all quite sharp; so sharp, in fact, that it is very easy to get the impression that this antenna works well in all directions. Results will be less reliable, however, in the areas covered by the nulls, even though communication may be possible. If we take everything within 10 db of the maximum as the reliable communication area, we find that nearly 90 percent of the horizon is "covered." On a statistical basis, this would indicate very little directional effect. However, it's just as well to make sure the nulls point to places where there isn't any DX.

HALF-WAVE ANTENNAS

It is well known that because of increased directivity, long antennas will give a power gain, in the most favored direction, over a half-wave antenna orientated to give its maximum signal in the same direction. Unfortunately, however, the curve of power gain versus antenna length increases very slowly at first, only showing an appreciable rise when the antenna is five or six wavelengths long. Ordinary backyards

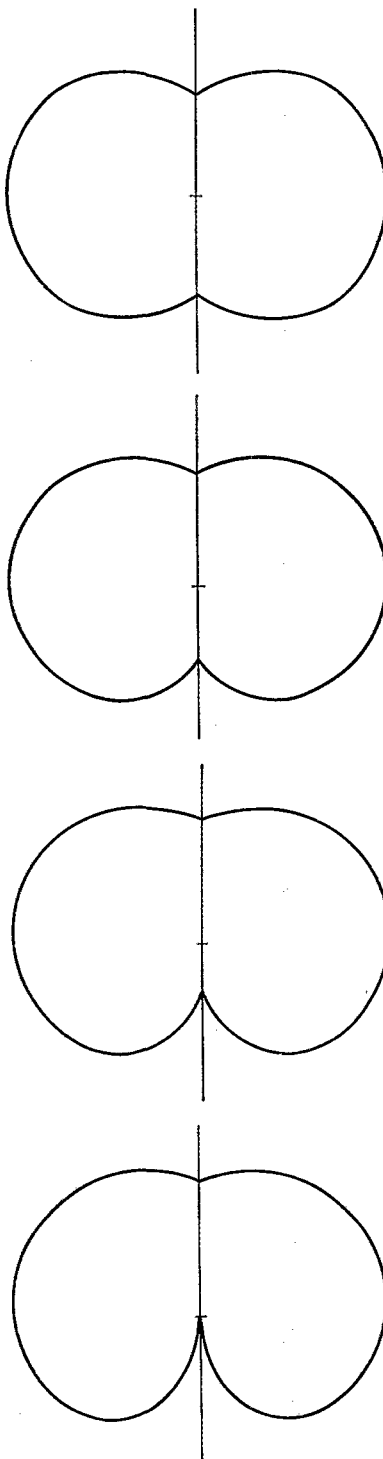

will not accommodate much over a 132-foot wire, even when friendly neighbors are willing to donate a little space. While this length is fine for working on several bands, on 14 Mc. the power gain over a 33-footer is only a matter of 2 db—a difference which is too small to be noticed in practical work. The man who wants to work DX on 14 Mc. therefore need not feel handicapped if he doesn't have much space—it takes quite a span of wire to give a worth-while increase in gain over a half-wave antenna.

There even may be some advantages in using a short antenna when a real directive array isn't possible. For one thing, at the usual radiation angles a half-wave antenna has no null points; there is radiation in all directions, although it is true the antenna is least effective in the direction in which it runs. Fig. 4 shows the directive diagram of a half-wave wire for a vertical angle of 15 degrees, again based on a 30-db range below maximum. Broadside to the antenna through an arc of 90 degrees, the drop-off in strength is only 3 db at the most; that is to say, if the antenna runs north and south, everything between

FIG. 6—CHARACTERISTIC OF THE ANTENNA OF FIG. 4 FOR A 10-DEGREE SLOPE

FIG. 7—CHARACTERISTIC OF THE ANTENNA OF FIG. 4 FOR A 15-DEGREE SLOPE

northeast and southeast and between northwest and southwest will be covered with practical uniformity. Directly along the line of the antenna the drop amounts to 14 db, which is 2 or 3 S points under the worst conditions and—when radiation angles higher than 15 degrees are effective—often less.

Uniform coverage of the

(Continued on page 92)

A 56-Mc. Crystal-Controlled Transmitter With 6L6 Output

By C. Harold Campbell,* W2IP

THE accompanying photograph and diagram of Fig. 1 show a 56-Mc. crystal-controlled transmitter which has been in operation at station W2IP for the past several months. Results have been so gratifying it was

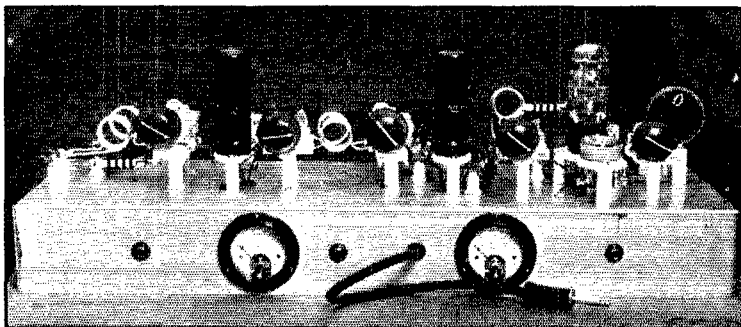

thought that by sending along this description, some of the gang might be tempted to junk their self-excited rigs. With its output power of 15 or 16 watts, it compares favorably with less stable transmitters of greater power and since only

is our old friend the 6A6 which has become very popular of late for its high output and low crystal current. The first triode section serves as the crystal oscillator on 14 Mc. while the second section doubles into the 28-Mc. band. This is coupled to a 6L6 metal tube which doubles to 56 Mc. and drives the final amplifier, which is also a 6L6 of the metal type. The use of a 14-Mc. crystal greatly simplifies the job of frequency multiplying and results in lower frequency drift in the 56-Mc. band.

Both the screen and plate of the final amplifier are modulated, the former through a 15,000-ohm resistor. A possible improvement in the system would be to use a modulation transformer with a special winding to modulate the screen. It was found necessary to neutralize the final amplifier. This presented no problem,

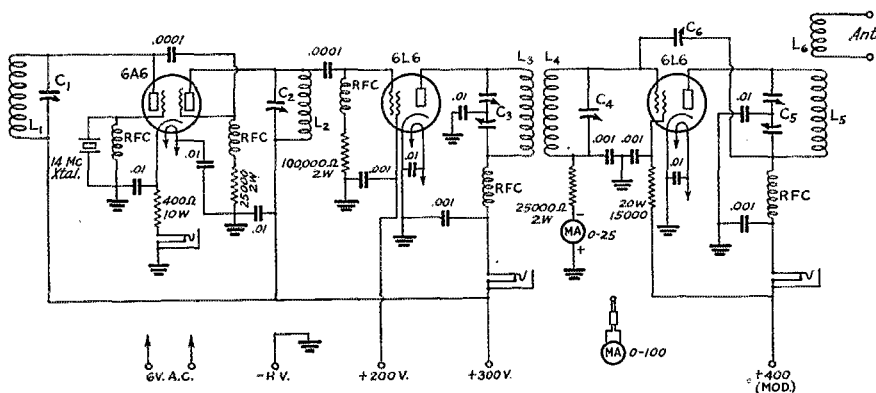

FIG. 1—THE R.F. CIRCUIT OF THE 56 MC. TRANSMITTER

- L₁—5 turns No. 16 d.s.c. wire, spaced diameter of wire, on celluloid coil form 2 inches in diameter.
- L₂—7 turns No. 12 bare copper wire, 1-inch diameter.
- L₃—5 turns, same as L₁.
- L₄—3 turns, same as L₁.
- L₅—5 turns, same as L₁.
- L₆—4 turns, same as L₁.

- C₁—100- μ fd. (Hammarlund MC 100S).
- C₂—50- μ fd. (Hammarlund MC 50S).
- C₃ and C₅—35 μ fd. each section (Hammarlund MCD 35X).
- C₄—20 μ fd. (Hammarlund MC20S).
- C₆—5 μ fd. (Cardwell ZV5TS).
- RFC—2.5-millihenry r.f. choke (National Type 100).

three tubes are used in the r.f. section, the outfit is little more complicated than the average transmitter used on the lower frequencies.

It will be recognized that the crystal oscillator

however, a very small capacity being required and the adjustment not critical. At W2IP, this amplifier operates on 400 volts and the plate current dips to about 25 ma. with no load. With

* 16 Millington St., Mt. Vernon, N. Y.

(Continued on page 122)



STRAYS



In Memoriam

Just for a bandfull of blaa blaa he left us,
Just for a mike to set on his desk.

Assemble, oh ye hams, with muffled tread. The great saga of the cottonfields—master extraordinary of the queen's English—grand poobah of all Dixie—arch advocate of the pumphandle—he, ole Squinchowl Jones, of all hamdom, is to forsake us for the squawking fone. Let no jasper raise his voice in protest—the evidence is conclusive. Rotate yer eyeballs in a downward direction and gaze, with what pity you can command, upon the mortal remains of that once majestic champion of the arcing key.



DIXIE (SQUINCHOWL) JONES

Bowed by the weight of countless squinchowls he leans
Upon his desk and gazes at his mike,
The emptiness of ages in his face,
And on his brow the curse of every splatterbug.
Who made him dead to dots and dashes?
Whose breath blew out the light within this brain?

For years we have been duped by Dixie's agile
ability at procrastination into believing him to be
the heart and soul, the champion, the leader of
that once far-flung legion of the pumphandle.
'Tis a bitter pill indeed; but, truth will out.

The candid camera snaps; and, having snapped,
Develops; nor all his ravings nor wit
Shall lure it back to cancel that exposure,
Nor all his tears (drip, drip) wash out one line of it.
—From "The Yaller Spider,"
Fifth Corps Area, A.A.R.S.

A conscience stricken editor approached W4IR
after seeing the above set in type, knowing it
could not be so. If 'twere so, Dixie deserved a few
words of consolation or congratulation and these

were sent forth. We present the mild explosion
that resulted:

Sir:

In the intrust of truth and justis allow me to
state that you have grabbed the rong sow by
the ear when you state, as you do, in effect, that
i yam in for some happy moments that i ain't
had none of yet on account of because youall
harbor the hallucination that that there pic-
ture of me is the real meeoy and that i yam on
fone as it looks like i yam but such is not the
case. I ain't on fone, i ain't been on fone ever
and i ain't ever going to be on fone so help me
billy sunday. Here is how the tragedy occurred:
last thaaxgiving i coulda stopped in Memphis
which is still in God's Country, but NO, i had
to be daring and reckless so i bulged over
across the river into the uncharted wilds of the
7th corpse area and while i was a standin there
lost in admiration of the forest primeval and
watchin the woggle birds flitting among the
tamarisks and the mamma rhinosserrhosses
cooing to thair young wye the fust thing i
knowed three big arkansaw gorillas fell out of
a tree on me and drug me to thair lair which
was W5SI's shack who is one of yore dang
directors the big egg and i was brutally forced
to swaller four five cans beer outa his icebox
and then here comes some horses knecks on
the rocks and i was a settin there a holdin my
scooper of scat in my mitt and not payin no-
body no mind and a big gorilla by the name of
W5BMI and another anthropoidal monstros-
ity by the name of W5IQ snuck up and took
my picture, the one you see, and you can shoot
me for a dang fone man if it didnt turn out to
be a mike i was a holdin' insteada my scooper.
i yam mortified. i rite you this so the great qst
will no the truth.

—W4IR.

W8GWY writes that in case of necessity it is
possible to cut a small portion from an isolantite
socket by careful grinding with a power-driven
carborundum stone.

The height of something or other was the per-
formance of a W3 heard the other night with an
R9 signal in New England. Giving himself a little
"bug" practice on the air, he picked a QST
article on reducing QRM by the use of dummy
antennas as a text for transmission! Merely one
of the many who contribute to the w.k. jam on
40.

Navy Day Competition—1936

ON OCTOBER 27, 1936, radio amateurs of the United States participated in the celebration of Navy Day for the twelfth consecutive year by copying a message from the Secretary of the Navy in the annual A.R.R.L. Navy Day Receiving Competition. This message was transmitted from NAA (Washington) and NPG (San Francisco) and was copied in 46 states, the District of Columbia, Hawaii, Canada, Canal Zone, British West Indies, and aboard several ships at sea.

Letters of commendation signed by the Secretary of the Navy were offered to all operators making perfect copy of the message text. Interest was extremely keen! 836 operators submitted copies—a participation 79% greater than the previous high. 434, or 52% of all contestants, made perfect copy and won a letter from Secretary Swanson. The Honor Roll lists all who submitted copies. Congratulations to those winning letters! A tabulation showing number of participants, number of perfect copies, etc., by Naval Districts, is presented to give a complete picture of nationwide interest and results.

The two stations (NAA and NPG) provided excellent coverage with good reception of at least one station reported from all quarters. Speed of transmissions was approximately 15 w.p.m. NAA's signal strength varied, due apparently to some condition at the transmitter. It proved very disconcerting to have the strength drop from S9 to S3 or so, and go back to S9, and repeat this whole performance several times during the transmission! More than one operator thought his receiver was "acting up" and frantically tried to locate the trouble and copy the message at the same time. In the NPG transmission the tape jammed in the sending of the signature, but this was corrected by the operator in charge.

Copy of NAA was made by VP2SL, British West Indies. . . It is natural for sea-going operators to take an interest in Naval activities. Numerous copies of the Navy Day message were made aboard ships. W6LGZ copied NPG while aboard the Flag Ship U.S.S. *Wright* at French Frigate Shoal (Lat. 2345-N, Long. 166-13). . . W2FDM made his copy of NPG aboard the S.S. *Chattanooga City* about 1137 miles southwest of San Francisco. . . W7FE and W7WU made their copies (NAA and NPG respectively) aboard the S.S. *President McKinley*, approximately 1200 miles at sea out of Seattle bound for Yokohama, Japan. . . W4CVZ was aboard the U.S.S. *California*, off the coast of California. . . W6BLZ was on the U.S.S. *Pensacola*. . . W8CEU was on Lake Huron aboard the Steamer *John W. Boardman*, KFMIN. . . W4AKH took part in the competition while on the S.S.

Fairfax, off St. Augustine, Fla., while W4CMN did likewise aboard the S.S. *Carolyn*, WKCA, about 100 miles north of Porto Rico. . . En route to Honolulu, about 500 miles west of Los Angeles, W6EYZ made his copy on the S.S. *Montebello*. . . For the fifth consecutive year

1936 NAVY DAY MESSAGE

On Navy Day each year it is my pleasure to address a few words of greeting to our American radio amateurs. We transmit these greetings through our Naval radio stations at San Francisco and Washington in order that they may reach as great a number of our forty-six thousand licensed amateur radio stations as possible. The Navy has always been highly appreciative of your patriotic and friendly cooperation whenever emergencies resulted in calling upon you for voluntary service. During hurricanes, floods and other disasters the amateurs have cooperated with our Naval Communication Reserve and made a splendid record. The best wishes of the Navy are extended to all.

CLAUDE A. SWANSON
Secretary of the Navy

(This is the text of the message transmitted from NPG; it is not, however, presented as an identical copy of what was sent—punctuation differs from the original. NAA's text was a paraphrase of NPG's.)

W9AIR copied the Navy Day message aboard a Mississippi River boat—this time the *Mark Twain*, W1EY, in the harbor at St. Louis, Missouri. . .

Looking ahead to coming receiving competitions it is in order to urge all operators to use the utmost care when transcribing what they copy. In the 1936 Navy Day Competition it was evident that errors were made when operators recopied. We could discuss at length some of the amusing mistakes caused by "guessing"! Don't do it, fellows! Simply copy what you hear and send in what you get—don't try to pretty it up by changing it to what you "think it should be."

—E. L. B.

1936 Navy Day Honor Roll

Letter Winners

First Naval District: W1AED W1APR W1AQW W1BB W1BDV W1BEC W1BOR W1BYR W1CJP W1DMG W1DUK W1EF W1ELL W1EOB W1EYS W1FAK W1FI W1FPP W1GNF W1IIB W1IIC W1IKU W1IMD W1IP W1IYC W1JAH W1KBG W1KDI W1KH W1PV W1RY W1RZ W2FEF/1. *Third Naval District:* W1ASP W1FNM W1GKM W1HSL W1HXZ W1ILI W1MY W2AA W2ALZ W2APO W2BC W2BDR W2BLL W2BNJ W2BVJ W2BZJ W2COI W2CQA W2CYX W2DBS W2DBQ W2DLI W2EWR W2FLD W2GGW W2GMS W2GTA W2GTW W2GVZ W2HDT W2HHG W2HIG W2HJT W2HNC W2HPT W2HSE W2ISJ W2JBL W2JEQ W2JMO

Naval Districts	Number of Participants			Number Making Perfect Copy			% Perfect Copies	Number of Copies Submitted		
	N.C.R. ¹	Non-N.C.R. ¹	Total	N.C.R. ¹	Non-N.C.R. ¹	Total		Of NAA	Of NPG	Total
First	31	36	67	15	18	33	49%	54	24	78
Third	67	69	136	39	31	70	51	103	46	149
Fourth	36	38	74	17	16	33	44	61	18	79
Fifth	11	30	41	5	13	18	44	36	10	46
Sixth	2	3	5	1	3	4	80	5	1	6
Seventh	16	12	28	11	6	17	61	25	7	32
Eighth	33	49	82	18	26	44	54	49	49	98
Ninth	78	141	219	37	78	115	52	130	110	240
Eleventh	13	41	54	7	30	37	68	10	48	58
Twelfth	29	26	55	15	12	27	49	9	52	61
Thirteenth	12	36	48	3	22	25	52	8	45	53
Fourteenth	2	2	4	1	1	2	50	..	4	4
Miscellaneous ²	..	13	13	..	9	9	69	5	8	13
Totals	330	496	826	169	265	434	52	495	422	917

¹ The number of N.C.R. and non-N.C.R. member participants was determined as accurately as possible by examination of copies received.

² Miscellaneous includes those aboard ships too far distant to attach to any Naval District, and participants in Canada and other outside points.

W2JPE W2JSL W2LA W2QY W2VP W3CZL W8ABX W8ANQ W8BEN W8BPJ W8BSL W8DOD W8EMW W8EWP W8EWT W8FU W8FYH W8GFP W8JGX W8JQE W8JUJ W8KQI W8KXA W8NVK W8OXE W8PK Frank B. Fucile, Stephen Gasparovitch, Carl O. Petersen, William J. Rowe. *Fourth Naval District:* W1BFI/3 W1CHF/3 W2BBK/3 W2FRF/3 W3ADE W3AKB W3CBF W3DRO W3EC W3EGL W3EMN W3ETM W3FFE W3FIG W3FTK W3FTR W3FVX W3QP W8BWL W8FUW W8HHM W8INA W8IUY W8KRT W8KUN W8NJK W8OEM William F. Miller (W8PLX) W8QAN W8QBK W8QEA P. F. Long, John A. Schuenger. *Fifth Naval District:* W1BGL/3 W3AEA W3AU W3BRK W3CMV W3EEN W3EWP W3FAE W3GDS W3GFF W3GKN W3GKU W3GKZ W4BJV W4CQ W4DW W8EYP/3 W8PSR. *Sixth Naval District:* W4BDT W4BRG W4DIA W4GY. *Seventh Naval District:* K4BU K4KD K4RJ W4AFC W4AGR W4AHZ W4AKH W4BCJ W4BEQ W4CZS W4DAP W4DBG W4DVO W4EHZ W4ZU W6LYR/4 Julian T. Webber. *Eighth Naval District:* W4ABY W4AFM W4AFI W4AKJ W4APU W4CED W4CRP W4EIC W4JN W4RO W5AAI W5ASD W5AUC W5AUL W5AWT W5BBR W5BCW W5BJ W5BKU W5BMI W5BUB W5CPB W5CPT W5DOM W5DWN W5EGP W5EOE W5FAJ W5FDR W5FJ W5FLW W5FM W5FNV W5FOX W5TQ W5OJ W9SN/5 John S. Bee, George A. Greene, Bradford Hearn, Otto J. Nilson (W2FW), J. W. Smith, C. G. Stokes, J. H. Wilkins. *Ninth Naval District:* W1CU/9 W8AQ W8AXV W8BAH W8BBI W8BKE W8BKM W8BON W8CHO W8FX W8FXH W8GKG W8GUN W8HA W8HKV W8HS W8ISK W8KZU W8MTE W. O. Gassett (W8NQS) W8ORF W8PKZ W8PO W8PP W9AHY W9AKP W9AKT W9ANB W9ANV W9AQX W9ARH W9AUH J. H. Cartwright and J. W. Hudgins (W9BNT) W9BQM W9CDA W9CGS W9CSJ W9CUH W9CWR W9DEB W9DJA W9DQL W9DRE W9DUO W9ECZ W9EDQ W9ELL W9EMN W9END W9ERS W9EVA W9FNQ W9FTJ W9GAF W9GMT W9GTG W9HIN W9HSK W9HYI W9IQP W9JZH W9KBR W9KMN W9KOC W9KZL W9LGZ W9MFI W9MYL W9NDB W9NVF W9NZG W9OLF W9OQ W9OQV W9PTT W9PLK W9PZU W9RGT W9RH W9RSO W9RJT W9RYZ W9SES W9SGT W9SKF W9SQI W9STG W9STQ W9SZL W9TGN W9TKX W9TMI W9TQZ W9TWC W9UCO W9ULQ W9UT W9UYP W9UZ W9VEE W9VFW W9VXB W9WDS W9WKM W9YPI Clarence E. Childers, Robert H. Clarke, W. H. Corbett, Clarence S. Granquist, W. J. McGuffage, Fred L. Schoenwolf, W. J. Wagner, Lynn Cunningham Wilson. *Eleventh Naval District:* W5ENI

W5ZM W6ACL W6AGF W6AM W6BMC W6BNO W6BQI W6BYD W6BXI W6CYS W6EC W6EQW W6FJK W6HG W6HID W6HLW W6HOS W6IOX W6LWX W6LZ W6JLU W6KHE W6LKB W6LTM W6MRT W6MTP W6NCJ W6NHZ W6OEJ W6RL W6WV W9CIW/6 W9RVU/6 George A. Hall, James R. Harding, Warren A. Simmons. *Twelfth Naval District:* W6AHK W6BLZ W6CDA W6CIS W6CZU W6DIY W6EJT W6EUI W6FBW W6FII W6FPW W6GBT W6KMS W6LMZ W6LWZ W6NAO W6NCF W6SM W6WF W9CAA W9FA W9LQO W9MKN W9PVZ W9SBB W9TEJ W9TSQ. *Thirteenth Naval District:* W7AF W7AJ W7ANV W7AXJ W7BHL W7BQS W7BRT W7BSU W7BVJ W7CAB W7CQE W7CRH W7CZC W7EAW W7ELF W7EOH W7FCM W7FQH W7HD W7JY W7LD W7NO W7RT W7WY F. B. Dyer. *Fourteenth Naval District:* K6AJA K6MZE. *Miscellaneous:* Raymond R. Bourret (K5AY) NY2AB VE3SA VE5OK W2FDM W4CVZ W6EYZ W7FE W7WU.

The remaining 392 participants on the Honor Roll follow. They are classified by Naval Districts and are listed under their respective districts in the order of rating. Where calls or names are connected by dashes, it indicates that these participants have equal ratings and are listed in a group, alphabetically and numerically:

First Naval District: W1ABQ-W1AHN-W1AJK-W1APP-W1BYP-W1CBN-W1DJQ-W1EEY-W1FNY-W1HWE-W1HYR-W1IJJ-Gilbert Badger-Eugene B. Petit W1ATO-W1BMW-W1ILN-W1ILO-W1JGP-W1MT-Karnig Nalbandian W1BTM-Manley W. Haskell W1ABG-W1BEH W1BPN W1DGV W1JID-Louis Tangherlini W1HVH-W1JOW W1FCX W1JCK-W1LM. *Third Naval District:* W2ALD-W2ALL-W2BCB-W2BJP-W2BMM-W2CJX-W2CP-W2FAR-W2FFL-W2HII-W2HYC-W2IOH-W2JJE-W2KW/CCD-W8AFE-W8AQE-W8DZU-W8LVZ-Edward G. Graf-Harold F. Meyer-J. B. Stucky, Jr. W1DSB-W2CIT-W2CJP-W2EDI-W2HXT-W2HZY-W2IDY-W2IME-W2IQM-W2JAL-W2JFS-W2FCQ-W3ZL-W8SFF-W8GWZ-W8QFE W2BZM-W2FKE-W2FOH-W2WP-W3EWI-W3SW-W8FUE-Walter J. Malone W1CEJ-W2AUP-W2FKL-W2JKY-W2JQ-W3EUX W2ELD-W2GTM-W2IXQ-W2KAK W1EEV-W2FJ-W2IBD-W3CTI-W8PLR W8PUM W2FZY W8PYQ W8COD W2BAI W8AOR. *Fourth Naval District:* W3AJF-W3AJS-W3AR-W3AUE-W3EOM-W3FDH-W3FJZ-W3FFG-
(Continued on page 104)

The 1937 Governors' to President Relay

By E. M. Williams, W3ER*

THE 1937 G.P.R. results indicated a modest betterment over the 1933 Relay. A total of 39 state governors were heard from against 35 in 1933. The same number of territories came thru, i.e. Alaska, Hawaii, and the Virgin Islands. In addition, President Quezon of the new Commonwealth of the Philippines responded with a nice message. The 9 missing states were Maine, Vermont, Florida, Iowa, Mississippi, Kentucky, Michigan, Louisiana and Wyoming. A.R.R.L. SCMs designated stations to obtain and start messages. The routings are shown in a summary appended to this report.

Most of the messages came thru on 80 meters over trunk lines and nets, as was the case in 1933. This year, the 40-meter band did itself right proud by grabbing off at least 10, which is 10 more than came thru on 7 Mc. in 1933. If we count W3CXL on 6990 it's 5 more. Twenty meters was out of the picture; not a message came thru on that band. After sending out a CQ GPR on 7 Mc. we had a number of replies asking what GPR meant! The snappy comeback to these queries was "read page 12, Jan. QST, 73. . . . -" The writer worked about every district on 40 meters that night including several of the missing states. In each case the station worked knew nothing about the message.

It is interesting to note how history repeated itself in the handling of a number of the messages. In 1933, the Georgia message came thru on 80-meter phone from W4KU. This year, W4KU was again the man at the mike with the Georgia message. W1AFB was the same man to put the Conn. message into Wash'n. W3ZI was on deck in 1937 as well as in 1933 for New Jersey. W8CZ was the West Virginia brass-pounder who came thru again. W4DW likewise was the same originator for North Carolina as was W5CJP for the state of New Mexico, in '33 and '37. Believe it or not, K4AAN in the Virgin Islands was on deck again. We wonder if these fellows have been idling their filaments all these months waiting for this GPR?

W3GKU, the Club Secretary, went on the air for the first time with his new T-55's. No G.P.R.'s handled and he missed an OZ and an SM who

heard him. Is his face red! As in 1933 W3CDQ had the important but thankless job of typing up most of the messages. The task put her in bed with tonsillitis. What price GPR?

The 80- and 40-meter bands were well covered by member-stations. On "40" members hoped to bring messages in direct from the far western states. About 5 stations were active on "80" and 12 on "40." The following were the successful message catchers: W3BWT—23 (all on 3.5 Mc.), W3FQB—5 (7 Mc.), W3FSP—4 (1 on



© Underwood and Underwood
THE WASHINGTON RADIO CLUB PRESENTS THE STACK OF INAUGURAL FELICITATION MESSAGES IT RECEIVED VIA AMATEUR RADIO FOR PRESIDENT ROOSEVELT

Standing, left to right: James L. Holmes, W3GKU, club secretary; Miss Elizabeth Zandonini, W3CDQ; C. M. Godfrey, W3CYO, club vice-president; Eppa Darne, W3BWT; Lieut. J. H. Nichol森, N3EEN; R. E. Macomber, W3CZE, club treasurer, and Roy C. Corderman, W3ZD, who delivered the G.P.R. messages.

3.5 Mc., 3 on 7 Mc.), N3EEN—3 (3.5 Mc.), W3FRB—2 (3.5 Mc.), W3ZD—1 (7 Mc.), W3FPQ—1 (3.5 Mc.), W3CDQ—1 (the first on 7 Mc.). Non-members of the Club cooperated splendidly, and got 10 more: WLM/W3CXL—5 (6990 kc.), W3COJ—2 (3.9-Mc. 'phone), W3ELN—1 (3.5 Mc.), W3FQZ—1 (3.5 Mc.), W3BKZ—1 (3.5 Mc.). The following did not get any of the elusive messages, but credit goes to each and every one of them for their efforts and time spent helping: W3CYO, W3ESP, W3AWS, W3GKU, W3GGX, W3DXJ, W3FVD, W3EUJ, W3EZN, W3ER.

Ep Darne of W3BWT explains that the large

(Continued on page 86)

* President, Washington Radio Club, 5316 N. W. 43 St., Washington, D. C.

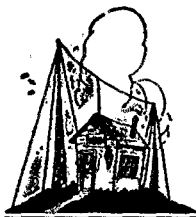

Amateur Radio STATIONS

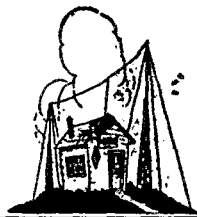

W5ZA, Roswell, N. M.

WE SUPPOSE the town of Roswell, New Mexico, has some just claims to distinction in the world of commerce and industry, but confess to complete ignorance on that subject. In ham ranks, its fame rests on the fact that it is the home of W5ZA!

Memories of old timers need no prodding to recall the days when Louis Falconi and 5ZA were the link between East and West, nor the part played by this station in the record-breaking



Transcons of 1921. Nor, indeed, the fact that 5ZA was the station to win the first Hoover cup, awarded in 1922 for "the best all-around amateur station, the major portion of which is home-made." Those achievements are part of the history of amateur radio.

In these days of split-up frequency bands it is well-nigh impossible for any one station to be as well known to the whole gang as it was when we were all on "200". The result, therefore, is that a station becomes outstanding only in a particular group having common interests. Such is the case of present-day W5ZA. Working practically entirely in the 20-meter 'phone band, its call is familiar to all who do any operating in that region. Knowing, therefore, that it will be of inter-

est to a great many hams, we are pleased to present a photo of the rig now in use, even though Louis warns us that it's likely to be rebuilt in the near future.

The main part of the works is on the rack at the left. The r.f. end of the transmitter consists of a 59 oscillator, 46 doubler, a pair of 825's as drivers for the final, and the final amplifier itself using a pair of 852's. Input to the final is 400 watts. This rack also contains the modulator, using a pair of 203-A's, in Class B.

Receiver, speech amplifier and controls are in the enclosed rack immediately behind the operating table. The receiver is an FB7. In the speech end, a condenser microphone works into a 5-stage amplifier-driver; the first speech tube is a 2A6 working into another 2A6 which in turn drives a 27. The 27 is coupled to a pair of 27's in push-pull; this stage excites the drivers, four 2A3's in push-pull parallel. The output of the driver is coupled to the modulator through a 500-ohm line.

The antenna now in use is a 66-foot center-fed Hertz (two half-waves in phase) with series-tuned feeders. We don't know how W5ZA stands on DX these days—or whether they ever go after any—but the station certainly does a good job of covering the country. And with Eunice operating, it can't help but command attention!

W9WFFV, Rifle, Colo.

W9WFFV is the latest of a series of calls held by A. D. Middleton, perhaps best known to the gang as 8UC and W4CA. Because changes in location frequently are necessary, the rig has been built up as an easily-transported affair, and is arranged to occupy the least possible amount of floor space while offering operating convenience.

The rack which contains the whole station is six feet high, and approximately 26 inches wide by 13 inches deep. Shelves and slides are provided for the various sections, and a desk leaf swings out for the operating position. The transmitter, built

(Continued on page 102)



CALLS HEARD

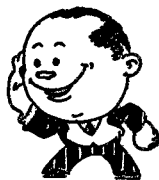

J. M. Hart, Jr., U.S.S. Pigeon, % PM, San Francisco, Calif.

(Heard at Tsing Tao, China, Oct. 1st, 4th, 7th)

er9aa k7pt ka9ne uk3aa uk3eh ve2gj w2la w4eok w5eef w5frl w6ahj azo ezv gaaq gk hlf lep leb lwd nem oaq oul wvl w7euy fdc w9ukf

F8RJ, Guy Grossin, 11 bis rue Miss Edith Cavell, Courbevoie (Seine)
(28-Mc. band)

w1aak alb ayx bux cfd coi csr df duk fdn fh fmq hio hun jiz kad ts tw w2aog ber bpd eko gjd jmq w3auc axu bop enx ghs pc w4bbr ef w5dqd w6jju grl w8bti cky dod ixs iwg w9adn csi dwu hsc ny pit uqt ve3adm er lu ty uf zshl zt2b

W6NSV, E. C. Gessert, Jr., Westminster College, Salt Lake City, Utah
(28-Mc. band)

f3kh 8kj eo et g6ir dh lk 2tm pl vk2ki pa0un pa0oz oz2m j3fz dc d4ijh oh5ng ym4aa

W3QM, Louis Wisniewski, 2443 East Indiana Ave., Philadelphia, Pa.
(14-Mc. band)

yr5ae ni ok or rr sg yt7kp vn sv1ke ym4af uk3aa lx1ao zblc zb1h su5nk fb8ad zp2ac vr2ab vr4ba pk1bx pk1jr pk1pk pk1ra pk3bm pk3wi j2ccj kj lu me 3cr fi 5cc kalap fs lb md vu2eq xu8op mx2b

VE5HR, H. R. Hough, 1785 First St., Victoria, B. C.
(14-Mc. band)

d3ben dxu f2i bmp den gkr dlc 4gjc aec arr xcy zpi xcg tpj dmc tkp ea1bc e1sf e1fr esse f3lk 8ai eb eo kj uk ex g2tr pi bk as xq xn xk 5li rv to qy il ms gq ym jw 6ir nj vp xi rh zu yu 8el haf3d hb9ak bd iltkm ly1j oel1h 3fl oh3np oi 5nr od ul ok1zb 2hx og rx on4au fe vw ox2h m 3d 7c ss pa0az jmw mq rnzx sm5uu 7uc ulad ap bl en 2ne 3as dq ym4aa yrsat ea8an fa8bg fb8ab af su1ac zslah 2x cr9ab hsl1pj j2mh jj lu ce el cb kj nb 3fk fu fi ek 5cc ce 6dk 8cc ef kalan me rb ts us mx5ta pk1bx jr pk 2du 4rf u9mi ml vs1al 7rf vu2eq dy 7rl yr2ff cetaq 3ar 3el eplaa 3ane cx1ce cx hk3hb pj4ap yv4ac 5ap cz2g yn1aa

(28-Mc. band)

d4buf cdm xjf f8am eo kj ni g2pl 5is fv nq oj 6dh nf wy ok2op oz2m pa0az zk

G6YL, Miss B. Dunn, Felton, Northumberland, England

(Heard on a 2-tube receiver)
(28-Mc. band)

w1aak aep ajz av avv bvl coi epm csr dma dbe duk dhd ebr elr fdn fh hio iasicaob hpe kh lz tw wv w2aog aoo afu axt eko epa eto dtb dvy dwn epr giz hfs hmd is kp jxz ju mb za w3air anh cyk eic eys evt far fre md pc vb w4ada ajx ef ft w5afx bee bsy dqd dqd drf dca ebt ehm ejj fhj fqn lw w6azp bam boy bxv bmw djj dob dtb due fmy fqy fzl fzq gcx gel grl grx guq hx fjf jju jna jnr kev knf mfr nep nhe nqw nya pn qd w7amx dzx dzx ewd eye w8bix btk cjm era eqq fem itk jfe jlk fh msl mwy oke osi w9bmx bqh byy bye dxx ef eym ghy huv iew isu lbb mtn ny owu ped rh sie

sii wda ve1ci dg dz 2ea dc ka 3adm du er kf lu ty uf wa 4du jv ph tj to vo1n vk2ae gu 3bq cp hm su xp yp 4ap bb ei shw my 6aa ca vu2au vs6ah k5ac lu1ep 3dh 6ax 7az 9bv hp1a j3fj oa4j pk3st py1br py1de py4bl u9mi on4cjj ti2ea zefay zel1b jf jj jr ju zlldv 2bp pe 3dj zshl zsuu zt2b 2q 5v 6ak k m y zult 5b 6e l p en8mi en8mq fa8bg fa8cr fa8jo fb8ab fb8ws ft4aa ac ae ag al su1ch ro sg u9mi ulad en 2ne 3dx uk3kg

(14-Mc. band)

w6gpb w7bsj etk eye fb8ad ve5mr ve5ra zeljs zeliz zsb6 zuld.

W6EA, Howard Seefred, 343 So. Fremont Ave., Los Angeles, Calif.

(Heard on a det. and 2-step receiver)
(14-Mc. band)

em2ad ai ao da jw md 7ai eplaa cx1bg cx1fb d4gwf ea4av ea8ao f8pz g2pl g2ww g6ag g6my g6nj hb9j hel1w hh1p hh3l hj3aj haf4k j2el is kj lk ll lo lu me mh mi dp fj fk 4et 5ce 6lj j6dk k5aa ac ag am ar ay k6dv eo nj k7ua ka1an aq rb rr us lu1ab ca ch lu2ax lu5ue lu7bh ef ek lu8di lu9ax ly1j ny2ab ny2ae oa4j q u z at oel1h oh2ob oh3oi ok1be ok2ak ok2hx ok2rs oz2m pa0qq pk2ko pk6aj py7aa sm5uu sm6wl sm7qa splba ti2rl velae ea ep kk vk2ae as ap aa bd bp da di dk eg eo ex fy fx hf hp hv hy ia ig iq ks lx lz mh mn my ny ot ow px qe qk sq td tf ti to va wr ww xs zt 3cn ep ex df dp eg gp gu hk jr jt kk kr kx mr or cj uf uh ww xp zz 4do el er gk hr jc ju jx kx le lm lw us 5cm jc mz wj wk wr 7jb vp2am vp7aa vs1aa vs1aj vs2ag vs6ah vs6ak vs6bd xelam xelay xeldd xu8ag yu7dx yv5aa z11aa ao ar ek cv di dm ds dv fe gx hh hy ke lm lv2bp bx ci ep ew ds ka hr ii ja jq kd kk kn mf mr oq pv qa qm ti 3ab az es dj gn gr ja kg ks lae ao bq ck fk fo fs zslid zsb2a zsz2x zsz4u zslah zslaj zslal zslax zt6q zu6e zu6p zxmz zsz2a

HB9J, J. Lips, Klosbachstrasse 87, Zuerich 7, Switzerland

(28-Mc. bands—Nov. 15th—Dec. 13th)

w1kh aep dze jmx coi hio ak w2dtb fwk gjk iiq tp bwc w3enx md fmq cbv w4rx w6flz jju hb w8ksl ifd amn jah gh jrl jak w9adn ghn bpu pst ef ces vrd lz vit fs esi jnb en8mq y1zbb oheng 3oi 3op 3np 7nd 7nj 7nf 7nc 5nr sulsg eplac (8-Mc. 'phones)
w2hmd jkk w3axr aib w4dsy w8agu ebo mwl w9bch

W4AG, Morgan H. Grawlee, Kennedy, Ala.

(28-Mc. band)

g2dh g2hx g2np g2pl g2xc g2xv g5bm g5by g5bz g5fv g5ju g5kh g5mw g5oj g5qy g5sy g6cm g6lk g6nf g6pl g6rh g6wn g6yl f8et f8eo f8ob f8ql f8sn i1kn i1mn i1un ok2op ok2rs ok3va on4mmv on4nc pa0am pa0a2 pa0uh pa0lf d4buf d4cdm ze1jr haf8c y12ed g6tk sulsg et1kh f3dm zt6m vs8aa vk2gu

(28-Mc. 'phones)

w5aer aht azp bdd bmw djj dzh eop fkg fqz hx ibs iwy kzu lul mdn met mbd nep nfa nif ntf oif uf w7bfa bxu eqt ebn edx fqk

W1ABG, Lowell, Mass.

(3.5-Mc. band)

g5ju g6wy hb9ad hb9y volp ti2wd (phone)

(Continued on page 68)

HINTS and KINKS for the Experimenter



Screen Voltage for the 6L6

SCREEN voltage with beam power tubes is important from the standpoint of power output and fidelity in audio circuits, and in view

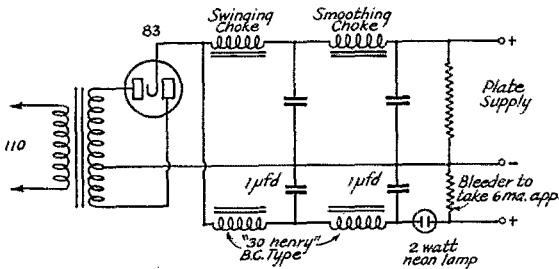

FIG. 1—PLATE AND SCREEN SUPPLY FOR 6L6'S WITH NEON-BULB VOLTAGE REGULATION FOR THE SCREEN CIRCUIT

A 2-watt neon bulb, with base resistor removed, is used to drop the voltage to the proper value and to maintain it constant with fluctuations in screen current.

of the large plate-current change with signal and the consequent effect on voltage regulation, it has been generally recommended that a separate supply be used for the screen. To overcome the necessity for two power supplies, Clifford L. Loudon, W2ALW, has devised the arrangement described in the following letter:

"The screen supply for the 6L6 tubes seems to be a general problem from the standpoint of convenience. I like to limit the number of power sources as far as is practical.

"The only obstacle in the way of taking the screen voltage from the plate supply is that the necessary dropping resistor ordinarily reduces the regulation of its load voltage beyond usefulness. The answer lies in removing the limiting resistor from a neon lamp and using the lamp as a dropping resistor. If one lamp is used, approximately 75 volts of the necessary drop is practically independent of the load current. The use of two lamps in series gives about 150 volts drop.

"The accompanying drawing shows the circuit I am using. My power transformer only gives 390 volts output from the 83 rectifier (without filter),

consequently my plate voltage is only about 360 volts with filter and a 150-milliampere load. The 600 ohms total resistance in the screen supply filter chokes plus the drop in the neon lamp gives a screen voltage of 302 volts with no signal, with regulation governed almost completely by the choke resistance. Cheap chokes are all that are necessary in the screen-supply filter. Of course this system pre-supposes a real power transformer but that is necessary anyway, for the plate supply.

"With a transformer capable of delivering 400 volts out of the filter at full load, or approximately 450 volts out of the rectifier, two neon lamps in series should do very nicely. Even if the screen voltage should be slightly low its constancy should compensate for the sacrifice in voltage.

"I used the .6 milliampere bleed to improve regulation as well as to maintain a load until the 6L6 heaters get going."

The plate-supply filter is conventional and needs no particular description. In the screen-supply filter, 1- μ fd. condensers will suffice for delivering good d.c. since the current drain is small. However, larger condensers can be used

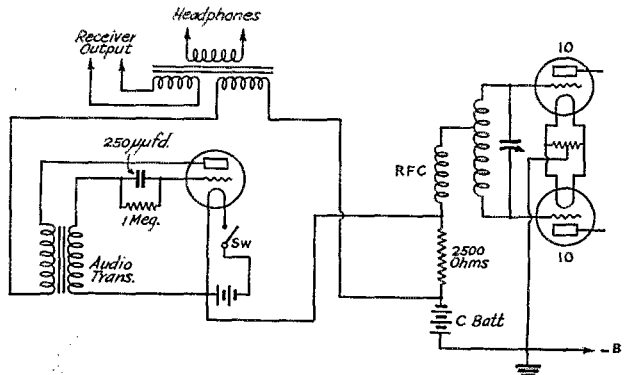

FIG. 2—KEYING OSCILLATOR UTILIZING EXCITATION-DEVELOPED BIAS FOR PLATE POWER

As used at W7CAP, the audio oscillator tube is a WD-12, but any small tube will do equally well. The headphones are connected to the oscillator and receiver through a three-winding audio transformer.

equally well; in fact, if electrolytics are used it is probably as economical to use a double-8 condenser as two smaller ones. With 300 volts on the

screen, a 50,000-ohm bleeder will drain the 6 milliamperes.

Excitation-Controlled Keying Oscillator

A GOOD many schemes have been described in *QST* for using audio oscillators as keying monitors, with various methods of obtaining plate power for the oscillator. Alvin C. Holmes,

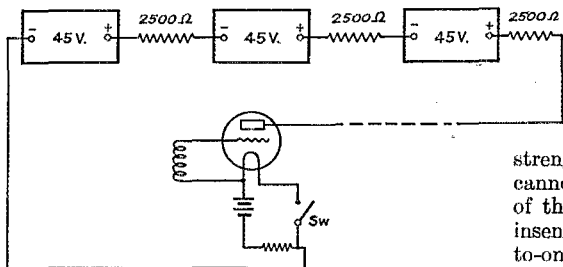

FIG. 3—USE OF PROTECTIVE RESISTORS FOR DRY-BATTERY RECEIVERS

A 2500-ohm resistor in series with each block will prevent burning out tubes in case of accidental shorts, and will also protect the "B" batteries themselves.

W7CAP, operates his oscillator from a rather novel power source. He writes:

"The distinctive feature of this system is that the plate voltage for the audio oscillator is taken from the grid bias resistor of the r.f. amplifier, as shown in Fig. 2. The power taken by the audio oscillator tube is so small that there is no effect on the operation of the amplifier. The key can be placed in the oscillator, buffer, final amplifier, or any place in the transmitter convenient to the operator. The switch in the filament circuit of the audio oscillator tube is incorporated in the send-recv switch and is closed while transmitting. The parts for this system can be found in any amateur's junk box. Any small receiving tube such as the 30 or 199 can be used in place of the WD-12 provided proper filament voltage is used. The system gives very good results."

This system has a further advantage over those in which the oscillator plate power is supplied from the drop across a resistor in series with the plate supply lead—it automatically shows that the final stage is receiving excitation. No excitation, no keying signal; with the other systems, operated by plate current, the keying oscillator operates whether the transmitter is functioning correctly or not.

Protective Device for Battery-Operated Receivers

IN ORDER to prevent burning out filaments of battery operated tubes while trying out bread-board layouts and general experiments, put a

resistor in series with the "B" battery, right at its terminal. A value of about 2,500 ohms per 45 volts of "B" battery will not appreciably lower the voltage supplied to the load but will prevent the passing of sufficient current to burn out any filament in case of short circuits and slips. It will also protect the "B" battery itself.

—V. L. Robbins,
Esquimalt, B. C.

A Simple Audiometer

A PRACTICAL audiometer of simplified design may be of interest to amateurs who want to give as correctly as possible reports of relative signal strengths. In judging radio signals the memory cannot retain for comparison the exact strength of the preceding day, and the ear itself is often insensitive to volume changes as great as two-to-one or even more. It is surprising how great a change must be made to appeal to the ear as a change of volume. A person trained in relative evaluation can differentiate between five values; very strong, strong, medium, weak and very weak. But the majority of us do well to distinguish between strong and weak.

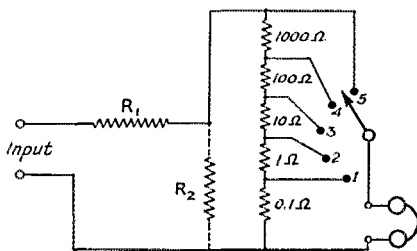

FIG. 4—A SIMPLE AUDIOMETER FOR MEASUREMENT OF RELATIVE SIGNAL STRENGTH

R_1 is used to match the required output tube load; 5000 ohms will be satisfactory in most cases. R_2 is a shunting resistor to be used only when the volume is too great without it; 10 to 500 ohms should be satisfactory.

A glance at the diagram, Fig. 4, will show its simplicity. In its commercial form the audiometer has a compensating series resistance which keeps the input impedance constant as the 'phones are shunted down the scale. In the simplified construction, however, this refinement is unnecessary because the impedance of the entire shunt resistance is purposely kept low relative to the impedance of the 'phones. The audiometer has five steps. Continuously variable adjustable resistors will not do because they vary too much. A small inductance switch with dependable fixed resistors should be preferred. The 0.1-ohm resistor is made up from a 1-foot 6-inch length of No. 28 wire on a wooden dowel. The optional resistance, R_2 , may be used with higher volume.

(Continued on page 74)

● I. A. R. U. NEWS ●

Devoted to the interests and activities of the

INTERNATIONAL AMATEUR RADIO UNION

Headquarters Society: THE AMERICAN RADIO RELAY LEAGUE, West Hartford, Conn.

MEMBER SOCIETIES

American Radio Relay League
Associazione Radiotecnica Italiana
Canadian Section A.R.R.L.
Československá Amatérská Vysílací
Deutscher Amateur Sende-und-Empfangs
Dienst
Experimenterende Danske Radioamatører
Irish Radio Transmitters Society
日本アマチュア無線聯盟
Liga Colombiana de Radio Aficionados

Liga Mexicana de Radio Experimentadores
Magyar Rövidhullámú Amatőrök Országos
Egyesülete
Nederlandsche Vereeniging voor Interna-
tionaal Radioamateurisme
Nederlandsch-Indische Vereeniging Voor
Internationaal Radioamateurisme
New Zealand Association of Radio Trans-
mitters
Norsk Radio Relæ Liga
Oesterreichischer Versuchssenderverband
Polski Związek Krotkofalowcow

Radio Club Venezolano
Radio Society of Great Britain
Rede dos Emissores Portugueses
Reseau Belge
Reseau des Emetteurs Français
South African Radio Relay League
Suomen Radioamatööriyhdistys r.y.
Sveriges Sandareamatörer
Unión de Radioemisoras Españolas
Union Schweiz Kurzwellen Amateure
Wireless Institute of Australia

Conducted by Byron Goodman

Awards

One of the favorite sports of amateur radio is "scalp hunting," or "DXing" as it is commonly known. The thrill of contacting a new country or continent is one that never palls on a large percentage of the amateur fraternity. Recognizing this necessary evil, several of the amateur societies award certificates for various achievements, in an effort to give you something to shoot at. With the idea in mind of clarifying and crystallizing the various requirements, we list them below.

The WAC (Worked All Continents) certificate is issued by the headquarters society (A.R.R.L.) of the I.A.R.U. to those showing evidence of two-way communication with stations in each of the six continents. In countries represented in the I.A.R.U. by a member-society, application is made through that society, and the applicant must be a member of that society to be eligible for the award. In countries not represented in the Union by a member-society, application should be made directly to the headquarters society, and a charge of 50 cents is made, to cover mailing costs, etc. Two certificates are awarded, one for c.w. work and the other for radiotelephony, but no special certificate is awarded for 28-Mc. work. QSL cards, or DX Contest logs of the contacted stations, are considered satisfactory proof of contact.

The WAS (Worked All States) certificate is awarded by the A.R.R.L. free of charge to any amateur submitting proof of contact with stations in each of the 48 states of the United States of America. A contact with the District of Columbia can be substituted for one with Maryland. Application should be made directly to the A.R.R.L.,

and sufficient postage should be enclosed to cover the return of the cards.

There are three types of WBE (Worked British Empire) certificates awarded by the R.S.G.B., for c.w., radiotelephony, and 28-Mc. work. The rules follow:

1. The WBE certificate will be awarded by



THE 100-WATT STATION OF DAVID BROWN, ZL1HY, OF WAIHI, NEW ZEALAND

The receiver is a two-tube a. c. affair, the transmitter is crystal-controlled. ZL1HY is WAC, WBE, and has over 70 countries to his credit.

Council to Corporate members of the R.S.G.B. or the B.E.R.U.

2. The WBE certificate shall be awarded in accordance with Rule 1 to those persons who have effected two-way communications on amateur frequencies, with at least one station in some part of the British Empire located in each of the five continents (North and South America are considered as one continent). The signal reported shall in no case be less than QSA 3.

3. In forwarding a claim a member shall give a guarantee that his licensed power has not been exceeded in effecting the QSO's upon which the claim is based.

4. All applications shall be made in writing to the Secretary of the R.S.G.B., and shall be accompanied by documentary proof, in the form of letters or postcards, that the claim is justified.

5. For the purpose of differentiating between the five continents, Council shall approve a map of the world showing clearly certain arbitrary datum lines. A copy of this map shall be held at the Headquarters of R.S.G.B.

6. All claims shall be judged in conjunction with this map.

7. Members to whom the WBE certificate has been issued shall be permitted to use the letters "WBE" on personal correspondence during the time they are members of the R.S.G.B. or the B.E.R.U.

8. Communications with ship stations sailing under the British flag and British mobile stations will be considered as Empire contacts.

9. British mandated territory and Protectorates shall be considered as forming part of the British Empire.

The R.S.G.B. also gives an HBE (Heard British Empire) award. The rules:

1. The HBE certificate will be issued to fully-paid up members of the R.S.G.B. who have received signals from amateur transmitting stations in not less than 25 different countries within the British Empire or territories mandated to the British Empire.

2. A minimum of three countries in each continent (North and South America count as one continent) must be heard to qualify for the award.

3. To effect a claim, members are required to produce QSL cards, or similar evidence, from each station heard. The evidence submitted must definitely confirm the reception claimed.

4. In the case of transmitting members, confirmation of two-way contacts will be accepted as evidence of the reception claimed.

5. Cards and similar evidence must be submitted to the Secretary, R.S.G.B., 53 Victoria Street, London, S.W. 1, England.

7. Members who have been awarded the certificate may use the abbreviation "HBE (Cert.)" on correspondence.

8. In the case of any dispute concerning a claim, the decision of the R.S.G.B. Council shall be final.

The rules for the DSM award of the D.A.S.D. are as follows:

I

In the title DSM (Deutscher Sendemeister, i.e., German Transmitting-Master) which is given by a diploma, the D.A.S.D. as the German group of the I.A.R.U. wishes to erect an award

for those transmitting amateurs in the whole world who have done outstanding work on short waves, especially in the field of long-distance communication.

II

The title DSM may be obtained by every short-wave amateur who is a member of the acknowledged short-wave association of this country. Titleholder is the applicant personally, not the station.

III

Applications for the title are to be made at the DASD-DSM-Department, Schweinfurthstr. 78, Berlin-Dahlem, Germany. It may be applied for after the conditions of the next article have been fulfilled.

IV

The following code communications have to be made evident to the D.A.S.D.:

1. Two-way communications with all six continents (continental regulations of the I.A.R.U.) on two amateur frequency bands.

2. Ten two-way contacts with foreign countries on a third amateur band.

3. There have to be worked three countries in every continent.

Special Regulations:

(a) Europe: At least one communication with one of the west coast districts W6, W7, VE4, VE5, or K7. Only one QSO with the near coast of Asia (YI, ZC, AR, TA) and not more than one QSO with Northern Africa (SU, FA, EA8-9, CT3, CN). For European stations outside of Germany at least 20 QSO's with different German stations.

(b) Africa: Only one QSO with the near east (YI, ZC, AR, TA), at least one QSO with the west coast of North America (W6, W7, VE4, VE5, K7), and QSO's with 8 different German stations.

(c) Asia: At least 4 QSO's with different German stations, and only one QSO with Northern Africa (SU, FA, EA8-9, CT3, CN) for applicants residing in YI, ZC, AR, TA.

(d) South America: At least one QSO with VE or K7 for North America and three QSO's with different German stations.

(e) North America: 5 QSO's with different German stations except W6, W7, VE4, VE5 with two German stations, and K7 with one only.

(f) Oceania: One QSO with Germany except VK, ZL, and PK, which have to work three different German stations.

One country of the whole series may be replaced by one contact over more than three thousand miles (5000 km.) on another amateur-frequency band than used for number 1. The

(Continued on page 70)



OPERATING NEWS



Conducted by the Communications Department

F. E. Handy, Communications Manager

E. L. Battey, Asst. Communications Manager

AGAIN amateurs rose to the need; again, as a major catastrophe threatened from flood conditions throughout the Ohio Valley amateurs shouldered the task of handling relief and emergency messages; again the record will show a splendid job of cooperative endeavor within the ranks of the amateur service. The emergency began to develop about January 21st. From the 26th day of January until the 5th of February an F.C.C. order designed to limit all communications in the 3.5- and 1.7-Mc. bands to those "related to relief work or other emergencies" was in effect—the first time since the war that special limitations have been placed on amateur operating. Rumors of restrictions on all bands had been circulated, even before the Commission order. These probably came from a distortion of the reading of a moderate F.C.C. statement (given by F.C.C. via W8YX) requesting all amateurs to observe care not to interfere with amateur emergency circuits, but to listen before going on the air! Upon issuing its order the F.C.C. called upon the A.R.R.L. to appoint vigilantes, to broadcast the order, to police bands, to contact by radio those individuals who violated the provisions of the order by intent or otherwise, to inform them and make the curtailment of casual calling, rag chewing, testing, and/or incidental operating, complete.

The League's Communications Department selected threescore stations, distribution nationwide, to monitor stations heard in the 160-meter band, 80-meter c.w., and 75-meter 'phone territory, to carry out the F.C.C.'s policing request. Experienced A.R.R.L. appointees, O.R.S., O.P.S., or officials, were selected in practically all instances—including many of the same minute men who so successfully piped down the League activities scheduled for January 23rd and 24th, when the growing emergency conditions on the Ohio indicated that this should be postponed to enable League stations to assist in the crisis. More than sixty vigilantes were not appointed since it was felt that the operations of policing stations must not in themselves assume a magnitude that would cause interference. These stations will be mentioned in the complete flood report next month. Our hearty thanks to each and every one for the effective work accomplished.

A high volume of superlative work was re-

corded, by 'phone, by c.w., by individual stations, by nets! Many Louisville stations and others in the area had to resort to batteries or gas engine supplies for power. The Kentucky A.R.R.L. Net (3810 kc.) demonstrated its worth; the West Virginia A.A.R.S.-O.R.S. Net (3700 kc.), and the Ohio A.A.R.S. Net with WLH-WLM and "Ohio Regulars" did marvelous snappy work. The Navy Nets likewise! NCR-amateurs, besides holding down their own circuits, operated many Coast Guard and Navy stations in the flooded area. The performance of all these operators and the place that one's individual A.R.R.L. Section Net may come to occupy in inter-city and (through TL connections) remote service is a great inspiration to us and we trust it will be to you. We are proud of all the ham work that took place. We are particularly proud of the readiness of the organized nets and the place that trained amateur operators took.

We shall not dwell on the flood communication results (to be reported in full) except to express our pride in the splendid record of cooperation and communication. We wish briefly to recite some suggestions received and state some of the lessons to be learned; our aim is to crystallize all the thought received, that it may benefit amateur emergency cooperative work in situations yet to arise in the future, and make our performance rise to even greater levels of perfection, achievement and real public service. An emergency communication manual, that has been in the formative stages for some months, to be distributed free to members of the League's Emergency Corps will be delayed by the recent experience, that it may include new material suggested by the special operating problems of this disaster. Every operator known to have played a part in the emergency work is receiving a questionnaire, so that the scope of the work accomplished, traffic handled, agencies served, etc., may be fully known and studied to help plan wisely for the future.

The important cooperation of those playing an inconspicuous part, keeping silent but informed thoroughly of everything in progress, deserves the greatest thanks. 95% or more of all amateurs are true cooperators. The 5% who exhibit selfish tendencies above rational and humanitarian impulses must be classed as headline-hunters at any expense, and we need fewer of these in amateur radio. This small group create a definite problem, some even demanding mail

notice from the F.C.C. about its order. Some we know got green tickets from Uncle Sam in this emergency. Transmitting to rag chew about "when the ban would be off" was in itself contrary to the order. Many hams, no doubt, could be benefited by some "flood education." The desire to help through transmitting participation is too often a fatal and dangerous thing. Just because someone has dug up a personal safety message for Louisville is no reason to go on the air with a "CQ URGENT." Messages of importance, those for official relief agencies, of public instead of individual import, have priority. Intelligent *listening* locates stations, places, nets, keeps general calls to zero or minimum, and enables the handling of secondary messages efficiently, responsive to the QRZ? or CQ of an emergency area station. Many such opportunities were afforded for clearing general relief traffic, between hourly and half hourly schedules of the spot frequency nets in Kentucky and Ohio. *Listening* is invariably profitable, and an essential before operating can be intelligent. There should be more listening, less transmitting unrelated to the actual flood area situation, in future emergencies. The *BARE*graph, club paper, suggests to us the thought that during the important period when *wire circuits are out*, radio channel congestion is most to be avoided, and traffic moved through any remote stations where wire facilities exist. The time for special organizing and orderly functioning of remote secondary radio nets is of course after the partial reestablishment of wire facilities, in order to supplement these facilities by the handling of amateur radiograms to any and all points. The best way to assure that the public is served in emergency is to maintain functioning unimpaired the regulation traffic organization.

One man suggests that, besides authorized vigilantes, the only transmission permitted should be that of A.R.R.L., A.A.R.S., and Navy nets, except when these stations send directional calls and seek definite stations outside the flood area for their needs. There is little excuse for unauthorized or self-appointed vigilantes, excepting where these function in clearing definite flood-net-frequencies, responsive to the wishes or request of net stations, which of course is tantamount to authorization. The use of CQ, or CQ Flood Area, labelled a number of operators remote from the area as completely dumb as anything could. Every Handbook distributed for years hits the practice of CQing "flood area" as nothing but a QRM producer. Any intelligent individual knows that, as conditions and power supply permit, any station in the area will transmit to the outside specifically as his needs direct and that general calls and CQs are worse than wasted.

Unauthorized broadcasting, and modifying of broadcasts was a curse of the early flood days. There should be a penalty for starting rumors, as was done by improper unintelligent expansion or contraction (and subsequent repetition) of broadcast dispatches. To delete essential limiting words that qualify a message, to expand, exaggerate, or alter meanings, is all deserving of censure. Broadcasts should include their source; they should be repeated exactly, if at all, or not repeated; League transmissions through vigilantes extended authority to no other operators to make repeats.

The need, in future emergencies, is perhaps for more selective regulation. Authority to quell a station that starts up on a channel where relief communication is in progress, is more important than blanket silencing of stations. There may be a short period when stations with emergency power supply, even with one or two high-power watch dogs outside their area to protect their channel, will require blanket protection. But the tendency of blanket regulation, unless discriminatory to permit continued work of operators with definite traffic handling experience (as opposed to casual and incidental working) is to substitute inexperienced operators for regulars. A number of reliables took the order as a flat shut down, since they had no relief traffic; some newer men lost their heads and feverishly attempted a transmitting rôle, regardless of location. Regulation for emergency must not remain in force so long as to handicap the handling of the secondary load of personals. Traffic outlets and regular channels, on all except frequencies utilized by emergency nets, must be maintained. 'Phone and c.w. each has its place; 'phone, most sensitive to interference, may best be protected from casual rag chews by a general F.C.C. order as in our recent emergency, but selective policing protection

of particular circuits (by vigilantes stations) is practical for c.w. telegraph workers and by no means out of the question for 'phones.

The F.C.C. interpreted its order to permit the handling of any kind of relief or emergency traffic, personals or official. Of course priority considerations caused Kentucky and Ohio stations to refuse such until service to official relief agencies was established, and personal safety traffic even then was secondary. Because so many of the people in the hard-hit cities were refugees, deliveries of ingoing messages were well-nigh impossible, so ingoing traffic was discouraged. Relief problems had priority, and so there was not the volume of outgoing traffic that some anticipated. But many messages were handled and we know how thoroughly the recipients appreciated the service. Let us hope that some of the operators who handled their first traffic in such a time, will make a practice of continuing some traffic work, not only as a service, but to keep in trim for orderly, recorded, accurate and fast work at any time in the future.

The best emergency work is always by those who have cultivated right operating habits by preparation and practice under normal conditions. The desirability of having emergency power supplies, and equipment (such as exciters and receivers) ready to plug over to such supplies was again demonstrated. THE NEED FOR PREPAREDNESS is the essence of the whole lesson. It may take some little time to perfect our organization, but the stimulation of this emergency is already apparent in increased registrations in the League's Emergency Corps. In each community we want to see amateurs in a constant state of preparedness—registered in advance with A.R.R.L. and with those that will be served by amateur radio communication if and whenever emergencies arrive!

We have in mind the possible desirability of an A.R.R.L. coordinator, for emergency groups in each city and town. Under appointment by the S.C.M., this official would have responsible charge of records of local amateurs and amateur equipment. His plans for deploying stations on different bands, for the local necessities, and for outside contact in the event of disrupted wire service, would be known to local authorities and A.R.R.L. beforehand and subject to current revisions and improvements by discussion from time to time. In, and long before, actual emergency, our coordinator would be in touch with the responsible local officials and ready to pass along to responsible prepared amateur operators the jobs to be done, meeting any situation as it develops by any necessary modification of the advance plans. The communication program, of course, should be worked out to meet flood, earthquake, tornado or as local experience indicates the type of possible disaster. Whether or not such a local amateur coordinator or official is needed to represent and plan, will be studied closely as full facts on every phase of this emergency become available.

—F. E. H.

Amateurs Provide Communication During Ice Storms

Hannibal, Missouri: With wire communication disrupted by a severe ice storm, the city of Hannibal on the morning of January 8th looked to amateur radio for outside contact. The Southwestern Bell Telephone Company requested communication with St. Louis and Kansas City. The Hannibal Amateur Radio Club station, W9KEM, made contact with W9KEF, St. Louis, at about 11:00 a.m. on 3.9-Mc. 'phone, and telephone company traffic was handled; the longest message contained 238 words. W9PYF (Hannibal) on 3.5-Mc. c.w. succeeded in raising W9EBX, East St. Louis. PYF and EBX were in contact continuously from 9:30 a.m. until 2:50 p.m., handling telephone company traffic. Late in the afternoon W9PYF arranged a schedule with W9EFC, St. Louis. These stations remained in contact until regular communication channels were again operating on January 15th. Most of the operating at W9EFC was done by W9CMF, who operated EFC's transmitter remote-controlled from his home. In the midst of communications

with St. Louis, the Chicago, Burlington and Quincy Railroad called for communication with Brookfield, Mo. It so happened that W9PYF had earlier been QSO W9SRE of Brookfield, and had him standing by, so contact between Hannibal and Brookfield was all set. Since W9SRE was unable to be on the air in the morning, W9ALJ, Marceline, Mo., stepped into the picture and handled the Brookfield traffic via telephone from his town. Communication with Brookfield was maintained until the 10th when the railroad got a line through. On the evening of the 11th, W9PYF went to bed sick, and traffic was handled through W9TCM, Hannibal, and W9SGP, Atlanta, Mo. Wire communication was finally established to St. Louis on the morning of the 15th. By that time W9PYF had put in 103 hours of operation and had handled 183 messages, 161 of which were for the telephone company. Average number of words per message: 40.



A TYPICAL SCENE IN THE STRICKEN AREAS

At the St. Louis end W9EFC put in 11 hours and W9CMF, operating W9EFC, put in 95 hours. W9FSZ was at the Hannibal Club transmitter W9KEM all through the day of the 8th, handling traffic for the telephone company and others. All the members of the club helped in every way possible. W9LRR operated at W9TZN on 1.75 Mc. in an effort to establish further communication to St. Louis and Kansas City. W9UJU brought his 1.75-Mc. 'phone station into action and also handled traffic. W9KEM established communication with W9WEE, Kansas City, and with W9LTY, Chillicothe, Mo., who acted as relay between K.C. and Hannibal.

W9EFZ, Hannibal, for three days used his station on 3.9-Mc. 'phone in contact with W9KEF, St. Louis, to handle Associated Press news for the local paper. A stenographer from the paper sat in at W9EFZ each day from 10:30 a.m. until 3:00 p.m. copying the news as sent from W9KEF. A messenger brought the various news items from the St. Louis agency to W9KEF's station. W9KEF transmitted a total of about 6500 words of press—all on 3.9-Mc. 'phone. He was on the air about 22 hours, one stretch of 5 hours without a break. W9EET, Sullivan, Mo., acted as relay between KEF and EFZ when difficulty was encountered in reception of EFZ's signals at KEF. W9TZN and W9FSZ assisted at W9EFZ.

Others who assisted in various ways in the establishment and/or maintenance of communication with Hannibal include W9LBA, W9FJV, and members of the Hannibal Club not previously mentioned: Branham Rendlen, president, W9GBC, W9FSB, W9RUU, Carroll Waddell, Alva Moore, Harold Benway, Lester Fuhrman and Andy Burnett. W9OQI, Jefferson City, Mo., called on the Hannibal lads for information regarding highway and weather conditions, same being secured for him. W9LBM assisted W9OQI. We are grateful to W9PYF, W9EFC, W9EBX, W9KEF and Selwyn Pepper of the St. Louis Post-Dispatch for information which made possible the above report of emergency communications.

Jacksonville, Illinois: On January 8th all landline communication with Jacksonville was cut off by heavy sleet

storms. W9YKA installed his transmitter and receiver at the local high school and with the help of W9TZL and W9TDK was able to contact W9BXR, Hillsboro, Ill., on the 3.5-Mc. band. Through W9BXR the Decatur Power Company was notified that W9YKA was in operation. The power company advised W9NFL (Decatur) of this and communication was established between YKA and NFL. Contact was maintained for about twelve hours; messages were handled relative to power line trouble for various power companies throughout the affected area. Other amateurs assisting: W9BEN, ex-W9BHH, W9AHB, W9WLM and W9YPW.

Siloam Springs, Arkansas: W5DRW handled emergency traffic for Western Union, KCS R.R. and others when heavy sleet and ice tore down all normal communications services out of Siloam Springs. All messages were given to W9BNT, where W5RED, a former Arkansas ham, was at the key.

Oklahoma: W5EGP, Muskogee, Okla., sends the following report: "Friday morning, January 8th, I contacted W5FX on 3.5 Mc. He asked me to help him try to make contact to Durant, which was completely isolated due to wires being down due to heavy ice. I went to 7 Mc. . . . heard W5QL (Okla. City) calling me . . . after making contact with him he informed me there was no telephone service between Oklahoma City and Muskogee and he had some important traffic for the Gas & Electric Co. in Muskogee. I stayed in contact with W5QL all day and by 5 p.m. had delivered five messages to the superintendent of the G. & E. Co. At 6:30 p.m. we shifted to 3.5 Mc. and remained in contact until 11 p.m. We maintained contact all day Saturday, the 9th, handling traffic between Muskogee and Oklahoma City and trying to raise a station in Ft. Smith, Arkansas—

Fort Smith was also without telephone service and the Gas & Electric Co. was anxious to establish contact. W5QL finally raised W5BRW (Ft. Smith) on 3.9-Mc. 'phone about 5 p.m. W5QL, W5EGP and W5BRW worked three-way, handling traffic between Ft. Smith, Muskogee and Oklahoma City. Later W5QL got W5EIH (Okla. City) on 3.9-Mc. 'phone to handle traffic with W5BRW.

"About 6:30 p.m. the superintendent of the Gas & Electric Company called me on the phone and asked me if there was any way I could talk to the power plant with 'phone. He had the idea of taking a short-wave receiver to the power plant, which was without telephone service to Muskogee, and letting me send his instructions to the men at the plant as he 'phoned them to me. I got in touch with W5EZV and he took his receiver and a portable National Guard transmitter with a hand-cranked generator to the power plant. Contact established, the superintendent 'phoned instructions to me and I relayed them to W5EZV at the power plant. All through the night I stayed in contact with W5EZV and W5QL by radio, and with the super by phone. None of us got a wink of sleep.

"W5QL left the air about 10 a.m., Sunday morning, and W5EZV and I stayed on until about 1 p.m. W5EZV then came into town and went to bed, and I went to sleep for about half an hour. W5FOJ went to the power plant to operate in EZV's place. I remained in contact with him until 4 p.m. when most of the job was done. About 11 a.m., Monday, the O. G. & E. Co. asked me if I could establish communication with the power plant again. They sent a car to pick up W5EZV and take him to the power plant and we again made contact. Later contact was wanted with W5EHY, Sallisaw. I hooked W5FOJ on 3.5-Mc. c.w. and he shifted to 1.75-Mc. 'phone and contacted W5EHY. W5QL and I reestablished contact about 4 p.m., not signing off until 7:15. It was the first real emergency work in which Muskogee hams have had a chance to participate. W5QL handled traffic with W5BLJ, Sulphur, on the 8th and 9th."

Columbia, Missouri: Nine W. U. telegrams filed at Columbia, Mo., on January 8th for points west of that city were handled via East Orange, N. J., and New York City. A

storm had brought down the wires at Columbia. The W.U. operator there is W9UYI. Going on the air he raised his brother, W2FL, in East Orange, N. J., and relayed the messages to him. W2FL sent them to N. Y. C. where they were put on telegraph wires.

PRIZES FOR BEST ARTICLES

The article by Mr. J. D. Phelan, W9RSE, wins the C.D. article contest prize this month. Each month we print the most interesting and valuable article received marked "for the C.D. contest." Contributors may be on any phase of amateur operating or communication activity (DX, phone, traffic, rag-chewing, clubs, fraternalism, etc.) which adds constructively to amateur organization work. Prize winners may select a 1937 bound *Handbook*, QST Binder and League Emblem, six logs, eight pads radiogram blanks, DX Map and three pads, or any other combination of A.R.R.L. supplies of equivalent value. Try your luck. Send your contribution today!

I Cannot Tell a Lie

By J. D. Phelan, W9RSE*

SOME very talented gentleman once invented a system of reporting signals: a conglomeration of QSA's, R's, and T's. This finally was shortened to the now popular RST system. The same ideas still exist, however, but I dare say they need quite a bit of reviewing. At present the only two "R" reports that seem to be used are R4 and R5. R4 is given when the other fellow's signals are not readable, due to their extreme weakness, or due to the fact that some local station has blocked the receiver. It is a most heinous crime to give a fellow an R4: even foreigners are frightened by such a report. R5 is given to anyone, and everyone else we work. R5 simply means that you simply heard him call you once, and that maybe, if conditions are right, you will be able to hear him again. The other three numbers in this group are never used (except as a joke). I, in particular, have been an offender. Upon investigation I found that in my last fifty QSO's I gave out only five reports that were not "readability" 5! In that same number of contacts I received forty-two such reports: I am positive that *only* about half of these contacts were 100% solid copy. Yet *that* is what readability 5 indicates.

There are three different "S" or strength reports that are given: S7 for the almost inaudible signals, S8 for those that are fairly audible, and S9 for those that actually come through the interference. (Maybe this is *slightly* exaggerated, but not much.) We have developed the connotation that S5 or S6 is a very poor report, and that we should never give it to anyone! This is *not* the case. Even a strength 4 is a *fair* signal that is *easy* to read. An S5 is a *moderately strong* signal, and an S6 is a *good* signal. I suggest the occasional use of S4, S5, and S6, on some of the locals, as well as the dx stations!

There are also only three different "T" reports that are now in use: T7 for the raspberry note that sounds like a cross between a politician's snore and a rivet machine, T8 for anything from a dicky-bird song to a wounded-duck quack, and T9 for the more gentle rasp, or bumblebee buzz. I gave one ham a T8X report. He seemed horrified; I could actually feel him shivering with fright! He asked me if I thought that he would get a pink slip from the government monitoring station! Apparently he judged his own signals by the reports he gave others. Another time, I gave an amateur a T6. "My gosh OM," he declared with feeling and emotion that virtually rocked the receiver. "the report I got before this one was T9X; I can't understand what could be wrong." (Insinuating, obviously, that there was something wrong with me.—Maybe he was right.) He messed around with the rig a little while, and when I repeated that he was T6, he became disgusted. He then told me he would be glad to see me again when I could give him a T9X. If his note

stays as it is, I am afraid that we shall never have another QSO.

If you don't already know it, a T6 is a fairly good tone. The definition defines it as a "nearly DC tone. *Very good* filter; keying OK." Even T4 indicates that the rig seems to have a small amount of filter; it should *not* sound like a crocodile belch before we consider it T4 or T5. Many of us pay no more attention to the definitions printed in our publications than do the XU's and ZS's pay to my ardent calls.

How can we blame many of the hams for their broad, raspy, modulated signals? We are constantly preaching to them to "clean up their notes: cut down the interference." Then we pause in our preaching, fire up our rig, and work a fellow who actually has almost a T3 note. He gives us a nice report, so of course we don't want to disappoint him. "Your fb RST 598x signals, etc." we pound into him. He then gets all puffed up like the base of our slightly overloaded "ten" and thinks his rig is swell. Why shouldn't he? How can we accuse another ham of being a menace and a scoundrel, if we don't tell him just how his signals really sound? It's getting so that one hasn't the least idea of just how his outfit sounds, or how loud he is. While on 80-meter c.w. one winter with a self-excited transmitter, I received reports varying from T6 to T9X; someone was mistaken (to say he lied would be a little harsh—but he did). How did I know whom I should believe? My monitor and better judgment indicated that my note was somewhat rough, but I virtually received more T9 reports than I did T6! Come on, fellows, look over your reports and see if I'm not right. If I am, why not turn over a new leaf by telling the next "ops" you work the *real truth* as to how their signals really sound?

Hartford Old Timers Night

The Hartford County Amateur Radio Association will hold its Third Annual Old Timers Night on February 27th, 7:00 P.M. EST, at the City Club, 10 Allyn Street, Hartford, Conn. A roast beef dinner will be included in the price of \$1.50. All amateurs are invited. There will be a bigger list of speakers than ever before—most of them real old timers. Tickets are obtainable through W1JAM, R. F. Alford, 842 Burnside Ave., East Hartford, Conn.

The Annual Hamfest of the Framingham (Mass.) Radio Club is scheduled for April 3d, 3:00 P.M. EST, at the Hotel Kendall, Framingham. Fee: \$2.00. An invitation is extended to all radio amateurs.

W1IKC, Waterville, Maine, is proud possessor of 1937 automobile registration number 7388.

W3EZ, Eastern Pennsylvania 6CM, was demonstrating his 30-watt phone and pointing out how useless it is to call CQ when the band is "dead." A CQ was sent just to show "how it's done." It was answered by PY1MK! Both stations were Readability 5, Strength 7.

KOAC—550 Kc.

E. A. Yunker, W7EZL, Assistant A.R.R.L. North western Division Director, is giving a series of ham talks over 1000-watt station KOAC under the title "News from the Amateur World." The purpose of the talks is to further interest in amateur radio, educate the public to the aims, ideals and problems of the amateur, promote understanding between the hams and B.C.L.'s and to emphasize the services rendered society by radio amateurs. This program has been going on since last October and will continue for the remainder of 1937. The time is Monday at 5:20 P.M. PST—station KOAC, 550 kc.

*929 South Jay Street, Aberdeen, S. Dak.

How's DX?

How:

About the time you get around to reading this, if at all, you will have ideas on the big things you're going to do in this year's DX Contest. The beams have been pruned down to the last inch and pointed in exactly the right direction, the receiver has new tubes and is working better than it ever did before, and the circuit breaker goes out at exactly 999.9 watts input to the final. You have it all figured out as to what bands to use at what time, and the serial number you're using combines speed with impossibility of confusion. If you're like one fellow we know you will, have the doctor syringe your ears the day before the contest, so you can dig down and hear the weak ones. Every electrical device for a block around has had a filter installed, and you are all set to hang up the "Detour" signs in the street to cut out automobile QRN. In other words, the thing's a cinch, and Bill on the other side of town isn't going to smoke you out like he did last year. Go to it, OM—don't say we didn't warn you about the key clicks, bum notes, long CQ's, and all-around poor operating of the other fellow

Where:

Siam is good DX for most anyone, and HS1PJ (14,200 kc., 'phone or 19x c.w.) and HS1RJ (14,325-14,370 kc., T7) are good bets from 8-12 E.S.T. W7BTH reports hearing HS1PJ on 7100 kc. at 8-9 a.m., P.S.T. . . . HK1JB (28,100 kc., T9) has moved to the coast, at Santa Marta, but you can QSL via the L.C.R.A. . . . Don't let NX2Z on 'phone fool you. Harold Vosburgh of Clarenceville, Quebec, went to a lot of trouble to verify his reception of NX2Z's 'phone which, by the way, has been working lots of W's, but all he got was a letter from the real NX2Z, now back in Denmark and signing OZ2Z, to the effect that he had never been on 'phone . . . W8CRA worked K6MTE on Jarvis Island some time ago but is worried because he can't find that island on the list of countries published last month. Our mapologist bows his head in shame—it should be counted . . . W2DKF worked a station signing EA7BA (7145 kc.) at 1:50 a.m. who said he was in Cadix but closed up completely when asked for more dope . . . The QRA of U9MI (14,290 kc., T7), worked at 0730 E.S.T. by W1FUY and around midnight by W1EDW, is Box 48, Sverdlovsk, Ural . . . W2HFF says send your card to VE5TV (14,290 kc., T7) at Nottingham Island, Hudson Straits, via Port Churchill, Manitoba. W2HFF would like the QRA's of FS5AZ (14,280 kc., T8), heard at noon, and HR7WC (14,360 kc., T7) . . . Just because you have already worked India, don't pass up VU2DY (14,300 kc., T9), heard on the east coast around 9 p.m. He is at Maymyo, Burma, and counts as another country . . . It broke the hearts of some of the boys entered in the S.A.R.R.L. Contest to hear CR7GF (14,430 kc., T9c) coming through about 4 p.m. E.S.T. calling "CQ JB"—a week after the contest! CR7 was rare all throughout the contest, as was Z63 . . . Reported by many, including W4CQR who heard him S9, is VV2AB (14,380 kc., T9) who says he is at Laguna Iale. Our attitude is one of frank scepticism . . . Those of you who didn't work EL2A may have to wait some time for a Liberian contact. EL2A has folded and is back in the States now. W8ZY was his last QSO . . . VP6RB (7050 kc., T9), a new-comer, uses 35 watts input to 45's in a TNT. Send your card to R. B. Lashley, 7th Avenue, Belleville, Barbados, B.W.I.

When:

One of those things we remember seeing in back issues of QST but can never dig out is the list of hours the J stations are allowed to operate. For your convenience they are made available once again, courtesy J2KQ:

J.C.T.	G.M.T.	E.S.T.
2- 4 A.M.	17-19	12- 2 P.M.
6- 8 A.M.	21-23	4- 6 P.M.
10-12 A.M.	01-03	8-10 P.M.
2- 3 P.M.	05-06	12- 1 A.M.
4- 6 P.M.	07-09	2- 4 A.M.
10-12 P.M.	13-15	8-10 A.M.

The 'phone portion of the DX Contest will not take place exclusively on 10 and 20 meters if conditions continue as they have been. For example, during the past few months W1BT has worked four continents and an even dozen countries on 75-meter 'phone. In an hour and a half on January 23rd he worked CO8YB, VE2HE, W2EEN, G2PO, G5CU, EI9D, and ON4HS, with an average report of S8. Some of the frequencies are: ON4HS, 3730 kc.; G2PO, 3620 kc.; G2PW, 3710 kc.; G5CU, 3700 kc.; EI9D, 3532 kc. A simple (7) antenna system is used—two sets of half-waves in phase, one set running north-south and the other east-west, 170 feet off the ground? Directional effects are quite noticeable when switching from one system to the other . . . And Jerry Mathis, W3BES, had thought that his 3.5-Mc. contacts with ZL1AR, ZL2NW, and ZL1DI at 4.4 Mc. about a month ago were not even worthy of mention, but we think that spells "DX" in any language . . . W9FQQ reports working K5AC (3550 kc., T8) at 11:15 p.m. C.S.T., using only 50 watts to a pair of 46's. K5AC has 65 watts input . . . And if you still are unconvinced that 3.5 has possibilities, lend an ear while W6KFC tells of hearing G5ML (3515 kc.) and HB9AD (3505 kc.) while listening for trans-pacific DX! . . . On our slide rule it adds up to: Don't pass up 80 in the DX Contest.

There seems to be an increasing feeling that 7 Mc. has not been given the attention it deserves. W1BT and W4AUU report U6ST (7100 kc., T6) at 11 p.m., and W4AUU adds that 10-11 p.m. E.S.T. is good for ZS, ZU, and ZT . . . The west coast boys have been getting in their licks working Europe, which is the best 7-Mc. DX there is out that way. W6CIS says 11 p.m. to 1:30 a.m. is the time, and hears G2PL (7025 kc., T9), G6NX (7025 kc., T9), PAOBE (7030 kc., T9), HK1J (7040 kc., buzzer modulation), F8EO (7020 kc., T9) was worked . . . W9UM reports 7-Mc. European signals coming through to the Middle West with good volume, with VK6 the best bet in Oceania. However, the VK's and European 7-Mc. stations are finding it increasingly difficult to get in good QSO's due to the terrific 'phone QRM in their respective countries.

Stations worth going after on 14 Mc. are ones like W1DF tells about: ZC6AQ (14,420 kc., T6) at 5:30 p.m., EA8AO (self-identified between 14,000 and 14,050 kc., T4) 5-7 p.m., and CT2BJ (14,275 kc., T8) at 12 noon . . . Wallie Smith, W6JMR, contributes a nice one with NX1Q (14,100 kc., T7), heard at 8 p.m. Wallie worked LA5N for country Nr. 52, raised U3AN, ON4FE, G6TD, G2YB, F3AD, F3LK, OZ2M, G6VP, and F8EO, and nominates the last three as outstanding signals. All in the morning before work . . . W6GPB, W6JMR's chief rival, lists a few of the best Africans from the JB tests: ZE1JZ (14,380 kc., T9x), ZE1J8 (14,375 kc., T9x), FB8AD (14,280 kc., T8c), FB8AF (14,270 kc., T8c), VQ8AF (14,050 or 14,360 kc., T8c). They come in from 7-10 a.m. and 6-8 p.m. P.S.T. Europeans are there from 7-11 a.m., and include SP1LN (14,440 kc., T8c and drift), SP1DE (14,275 kc., T9x), SP1AO (14,300 kc., T8c), YM4AA (both edges of 14 Mc., T9x), HAF4K (14,125 kc., T9), HAF4H (14,040 kc., T9x), and HAF8C (14,050 kc., T9x) . . . If you need Iceland, TF5C (14,300 kc., T8) is a good bet in the morning or evening . . . Reg Tibbitts, W6ITH, adds a new one to his already overflowing list of 'phones worked: OA4C (14,088 kc., 'phone), worked at 6:40 p.m., and says that Europe very good between 6:30 and 8 a.m. P.S.T. . . . The new rhom-

bic works well for Ford-engine-powered W7AHX, and he has added G5BJ, PAOALO, and G2XV VP2SL, reported last month as on 7 Mc., has moved down to 14,290 kc. and W9KA was the first contact for the St. Lucian station W2HHF has been knocking them over right and left. Among those worked were ZU5Q (14,015 kc.), ZT6AY (14,320 kc., T7), PK1MO (14,050 kc.) S8 at 8 A.M., J2JJ (14,270 kc., T8) at 5 P.M., ZS6AY (14,090 kc.), ZT6AL (14,360 kc.), ZS6AJ (14,060 kc.), ZU6AF (14,365 kc.), ZS5X (14,010 kc.), ZSIAL (14,025 kc., T8), ZS1AV (14,100 kc., T6), ZS6AU (14,270 kc.), ZT6AU (14,090 kc., T7), ZT6Z (14,100 kc., T9), CN8MK (14,380 kc., T7), CN8MU (14,290 kc., T7), HC2CG (14,300 kc., T9), VQ4KSL (14,300 kc., T8) at 4 P.M., VU2BA (14,380 kc., T7) at 8 A.M., and YT7KP (14,370 kc., T6). Heard were VP3BG (14,370 kc., T9) at 8 A.M., SU1MA (14,280 kc., T9), U1BC (14,260 kc., T9) at 7 A.M., FK8AA (14,280 kc., T8) at 3 A.M., VU2JN (14,420 kc., 'phone), VU2CQ (14,370 kc., 'phone and c.w.), VS7RF (14,300 kc., T8) at 7 A.M., VU7FY (14,380 kc., T9), VS8AA (14,370 kc., T7) at 8 A.M., VQ4MSN (14,130 kc., 'phone) U9ML (14,315 kc., T9) and U9AL (14,310 kc., T8) are good bets if you need Asiatic U.S.S.R. Midnight or early morning In W6 land, listen from 8-10 P.M. for GI6TK, OH3NP, OH3OI at about 14,325 kc., and at 14,100 kc. for PAOGN W4CQR reports VP6MO (14,260 kc.), FY7C (14,400 kc., T7), and PZ1PA (14,400 kc.).

Most of the boys are keeping their 28-Mc. DX to themselves, but on the east coast J2IN (28,100 kc., T9) has been coming through around 5:30 P.M., as well as VK3XP (28,100 kc., T9) and HK1JB. Europeans are of course good during the morning Other Asians are J2CE (28,360 kc.), J2LU (28,060 kc.), J3DC (28,240 kc.), J3FJ (28,000 kc.), and J3FZ (28,200 kc.).

Who:

Well-known HC1FG spent November and December in the States and maintained skeds home through several W stations. The QSO between W9UM and HC1FG on Dec. 27th was the 1264th QSO between these two stations since starting their schedule in March, 1927 VK3EG reports a new 'phone testing, signing HZ1AA on 14,150 kc., but apparently the two American operators do no listening W3ARK is with the U. S. Marines at Shanghai, and can be heard frequently operating XUBAG and XUBKP on 7070 kc. . . . If you think it's easy, just try to do it yourself, but VE1EA and G2PL have the first 5BTOC we know of. You remember how we started out with TBTOC (Three Band Trans-Oceanic Contact) and then when that became too easy with 28 Mc. opening up we switched to 4BTOC. Well, VE1EA and G2PL have QSO'ed on 10, 20, 40, 80, and 160, and are now making plans for a 56-Mc. QSO! The time they contacted on 160 was around 0530 GMT We erred slightly in reporting a G5QY-PY1BR 28-Mc. QSO the first on ten between England and Brazil. G6YL worked him a day earlier, and says that she is sure hers was not the first QSO. Maybe we'd better not try to list these "firsts" or we'll be in up to our neck! Alan Eurich, W8IGQ, operating WCFT aboard the Schooner *Yankee* at present in Tahiti, has been carrying on daily schedules at 6:30 A.M. E.S.T. with W1ZB and W1FTR. WCFT uses 8280 kc. and amateurs working him use the 7-Mc. amateur band. W1NI, W1TS and W1CC have also contacted WCFT several times. WCFT expects to be near Samoa at the time of the DX tests and will look for calls from amateurs on the 7-Mc. band after 1130 GT daily. This will probably be an added multiplier to many participants so watch out for WCFT. . . . Latest 28-Mc. WAC's are W. F. Meyer, ZU6P, K. R. Rankin, VK3KR, and, of all things, W1JPE.

Good luck in the DX Contest

—W1JPE

—♦♦♦—

By special permission of the Navy Department and the F.C.C., members of the Naval Communication Reserve in the 12th Naval District were permitted to contact the U.S.S. *Chester*, NAFV, anchored off San Francisco on Sunday, October 25, 1936. Amateurs worked in the frequency range 3500-3900 kcs. and NAFV used 3475 kc. Two receivers

were used on the *Chester* with two operators keying one transmitter. When one operator finished a QSO, the other would work the next station that had been found while searching the band; 91 amateur stations were worked. This drill was under the supervision of Lt. Sydney J. Fass, U.S.N.R., W6NZ, Chairman for Radio Programs for Navy Day, 12th Naval District.

—♦♦♦—

The following are students at Tri State College, Angola, Indiana: W1HJR FZX CCV HEC JLY W2ICH IGH W3ERD AZX W5DAZ W7BDJ W8JLL KUK NDS HAR OPW PTA CGW GFT HAQ MIB MKN BIF MBI OGH W9UJ FBJ VE4RF.

56-Mc. Doings

Trans-Atlantic Tests

G6DH announces an extensive series of 56-Mc. transmissions during February, March, April, May and June. Starting February 1st through February and March he will send with unmodulated c.w. on 56/56.5 Mc. daily, including Sundays, for half hour periods starting at exactly 5, 6, 7, 8, 9:30 and 10:30 A.M. E.S.T. April, May and June transmissions will start at 4, 5, 6, 7, 8:30, 9:30, 10:30 and 11:30 A.M. E.S.T. daily. In May and June additional transmissions (noon to 2 P.M. E.S.T.) will be made as conditions seem to warrant. On days when conditions are good and there is possibility of contact with other stations, the above schedule may be subject to slight variation.

Via W1BFT comes word that 150-watt 56-Mc. station F8QK will call USA each Sunday.

56-Mc. tests will be conducted by W3GLV, Leesburg, Va., from 8:00 A.M. to noon E.S.T. (1300 to 1700 GT) on the mornings of Feb. 20th, 21st; Mar. 20th, 21st; Apr. 17th, 18th; May 8th, 9th; June 5th, 6th; and July 3rd, 4th. On these dates W3GLV, c.c. 56,004 kc., 250 watts input, c.w., will endeavor to contact Europe and Africa. Transmissions will be for 15-minute periods starting on the hour, followed by 15-minute listening periods. W3FPL will also take part in the tests whenever possible, using c.w., 100 watts input on 57,560 kc.

Buckeye 56-Mc. Relay

The Buckeye Short Wave Radio Association (Akron, Ohio) is sponsor of a 56-Mc. Relay Contest to be held March 6th and 7th. The object is to route messages into Akron via 56 Mc. from any other cities, towns or outlying stations, using as many relay stations as necessary or desirable. The form suggested for messages by the contest committee is as follows: HR MSG NR1 (no ck) FM W8ZZZ PUMPKIN CENTER N Y 9:20 AM MARCH 6 to W8KG AKRON OHIO VIA W8 . . . W8 . . . W8 . . . etc., each station adding his call to the list. An attempt will be made to acknowledge each message over the same net and each station participating will receive an acknowledgment by card. Amateurs everywhere are invited to participate. Worthwhile prizes will be awarded to (1) the station outside of greater Akron turning in the most outstanding piece of work, (2) the station making the longest direct contact with Akron, (3) the two stations bridging the longest distance in any net, provided the message arrives at Akron, (4) the station farthest from Akron that participates in any net that gets a message into Akron, (5) the station outside of Summit County (Ohio) whose call appears in the greatest number of messages reaching Akron, and (6) the first station outside of Ohio that gets a message through to Akron. Send all reports of participation in this activity to Harold E. Dinger, W8KG/W8YC, President B.S.R.A., 905 Berwyn Ave., Akron, Ohio.

Brief

Another amateur radio romance: Doris Schwerdtfeger, W1IGN, and Lawrence A. Hopp, N8ENP, will be married in March, 1937. They became acquainted through radio contact two years ago and have kept schedules regularly during the past eight months. N8ENP, formerly of Benton Harbor, Mich., is now located in Boston with the U.S.N.R.

BRASS POUNDERS' LEAGUE

(December 16th-January 15th)

Call	Orig.	Del.	Rel.	Extra Del.	Total
W3FTK	75	43	1817	2	1937
W5MN	54	225	1332	157	1768
W6KFC	45	84	1493	56	1678
W7DUE	36	58	1262	9	1365
W4PL	35	53	1184	28	1320
W8JTT	45	86	1092	42	1267
W8MTP	9	14	1110	14	1147
W2HZY	40	80	876	34	1030
W5PDR	158	219	388	207	972
W8KUN	33	60	842	30	965
W8SN	120	201	610	10	931
W2HYC	103	76	717	34	930
W8BWT	75	133	585	83	876
W5CEZ	79	89	664	42	874
W2BCX	4	44	818	—	866
W1EP	31	70	790	12	855
W8OFO	17	52	717	66	852
W8EOP	29	12	780	4	825
W9PVS	38	24	664	51	777
W8DI	13	26	683	12	734
W8EBX	32	40	652	—	724
W1FSV	92	49	1082	44	1235
W6MQM	152	142	400	127	721
W4AWO	26	79	454	148	707
W1AKS	134	76	496	—	706
W8MOT	91	10	678	10	705
W8CII	91	69	511	30	701
Y82EG	82	72	472	51	677
W6JTV	37	83	472	83	675
W8ISE	11	37	590	36	674
W9AZR	30	32	621	—	673
W8ESA	49	104	440	17	670
W8BCW	141	92	366	16	645
W1LOR	265	139	196	17	617
W8SGP	37	37	528	4	606
W8MOT*	21	5	572	5	603
W8FAM	2	9	576	8	595
W8OOD	38	38	504	10	590
W7NH	8	9	538	11	563
W8KWA	12	52	518	—	582
W1UE	84	168	235	91	578
W1PRO	20	94	390	72	576
W8AD	93	112	349	14	568
W1WC	38	43	432	19	538
W8RMN	3	37	494	24	558
W2KI	35	147	234	141	557
W1IHI	60	42	446	6	554
W8CSE	28	53	444	29	554
W8LH	6	21	514	13	554
W1HSX	86	74	346	39	545
W9FLG	58	145	342	—	545
W8DXA	67	91	352	31	541
W1JFP	41	34	443	21	539
W1EST	273	97	152	11	533
W1LGB	143	72	297	18	530
W9LCX	72	29	414	12	527
W1IOT	22	54	432	14	522
W8ABW	65	93	295	67	520
W8GAN	212	66	180	57	515
W8GCG	39	39	380	27	506
W8FQU	60	143	190	107	500
W7WY	8	8	479	5	500

MORE-THAN-ONE-OPERATOR STATIONS

Call	Orig.	Del.	Rel.	Extra Del.	Total
KA1HR	1516	1136	906	—	3558
W5OW	209	450	1828	361	2938
W5DGP	61	84	1238	—	1383
W9BNT	140	235	791	—	1166

These stations "make" the B.P.L. with totals of 500 or over. One hundred deliveries + Ex. Del. Credits also rate B.P.L. standing. The following one-operator stations make the B.P.L. on deliveries. Deliveries count!

W6CVU, 338	W2DBQ, 156	W5AWK, 110
W2GGP, 306	W8CEU, 142	W1EPT, 109
W9KJY, 288	W1EJH, 128	W2PFF, 109
W6ITE, 281	W1EFL, 126	W5CVA, 107
W7APS, 245	W6EWC, 124	W4COB, 107
W7DYH, 187	W1INE, 121	W5ENI, 105
W6IMJ, 172	W5GCC, 114	W8JQE, 105
W4CYV, 168	W1LXP, 112	W9PTJ, 103
W6MQS, 168	W9PYF, 111	W5AAJ, 101
W6IOX, 165	W2ISQ, 110	More-than-one: W6FSK, 121

A. A. R. S.

Call	Orig.	Del.	Rel.	Extra Del.	Total
W1MI (W6QXM)	174	245	644	—	1063
W1NF (W2BCX)	21	35	885	—	941
W1MC (W3DQN)	6	3	842	—	851
W1RC (W4BBV)	77	40	640	—	757
W1RY (W4IR)	12	170	556	—	738
W1ME (W6ETL)	190	210	260	—	660
W1VH (W6EMC)	4	7	647	—	658
W1JJ (W6IIG) made the B.P.L. on 155 message deliveries.					

Call Orig. Del. Rel. Extra Del. Total
W1MI (W3CXI) 278 198 1804 2280
A total of 500 or more, or 100 deliveries + Ex. D. Cr. will put you in line for a place in the B.P.L.
* Nov.-Dec.

Hams Afloat

W3EWO is operator aboard the S.S. *Gulphawk*, WJCO. The rig is an ET 3626 consisting of eight Type 211's. An ET 8003 is also carried for emergency use. . . . The *Gulphawk* runs between Philadelphia and Las Piedras, Venezuela, and W3EWO offers to listen for any hams who wish to make tests with beam antennas, etc. Address him at his call book address. . . . W3EIC is on the S.S. *Gulfpenn*, KDRX. . . . W4CPL is Sparks on the S.S. *Colorado*. . . . W2HRA has a berth on the S.S. *Dixie*, which runs from New York to New Orleans. . . . W5ASD, radio officer on the S.S. *Fairland*, KOSQ, noticed a good one in a story in a recent issue of the *American Magazine*—mention was made of "the clear, bell-like signals from a 2-kw. Navy spark"! . . . W5FXS is another "ham afloat" on the S.S. *L. L. Abshire*, WPCN. . . . It's hamfest season all year 'round on the U.S.S. *Idaho*! Eight radio amateurs are attached to that ship: W3EJL, W4GU (ex-W4AOR), W5DKX, W6NMS (ex-W4U), W6NZL (ex-W8KKY, W8KIG), W6OBC, W6OLR (ex-W9RLJ), W7GDZ. . . . W8KVX is still pounding brass on the Coast Guard Cutter *Tahoma*.

During bad weather the telegraph lines between North Head (Washington) Weather Bureau station and Portland and Astoria, Oregon, often fail for long periods of time. The weather man at this station is W7CQQ. When other means fail, he sends forecasts over his ham rig to Naval Radio NPE where they are put on land wires. Thus amateur radio is performing another real service.

January 1, 1937 found Big Bear Lake in the San Bernardino Mountains (California) snowbound and with no means of communication except amateur radio. The 2000 villagers and folks on holiday at the various resorts depended upon W6MN, Carl V. Teschan, Pine Knot, Big Bear Lake, to send words of reassurance to their families, food orders to grocers, explanations of absences to employers and directions to rescue parties. For sixty hours, with but brief snatches of sleep, W6MN kept the marooned populace in touch with the outside world. Regular contact was maintained with W6HOE (Monrovia), W6IRX (San Bernardino) and W6HUX (Los Angeles). W6FSF, W6LDK and John Le Borgne (W6LZD?) assisted at W6HOE. Hundreds of messages were handled.

On the evening of January 2d, W5DGP, W5CGJ and W5BCW relayed a death message to Dallas. CGJ heard DGP calling "CQ Dallas." CGJ raised DGP and offered his services, if needed. DGP gave him copy of the message so that he could keep trying to QSP while DGP QRT temporarily to copy Airways Weather report. CGJ then heard W5BCW calling DGP and made contact. It developed that BCW had intercepted the message while DGP was sending it to CGJ, and suggested phoning it to Dallas. W5BCW did this after W5DGP had returned to the air and given his okay. It took approximately one hour for the message to travel from point of origin to destination. Considering circumstances at the city of origin this was excellent time. The message originated at El Morro, out in the sticks in western New Mexico. That entire area had just experienced a very heavy snowfall, which completely isolated residents and the only possible means of getting information out was amateur radio.

OBSERVERS' HONOR ROLL

Cairo Commercial Occupancy Survey
For January 1937

6000-8000 kcs.	W8NQ
21,000-21,900 kcs.	W1BMW W9DII
W. R. Faries	

Briefs

From *Radio Guide* magazine the following "communication to the editor" is quoted:

"Sirs: Two weeks ago I heard the call for CQ over the amateur band. Since then I have heard CQ called over the short waves from every one of the 48 states, from Hawaii, Porto Rico, Cuba, Mexico and a dozen amateurs in Canada. Is CQ in distress? If so, the determined effort of thousands of amateurs to locate CQ reflects a trait of humanitarianism all too rare today."

Hi! We have heard CQ called many names, but none as nice as "humanitarianism"!

— . . . —

W4DNY is attempting organization of an amateur radio emergency net for the Georgia & Florida Railroad. Amateurs are needed in the following cities: In Georgia—Augusta, Midville, Swainsboro, Vidalia, Hazlehurst, Douglas, Willacoochee, Nashville, Valdosta. Statesboro, Broxton, Adel and Moultrie. In South Carolina—Greenwood, Edgefield. In Florida—Madison. Amateurs in these cities who would be interested in cooperating in an emergency net are requested to get in touch with I. W. Peters, Jr., W4DNY, 412 Seventh Street, Augusta, Ga.

— . . . —

The emergency service provided by amateur radio operators during the Florida Labor Day hurricane a year ago was praised in a report submitted on October 8th by the Committee on Research and Development at the closing session of the annual convention of the Telegraph and Telephone Section of the Association of American Railroads. The report recommended that the railroads consider the feasibility of arranging for the establishment of radio communication for use in emergencies when all other means of communication have failed. The committee said, "The splendid cooperation and untiring efforts displayed in the storm is indicative of the assistance that might be expected by the railroads in any major emergency with which they might be confronted."

— . . . —

O.B.S.

The following is a supplement to the list of A.R.R.L. Official Broadcasting Stations in October *QST* (page 122): W1HKH, W2ACY, W2IOP, W4BQD, W4DCQ, W4DVB, W5EAL, W5FZJ, W6MMV, W6NMT, W7BDD, W7DNP, W7EMT, W7FU, W7VS, W8CKC, W8MIW, W8NDE, W8OFN, W9RYV, W9CWW, W9IGZ, VE3AHK.

STATION ACTIVITIES

CANADA

MARITIME DIVISION

MARITIME—SCM, A. M. Crowell, VE1DQ—Flash! Margaret Hierlihy, sister of VO1I and VO4C, is the first licensed VO YL operator; her call is VOIS. Congratulations, Marge! HJ, new T.L. station in Halifax, sets a new high for this Section as Halifax terminal of Maritimes Net. HH, our new R.M., controls the Maritime Net and connects with the Pine Tree Net thru W1BR. HH finds traffic definitely on the up-grade with all net stations helping. Please include report of all traffic handled along with your station activities dope. Any O.R.S. or net station will gladly see that your report lands in Hfx. in time for S.C.M.'s report. All stations interested in net, get on at 6:45 p.m. A.S.T. and contact any net station or HH. BJ is back on 3.5 Mc. CO has completed the eight-tube superhet. AP is using 6L6 crystal osc. on 3.5 Mc. BE is chasing bugs out of the 'phone rig. AC has been trying to get his 6L6 to perk

better. AF is on the road to Florida. BD is going to take a crack at 14-Mc. 'phone. FR is getting out well on 7 and 3.5 Mc. with low power. KJ at Annapolis Royal is going well on 7 Mc. with 6L6. CW is one of our new net stations. BD is on 14 and 7 Mc. with pair of '45's. BZ gets on for net drill. EY has a new high-power rig. Fredericton news via VE1HM: HM got back on 3.5 Mc. after his trip to Camp Borden. 3DX from Fort William, Ont., now at the U.N.B., operates from HM. BO is back on 3.9-Mc. 'phone. JO, a new man on 7 Mc., is getting out nicely with single '45. GJ is getting FB reports on his 7-Mc. signals. IZ reports for the St. John gang and is getting out well with 16 watts input. BF is working 1.75-Mc. 'phone. FC and FU put out FB signals on 3.5-Mc. c.w. EE has a new quarter k.w. rig on 3.9-Mc. 'phone. IE, JN and FL are having excellent results on 1.75-Mc. 'phone. GP works 14 and 3.5 Mc. with T55 final. EI is working great DX on the old 3.9-Mc. 'phone. CE is still keeping that schedule with his brother, IV on P.E.I. FK is hitting it up on 14-Mc. 'phone. IF is working 28 Mc. at present. Valley News via EA: EA is going strong on 28, 14, 7 and 3.5 Mc. FE is building another rig—medium-powered, a.c.-operated, portable transmitter and receiver. BW hits the 3.9-Mc. 'phone hard. IW sneaks home from college occasionally to keep the rig hot. EX has rebuilt to be ready for the big DX. BV is on again after a year's absence from "hamming." KN is a new man in Truro. EQ is showing interest in 28 Mc. GD has been trying out the new 'phone rig he built for another ham. KP is a new man in Berwick. CU is crystal-controlled on 1.75 Mc. BU plans to try 28 and 36 Mc. BI has his eyes on 28 Mc. CV and his XYL were burned quite badly when the latter's clothing caught fire from a heater. GK in addition to traffic and net work makes the '46's work Europe on 3.5 Mc. CB is on 3.5 Mc with a 211 final. Moncton news via GI, secy-treas. M.A.R.C.: CX has remote control and is owner of nice equipment: new Class B's, power transformers, and new speech equip't complete with mixer. DC is mostly on 14 Mc. GI rebuilt, completely concealing all equipment in desk in order to keep the juniors away from shocks. GS had misfortune to lose power supply. EV is getting out well on 'phone using series grid mod. FF will increase power, using 6L6 tri-tet, 6L6 amp. JU is getting out well on 3.5 Mc. IJ's new rig, 53 osc., 6L6G's in P.P. is working all bands. KO, new ham, has 53 osc., 46's P.P. IL is QSO-ing again after long lay-off. Monthly M.A.R.C. meeting was held at VE1CX.

Traffic: VE1HJ 240 HH 140 BJ 13 FR 4 CW 5 IV 4 BZ 6 EY 4 GU 30 GK 42 EA 4.

ONTARIO DIVISION

ONTARIO—SCM, Fred H. B. Saxon, VE3SG—R.M.'s: VE3ABW, DU, GG, GT, MB, TM, WK, WX, SG. P.A.M.: NX. ABW made the B.P.L. this month on total and on deliveries as well. WK made it on deliveries. MB in Morrisburg blew three 82's, one 83, one 59 and one RK-20 in one smack. QK reports rebuilding with 6L6 crystal osc. S02 buffer-doubler, T55 second buffer and T200 in final. KT is attending Army course at London. AHK is O.P.S. and O.B.S. SS and VZ are qualifying for O.R.S. The Bracebridge gang reports as follows: AHO has rebuilt with 2A5 and '46; ABY is on 1.75-Mc. 'phone; AKJ is in Toronto at Radio College; ABM has 59 crystal osc. and 41 amp. EA reports for the Midland gang. GF has 59 crystal and P.P. '45's. VW blew his '46 buffers. WH has new 841 and new superhet. AAP has Sky Buddy super. EA has P.P. 825's in final; two Africans in a week make him W.A.C. GG is moving to Toronto. PH is QRL garage work. NJ does service work in St. Kitts. DW and the XYL are on 3809 kc. with 33 crystal osc., Ford coil plate supply with '01A rectifier, input 2 watts. VB on 14 Mc. uses vibrator plate supply and windmill generator. FZ is having a try at 3.9-Mc. 'phone. Lincoln Radio Club is using PT's rig until club rig is ready. TO worked OE3AH, SJ1AZ, SP1IH and ZL1FF, all on 7 Mc., with 30 watts input. We welcome AKD, ex-4VR, to Sudbury and the Section; he comes from the wide-open spaces, Calgary to be exact, where he was stand by op for 4CM on Trunk "1." SS is trying to rebuild between schedules. TM and OI are building up 1/2-kw. job for HK. AKW has 59 tri-tet, 841 buffer and '10's P.P. PL, HX, OR and SX helped Mr. Donald Stewart of Ottawa locate his brother

Ian who was last heard from in St. Catharine's; his father was seriously ill and in this case all other means had failed to locate him; who was the St. Catharine's ham who did most of the work? AU is designing a special QSL for his VK contacts as he now owes 75 cards. FW is new O.R.S. in Fort William. AHK is new O.P.S. and O.B.S. KM is proud daddy of new baby girl. Congrats, Wibb. HX is having modulator worries. HP has changed QTH to Chatham.

Traffic: VE3ABW 520 WK 243 GG 222 HV 188 SG 139 GT 101 DU 103 VZ 72 LI 46 MB 40 SS 37 MA 30 AGM 23 UO-OI 19 AEM 18 AE 14 AKW-YF-ZE 12 PL 9 QB 6 AHK 3 VE9AL 17.

QUEBEC DIVISION

QUEBEC—SCM, Stan Comach, VE2EE—Thanks to OM Winter, EX had to mend a broken feeder, BO had a broken halyard, JI had his metal mast come down in a very twisted condition, FK had to replace a broken topmast. BE has been getting reports from across the pond on 3.5 Mc. BO is back on 14 Mc. DC has 22,000 feet of copper wire buried for his ground. ER, with 7 watts input, has worked VE1, W9, and CO on 'phone. LJ is now remotely controlling his transmitter. LV has added an audio stage to the old Super-Gainer. FO blew a 211. BV slung a new antenna. CA purchased a new 750-watt bottle. Another YL joins the gang; Miss Varey has passed her tests. Congrats. DG is doing a noble job with the traffic lines; Doc makes the B.P.L. this month. FB, KN lost his antenna with the sleet. NB is a new call on the air; this is old 2BL of spark days. HT had quite a holiday with BW at Clova. EP is holding schedules with 15 major American cities. BK is putting an Eimac 100T in the final. KM is on 7 Mc. regularly. DO has 55T in the final. AW is completing new job using pair of 35T's final. AP is building another rig, capacity 600 watts. The French Clubs of Montreal and Quebec exchanged greetings on New Year's Eve with a solid contact lasting 4½ hours; those participating include AB, HL, EY, FS, KZ, JX, JY, IZ, EU, HG and their respective YL's and XYL's. EU is using a Super-Gainer receiver. HP purchased an FBXA. AG is trying 28 Mc. HG has worked 74 countries. FS is regularly on 3.5-Mc. 'phone. IP is using the Comach Coupler on 7 Mc. NF is a newcomer, Bienvenue. JY is changing his final from parallel to push-pull. ID is going Class A 'phone. MM is on 1.75-Mc. 'phone with high power. BH is operating 3.5 Mc. EV and KZ are having lots of fun on 28-Mc. 'phone. BG has new tube in final. IJ has a good signal on 3.9-Mc. 'phone. DD is also using 'phone on that band. HY purchased new receiver. LC sends us word of the passing of VE2MG. May I express my appreciation to EX, JK, KN, EP, HH, the Club Canadiens Français de la T.S.F. and all others who so kindly sent in news items. Keep it up. The more the merrier. The Quebec Division takes this opportunity to extend our congratulations and best wishes to Miss HH5PA on the occasion of her recent engagement.

Traffic: VE2KN 10 EE 11 EP 30 GO 4 JK 68 KM 9 IN 22 BU 100 EC 49 HT 25 CO 5 DR 352 LC 90 BB 114 HH 19 DG 677.

VANALTA DIVISION

ALBERTA—SCM, Alfred D. Kettenbach, VE4LX—GM is newly elected president of Board of Trade at Hanna. JJ distributed between 400 and 500 hampers to the needy in the Medicine Hat District. SK installed 6L6's in his transmitter and reports they couldn't take it. LA has been working some FB DX on 28 Mc. JW and GD visited LA and SW during the hunting season with a total bag of one rabbit by GD. GM had 24 YL's from the Hanna Business and Professional Women's Club on the air sending our Christmas greetings. ID is now located in Vegreville. CY handles new crystal mike like his old double button. RV gets K5 S9 reports from Vancouver with his flea-power rig. PH is W.A.C. and W.B.E. on 14 Mc. and claims first W.A.C. on 28 Mc. in Alberta. FI is having FB chats with his son in Chicago via W9UVC. The Calgary gang is working on the club transmitter. Two new hams on 7 Mc. are AFT and AFL. WX is still trying to figure out which of the three brother ops. he talks to at RY, while the trio at RY are busy most of the time tossing coins to see who is to operate the rig. OD is taking a try at 28 Mc. The Edmonton Club

organized to put on big hamfest in July. HM is trying an 807. LQ is on 1.75-Mc. 'phone. BP moved to new QTH (next door to old one). AH is rigging up rhombic ant. UJ is on 14 Mc. 3UZ visits club meeting. SW keeps daily schedule with CY. EO is secretary for the Friendship Society of Radio Amateurs in Canada. WX has finished grinding the crystals for the Alberta Provincial Net, and they are now operating spot frequency 3727 kc. ZN is now operating at Jasper. VM has seven tube home made super-gainer. YY gets out very well using three watts to an '01A. ST is using new rig on 7 Mc. AFI is new call of Bill at RY. AAZ worked IN, twelve miles away, by keying his receiver detector. ZZ is on 7 Mc. with two nice skyhooks. WZ is getting out well with 6L6 osc. BP is active after long lay-off.

Traffic: VE4LX 306 GE 50 LQ 35 WX 31 QK 19 CY 16 HM 10 AAZ 8 SW 6 EO 3.

PRAIRIE DIVISION

MANITOBA—SCM, A. J. R. Simpson, VE4BG—Trunk Line Station GC turns in the best traffic total for this season. GC keeps daily schedules east to 3FW, Fort William, and west to 4LX and 4FW. He has been appointed RM, succeeding AG. Stations desiring to arrange schedules are requested to get in touch with GC at 711 Ashburn St., Winnipeg, or over the air on 3690 kc. At Langruth WT is on 3.5-Mc. c.w. and at Binscarth, UV. In Winnipeg's sister city of Brandon, AU puts out 200 watts c.w. with a 211D final. IF keeps Brandon on the map on 3.9-Mc. 'phone. ACD at Dauphin keeps 3600 kc. hot. XP, at Dauphin, has a pair of 250's in a 3.5-Mc. B negative modulated 'phone rig. Dauphin is also represented on 3.5 Mc. by AFF. FV at Brandon works 3600 kc. FN at Langruth finds a pair of 71A's with 22 watts input from a motor generator. FB. AED at Boissevain is on 3.5-Mc. c.w. with a pair of 45's CG at Winnipegosis gets along nicely with an 89 oscillator running 8 watts from a motor generator. HC at Fisher Branch keeps his spot on the band. ZA located in the University at Fort Garry works with a 47 crystal oscillator and 10 final. ACF at Little Britain works daily 'phone schedules on 3.5 Mc. with AG at Winnipeg. EJ at Winnipeg is on 1.75 Mc. AE has completed a push-pull crystal oscillator using 6L6's. DU almost made W.A.C. within one hour but couldn't get a VK. GL works 'phone on 28 and 14 Mc. GQ is installing an RK-20 buffer. IP is changing to plate modulation. KX spends his time chasing 28- and 14-Mc. DX. LH has completed the 6A6 and 6L6 exciter. MY moved to new location. QA is moving to Vancouver. QC installed a new RK-23 buffer. QF is looking around for high-power equipment. SB bought a new receiver. UX has a new power transformer for his 242A's. AEB from Reedy Creek was a visitor to Winnipeg. The St. James Radio Club had a visit from CKY's traveling microphone and put over a very FB amateur broadcast. This is the first time anything like this has been done and the club deserves credit for the splendid way the broadcast was handled. Following the New Year the M.W.E.A. has resumed regular meetings and have a busy programme outlined. The Winnipeg Radio Club station JI has been active on 56 and 14 Mc.

Traffic: VE4GC 224.

SASKATCHEWAN—SCM, Wilfred Skaife, VE4EL—AEF puts out a real sock with his P.P. RK-20's grid modulation. Other Saskatoons on 3.9-Mc. 'phone are TN, RJ, UC and UD and are getting out fine. SP, new call for Saskatoon, was formerly Sen. Op. at QP, Elstow. LS has been visiting in Saskatoon. Blue Jersey Cows are getting common in this Section; you will hear them from CM, TN and AES. QZ gets out well between blowing rectifiers. JB has a 211 final in his 14-Mc. 'phone, grid mod. UG works Europeans on 14-Mc. c.w. BF, UD and BD are getting out well on 28-Mc. 'phone. WI puts out nice signal on 3.5 Mc. with flea-power. PQ knocks off K5's with little difficulty. FW is doing a fine job handling the Trunk Line and will receive any local traffic from the local net. ACR is handling any traffic that comes his way. KJ gets out fine on 3.5-Mc. 'phone. The yearly opportunity for making suggested changes in amateur regulations is here. Do not neglect to put forward your views. LJ has very nice signal on c.w. on 3.9-Mc. 'phone.

Traffic: VE4ACR 42 QZ 12 PQ 8 EL 7 KJ 5 MB 4.

(Continued on page 96)



CORRESPONDENCE

The Publishers of QST assume no responsibility for statements made herein by correspondents

Floods and QRM

2826 N. Western Ave., Indianapolis, Ind.

Editor, QST:

There is no question about it, the radio amateurs have brilliantly scored again, this time in their very efficient handling of flood traffic for and from the stricken areas. However, it is scorn that has prompted my writing this letter; yes, scorn for that small minority of selfish amateurs who clutter up the bands with their chatter when really serious work should be done in the cause of suffering humanity. I have nothing but contempt for them because they deserve nothing better. They are thoughtless, unsympathetic, egocentric and selfish. If they ever heard of the Golden Rule, they certainly have learned nothing about practicing it.

Here is an example: A certain amateur, operating on one of our best traffic bands from a stricken territory, was dispatching traffic of evident importance. He asked a certain operator of a high-powered station, who was conflicting with several traffic-handling stations, to please QSY lower in frequency, so that the important flood traffic could be promptly handled. The fellow of whom this favor was asked was "rag-chewing" with other high-powered stations, all very close together in frequency. I heard the favor asked, and can vouch that it was done not only unoffensively, but even with finesse; in as gentlemanly a manner as anyone could have done it. I remarked to myself at the time about the polish and tact of the operator who asked the favor. Now what happened? The operator who was asked to QSY remarked to his net that some amateurs attach too much importance to their message-handling; that the broadcasting stations were handling flood traffic; that some amateurs were seeking glory for themselves.

Mr. Editor and fellow amateurs, I consider such a spirit as nothing short of detestable. The broadcasting stations could *not* handle all the important messages with telephone and telegraph communication disrupted. Anybody who followed the amateurs and the commercial broadcast stations knows that. Within a few hours I heard one broadcast station thrice solicit the aid of radio amateurs. . . .

Amateurs who are unwilling to forego a little pleasure when a major crisis is going on are not worth their salt and they are a disgrace to the fraternity, in my opinion. What are we good for

if we are selfish in relation to those who are in dire need, when we ourselves are getting on nicely? The least we can do, if we cannot help, or if we prefer to stay out of it, is to cease operation, temporarily, to let others carry on urgent work unhampered; to do well by doing more listening and less unnecessary transmitting that causes expensive interference. . . .

—Joseph A. Terstegge, W9LQE

A Lesson

8527 Germantown Ave.,

Chestnut Hill, Phila., Pa.

Editor, QST:

Several nights ago I witnessed as pretty a demonstration of 'phone operating as I ever hope to see. It had to do with the flood emergency work. The station on this end was our Atlantic Division Director, W3QV.

QV had two receivers running. With one he guarded 3610 and one of the N.C.R. frequencies outside the 80-meter band, shifting around from one to the other; with the other receiver he kept track of doings at either end of the 80-meter 'phone band, and working schedules with up-state 'phones periodically. The beauty of it was in the perfect airways standard of operating: one call and one sign, as short and concise wording as possible with no code abbreviations and "Q" signals to be misunderstood, seldom more than 30 seconds on the air without breaking to see how it was reaching the other station and in case of interference a stand-by until it cleared up.

You may wonder why all the raving, but it has a point: It appears to me from what I saw at QV's that the 'phone bands are in their present shape just because the majority of 'phone operators are too lazy to build their rigs so that a single push on the button will put the whole rig on the air and so that they can merely release that pressure on the button at any time, the oftener the better, to know how the other chap is getting it. The tendency is to be *broadcast* stations and not *telephone* stations. The ideal of question and answer can be easily achieved without the necessity for VODAS operation if the 'phone men will only be willing to wiggle their fingers occasionally. My trans-con sked with W6CUU would be next to impossible without break-in; we occasionally have to wait for several minutes while some Mexican broadcast amateur or local

blooper gets through mushing things. How much more necessary is it, therefore, in the case of many 'phones working close together to know the condition of your own and the other fellow's channel at all times as nearly as possible? Fast break-in would be the making of the 'phone bands I feel sure; the code bands are pretty much that way already just by being code, but there is room for improvement there, too.

—John Buck Morgan, W3QP

International Situation

57 Waterman St., Providence, R. I.

Editor, *QST*:

Highly astonished and with deepest regret I read Mr. Kreisinger's letter on "Condemning Spanish News" in *QST*, January, 1937, and I have at first to emphasize that there never has been or will be a difference in the ham spirit in Germany compared with the international standard. If a German station was telling about our common friend EA4AO, he never would think anything as Mr. Kreisinger prefers to believe, and I have to protest in the name of all German amateurs as well as all hams in the world against such an inferior thinking.

I regret to ask the Editor of *QST* for publication of this letter, but I like to show all our brother-hams who have not had the opportunity to chew the rag with German stations, that there is no reason to believe Mr. Kreisinger's theory. That German hams follow the universal laws of international fairness is needless to say.

The only fact which may excuse Mr. Kreisinger is that he maybe never did work German stations (possibly he is no ham at all, since he signs without call), but it is always the wrong way to judge on things without any practice in the problem in question. . . .

—Chris Schmelzer, D4BU

EDITOR'S NOTE: *QST* has said that it will not tolerate international politics in its columns. The German point of view having now been expressed by Dr. Schmelzer, the present discussion is declared closed. No further letters on matters of international politics will be published.

Silent Key

1758 Workman St., Los Angeles, Calif.

Editor, *QST*:

With a broken heart I am writing you this to inform you of the passing of one of the few old-time amateur operators, Horace Howard Johnson (W7EUR), who is now among the "Silent Keys." Born in Hartford, Conn., in Aug. 22, 1870. Dad lived in Quincy, Mass., at the time of Marconi's first experiments and with a needle balanced on two pieces of carbon and a crude coil listened to Jack Binns' CQD when the old *Republic* went down. As an electrical engineer he was intensely interested in "wireless" and followed Alexander's development of the high-frequency alternator with keen interest, worked the old Brant Rock station and had a station on the air back in 1910 when we used to be able to "bawl out" the Boston Navy Yard about QRM, in the days when the ham had as good or better stations than the government.

In 1912 he went to the Pacific Coast and worked at the old Council Crest station in Oregon and when I took out a license in 1916 with the call 6AEA he operated with me. I still have one of the first audion bulbs used by him in 1914.

When I went to sea in 1917 he gradually dropped out of active amateur work although keeping abreast of developments, and then in 1927 he became again intensely interested in "short wave" development although heart trouble which finally caused his death kept him on the "quiet" list.

Active here at W7ESE, portable at the above address. His last transmission recorded in the station log was on the five-meter rig with W6JHO on Sept. 25th.

We came down here from Rogue River, Oregon, several months ago hoping the lower altitude would benefit him and brought only our little 56-Mc. rig along.

I have attempted my first QSO to-night since he passed away but it doesn't have the "flavor" now it used to. Everything here was made by him. . . .

A master craftsman, a fine operator, a pioneer in amateur radio and a perfect and devoted father has joined the Silent Keys, leaving a gap that will never be filled. . . .

—H. L. Johnson, W7ESE

Local Static

1612 Bonnie Brae, Houston, Texas

Editor, *QST*:

I have just completed the reading of "Local Static" by Karl Detzer. This work of art is found in the January, 1937, issue of the *American Magazine*.

I have known for some time that we are getting some adverse publicity due to the fact that so many of us find it necessary to improve our quality and response by playing phonograph records and in some few instances even crooning. No doubt, we deserve to be punished, but I am wondering if the punishment is not too severe in this instance.

On the other hand, perhaps Mr. Haley of the Cornland Radio Corporation was right in his letter to Mr. J. B. Passmore when he stated, "I don't like to be discourteous, but what do you think I've been sitting up nights for, listening in on the short waves to all the adenoidal fools in the world talking to one another about nothing at all?"

—J. N. Royall, W5HU

Calling DX

Coromandel, P. O., S. India

Editor, *QST*:

Much has already been written from time to time in *QST* regarding the various methods of calling a DX station, but the result of my experience is that the advice given is ignored, so it would appear that "Advice is a useless thing"—a wise man does not need it, and a fool won't take it.

I have known "W" stations to call me for over 40 times and then sign thrice quickly, with the result that, although in the clear when calling me, when signing they have been blotted out by QRM. I often ignore a station that calls and calls without signing, as past experience shows that for the above reason it is a sheer waste of time.

The stations that have so far been successful in contacting VU7FY are those who have frequently inserted their call-signs when calling, and it is this type of snappy operator that gets home every time, on the wall of his shack may be seen the WAC certificate.

May I request "W" stations to call thrice, then sign thrice, in fact sign oftener than call. I have receivers here and they are in use, and it is your call-sign that I want to give you the contact, I know my own off by heart. Please repeat the process thrice and then sign and send AR K, if I am listening I have got you first time, if I am not listening then you are wasting your time. Very 73 to you all.

—O. A. F. Spindler, VU7FY

More Power With Less

3866 Orloff Ave., New York City

Editor, *QST*:

In February's *QST*, Mr. Curtis, W1EXZ, presented a very workable plan to reduce QRM on the ham bands. His plan is one which should be given much thought as it gives us a chance to reduce interference and increase enjoyment on our bands. Mr. Curtis said everything that could possibly be said in favor of low power. To gain a larger and broader understanding of the points made in his article, we should all read Mr. G. H. Johnstone's article, which won the C.D. Contest for February. Now, put the two articles together. The first, low power, plus the second, a selective, sensitive receiver, equals less QRM and more enjoyment for all. Let's consider these sensible suggestions so that we all may end up by saying more power to less power!

—R. Bach

(Continued on page 66)



IN THE last few months we have received a great many letters from amateurs who wished to know whether we planned to bring out a new model of the HRO. We do not plan to, for we have not discovered any improvements important enough to warrant a new design. It is not from want of trying. During the two years since the HRO first appeared on the market, our research laboratory has tried out many schemes for making the HRO better. The principal result of all this work has been to confirm our feeling that the original design of the receiver was darn good.

There have been a few minor improvements in the original design, but these changes were made as soon as possible, instead of filing them away for use on a new model. Oddly enough, the greatest change has been in the dial. The bright-metal finish had a tendency to tarnish, and was tiring on the eyes as well. A special kind of enamel having the necessary toughness was found, and dials are now being finished the new way.

Air-core IF transformers have been slightly improved from time to time since the HRO was first designed. These refinements did not result in any very notable increase in performance, and as far as HRO is concerned, were of very little practical importance because the crystal filter supplies extreme selectivity when needed. Nevertheless, these improvements in the IF were incorporated in the HRO, largely because it is our policy to keep the HRO up-to-the-minute in every detail.

Most of the letters we received also asked whether we planned to use metal tubes. We have no objection to metal tubes as such, but neither do we see any great virtue in them, at least as far as the HRO is concerned. In particular, we greatly prefer 2.5 V. heaters to the 6.3 V. variety. As we have remarked before on this page, the latter are not entirely hum-free. The amount of this hum is very small of course, and is apparent only in extremely high gain receivers. However, the HRO is very definitely a high gain job, and in it the 2.5 V. tubes are definitely less noisy.

There have been other minor changes in the HRO now and then (such as the addition of a pilot light) but these are too unimportant to warrant listing here. The fact is that the basic design of the HRO has proved to be unusually sound. This pleases us very much. Some two years ago we ran an advertisement in *QST*, pointing out that National Receivers had high resale value because they grew old so slowly. When that copy was written the HRO was very, very new and the FB-7 was in its heyday. Today the HRO is the standard of comparison, but the FB-7 is more popular than it ever was. Even the SRR (four years old) and the SW-3 (nearly six years old) still keep on making new friends and holding old ones.

JAMES MILLEN





SPECIAL

WE'LL PAY HALF THE COST

A TYPE FOR EVERY NEED

Resistance	Type No.	Curve	Usual Application
500 Ohms	11-103	A	Potentiometer Voltage Divider
1,000 "	11-108	A	Potentiometer Voltage Divider
2,000 "	11-110	A	Potentiometer Voltage Divider
3,000 "	11-112	A	Potentiometer Voltage Divider
4,000 "	11-113	A	Potentiometer Voltage Divider
5,000 "	11-114	A	Potentiometer Voltage Divider
5,000 "	13-114	C	Antenna Control
10,000 "	16-116	F	*Antenna Grid Bias of 1 Tube
10,000 "	11-116	A	*Antenna Grid Bias Control
10,000 "	14-116	D	*Antenna Grid Bias of 2 Tubes
10,000 "	13-116	C	Antenna Control
15,000 "	14-118	D	*Antenna Grid Bias Control
15,000 "	16-118	F	*Antenna Grid Bias Control
20,000 "	16-119	F	*Antenna Grid Bias Control
25,000 "	14-120	D	*Grid Bias Control
25,000 "	11-120	A	Potentiometer Voltage Divider
25,000 "	16-120	F	Antenna Control
50,000 "	11-123	A	Potentiometer Voltage Divider
50,000 "	13-123	C	Tone Control
75,000 "	13-125	C	Tone Control
75,000 "	14-125	D	*Grid Bias Control
100,000 "	11-128	A	Potentiometer Voltage Divider
100,000 "	13-128	C	Tone or Audio Circuit Control
200,000 "	11-129	A	Potentiometer Voltage Divider
200,000 "	14-129	D	*Grid Bias Control
250,000 "	13-130	C	Tone or Audio Circuit Control
500,000 "	13-133	C	Tone or Audio Circuit Control
500,000 "	11-133	A	Potentiometer Voltage Divider
500,000 "	13-133X	C	Tapped Tone Compensation
1.0 Meg.	13-137	C	Tone or Audio Circuit Control
1.0 "	13-137X	C	Tapped Tone Compensation
1.0 "	VC-539	Spec.	Fader
2.0 "	13-139	C	Tone or Audio Circuit Control
3.0 "	13-140	C	Tone or Audio Circuit Control
10.0 "	11-143	A	Potentiometer

Wattage rating at full rotation — 1 watt.
*External 300 ohm B T-½ Grid Bias Resistor Included.

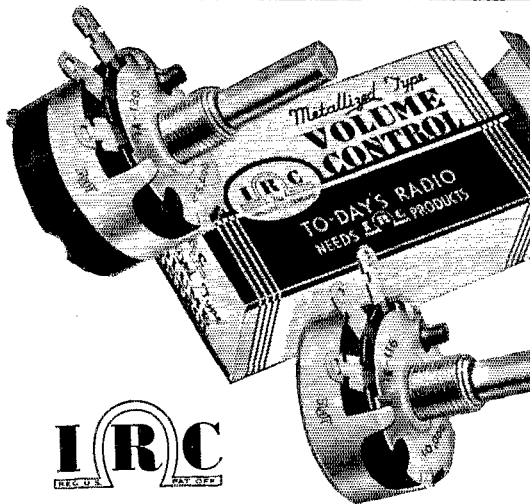

Metallized CONTROLS

Prices —

IRC Control without switch (Plain cover) List Price \$1.00 — Your NET **60¢**

Switch Prices —

No. 21 — Complete cover and switch — Single Pole — Single Throw, List 50c, NET **30¢**

No. 22 — Complete cover and switch — Double Pole — Single Throw, List 60c, NET **36¢**

No. 23 — Complete cover and switch — Single Pole — Double Throw, List 60c, NET **36¢**

● FEATURED BY THESE LEADING JOBBERS ●

Packard Radio Co., Fort Smith, ARK.
Beem Radio Co., Little Rock, ARK.
Herbert H. Horn, Los Angeles, CAL.
L. J. Meyberg, Los Angeles, CAL.
Radio Tele. Sup. Co., Los Angeles, CAL.
Dow Radio Supply Co., Pasadena, CAL.
Offenbach Elec. Co., San Francisco, CAL.
Harry Moll, Inc., Denver, COLO.
Hatry & Young, Bridgeport, CONN.
Hatry & Young, Hartford, CONN.
United Radio Sup. Co., New Britain, CONN.
Hatry & Young, New Haven, CONN.
United Radio Sup. Co., Waterbury, CONN.
Wilmington, Elec. Spec. Co., Wilmington, DEL.
Capitol Radio Whisers., Washington, D. C.
Rucker Radio Whisers., Inc., Wash., D. C.
Radio & Electric Service, Fort Myers, FLA.
Cooper Radio Co., St. Petersburg, FLA.
Capitol Radio Labs., Tallahassee, FLA.
Wholesale Radio Ser. Co., Atlanta, GA.
Augusta Radio Co., Augusta, GA.
Allied Radio Corp., Chicago, ILL.
Electric & Radio Supply, Chicago, ILL.
Newark Electric Co., Chicago, ILL.
Radiolec Co., Chicago, ILL.
Wholesale Radio Ser. Co., Chicago, ILL.
Otta & Songer, Decatur, ILL.

Jay's, Inc., Peoria, ILL.
Wilhelm's, South Bend, IND.
Arthur's Radio Co., Cedar Rapids, IOWA
A. A. Schneiderhahn Co., Des Moines, IA.
Gates Motor Sup. Co., Independence, IOWA
P. I. Burks & Co., Louisville, KY.
Dixie Electric Co., Lafayette, LA.
The James Bailey Co., Portland, ME.
North Radio Co., Baltimore, MD.
Radio Elec. Service Co., Baltimore, MD.
Radio Ser. & Sup., Cumberland, MD.
Eastern Radio Co., Cambridge, MASS.
Woodrow Radio Co., Cambridge, MASS.
C. E. Beckman Co., New Bedford, MASS.
Pittsfield Radio Co., Pittsfield, MASS.
Radio Maint. Sup. Co., Worcester, MASS.
Welemeyer Radio Co., Ann Arbor, MICH.
Harold G. King Radio Sup., Detroit, MICH.
Radio Parts, Inc., Detroit, MICH.
Serlin Stores Corp., Detroit, MICH.
Radio Eq. Sales Co., Grand Rapids, MICH.
Budd's Music House, Lansing, MICH.
Electric Products Sales Co., Lansing, MICH.
Fitzpatrick Elec. Sup. Co., Muskegon, MICH.
Northwest Radio, Duluth, MINN.
Lew Bonn Co., Minneapolis, MINN.
Lew Bonn Co., St. Paul, MINN.

Burstein-Applebee Co., Kansas City, MO.
Radiolab, Kansas City, MO.
Electric Lamp & Supply, St. Louis, MO.
Aaron Lippman Co., Newark, N. J.
Wholesale Radio Service Co., Newark, N. J.
Advance Radio Corp., Paterson, N. J.
Wm. H. Allen Co., Albuquerque, N. M.
Dare's Radio Service, Auburn, N. Y.
Radio Equipment Corp., Buffalo, N. Y.
F. C. Harrison, Elmira, N. Y.
Stallman of Ithaca, Ithaca, N. Y.
Gross Radio, Inc., New York City, N. Y.
Sun Radio Co., New York City, N. Y.
Terminal Radio Corp., N. Y. C., N. Y.
Wholesale Radio Ser. Co., Bronx, N. Y. C., N. Y.
Wholesale Radio Service Co., N. Y. C., N. Y.
Howe & Rogers Co., Rochester, N. Y.
W. E. Berndt, Syracuse, N. Y.
Roy C. Stage, Syracuse, N. Y.
Vaeth Electric Co., Utica, N. Y.
Weber Radio Corp., White Plains, N. Y.
Shaw Distributing Co., Charlotte, N. C.
Lewis Sporting Goods Co., Raleigh, N. C.
Brighton Sporting Goods Corp., Akron, O.
Steinberg's, Cincinnati, O.
United Radio, Inc., Cincinnati, OHIO

INTRODUCTORY OFFER . . .

OF YOUR FIRST CONTROL

. . . TEST THE WORLD'S FINEST CONTROL FOR YOURSELF . . .

THIS unusual offer is being made because we KNOW IRC Metallized Volume Controls are their own best advertisement. We KNOW you'll like them.

We KNOW you'll be more than pleased with their permanent **QUIETNESS**, **SMOOTHNESS** and **DURABILITY**—and that you'll quickly recognize them as the finest controls ever offered to the Radio profession.

. . . And so, to get you to try one at once, we'll actually **PAY HALF THE COST** of your first IRC Metallized Control. Just sign the attached coupon and mail or hand it to your nearest IRC Jobber. He will accept it as 30c **IN CASH** toward payment of any standard IRC Control. This means the Control will cost you only 30c—exactly one-half the regular price of 60c net. List price is \$1.00.

Try the Control! Test it! Use it in the most critical circuits where you have had trouble or noise with ordinary controls. We'll rest all of our claims on what the IRC Control **PROVES** to you!

INTERNATIONAL RESISTANCE COMPANY
401 NORTH BROAD STREET PHILADELPHIA, PA.

JOBBERS—CONTINUED

Ferguson Radio Supplies, Cleveland, O.
The Frankelite Co., Cleveland, O.
Radio Servicemen's Sup. Co., Cleve., OHIO
The Winteradio, Inc., Cleveland, OHIO
H & W Auto Accessories Co., Toledo, OHIO
Ross Radio Co., Youngstown, OHIO
Southern Sales, Oklahoma City, OKLA.
Radio, Inc., Tulsa, OKLA.
Northwest Radio Sup. Co., Portland, ORE.
Stubbs Electric Co., Portland, ORE.
United Radio Supply, Inc., Portland, ORE.
Hollenbach's Radio Service, Altoona, PA.
Jordan Radio Laboratory, Erie, PA.
Cambria Equipment Co., Johnstown, PA.
Herbach & Rademan, Philadelphia, PA.
M. & H. Sporting Goods Co., Phila., PA.
Radio Electric Service Co., Phila., PA.
Eugene G. Wile, Philadelphia, PA.
Cameradio Co., Pittsburgh, PA.
Radio Service & Sup. Co., Scranton, PA.
Kraus & Co., Providence, R. I.
Wescoast Radio Shop, Charleston, S. C.
Bradford Radio Sup. Co., Columbia, S. C.
Dakota Radio Corp., Yankton, S. D.
J. Harper Stoddard, Memphis, TENN.
Amarillo Electric Co., Amarillo, TEXAS
Dallas Electric Supply Co., Dallas, TEXAS
Straus-Frank Co., Houston, TEXAS
Felt Radio Co., Salt Lake City, UTAH
Radio Supply, Inc., Salt Lake City, UTAH
Radio Supply Co., Norfolk, VA.
Johnston-Gasser Co., Richmond, VA.
Northern Radio Co., Seattle, WASH.
Wedel Company, Seattle, WASH.
H. H. Kyle & Co., Charleston, W. VA.
MacFadden Ignition, Charleston, W. VA.
Professional Radio Sup., Clarkburg, W. VA.
White Electric Co., Clarkburg, W. VA.
King & Irwin, Huntington, W. VA.
Sound Systems, Inc., Huntington, W. VA.
Sunny's Auto Sup. Co., Parkersbg., W. VA.
Cameradio Co., Wheeling, W. VA.
Ott-Hotchkiss Co., Wheeling, W. VA.
Ne-Jed-Lo Radio Sup., Green Bay, WISC.
Central Radio Parts Co., Milwaukee, WISC.
Radio Laboratories, Inc., Milwaukee, WISC.

THIS COUPON IS

GOOD FOR 30¢

IRC Jobbers throughout the United States are hereby authorized to accept this coupon as 30c in cash toward payment of one standard IRC Metallized Volume Control. All standard IRC Controls are priced at \$1.00 list, 60c net. This means that this coupon and 30c cash entitle the bearer to one IRC Control under terms of our special half-price introductory offer as advertised in QST for March, 1937. Coupons must be signed by bearer on lines below.

Coupons accepted by jobbers under this offer will be redeemed at full value by IRC.

Coupon Void After April 15th, 1937

INTERNATIONAL RESISTANCE COMPANY, 401 N. Broad St.
Philadelphia, Pa.

Name of purchaser _____

Address _____ City _____

Serviceman Amateur Experimenter

Jobber _____ City _____

Only One Control To A Customer Under This Offer

Use tubes with

S P E E R
G R A P H I T E
A N O D E S

for extra service
and satisfaction

Tubes with Speer Graphite Anodes offer you

1. Long life.
2. Constant characteristics.
3. Maximum wattage dissipation.
4. Absence of hot spotting or warping.
5. Resistance to damage from overloading.
6. Remarkable uniformity.

Names of well-known tube producers using SPEER Graphite Anodes and booklet with authentic information sent on request. Write.



SPEER CARBON COMPANY
ST. MARYS, PA.

Ⓜ7070

Correspondence

(Continued from page 62)

Hi-vs.-Lo Scheme

5113 Cleveland Ave., Lincoln, Nebr.

Editor, *QST*:

About every so often a ham must "air" his views in print—not that it does a whole lot of good but somehow it affords a lot of personal pleasure and satisfaction to let off steam on some burning amateur issue. So I've chosen the Correspondence Section of *QST* as the logical place to put forth my pet idea. I know I'll receive some worthwhile rebuttal that will probably give me plenty of angles on the question that never entered my head.

Yes, it's the same old thing—High Power vs. Low Power. I have no permanent solution to this raging controversy but possibly an idea which might bring temporary relief and be workable if conformed with wholeheartedly. What I have in mind is this:

That each week, one twenty-four hour period be set aside in which only United States amateurs using 200 watts *input* (manufacturer's tube ratings) or under could operate.

That each week, one twenty-four hour period be set aside in which only United States amateurs using more than 200 watts *input* (manufacturer's tube ratings) could operate.

That this plan apply to all amateur bands both 'phone and c.w., except 5 and 10 meters.

That these twenty-four hour periods be rotated so that it wouldn't work a hardship on the fellows having to work certain days in the week.

I realize that this would be a restriction in particular on the operating of all low-powered men (I'm one of 'em), because we would have to remain quiet during the high-power twenty-four hour period. The high-powered boys could lower their input and operate all the time but out of courtesy's sake I don't believe they would. Even if they did come on with a reduced input it would still be a blessing to have those kilowatt rigs cut down one day in the week.

To me it seems a possible solution for obtaining a better chance at hearing and working those far away DX stations which now are always covered up by heavy "W" QRM. If the idea was tried we might draw some valuable conclusions. I expect the first several times it was attempted the QRM would be about the same as usual as we'd all be on, but would improve after several months. . . .

—Hugh Foster, W9FWL

Stamps

5 Robijnstraat Berchem, Belgium

Editor, *QST*:

Here goes an offer to all W/VE hams!

I will send free every two or three months a bunch of European stamps of different countries and value to one or more hams under the following conditions:

1. Only bona fide stamp collectors shall ask for them, tradesmen abstain. . .
2. No swap or trade offers, as I don't care for stamps and hate all profit-making ideas in ham circles.

Preference will be given to hams of my age (30) who are fighting for their butter in the newspaper jungle as I do. But don't rush, fellers—it isn't King George's collection.

—J. M. Van De Velde, ON4MO

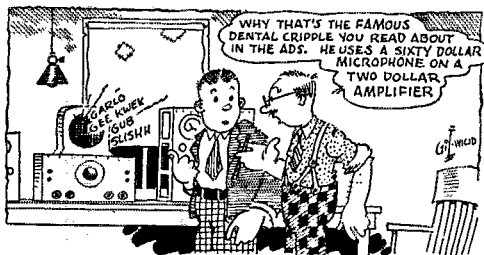

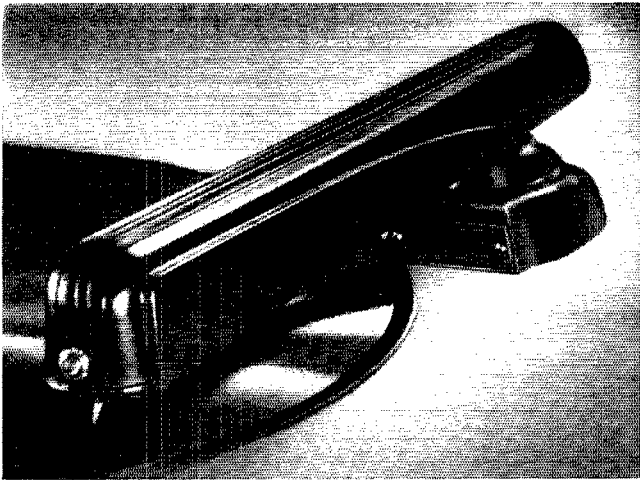

ANNOUNCING
★
THE NEW SHURE
ZEPHYR

BALANCED-TRACKING CRYSTAL RECORD REPRODUCER

● The Shure ZEPHYR is *not* just another pickup — it's *entirely new* — *utterly different!* Basically new design features now bring you *more accurate, more life-like* reproduction of the recorded original . . . *decidedly longer record life* . . . and new, beautiful "aero-stream" design in black bakelite molded . . . at low cost.

Built-in "Balanced-Tracking," provided by the new exclusive Shure "needle-tilt" principle, keeps the needle practically tangent to and centered in the record groove at all times—thus materially reducing record wear. Here, for the first time, low-tracking error has been achieved in combination with new modern "streamline" design!

And these features, too, are important! . . . ★ "Ultra" wide-range response — corrects for deficiencies in recording characteristics ★ Full-floating double precision ball-bearing pivot ★ Double moisture-proof, fully electrostatically-shielded crystal ★ Mechanically "shock-proof" critically damped moving system ★ Special "high-lift" arm for convenient needle-changing.

List Price **\$12**

See your Jobber for complete information or write for Bulletin 142Q today!

Licensed under patents of the Brush Development Company. Shure patents pending.

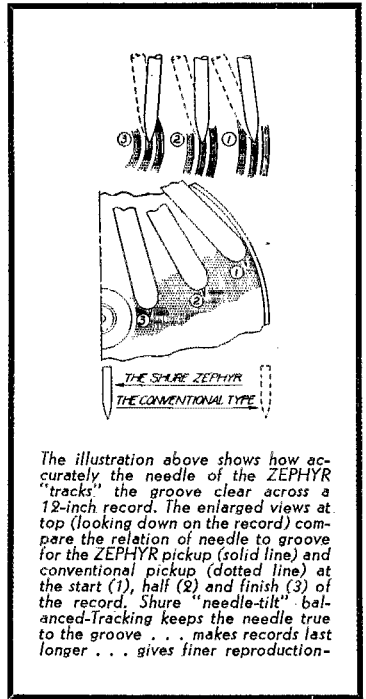

The illustration above shows how accurately the needle of the ZEPHYR "tracks" the groove clear across a 12-inch record. The enlarged views at top (looking down on the record) compare the relation of needle to groove for the ZEPHYR pickup (solid line) and conventional pickup (dotted line) at the start (1), half (2) and finish (3) of the record. Shure "needle-tilt" balanced-tracking keeps the needle true to the groove . . . makes records last longer . . . gives finer reproduction-

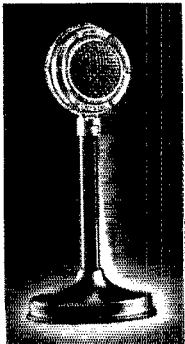

**THE SHURE 70S
COMMUNICATIONS-TYPE
CRYSTAL MICROPHONE**

The Shure 70S was the first microphone specially designed for high-efficiency voice transmission. Gives clear, crisp 'phone signals that cut through noise and static . . . actually **DOUBLES** power on important intelligibility speech frequencies. Widely used on police, airway, commercial and advanced amateur radio-telephone transmitters.

List Price, with Desk Mount **\$25**

SHURE Cable Address SHUREMICRO
MICROPHONES
SHURE BROTHERS • MICROPHONE HEADQUARTERS
225 WEST HURON STREET • CHICAGO, U. S. A.

Ol' Man Centralab broadcasts-

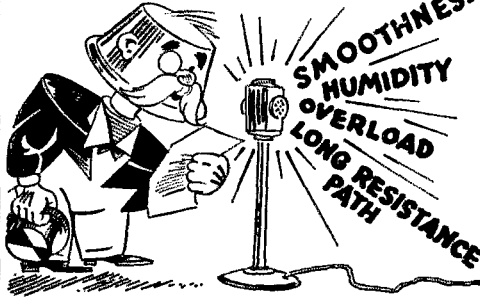

That genial chap... the friend of servicemen and experimentors takes time out to remind you that every control problem can be met (better and easier) with CENTRALAB CONTROLS. Smoother — because of the long, non-rubbing contact, they give "profitable" service for a long time. Change to CENTRALAB.

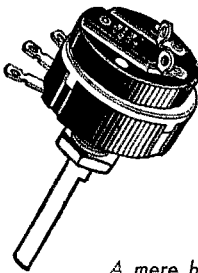

A mere handful will service practically any set — old or new

Volume Controls
Fitted Resistors
Selector Switches

Centralab

Milwaukee, Wisconsin

British Centralab, Ltd.
Canterbury Rd., Kilburn
London N.W.6, England

French Centralab Co.
118 Avenue Ledru-Rollin
Paris XI, France

Calls Heard

(Continued from page 47)

HB9AD, Robert Staempfli, Brunnadernstr. 50, Berne, Switzerland

(Sent via HB9AD-W2BMX on 3.5 Mc.)
(3.5-Mc. band)

w1ajl bft bjp bnc cov dld dcm emh ewf ez glz gul hky hse
hyu iom iov ixb jlm jpe jtb jvh pi ts zl w2bbq bvp bmx cfi
ccz czo dnr dnx dup dyo gdf ggw hnp htx hxi iom hxy ikk
iww jmn jfc kbq w3awh awu bes bdl bgo bip eea edp esz
eic emr enx fiy fkj fra ftk gci nf qv w4dq eou se w6hgl tap
w7byx w8axe bas cnc dhh dmo eth eny fip fjn fu gfv gps
hmi kwa kun ida ldm lmi nle npy nyj ofn imb w9aut aqh
spb uit nylaa velij ve2lc ve2dv ve2lv volx

Ben Chiles, 19 Perkin St., Port Elizabeth, South Africa

(14-Mc. band)

kalch ka1me lu4bh lu4lg pk1xz pk3gd vu2cq w1ajz widic
wlgeb wlgix w3ahs w3bfh w3bma w3crg w3exc w3fih w6am
w6ish w8cbw w9as w9fei

W6OJW, B. W. Southwell, 3475 Margarita Ave., Oakland, Calif.

(14-Mc. band)

sulch zt6au zs2x zs4j zu5x es2c oh3np zelis sm5uu g6oj
ka1me on4vk vs6aq

W2EWM, Chester Voorhees, 466 Stuyvesant Ave., Irvington, N. J.

(Heard on a 2-tube receiver—Nov. 12th—Jan. 25th)
(14-Mc. band)

en8mk etlby etlpe ex1bu ex1eb d3bwu d3feh d4hef d4ltn
d4xbg d4xog eiaj ei8b fa8da fm8aa fy8ce g5qx haf8d hb9bd
hcljw hc2mo hj1ca hslry ilir k6ilt k7fru k7pq la1h la2b
la3q la4k la5r la5x lu2fr lu4bh lu4dq lu6dj lu6jb lu7az
lu8dj ly1j oa4j oh2ne oh2ob oh3np oh5oa oh5od oh6ns
ok1mb ok2lo on4di on4fp on4fq on4jo on4pa oz2b oz2m
oz2xa oz3j oz7cc oz8as pa0az pa0ds pa0ff pa0iw pa0lb
pa0mdw pa0mq pa0mw pa0sd pa0xf pylaz pylbr pylrd
pyldk pylrdw pylrf py2ac py2bu py2fy py2gs py2hn py3cj
py4au py7ab py7aj py8ae sp1cc sp1fu sv1ke tf5c ulbc
u2nc u2ne u3as u3qe vk2dk vk2zh vk3al vk3ng vk3re vs1aa
vs7rf ym4aa ym4al yv5ap zllgx zs2x ztlz zt5m zt6w zu6af

W9PTF, Arthur J. Pinard, 1605 Flett Ave., Racine, Wis.

(28-Mc. c.w.—Dec. 24th—Jan. 4th)

d3dsr d4kpj d4jqu d4xqf ei5f ei8b f3kh f8ct f8dw f8ob f8ol
f8nj f8vs f8wk fm8aa g2hg g2io g2pn g2zp g2zh g2oa g2rd
g2xc g2wq g2nm g5rf g5qy g5zt g5li g5an g5cn g5yr g6wn
g6dh g6nf g6qz g6wy g6pd g6zv g6rh g6ir g6lk hb9j hb19
k5ac oh5ng ok2ra ok2rm on4ap on4fec pa0mq pa0az pa0vb
pa0xr sm6wl xelom xelam zel1jr zs1h zult

W5FQN, Dick Legg, 701 N. E. 14th St., Oklahoma City, Okla.

(14-Mc. c.w. band)

zu6af zt6au zu6e zu6l py1mk py1ci py2bz py2ej py2gs cp1ac
pa0zb pa0qf pa0an oh3od g2yd g6rg vk2ce vk2zy vk3vf
vk3eg vk3wp vk4xcg d4dlc i1tkm j2cb z12rx z12sx
(14-Mc. 'phone band)

zs4j py2ac lu4bh

W8MKA, Ken Hanson, 44 Charles St., Iliion, N. Y.

(7-Mc. band)

d4yfi fa8ih g2ao g5gq hh2g hh5pa hk5jd k4aan k5ac ny2ac
oe3ah sv1sm vp2ga yslfm

(14-Mc. band)

en8mb ep3ane fm8aa hh3l j2kj j2jj j2mh j5cc oh6ns oz7cc
sp1ln sulch u3qe ym4aa

W9DBC, Joseph B. Tomczyk, 1322 Monroe St., N. E., Minneapolis, Minn.

(28-Mc. band)

cm2fa cplane d4sno f8ct f8ol f8vs fm8aa g2ao g2mv g2pl

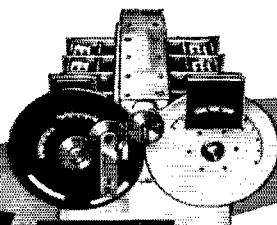

TUNING UNIT

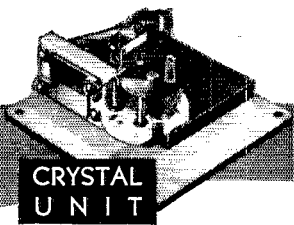

CRYSTAL UNIT

STANDARD "SUPER-PRO" RECEIVER CHASSIS

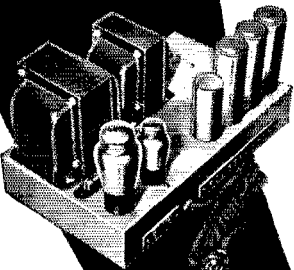

STANDARD "SUPER-PRO" POWER SUPPLY CHASSIS

The LAST WORD

A SUCCESSFUL radio receiver intended for use over a wide frequency range as well as a wide variety of services must necessarily possess many varied and unusual characteristics. That the new "Super-Pro" completely meets these exacting requisites by means of advanced design and extreme flexibility—rather than by the many compromises resorted to so frequently—is being attested to daily by the many ultra-critical amateurs, engineers and professional operators now using the new "Super-Pro."

Among the exclusive features in this new 16 tube "Super-Pro" receiver are the accurately calibrated panel controls: viz. — 3 to 16 K.C. continuously variable band-width control, 2500-0-2500 cycle beat oscillator control, and graduated audio and sensitivity controls, in addition to, the megacycle and kilocycle tuning dial, accurate to within 1/2% and the 0 to 100 band spread dial. Within the rugged and self-contained tuning unit are a 4-gang tuning condenser, a 12-gang band spread condenser, 20 tuning coils on Isolantite bases and the remarkably noiseless five point cam knife-switch, which has proven to be absolutely trouble-free!

The fidelity of the new "Super-Pro" is so faithful and the sensitivity so great that it is being used by many news, recording, and broadcast stations for recording and re-broadcast work.

For those who require additional knife-like selectivity for C.W. code, a crystal model is available which when properly adjusted also affords added selectivity for voice and other modulated signals.

Regardless of the complexity of the heavy duty receiving problem you have, the "Super-Pro" will provide the results you want. It is truly "THE LAST WORD"! Send for the new "Super-Pro" bulletin with further details and illustrations. Mail the coupon below.

MAIL THIS COUPON!

HAMMARLUND MFG. CO., INC. Q-3
 424-438 W. 33d St., New York.
 Please send me new "Super-Pro" bulletin.
 Please send new "37" catalog.

Name.....
 Address.....
 City.....State.....



HAMMARLUND'S 25TH YEAR



NEW MIKE IDEAL FOR AMATEURS

**It's both Directional and
Non-Directional!**

The low price will surprise you!

Western Electric's new "salt-shaker" mike — the 633A — is ready for you. Like the famous "8 ball," it's a 2-in-1 mike — good for either non-directional or directional pick-up. For the latter, you simply attach the scientifically designed acoustic baffle.

Developed by Bell Telephone Laboratories, you can count on the 633A for "good broadcast quality." At its low price, you can't afford to do without it! For details: Graybar Electric, Graybar Building, New York, or Graybar's nearest branch.

At right: 633A for non-directional pick-up. Below: attach the acoustic baffle and your mike is directional!

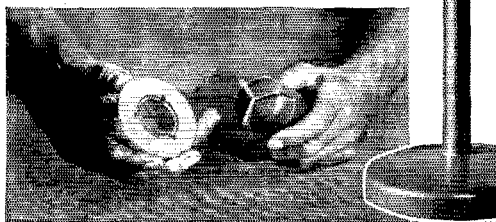

Western Electric
BROADCASTING EQUIPMENT
Distributed by **GRAYBAR Electric Company**

g2pn g2ao g5kh g5kj g5oj g5qv g5ri g6cl g6dh g6nf g6os
g6vk g6wn g6vn hb9jh hb9bd k6mvv fone ok2rs oz7g pa0aq
pa0az pa0kw pa0mq pa0pn pa0tsk suisg ze1jr za1h zt6ak
zt6m zult xelay

(14-Mc. band)

tf5c vu2dy

**W9RTY, Henry J. Hengels, 2643 Sheffield Ave.,
Chicago, Ill.**

(1.7-Mc. c.w.—Jan. 1st-17th)

wlze w2hxl w3cwi w8izg jfc lan nje oqm pdx vk w9aaw
ad agb arf bam das eez glw gpf hau jik jix juc kix koq lqm
lqy nne npm oeq ozz pnv rbr rkq srz stm tfw tms ugg vtj
wdf whq ybz ve3aje

A. Petitjean, 212 rue Marcadet, Paris 18, France

(14-Mc. 'phones)

w1bqq blo iaf jg iar gbe gbw dic aiq sz ged isd w2aio apv
cfu hgi oqd cwc dsy bkn bfx epi ze axr cla bbb cnt akd ad
cls axy kd w3fam ld fpu emm eys dhg bma eku. baw is
w4dpx cpb azk dlh w5atb bee w8oke qho dey jvf igl fqt
w9wpi bpl hpl la lu5ez lu6ke lu4bl celah py2ej py1dk yv5ak
oa4ak vp9r voig ve2dc ve3eo ve3jv

(28-Mc. 'phones)

w1dba hqn day ipm jlc w2kax kap hs hgu joa gib w3fpl huc
auc pc w4ki w5fra w6mdf mdn w8uxf mwi nzu ann kfr clg
dfe w9bhp bp dku mpm

I.A.R.U. News

(Continued from page 61)

German contacts may only be replaced by applicants residing in Oceania and K7.

4. A paper regarding a technical or scientific problem out of the field of short or ultra-short waves, which shall be published in the D.A.S.D. monthly magazine "CQ-MB" with the subtitle "DSM-Arbeit." This paper has to be written for this purpose only. The D.A.S.D. gets the copyright for that publication alone. The paper must be in a language using Latin letters and shall be typewritten. It is suggested to send two samples of the paper. The D.A.S.D.-DSM Department has the right to return papers below the common standard.

V

The winner of the title "DSM" is awarded with an artificial diploma from the D.A.S.D. and ought to mark the letters "DSM" on all his correspondence and cards.

VI

The diploma bears the year of award. In the following years the DSM may be applied for again and the applicant then receives an additional diploma for the respective year. Number IV, 4, is not requested when DSM is additionally claimed for.

APPENDIX

Members of I.A.R.U. sections may send their application cards for DSM to their headquarters, which give an acknowledgment to the D.A.S.D.-DSM Department.

D.A.S.D. BROADCAST

The next D.A.S.D. broadcast to radio amateurs will be on March 18th at 5 p.m., E.S.T. Tune to DJD at 11,770 kc. or DJC at 6020 kc.

A COMPLETE LINE OF CRYSTALS



Discriminating amateurs the world over have found Bliley Crystals to be most desirable for all operating conditions. Now, with 4 new units developed and perfected by Bliley engineers, a complete line of crystals is available for all amateur requirements.

Dodging QRM is easy with the Type VF1 Variable Frequency Unit whose frequency is adjustable over a range of approximately 6KC. Through temperature control with the Type CO6 slip-over oven, the frequency stability of standard Bliley Amateur Crystal Units can be bettered. Extremely high receiver selectivity is made possible with the improved Filter Crystal Unit, Type CF1. And for frequency measurements or calibration of frequency meters, monitors, etc., the Type SOC100 Standard Frequency Unit offers reliable accuracy without expensive equipment.

Standardize on Bliley Crystal Units — they are individually designed and precision built for lasting, dependable operation.

Type BC 3	\$3.95	Type LD 2	\$4.80
Type HF 2	\$6.50	Type VF 1	\$8.00
Type CO 6	\$3.25	Type CF 1	\$5.50
Type SOC 100		\$18.50	

**BLILEY ELECTRIC CO.
ERIE, PA.**

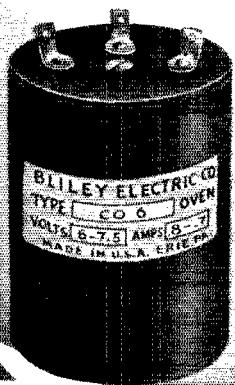

TYPE CO6 OVEN

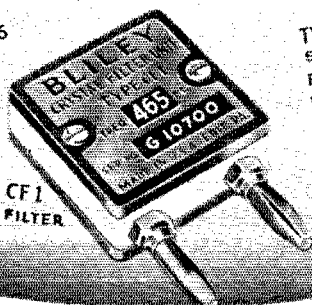

TYPE CF1 CRYSTAL FILTER

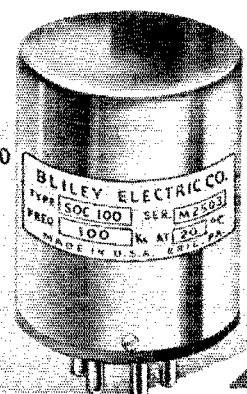

TYPE SOC 100 STANDARD FREQUENCY UNIT

FOR ALL AMATEUR REQUIREMENTS

BLILEY CRYSTAL UNITS

Craftsmanship is our star ★ salesman

High pressure . . . and empty superlatives may bring an occasional few sales . . . but only for a short time . . . YOU know what you want . . . and so do we . . .

CARDWELL solicits your CONTINUED patronage with a thorough understanding of amateur problems and a constant standard of superior craftsmanship.

CARDWELL RATINGS are
CONSERVATIVE and DEFINITE

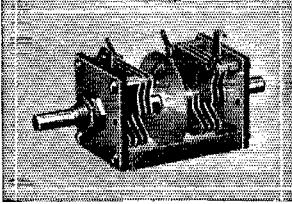

the new
ER-25-AD

DUAL TRIM-AIR MIDGET

is one of 10 new, standard double section equivalents of stock TRIM-AIRS . . . with sturdy oversize double bearings . . . at prices less than you would pay for 2 single units. Furnished with circular shield as illustrated or with square shield removable from the rods. New nickled brass angle tie rods . . . 4 convenient methods of mounting . . . 1/4 inch shaft extended at rear for ganging . . . Isolantite insulation.

ER-25-AD _____ Net Price **\$1.62**

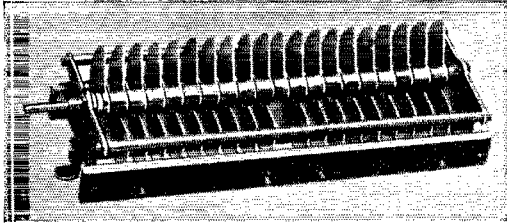

XC-75-XD Inputs up to one kilowatt have been successfully handled by this condenser. It is a double section high voltage transmitting condenser for push pull tank circuits for tubes of the 35-T, HF-200, T-55 and 808 class, plate modulated.

Capacity, per section _____ 75 Mmf.
Airgap _____ .200"

Voltage Rating, peak
flashover _____ 5800 Volts at 4 MC
Insulation.

General Electric Mycalex

Net Price, with
mounting feet attached

\$10

XT-210-PD

A very popular low-priced double section condenser for medium powered tank circuits where capacity requirements exceed those available in the transmitting Midway frame.

Net Price **\$4.70**

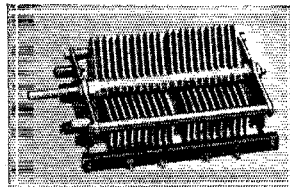

Capacity, per section _____ 210 Mmf.
Airgap _____ .070"

Voltage Rating, peak
flashover _____ 3500 volts at 4 MC
Insulation _____ Radion

An Earth Model for Showing Daylight-Darkness Distribution

(Continued from page 54)

divided into thirds, corresponding to ten-day divisions. That is about as much as the accuracy of this model will stand, but it is sufficient for the purpose. Don't worry about the months not being of equal length; it works out closely enough. Rule in the segments with white ink, with shorter marks at the ten-day intervals. The months of the year can then be written in; it makes no difference in the final model if they are put in in clockwise or counter-clockwise sequence. Draw a large arrow from the center of the disk through December 21st—this is the line along which the light source will be mounted.

The globe and cardboard disk can now be mounted on anything you like; a wood block is simple and requires little or no preparation. If the cardboard disk shows any tendency to buckle, it can be glued or tacked to the board. The globe should be mounted so that the support may be turned to simulate the actual position of the earth's axis with respect to the sun, but this bearing should be firm so that the earth's axis will remain at the proper angle for all settings. The earth's axis is tilted 23 1/2° from the vertical, a simple thing to check with a protractor, although most globes, even the cheapest, are mounted fairly accurately from this standpoint.

You now have a model of the earth that can be set for any day of the year simply by swinging the pointer around to the proper angle for that particular day. To set the globe for any specified time during that day, a small disk, divided into 24 sections, one for each hour of the day, is mounted on the upper bearing of the globe. This disk should be constructed to rotate easily on the bearing. The times are marked in, progressing counter-clockwise around the disk, and for convenience half of the disk is shaded, corresponding to the portion 6 p.m. through midnight to 6 a.m. Some globes will be equipped with this time-disk, but if not it is a simple thing to construct. A small wire pointer, extending up to the center of the globe, is mounted on the arrow of the calendar disk in such a fashion that it clears the mount when the globe is rotated. The length of the wire is adjusted so that, with the calendar pointer set for March or September 20 (the equinox dates), the tip of the wire just comes up to the equator. The shadow of the tip of this wire will always fall on the longitudinal line corresponding to noon and thus facilitate the proper setting of the globe.

To operate the model, and thereby show the proper proportioning of day and night on the earth at any time during the year, the globe is set up on one end of a table and a brilliant light is then mounted at the same height as the center of the globe, some distance from it. By shielding the lamp so that the light falls principally on the globe, light reflection from other objects in the room will be reduced to a minimum, and the dawn-dusk areas will be sharply defined. The base of the earth-model should be set so that the

THE ALLEN D. CARDWELL
MANUFACTURING CORPORATION
83 PROSPECT STREET, BROOKLYN, NEW YORK

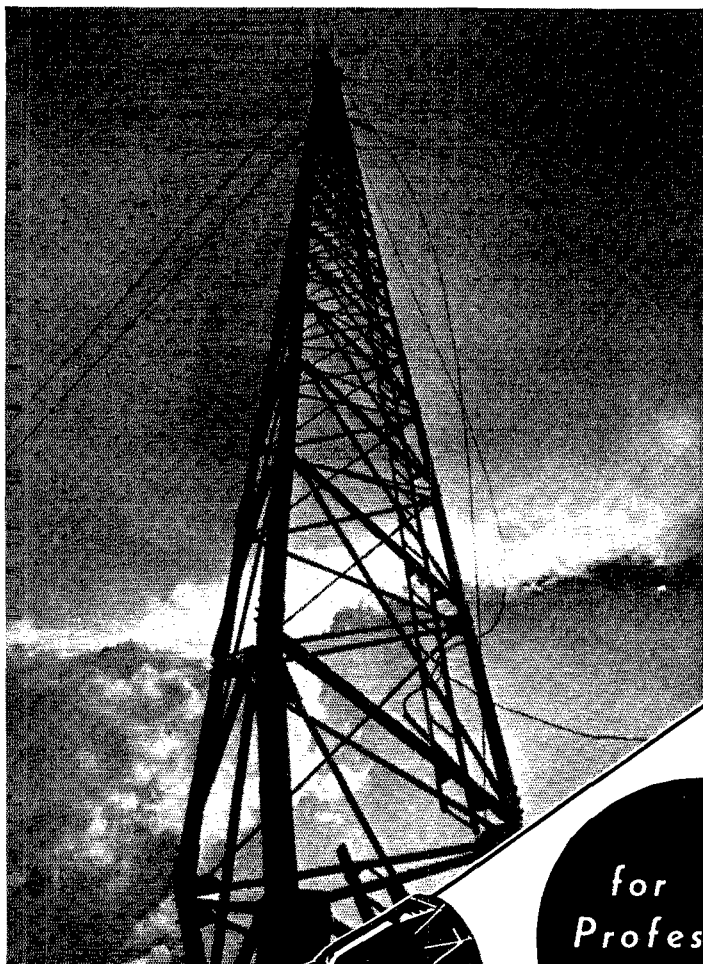

Courtesy N. B. C.

for
Professional
Performance



use this **BURGESS**
Safety-Lite

Insulated—rubber cushioned—water proof—gas tight—is this new attractive black and chrome flashlight. It bears the seal of dependability that is recognized throughout the radio world—the name Burgess.

Constructed ruggedly as a vertical radiator, the very feel of the Burgess Safety

Lite will give you a new sense of safety and dependability regardless of how severe your trouble-shooting work may be. Be prepared for every emergency. Get a Safety Lite and a supply of fresh Burgess Batteries today.

BURGESS BATTERY COMPANY
Freeport Illinois

BURGESS

Say You Saw It in QST — It Identifies You and Helps QST

CRYSTALS

PRICE LIST

Effective January 1, 1937

Frequency in KC Commercial & Broadcast	Temperature Coefficient Parts per Million per Degree C, 0-60 Degrees			
	4	2	1	.5
500-1715	\$25.00	\$35.00	\$50.00	\$65.00
2001-3499	27.50	37.50	52.50	67.50
4001-6999	30.00	40.00	55.00	70.00
7301-10,000	65.00	70.00	75.00	80.00
10,001-13,999	75.00	80.00	85.00	90.00
14,401-20,000	85.00	90.00	95.00	100.00
20,001-25,000	100.00	105.00	110.00	115.00
25,001-30,000	125.00	130.00	132.50	135.00

Prices on lower and higher frequencies upon application. All Commercial crystals are mounted in standard Navy type C holders and frequency settings can be made to zero beat by means of variable air gap. Or we can use your present holder.

Amateur Bands				
1715-2000	\$3.00	\$6.50	\$8.00	\$10.00
3500-4000	3.50	7.00	9.00	12.00
7000-7300	4.00	8.00	10.50	15.00
14000-14400	5.00	9.00	15.00	20.00

All frequency settings are within 1 kilocycle or better. Add 5 percent for setting of 500 cycles and 15 percent for exact setting. Prices do not include holders. Any type holder can be furnished at the current market prices. In ordering crystals to exact frequency please state type oscillator tube, plate voltage and holder must be included.

X or Y cut prices upon application.

All frequency settings are made against a General Radio Primary Standard. This standard is checked twice weekly against WWV The U. S. Bureau of Standards.

BELLEFONTE
RADIO ENG. & MFG. CO., INC.
Bellefonte, Penna.

arrow on the calendar disk is pointed towards the light. Now suppose you wish to find the distribution of sunlight on the world at 6 p.m. EST on January 1. The mounting of the globe is rotated until the pointer is set at January 1, and the time-disk is rotated on the globe until 6 p.m. is lined up along the 75° W. meridian of longitude corresponding to EST.¹ Rotating the globe until the meridian of longitude under 12 noon (in this example, 15° E. longitude) is lined up with the shadow of the tip of the wire pointer gives you a model of the world and its illumination for the date and time selected.

In general, the procedure to follow is to set the calendar pointer to the proper day, adjust the time-disk until the desired time corresponds to your local longitude, and then rotate the globe until noon on the time-disk corresponds to noon as shown by the shadow of the wire pointer. Simple, it takes more time to describe it than actually to set it up.

What practical benefits are likely to accrue from the construction and operation of a gadget of this sort? Really, it is mostly a tool for speculation, but speculation is often an attractive phase of the game—if it weren't, and everything were cut-and-dried, most of the thrill of an unexpected DX contact would be missing. Knowing the way in which the "best" times for working certain distant points vary at different times of the year, the explanation is often to be found in the daylight-darkness distribution over the great-circle route, particularly if the variation in ionosphere heights (or critical frequencies) during the day and year, as described in Dr. Kenrick's paper in September *QST*, are kept in mind. Furthermore, a ham with a little "savvy" and one of these implements can do a little predicting of his own as to best times for DX.

In short, if you're a fellow who thinks all there is to amateur radio is a signal report and a QSL card you won't have read this far, but if most of your questions start with "Why?" you'll get a kick out of conjecturing about the surface coating of T9x that covers the world.

Hints and Kinks

(Continued from page 49)

It will be noted that each step increases the resistance across the 'phones (and therefore the voltage), by the approximate factor of 10:1. The power ratio, then, is 100:1; the common logarithm of 100 (and hence the number of bels) is 2; the number of decibels is 10 times this or 20. Therefore the steps are 20 db each.

On two stages of audio it rates a fair loud-speaker signal 5 and a very weak 'phone signal 1. In operation a signal is tuned in with the switch on tap 1, where it will be loudest. Then the switch is moved up the scale, putting the 'phones across smaller and smaller resistances until the signal can barely be heard. If the signal is heard weakly

¹ The line of longitude for your particular time zone may be found by referring to the Appendix of the *Handbook*.

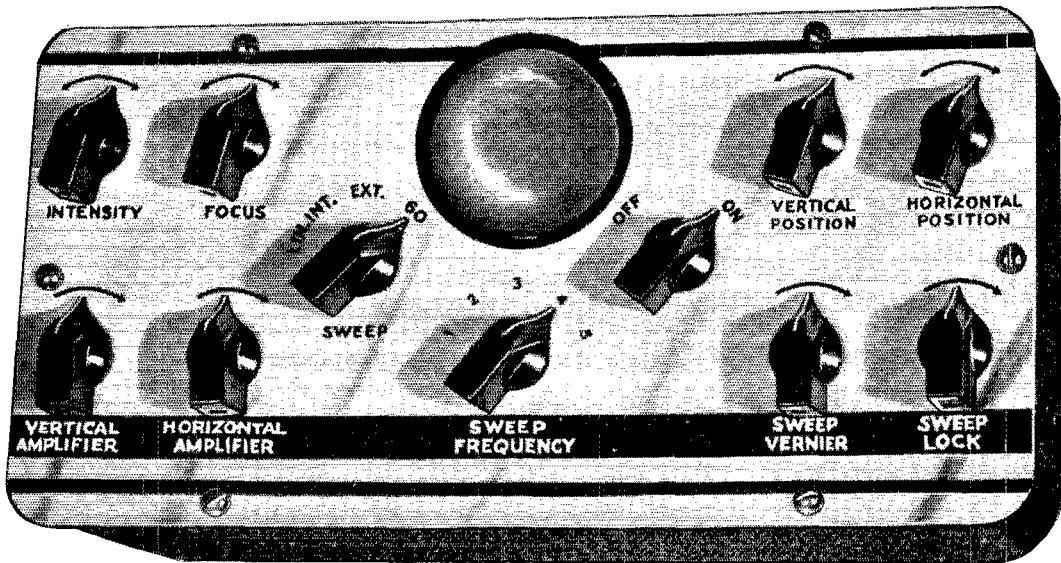

OSCILLOSCOPE by THORDARSON

A COMPACT... ALL-FEATURE FOUNDATION UNIT

Here it is men! You have needed this new Thordarson Oscilloscope for years. Unit is absolutely fool proof. Instructions concise and clear. All mounting holes drilled in chassis and steel panel. Build it yourself and get a real professional oscilloscope at an amazing price saving.

The Thordarson Oscilloscope has every feature found in the most expensive units. Special etched panel for rack or cabinet mounting. Unit can also be operated as portable oscilloscope. Compact, light weight, overall size—10½" x 6¾" x 5³/₁₆" high. Assembled in three hours. Operates with new 913 cathode ray tube. Enlarging lens builds image to 2 inches.

FEATURES

- | | |
|--|----------------------------------|
| Perfect linearity of sweep | Self-contained linear sweep |
| Positive "snap-in" locking | 60 cycle and external sweep |
| Intensity and focusing controls | 5 range sweep (20-12,000 cycles) |
| Horizontal and vertical amplifiers | 500,000 ohm input |
| Enlarging lens and etched panel optional | |

Available in "Build It Yourself" foundation unit at your favorite supplier.



FREE See your parts dealer today or write factory for Bulletin SD-266 **FREE**

THORDARSON ELECTRIC MFG. CO.

500 W. HURON ST., CHICAGO, ILL.

Demand "Power by Thordarson"

Now—a high-powered—

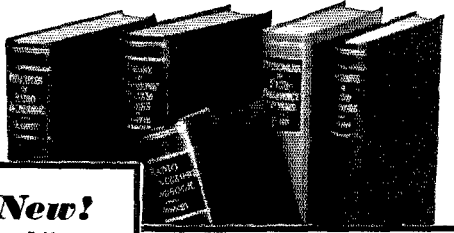

New!

The Library now comprises a revised selection of books culled from latest McGraw-Hill publications in the radio field.

RADIO ENGINEERING LIBRARY

— especially selected by radio specialists of McGraw-Hill publications

— to give most complete, dependable coverage of facts needed by all whose fields are grounded on radio fundamentals

— available at a special price and terms

These books cover circuit phenomena, tube theory, networks, measurements, and other subjects— give specialized treatment of all fields of practical design and application. They are books of recognized position in the literature— books you will refer to and be referred to often. If you are a researcher or experimenter— if your interest in radio is deep-set and based on a real desire to go further in this field— you want these books for the help they give in hundreds of problems throughout the whole field of radio engineering.

5 volumes, 3064 pages, 2000 illustrations

1. **Glasing's** PRINCIPLES OF RADIO ENGINEERING
2. **Terman's** MEASUREMENTS IN RADIO ENGINEERING
3. **Chaffee's** THEORY OF THERMIONIC VACUUM TUBES
4. **Hund's** PHENOMENA IN HIGH-FREQUENCY SYSTEMS
5. **Henney's** RADIO ENGINEERING HANDBOOK

Special Low Price and Easy Terms

Bought singly, the five volumes comprising this library would cost you \$25.00. Under this offer you save \$1.50 and, in addition, have the privilege of paying in easy installments beginning with \$2.50, 10 days after receipt of the books, and \$3.00 monthly thereafter. Already these books are recognized as standard works that you are bound to require sooner or later. Take advantage of these convenient terms to add them to your library now.

SEND THIS ON-APPROVAL COUPON

McGraw-Hill Book Co., Inc.
330 W. 42nd St., New York, N. Y.

Send me Radio Engineering Library, 5 vols., for 10 days' examination on approval. In 10 days I will send \$2.50, plus few cents postage, and \$3.00 monthly till \$23.50 is paid, or return books postpaid. (We pay postage on orders accompanied by remittance of first installment.)

Name

Address

City and State

Position

Company QST-3-37
(Books sent on approval in U. S. and Canada only.)

on 3 and goes out on 4, we rate the signal 3 on the 1-5 scale. Of course the figures mean nothing in themselves; they simply indicate the relative strength. It should be pointed out that using the same system any number of steps may be used to show any number of relative strengths.

B.C. Interference from Code Practice Oscillators

MAKING and breaking the circuit with the key in code-practice audio oscillators of the type shown in the *Handbook* (using an audio transformer) sometimes causes clicks in nearby broadcast receivers. A note from Billy Baxter, Birmingham, Ala., says that the interference was cured in his case simply by shifting the key from its position between "B" battery and 'phones so that it was between the 'phones and the audio transformer winding. Apparently the transformer and 'phones together acted to absorb the click. It's simple and worth trying in cases where similar interference occurs.

Electronic Mixing for Monitoring

THE circuit of Fig. 5 is suggested by Francis Higgins, WSRX, as a means of eliminating switching, split headsets, and other schemes which have been devised to permit feeding the monitored signal into the 'phones during transmission.

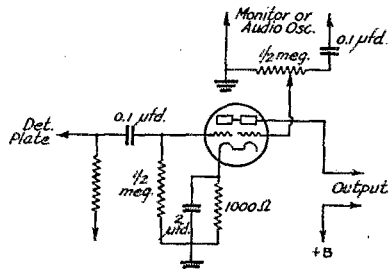

FIG. 5—USING A TWIN TRIODE FOR INTRODUCING THE MONITOR SIGNAL INTO THE RECEIVER OUTPUT

As the diagram shows, the first audio tube in the receiver is a twin triode with its plates in parallel but with one grid connected to the detector output and the other to the output of the monitor or keying oscillator. A gain control on the latter grid permits adjusting the monitor signal to the desired level.

This arrangement would seem to be ideal for monitoring with break-in.

Simple Band-Change Switch

AN easily-constructed and inexpensive switch of the coil-shorting type, devised by J. Stanley Brown, W3EHE, is shown in Fig. 6. The drawing is practically self-explanatory. The contacts are bronze fuse clips, the shorting contact a length of

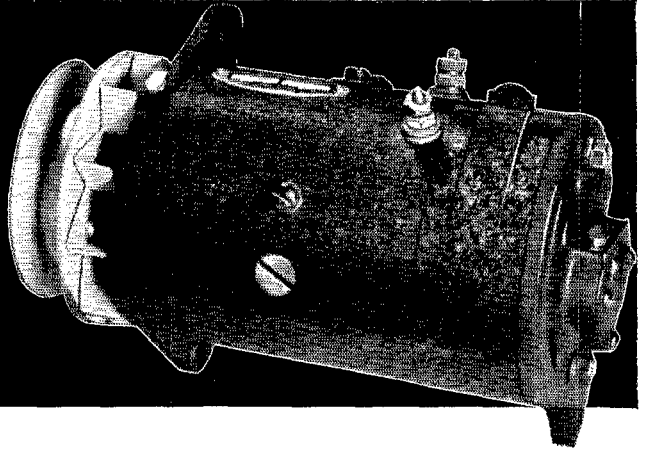
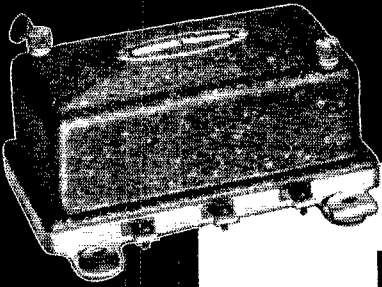

DELCO-REMY

HIGH-OUTPUT GENERATORS

For Extra Current Requirements

For the increased current requirements of winter driving—for two-way radio and added lights—you need the extra output of one of the Delco-Remy Special Service Generators for passenger and police cars.

There is a type to suit most installations and operating conditions—from the model 954-A, an inexpensive passenger car unit having a constant output of 22 amperes from a very low cut-in, to the larger police car generators for state police or city "cruising" service. All are full ball-bearing equipped and have forced-draft ventilation.

The Delco-Remy current and voltage regulator, furnished with each generator, accurately controls the output of the generator to suit the load requirements, and prevents the battery from being overcharged.

If you have experienced trouble with run-down batteries this winter, see the Branch or Electrical Service Station of United Motors Service nearest you. Let them suggest the Delco-Remy high-output generator that will best suit your driving conditions.



Delco-Remy products are sold and serviced in the United States and Canada by United Motors Service.

Delco-Remy

ANDERSON, INDIANA

Say You Saw It in QST — It Identifies You and Helps QST

How do **LOOK**
your sigs
at full power output?

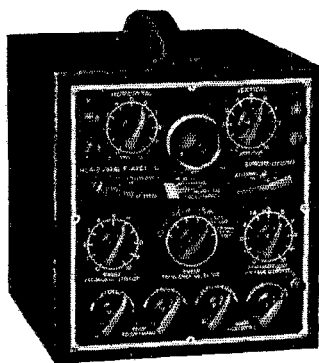

C-B
Model 105
Oscilloscope
\$5.50
down
from your
dealer

Get CLEAN TRANSMISSION
with maximum efficiency
by regular Oscilloscope checks

● Because the MODEL 105 is complete with linear sweep circuit and dual input amplifiers you can check the performance of speech amplifiers, class C stage, degrees of excitation and modulation. Unlike instruments lacking the saw-tooth sweep generator, the MODEL 105 is electrically synchronized and not limited to trapezoid determinations of modulation — but shows you the true modulation envelope revealing both percentage of modulation and wave form distortion. Net price complete with five tubes — \$48.90. Write for descriptive bulletins.

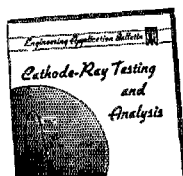

FREE — **24-page Booklet**
"Cathode-Ray Testing and Analysis," by Kendall Clough

For a limited time only. Get your copy of this valuable booklet today.

The CLOUGH-BREngle CO.

2813-C W. 19th St., Chicago, U. S. A.

Send at once a copy of "Cathode-Ray Test and Analysis," the complete C-B Catalog and Time Payment order blank.

Name.....

Address.....

quarter-inch brass rod. The parts should be mounted on good high-frequency insulating material such as Victron (which is easily worked) to prevent power loss.

A switch of this type has high current-carrying

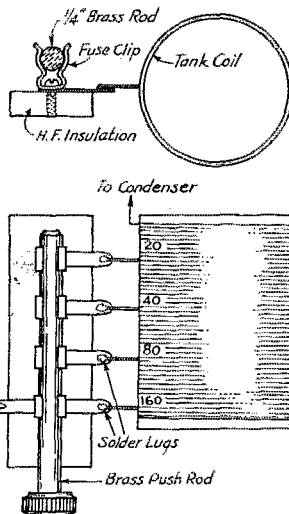

FIG. 6—AN EASILY-CONSTRUCTED SHORTING SWITCH FOR BAND-CHANGING

capacity, low electrostatic capacity between contacts, and permits laying out the circuit so that the shorting leads have negligible length.

Band-Switching Exciter

(Continued from page 18)

right, by the 89 and RK-25. The RK-20 and its tank circuit are easily recognizable. The RK-20 tank condenser, C_4 , is also mounted on butt-ins to insulate it from the chassis. The plate coil is wound on a ceramic form fitted with a bakelite strip at the bottom to take the six G.R. plugs to which the coil and link connections are made. These fit into six jack-top feed-through insulators mounted in a row along the rear edge of the chassis.

The "works" below the chassis is shown in another photograph. Wiring of resistors and bypass condensers needs no particular comment; the former are simply placed in convenient locations and the latter as close as possible to the circuit points which they bypass, using short ground connections direct to the chassis. The crystal switch, S_1 , is mounted on a small piece of bakelite which is bolted, by means of an L-section piece of brass, so that it projects from the side of the chassis and places the switch near the crystal sockets. The control knob is mounted on a Bud No. 531 panel bearing, the space between the end of the bearing shaft and the switch shaft being pieced out by a length of quarter-inch brass rod, using flexible couplings for the mechanical connection.

The three coil-shorting switches are fastened to a 10½ by 3 inch piece of bakelite mounted as shown in the photograph. The spacing is such as to

RME - 69

R.F. SIGNALS *versus* A.F. SIGNALS

The carrier level meter on the RME-69 is actuated only by the *radio frequency energy* entering the receiver. Percentage of modulation does not affect the meter unless frequency modulation occurs.

A radio frequency carrier modulated only 30% may give just as high a DB. level reading as one modulated 90%. Thus the R. values indicated on the meter are not affected by the modulation. Audibility and strength of audio signals are not measured in terms of R. and the meter cannot therefore give false impressions of R.F. signal strength versus audio level.

As an operator of an amateur transmitter, you are primarily interested in R.F. signal strength when giving or receiving an R. report. The RME-69 will do this quickly and quite accurately from day to day. It is a distinct asset in the receiver found in your station.

Write for Bulletin 69

Radio Mfg. Engineers, Inc.

Peoria, Illinois

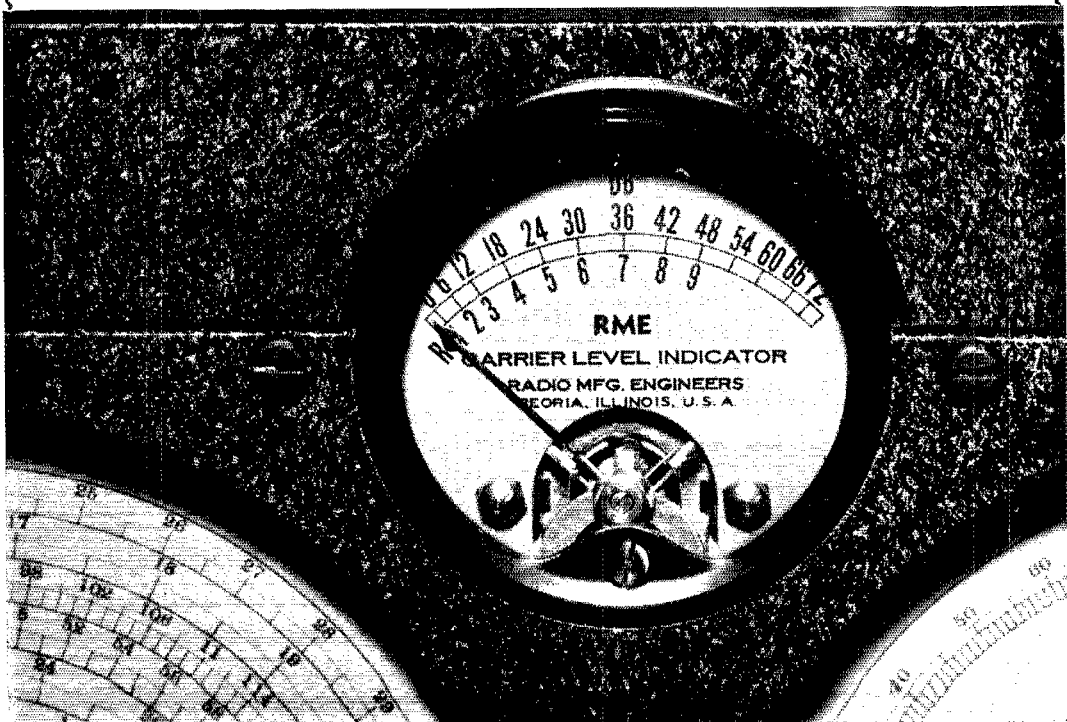

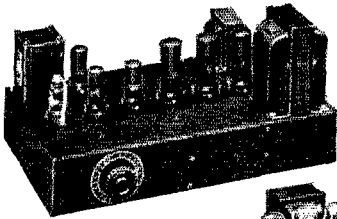

120-Watt P.P.
Parallel 6L6
Amplifier.

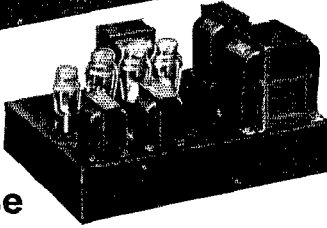

Get These 8 AMPLIFIER DIAGRAMS Developed by Jefferson

Of the many amplifier circuits developed by Jefferson engineers—we have selected 8 that are of particular interest to every "ham." These 8, all tried and proven, provide a wide selection for those interested in improving their phone rigs.

1. "120-Watt P. P. Parallel 6L6." More watts per dollar than any other combination, with quality that approaches that of our best commercial stations.
2. "60-Watt 6L6"—employs 6L6 Beam Power tubes in push-pull class AB₂. Powerful 60 watts output with high power sensitivity and high efficiency.
3. "P.P. 6B5 High Gain"—20 watts output—flat frequency response. Easy to build, template with each chassis base.
4. "6F6 Metal Tube High Gain"—18 watts output—double channel input.
5. 20-Watt Convertible—operates from 6 volt D.C. or 110 volt A. C. Used extensively for public address work, and sound trucks.
6. P.P. Parallel 45, A-B 38 watt—economical, suitable amplifier for large halls, schools and many outdoor uses.
7. High Gain "2A3"—15 Watt amplifier—120 D.B. gain. P.P.-56 drivers reduce harmonic distortion and give fine frequency response.
8. Class B-59—good volume, tonal quality, fidelity; 15 watts output.

Ask your Parts Jobber or write for the 8 Jefferson Circuits, they are free.

Jefferson Transformers are made for every radio purpose—and the name "Jefferson" is guarantee of the highest quality of engineering design and construction . . . JEFFERSON ELECTRIC COMPANY, Bellwood (Suburb of Chicago), Illinois. Canadian Factory: 535 College St., Toronto.

JEFFERSON TRANSFORMERS

Jefferson Electric Company
Bellwood, Illinois

Send Catalog and the 8 Amplifier Circuits mentioned above.

Name.....

Address.....

City and State.....

bring each switch close to its coil socket. A section is cut out of the bakelite piece to clear the buffer tube socket and the wiring associated with it. To prevent "weaving" when the switches are turned, a bracket of half-inch brass strip fastens the bakelite mounting, about half-way along its length, to both the top and rear edge of the chassis, making a very solid mounting. The switches are ganged by means of insulating couplings, isolantite being used between S_4 and S_3 , and bakelite between S_3 and S_2 . The voltage difference between S_3 and S_2 is small. The string of switches is mechanically coupled to the control knob on the panel through a National Type TX-12 flexible shaft coupling. The panel bearing is the same type as that used for the crystal switch. To reduce backlash in the flexible coupling, the flexible section is run through a hole in a strip of bakelite mounted from the side of the chassis. This acts as a bearing which prevents undue twisting.

The socket for the RK-20 is mounted about 2 inches below the chassis on brackets made from brass strip. The tube projects through a hole in the chassis. The mounting arrangement was adopted partly to save an extra rack unit in panel height and partly for shielding purposes. A cut-down coil shield (National Type J30) is mounted on top of the chassis above the hole for the tube, and encloses the lower part of the tube up to the edge of the plate. Below the chassis, a baffle shield of thin aluminum is interposed between the tube and the plate coil switch.

The two small feed-through insulators on the edge of the chassis at the upper left in the bottom-view photograph are the r.f. output terminals, connected to the link winding. Power supply connections are made to a terminal strip on the back edge of the chassis except for the RK-20 plate lead, which comes in through a feed-through insulator. The key terminals are on the same side of the chassis as the jacks for oscillator and buffer plate-current measurements.

COILS

An exploded view of the buffer plate coil is given in one of the photographs. The construction of the oscillator coil is similar. The coils are wound on $1\frac{1}{4}$ -inch bakelite tubing, with taps taken out at experimentally-determined points to give suitable $L-C$ ratios on each band. The method of mounting the coil on the plug-in base is simple and quite effective from the standpoint of rigidity. Short lengths of No. 14 tinned wire (one for each connection) are fastened to the lower edge of the bakelite tubing by feeding the end of the wire through a hole in the form and then bending it back and squeezing it tight and soldering. The other ends of the wires are then forced through the prongs in the base and soldered in place. The coil is held as solidly as though mounted on special brackets. The connection to the shield can be made by bending a soldering lug over the edge of the plug-in base so that one of the mounting screws passes through it.

The same photograph shows the ten-meter plate coil for the RK-20, this tube being conveniently

TEMCO

600 WATT TRANSMITTER

(INPUT RATING FOR BOTH PHONE AND CW)

*Offers Deluxe Features
at Substantially Lower Cost*

TEMCO, by utilizing the newest type low capacity high frequency tubes (100TH's or RK39's), now offers a medium high power transmitter with numerous Deluxe features previously embodied only in our Model 1000. An added feature is a built-in oscilloscope employing a type 913 cathode ray tube. This provides an efficient method of measuring percentages of modulation.

The type 2B speech amplifier is entirely self-contained and embodies a two channel mixer for sound cell crystal microphone and crystal phonograph pickup. This amplifier has an undistorted output of 10 watts with an overall gain of 110 db. Its frequency response is flat from 60 to 10,000 cycles to within plus or minus 2 db.

*Full descriptive literature is available
on request to those interested*

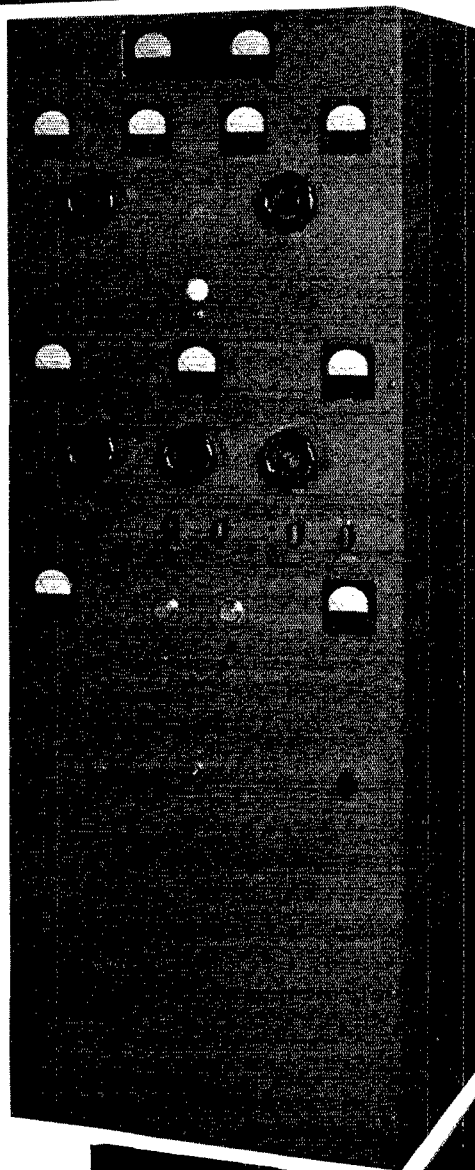

Transmitter Equipment Manufacturing Co., INC.

130 CEDAR STREET • NEW YORK, N. Y.

Designers and Manufacturers of Radio Transmitting and Accessory Equipment

ANNOUNCING THE Bassett Concentric Feeder

A Flexible, Concentric Transmission Line

Based on extensive research that involved the creation of a new mathematical formula for coaxial transmission cable for high frequency work, the Bassett Concentric Feeder represents a tremendous forward stride in antenna engineering.

Dimensions and materials are figured so exactly that you enjoy almost perfect efficiency... negligible radiation or power loss... high quality insulation.

Note These Features

1. Characteristic surge impedance perfectly matches center of doublet with or without reflector.
2. Absolutely unaffected by moisture, snow, sleet, sun, temperature changes or atmospheric conditions of any kind. Can be operated buried underground or submerged in water.
3. Extremely high efficiency, equal to open wire lines, with absolutely no line radiation.
4. May be link coupled or coupled through network.
5. Maximum power attenuation in a 100 foot section at 7000 kilocycles only six-tenths of one decibel.
6. Characteristic surge impedance constant regardless of frequency whether audio or radio. Variation less than one-third of one per cent.

The Bassett Concentric Feeder is light and flexible as rope, easy to install, may be used in any length desired, handles a California kilowatt with ease. Attractive low cost.

FOR INFORMATION WRITE

BASSETT RESEARCH CORP.

1456 Maccabees Bldg., Detroit, Michigan

*

Amateurs may also write

MIMS RADIO COMPANY

Box 504

Texarkana, Ark.

used as a doubler on 28 Mc. Since only a small number of turns is required, the coil is made self-supporting, using 3/16-inch copper tubing for the conductor. The link is a single turn of the same material, wound between the first and second tank-coil turns at the low-potential end. To reduce losses, the mounting strip is made of Victron.

One problem in connection with the band-switching tank coil for the RK-20 was that of getting satisfactory output coupling on all three bands without the necessity for switching links. Early plans had called for a link winding distributed over the various active sections of the coil, but it was found that a single link, having the right number of turns and properly placed on the coil, worked equally well. The final arrangement has three turns, wound over the part of the coil lying between the 40- and 20-meter taps, supported from the coil by several small pieces of Victron cemented in place. With this link, the RK-20 is loaded to about the same plate current on all three bands, and puts approximately the same grid current into the following amplifier on all three, when the links at the receiving end are properly adjusted.

OPERATION

Tuning practice with this rig does not differ from that which would be used with any transmitter having the same fundamental circuit arrangement. The usual plate-current dips indicate resonance in all plate circuits. Under operating conditions, the oscillator plate current should be about 20 ma. The buffer plate current will depend upon the frequency to some extent; it runs quite low in any event, being about 20 ma. on 3.5 Mc. (when driving the RK-20), 25 to 30 ma. on 7 Mc., and between 30 and 40 ma. when doubling to 14 Mc. In no case is the plate current as high as the normal rating for the tube; in this circuit it is impossible to load the tube to any greater extent. There is ample excitation, of course, for the RK-20.

In the RK-20 stage, no load plate currents range from about 10 ma. on 3.5 Mc. to around 20 ma. on 14 Mc., the tube being used as a straight amplifier on these bands, with 1250 volts on the plate. With normal input, power outputs of 75 or 80 watts are readily obtainable. When the RK-20 is used as a doubler to 28 Mc., the no-load plate current is approximately 40 ma. and the output at normal plate current about 40 or 50 watts. The plate of the tube does not show any color under these conditions. The output capacity of the tube seems quite high, since the rather small 28-Mc. coil can be tuned to resonance with the tank condenser plates just starting to mesh, so that a rather unfavorable L-C ratio results on this band.

The excitation control proves to be an invaluable aid in tuning. It can be set well back so that in no case does the plate current on either the RK-25 or RK-20 exceed any desired percentage of the rated value, yet the resonance dips are just as plain as with full power. Then, after all

START RIGHT *with the* UTAH

ADD-A-UNIT AMATEUR TRANSMITTER KIT

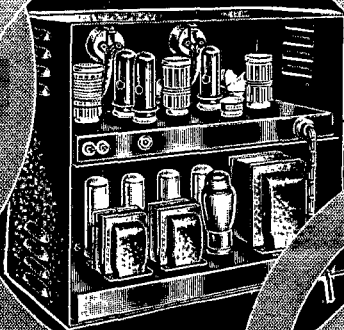
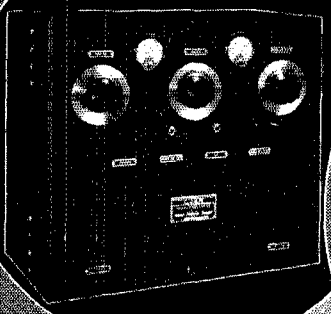

\$ 49.⁷⁵ TUBES
METERS
CRYSTAL
less

A completely self-contained Amateur Transmitter Kit . . . 80 watts input

Here's great news for amateurs! This professionally styled Transmitter gives high efficiency — yet costs 1/3 less. Have the fun of building it yourself. Enjoy its exceptional performance. Get the thrill of being on the air. You'll always be glad you started with UTAH. Later on you can plug in additional UTAH units and have a complete professional style 400 Watt Phone Transmitter — the dream of every amateur.

Each kit is a complete unit and is easily assembled and wired. Each part is tested and proved by UTAH — so you know it's right. The sensational new circuit amazes everyone.

These UTAH jobbers were selected

because we consider them outstanding in their communities for their ability and willingness to serve amateurs with fairness and understanding. See your closest UTAH jobber. You will find him not only friendly and helpful, but prepared to give you the most for your money . . . and that means UTAH!

See your Amateur Parts Jobber now, or write for complete details! If your jobber is not listed, write direct.

UTAH RADIO PRODUCTS CO.
CHICAGO, U. S. A.

TORONTO
CANADA

BUENOS AIRES
(UCOA Radio Products Co.)

15 YEARS OF LEADERSHIP

IF
YOUR JOBBER
IS NOT LISTED
WRITE DIRECT

BOSTON Brattle Radio Co.
BOSTON Selden Radio
BUFFALO Dymac Radio
CHICAGO Allied Radio
CHICAGO Montgomery Ward & Co.
CINCINNATI Steinberg's Inc.
CLEVELAND Northern Ohio Laboratories
COLUMBUS Bell Radio Parts
DAYTON Standard Radio Parts
DETROIT Radio Specialties Co.
EVANSVILLE Wesco Radio Parts
FORT WAYNE Pembleton Laboratories
INDIANAPOLIS Van Sickle Radio Shop
KANSAS CITY Burstein Applebee
LOUISVILLE P. I. Burks
NEW YORK CITY Harrison Radio
PHILADELPHIA Radio Electric Service
ROCHESTER Beaufaire, Inc.
TOLEDO Toledo Radio Specialties
YOUNGSTOWN Ross Radio

STUCK?



CANDLER Scientific Code System Will Put You Over the "Hump"

Don't be discouraged if you're stuck or have failed your code exam! Maybe you've spent hours in faithful practice — maybe you've tried again and again without progress — yet the *Candler System* can help you "over the hump" that seems to be your limit.

It's not how *much* you practice but *how* you practice that counts in learning code or gaining speed — and Candler can show you *how*.

Thousands of high speed radio ops — men like Champion Ted McElroy and other skilled amateur and commercial operators — can testify to the effectiveness of Candler System Code Training. It's different — you learn to read code by sound as you read print by sight. It's sure — Candler guarantees you whatever ticket you're working for, amateur or commercial. It's quick — the rapid progress of Candler students is amazing — in a few weeks time they accomplish what years of undirected practice failed to give them. It's easy — only a short time daily will suffice. And last but not least, it's inexpensive.

Don't be satisfied to be a "LID" when it's so easy to be a skilled radio operator. Let Candler train you the *right way* — the *quick way*. Ask any skilled operator about the Candler System! Who knows — it may be your start in a well-paid profession. Write today for the *Free Book of Facts* that tells you all about the Candler System.

COURSES for BEGINNERS and ADVANCED STUDENTS

Candler takes you right through from the very beginning to your amateur or commercial license. There's a course for beginners that teaches you all the necessary fundamentals scientifically — a course for operators who want to prepare themselves for the commercial radio field — and a Telegraph-Touch Typewriting course for those who want to become expert in the use of the typewriter, in receiving fast stuff. Remember, Candler trained operators are in demand for attractive commercial jobs. Send the coupon today for complete details.

CANDLER SYSTEM CO.

DEPT. Q-2 ASHEVILLE, NORTH CAROLINA
FREE—Book of Facts. Tells all about Candler Beginners' and Professional Training, records of Champions. All questions answered. No obligation.

MAIL THIS COUPON TODAY!

CANDLER SYSTEM CO.
Dept. Q-2, Asheville, North Carolina

Please send me Free Book of Facts.

Name.....

Address.....

City.....State.....

Code Speed (if any).....WPM

circuits are in line, this control is set at maximum and the full output is developed. With such a gadget, dangerous plate currents and excessive plate dissipation simply are not a consideration.

Flood Relief Communications

(Continued from page 15)

the Army-Amateur Radio System and of the Naval Communication Reserve have definitely proved to the American public its absolute dependence upon the amateur in times of such emergency. The amateur has unquestionably again established his place in the sun through these many instances of really brilliant work. The regularly organized lines of communication—broadcasting stations, newspapers, telegraph and telephone companies—all were forced to rely upon the amateur to put through their important emergency communications, and to order the supplies, food, clothing, boats and men which were needed.

There is one outstanding contribution from this flood experience. There must be a definite controlling agency set up which has the authority and the ability to definitely and positively coordinate and direct all the various means of radio communication which are available. Where amateurs, broadcasting stations, Army, Navy, Naval Reserve, Coast Guard, Red Cross, airlines, and commercial radio stations are all endeavoring to do the same job, necessarily conflict, confusion, interference and hopeless babble result unless there is centralized in one controlling agency the authority to direct the activities of all such channels of communication and to select the most desirable, whichever it may be in each specific instance, and eliminate from the picture all others which merely cause interference by their efforts to assist.

From two weeks' close observation the conclusion is inevitable that the amateur station represents the only dependable medium of communication under conditions such as those described. It should be remembered that an amateur operating his own station is none the less an amateur even though associated with the Army-Amateur Radio System, the Naval Communication Reserve, or other governmental body. Affiliation with these organizations gives him official recognition and some training in preparation for emergency work, and when I speak of amateur stations being the only dependable means of communication I refer to the entire body of such amateur stations, regardless of their affiliations. Where amateur stations of this kind were left alone to work out their own communication problems, the results were in every case excellent. Where those attempted to take jurisdiction who did not understand the amateur set-up and the problem, then confusion resulted until it was straightened out by someone with local authority.

It is unquestionably the duty of the American Radio Relay League to draw up and present to the Federal Communications Commission some coherent plan of organization which will accomplish centralized control and direction of

RCA RECOMMENDS A FEW OUTSTANDING TUBE TYPES FOR AMATEUR APPLICATIONS

Improved quality, greater production make possible new low prices on many types (See Back Cover)

THE past few years have seen the introduction of many new tube types designed primarily for amateur use. Because so many types are now available, the amateur often finds it difficult to make a decision as to which tube to use. To simplify the choice, we suggest a few outstanding types which meet all major amateur requirements.

Money-saving price reductions are, at this time, being made on a number of RCA types for which amateurs have already demonstrated their whole-hearted acceptance. At these new prices, these types become of even more outstanding value for amateur applications.

It is interesting to note that these price reductions are being made at a time when prices on many lines of merchandise are being advanced because of rising costs. However, RCA is able to make substantial reductions on these types because increased production coupled with greatly improved quality has resulted in manufacturing economies which can be passed on to the consumer. As greater production is secured, lower costs are obtained. As RCA improves its already outstanding quality, better factory efficiency results because fewer tubes which do not meet rigid standards need be scrapped.

We call your particular attention to the following types and recommend that you give them first consideration for use in your transmitter:

RCA-801—Now \$3.45. A triode of proven quality for low-power transmitters and the amplifier stages of all transmitters.

RCA-802—\$3.90. A pentode for crystal oscillator, buffer, doubler and low-power final stages.

RCA-803—Now \$34.50. A high-power pentode for suppressor—or grid-modulated service.

RCA-805—Now \$15.00. The new price makes this the outstanding type of its class.

RCA-806—\$24.50. A high-power, tantalum-plate triode for the final amplifier or the Class B modulator stage.

RCA-807—\$3.90. A beam-power tube for crystal oscillator, buffer, doubler, or final amplifier stage.

RCA-808—\$10.00. A new tantalum-plate triode for medium-power transmitters and Class B modulators.

RCA-845—Now \$15.00. The old favorite for Class A modulators.

RCA-866—Now \$1.75. The standard, proven quality rectifier for medium-power transmitters.

RCA-872—Now \$14.00. The rugged, heavy-duty rectifier for high-power transmitters.

RCA-906—Now \$15.00. The first and leading 3-inch cathode-ray tube for amateurs.

RCA-913—\$5.60. The popular new 1-inch cathode-ray tube.

RCA-954—Now \$5.00. RCA-955—Now \$3.00. RCA-956—Now \$5.00. The acorn-tube family is the only popular group of tubes for ultra-high frequency applications commercially available.

The RCA types recommended above are of proven, dependable, and efficient design. We sincerely believe that these tubes offer exceptional values. Our distributors will be pleased to furnish additional information and supply your requirements.



AMATEUR RADIO SECTION

RCA MANUFACTURING CO., INC., CAMDEN, N. J.

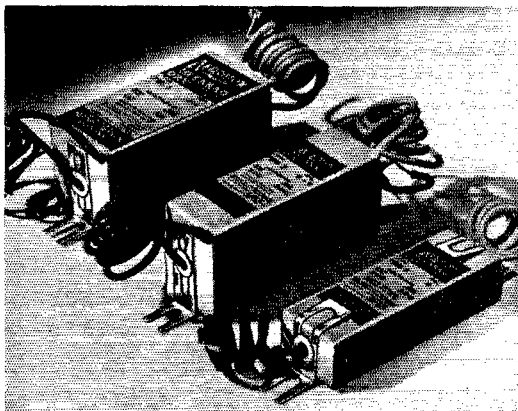

Handier than Ever!



Swivel flange permits flat or upright mounting.

Minimum bulk due to latest technique.

200 and 450 v. working. Popular capacities. Single, dual and triple sections.

A lot of capacity for very little money.

Those compact AEROVOX PBS card-board-case electrolytics are now available with the NEW Adjustmount Flange. Metal flanges match any mounting-hole spacing. Units mount individually or stacked. Fit anywhere. ● Send for latest catalog.



NEW PRICE on the AMPEREX HF 100

"... the easiest tube on the American market to drive ..."

This tube delivers a satisfactory power at ultra high frequencies and is, in addition, a remarkably efficient modulator and amplifier both in the amateur and broadcast bands.

High μ
High Gm
High voltage handling ability
High frequency oscillator
High power output

\$12.50

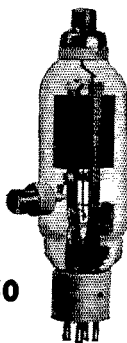

AMPEREX

ELECTRONIC PRODUCTS, INC.
79 WASHINGTON STREET, BROOKLYN, N. Y.

amateur stations during emergencies. It is essential that this scheme be set up in advance, drilled and prepared to function at a moment's notice. It is equally essential that it be so coordinated that it can function perfectly even though a portion of its tentacles are cut off. Here is a real problem, one of producing centralized authority which can be exerted from a multitude of points as may be required, but from only one of those points at a time under conditions which make the necessity of using such a specific point obvious.

Governors-President Relay

(Continued from page 45)

number of messages received thru his station was due to the fine group of operators assisting him and to stations in important relay positions that acted as "collectors" voluntarily throughout the activity. The hard work of Elizabeth M. Zandonini, W3CDQ, Larry Harvey, W3EMO, Bill Sutherland, W3CJT, El Banker, W3BHV, Reds Downs, W3WU and Bill Brantley, W3EZN, all veterans of previous G.P.R.'s who were at BWT, he says rates special mention.

Climaxing the receipt of the messages was the actual delivery to the President. Thru the efforts of the Washington Radio Club president, W9ER, Mr. Roosevelt personally received the messages from the GPR Committee. Our impressions after the delivery of the GPR messages to the White House left us with one outstanding above all others; namely, that our president not only knows those things a president is expected to know but in addition knows much about everything in the daily lives of all of our people. When we were ushered into his office, a very homelike and comfortable room, he was sitting at his desk, smoking. The members of our committee, shown in the photograph, were introduced to the president by his first secretary, Mr. McIntyre. As the club president was out of town, Mr. Corderman, W3ZD, past-president W.R.C., handed him the sheaf of messages. President Roosevelt accepted the messages and thanked us for them, remarking that it was on the occasion of the last flood that amateur radio had been called to his attention and that now, we were again going through another flood experience.

We expected to follow the camera man from the room. Our retirement, however, was postponed by Mr. Roosevelt remarking that he had given thought to amateur radio. After an enjoyable visit of about twenty minutes and discussion of flood traffic problems we took leave of the president, with the impression that he is physically well, mentally happy in his work, and also, acquainted with and interested in our activities as radio amateurs. President Roosevelt suggested that in times before floods we could establish networks in each river watershed to properly handle traffic during emergencies.

In conclusion, we hope all members of our League will be as well pleased with the results as we were. The WRC gang enjoyed the job im-

Actual Modulation Percentage Shown on Direct Reading Scale

TRIPLET

MODULATION MONITOR

Dealer Price

\$24.83

for

All Voice

Transmitting

Stations

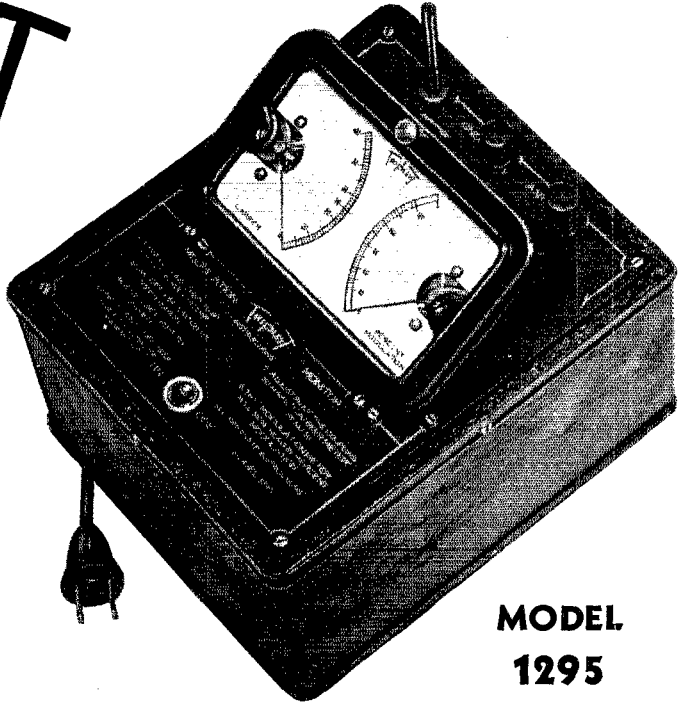

**MODEL
1295**

ELIMINATES the uncertainty of depending on the ear, variation of antenna ammeter or the loop and light in determining carrier shift and percentage of modulation. Actual modulation percentage is shown on direct reading Triplet twin instrument scale.

Modulation is indicated on scale from 40 to 120 per cent. All readings in peaks. Visual information on second dial provided for carrier reference level for the modulation test and also to check carrier shift during modulation. All uncertainties regarding final adjustments on the

transmitter eliminated with the use of Triplet's Modulation Monitor. Prevents monkey chatter, cross talk and B.C.L. interference. Factory calibrated and no further calibration needed.

Model 1295 Modulation Monitor—Complete with necessary accessories. Dealer Price **\$24.83**

THIS IS A TRIPLET MASTER UNIT

See the Modulation Monitor at your jobbers. Triplet manufactures a complete line of Precision Radio Testing Equipment and Precision Electrical Measuring Instruments for the Amateur and Experimenter. Complete information available on request.

SEE YOUR JOBBER—WRITE FOR CATALOG

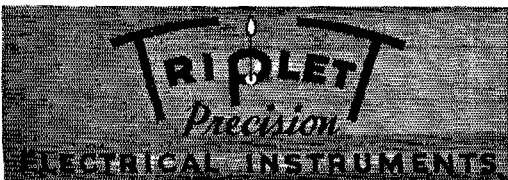

TRIPLET ELECTRICAL INSTRUMENT CO.
253 Harmon Avenue, Bluffton, Ohio

Please send me more information onModel 1295 I am also interested in

Name

Address

City State

OHMITE RHEOSTATS

Save Money on
TUBE
REPLACEMENTS

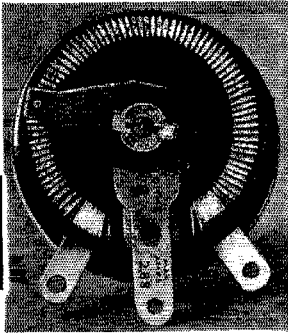

OHMITE Rheostats quickly repay their cost by prolonging the life of transmitting tubes. All tube manufacturers state that excessive voltage shortens the life of their tubes. Not only that, but voltages lower than tube ratings rob the tube of efficiency.

An OHMITE power rheostat connected to your input transformer primary gives accurate voltage control . . . without unbalancing the transformer secondary. Ask your jobber or write for complete information.

HANDBOOK
PAGES

518-519
CATALOG
SECTION

OHMITE

MANUFACTURING CO.

4831 Flounoy Street Chicago, Illinois

mensely and stands ready to cooperate in any way at any time that it can.

MESSAGE ROUTINGS

Transmitting time at the originating station and receiving time at the Washington station is indicated (Washington time EST). Dates are all January 19th unless otherwise stated.

Alabama: W4AG via W4DS (11:58 P.M. CST)-W9PDE-W1AFB-W3BWT (1:15 A.M., Jan. 20th)
 Arizona: W6KFC (7:10 P.M. MST)-W5DGP-W5MN-W4PL-W3FSP (10:25 A.M., Jan. 20th)
 Arkansas: W5ABL-W3FQB (8:23 P.M.)
 California: W6ZS (5:22 P.M. PST)-W3EZ-W3BWT (8:50 P.M.)
 Colorado: W9FA-W3BWT (2:05 A.M., Jan. 20th)
 Connecticut: W1AFB-W3BWT (5:40 P.M.)
 Delaware: W3BAK-W3BWT (4:45 P.M.)
 Georgia: W4KU (4:39 P.M. CST)-W4CQG-W4ANU-W3COJ (8:30 P.M.)
 Georgia: W4KU-W4CQG-W4ANU-(W4DW-N3EEN 9:10 P.M.) . . . W4DW intercepted while W4ANU was sending to W3COJ and relayed to N3EEN because he was not sure W3COJ received the message.
 Idaho: W7EFR-7-WLMM/W7NH-WLM/W3CXL (8:00 P.M.)
 Illinois: W9ISG-W3CDQ/W3ER (9:07 P.M., Jan. 18th)
 Indiana: W9SDQ (5:40 P.M. CST)-W1HKK-W1FRO-W1AFB-W3BWT (8:20 P.M.)
 Kansas: W9NI (4:12 P.M. CST)-W9PB-W9IQI-W9LH-W9PDE-W1AFB-W3BWT (12:30 A.M., Jan. 20th)
 Kansas: W9MUY-W3EZN (1:00 A.M., Jan. 20th)
 Maryland: W3CQS-W3BKZ (5:00 P.M.)
 Massachusetts: W1FRO-7-W2KI-W3BWT (6:36 P.M.)
 Minnesota: W9FUZ-7-W9JK-W3FQB (10:15 P.M.)
 Minnesota: W9FUZ-7-W9OWU-W9PTU-W8KWA-W3EZ offered to W3BWT 12:10 A.M., Jan. 20th, but W3BWT's master log showed Minnesota message already received in Washington.
 Missouri: W9DFU (7:11 A.M. CST, Jan. 20th)-W4PL-W3FSP (10:35 A.M.)
 Montana: W7CRH-W9PTU-N3EEN (10:21 P.M.) . . . Not in W9PTU's report, so believed "intercepted" at N3EEN.
 Montana: W7CRH (7:55 P.M. MST)-W9PTU-W8KWA-W3EZ offered W3BWT 12:10 A.M. Jan. 20th. Master log at W3BWT indicated Montana message already in Washington.
 Nebraska: W9EDI (5:08 P.M. CST)-W9FAM-W9KJP-W3FQB (10:55 P.M.)
 Nevada: W6CW-W9NI-W3BWT (4:00 A.M., Jan. 20th)
 New Hampshire: W1BFT (6:10 P.M. EST)-W1IP-W3BWT (6:45 P.M.)
 New Jersey: W3ZL-W3FSP (7:15 P.M.)
 New Mexico: W5CJP (12:30 P.M. MST)-W5CGJ-W5ENI-W5DGP-W5MN-W4PL-W3FSP (10:35 A.M., Jan. 20th)
 New York: W2LU-W3FPQ (6:45 P.M.)
 North Carolina: W4DW-W3BWT (7:55 P.M.)
 North Dakota: W9KZL-W3ZD (5:25 P.M.)
 Ohio: W8BBH-N3EEN (7:20 P.M.)
 Oklahoma: W5CVA-W5CEZ-W4PL-W3FQB (9:10 P.M.)
 Oregon: W7FNZ-W7AJV (6:50 P.M. EST)-W7BXQ-7
 Pennsylvania: W3FXX (6:04 P.M. PST)-W3EZ-W3BWT (6:10 P.M.)
 Rhode Island: W1DDY-W3BWT (5:15 P.M.)
 South Carolina: W4CQG-W4ANU-W3COJ (7:35 P.M.)
 South Dakota: W9SEB-7-W9AZR-W8JTT-W3BWT (9:10 P.M.)
 Tennessee: W4AYE (4:00 P.M. CST)-W4PL-W3FQB (5:35 P.M.)
 Texas: W5ERU (12:25 A.M., Jan. 20th)-W2GGW-W2HZY-7-W1AFB-W3BWT (2:45 A.M., Jan. 20th)
 Utah: W6GQC (8:39 P.M. CST)-W9PDE-W1AFB-W3BWT (10:30 P.M.)
 Virginia: W3UVA-W3FRB (6:35 P.M.)
 Virginia: W3GE-W3FCF (1:05 A.M., Jan. 20th)
 Washington: W7DDY-7-(W7WY-W7DUE)-W9AZR-W8JTT-W3BWT (12:50 A.M., Jan. 20th)
 West Virginia: W8CZ (5:00 P.M. EST)-W8MCL-W8HD-W3BYA-W4DW-W3BWT (7:50 P.M.)
 Wisconsin: W9AKT (12:12 A.M. CST, Jan. 20th)-W9PDE-W1AFB-W3BWT (1:25 A.M., Jan. 20th)

R.D. ENGINEERS

Announce

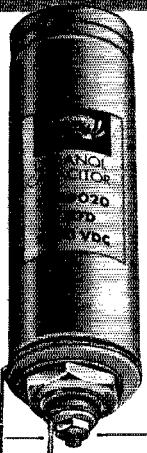

DYKANOL IMPREGNATED AND FILLED

The increasing need for a compact, dependable, high voltage filter condenser for high power amplifiers, transceivers, television circuits, etc., has been filled by the design of the Type TL series.
 Dykanol impregnated and filled in hermetically sealed round aluminum containers, similar to those used in the construction of electrolytic capacitors, the Type TL's are convenient for either upright or inverted mounting.

Cap. Mfd.	D.C. Volt.	Size	LISTING	Cat. No.	List
2	600	2 3/4 x 1 1/2	TL-6020		\$2.25
3	600	4 1/2 x 1 1/2	TL-6030		2.75
4	600	4 1/2 x 1 1/2	TL-6040		3.00
1	1000	2 3/4 x 1 1/2	TL-10010		2.25
2	1000	4 1/2 x 1 1/2	TL-10020		2.75
.5	1500	2 3/4 x 1 1/2	TL-15005		3.00
1	1500	4 1/2 x 1 1/2	TL-15010		3.50

For full details and listing send for Catalog No. 135A

CORNELL-DUBILIER CORPORATION
1013 Hamilton Blvd. So. Plainfield, N. J.



Taylor HEAVY **CUSTOM BUILT** DUTY Tubes

IMPROVED—NEW POWER!

203B

THE TUBE YOU HAVE WANTED

*CUTS COSTS IN TWO
OFFERS BIG PERFORMANCE*

Taylor Tubes has redesigned the 203B. The best tube buy on the market for 75- and 160-meter phone rigs.

The Mu and inter-electrode capacities of the 203B are designed to meet the requirements of 75 and 160-meter transmission. In transmitter operation this tube offers greater efficiency with less drive than types of lower interelectrode capacity tubes.

The 203B is also an outstanding value in Class B audio work. It operates with all regular type 203A Class B audio transformers.

At 1,250 volts, the 203B delivers 300 watts of audio, 200 WATTS IS EASY UNDER STANDARD CONDITIONS.

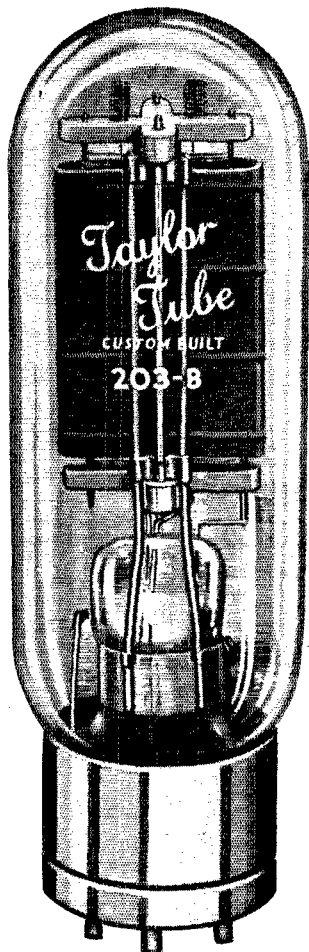

NEW CHARACTERISTICS (Type 203B)

Filament voltage.....	10
Filament current amps.....	3.85
Amp. factor.....	25
Thoriated Tungsten Filament	

Class "C" osc. and power amp.

Modulated D. C. volts.....	1000
Max. D. C. plate current mls....	150
Max. D. C. grid current mls....	50
Grid bias normal.....	-90
Max. plate dissipation watts....	55

Class B as Modulators (Push Pull Operation)

	200 Watt	300 Watt
D. C. Plate Voltage.....	1000	1250
Grid voltage approx.....	-35	-45
Load resistance (plt to plt) ohms.....	6800	7900
Av. D. C. plate current (2 tubes) mls.....	330	350
Static plate current (per tube).....	20	20
Power output (2 tubes) watts.....	200	300

The 203B Duplicates All Standard 203As in Electrical Characteristics at Half the Cost

The sensationally low price of the 203B is due to the use of a heavy-duty, long life carbonized metal anode instead of a carbon anode. Plate dissipation is naturally less (55 watts instead of 100 watts as in the carbon anode type), however, at the efficiencies normal to amateur transmitter operation, it is easy to run 300 watts input to a pair of 203Bs in Class C with less than the rated plate dissipation.

See your favorite parts dealer today!!! If he can't supply you, write us at once for full particulars

"More Watts Per Dollar"

TAYLOR TUBES, INC., 2341 WABANSIA AVE., CHICAGO, ILLINOIS

Bruno's NEW LOW COST

WIDE RANGE HIGH OUTPUT HUMLESS MICROPHONE

Not just another Mike!

Based on an exclusive Bruno construction feature, the rugged Velotron, embodies the high fidelity characteristics of the velocity, surpasses the output of the diaphragm type crystal and is as low priced as the best carbon. The Velotron is a true velocity microphone utilizing a static, instead of the customary magnetic field.

Check these outstanding characteristics found only in the

BRUNO VELOTRON

☆ Highly directional ☆ Low feedback level ☆ Variable Frequency response (30 to 14,000 cycles) ☆ Output level — 50 db. (Zero level 6 milliwatts) ☆ Absolutely humless ☆ Thoroughly shielded ☆ Not affected by varying temperatures or changing atmospheric conditions.

Complete with shock absorber, ball swivel, detachable cable connector, and 3 feet of single shielded cable. Model A only \$20.00 list. Model H also available for portable use.

Get your jobber to demonstrate the New Velotron to you! . . . or write direct for complete descriptive catalog.

ONLY
\$20
LIST

BRUNO

LABORATORIES, INC. 34 WEST 15th ST. N.Y.C.

MR. E. H. RIETZKE

PRESIDENT OF CREI

Have YOU a Right to Succeed In Radio?

Professional radiomen can acquire the necessary additional ability by home study training in their spare time. The CREI courses in Practical Radio Engineering are practical — and have been thoroughly tested and proved in all branches of the industry.

FREE:
Just off the Press

New illustrated booklet "A Tested Plan for a Future in Practical Radio Engineering." Write for your personal copy at once!

TRAIN NOW!

New radio developments demand the services of highly skilled technicians. Training NOW can mean thousands of dollars to you in years to come. You have the right to succeed if you have the ambition to study. Write for our interesting booklet.

CAPITOL RADIO ENGINEERING INSTITUTE

Dept. Q-3

WASHINGTON, D. C.
14th and Park Road

NEW YORK CITY
29 Broadway



Hawaii: (K6JFV) K6JPD-W2DP-W2HHF-W3FQZ (4:00 P.M., Jan. 20th)
Virgin Islands: K4AAN-W3ELN (8:33 P.M., Jan. 20th)
Philippines: KA1HR-7-WLMI/W6GXM-WLM/W3CXL (10:15 P.M., Jan. 20th)
Alaska: K7ELM-K7ASV-K7PQ-W3EDP-WLNE/W3ZIWLM/W3CXL (10:15 P.M.)
Alaska: K7ELM-K7ASV-K7PQ-(W1AFO)-W1CAB-W3BWT (11:15 P.M.). . . W1AFO intercepted the message while K7PQ was sending it to W3EDP on 14 Mc. and relayed via W1CAB, since he was not sure W3EDP had received the complete message.
Alaska: K7ELM-K7ASV-K7PQ (7 P.M. PST)-W6ZX-W3FQB (11:50 P.M.)
Alaska: K7ELM-7-W7LD-W7CRH-W9PTU-W8KWA-W3EZ offered to W3BWT 12:10 A.M., Jan. 20th, but W3BWT's master log showed Alaska message already received in Washington.

Extras:

The Mayor of Salisbury, Md., sent a message via W3CQS-W3BWT (5 P.M.)
Vermont: The SCM of Vermont sent a "service" advising no message received from the governor. It was believed the governor was going to attend the inauguration. The routing: W1GNF (5 P.M. EST)-W1FSV-W1IP-W3BWT (6:50 P.M.)
Michigan: W8DSQ was unable to get a message from the governor who was reported expected in Washington for inauguration, busy with strikes, etc.
Mississippi: The SCM advised W4PL that he was unable to get a message from the governor.
Maine: The governor indicated advance willingness to send a message but W1BWR reported that he failed to file one.

GPR Notes: The Minnesota message was started by Armond D. Brattland, W9FUZ, assistant attorney general of that state. . . . Since it was necessary for the New Mexico originating station to start the message during his "noon hour," this message was sent ahead of the official starting time; however, W5CGJ held it until the relay had actually begun. . . . The Pennsylvania message was started by Mrs. Mary C. LeVan, W3FXX, wife of W3MG. . . . W9SDQ passed the Indiana message to W1HKK on 14-Mc. 'phone. . . . W1HKK shifted to 3.5 Mc. and put it on Trunk "C." . . . W3EZ received the California message direct from W6ZS on 14 Mc. . . . W4PL in contact with K4AAN at about 3:00 P.M. CST, January 20th, endeavored to take the Virgin Islands message, but conditions would not permit. . . . the V. I. message arrived later via W3ELN. . . . The Georgia and South Carolina messages were handled via 3.9-Mc. 'phone. . . . W4DU of Jacksonville, Fla., assisted in relaying the Georgia message when W4CQG's transmitter developed trouble. . . . W4CYN and W3AIJ attempted to handle the S. C. message but failed due to conditions. . . . A word of thanks is due the many operators who stood by to assist should they be needed. . . . W9SDQ gives much credit for the successful handling of the Indiana message to W9YGC, who tried for several hours to contact a Washington station direct and who was directly responsible for securing the contact with W1HKK. . . . In North Dakota, W9KZL reports that W9PQW, Fargo, had arranged schedules with two Washington stations (W3ER and W3EZN) to help in case W9KZL's plans didn't work out. . . . W9NNM stood by on Trunk "G" to help in cases of QRM, etc. . . . Operators of A.R.R.L. Trunk Lines "A," "C" and "G," and the National Trunk Line Net did some excellent work during the Relay. . . . W5BMI checked with Washington on the Arkansas message, making doubly sure that his state was represented. . . . In West Virginia a number of additional stations were standing by: W8PSR, W8HWT, W8LII, W8KKG, W8CFB, W8NAU, W8PTJ, W8MCR. . . . W9SJK performed a real service for W6ZX in acting as the "go-between" in getting the Alaska message to W3FQB. . . . In filing his message as Governor of Pennsylvania, Governor Earle added, "I would like to express my appreciation for the work of amateur radio operators in Pennsylvania. I think particularly of the tremendous public service they rendered during the disastrous floods of last March. I shall be happy if you will relay that message to your fellow amateurs."

BUY NOW ON EASY CREDIT — prices are going up!

MARVIN KIRKBEY — W9JAS } Added to our technical staff.
HARRY HARRISON — W9LLX } Write your problems to them.

NEW SERVICE — Time payments on parts and tubes totalling \$60.00 or more. Write for details.

DON'T WAIT until you have ready cash. Buy now on *easy credit*, at today's prices. Your saving will more than offset the small cost of our low rate 6% credit plan. Prices have already advanced about 20% during past month, and are sure to go *much higher!* Prices guaranteed for *this month only!*

SPECIAL HAM BARGAIN PLATE TRANSFORMERS

Manufactured by UTC

20462A — 750-1000 each side of center. AC at 300 mills. \$5.70
20462B — 1000-1250-1500 AC each side of center. 300 ma. \$7.35
20462C — 1500-2000-2500 each side of center. AC. at 300 mills. \$11.95
20462D — 1000-1250-1500 AC each side of center. at 500 mills. \$11.75

Varimatch Modulation Transformers

VM-1. Will handle any power tubes to modulate a 20 to 60 watt class C stage. Maximum audio output 30 watts. \$4.70
VM-2. Will handle any power tubes to modulate a 40 to 120 watt class C stage. Maximum audio output 60 watts. \$7.35
VM-3. Will handle any power tubes to modulate a 100 to 250 watt Class C stage. Maximum audio output 125 watts. \$11.76
VM-4. Will handle any power tubes to modulate a 200 to 600 watt Class C stage. Maximum audio output 300 watts. \$19.11
Thordarson No. 16878 Plate and Filament Transformer, 600-0-600 V. at 200 MA. 2 1/2 V. at 10 amp. 5 V. at 3 amp. 7 1/2 V. at 3 amp. \$2.45
High Voltage Transformer, 1000-750-500-0-500-750-1000-300 MA. 3 1/4 x 4 1/2 x 5 1/4. \$5.95
These transformers are heavy cast Iron Frame open mounting type. Heavy Insulation. Heavy Rockbestos leads. Fully Guaranteed.
1600-1335-0-1335-1600 A.C. R.M.S. 1250-1000 V. DC — 400 MA. 7" w. x 6" d. x 5" h. \$11.00
1950-1600-0-1600-1950 A.C. R.M.S. 1500-1250 V. DC — 500 MA. 8 1/4" w. x 7" d. x 7" h. \$14.50
2350-1950-0-1950-2350 A.C. R.M.S. 2000-1500-0-1500-2000 — 500 MA. 8 1/4" w. x 7 3/4" d. x 11" h. \$18.50

Filament Transformers

If you like to save money on quality merchandise here's some real bargains. No. 25 Volts, 10 Amps — 2500 Volts Insulation — No. 2510. \$0.95
6.3 Volts, 3 Amps — 1600 Volts Insulation — No. 63S. \$0.95
7.5 Volts, 3 Amps — 1600 Volts Insulation — No. 75S. \$0.95

CHOKES

18 Henries, 125 M.A., \$1.15
A real quality choke. Resistance 130 Ohms. No. NS115. \$1.15
Thordarson No. 16877 Heavy Duty Choke. 15 henries at 250 MA. \$1.95

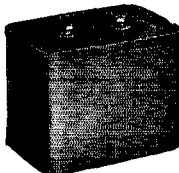

Use the 10 mfd. for perfect filtering in class B modulation Power Supply.

ORDER DIRECT FROM THIS AD — NOW

Receivers listed in this ad are best values anywhere. Order today on EASY TERMS. Send your down payment with order. Set will be shipped immediately upon approval of your credit. Entire transaction in 1 week. No red tape. Full details of any item, with complete NEW CATALOG FREE upon request.

EASY PAYMENT TERMS RECEIVERS

These receivers are among the best values money can buy. Our 6% EASY CREDIT PLAN makes it easy to own one. Compare our rates! Send down Payment with your order today. Set will be shipped as soon as credit is O.K.'d. Entire transaction 1 week. Order now!

	Cash Price	Down Payment	6 Months	9 Months	12 Months
HAMMARLUND SUPER PRO complete with tubes, crystal and speaker.	\$255.70	\$55.70	\$34.62	\$23.44	\$17.86
NATIONAL NC-100 complete with tubes and speaker.	\$125.10	\$25.10	\$17.74	\$11.93	\$9.02
NATIONAL NC-100X complete with tubes, crystal and speaker to match.	\$147.60	\$32.60	\$20.26	\$13.64	\$10.36
NATIONAL NC-101X complete.	\$129.00	\$29.00	\$17.74	\$11.93	\$9.02
NATIONAL HRO less power supply and speaker.	\$179.70	\$39.70	\$24.46	\$16.51	\$12.57
NATIONAL HRO with power supply.	\$195.60	\$45.60	\$26.14	\$17.67	\$13.45
NEW ACR-155 complete with tubes and built in speaker.	\$74.50	\$19.50	\$10.16	\$6.83	
RCA-AGR-175 complete receiver, speaker separate.	\$119.50	\$24.50	\$16.90	\$11.37	\$8.59
RME-69 complete with tubes, crystal, speaker housed in baffie.	\$151.20	\$31.20	\$21.10	\$14.21	\$10.80
HALLICRAFTERS SX-11 speaker in cabinet \$12.00 extra.	\$99.50	\$24.50	\$13.52	\$9.09	\$6.87

We will have new receivers, as released by manufacturers, on our deferred payment account. Full details of any set listed, mailed immediately upon request.

VERY SPECIAL OIL FILLED AND OIL IMPREGNATED FILTER CONDENSERS

Lucky Purchase of 10,000, all well known makes, enables us to offer astonishing low prices. All Guaranteed at rated voltages. Already sold down to limited supply and going fast. Order now!

Cap.	Voltage	Size	Weight	Price
1 mfd.	2000 V. DC 5	3 3/4 x 1 1/4	1 1/4 lbs.	\$1.25
2 mfd.	2000 V. DC 5 1/2	3 3/4 x 2 1/4	1 1/2 lbs.	1.50
8 mfd.	2000 V. DC 5 1/2	3 3/4 x 4	4 lbs.	2.75
9 mfd.	3000 V. DC 5 1/2	3 3/4 x 11	9 lbs.	7.25
(including 2 1/2" bakelite standoffs)				
4.4 mfd.	1500 V. DC 5	3 3/4 x 1 1/4	1 1/4 lbs.	1.75
5 mfd.	1500 V. DC 3 1/2	3 3/4 x 1 1/4	1 1/4 lbs.	1.90
5.2 mfd.	1500 V. DC 5	3 3/4 x 2 1/4	1 1/2 lbs.	2.00
10 mfd.	1500 V. DC 5	3 3/4 x 3	2 1/4 lbs.	2.75

FREE JUST OUT! BIG NEW! CATALOG!

Big Bargains in Parts. Equipment and Supplies for Hams, Servicemen and Dealers. Lowest Wholesale prices. Write quick!



NEWARK ELECTRIC COMPANY

226 W. MADISON ST. Dept. Q CHICAGO, ILL.

Save Your Tubes and Equipment

with
RE-CIRK-IT

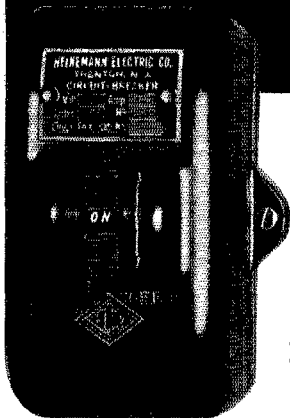

Combined power switch and circuit-breaker — 50 milli-amps. to 35 amps.

Handsome bakelite case. Indicator handle. Single-pole. Time delay or instantaneous trip types. $4\frac{7}{8} \times 3\frac{1}{2}$ " base.

Extremely accurate. Instantaneous trip type set to exact point desired with plus or minus 20% adjustment.

Almost instantly reset if current has returned to normal after tripping.

Order Yours Today Only \$5.00 C.O.D. (1-35 amps.) Or \$5.50 for ratings under 1 amp. Pays for itself many times in tubes and equipment saved from burnout. Literature on request.



HEINEMANN
ELECTRIC COMPANY
TRENTON, N. J.

WE OFFER —

Specialized personal service of genuine value that is not available from other jobbers.

Time sales of all receivers and transmitters with terms arranged to suit you and 6% interest charge. We finance our own paper. Trade in your equipment for the down payment.

Complete stock of all amateur apparatus at net prices.

TRADE IN YOUR RECEIVER

All receivers shipped on ten day trial. You need send but \$5.00 with order, balance C.O.D. These receivers in stock:

RME-69s Complete	\$151.20
The new 1937 Breting 14s	99.00
The new RCA ACR-155	74.50
RCA ACR-175s	119.50
The new 1937 Super Pro (now ready)	238.14
The new Hallicrafters Sky Challenger	69.50
Hallicrafters Sky Buddys	29.50
Hallicrafters Sky Chiefs	44.50
Hallicrafters 1937 Super Skyriders S-11	89.50
Hallicrafters Ultra Skyriders S-10	99.50
The new Patterson PR-15 (when ready)	109.50

TRADE IN YOUR TRANSMITTER

All Collins, Harvey, RCA, RME, Marine, All Star, Utah transmitters at net prices. Sold on terms to suit you with two years to pay and 6% interest charges.

HENRY RADIO SHOP

211 North Main Street

BUTLER, MISSOURI

Directivity of Horizontal Antennas

(Continued from page 40)

whole horizon can be obtained by the simple expedient of using two antennas at right angles to each other. With such an arrangement the directions covered least effectively by one antenna will be covered most effectively by the other. If—and we heartily recommend the practice, especially in DX work—the same antenna is used for receiving and transmitting, it is a simple matter to switch from one to the other while receiving and pick the one on which the desired signal is loudest. The same one, of course, should be used for transmitting. Very few locations will not permit running two 33-foot wires at right angles to each other. For equal performance, the two antennas should be at the same height.

Although this discussion is confined to horizontal antennas, we might interject parenthetically here a reply to the natural question that arises after the above suggestion—why not use a single vertical antenna instead of two horizontal ones? The answer

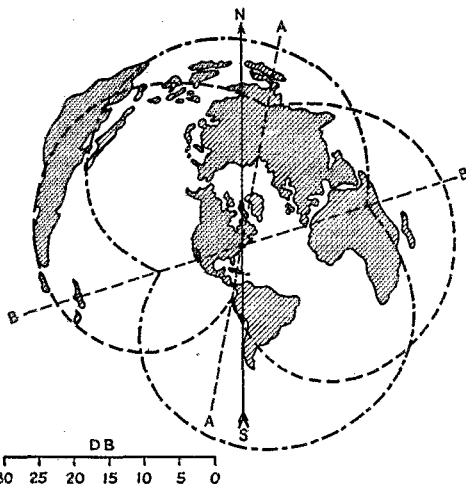

FIG. 8—ILLUSTRATING THE USE OF THE DIRECTIVE DIAGRAMS IN CONJUNCTION WITH AN AZIMUTHAL MAP

is that the horizontal antenna usually is more favorably situated with respect to the energy-absorbers in the neighborhood. Using the same pole height, the horizontal antenna is well above its surroundings; the vertical has to drop down nearer the ground where it is more apt to be shielded by houses and trees. From the low-angle radiation standpoint, there seems to be no particular advantage in using a vertical antenna, since at frequencies above 10 megacycles most of the energy radiated at angles lower than 15 degrees is greatly attenuated.⁴ On the whole, these two

⁴ Ladner and Stoner, "Short-Wave Wireless Communication," p. 226. For horizontal antennas, the assumption of perfectly-conducting ground seems to give calculated results in good agreement with experimental results.

G5BY Bridges Atlantic on 5 Meters!

*Hand and hand with world famous experimenters **EIMAC** tubes are aiding in the conquering of new fields*

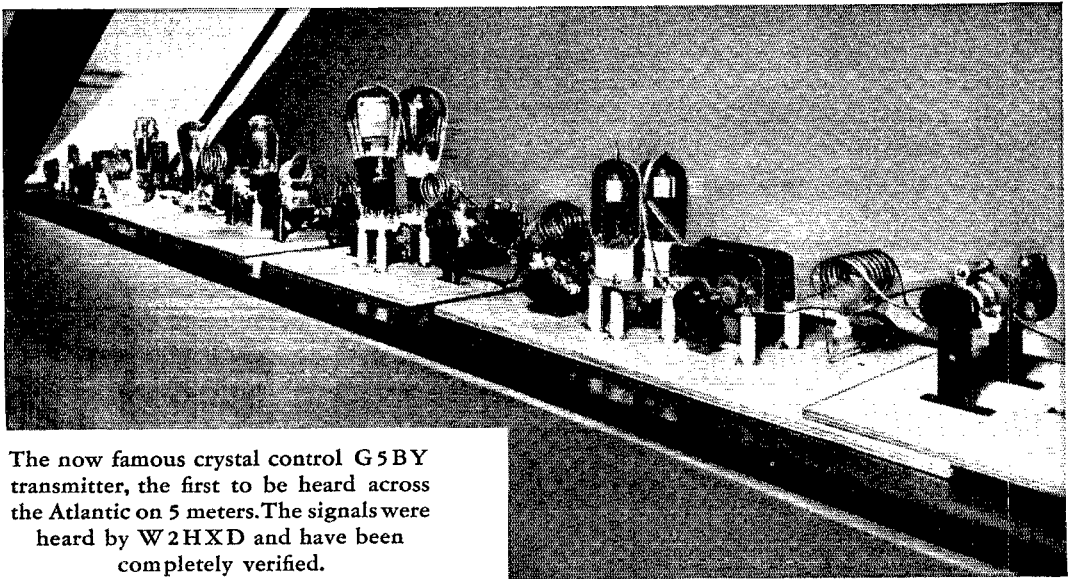

The now famous crystal control G5BY transmitter, the first to be heard across the Atlantic on 5 meters. The signals were heard by W2HDX and have been completely verified.

☞ G5BY uses two **EIMAC** 35T's in the final amplifier with inputs of 100 to 250 watts.

☞ G5BY says "*thanks for turning out such a fine tube...it makes 5 meter operation like 40!*" ☞ Why buy copies of these internationally famous tubes.

The *original* **EIMAC** tubes cost no more.

EITEL-McCULLOUGH, INC.

San Bruno, California, U. S. A.

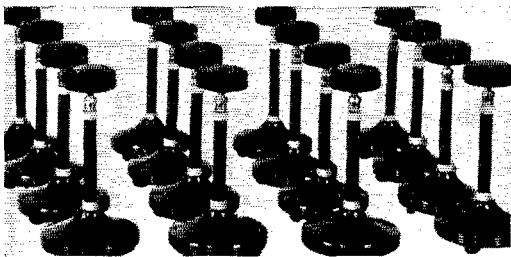

GET BROADCAST QUALITY REPORTS with VT-73

Hams from coast to coast are getting Broadcast Quality reports with the new VT-73.

**High Level Output
R. F. Feedback Banished**

THE VT-73 REQUIRES LESS AMPLIFICATION

It is 100% shielded, from the diaphragm to the heavy duty plug. The cable is anti-resonant too.

LIST — MIKE-STAND, SHIELDED PLUG..... \$27.50

Write today for new booklet 10C

**THE TURNER COMPANY
CEDAR RAPIDS, IOWA**

Licensed under patents of the Brush Development Company

ALADDIN

**The new induct-
ance-tuned i-f
transformer
(Type L)**

TUNING is accomplished by changing the position of the Polyiron cores in the fields of the respective coils. High quality fixed capacitors are used instead of variable trimmers of the compression type.

Greater stability is afforded with this type when used under extreme conditions of temperature, humidity and vibration.

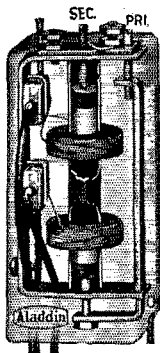

	<i>List Price</i>
L 150 converter for 262 kc.....	\$2.50 each
L 250 diode for 262 kc.....	2.50 "
L 101e converter for 465 kc.....	2.50 "
L 200e diode for 465 kc.....	2.50 "

ALADDIN RADIO INDUSTRIES, INC.
466q W. Superior St. Chicago, Illinois

Licenses of Johnson Laboratories, Inc.

points are borne out well in practice by the success with which horizontal antennas "get out."

TILTING

Despite the broad pattern shown in Fig. 4, there is a good deal of flexibility in the half-wave antenna—more so than in the case of long wires. For example, consider the patterns of Figs. 5, 6 and 7, which show how the directivity at a vertical angle of 15 degrees changes when the antenna is tilted with respect to the earth. These patterns again neglect ground reflection, and while when the antenna is tilted it is no longer true that reflection effects are uniform in all directions, for small angles of slope the discrepancy should be quite small.

Comparing the tilted patterns with the horizontal pattern of Fig. 4, it can be seen that the effect of tilting is to broaden out the pattern off one end of the wire and to pull it in off the opposite end. The pulling-in takes place off the high end for the type of antenna and angles of slope under consideration. For a slope angle of 15 degrees, the back radiation—from the high end—is zero in the direction of the antenna (at the 15-degree vertical angle) since there is no radiation along a line coaxial with the wire. With smaller slope angles there is a considerable decrease, but not an actual null.

Sloping the antenna is of comparatively little importance for transmission, although it would be useful where it is desired to get as broad a pattern as possible over an arc of some 180 degrees. Its real utility lies in reception—as a means of decreasing interference. As the patterns show, it is possible to reduce greatly the response to signals coming from the direction of the high end. This property can be used to advantage, especially by those living on or near either coast where most of the heaviest interference comes from one direction.

For example, in the vicinity of Hartford a half-wave antenna running slightly north of east will give maximum response both for reception and transmission toward South America and Asia. Most of the interference comes from a generally westerly direction, naturally. By sloping the antenna downward towards the east, U. S. signals can be cut down in strength to a marked degree in reception. Conversely, with a north-south antenna, used for working Africa, Australia and New Zealand, 'phone interference from the West Indies and Central America can be similarly reduced if the antenna slopes downward towards the north. The sloped patterns, transferred to tissue paper and placed over an azimuthal map for the location under consideration, will show instantly the possibilities of improvement in signal-to-QRM ratio by suitable choice of antenna direction and slope. It should be easy to reach a compromise between satisfactory transmission coverage and QRM reduction.

An example of this sort is shown in Fig. 8. Two antennas, which we will call A and B, were in-

(Continued on page 98)

LEEDS MAKES YOU STOP-LOOK-BUY

Rack Panels



By LEEDS are furnished with black shrivel finish in the standard 19" length, 3/4" thick. Mounting slots are spaced according to Bureau of Standards specifications, insuring freedom from all trouble in mounting or interchanging panels.

Steel	Price	Width	Aluminum	Price
PS-1	\$.52	1 1/4"	PA-1	\$.74
PS-2	.57	3 1/4"	PA-2	1.03
PS-3	.68	5 1/4"	PA-3	1.30
PS-4	.71	7"	PA-4	1.55
PS-5	.95	8 3/4"	PA-5	1.90
PS-6	1.15	10 1/4"	PA-6	2.45
PS-7	1.30	12 1/4"	PA-7	2.90
PS-8	1.50	14"	PA-8	3.35
PS-9	1.70	15 1/4"	PA-9	3.70
PS-10	1.90	17 1/4"	PA-10	3.90
PS-11	2.05	19 1/4"	PA-11	4.45
PS-12	2.30	21"	PA-12	5.20

Masonite Crystalline finish panels, 3/16" thick, sizes as above, prices slightly lower.

NAVY TYPE TELEGRAPH KEY



List \$3.60. Navy knob — 1/2" Tungsten contacts. While they last. \$1.15 With regular knob. .95c

AEROVOX

OIL FILLED AND IMPREGNATED CONDENSERS

1 mfd. 1000 v. \$1.59	1 mfd. 1500 v. \$1.67
2 mfd. 1000 v. 1.97	2 mfd. 1500 v. 2.30
4 mfd. 1000 v. 2.85	1 mfd. 2000 v. 2.09
	2 mfd. 2000 v. \$2.79

Electrolytic and tubular condensers in stock

Raytheon Transmitting Tubes

RK-10	\$.35.00	RK-28	\$.38.50
RK-15	4.50	RK-30	10.00
RK-16	4.50	RK-31	10.00
RK-17	4.50	RK-32	12.00
RK-18	10.00	RK-34	3.50
RK-19	7.50	RK-36	14.50
RK-20	15.00	RK-100	7.00
RK-21	5.00	841	3.25
RK-22	7.50	842	3.25
RK-23	4.50	866A	5.00
RK-24	2.25	872A	18.50
RK-25	4.50		

WRITE FOR FOLDER

The NEW sensational AMPEREX

Class B Tube, Type ZB-120. Completely described Feb. QST, page 77 **\$10**

HP-100	\$10.00
HR-200	\$24.50
HP-300	\$35.00

TRIMM 2000 ohm phones	\$1.80
4000 ohm	\$2.25
TRIMM featherweight	\$5.88
1X 20,000 ohm imp.	\$2.65

NOISE SILENCER ADAPTERS are a great help on reducing natural static too. LEEDS "QUIET CAN" and "SILENT CAN" also provide freedom from ignition noises and afford an ideal arrangement for push to talk phone and break-in CW.

LEEDS "Quiet Can" for receivers with 2 IF stages; less tubes	\$5.95
3 R.C.A. tubes	\$2.65
LEEDS "Silent Can", for receivers with 1 IF stage; less tubes	\$7.50
4 R.C.A. tubes	\$3.35

LEEDS has the most complete line of Antenna Wire found in any shop.

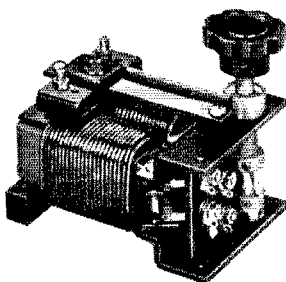

GENERAL RADIO Variac Transformers

A wonderful line voltage control, that is smaller, more convenient to use and furnishes high current over a narrow voltage range.

Type 70-B — 115 v. at 2 amps. \$10

Type 80-B — 115 v. at 7.5 amps. \$15

Write for Bulletin 67-Q for complete data

Here are two handy G.R. forms for that multiband transmitter.

Type 677-U — 21 turns. 2 1/2" diameter, resonant on 3.5 mc with 100 mfd. capacity; shipping weight 2 lbs. Price..... 56c

Type 677-Y — 30 turns 4" diameter, resonant 1.7 mc with 100 mfd. capacity; shipping weight 3 lbs. Price..... 75c

Also 7-pin base to fit above forms at 70c and a matching base with jacks at 65c.

G.R. Amateur accessories always in stock

LEEDS

Completely shielded High Voltage

Transformer

Made for us by one of the most reputable manufacturers in this field.

300 MA

750-1000 v. each side.....\$5.70

1000-1250-1500 v. each side..... 7.35

1500-2000-2500 v. each side..... 11.95

Type P — 1200 v. T. at 200 ma; 5 v. at 3 amp; 1 1/2 v. at 10 amp; 7 1/4 v. tapped at 6.3 at 2 1/2 v. Special..... \$2.95

Thordarson Neon Transformers, 115 v. primary — 1500 volts at 20 mils. \$1.45

Thordarson Cased Transformer, 600 volts each side of C.T. 200 ma 2 1/2 v. 10 amps. C.T. 5 v. 3 amps. 7 1/2 v. 3 amps. C.T. \$2.45

Thordarson Choke, 12 H. 250 ma. \$1.95

We carry the complete Thordarson line at 40% and 2% from list price.

COTO-Coil Low Loss Inductors

We have them for immediate shipment



LEADS THE FIELD

World Wide Service to Amateurs

45 Vesey Street

New York City

Tel. COntinent 7-2612

Cable Address: "RADLEEDS"

BASES and DEMI-BASES



Crystalline finished of 20 gauge steel; each base is finished with bottom cover plate.

8 1/4 x 8 x 2.....\$65	10 x 17 x 2.....\$110
8 1/4 x 10 x 2.....70	10 x 17 x 3.....1.30
8 x 17 x 2.....95	12 x 17 x 2.....1.30
8 x 17 x 3.....1.15	12 x 17 x 3.....1.40
	4 x 17 x 2.....\$70



GOING LIKE WILD FIRE

Our NEW LD-5 Mounted Crystals

These low drift plates, in the new LEEDS metal holder are outstanding from the standpoint of stability, accuracy, high output and low cost. Low Drift — 5 cycles per million per degree. Accuracy of calibration — better than .05%. Orders filled plus or minus

two kc. of specified frequency. Last but not least, the price of the mounted crystals, anywhere in the 160, 80 and 50 **\$3.50** meter band is only.....

Money back guarantee if you are not completely satisfied.

LEEDS type A.L. metal crystal holder, as illustrated above, fits standard 5-prong socket..... 89c

NATIONAL C R M Oscilloscope

Employing a 913 RCA tube; net \$11.10 (without tube). RCA 913 tube..... \$5.60

NC 100 — NC 100 X and 101 X

Hammarlund "Pro" and "Super-Pro" (less 40% off list)

Sold on time at cash prices in Metropolitan area. No down payment.

Liberal allowance on your old set.

We carry the complete line of NATIONAL and HAMMARLUND.

The BULLET, T.R.-2 electro dynamic Microphone, made by Transducer Corp. Special..... **\$29.23**
Model T.R.-3 List \$24.50. **\$14.70**
Special.....
Write for folder

TAYLOR Custom Built TRANSMITTING TUBES

T55 — 55 watt plate dissipation..... \$8.00

T155 — 155 watt plate dissipation..... 19.50

T200 — 200 watt plate dissipation..... 21.50

866 Mercury Vapor Rectifying tube... 1.65

866 junior..... 1.00

T-20 ceramic base, 20 watt plate dissipation, conservatively rated **\$2.45**

600 v. 100 mc. tube.....
All other types in stock

RCA 806 tube — \$24.50. Complete line of RCA tubes in stock. Write for folder.

TRIPLETT METERS

All standard ranges; 0-10 to 0-1000 MA

3 1/2" bakelite case..... \$3.75

2" bakelite case..... \$2.94

READRITE milliammeters 15 to 400 milles; any range, each..... 50c

All Triplett testers at regular wholesale prices

The record is 100% perfect. Thousands of microfarads of LEEDS OIL FILLED CONDENSERS are in use without one case of failure.

1 M F 1000 volt D.C. working..... \$1.10

2 M F 1000 volt D.C. working..... 1.45

4 M F 1000 volt D.C. working..... 2.00

1 M F 1500 volt D.C. working..... 1.45

2 M F 1500 volt D.C. working..... 1.95

4 M F 1500 volt D.C. working..... 3.25

1 M F 2000 volt D.C. working..... 1.75

2 M F 2000 volt D.C. working..... 2.45

4 M F 2000 volt D.C. working..... 4.65

1 M F 3000 volt D.C. working..... 2.50

2 M F 3000 volt D.C. working..... 4.95

STATION ACTIVITIES

(Continued from page 60)

CENTRAL DIVISION

ILLINOIS—SCM, John Huntoon, W9KJY—R.M.'s: ILH, RMN, P.A.M.: WC. Welcome back to Chicago. DOU and JZY. DOU has been appointed Radio Aide, Sixth C.A. A.A.R.S. JZY is second opr., and their new YF's are finding out the meaning of "radio widow." SKR is doing homework with one hand and pounding brass with the other. Notice: We are sorry, but due to S.C.M.'s lack of time, ILLI-NOISE has discontinued publication. RWS with new Skyrider, is learning touch typing for fast traffic handling. O.R.S. appointments expired the first of this year (with a month's grace period), and this year we are going to be as strict as possible about new appointees. EL2A furnished 83rd country for KA! EBX did nice job of furnishing communication to a stricken area near Hannibal, Mo., in conjunction with PYF and EFC. KJY is now C.A.N.C.S. A.A.R.S. AA has i.e.w. 56 Mc. signal that sounds like rotary gap. YBZ is interested in DX work on 1.75-Mc. c.w. VDA worked his first VK (on 14 Mc.) DX heard at RIY is excellent. TAY's New Year resolution: To improve the present transmitter to work more DX and have more QSO's. HQH finds O.R.S. appointment becoming a habit after five years. FB, Frank. WR is having trouble with a bum note. YZT plans on 3.5-Mc. c.w. for his first ham work. FLH forsook DX for 1.75-Mc. 'phone. New YL opr. at MIN keeps Smitty plenty busy. SHU is second opr. at MRH, k.w. 'phone. 80 countries for BPU! Someone is bootlegging YTV's call on 3.5 Mc. Missouri storm severed power at VEE, besides snapping off the mast. MRQ was elected new chairman of Chicago Area Radio Club Council, with TSN vice-chairman. HPG and PNV were reflected secy. and treas., respectively. NKJ popped a brand-new HF-100. MEF and SCH are contesting honor of "River Forest's Biggest DX Station." Not to be outdone by HUX, MIN, et al., ACU reports arrival of new YL opr. January 6th—Congrats! "Nic" of NIU now has '34 V-8. NXG is now Alternate N.C.S.: ILH seems to have competition—a "Miss Carol Keating." WWP, has taken up traffic work with nice start. MCC hears nothing but So. Americans and EL2A on 14 Mc. PLL's hand nearly healed, up goes the traffic total. We are trying to organize a more extensive network covering the state. Chicago is well covered, but we want stations in Rock Island, Rockford, Bloomington, Galesburg, Peoria, Springfield, Decatur, etc., or suburbs of these towns; write KJY if interested in organization and schedule work. DBO and CGV enjoyed A.A.R.S. speed contest. Lack of DX turns ANQ back to traffic work. GPK is monitoring 14-Mc. band for traffic destined Chicago each morning at 9:30. NHF is godfather of another new arrival—Jr. op. at IAL. SG and CGV were appointed Assistant Directors, Chicago area. Dizzy-G is ditto for East St. Louis area. UPW is pining for just one more state to make W.A.S. Among the unfortunates hit by the flu were DDO, GPF and FTX. The kw. is blasting forth again from NN. Director ZN is planning a ham half-hour program, tentatively set for WBBM (770 kc.) about midnight Saturdays. Write him for details if you haven't heard more definitely by the time you read this. ENH went on trip to Ohio. RAQ is going great guns in Wyoming.

Traffic: W9EBX 724 RMN 558 ILH 554 KJY 361 (WLTK 50) SKF 141 RWS 91 RBR 89 HPG 78 PLL 75 NXG 76 GPF 63 CGV 56 DDO 51 NN 26 ENH 22 HQH 18 PNV 17 WWP 13 MCC 12 FTX 10 LIV 8 NMZ 6 DBO 5 ANQ 4 NHF 5 GPK-BPU 4 WR-UPW-CFO 3 GSB-VEE-EQX 2 NIU-HUX 1.

MICHIGAN—SCM, Harold C. Bird, W8DPE—R.F.D. 2. Joe Lessard, W9PDE, Asst. S.C.M., Munising, Congrats, fellows, on your fine cooperation on the Michigan Nets, both Upper and Lower. Has any one heard of the Great Lakes Storm Net mentioned in this column in QST about two years ago? Good time to dig up the old equipment and get in on the Emergency Net of the A.R.R.I. MICHIGAN EIGHTS: FWU is doing nice job on daily nets. PBP has reliable QSO on 56 Mc. to Detroit. DED suggests holding hamfest in Holland during tulip time. DYH, our ex-S.C.M., has been doing a fine job in organizing our Evening Nets. EGI is back and looking for schedules. PKX, our friend in the C.C.C., comes through with nice report. BMG is doing nice work on Evening Net. CLL is going to help put Michigan back in

the running. NUV is ready to resume activities with new rig. QGD likes break-in. CEU is back with nice total. NGC is kept busy with A.A.R.S. and L.P. Net. JUQ is getting big kick out of nets. FX says the ole rig just won't work on 1.75 so he's leaving it on 3.5 Mc. DSQ is back on his feet again. FB, FTW says the A.A.R.S. is coming fine and all stations are invited. NXT is working 56 Mc. PXY wants O.R.S. DPE, ye S.C.M., is pulling his hair because those report cards are not coming in as they should. NHF is interested in Rag Chewers Club. MICHIGAN NINES: CWR is QRL on U.P. Net. CE reports new ham, YYA. ETE is suffering with bad jaw due to an extraction. A monthly report is appreciated. You owe it to yourself and fellow amateurs.

Traffic: W8FWU 50 DYH 89 EGI 1 BMG 29 CLL 35 NUV-QGD 1 CEU 200 QBZ 1 NGC 100 JUQ 6 FX 24 NDL 4 PXY 15 DPE 100 DED 22 RR/KNP 31 NHF 30 FTW 221 (WLTK 131) NXT 2 NQI 24 LSF 61. W9CWR 15 PDE 292 CE 39.

OHIO—SCM, E. H. Gibbs, W8AQ—Bart of ISK made the B.P.L. this month—says he has been trying for 18 years. FB, OM, IAW is active on Trunk "L" and National Trunk Net as shown by nice total. HMH has had to give up all schedules temporarily; Chuck certainly did an outstanding job, and we hope he can resume soon. The P.P. 849's at CMI are now running 600 watts. LCY is doing yeoman service as N.C.S. for the Ohio Regulars on 3710 kc. nightly. JZK is holding down position on Trunk "M." CIO (WLHC) still punches a big hole at 3780 kc. PWY applied for O.R.S. LZE takes part in Regulars and A.A.R.S. Nets and also schedules into Trunk "B." U.S.N.R. schedules keep BAH busy three days a week. AQ gets a kick out of working in Regulars Net. GSO considers 1.75 Mc. to dodge the QRM on 3.5. QNZ is new ham in Lancaster. BBH (WLHA) is another A.A.R.S. mainstay. RNC was married on January 9th. Congrats, Chas. His new address is 157 Logan, Bedford. GUL keeps daily schedule with 3GLN in Washn. Cambridge Radio Club meets last Wednesday each month—new officers are NQX, pres.; FNN, vice-pres.; MDU, secy.-treas.; VP, activities mgr. HCS is going to college now. GL, Bill, MXW has been losing sleep chasing 3.5-Mc. DX, 802 final at LVU now. BYM had FB score in SS. OZA is new reporter; uses 6L6-10 on 3532 kc. HFR is on 3946-kc. 'phone and keeps morning and evening schedules. NYP applied for O.P.S.; he operates chiefly on 14,180 kc. LGM chased some of the bugs out of his speech equipment. ORM hunts DX with his pair of '46's geared up to 85 watts. IAI's pet spot is 1919 kc. New rig at BKE—6L6 to P.P. '10's. KNF tried 14 Mc., but says wooden feeder spreaders not so hot. QHP had visit from 90ZI over Christmas. AXQ moved to 4077 W. 157th, Cleveland. JTI tried 56 Mc. for a change. PFT of Portsmouth is new reporter. DXB finally gave up linear r.f. amp. in favor of high level modulation. OPT migrated to 14 Mc. and QRO to 75 watts.

ATTENTION, 56-Mc. OPERATORS

The Buckeye Short-Wave Radio Association of Akron is sponsoring a 56-Mc. relay competition in order to stimulate and coordinate interest in this band in this part of the country. The test, which is to be held from 9:30 A.M., Saturday, March 6th, until midnight, Sunday, March 7th (E.S.T.), is open to any licensed amateur anywhere. Worth while prizes are offered. See details elsewhere in this issue. This is a real opportunity for 56-Mc. stations to take part in a worth while activity of this sort—the first of its kind in the country. It will require the participation of every available "5 Meter" station to put it over, so let's all help. Any correspondence in connection with the contest should be directed to W8KG, H. E. Dinger, 905 Berwyn Avenue, Akron, Ohio.

LAU of Salem is A.E.C. member, regularly on 3726 kc. GMI has been building measuring equipment and overhauling the rig. EMV is trying 6L6-807 for all band operation. LTI has P.P. '10's on 3.9-Mc. 'phone. OFN is new O.B.S. appointee—his RK-20 buffer took the long count, so new 804 replaces it. OPB received New Years greetings to

A.R.R.L. from HK5JD, EDR is rebuilding. ARF reports considerable 56 Mc. activity in Toledo. MDQ is busy bringing rig up to par. CDR has push-to-talk system that cost him 17 cents. QKB is having an 8-tube super made to order. LQQ has new Breting 14 and built some checking equipment for 'phone rig. MQP rebuilt with 50T final. NYY has been helping a shut-in get on the air. FB. NAL hooked some DX on 3.5 Mc.

Traffic: W8ISK 674 IAW 385 HMH 356 CMI 177 LCY 157 LZK 136 CIO 120 (WLHC 162) PWY 109 LZE 99 BAH 98 BBH 65 (WLHA 42) AQ 50 GSO 38 RN 37 APC 35 KIM 29 GUL 22 VP 18 ICC-HCS-MXW-LVU 16 BYM 15 OZA-BMK 8 HFR 7 NYP 3 LGM-ORM-IAL-BKE 2 KNF 1 MQO 120 NYY 79 NAL 25.

WISCONSIN—SCM, E. A. Cary, W9ATO—AKT has new rig. SES is experimenting with 6L6 transmitter. SZL is QRL State Net, N.C.R. and A.A.R.S. ATO is getting on the air more lately. WSY is trying DX. RQM had notice from F.C.C. for harmonic radiation, antenna blew down and he blew a tube in his final! WQM says his '46 blushes every time he steps on the key. IDG and BTA are on 1.75-Mc. 'phone. WKL got a buck deer on his hunting trip. G'IT will soon have more watts on 1.75-Mc. 'phone. CDC is building 14-Mc. rig. SWJ works at WHBL to keep in trim for 1.75-Mc. 'phone. ACK has 6L6, 211 and '04A with 450 watts into final, on 7154 kc. FEO has new ACR-175. LED has new rig using 6L6, 802 and '10. CFT is back on 3.5 Mc. VKV is busy selling radios. WJD is looking for DX. PRM has Class A. LWX has new 4-Mc. 'phone. WMK has stepped up power with '10 final. YVB is on 3.5 and 56 Mc. VBC has new RME-69. ESV and X9DNU are building new 100 BC station at Wausau, WSAU. RJB will also be one of the operators. BJF and WWF bought new 56-Mc. transceivers. SCR has new 70-foot sky pole. DXI is in full swing on 4-Mc. 'phone. FII is rebuilding. PQY is thinking of building an oscillograph with new 913 tube. RBY is rebuilding after fire. HDP is op at C.C.C. camp near Superior. YNT is new A.A.R.S. member in 5th District. YNB is on 7 Mc. with Gross CW25 and SW3. ULE is still rebuilding 1.75-Mc. 'phone. JUE and JTQ have Super Skyrider and 250 watts on 14-Mc. c.w. SPE is rebuilding again, also on 14 Mc. RSA is back on 7 Mc. after moving and rebuilding. RBI held schedules with SYV to keep in touch with niece who was in Milwaukee hospital. ONF has been working South America on 7 Mc. YEX is building 6L6 crystal rig. EXH installed 841. BWY has pair of 35T's in final. Fire at FSQ resulted in loss of ham and service equipment. HSK was appointed Corps Area Net Control Station for 8th Area. TFS is working on 14-Mc. 'phone rig. WNQ sent for HF100. JXZ conducts weekly code practice for beginners in Green Bay. FJJ and TDN are lab partners in physics class at U. of W. RNX was appointed O.P.S. IYL wants O.B.S. in Madison. JLM rewired his house and built metal cabinet for 1.75-Mc. 'phone rig in attempt to cut down QRM to B.C.L.'s. That's real ham spirit! DCU is using pair of 849's on 14-Mc. 'phone. DCU, operator at W1BA, demonstrated a midget oscillograph using 913 at meeting of Madison Club. AKT says, "The meeting discussed at length the QRM situation to the B.C.L.'s of the local 1.75-Mc. 'phone boys. Steps are now being taken to police the band and punish any who willfully do not try to make changes for the better. Over modulation will be corrected too, or else!" If every club would do this, the 'phone bands would be a much better place in which to operate. EWY ran several reels of motion pictures on Navy life at meeting of the La Crosse Club. The Green Bay Club has definitely decided to become affiliated. FB!

Traffic: W9AKT 63 SES 55 SZL 49 ONI 28 ATO 12 WSY 4 RQM 3.

MIDWEST DIVISION

IOWA—SCM, Owen Williams, W9NNM—More reports are requested to make this column a more comprehensive picture of Iowa activities. Club reports are particularly desired. NTB is building a new house. YYP is new call in Council Bluffs. SCV blew up his rig. RVE is attending the University of Iowa. SEE proudly exhibits an S.W.L. card from Asia. NVF uses a push-pull 53 for schedules. RQR is rebuilding from antenna to receiver. 8BMZ is now living in Davenport. The Charles City Radio Club received its A.R.R.L. charter. LCX leads the Seventh Corps Area in the A.A.R.S. code speed contest with a perfect copy at 40 words per minute.

Traffic: W9PGG 29 TGK 52 AWH 54 NVF 64 REH 146 RQR 292 NNM 414 LCX 527.

KANSAS—SCM, Harry E. Legler, W9PB—R.M.: 9IQI. The Sunflower Club (Hutchinson) and amateur radio lost an outstanding amateur when Earl Harden, FMX, passed away in Veterans Hospital at Wichita. The Section extends sympathies to his many friends and relatives. MKR teaches Manual Arts at Coffeyville and has organized a High School Club. New Sunflower Club officers: IXE, pres.; UPH, vice-pres.; VGS, secy.-treas. VEL says the Dodge City Club has new quarters in the Armory. The Wichita Club is arranging for Section A.R.R.L. Convention that will be different. Their new officers are UQC, pres.; TTU, vice-pres.; UFC, secy.-treas.; Earl Graves, pub. mgr. and assoc. rep.; TJQ, Sgt-at-arms. BEZ and DMF are putting up "Q" antennas. TTU and CVN are working 28 Mc. AWP placed very high in the SS. He says bootleg 56-Mc. operators were squelched by the R.I. UNQ, LKD, PGL, UQX and ABJ are all busy on 1.75-Mc. 'phone. UEG always sends in nice reports of local news and traffic as well, handling bunch of traffic from Governor Huxman's home town to Topeka when he was inaugurated. FLG was on the Topeka end. LRR and GWY visit UEG during holidays. IQI says the slump in his traffic total is due to getting married, but he is again moving trunk line and A.A.R.S. traffic as usual. Congrats and thanks for the cigar, OM. Lieut. Merrill in charge of WRK says they went in for amateur radio in the Cavalry Communication Platoon because ham radio furnished much better and reliable reports on conditions in Republican River flood last spring than their telephone reports did. UEG and CWW both hold O.O. and O.B.S. appointments now; look them up for frequency checks and the latest official news. YFE is going on 'phone. TTR is working 7 Mc. TTS burned out mod. transformer. IPD and MYV are working 1.75-Mc. 'phone. YAH has had over 900 contacts with 45 states since last June. VWV is putting a new 211D on 7 Mc. TAE is getting a new T55 for final. OAQ is chasing PY's on 14 Mc. PXW/9 boasts brand-new junior opr. in his first report to S.C.M. EVR, PFN and CKV are active again. YAL changed his '46's to '10's and now sleeps better. WAZ got League membership for Christmas. IYT visits his home town after being on Great Lakes as ship op. The S.C.M. is very pleased with the way the gang responds with reports, but remember that the Headquarters asks for worthwhile activity reports. It behooves us to direct our activities along such lines so that our efforts will justify suitable recognition.

Traffic: W9FLG 545 IQI 317 WRK 244 UEG 103 RAT 54 EYY 34 BYV 16 VAO-NFG 12 WBC 6 YAH 3 YFE-AWP-CWW-PXW/9 2.

MISSOURI—SCM, J. Dewey Mills, W9CJR—With the coming of the very severe sleet and ice storm in Missouri on about January 7th, the Missouri hams were afforded plenty of opportunity to step out with QRR work—and the reports show they did that very thing. KEF handled Telephone Company and Associated Press traffic from St. Louis to Hannibal. ENF handled emergency traffic for State Highway from Joplin to Kansas City, and also to Jefferson City via AIJ at Marceline. Highway Department very much appreciated this service. AIJ and SGP kept watch 5 hours per day during storm period. AIJ handled QRR traffic between Hannibal and Brookfield, Joplin and Jefferson City, and Jefferson City and Centralia. TCM was on QRR at Hannibal. TGN, Joplin, loaned two transmitters to WMBH for use between studio and station while 'phone lines were down. NNZ worked G2PL and G6WY on 3.5 Mc. MLR reports again after being off the air one year. UZS handled emergency traffic for Katy R.R. UYI handled QRR traffic for Western Union to New Jersey. OUD, even though antenna went down in storm, made the B.P.L. ARH still grabs plenty of DX. AHH has E.E. Degree and is going to work for Westinghouse. KYG is having troubles with portable. LBA reports best DX is ZT. KEI reports trunk schedule still clicking. RVP, St. Louis, is now signing PCT at school in Joplin. HEL is back active after extended absence. VXV dropped his 50-watter and it didn't bounce!! PYF handled emergency traffic with EFC, SRE, LBA, SGP, AIJ and FJV. VLP has schedules for direct traffic to W6, K6, KA and XU. Missouri hams note and contact VLP on 3570 kc. for traffic to and from West Coast, the Islands and China daily. VMI is on 1.75-Mc. 'phone. UYD is on 28 Mc. with high power and China Net. OWQ has W.A.S. and W.A.C. for her efforts this winter. Congratulations, Mrs. Hamilton.

(Continued on page 100)

How's Your Modulation O. M.?

Frankly we don't know but it is easily ascertained by constructing a low cost yet extremely f. b. oscilloscope as shown.

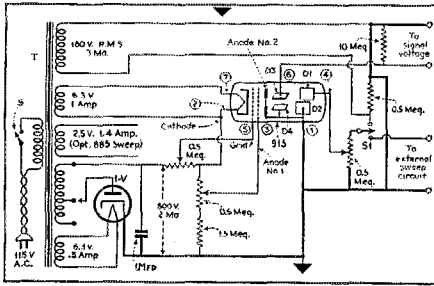

For a linear sweep circuit see *QST*, January, 1937

KENYON power transformer T-207 is especially designed for these and similar circuits. Amateur's net price \$2.40.

Our 64-page transmitter manual contains complete transmitter circuits ranging in size from five watts to one kilowatt. Fourteen pages are entirely devoted to full page Ken-O-Grafs. Obtainable from your local dealer for twenty-five cents or

Chief Engineer—Amateur Section

KENYON TRANSFORMER CO. INC.

840 Barry Street

New York, N. Y.

LOOK FOR THE NAME BIRNBACH ON INSULATORS THEN YOU ARE SURE YOU HAVE THE BEST!

... and that's because Birnbach are pioneers, creators and manufacturers of the largest and most complete line of reasonably priced insulators in the industry. Notable among Birnbach "firsts" are Feed Thru Insulators with insulating Bushings, in use throughout the world. Ask for them by name!

Feed Thru Standoff Insulators



An original Birnbach development. Two pieces. Designed and proportioned for maximum strength. Brass nickel plated hardware supplied.

Cat. No.	Height	List Price
No. 458	3/8"	\$0.12
No. 478	1"	.20
No. 478J	1"	.25
No. 4125	1 1/4"	.25
No. 4125J	1 1/4"	.30
No. 4234	2 1/2"	.35
No. 4234J	2 1/2"	.50

Stretchless Copperweld Enamel Antenna Wire

Steel case, copper covered, heavily enameled, low K.F. resistance. Fine for x'mitting doublet and directional antennae.
No. 12 Gauge — 100 ft. List price \$1.58
No. 14 Gauge — 100 ft. List price \$1.10
Special lengths to order

E01 Transmission Cable



No. 956 — 100-ft. spool. List price \$10.00

BIRNBACH RADIO CO. INC.
145 HUDSON ST. BIRCO NEW YORK, N. Y.

(Continued from page 94)

stalled about as shown on the map. Line A-A represents the axis of antenna A, which had approximately a 10-degree slope in the northern direction. The dashed pattern is the theoretical plot of this antenna. The axis of antenna B, with a slope of about 5 degrees toward the east, is shown by the line B-B, with the dot-dash pattern representing its theoretical directivity. The two antennas were approximately the same height above ground. Incidentally, they were not erected to do any particular job except that they were as nearly at right-angles as constructional convenience permitted; the main point of interest was to see whether the theoretical and actual performance checked.

A large number of listening tests has shown that the agreement between practice and theory is remarkably good, especially in view of the fact that the theoretical patterns are for one vertical angle only, while the actual signals arrive over a band of angles. In directions where the calculated difference between the two antennas is small—in the vicinity of 5 db or less—the theoretically more effective antenna usually will give a small increase in signal strength over the other, although often there may be no difference between the two. Where the theoretical difference is of the order of 10 db, the more favorable antenna invariably gives a noticeably stronger signal; at least an S point, often two. The greatest difference between the two antennas is theoretically 20 db, off the south end of antenna A, and it is here that the most striking differences in response are noted. For instance, a K5 signal which registers S4 on antenna A often comes up three S points on antenna B. Simultaneously, the majority of W signals drop down about two points when the switch is made from A to B. On several occasions when QRM has happened to be heavy, simply switching from A to B has brought a Canal Zone signal well into the clear where before it was audible, but drowned out by W's.

The ratio of response (on a given signal) between the two antennas varies from minute to minute under some conditions, indicating that the angle of arrival is varying rapidly. The ratio of response likewise changes with the time of day and on different days, a state of affairs which is to be expected from the varying nature of transmission paths. In general, however, the theoretically poorer antenna will never give a greater signal than the one theoretically best for the direction under consideration.

As a last thought, we repeat again the point concerning directions brought out in the preceding article. Ordinary maps are highly misleading when great circle routes are under consideration. A globe or azimuthal map for your location is a prime necessity for interpreting results. Humans may make mistakes as to directions, but the waves don't. When observed results fail to check with predictions, it is seldom indeed that the error can't be found in the observer's having assumed that the direction was north when it was really northeast.

A SUPER-HET that is a STAND-OUT!

"Red Hot" on 10 Meters

The time has passed for saying a receiver "gets down to 10." Model 21 STARTS there. The whole layout of the tuning unit was designed not only with the idea of getting down to 10 meters, but of doing something while there! By sharply peaking the input regeneration tremendous sensitivity is obtained on 10 meters and weak carriers, otherwise unreadable are brought right up out of the noise level. With Model 21, the superiority of the 10 meter band at this time of year is clearly shown. Stations operating on both 10 and 20 come in with more than double the 20 meter strength on 10.

Regenerative Input, All Bands

A new type of regeneration, smooth, non-critical, easy to operate. R.F. amplifier tube operates at full efficiency at all times, regeneration being separately controllable. Regeneration operates on all bands (including the commercial ones above 550 meters).

Noise Level Control

Another step forward in noise level control has been taken with the advent of Model 21. Increased efficiency through the improved regenerative input allows the I.F. amplifier to operate at very low level, greatly reducing or eliminating hiss and I.F. noise for the same signal level.

Commercial Model

Seven tuning bands, covering all the way from 9.5 to 3750 meters. Smooth, easy control all the way — no skips, no dead spots. Excellent reception on 600 meters, ship and airplane beacons and long wave time signals. Built to commercial specifications. Rack size panel.

SARGENT MODEL 21

- 12 Tubes (metal)
- Shadow Tuning
- Large, Calibrated Tuning Dial
- Regenerative Input, all bands
- Iron Core I.F.s
- Band Spread
- C. W. Oscillator, panel beat control
- Separate R.F. Gain Control
- Manual Volume or Amplified AVC
- Heavy, welded steel cabinet
- Speaker separate, in attractive cabinet
- Made in 2 Tuning Ranges:
 - Amateur Model 9.5 — 550 Meters
 - Commercial Model 9.5 — 3750 Meters

Battery Model for Direction Finders

Model 21 is available for 6 volt battery operation in either the amateur or commercial tuning range. The battery model is exceptionally good for radio direction finding work. Its complete shielding eliminates direct pick-up, giving sharply directional signals with a good loop.

Delivery

IMMEDIATE DELIVERY at time this ad is written. Growing demand may put us a few days behind, but we can promise very good delivery.

YOUR DISTRIBUTOR SHOULD HAVE IT IN STOCK

E. M. SARGENT CO.

Cable Address "EMSCO"

212 Ninth Street • Oakland, California

Radio Operator's Course

Complete in
Telegraphy—
Telephony



Practical
Experience
Studio—
Transmitter—
Announcing

P. A. C. is an endowed, educational institution — not privately owned, not operated for profit, maintaining college rank. Tuition rate \$15.00 a month; Dormitory room and board \$23.00 a month. The Radio Course consists of the maximum knowledge necessary to secure Commercial Telegraph Second-class and Radio Telephone First-class government licenses. The course includes Police and Aeronautical Radio, Service, actual experience in Wireless Code, Radiophone, Announcing, Microphone-Studio Technique. We are authorized to teach RCA texts. You receive practical studio experience in our commercial broadcast studios located in the administration building, and experience as an operator on K P A C (500-Watt Commercial transmitter located on the campus, owned and operated by the college), and inter-departmental marine communication experience.

If interested, write for Bulletin R

PORT ARTHUR COLLEGE • **PORT ARTHUR (World-known port) TEXAS**

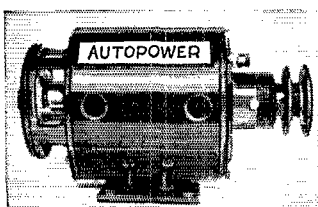

TURN SCRAP INTO MONEY

AUTOPOWER tells you how in plain, easy, simple, and illustrated instructions that anyone can follow. Change auto generators into useful, practical A C and D C generators and motors with voltage from 2 to 1,000 volts, for power, light, welding, radio, sound, etc. No previous experience nor special tools needed. Generators can be driven by wind, water, fan belt, etc. Already used and endorsed by thousands. Send today for your copy, and also receive FREE a copy of PRACTICAL ELECTRIX, the new publication for the man who wants to KNOW, BUILD, REPAIR and READ about electrical apparatus and machinery. Book and magazine postpaid only \$1.00. AUTOPOWER, INC., Dept. 5



414 S. Hoyne Ave., Chicago

Say You Saw It in QST — It Identifies You and Helps QST

(Continued from page 97)

SHK has been QRL trip to Old Mexico City. HUG and JVL both moved and settled on West Coast.

Traffic: W9SGP 606 OUD 590 AIJ 568 PYF 284 TCM 72 KEI 52 TGN 46 KEF 19 LBA 11 EDK 5 ENF 14 MLR-EYG-NNZ 3. (Nov.-Dec., W9PYF 171 TCM 110).

NEBRASKA—SCM, Samuel C. Wallace, W9FAM—DI is handling 9 daily schedules on 1761, 3795 and 7064 kcs. FAM is trying to work Trunk Line "L." UHT is keeping 13 daily schedules. EHW kept nightly schedule with UHT, who gave reports of condition of sick friend in hospital in Ogallala. Fine work! RUJ reports SUS and WKP on 1.75-Mc. 'phone. CUY is working RUJ cross-band, 7-Mc. and 3.9-Mc. 'phone. Southeast Nebraska Radio Club met at RUJ's and was organized after a long time of planning; VOI elected pres., WKP secy. & treas. POB's wife is very ill, so this accounts for no activity from him. Sorry, OM. KJP is working 7 Mc. DLX is kept busy digging out of snow banks. TQD is attending University at Lincoln. YDZ sends in report for the gang up at Norfolk and vicinity. YRM had bad luck; wind blew masts down. YHN was at YNO's during holidays. YQO rebuilt. GFI is trying for W.A.S.: ditto with YDZ, YHN and YNO. RVG left for Colorado. YDZ cusses about 4 hams in Nev., Ariz., Va. and Tenn. who don't QSL. YHN and YDZ are tied for lead with 39 states apiece. YRF rebuilt receiver.

Traffic: W9BNT 1166 (WLU 886) DI 734 FAM 595 UHT 122 EHW 44 RUJ 14 UDH 13 TBF 8 KJP 2.

DAKOTA DIVISION

NORTH DAKOTA—SCM, Hartwell B. Burner, W9OEL—DHQ reports rig working on all frequencies with a pair of '10's in final and has emergency rig ready for any emergency. RZA at Thompson puts out nice signal with 89 crystal-2-89's par. on all bands. EMY is now at Rugby. EAP, formerly of Upham, is now at Columbus, N. Dak., and is working portable with RK-20. DGS is on 2.8 Mc. RPJ of Fargo reports new 4-Mc. 'phone about ready with pair of 807's final. TWF puts out real sock with e.c. 802 to an RK-20 with 130 watts input. JMW is on 1.75-Mc. 'phone. WLI uses 6L6 to drive T55. RGT now runs 1 kw. DIW is on 14-Mc. 'phone. GND is new U. of N. Dak. call. JZL is now instructor of radio at Central High in Grand Forks. WFO is building new rig with T55 final. YEE has pair of 6L6's on 1.75-Mc. 'phone. TSB is on 3.5-Mc. c.w. YCJ will put in 825 final. YIZ is using 6L6 at Science School and keeps in touch with home folks via YWC. OEL has new rig going. KZL visited PQW at Fargo and GNS in Minot. KZL was appointed to handle Governor-to-President message and sure did the job in regular Rova style—he filed his message at 4 p.m., January 19th, and delivered same direct to Washington at 4.37 p.m. All Dakota Division S.C.M.'s and Director are now on 3800 kc. and Sunday drills continue very enjoyable.

Traffic: W9OEL 86 KZL 85 SWC 45 DM 40 WLI 22 RQX 15 DHQ 6 RZA 2 (Nov.-Dec., W9DGS 8 WLI 31).

SOUTH DAKOTA—SCM, Andrew J. Kjar, W9SEB—AZR made the B.P.L. with a nice total. ORY is using a 150T final. USI worked a W6, USI and USH are rebuilding for higher power. PPE is using a 6L6-6L6-801 rig. SRX is grid modulating a pair of 801's on 28 Mc. IQZ has a new Super Sky rider. SXN is rebuilding BC station KUSD. IQZ puts 700 volts on an R.C.A. metal 6L6. WPA picked up his plate supply with the juice turned on—result, he is rebuilding. Fellows, be careful with that high voltage! We don't want anybody hurt. YLG is a mail carrier. YKU is YL on 3.5-Mc. c.w. FOZ is back in White. ZAL is new ham in Delmont using 59 and 46's final. TY sold his rig to a ham in Clear Lake. LDU blew a ten in final. PPR is busy hauling coal to Miller hams. PGV was ZAL's first QSO. RKI is on 1.75-Mc. 'phone in Huron. VQC has a new crystal rig. WES is active on 3.5-Mc. c.w. BGB is on 3.9-Mc. 'phone. VOD and FOQ joined the A.A.R.S. How about a few more of you boys joining up with something worth while? If interested, just let me know. The Rapid City Amateur Radio Club sends code lessons on 3670 kc. daily at 8.00 p.m. M.S.T. YNW blew his filter in Dak. Division QSO party. TY and SCB are now located in Northville. FLO called on the Pierre hams and attended one of their meetings. ALO is trying to put a quarter kw. on a '52 won at Sioux Falls Club banquet. The South Dakota State A.R.R.L. Convention will be held in Sioux Falls, probably sometime in August or early September. In the Dakota Division QSO party SEB

heard a VP3 QSO a W9 on 3.5 Mc. SEB originated the Governor-to-President message, put it on Trunk Line (G) at 6:40 p.m.; 9AZR then put in to 8JTT, who in turn put it into Washington, D. C.—all in less than thirty minutes . . . plenty good for a message with a CK of 117; more power to those snappy operators on the T.L.

Traffic: W9AZR 673 WAJ 146 FOQ 138 SEB 124 VOD 74 PGV 15 YOB 11 YNW 3.

NORTHERN MINNESOTA—SCM, Leonard Hofstad, W9OWU—The Dakota Division QSO contest was a big success. More stations took part and the scores were bigger than in any previous contest. In No. Minn. 9TJF has the largest score—1708 pts. Congrats, OM. PTU is 2nd and your S.C.M. 3rd in this Section. The Gov.-to-Pres. message relay clicked very nicely. FUZ got the message from the Gov., your S.C.M. relayed to PTU, who put the message on Trunk Line "A." TEF is on the air with a 6L6G with 17½ watts input; the whole rig is built in a case 13¼ x 10½ x 6½; either a power pack or a genemotor fits into the case. CWB/9 is on at Crosby with a 9-watt 3.9-Mc. 'phone. The Ironton High School has again started a radio club. KQA is planning new transmitter with 6L6's that CWB gave him for Christmas. VTH is now Class A and is joining the A.A.R.S. VVA has only Asia left for W.A.C. on 7 Mc. MOW is on with a single ten at 30 watts input. MOV is working in Mpls. and will have rig on from there. WVD is having trouble with an old '03A. IGZ got two S.W.L. cards from England reporting his 28-Mc. 'phone S6; he is using a 6L6 in final and works all bands. SYX sent a nice contest score. OOV took part of his rig along when he went back to the U. HEO is on with a pair of T55's final. SZG and WQD are on at Crookston. YAP is still on 1.75-Mc. 'phone. OTW put in bridge rectifiers so he has plenty of voltage. UDK dropped in on your S.C.M. at the theatre. RGN has a new 6L6 rig. Your S.C.M. has rebuilt his power supply and is building modulator, and expects to use 28- and 1.75-Mc. 'phone occasionally.

Traffic: W9ORQ 167 HDP 9 RPM 19 OGZ 26 IGZ-FTJ 5 RJP 81 SXM 25 RTN 32 HEN 64 OTW 5 PTU 280 FUZ 1 OWU 111.

SOUTHERN MINNESOTA—SCM, Webster F. Soules, W9DCM—DEI hopes for a large score in the African DX contest. KUI is getting his 3.5-Mc. rig ready for the O.R.S. party. ZAD is a new ham from Preston. YNQ is going again with a '10 final. IDF wants a schedule to take any traffic for the colleges in Northfield. IGZ puts in a good signal on 3.9-Mc. 'phone. TKX is spending a lot of time handling traffic. DHP is using the same old '52 grid modulated on 28 Mc. CCX and DH did some excellent work finding an unauthorized station broadcasting on the broadcast band, and rated the front pages of the papers with the story. PTY says he had the S.C.M.'s call DCM on the first issue. DGH wants to put up a new antenna. RWH got a new candid camera for Christmas. SJK with EFK at the key helped out on a Governor-President message from K7ELM: it went from K7ELM to K7PQ, 6ZX, 9SJK, to 3FQG in three quarters of an hour. BF says the 150T is so easy to excite all you have to do is wave a grid milliammeter at it. DCM has moved to a new shack in the basement. The Minneapolis Radio Club elected new officers with FK as pres., EFK vice-pres., and RTE as secy.-treas. Plans are underway for a bigger and better MID-AMERICAN CONVENTION to be held this spring.

Traffic: W9TKX 46 SJK 21 BN 8 DEL 6.

WEST GULF DIVISION

NORTHERN TEXAS—SCM, Richard M. Cobb, W5BII—CIJ has new rig using 6L6 crystal and 830 final and made B.P.L. with nice total. BCW and CIJ handled gobs of traffic while wires were down. They received write-ups in several newspapers on this service. DXA now has a Trunk Line "D" crystal. He reports EEF and BEY are job hunting. EES has a 6L6 tri-tet oscillator and can work all bands down to "5 meters"; he has 170 watts input to final stage. FAJ reports DNE is located in Forth Worth. EEW handles most of his traffic using A.A.R.S. special frequency and the call WJMI. DVD reports by radio via EOE and DXA. FBQ has been operating mostly on 7 Mc. CPT has been sick since Christmas. FXN cracked his crystal. CAV has been operating some from CCD and sends radiogram. FOH worked his first VK and is going in for DX in a big way. BII is QRL with service work. Several O.R.S. are not reporting any activity. It takes only a minute

to fill out that report card, fellows. No inactive appointment will be renewed.

Traffic: W5CIJ 701 BCW 645 DXA 541 EES 254 FAJ 182 FMZ 67 EEW 2 (WLJM 34) DVD 25 BAM 15 FBQ 6 CPT 5 FZJ 3 FXN 2.

OKLAHOMA—SCM, Carter L. Simpson, W5CEZ—CEZ has been busy "spotting" crystals for the Okla. A.A.R.S. Nets. EXZ has moved station back to his home. FSK applied for O.R.S. appointment. CVA got a 300-W. job perking and now has three transmitters around the shack. FOJ did some FB QRR work during sleet storm; he has been appointed S.P.N.C.S. in Okla. A.A.R.S. EGP did some excellent QRR work. BDJ has a nice string of schedules working. FRC has some good schedules working. FXG has the rig paid for and is out of debt now. FX wants a schedule with a fast op to increase his speed. ADC is enjoying his work in the N.C.R. BLJ did some QRR work during sleet storm. EMD visited the S.C.M. and attended Ponca City Unit N.C.R. meeting. FLY is working in State Traffic Net. FFK lost his antenna in sleet storm. BNF is operating portable at Henderson, Texas. DZU plans to enroll in college for coming term. FBI received some new equipment for a new rig. BLT broke his crystal trying to get a 6L6 oscillator to perk. EMH is making a good showing in A.A.R.S. FRB joined the A.A.R.S. AMT conducts WX schedules with half of his antenna lying on the ground. FQN has been hearing a lot of DX on 28 Mc. The amateurs of Eastern Oklahoma had a chance to do some QRR work during sleet storm, January 8th to 11th, and EGP, FOJ, EZV, QL and EHY are commended on the manner in which they handled the matter. EHU is back on the air after a year's absence. FDP was visitor at FOJ's during Christmas. ENN has fired up on 3.5 Mc. FLE spent Christmas holidays at home in Muskogee. DSM, DRI, EMD and EWE had an all-night session at DWB's shack during Holidays. CJZ bought a new Chevy and moved to Bristow. AFX will be on with a pair of T200's soon. 56 Mc. is coming into its own in Okla. City. DQM now has a rig on at Norman. ESP has moved to Isabella where there is no 110 juice. FKL got Class A ticket. GFT is new ham in Enid. FJ is working in Louisiana. CWL and CPC have been working some 3.5 Mc. FEC says he is off frequency with YF cause he got a HF100 and RME69 instead of a new car. MAIL YOUR TRAFFIC REPORTS PROMPTLY. GBY of Tulsa has been off the air since November, '36; he is now receiving QSL cards confirming recent QSO's, which, of course, he never had. Anyone hearing or working anyone signing 5GBY please advise the rightful owner, giving freq., time, date, signal, etc. His address: K. L. Baner, 1 N. Gillette, Tulsa.

Traffic: W5CEZ 874 EXZ 394 FSK 350 CVA 221 FOJ 204 EGP 185 BDX 161 DWB 85 FRC 75 FXG 68 FX 52 ADC 37 BLJ 34 EMD 24 FLY 21 FFK 18 BNF 18 DZU 16 FBI 10 BLT-EMH-FRB 9 AMT 7 FFH-FQN 3.

SOUTHERN TEXAS—SCM, Ammon O. Young, W5BDI—CPB is taking things easy since the SS. EWZ has a new crystal on 7061 kc. and is planning to QRO. DWN's operating time is spent 100% in traffic handling. FDI has been working a slug of DX on 14 and 28 Mc. FGP visited KC and DGB over Louisiana way. AFG is on 14-Mc. 'phone with 400 watts and has worked ZE1JR and ZU6P. FKU and BUZ have new receivers. BUZ decided he would take a shot at 'phone. ETR is going to move to Tulsa. MN hits a new high for traffic handled in one month. EYB reports by radio via CVQ. EXR is now down to two operators as Cox (FSJ) has been transferred. Stevens, the DX operator at EXR, wants to know how many W5's worked over 45 countries on 7 Mc. during 1936; he worked 47, and as soon as he gets a total of fifty on 7 Mc. he is going to 14 Mc. OW really goes to town with December traffic. EYR is about to go 'phone since he had that QSO on 28 Mc. EYR and FGL "took in" the Harlingen Fair and while there visited with ENR. FKG got a new Mac-key for Christmas. ERC and YF visited DVK and EZH at Portland, New Year's Day. EUO's new rig will use a 6L6 and an 800. We are all sorry to learn of the passing of ETD—he will be missed by the 1.75-Mc. gang. The Southern Texas 1.75- and 3.9-Mc. 'phones handled quite a bit of emergency traffic in recent cold spell when all lines went out. EAL is back on with new antenna. COK is attending Rice. FDS will report from Austin for a while now. CHB is operating an emergency 1.5-watt 'phone on 1.75 Mc. EAM is building an 807 rig to work 28-Mc. 'phone. AMX is active in A.A.R.S. as well as on 3.9-Mc. 'phone. EFB blew his '03A. CLZ is working

7 Mc. FWB has a new rig with a ten final on 14-Mc. c.w. FDR is back on the air with 500 watts. DMB built a new 28-Mc. rig. EWJ is on 28 and 14 Mc. with 300 watts to P.P. 50T's. FI is getting ready for the DX contest. 3GCS was a visitor at BDI's shack. BDI hopes to have the rig and receiver finished by the DX contest in hopes of adding a few new countries.

Traffic: W5OW 2938 MN 1768 FDR 972 DWN 176 EYB 131 EXR 116 BEF 77 AMX 48 CPB 19 BKW 11 FDI 8.

NEW MEXICO—SCM, Joseph M. Eldodt, W5CGJ—E. C. Stents is a new ham at Grants, just having received the call GEY; he got in on the A.A.R.S. speed contest held January 11th and copied at 55 w.p.m.! DGP hit it off at 40 per, too. DGP did some fine QRR work on January 20th. It seems that a co-worker started for his home 60 miles west of DGP on the 19th, a blizzard came up, and the next morning he was reported as not having reached home. DGP started out to look for him, took a portable outfit along, found him, and immediately reported back, notifying the man's family. FB. GFK is a new ham at Chamita. Your S.C.M. finally has company in his neck of the woods, after being a lone ham for about five years—hi. Last but not least, the Section scores in the B.P.L. DGP makes it!

Traffic: W5DGP 1383 ENI 350 DZY 137 ZM 39 (WLJG 34) CGJ 47 (WLJE 5) FSP 31. WLJI 7.

DELTA DIVISION

ARKANSAS—SCM, H. E. Vette, W5ABI—AAJ is doing a fine work on T.L. "H." ABL handled Governors-President message. EWW is going to school at A.S.T.C. EIJ is operating on ship along east coast. FJY is alternate on T.L. "D." BMI is doing photography work as a sideline. EIP worked ZU and SM on 28 Mc. BTX is building new 'phone rig. FKT is on with new 1.75-Mc. 'phone. DRW and DRY are on from the U. of A. FPV is "going to town" on 3.5 Mc. CBK copies PX for KUOA. CVO is in charge of new rig at KUOA. EHO is operating at ENL. DTI has new rig with 170 watts input and is mostly on 1.75-Mc. 'phone. DNK has new Sky Buddy. GAR is on 28- and 14-Mc. 'phone. FPD, new O.R.S., got HRO for Christmas. FKQ's new rig has HF-100 in final. Please change the S.C.M.'s mailing address to 4415 West 12th St., Little Rock, Arkansas is headed for the top of the Division again. Please report all news in your section of the state. CVO sends the following news: DRW handled emergency traffic for Western Union, KCS R.R., and others when heavy sleet and ice tore down all communications services out of Siloam Springs. All messages were given to 9BNT, where 5BED, a former ham of this Section was at the key. BTX and BSG are finishing work on degree of U. of A. CGW is now "Sparks" in the Navy, stationed in China. AHS works in a "five and ten" in daytime and on "forty and eighty" at night. BJJ, QRT for several years, recently filled out papers for Class C license. DYF is Midshipman at U. S. Naval Academy. BXM switched to 28- and 14-Mc. 'phone. DXT is at Siloam Springs attending John Brown University. ASD has job as "Sparks" on freighter out of Mobile, Ala. DJE is boning up for Second Telegraph exam. DKX is learning to be "Sparks" at Naval Station at San Diego, Calif. FKT manages picture show and works 1.75-Mc. 'phone. The University Radio Club was recently organized at Siloam Springs; officers elected as follows: LD, adviser; CVO, pres.; CBK, vice-pres.; 4ADI/5, secy.-treas. The first project of the club will be to complete the club transmitter; the parts for this are from the old KUOA broadcast transmitter which was replaced this fall by a new Western Electric job. Membership of the club is of two kinds—regular, which includes all licensed amateurs, and associate, which includes those who do not hold an amateur license but are interested in radio. LD is getting back on the air with new 'phone transmitter. CVO moved to new QTH where there's plenty of space for a skywire. CBK, after being relief op at KUOA all fall, is now on with a regular shift. 6MWX/5 gets out nicely on 3.5 Mc. with 10 watts input to TNT. 6SQK/5 copies press for KUOA.

Traffic: W5AAJ 275 ABL 10 EWW 23 FJY 34 DRW 18 CPV 6 DTI 4 FPD 6.

LOUISIANA—SCM, Eugene H. Treadaway, W5DKR—4DQW from Alabama is operating portable at Camp Beau-regard, La. 5KC reports Trunk Line "H" working nicely. 5BUK wants it known that it is not his station being reported on 14-Mc. 'phone but rather 5DUK—alike in sound but by no means the same station.

Traffic: W5KC 16.

W A C

THE
FAMOUS
"Speech
Range"
ASTATIC
D-104
CRYSTAL
MICROPHONE



LIST
PRICE
\$22.50

Yessir! Many Astatic D-104 Crystal Microphone equipped stations have WORKED ALL CONTINENTS. It is the favorite microphone of amateurs the world over.

SEE YOUR JOBBER

Preferred because of its excellent frequency response in the "speech range," high output, freedom from microphonics, resistance to atmospheric conditions and rugged construction. Now equipped with Phenolic connector instantly separable from stand fitting. Positive threaded locking ring.

Licensed under Brush Development Company Patents

ASTATIC MICROPHONE LABORATORY, Inc.

DEPT. Q, YOUNGSTOWN, OHIO, U. S. A.

W9WFFV

(Continued from page 48)

as a unit on a baseboard with controls on a plywood panel, consists of a 59 Tri-tet, 46 doubler, and a carbon-plate 10 in the final. It operates in the 7-, 14- and 28-Mc. bands, with four 80-meter crystals providing advantageous frequencies in these bands. Crystal-switching gives quick frequency change within a band, while shifting from one

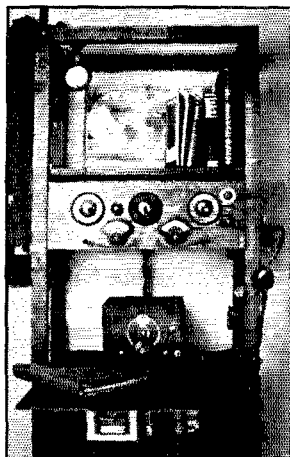

W9WFFV

band to another takes only about thirty seconds. The 10 is used as a straight amplifier on 7 and 14 Mc., and as a doubler on 28 Mc.

Two power supplies, breadboard mounted and fitting into the bottom of the rack, handle the transmitter requirements. One delivers 450 volts for the crystal oscillator and doubler, the second 800 volts for the final. Power input to the final on 7 and 14 Mc. is about 80 watts. The receiver "B" supply furnishes bias for the amplifier.

An SW-3, rebuilt to use the *Handbook* three-tube autodyne circuit, is used for receiving. A half-wave 7-Mc. antenna, single-wire fed, is the radiator on 7 and 14 Mc., with a vertical half-wave used separately for 28 Mc.

In the two and a half years the rig shown in the photographs has been in existence, some 4000 QSO's have been made. The station is both WAS and WAC. During nine months spent in various New Mexico locations, W4CA-5 provided a much-needed contact in this state for hundreds of WAS-seeking hams. Much of the recent operation has been carried on at Nederland, Colorado—at an elevation of 8400 feet—but a permanent location and the W9 call are now at Rifle, Colo.

"Mid" has been in the game since the early '20's, having started out in Indianapolis in the spark days with the w.k. Ford coil. First call was 9BJL, held until 1925 when the QRA was changed to Ohio, when 8CGI, 8AKA and 8UC came into existence; then in Florida with W4CA and finally in the West with W9WFFV. Chief Radio Man in USNCR and holding appointments as OBS and ORS, "Mid" is also a writer of fiction on radio subjects, some of his stories having appeared in *QST*.

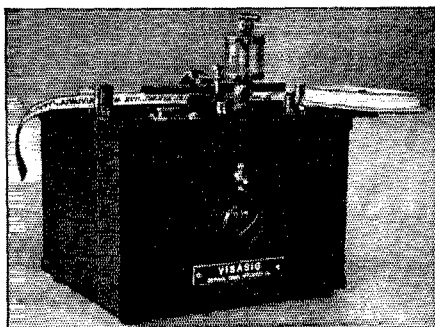

VISASIG Full Automatic Siphon Tape Recorder

for Amateur and Commercial use

Will record code signals from the air up to and in excess of 100 WPM. Use it to make a record of your own list or the fellow's you work. Make a permanent record from your receiver of weather reports, press news, speed contests, etc. See how it helps improve your fist!

VISASIG — V1 — With electrically driven tape puller complete in one unit as pictured above. . . . \$49.00

VISASIG — V1-B — Same as above but with constant level ink feed and 1500 ft. tape capacity. . . . \$59.00

PRICES F.O.B. NEW YORK CITY

Commercial Station Managers and Executives write for particulars of professional 200 WPM model

HAMS AND SWL! Write for complete information concerning our new audio oscillator in kit form. Every fellow interested in code speed needs one!

UNIVERSAL SIGNAL APPLIANCES

64 West 22nd Street

New York City

Visasig Blueprints \$1.00

TRANSATLANTIC CABLES

Tell the Facts About OIL!

Transatlantic cables don't fail. Neither do Sprague Impregnated, Oil Filled Transmitting Condensers and for much the same reason. . . .

In analyzing oils of many types, we were especially interested in the oil used to impregnate the giant ocean cables. Here there could be no failure. Here none but the very best oil would do.

As a result, we developed an identical oil

for our condensers. We demanded the best — and got it! Also, although most oils are non-inflammable, Sprague gives you the added protection of one having a flash point of 500° F. according to A. T. M. Standards.

This Sprague oil has no tricky name — no fancy prefixes. But it is the best oil for the purpose BAR NONE.

Use Sprague Condensers and note the difference!

SPRAGUE PRODUCTS COMPANY, North Adams, Mass.

Now you can get Sprague Rectangular Condensers at new low prices — the same prices you pay for the Round types!

Rect. Cat. No.	Round Cat. No.	Capacity	D. C. Working Voltage	Surge Voltage	Your Price
GR-27	OT-27	2 Mfd.	700v	1000v	\$1.50
GR-11	OT-11	1 Mfd.	1000v	1500v	1.50
GR-21	OT-21	2 Mfd.	1000v	1500v	2.00
GR-41	OT-41	4 Mfd.	1000v	1500v	2.91
GR-115	OT-115	1 Mfd.	1500v	2000v	1.71
GR-215	OT-215	2 Mfd.	1500v	2000v	2.34
GR-12	OT-12	1 Mfd.	2000v	3000v	2.13
GR-22	OT-22	2 Mfd.	2000v	3000v	2.85
GR-13	OT-13	1 Mfd.	3000v	3500v	5.10



SPRAGUE TRANSMITTING CONDENSERS

NEW RECTANGULAR AND ROUND TYPES AT NEW LOW PRICES

Read another
Then get your
copy and read
the whole
story. price!
postpaid
A.R.R.L.
W. Hart-
ford,
Conn

page from the Saga
of amateur
Radio

TWO HUNDRED METERS AND DOWN

below 200 meters was exhibited by amateurs even prior to the War. The
to be recalled the 30-meter amateur spark station in a 1910 list of stations in
Canada as a matter of fact, certain stations capable of causing interference to
government stations were restricted to 50 meters. For contact over the very
few miles then regarded as customary, the use of 30 or 50 meters would give
performance differing little from that at 400 meters; it occurred to no one that
long-distance work was possible. Until the advent of post-war vacuum tube
transmission, however, interest was either enforced or purely academic. It
was hard enough to get a spark transmitter going on the nominal wavelength
of 200 meters without trying to get down any lower.

Immediately after the war, however, when tubes of a sort became available
through devious methods a few bold souls really got down below 200 meters.
Technically the operation was often illegal, but as the local burgoning of
meters, and nobody bothered much about that. The actual burgoning of
the short-wave movement are a bit obscure, but the lack of much of
any success — as far below an 180' — was a tactical maneuver necessitated by
the QRN from NAF, cheeper and NAA are mostly in the winter of 1921-22.
on the part of a few stations — 3RP, 3AB1, 1TS and 1QP have been
mentioned — but this same lack of interference closed a lack of occupancy
that limited the amount of work that could be done. There is unadmitted
evidence that at least one amateur, Greg Borden of Washington, communi-
cated with another station on a wavelength approximating 60 meters and
found the signals stronger in the March, 1924, issue of QST, entitled
"In January, 1922, Lloyd Phelps made tests at night, in Minneapolis to deter-
mine the minimum wavelength to which a two-watt tube transmitter could be
tuned. Good antenna currents were obtained as far down as 35 meters and
of course, there was no one listening on that wavelength. He con-
sulted the technical literature published in the days of the war, and
"50 Meters," in which amateurs generally were urged to transmit on
wavelengths in the March, 1924, issue of QST, entitled, "The
Shortly thereafter, in the spring of that year, the
A.R.R.L. headquarters staff in Hartford
was established between 35 and 40
meters with good signals all the
needed with QST, and
successful communication
was established."

Insignia

OF THE

Radio Amateur

► In the January, 1920 issue of *QST* there appeared an editorial requesting suggestions for the design of an A.R.R.L. emblem — a device whereby every amateur could know his brother amateur when they met, an insignia he could wear proudly wherever he went. There was need for such a device. The post-war boom of amateur radio brought thousands of new amateurs on the air, many of whom were neighbors but did not know each other. In the July, 1920 issue the design was announced — the familiar diamond that greets you everywhere in Ham Radio — adopted by the Board of Directors at its annual meeting. It met with universal acceptance and use. For years it has been the unchallenged emblem of amateur radio, found wherever amateurs gathered, a symbol of the traditional greatness of that which we call Amateur Spirit — treasured, revered, idealized.

Do You
Wear
the
A.R.R.L.
Pin
?

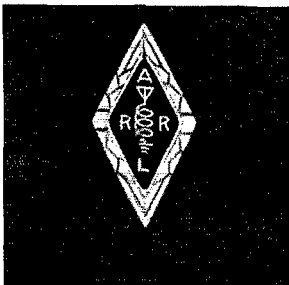

THE LEAGUE EMBLEM, with both gold border and lettering, and with black enamel background, is available in either pin (with safety clasp) or screw-back button type.

In addition, there are special colors for Communications Department appointees.

● Red enameled background for the SCM.

● Blue enameled background for the ORS or OPS.

(Red available in pin type only. Blue may be had in either pin or button style.)

THE EMBLEM CUT: A mounted printing electrotype, 5/8" high, for use by members on amateur printed matter, letterheads, cards, etc.

ALL EMBLEMS PRICED THE SAME

50 cents, postpaid

AMERICAN RADIO RELAY LEAGUE
West Hartford Connecticut

Navy Day Competition—1936

(Continued from page 44)

W3FXV - W3FZO - W3GHL - W3SB - W8CVS - W8CXE - W8EU - W8KSG - W8MKQ - W8MOT - W8NCJ - W8ORQ - W8QFM - C. D. Stein W3AGK - W3APX - W3EWJ - W3FSF - W3GLQ - W3ID - W3AOE - W8CVS - W8KBN - David W. Lee, Jr. W3GFS W8BYI W3FPR W3AEJ - W3ECI - W3EYT W3BGD - W3QM W3GES. *Fifth Naval District:* E3AHZ - W3AYS - W3CFL - W3EBZ - W3FJ - W3FSP - W3GFV - W3MQ - W4BRK - W4BWA - W8MCL - W9SEC - Edward N. Dingley, Jr. W3AVW - W3CAB - W3CIZ - W4BMR W4DOS W3FHT W8NCD - W8PMA W3EIL W8PQQ. *Sixth Naval District:* W4AGI. *Seventh Naval District:* W4DYZ W4DDM - W4DRK - W4EFM - W4HC - Joseph Arlt W4CIF - W4CSH W4CMN - W4CY W4ES. *Eighth Naval District:* W4BAQ - W4BGO - W4DGC - W4MS - W5AFH - W5AZB - W5BID - W5BNF - W5CEZ - W5DAQ - W5DXQ - W5FBQ - W5DLR / 4 - William A. Green W4BIW - W4BUC - W5ADC - W5AOZ - W5ASQ - W5BAM - W5CAV - W5ELG - W5FFK - W5FVD - W5SU W5AMO - W5CVO - W5DDJ - Louis Skipper, Jr. W4BAOW - 5BLJ - W5FCZ - W5FLU W5EGC - W5ENW - W5KC W4DXQ W4EKO. *Ninth Naval District:* W5FWV - W7EMA - W8HSW - W8KPL - W8NVP - W8NXN - W8OIH - W8QIS - W9AHH - W9BKR - W9BNL - W9CB - W9CDM - W9CFP - W9CGV - W9DGS - W9EGS - W9ERU - W9FDC - W9FI - W9FQ - W9HF - W9JSL - W9KCR - W9LJV - W9NUF - W9PSN - W9PTV - W9RPM - W9SDL - W9SJB - W9SKR - W9TH - W9TYF - W9YAI - W9VES - W9VY - W9YGF - W9YLA - Edw. J. Roth, Jr. - James B. Rowe - J. Russell Thorburn - James R. Walker - W. E. Wecker - F. C. Winston W8IFQ - W8LZJ - W8LZK - W9AIR - W9CEX - W9CFB - W9CYD - W9EFK - W9FZH - W9LWV - W9MTW - W9OGZ - W9PFI - W9PPN - W9RZU - W9SG - W9SO - W9TE - W9UZG - Harry Brice W8HMH - W8KEV - W8NXT - W9CKR - W9GFG - W9IMV - W9LDJ - W9LLD - W9PTW - W9TCN - Michael DePoski W9CBN - W9GSD - W9KQA - W9KU1 - W9YNW - George W. Boniger W9BAZ - W9FHU - W9NLZ - W9TDDH W9CEU - W8OCN - W9CNG - W9OPP - W9VEV - Eugene Mahoney W8KWE - W9WLM John Derrick W8OPT W8DIO - W9PAN Carl D. Short W2ICH W9HEZ W9VWY W9KCK W9GEN. *Eleventh Naval District:* W6BVE - W6LDJ - Andrew Kirinich W6DBF - W. D. Hudgins W6CSO - W6DFE - W6GTM - W6MEX - W6MLJ - W6NXT - W6OF - W6IDW - W6LYF - W6MTS - W6MPN - W6HIE. *Twelfth Naval District:* W6ATT - W6FYW - W6IYL - W6MGL - W6JFD - W9PIH - W9REU - L. D. Mealer - Carroll Short, Jr. W6DXA - W6FKL - W6FSD - W6NLQ - W6OGJ - W9AUI - W9VCN - W9VTX - Jack G. Hollenbeck W6MAG - W9GLI - C. Brown W6MDP W9TRR W6CWR W6LNG W6MFM W9SJT W6LLH. *Thirteenth Naval District:* W6EMY - W6FIP - W7AND - W7BIZ - W7BRC - W7CAP - W7CFJ - W7DJJ - W7DXF - W7EBQ - W7EBB - W7FLD - W7FNG - W7TK Luther L. L. Dilley W7BIR - W7ME W7CNC - W7DWQ - W7ESJ W7GAS Joe Dunato W7DLH. *Fourteenth Naval District:* K6CCO K6NYH. *Miscellaneous:* VE3AHD - W6LGZ - Paul Russnak, Jr. Cyril F. L. Volney (VP2SL).

How Would You Do It?

(Continued from page 37)

1. Solutions must be mailed to reach West Hartford before the 20th of the publication month of the issue in which the problem has appeared. (For instance, solutions of problem given in the March issue must arrive at *QST* before March 20th.) They must be addressed to the Problem Contest Editor, *QST*, West Hartford, Conn.

2. Manuscripts must not be longer than 1000 words, written in ink or typewritten, with double spacing, on one side of the sheet. Diagrams and sketches may be in pencil, but must be neat and legible.

3. All solutions submitted become the property of *QST*, available for publication in the magazine.

4. The editors of *QST* will serve as judges. Their decision will be final.

Prizes of \$5 worth of A.R.R.L. station supplies or publications will be given to the author of the

FOR BETTER MESSAGE SERVICE

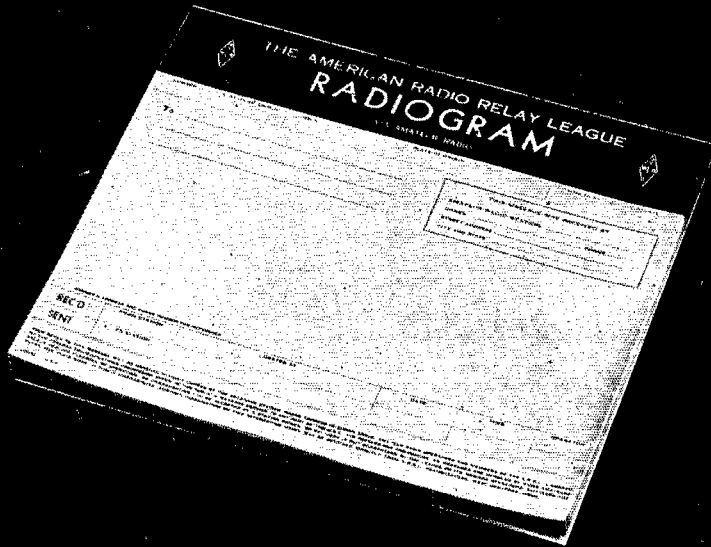

Now—25¢ per pad of 100 blanks

American Radio Relay League, West Hartford, Connecticut



**NEW
HOLDER
DESIGN
15 SECONDS
TO INSTALL
CRYSTAL**

**For All Bands
GREATER
STABILITY
Plugs in 5 prong
tube socket
Beautiful
Appearance**

MODEL AH HOLDER \$1.00

At your dealer or direct

HIPOWER LOW DRIFT CRYSTALS:
within 10 kc. or choice of stock

AH-10, 1700-3500 Kc. bands \$2.35

AH-10, 7000-7300 " band 3.90

write for new Literature

Hipower "Low Drift" Broadcast and Commercial
Crystals Are Approved by F.C.C.

Hipower Crystal Co., 2035 Charleston St., Chicago

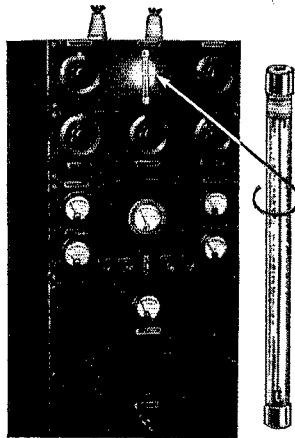

**MORE D. X. from
your present Xmitter
SUNCO
NEON TUNING
WAND**

Gives you the most watts
output from your rig. Indi-
cates current in radio fre-
quency circuits without any
direct connection to the cir-
cuit. Install as illustrated
for all transmitters from 1
to 1,000 watts.

Consumes practi-
cally no power.
Will not burn
out. Used for an-
tenna meter,
resonance, neu-
tralizing, tracing
R.F. in power supply and
modulation meter.

You'll be pleased with the
way it increases your trans-
mitter efficiency.

Yours sent postpaid \$1.50
SEND NOW. Each

**Sundt Engineering
Company**

(Affiliate of Littelfuse
Laboratories)

4246 Lincoln Avenue
Chicago Illinois

Clear glass tube 8" x 1/8" dia. Filled
with highly purified neon. Red glow
creeps up 6" electrode and indicates
strength of current. Very sensitive to
R.F.

R A D I O

ENGINEERING, broadcasting, aviation and
radio telegraphy and telephony, Morse telegraphy and railway
accounting taught thoroughly. Engineering course of nine
months duration equivalent to three years of college radio
work. School established 1874. All expenses low. Catalog free.
DODGE'S INSTITUTE, Day Street, Valparaiso, Indiana

T. R. McELROY

WORLD'S CHAMPION RADIO TELEGRAPHER

23 Bayside Street, Boston, Mass.

MAC KEY @ \$7.95 a real speed key.

MAC KEY DELUXE @ \$15.00.

MAC CORD @ \$1.00 speed key cord.

MAC CASE @ \$3.95 speed key case.

MAC OSC @ \$3.95 ac/dc oscillator. Tone control.

If u hv Mac Key wrt me fo xmy pt & durb lfn.

All my stuff emcy gad best pduts obl. 73 Mac.

BRUSH Headphones

● Meet every headphone requirement. They bring in weak signals strong and clear and will handle excessive volume without overloading. Response 60 to 10,000 cycles. No magnets to cause diaphragm chatter. Specially designed cases minimize breakage. Light in weight. Only 6 oz., complete with headband and cords. A quality product at a low price. Details, Data Sheet No. 10. Copies on request. Send for one.

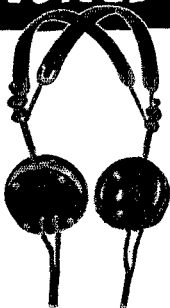

The BRUSH DEVELOPMENT COMPANY
 1113 EAST 40 ST. CLEVELAND, O.
 MICROPHONES • MIKE STANDS • TWEETERS • HEAD PHONES • LOUD SPEAKERS

Mims SIGNAL SQUIRTERS ROTARY BEAM ANTENNAS 20 and 10 METERS ONLY

Full descriptive information and details of our kits making it easy for you to "PUT YOUR SIGNAL WHERE YOU WANT IT—WHEN YOU WANT IT THERE." Send 5c for your copy.

Mims Radio Co.

(M. P. Mims, W5BDB)

P. O. Box 504 Texarkana, Ark.

Epcor STORAGE BATTERY ELIMINATOR



Supplies filtered D.C. suitable for operating auto radios, public address systems. Voltage adjustable from 4 1/2 to 9 volts at 10 amps. Write for detailed information.

As Illustrated \$19.75 Model B
 Variable Voltage \$15.75 6 volts—5 amps. Fixed Voltage



Supplies rectified D.C. for operating relays, solenoids and remote controls. Voltage ranges from 6 to 24 volts, rated at 2 to 15 amps. Operates on 110 volt A.C.

ADAPTOPAK

Operates A.C. radios in D.C. districts and 110 volt A.C. radios in autos and trailers.

ELECTRICAL PRODUCTS CO. 6539 RUSSELL ST. DETROIT, MICH.

GULF RADIO SCHOOL

Radiotelegraphy Radiotelephony
 Radio Servicing

SECOND PORT } 1007 Carondelet Street
 U. S. A. } NEW ORLEANS, LA.

solution considered best each month, \$2.50 worth of supplies to the author of the solution adjudged second best. The winners have the privilege, of course, of stating the supplies preferred.

—R. A. H.

Taking the Harmonic Headache Out of 75-Meter 'Phone

(Continued from page #1)

But one day, after spending more time on this 40-meter radiation than would be required to win a DX contest, I finally found the answer. I happened to be talking to W. R. Foley, W3MQ, one of the local R.L.'s here. He suggested that I try a static shield between the final plate coil and my antenna system. After much discussion we both decided that the 8-Mc. harmonics were being radiated because of the capacity coupling of the antenna system to the final plate circuit, and that the small amount of harmonic power was getting out in this manner. I went home and put my set on 75, just as it had been before I became harmonic conscious, and tuned it up. Then I took the plate coil out and hay-wired a piece of copper screen around the center of the plate coil with about a 1/4-inch spacing and put a ground on it. Then the same number of turns that were in between the two coupler clips on the tank coil before were wound right over this screen. In this case the clips were four turns each side of center, so eight turns were put on. The coil was put back in and tuned to resonance. Then the pi-network was connected to the new pickup coil and tuned up just as before. I had the HRO in the shack tuned to the 2nd harmonic signal, antenna disconnected and the two r.f. stages out of the circuit, taking readings on the S-meter. The S-meter had been almost off scale with every other set-up tried; but when the button was pushed on the 40-meter signal after the screen was put in, the reading was less than S1! I could hardly wait to get some other check. Since then I have had reports from the five local points that had been checking me and all reported no signal at all. At W3BEK a little over a mile away the harmonic had been S8 to 9; but with the shield in there was absolutely no harmonic signal at all with the gain control wide open. When the rig was keyed, Turner at W3BEK could just receive the 40-meter c.w. signal with the beat oscillator on. So now W3EMM has no harmonics at all; and am I relieved! Any day I was looking for a ticket from the F.C.C. but now everything is O.K. And if I did get one it would be because the radio bugs had chewed the static screen up.

With this set-up there is no noticeable loss of power. The antenna current is exactly the same as before. The only difference is a slight change in adjustment of the plate condenser and antenna turning condensers as the result of the small difference in capacity in the circuit. There is possibly some loss due to circulating current in the screen shield (it gets just a little warm), but it ap-

WHY GAMBLE?

You get satisfaction on all your transactions when dealing with Gross Radio — Prompt shipments are assured because we actually have one of the largest amateur and commercial radio stocks on hand at all times.

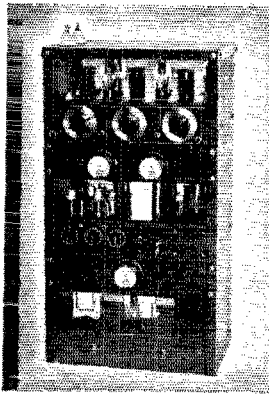

NEW! CB-50 FB. FOR 30 MC. RADIOPHONE TRANSMITTER

Input — 80 watts. Uses — 6L6 tubes in R.F. and Modulator. Coils available for 30, 14, 7, 3.5, and 1.7 mc.

Descriptive Bulletin on request

NEW!!

CW-50—Uses 6L6 Tubes
FB. for 30 MC.
Output — 50 watts
42 osc., 6L6 Buffer
2-6L6 amp.

Coils can be supplied for 30, 14, 7, 3.5, and 1.7 MC Bands. Complete Kit, with one set Coils, less tubes and crystal. **\$17.95**

Descriptive Bulletins on request

New CB-80 Radiophone and C.W. Crystal Controlled Transmitter

OUTPUT 100 WATTS
goes down to 10 meters

*Special Low Price
Literature on request*

GROSS TRANSMITTER KITS

CW-25 Output 25-30 watts (Crystal Controlled). Complete kit less tubes and crystal. **\$14.95**
P-25 power supply kit for above — 450 volts at 200 MA **\$11.00**

CW-60

(Uses New Eimac 35T)

Output — 100 watts. Crystal Control Transmitter

Coils can be supplied for 30, 14, 7, 3, 5, and 1.7 Bands. Complete Kit, with one set Coils, less tubes and crystal. **\$20.95**

Descriptive Bulletins on request

RECEIVER HEADQUARTERS!

We Are Authorized Distributors

RME 69 complete.....	\$151.20
RME DB-20 R.F. amp-selector	42.60
Hallcrafters Sky Buddy complete	29.50
Hallcrafters Sky Challenger . . .	69.50
Hallcrafters Ultra Sky rider S-10	99.50
Hallcrafters Super Sky rider S-11	89.50
Hallcrafters Sky Chief.....	44.50
Hammarlund Super Pro.....	255.70
RCA ACR-155.....	74.50

Come in for demonstration. Liberal allowances on your old set. Time payments arranged

MODULATORS

30 Watt (Beam Power)
4 Stages — **\$31.50**

60 Watt (Beam Power)
4 Stages — **\$42.50**

*See December Issue Page 69
for Complete Information*

PREMIER CRYSTALS

Gross Radio, realizing the needs of the ham for a real crystal, brought pressure to bear on Premier Laboratories, caterers to Government, Laboratory, Broadcast, and other commercial users of fine exact crystals.

Premier crystals now available at prices you pay for ordinary crystals.

Formerly these crystals could only be bought by the lucky few able to pay the regular price 2 to 2½ times our price.

When you buy Premier crystals, you are getting one of the finest xtals money will buy, real power oscillators, full size approx. 1" x 1" (not small chips, etc.), expertly finished and guaranteed accurate calibrations.

Mounted in new No. 400 Holder of new PL-39 with *hand-lapped* plates. Available exclusively from Gross Radio in New York. Supplied for the 40-80 meter bands at a new low price.



**Within 5 KC of specified KC
\$4.35**

NEW! "THE STANDBY" (2 TO 2000 METERS) 3-TUBE A.C. AND D.C. RECEIVER

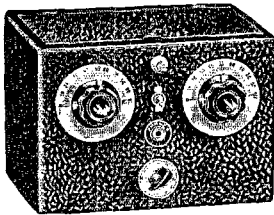

This excellent 2 to 2000 meter receiver is offered with full realization of the present-day need of the amateur for a dependable "standby" receiver which will cover practically all of the radio bands in use today, Super regeneration, which is the most efficient form of detection at these frequencies, is used from 2 to 15 meters. The R.F. stage is effectively used over the entire tuning range. Throughout the entire tuning range, there are no skips or dead spots. Loud speaker volume is available from practically every station received.

- 1000 to 1 tuning ratio ● Super regeneration below 15 meters
- Automatic change over from straight to super regeneration
- Power supply incorporated
- Individual antenna tuning for high and low wave ranges
- 1-6J5C detector, 1-6J7 R.F. stage, 1-12A7 audio amp and rectifier.

Complete kit of parts, less coils, tubes, cab. . . . \$7.59
2-5-10-meter coils (set of 3)95
9½ to 15 meter coil39
15-200 meter coils (set of 4)95
200-310 meter coil39
310-550 meter coil39
550-1050 meter coil60
1000-2000 meter coil60
Metal cabinet. 1.50
Kit of three tubes 2.40
Wired and tested in our lab., add. 2.00

WRITE IN FOR FREE NEW CATALOG ON HAM AND P.A. EQUIPMENT

20% DEPOSIT WITH ALL C. O. D. ORDERS

REMIT BY M. O. INCLUDE POSTAGE

Cable Address: GROSSINC

GROSS RADIO, INC., 51 VESEY STREET, NEW YORK CITY

ELECTRO-VOICE

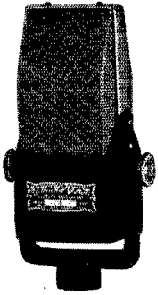

Velocity Microphones "V" Series

Used the World over for dependable high-fidelity Communication and Public Address. Many features such as: Zero cavity resonance, Hum-free operation, Excellent frequency response, Hammered ribbon, Locking cradle and Shock absorber. Three popular models priced from \$35 to \$75, list.

"K" Series

Genuine quality brought to the low price field. The response is wholly natural and life-like, reproducing with brilliance and depth. Sweeping modern lines give it fresh symmetrical beauty. Three models, \$19.50 to \$29.50, list. Also an electro-static model at \$20, list. (We particularly recommend this for Ham work.)

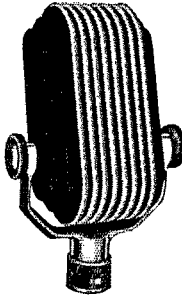

ELECTRO-VOICE MFG. CO., INC.

322 E. Colfax Avenue

South Bend, Indiana

Export Office: 100 Varick Street, New York, N. Y.

parently is only a few watts. The same arrangement was tried at W3CHE with identical results.

The electrostatic or Faraday screen is old stuff and has been used by broadcast stations and

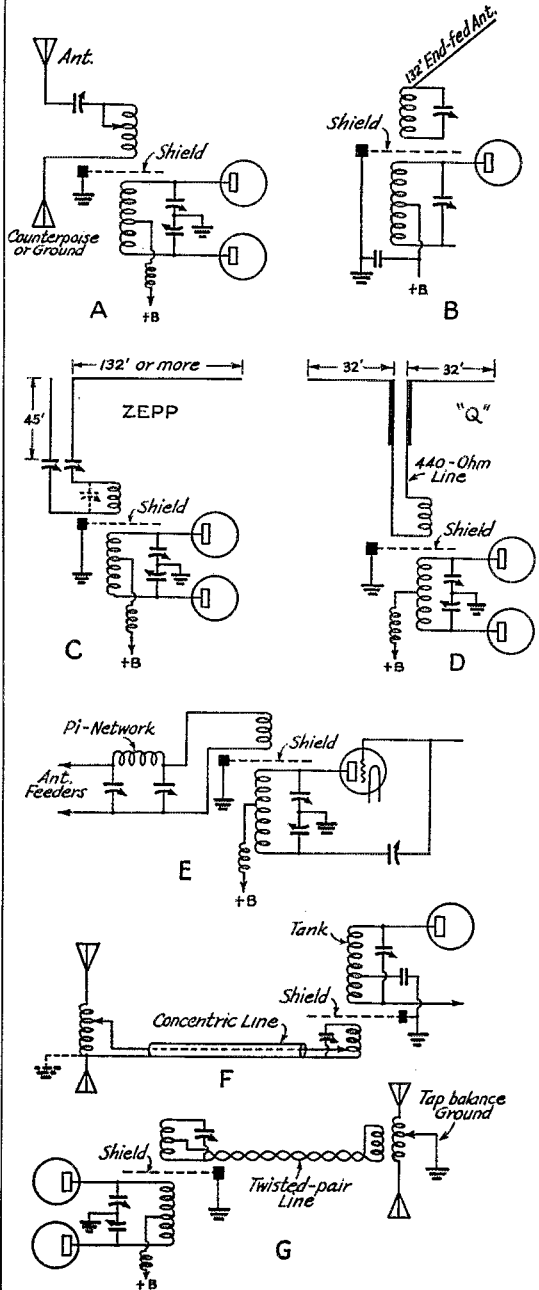

FIG. 3—ILLUSTRATING HOW STATIC SHIELDING IS ADAPTABLE TO A VARIETY OF POPULAR ANTENNA SYSTEMS

other services for years. The amateur has evidently overlooked this excellent method of preventing coupling, other than the desired mag-



News Flash!



"STREAM-LINE" POWER-HOUSE For Amateur Radio "A Lap Ahead O' the Field"

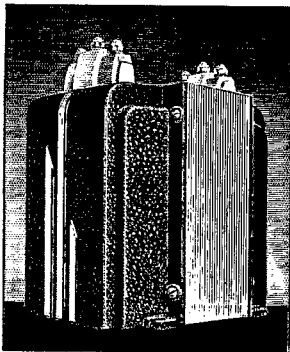

(Pat. applied for)

Transformers and chokes for every need—
Build U'r Rig "Stream-Line" the PROGRESSIVE Way
FREE for the asking—Bulletin forms 35 and 42—
tell all about it!

GENERAL TRANSFORMER CORP.
518 S. Throop St. Chicago, Ill.

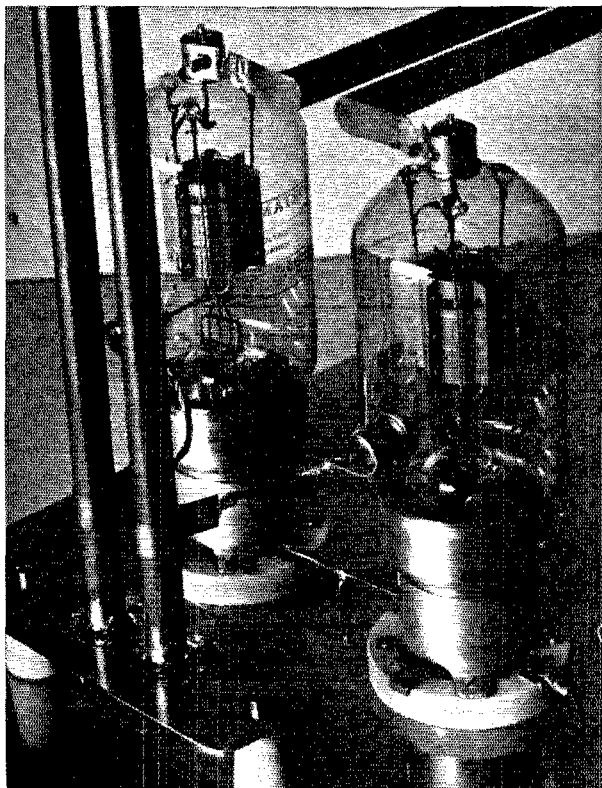

Heintz and Kaufman, Ltd.
ANNOUNCE!
THE 354-C GAMMATRON

Improved ULTRA-HIGH Frequency Operation. Same electrical characteristics as the "354" GAMMATRON — PLUS:

- Increased filament to grid insulation.
- Input capacity reduced to one-half.
- Extremely short grid lead.
- New grid and plate cap that can't come loose.

Same GAMMATRON FEATURES of superiority. Same price. . \$24.50

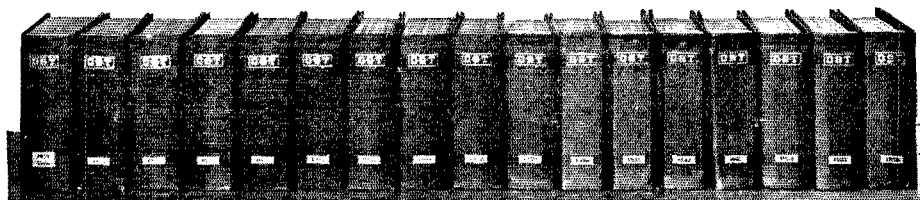

**WE CAN HELP YOU TO KEEP YOUR
 QST'S IN ORDER**

THE value of your QST file for reference purposes will depend entirely upon how readily you can find the issue which you want, and the appearance of the station will depend upon how you keep them. The binder fills both of these needs. Designed to hold twelve issues of QST and an index, it permits the copies to be placed in as they are received, or removed at will without mutilating the copies. It is a binder that you can be well proud of, and with each binder is furnished a set of labels, with the year marking, so that you can designate your yearly files. The binder is available only in the United States and its possessions, and the price is \$1.50, postpaid.

THE AMERICAN RADIO RELAY LEAGUE, West Hartford, Connecticut

LEADERSHIP

has to be

EARNED

NO other radio book has ever sold a tenth or a twentieth as many copies as the Radio Amateur's Handbook. Of course it's the biggest book on radio in the world. And of course it's painstakingly complete in every detail. But the important thing is that it is accurate, honest, carefully written by experts who know what they are talking about. Anybody can write a book and call it a "Handbook," but it takes time and ability and costs money to produce the Radio Amateur's Handbook. As a matter of fact, it cost us fifty thousand dollars — but it's yours for

\$1 POSTPAID
\$1.25 OUTSIDE
CONTINENTAL
U. S. A.

*American
Radio Relay League*

West Hartford, Conn.



netic coupling between the final stage and the antenna circuit. This static shield is advantageous in many ways. It not only eliminates the second-harmonic radiation, but also attenuates all the unwanted harmonics and spurious signals, such as transients, clicks and any other signals that are of anything but the fundamental frequency. The only coupling between the amplifier and the antenna is the inductive coupling of the pick-up coil to the final plate coil. This shield can be applied to any type of antenna coupling whether it is twisted pair feeders, matching network, untuned line or antenna coil arrangement. In any type of feeder system where the feeders clip directly on the coil the only thing necessary is to wind another coil directly over the shield with approximately the same number of turns between the two clips as were between them on the tank coil itself. Of course the number of turns might vary slightly because there is practically no capacity coupling between the final and antenna, when the shield is used, where there was some existing before. If the conventional antenna coil or coils are used and the screen is put in between them and the final plate coil, it will probably be necessary to tighten the coupling some as the same thing happens; the capacity coupling is reduced and only inductive coupling remains. In some cases where link coupling is used with a one- or two-turn link around the final tank coil, it is only necessary to ground the link in the center to eliminate the unwanted capacity coupling and thereby reduce or cut out the harmonic radiation. When the link is only a couple of turns and can be connected to ground, the shield would be of little value and would probably not be needed, as harmonics and the like would have no plate circuit to antenna capacity coupling and, consequently, would not be radiated by the antenna system. If the ground point on the plate coil is where the coupling coil or link is, and that point is actually at ground potential (by-passed or connected direct to ground as is the case with parallel feed), then the capacity loading effect of the antenna on the harmonics is not as much as it is where the series plate choke is used. Consequently there is less possibility of this type of harmonic coupling and radiation by the antenna. It is my idea that in most cases this static shield or grounding the link coil would do a lot toward eliminating harmonic radiation. A more efficient screen could be constructed but for all practical purposes copper screen would be O.K. and can be used with very little losses. Of course in this type of shielding there should be no closed loop around the tank coil as the losses in the one turn coil would be much higher and the shield would get very hot.

With the mad scramble for frequencies and the situation already in a big mess, so to speak, it is possible that the F.C.C. might impose further restrictions on amateur radio in general if ham harmonics continue to create off-frequency interference. In any event this sort of thing does absolutely no good and puts amateur radio on the spot.

1937 EDITION

The radio amateur's handbook

THE STANDARD MANUAL OF AMATEUR
RADIO COMMUNICATION



PUBLISHED BY THE AMERICAN RADIO RELAY LEAGUE



How Old Is Your ? LICENSE MANUAL

You know that the F. C. C. makes frequent changes in amateur regulations? That many of these changes deal with the rules for getting new licenses and renewals? That when the regs are changed, the appropriate questions are changed in the license examination, and the answers have to be different?

►►►► To keep pace with these changes, The Radio Amateur's License Manual is frequently revised. It is now in its seventh edition. Moreover, each copy is, when necessary, accompanied by a change sheet summarizing any changes that have been made since it went to press. ► The License Manual is as invaluable to the practising amateur as it is to the aspirant — but only if it is the current edition. *Price 25c postpaid*

American Radio Relay League West Hartford, Connecticut

LEARN CODE RIGHT — the practical, easy way —

And Now — Airways Tapes! Tapes to teach you every type of sending are available through INSTRUCTOGRAPH.

When you can practice Radio or Morse with tapes for your own special need, it's easy to become a real operator. With an INSTRUCTOGRAPH you may practice at your convenience — at any speed. Comes in two models. Buy or rent, at low cost. Send postcard for complete details now to —

Instructograph Co., Dept. Q-3
912 Lakeside Place Chicago, Illinois

Representatives for Canada
Radio College of Canada
863 Bay St., Toronto



We Also Handle:

HALLICRAFTER SHORT WAVE RECEIVERS—MICROPHONES
—VIBROPLEXES—TAYLOR TUBES CASH OR TERMS

NOW! A compact Portable Transmitter and Non-Radiating Receiver for the popular Ultra-High Frequencies . . .

● AN IDEAL FIXED OR MOBILE STATION ●

"Type TR-6A6"

- Better Than Ever
- 7 Tubes — Jensen Dynamic Speaker
- New 6E6 Unity Coupled
- 10 Watt Carrier
- 100% Modulation
- Duplex Operation—PHONE ● ICW

F.O.B. FACTORY
Less Tubes

\$39.75

RADIO TRANSCIVER LABORATORIES

8627 — 115 Street, Richmond Hill, New York

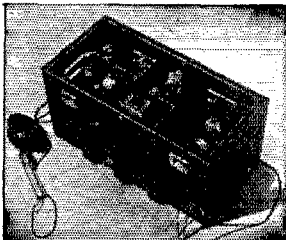

A.R.R.L. QSL Bureau

FOR the convenience of its members, the League maintains a QSL-card forwarding system which operates through volunteer "District QSL Managers" in each of the nine United States and five Canadian districts. In order to secure such foreign cards as may be received for you, send your district manager a standard No. 8 stamped envelope. If you have reason to expect a considerable number of cards, put on an extra stamp so that it has a total of six-cents postage. Your own name and address go in the customary place on the face, and your station call should be printed prominently in the upper left-hand corner.

W1—J. T. Steiger, W1BGY, 35 Call Street, Williamansett, Mass.

W2—H. W. Yahnel, W2SN, Lake Ave., Helmetta, N. J.

W3—R. E. Macomber, W3CZE, 418 10th St., N. W., Washington, D. C.

W4—B. W. Benning, W4CBY, 520 Whiteford Ave., Atlanta, Ga.

W5—E. H. Treadaway, W5DKR, 2749 Myrtle St., New Orleans, La.

W6—D. Cason Mast, W6KHV, 423 East E Street, Ontario, Calif.

W7—Frank E. Pratt, W7DXZ, 5023 So. Ferry St., Tacoma, Wash.

W8—F. W. Allen, W8GER, 324 Richmond Ave., Dayton, Ohio.

W9—George Dammann, W9JO, 319 Sherman Ave., Evanston, Ill.

VE1—J. E. Roue, VE1FB, 84 Spring Garden Rd., Halifax, N. S.

VE2—C. W. Skarstedt, VE2DR, 236 Elm Ave., Westmount, P. Q.

VE3—Bert Knowles, VE3QB, Lanark, Ont.

VE4—Dr. J. J. Dobry, VE4DR, Killam, Alberta.

VE5—E. H. Cooper, VE5EC, 2024 Carnarvon St., Victoria, B. C.

K4—F. McCown, K4RJ, Family Court 7, Santurce, Puerto Rico.

K5—John J. Carr, K5AV, 78th Pursuit Squadron, Albrook Field, Canal Zone.

K6—James F. Pa, K6LBH, 1416D Lunalilo St., Honolulu, T. H.

K7—Frank P. Barnes, K7DVF, Box 297, Wrangell, Alaska.

KA—George L. Rickard, KA1GR, P. O. Box 849, Manila, P. I.

More DX Per Dollar

(Continued from page 51)

filter on the last two stages are cut off completely. Then the fixed bias (well past cutoff) on the 250TH's has a second effect in that it prevents these tubes from discharging the filter condensers in the 2500-volt supply. The result is that the condensers remain charged and ready to go on the

See
it at
your
local
dealers

PRICE

\$1.25

A. R. R. L.
West
Hartford,
Connecticut

**THE AMERICAN RADIO RELAY LEAGUE
Amateur Radio
Map of the World**

Explanation

Amateur Stations

Complete World Map

QST

QST

QST

Say You Saw It in QST — It Identifies You and Helps QST

SENDING and RECEIVING with the same Antenna



Amateur demand for a *Low Priced* Midget Radio Frequency Relay for low powered transmitters has forced us to bring out a brand new instrument. It is described on the new page 6 of Bulletin 507B. Send for it.

WARD LEONARD RADIO SPECIALTIES

WARD LEONARD ELECTRIC COMPANY

41 South Street, Mount Vernon, N. Y.

Please send me page 6 of Bulletin 507B.

Name

Street

City and State

Call Signal

PRECISION CRYSTALS



Crystal Holder

Highest quality crystals one-inch square, carefully ground for frequency stability and maximum output. Be sure of your transmitter frequency—use PRECISION CRYSTALS.

'X' cut PRECISION Crystals carefully ground for maximum power supplied within 0.1% of your specified frequency and calibrated to within 0.03% are priced as follows: 1750, 3500 and 7000 kc. bands—

\$3.00 each. Add \$1.00 to above price if plugin, dustproof holder is desired. (Holder as illustrated to fit G.R. jacks or round holder to plug into a tube socket can be furnished.) G.R. jacks to plug illustrated holder into — \$1.5 pair.

Low frequency drift crystals (Type LTC) having a drift of less than 5 cycles per million per degree C. are supplied at the following prices: 1750 and 3500 kc. bands — \$3.50 each; 7000 kc. band — \$4.00 each. Holder \$1.00.

'AT' cut crystals for commercial use quoted on at your request. When ordering our product you are assured of the finest obtainable. Now in our seventh year of business.

PRECISION PIEZO SERVICE

427 Asia Street

Baton Rouge, La.

next dot or dash. This stops the heavy surge of current drawn at each "make" in ordinary primary keying when the filter must be charged. It is this surge that causes the apparent chirp in many primary keyed signals, and also is the chief reason for sticking relay contacts at the higher keying speeds. The resulting keying is well-nigh perfect at any speed, and is independent of the amount of filter required on the final stages.

The actual keying is done by two plunger type relays with 5/8-inch pure silver contacts. They are home-made and designed to work on 30 volts from a pair of Tungar rectifiers filtered by 100 μ f. of electrolytic condenser (50-volt rating). The two relays draw one ampere and are extremely snappy in action. This is essential because the chief requirement of a non-sticking, relay is fast, positively closing contacts with very high contact pressure. As a result, these relays sound like trip hammers going into action—but were quieted by being mounted in a heavy, felt-lined wooden box.

PERFORMANCE

Now a word about power performance with the high- μ tubes. The excitation usually run on both 7- and 14-Mc. final amplifiers is about 150 watts, corresponding to 100 ma. of grid current; this is considerably higher than that normally required for efficient operation at 2500 volts and 400 ma. but is necessary for the fix-tuned operation already described. With either amplifier tuned right on the nose, the above excitation can be reduced to 50 ma. (60 watts) without loss in output. On test, the 7-Mc. amplifier developed some 700 watts output (1 kw. in) driven directly by a 7-Mc. 6L6 crystal oscillator. The grid current was 25 ma. with about 20 watts excitation from the 6L6, a power gain of 35. At a plate voltage of 4000, the output reached 800 watts with the same 1-kw. input for a power gain of 40. Even the 28-Mc. doubler-final has a power gain of 5 at 3300 volts, and still higher at 4000 volts. While it is evident that some output is being sacrificed by running the finals at 2500-3300 volts instead of higher values, the loss is small because of the low plate impedance of the tubes used. Furthermore, the low plate voltages require the tighter load coupling necessary for broad tuning tanks as are used for fix-tuned operation.

It must be emphasized that this is only the beginning in the attack on flexibility. There are numberless variations possible in the ideas herein described. Padders can be added to any existing transmitter with almost no effort. Perhaps the best feature is that complication is only bothersome on the high-power end—low power means fewer stages to pad, less insulation required, possibility of using ordinary ganged coil switches for padder control, etc. Even the automatic driver described becomes a good two-band medium-power transmitter.

One thought stands out in concluding. Work with a transmitter of this type leaves one regarding the old stand-by rig as an awkward reminder of the horse-and-buggy era.



THAT PERSONAL TOUCH — by W9ANZ

"The Pioneer 14 Mc. Phone Amateur of the World"

HALLICRAFTERS

TAYLOR TUBES

Sky Buddy.....	\$29.50	866.....	\$1.65
Sky Chief.....	44.50	T55.....	8.00
Sky Challenger..	69.50	T155.....	19.50
Super Sky rider..	99.50	203A.....	12.50
Ultra Sky rider..	99.50	T200.....	21.50

LEUCK ELECTRIC SERVICE, LINCOLN, NEBR.

HINTS! &

New Edition

— and you know this book has an amazing amount of good information in it!

Chap.	Pages	Illust.
1	9	25
2	16	26
3	3	2
4	4	2
5	13	22
6	10	29
7	18	22
8	15	8
9	8	1
10	5	4
11	4	1
12	1	1
13	1	1
14	1	1
15	1	1
16	1	1
17	1	1
18	1	1
19	1	1
20	1	1
21	1	1
22	1	1
23	1	1
24	1	1
25	1	1
26	1	1
27	1	1
28	1	1
29	1	1
30	1	1
31	1	1
32	1	1
33	1	1
34	1	1
35	1	1
36	1	1
37	1	1
38	1	1
39	1	1
40	1	1
41	1	1
42	1	1
43	1	1
44	1	1
45	1	1
46	1	1
47	1	1
48	1	1
49	1	1
50	1	1

Price 50 cents
 120 pages
 illustrations
 236

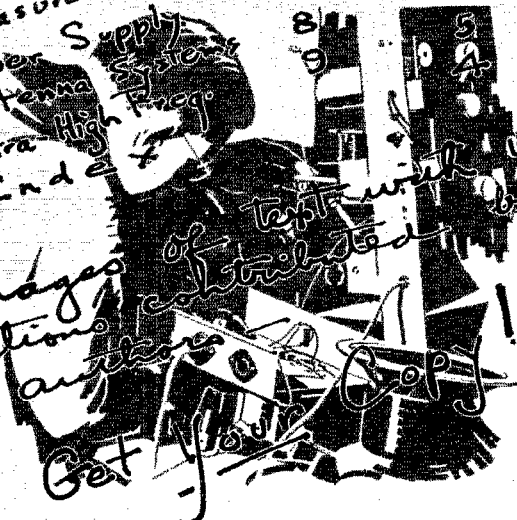

Published by the AMERICAN RADIO RELAY LEAGUE • West Hartford, Conn.

DO YOU WANT TO LEARN WIRELESS and TELEGRAPHY?



TWO BOOKS EVERY AMATEUR SHOULD HAVE —

Send Now!

25¢
COIN, MONEY ORDER
OR STAMPS
Each
POSTPAID

Hundreds of amateurs have learned from these books, so can you.

These books give you the fundamentals of wireless and telegraphy. They contain the codes and how to learn them. Mail your order now to:

SIGNAL ELECTRIC MFG. CO., Menominee, Michigan

ESTABLISHED
1892



AMATEURS EVERYWHERE Use VALPEY Crystals

The type VM2 mounted crystal employs a power type X cut crystal, precision ground to its finished frequency, supplied to within 5kc's. of your specified frequency in the 1.7, 3.5, 7Mc. bands — \$3.00. Exact frequency \$5.00.

The type VM2A mounted crystal employs a power type crystal, frequency drift less than 4 cycles/M/°C precision ground to its finished frequency, supplied to within 5kc's. of your specified frequency in the 1.7, 3.5, 7Mc. bands — \$4.50. Exact \$6.50.

Our products may be obtained from your dealer or by ordering direct

THE VALPEY CRYSTALS, 377 Summer St., Medway, Mass.

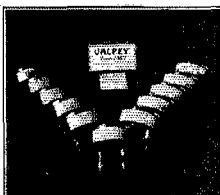

★ *Read About* ★

THE
New Hints & Kinks

(Vol. 2)

on Page 115



How Much C?

(Continued from page 28)

stage was 4.65 μ h. four times that value is 18.6 microhenrys.²

For those amateurs who would like to see equations worked out in the form of graphs, there are presented three graphs that help do away with any tedious calculations. For those who wish to calculate the Z value of their final stage tank circuits but who would like to be able to read the capacity value off a chart for any of the amateur frequency bands, Chart A, Fig. 1, will answer that question. Taking the ordinate as Z it is only necessary to locate the place where it intersects the proper band and then to follow the abscissae to the capacity required.

When we wish to determine what the maximum input can be for a given plate voltage for a single-tube circuit, Chart B, Fig. 2, may be used.³ This chart shows almost at a glance what voltage you should use for a given transmitter when the capacity of the tank condenser is to be 1, 2 or 4 μ fd. per meter,⁴ assuming the Q of the circuit to remain at 12. It should be noticed that for 1 kilowatt input, between 2000 and 4000 volts are required for the circuit Q of 12 to be attained when the μ fd. per meter capacities per section are between 1 and 4.

For a push-pull stage and a circuit Q of 12, the 1 kilowatt input maximum can be obtained with lower plate voltages, running from 1000 to 2000 volts, while the μ fd. per meter condenser capacity requirements per section are still between the values of 1 and 4. Chart C, Fig. 3, gives this information.

It is seen then that a push-pull final has a

² When a balanced tank circuit is used with a single-tube amplifier, a capacity value intermediate to those used for single-ended and push-pull amplifiers obtains. Note that in the push-pull analysis given above, the output power is the same as for the single tube in the previous example. A single tube working into a balanced tank is equivalent, in so far as tank circuit requirements are concerned, to a push-pull amplifier having twice the single-tube's output. Thus the formula

$$Z = \frac{E^2}{P}$$

for the single-ended stage becomes, for push-pull, $Z = \frac{(2E)^2}{P}$

and for a single tube working into a balanced tank circuit,

$Z = \frac{(2E)^2}{2P}$, which reduces to $\frac{2E^2}{P}$. Solving the equation for

C, it develops that for the single tube with a balanced tank circuit the total capacity should be half that for a single-ended tank, and the inductance correspondingly doubled. Each section of the split-stator condenser therefore has the same value as the total in the single-ended stage, since the total capacity is half that of one section. In Chart B, Fig. 2, the capacity values are accordingly given in μ fd. per condenser section, assuming that a single-section condenser will be used for the single-ended amplifier and a double-section condenser for the balanced amplifier.—EDROR.

³ This chart also applies to tubes in parallel. The important thing is the power input; it does not matter whether that input is obtained by using a large tube or several smaller ones paralleled.—EDROR.

⁴ E.g., at 7 Mc. (40 meters in round figures) 40 μ fd. at 1 μ fd. per meter, 80 μ fd. at 2 μ fd. per meter, 160 μ fd. at 4 μ fd. per meter. If, at the plate voltage and power input selected, the point does not fall on one of the lines, the " μ fd. per meter" value can readily be found by interpolation.—EDROR.

THE
80-T TRANSMITTER
 AN INSTANT SUCCESS

BECAUSE

- It covers all bands from 10-160 meters on phone and cw.
- It has all necessary controls and meters, yet is simple to operate.
- It is compact in size and well proportioned for restricted space.
- It is properly engineered of the best parts for many years of service.
- It is reasonably priced and may be purchased on easy payments.

Amateur net \$140 less accessories

Write for Information

HARVEY RADIO LABORATORIES, INC.
 12 Boylston Street, Brookline, Mass.

Export: 25 Warren Street, New York City. Cable: "Simonrice."

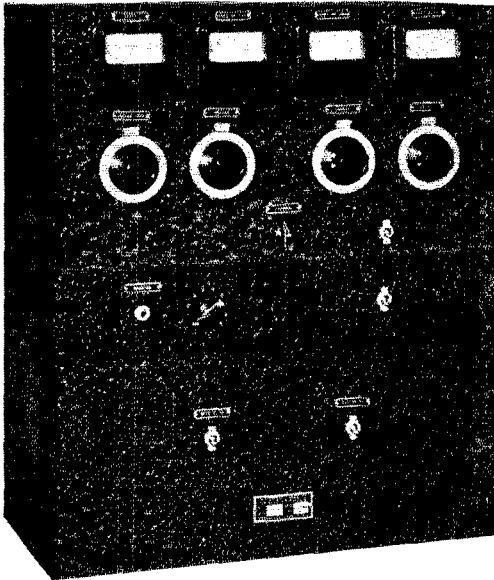

*How to
 Become*

**A RADIO
 AMATEUR**

Published by the AMERICAN RADIO RELAY
 LEAGUE, INC. • West Hartford, Connecticut



Price 25 Cents

« « « «

Price 25¢ postpaid
 (no stamps, please)

NOT to Make More Amateurs
 But to Make GOOD Amateurs

is the purpose of the League's beginner's booklet

**HOW TO BECOME
 A RADIO AMATEUR**

There is, inevitably, a constant flux of newcomers to the amateur game; it takes thousands of beginners each year to make up the annual 40% turn-over in our numbers. The policy of the F.C.C. and the League is to maintain, as nearly as possible, the status quo.

It is also the policy of the League to insure that these newcomers are competent, adequately-trained amateurs by supplying authentic instruction and trouble-proof beginner's designs. Such information is provided in the beginner's booklet.

Keep the beginner-QRM down — start your beginning amateur friends with HOW TO BECOME A RADIO AMATEUR.

AMERICAN RADIO RELAY LEAGUE
 WEST HARTFORD, CONNECTICUT



A Division of L. S. Brach Mfg. Corp.

BRACH DeLuxe ANTENNA

Type BD-400

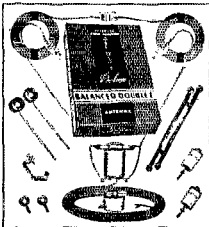

The remarkably improved performance, the greatly increased signal strength and the ultimate in noise reduction, has made this aerial outstanding in popularity.

Leading set manufacturers use and recommend this antenna with their deluxe radio sets.

Licensed under patents of Amy, Aceves & Kings.

Write Today for Our New Catalog

EQUIP YOUR ANTENNA WITH LYNCH GIANT KILLER CABLE
The Perfect Transmission Line or Down-Lead

World's Largest Makers of Antenna Systems

L. S. BRACH Mfg. Corp.

Newark, N. J. Est. 1906

WHY 100,000 OPERATORS

New **GENUINE MARTIN JUNIOR** *Weight 2 3/4 lbs.*

Prefer the **VIBROPLEX** SEMI AUTOMATIC KEY

ONLY \$12.50

Smaller and more compact. Large contact points. Black japanned base. A low priced key with world famous Vibroplex quality.

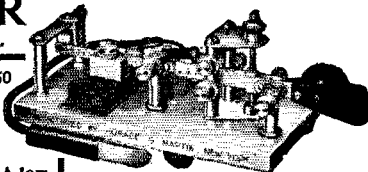

More than 100,000 experienced Radio and Morse operators prefer the Vibroplex key because its semi-automatic style produces a higher quality signal

... a more uniform style of sending proficiency seldom attained by users of the regulation telegraph key. So if you want the best, be sure to insist on the Genuine Martin Vibroplex key. Accept no substitute. Order yours TODAY! Money order or registered mail. Other models \$17 and \$19. Write for FREE illustrated Catalog.

FREE Catalog



THE VIBROPLEX CO., INC.

832 Broadway New York, N. Y.

RADIO ENGINEERING



RCA Institutes offer an intensive course of high standard embracing all phases of Radio. Practical training with modern equipment at New York and Chicago schools. Also specialized courses and Home Study Courses under "No obligation" plan.

Illustrated Catalog on request

RCA INSTITUTES, INC. Dept. ST-37

Varick St., New York 1154 Merchandise Mart, Chicago
Recognized Standard in Radio Instruction Since 1909

great advantage over a single-ended final in that the condenser capacity requirements are but one-fourth those for the single-ended stage. This factor is of considerable economic value when the price of tank condensers is taken into consideration even if we have high plate voltage available for the single-ended stage to keep down the capacity required. Even so, it is always advantageous to keep to the lowest possible plate voltage because of lower filter cost and lessened danger to the operator.

Standard Frequency Transmission

Date	Schedule	Station	Date	Schedule	Station
March 5	B	W6XAN	April 7	C	W9XAN
	B	W6XK	April 9	B	W9XAN
March 10	C	W9XAN			
March 12	B	W9XAN		A	W6XK
	A	W6XK	April 14	BB	W6XAN
March 17	BB	W9XAN	April 16	BB	W6XK
March 19	BB	W6XK			
	A	W9XAN		A	W9XAN
March 20	BX	W6XK	April 17	BX	W6XK
March 21	C	W6XK	April 18	C	W6XK
March 26	A	W6XK	April 23	A	W6XK
April 2	B	W9XAN	April 30	B	W9XAN
	B	W6XK		B	W6XK

STANDARD FREQUENCY SCHEDULES

Time (p.m.)	Sched. and Freq. (kc.)		Time (p.m.)	Sched. and Freq. (kc.)	
	A	B		BB	C
8:00	3500	7000	4:00	7000	14,000
8:08	3600	7100	4:08	7100	14,100
8:16	3700	7200	4:16	7200	14,200
8:24	3800	7300	4:24	7300	14,300
8:32	3900		4:32		14,400
8:40	4000				
Time (a.m.)	Sched. and Freq. (kc.)				
				BX	
6:00				7000	
6:08				7100	
6:16				7200	
6:24				7300	

The time specified in the schedules is local standard time at the transmitting station. W9XAN uses Central Standard Time, and W6XK, Pacific Standard Time.

TRANSMITTING PROCEDURE

The time allotted to each transmission is 8 minutes divided as follows:

2 minutes—QST QST QST de (station call letters).
3 minutes—Characteristic letter of station followed by call letters and statement of frequency. The characteristic letter of W9XAN is "O"; and that of W6XK is "M."

1 minute—Statement of frequency in kilocycles and announcement of next frequency.

2 minutes—Time allowed to change to next frequency. W9XAN: Elgin Observatory, Elgin National Watch Company, Elgin, Ill., Frank D. Urie in charge.

W6XK: Don Lee Broadcasting System, Los Angeles, Calif., Harold Perry in charge.

Schedules for WWV

EACH Tuesday, Wednesday and Friday (except legal holidays), the National Bureau of Standards station WWV will transmit on three frequencies as follow: noon to 1:00 p.m. E.S.T., 15,000 kc.; 1:15 to 2:15 p.m., 10,000 kc.; 2:30 to 3:30 p.m., 5000 kc. On each Tuesday and Friday the emissions are continuous unmodulated waves (c.w.); and on each Wednesday they are modulated by an audio frequency. The audio frequency is in general 1000 cycles per second.

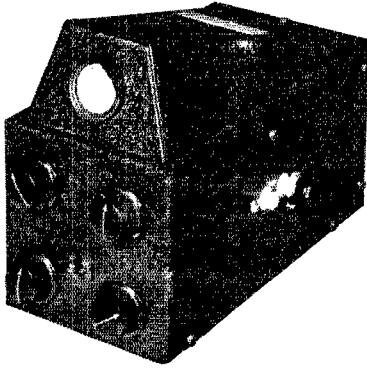

A MINIATURE OSCILLOSCOPE AT A NEW LOW PRICE

The new Type CRM Oscilloscope employs the little RCA-913 tube having a one-inch screen. In spite of its small size, this new equipment is thoroughly practical and is quite satisfactory for routine measurements in the amateur station.

The circuit is essentially the same as in the larger CRO, and includes a power supply with controls for brilliancy and focus, a potentiometer for controlling the amplitude of the horizontal deflection, and a built-in 60-cycle sweep. This latter is particularly convenient as it permits checking transmitter operation with no connection other than a pick-up coil.

Although the larger Type CRO Oscilloscope will remain the preferred equipment for the amateur station, the little CRM gives excellent results where size and cost are important considerations.

NET PRICE \$11.10

Without Tubes

SPECIFICATIONS

Tubes: RCA-913 with 1" screen and 6X5 rectifier.

Size: 4 1/8" x 6 1/8" x 8", not including knobs and binding posts.

Controls: Focus, brilliancy and sweep amplitude.

Sweep: 60 cycle sweep built-in, with provision for external sweep of any type.

Net Price: Type CRM, \$17.60 with tubes, \$11.10 without tubes.

At Right:

The Type CRO Oscilloscope with 3" screen. Net Price \$19.50, without tubes.

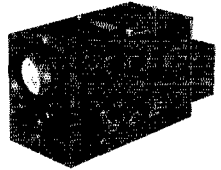

NATIONAL COMPANY, INC.

**LOW PRICED! EASY TO ERECT!
STEEL ANTENNA TOWER**

HAMS!—Here's the ideal antenna tower—can also be used as a vertical radiator. Strong! Light weight! Extremely rigid! Comes in 20 ft. sections, with 5 ft. tip, knocked down, for building towers 25, 45, 65, 85, or 105 ft. high, as you wish. Easy to erect. Easy to climb.

Tower Legs—1/2" x 1 3/4" x 1 3/4" x 20 ft. Low carbon rail steel angle. Galvanized after fabrication.

Cross Bars—1/2" x 3/4" x 1 3/4" mild steel, spot welded to form X brace. Baked black enamel.

Bolts—1/4" USS X 3/4"—1035 steel, cadmium plated. **Guy Wire**—300 ft. No. 9 galvanized with each 20 ft. section. Tower weighs 4 1/2 lbs. per foot when assembled.

50^c
50 ft.
i.e., b. Sioux City, Iowa

**Order Direct From
WINCHARGER CORPORATION
Dept. QST-3 Sioux City, Iowa**

Power X cut	O. C. L. Control Crystals	High Output
Unconditionally Guaranteed		
7000 KC ± 5 KC . . \$1.85 3500 or 1750 ± 5 KC \$1.50		
ATCUT—40-80-160 ± 5 KC 2.25		
OMAHA CRYSTAL LABORATORIES		
Jobbers write: W9JRY, NORTH PLATTE, NEBR. W9CPM		

SICKLES COILS
ALL TYPES OF RF AND IF WINDINGS

Manufactured by
F. W. SICKLES COMPANY
300 Main Street Springfield, Mass.

**RATTLE THE AUSSIE'S
FONES WITH THE MB50**

This modern, flexible, inexpensive crystal-controlled Transmitter Kit uses a 59 "Tritet" Oscillator, driving a pair of 802's to 50 watts output. No neutralization is required. Coils are available for operation on all bands from 160 to 10 meters.

The MB50 Kit uses the highest quality parts representing such names as National, Hammarlund, Sangamo, Yaxley and others equally well-known. The complete kit includes all component parts, a drilled, crackle-finished chassis and panel, metal-etched dials and one \$19.90 set of coils. Complete with instructions. **\$19.90**

**M. & H. Heavy Duty
Power Supply Kit**

This Power-supply Kit, consistent with our policy to use only the best of parts is made of Thordarson Transformers and Chokes, and oil-filled 1000-volt filter condensers. Voltages are available up to 600 volts at 200 milli dc. Filament voltages of 7.5; 6.3; and 2.5 are supplied. The use of an 83 or 523 rectifier is optional. The base is punched and crackled ready for assembly. This pack may be considered a companion unit to the MB50 transmitter. Complete with instructions for **\$10.75** assembly. Price.

Send for New 1937 Radio Catalog

M & H Sporting Goods Co.
512 MARKET ST. PHILADELPHIA
1709 Atlantic Ave. Atlantic City

Where to buy it

A directory of suppliers who carry in stock the products of these dependable manufacturers.



AKRON, OHIO 110 E. Market Street
Brighton Sporting Goods Corp.

AKRON, OHIO 110 E. Market Street
Brighton Sporting Goods Corp.

CHICAGO, ILL. 833 W. Jackson Blvd.
Allied Radio Corp.

BUTLER, MO. 211 N. Main St.
Henry Radio Shop

CHICAGO, ILLINOIS 19 S. Wells St.
Hinds & Edgarton

CHICAGO, ILL. 226 W. Madison Street
Newark Electric Company

CHICAGO, ILL. 901-911 W. Jackson Blvd.
Wholesale Radio Service Company, Inc.

CHICAGO, ILL. 833 W. Jackson Blvd.
Allied Radio Corporation

CINCINNATI, OHIO 633 Walnut St.
Steinberg's, Inc.

CHICAGO, ILL. 901-911 W. Jackson Blvd.
Wholesale Radio Service Company, Inc.

COLUMBUS, OHIO 61 E. Goodale St.
Bell Radio Parts Co.

CHICAGO, ILLINOIS 25 North Franklin Street
Electric & Radio Supply Co., Inc.

DETROIT, MICHIGAN 5027 Hamilton Ave.
Rissi Brothers, Inc.

CINCINNATI, OHIO 633 Walnut Street
Steinberg's, Inc.

DETROIT, MICH. 171 E. Jefferson Ave.
Radio Specialties Co.

CLEVELAND, OHIO 2073 West 85 Street
Northern Ohio Laboratories

DULUTH, MINN. 109 E. 1st St.
Northwest Radio

CLEVELAND, OHIO 610 Huron Road
Goldhamer, Inc.

INDIANAPOLIS, IND. 34 W. Ohio St.
Van Sickle Radio, Inc.

COLUMBUS, OHIO 178 N. 3rd Street
Hughes-Peters Electric Corp.

KANSAS CITY, MO. 1012 McGee Street
Burststein-Applebee Company

DAYTON, OHIO 140 E. 3rd Street
Burns Radio Company

OMAHA, NEBRASKA 2855 Farnam St.
Radio Accessories Company

DETROIT, MICH. 171 E. Jefferson Ave.
Radio Specialties Co.

ST. LOUIS, MO. 927 Pine Street
Gordon Radio Company

FLINT, MICH. 203 W. Kearsley St.
Shand Radio Specialties

KANSAS CITY, MO. 1012 McGee St.
Burststein-Applebee Company

Where to buy it

A directory of suppliers who carry in stock the products of these dependable manufacturers.

MINNEAPOLIS, MINN. 1124-6 Harmon Pl.
Lew Bonn Co.

CHICAGO, ILLINOIS 226 W. Madison Street
Newark Electric Company

CINCINNATI, OHIO 633 Walnut Street
Steinberg's, Inc.

CLEVELAND, OHIO 2073 West 85th Street
Northern Ohio Laboratories

RME
RECEIVERS -- PRE SELECTORS
AMATEUR RADIO EQUIPMENT
RADIO MFG. ENGINEERS, Inc.
PEORIA, ILLINOIS

TRIPLET
INSTRUMENTS

BUTLER, MISSOURI 211-215 N. Main Street
Henry Radio Shop

CANTON, OHIO 620 Tuscarawas Street, W.
Radio Electric Supply Company

CHICAGO, ILLINOIS 19 South Wells Street
Hinds & Edgerton

CHICAGO, ILLINOIS 226 West Madison Street
Newark Electric Company

CINCINNATI, OHIO North Bend Road, Mt. Airy
Jos. N. Davies

INDIANAPOLIS, INDIANA 34 West Ohio Street
Van Sickle Radio Shop

MINNEAPOLIS, MINNESOTA 1124-26 Harmon Place
Lew Bonn Company

AKRON, OHIO 110 E. Market Street
Brighton Sporting Goods Corp.

ANN ARBOR, MICH. 331 S. Main St.
Purchase-Radio

CHICAGO, ILL. 833 W. Jackson Blvd.
Allied Radio Corporation

CHICAGO, ILL. 226 W. Madison Street
Newark Electric Company

CHICAGO, ILL. 901-911 W. Jackson Blvd.
Wholesale Radio Service Company, Inc.

CHICAGO, ILLINOIS 25 North Franklin Street
Electric & Radio Supply Co., Inc.

CINCINNATI, OHIO 633 Walnut Street
Steinberg's, Inc.

CLEVELAND, OHIO 610 Huron Road
Goldhamer, Inc.

INDIANAPOLIS, IND. 34 W. Ohio St.
Van Sickle Radio, Inc.

RAYTHEON
AMATEUR TUBES

AKRON, OHIO 110 E. Market Street
Brighton Sporting Goods Corp.

MINNEAPOLIS, MINN. 1124-6 Harmon Pl.
Lew Bonn Co.

READ AND
SEND

CODE

Learn Easily at Home this Quicker Way:

No experience needed. Beginners read code quickly, copy accurately. If already an op, speed up your wpm this approved way. "Almost human!" experts call the amazing New All Electric Master Teleplex. Only instrument ever produced which records your sending in visible dots and dashes on specially prepared paper tape—then sends back your own key work at any speed you wish.

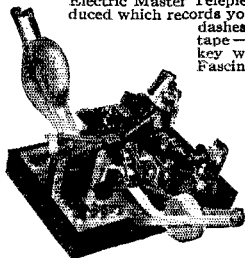

Fascinating, fool-proof, gets results because you learn by HEARING as well as seeing. That is why thousands agree this method is surest and quickest. We furnish Complete Course, lend you the New Master Teleplex, and give you personal instruction with a MONEY-BACK GUARANTEE. Low cost, easy terms. Write today for folder Q3; no obligation.

The "Ham" Standard Teleplex—a highly efficient code teacher using heavy specially prepared waxed paper tape, having two rows of perforations. Write for Free folder QT-3.

We are the originators of this type instrument

TELEPLEX CO. 72-76 CORTLANDT ST.
NEW YORK, N. Y.

WE HAVE a limited number of openings in our aviation research laboratories for young men who can meet the following requirements:

- Intensely interested in radio theory and possessing a fundamental knowledge of radio.
- High school education or better.
- Prefer licensed operators—amateur grade or higher.
- Interested in learning to fly and in working around and on airplanes.
- Willing to work hard for advancement.
- Capable of using hand tools and a knowledge of working with small machine tools.
- Must be good at mechanical drawing or drafting.
- Prefer men under 20, unmarried, and who are willing to accept a nominal salary and special training in this new art of aircraft radio to fit them for big opportunities in aviation.

State all your qualifications in your first letter and give at least three references—one from your school and one from your former employer.

Address Box L, Advertising Dept., QST
West Hartford, Connecticut

DX IS BETTER WITH TRIMM HEADSETS

Many amateurs have found the difference between mediocre and good DX lay in their choice of the Trimm Featherweight Headsets.

Now, a headset adapter of equal high quality, simple to connect to practically all modern radio sets.

TRIMM RADIO MFG. CO.

Write for catalogue 6437
describing headset adapter

1770 W. BERTEAU AVE., CHICAGO, ILL.

RADIO COURSES

RADIO OPERATING: Prepare for Gov't License Exam. ●
RADIO SERVICING: Including Short Wave ● AMATEUR
CODE ● ELECTRONICS ● TELEVISION ●

Day and Evening classes—Booklet upon Request

NEW YORK YMCA SCHOOLS

4 West 63rd Street, New York City

A 56-Mc. Crystal-Controlled Transmitter With 6L6 Output

(Continued from page 41)

the antenna connected, the plate current is 80 ma. The crystal and exciter stage are run at 300 volts and furnish ample excitation. The normal plate current reading of the 6A6 tube is 60 ma. and that of the 6L6 doubler about 40 ma.

It will be noted that two meters are provided to adjust the transmitter. The 100-ma. meter may be plugged in to read the plate current of any one of the three tubes, while the second meter of 25-ma. range, is permanently connected in the grid circuit of the final amplifier. The 6L6, like most pentodes, is rather critical as to its excitation requirements. If it is driven too hard, the output falls off, and too little excitation will cause downward modulation. A happy compromise in this transmitter seems to come at a d.c. grid current of 4 or 5 ma.

Anyone who has had some experience in the construction and operation of multi-stage transmitters should have no trouble in putting this little job on the air. As the photograph shows, Isolantite insulation is used throughout and it is important that the various by-pass condensers be so arranged that the lead to the point of the circuit by-passed will be short. All the ground connections in each stage go to a single point on the chassis.

About 15 watts of audio power are required to modulate this transmitter fully, and the output impedance of the modulator should be 5000 ohms in order to match the final amplifier. In this particular case, the transmitter was constructed so as to be operated remote control with the modulator located at the operation desk, thus permitting duplex operating with other 56-Mc. stations who are not too close to our own frequency.

Silent Keys

It is with deep regret that we record the passing of these amateurs:

Vasco Abreu, PY1AW, Rio de Janeiro, Brazil

G. E. Crabbe, VE2MG, Bourlamaque, P. Q.

Charles Dubelle, W1KHD, Allston, Mass.
Edward Gobrecht, W8ANV, Mount Vernon, Ohio

E. Earl Harden, W9FMX, Nickerson, Kansas

Roy M. Kenogae, W6JZD, Santa Ana, Calif.

John A. Lyons, W2ALY, New York City
William E. Nichols, W2UV, White Plains, N. Y.

HAM-ADS

(1) Advertising shall pertain to radio and shall be of nature of interest to radio amateurs or experimenters in their pursuit of the art.

(2) No display of any character will be accepted, nor can any special typographical arrangement, such as all or part capital letters be used which would tend to make one advertisement stand out from the others.

(3) The Ham-Ad rate is 15¢ per word, except as noted in paragraph (6) below.

(4) Remittance in full must accompany copy. No cash or contract discount or agency commission will be allowed.

(5) Closing date for Ham-Ads is the 25th of the second month preceding publication date.

(6) A special rate of 7¢ per word will apply to advertising which, in our judgment, is obviously non-commercial in nature and is placed and signed by a member of the American Radio Relay League. Thus, advertising of bona fide surplus equipment owned, used and for sale by an individual or apparatus offered for exchange or advertising inquiring for special equipment, if by a member of the American Radio Relay League takes the 7¢ rate. An attempt to deal in apparatus in quantity for profit, even if by an individual, is commercial and takes the 15¢ rate. Provisions of paragraphs (1), (2), (4) and (5) apply to all advertising in this column regardless of which rate may apply.

Having made no investigation of the advertisers in the classified columns, the publishers of QST are unable to vouch for their integrity or for the grade or character of the products advertised.

QUARTZ—direct importers from Brazil of best quality pure quartz suitable for making piezo-electric crystals. Diamond Drill Carbon Co., 719 World Bldg., New York City.

RADIO engineering, broadcasting, aviation and police radio, servicing, marine and Morse telegraphy taught thoroughly. All expenses low. Catalog free. Dodge's Institute, Byrd St., Valparaiso, Ind.

NATIONAL—Hammarlund, RCA-RME used sets, 60% off list. W3DQ, 405 Delaware Ave., Wilmington, Del.

QSL's, W2SN, Helmetta, N. J.

CLASS B transformers—Universal for two or four 46's, 6L6's, 210's, 800's, etc., \$7.75 pair postpaid. 70 watts audio from 46's, 100 watts from 10's. Write for details. W8UD, Douglas, Mich.

CALLBOOKS—new DX calls, new prefixes, thousands of new W and VE calls, in the Spring, 1937 Radio Amateur Call Book. Sent postpaid \$1.25, or a whole year (four issues) for \$4. (In foreign countries \$1.35 and \$4.35.) Your call and QRA printed in large type \$1 per year. Radio Amateur Call Book, 610 S. Dearborn, Chicago.

TELEGRAPH speed keys in kit form, only \$2.89. A post card brings full information. Electric Specialty Mfg. Co., PO Box 645, Cedar Rapids, Iowa.

QSL cards, two color, cartoons, snappy service. Write for free samples today. W1BEF, 16 Stockbridge Ave., Lowell, Mass.

WESTON D. C. milliamperemeters, Model 506, 0-300 scale, \$3. General Electric A-C, ampere meters, Type AO, 0-30, \$2. Miller Surplus, 2553 Madison, Chicago.

GUARANTEED first class condition complete with tubes and speaker. First come first served. Patterson PR10 \$39., Halli-crafter Super 7 \$29., Halli-crafter Sky rider 9 \$49, RME-9D \$75., All-Star Jr. \$19, Sargent 20 \$30. W9KJF, 34 W. Ohio St., Indianapolis.

25¢ prepaid—Second edition transmitting manual and fifteen manufacturers parts catalogs. Van Sickle Radio, Inc. (W9KJF) 34 W. Ohio St., Indianapolis, Ind. Distributors of all leading transmitting lines.

CRYSTALS: Zero cut. Guaranteed to compensate at zero without oven. 80-160 meters, \$1.85. Forty meters, \$2. Holders, 75¢ postpaid. Fisher Lab., 4522 Norwood St., San Diego, Calif.

CRYSTALS: Unconditionally guaranteed, small X cut, 80-160 meters, within ten kilocycles, \$1.50. Approximately 1", spot frequency \$2.50. Small X cut, 80 meter semi-finished blanks, including carborundum, three for \$1.20. Dustproof plug-in holders, 85¢. William Threm, W8FN, 4021 Davis Ave., Cheviot, Ohio.

THOUSANDS of crystals for 160 and 80 meter bands, 75¢ each postpaid. Faberadio, Sandwich, Ill.

QSL'S. Satisfied customers everywhere. Est. 1927. Stamp for samples, W8CUX.

SKYRIDERS, easy payments, prepaid. LaPierre's, Roundup, Mont.

QSL'S—SWL's. Samples? (stamp) W8DED, Holland, Mich.

FREQUENCY—exchange service on Bliley crystals. Write W8DED.

BLILEY crystals. W8DED

QST subscribers. Request W8DED's free gift.

SELL automatic mercury arc rectifier. W9FWT, 808 Melrose Ave., Lexington, Ky.

NEW—beautifully efficient feeder spreaders machined from plate glass, \$1.75 dozen postpaid with instructions for permanently symmetric installation, no metal, clamps, or tie-wires; any length up to six inches, other sizes on order. The Babney Special Products Co., Box 763, Cisco, Texas.

QSL'S. Cartoons. Free samples. Theodore Porcher, 7708 Navajo St., Philadelphia, Pa.

QSL'S, free samples. Printer, Corwith, Iowa.

SELL—Grammer autodyne & power pack, 2 Hammarlund I.P.'s, 1 B.O. coil, 1 W.E. 242A, excellent condition, & Johnson socket, 100 watt xmitter, C.C., E.C. 4 stages, 2 crystals fully metered, handsome rack. Write for photo and details. Make offer. W9RLL, 419 Minneapolis Ave., Duluth, Minn.

A.C.-S.W.-3, complete; power supply, tubes; 10, 20, 40, 80, 160 m. band—spread coils; recently factory overhauled, \$25. W8OZH.

QSL'S, SWL's, 3 color, 75¢ a 100. Lapco, 344 W. 39 St., Indianapolis.

SELL—Crystal transmitter, power supply, and 3 tube receiver with tubes and crystal, \$20 cash. W5FGG, Box 797, Frederick, Okla.

RECONDITIONED receivers: Always a wide selection because of our immense time payment sales. Penny post card brings list. Radiolab, 1515 Grand, Kansas City, Mo.

NAT. SW3, 4 sets bandspread coils, tubes, W. E. audio amplifier and power supply. \$20 complete. W2DVI, Bloomfield, N. J.

THE best place to get any make of Ham receiver, transmitting equipment, and parts is old W9DOQ, Palmer's Trading Post, Route 1, Duluth, Minn.

SELL—SW-3 160 general coverage, 80, 40, 20 bandspread coils. Stewart Warner 301A converter. Asa Adkins, 3816 UK Sta., Lexington, Ky.

CUSTOM built 9 tube ss superhet, metal tubes, preselector, iron core IF's, BO, AVC, crystal, speaker, power supply. Sacrifice—\$50. W2FUG.

GENERAL Electric 24/750 volt 200 mill ball bearing dynamos with filters, \$25. On twelve volts deliver 375, 6-15 volt 500 watts Westinghouse Aircraft with propeller, 100, 500 watts 500 cycles with exciters \$8. Slightly used, \$6, 900 cycle 200 watts \$15. Henry Kienzle, 215 Hart Blvd., Staten Island, N. Y.

TRADE monument or marker of granite for cemetery memorial three colors for good receiver and xmitter up to 1 k.w. and motor generators up to 2 k.w. Jerry Soukup, W5CZB, Mountain Park, Okla.

FB7A, 20-40 coils, Peak preselector, tubes. \$35. W8CUX, Millington, Mich.

AMATEUR radio, commercial radiotelephone and radiotelegraph licenses, complete training. Resident and correspondence courses. Every graduate a licensed operator. N. Y. Wireless School, 1123 Broadway, N. Y.

SILVER 5C with crystal, \$45. W9KBEH.

TWO National 1-10 receivers with tubes, no supply \$26 each. W9KEH.

HALLICRAFTER Ultra-Skyrider without crystal, \$65. W9KEH.

SELLING out entire equipment W9MEX. Crystal transmitter, Comet Pro, omnigraph. For particulars write Cornelius Schneider, St. Francis, Wis.

CRYSTALS: Request catalog listing complete line V, AT, X cuts, holders. Unconditional written guarantee. Pyrex Bowl feedthru insulators. Ham Crystals, 1104 Lincoln Place, Brooklyn, N. Y.

FEDERAL 100-A tube, 500 watts plate dissipation, \$30 including connectors and filament transformer. W2ADJ.

QSL'S, 300 one-color cards, \$1. Samples. 2143 Indiana Ave, Columbus, Ohio.

ARTISTIC QSL's. T. Vachovetz, Elmsford, N. Y.

QSL'S. Distinctive and new. Free samples. Maleco, 1512 Eastern Parkway, Brooklyn, N. Y.

USED 1937 Super Skyrider 20% off. W9NBE.

SELLING out—receivers, transmitters. W2DBF.

FOR sale: Unbound Proceedings IRE 1921 to date less only Nov. '23 and June and July '30. Best offer before March 31 accepted. J. Dan Bender, 7100 Chestnut St., NW, Washington, D. C.

BUGS—\$6, postage paid. Walter Vetromile, 190 School, Somerville, Mass.

QSL'S—samples. W8LQM, 1040 Kelton Ave., Columbus, Ohio

CAMERA: Kodak-Nagel Vollenda, half vest-pocket size, Schneider f.3.5, lens; color filter for same; Rhaco metal developing tank for 127 film; German hip-pocket aluminum tripod and universal head, in suede case; all good serviceable condition. First \$25 takes works. K. B. Warner, care this magazine.

NEW RME-69's—DB20's in stock. W8ANT.

USED receivers. W8ANT.

USED meters. W8ANT.

NEW Eimac 100T's—250T's in stock. W8ANT.

MAC-keys, \$7.95. W8ANT.

USED 53-10 exciter unit. W8ANT.

ALL lines of new and used amateur equipment bought, sold, exchanged. Write to Southern Ohio's only amateur owned amateur business. Jos. N. Davies, W8ANT, 2767 N. Bend Rd., Sta. A, Cincinnati, Ohio.

CRYSTALS, 80 and 160 meter bands 95¢, 40 meters, \$2. Holders, 60¢. Special AT cut \$2.35 mounted. White Radio Lab., Standpoint, Idaho.

TRANSMITTING condensers two mfd. at 2000 volts, \$2.10 postpaid guaranteed. Super Television Labs., Oconomowoc, Wis.

HIGH-power equipment wanted—for cash or trade. R. Kewley, Oconomowoc, Wis.

BETTER QSL cards. Fritz, 203 Mason Ave., Joliet, Ill.

COMMUNICATIONS receiver RCA Model ACR 136. Like new. Complete. First \$45 takes it. W2DPP.

CRYSTALS: Eidson T9 fracture resisting 40, 80, 160 meters, \$1.50. Dependable, powerful X cut. Close frequency always supplied. Fully guaranteed, accurately calibrated. Fast increasing popularity—they are unbeatable, say users. T9 ceramic plug-in holders, \$1.10 postpaid. C.O.D. orders O.K. Eidson's, Temple, Texas.

POWER transformers. Oversize. Lower prices. Guaranteed. Built to your specifications. W8EQ, Lima, Ohio.

EO-1 cable—50 ft., \$4.25. Price goes down as quantity goes up. Write W8DT.

QSL'S. Better designs; better stock; better workmanship. Free samples to Hams only. W2FJE, 143 DeKalb Ave., Brooklyn, N. Y.

HALLICRAFTERS receivers. W9ANZ.

BOSTON Hams—1 k.w. final amplifier, push-pull 52's—\$60 complete, tubes, 5 quality meters, antenna coupling. Phone Mystic 1055-W.

TAYLOR tubes. W9ANZ.

CRYSTALS complete with round bakelite plug-in (socket) holder. X-cut: 160-80m \$1.75; 40m \$2. Low Drift, near zero, 160-80m \$2.25; 40m \$2.50. Individual call wall card free. Unconditional guarantee. C.O.D. if desired. Premium Crystal Co., Box 2250-C, Kansas City, Mo.

HALLICRAFTERS receivers. W9ANZ.

7 MC. transmitter, 210's final—\$25. W3FYW.

CRYSTALS: Dollar special; X-cut 80m within 5 k.c. 40m powerful oscillators, \$1.40. Low Drift AT, V-cuts, 160-80m, \$1.60; 40m \$1.85. Round molded bakelite plug-in holders—Fb for 40 m—90¢. Dozen, \$7.20. Money-back guarantee. C.O.D.'s accepted. Star Crystal Co., 1324-M Georgia, Kansas City, Kansas.

WANTED: small electric calliops. Want 32V d.c. motors. Want 2000 v. d.c. generator, 500 w. W9HYO.

TELEPLEXES, omnigraphs, vibroplexes, meters, receivers bought, sold, traded. Ryan Radio Co., Monroe City, Mo.

SWAP 1930 Oldsmobile convertible coupe A1 for good receiver. John Stass 238½ 3rd St., Jersey City, N. J.

SELL brand-new RCA 803, \$20. W7DTJ, Clarkston, Wash.

WANTED—high and medium voltage power supply equipment. Prefer Delta or Thordardson. Also Delta AD-75 and AD-91, Dunco relays, crystal mike. Haynes, 1912 Begole, Flint, Mich.

CLASS B transformers fully cased tapped secondary \$4.25 pair up. Guaranteed. Send for prices. 112 S. Main, Blackwell, Okla.

TAYLOR tubes. W9ANZ.

QSL'S—SWL's. Best on market. W2AEY, 338 Elmora, Elizabeth, N. J.

CRYSTALS: Eidson's T-9 accurately calibrated 40 and 80 meter crystals in stock, close frequency supplied, \$1.50 postpaid. Impregnated ceramic lowloss holders finely lapped plates, \$1.10 postpaid. C.O.D. orders accepted. Hieronymus Radio, 8834 209 St., Queens Village, N. Y.

NATIONAL Union tubes one or one thousand 50% off list. Harper Richards, W8IV, Argyle, N. Y.

CALL letter plates, ¼" x 2" x 6¼", 75¢, two \$1.25. W8ESN.

QSL, SWL cards. Superlative quality. Samples, (Stamps) W8ESN, 1827 Cone, Toledo, Ohio.

SELL: Hammarlund Super Pro complete \$155; Hammarlund crystal Super Pro \$165; National HRO Senior \$117.70; Collins 4A transmitter complete \$45; other receivers and transmitters at big savings. W9ARA, Butler, Mo.

MODULATION meter. For complete details—Collins, 112 Shepherd Ave., S. Charleston, W. Va.

QSL'S—Special introductory offer extended. Radio Headquarters, Ft. Wayne Indiana.

HAMSTAMPS—add that personal touch to your QSL cards and letters—photo reproductions postage stamp size—of you, your rig, etc., made from your favorite snapshot. Perforated and gummed, 100 stamps \$1. Hamstamps, 1730 E. 17th St., Brooklyn, N. Y.

SELL advanced Crei Course for microscope?—field glasses?—miniature camera?—or cash. Box 653, Paris, Texas.

NEW—Mac-Key \$5. W2MJJ.

QSL'S—2 color—\$1 hundred. Samples. Stamp. W8NOS.

METER repair service. Complete repair and replacement service on all types of meters. Reasonable prices. Braden Engineering Co., 305 Park Dr., Dayton, Ohio.

BRETING 14's: In stock, \$99 cash; Johnstone Studios, Saginaw, Mich.

SELL: Collins 150B complete 60% off. Buy: 300W 110V 60C portable gasoline generator. Trade for Collins 32G portable complete. Box 1110, El Paso, Texas.

SELL: Pair unused 852's, \$20 for both. Two UV-201-A's, moderately used but emission good \$15 each. Unused type 03-A, graphite anode, \$10. Used Pilotron "P" tube, \$5. Unused deForest 552, slightly gassy, \$3. F.o.b. Hartford, K. B. Warner, care QST.

CRYSTALS. Buy yourself a Biley crystal and be safe. Guaranteed not to crack or stop oscillating if properly used. Order yours direct from W8DED, Holland, Mich. (Sent C. O. D. if desired, nothing down.)

BUD FLEX-O-SHAFT COUPLINGS

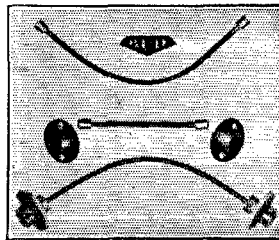

WITH THESE FEATURES:

1. Freedom from backlash.
2. Will turn at angles up to 90°.
3. Four types to meet a variety of requirements.

No. 859 and No. 860 consist of FLEXIBLE SHAFT with ¼" bushings sweated on each end, so as to fit either plain or insulated couplings.

No. 859 — Length 3" — Price \$.35
No. 860 — Length 6" — Price \$.50
No. 862 and No. 863 consist of FLEXIBLE SHAFT with Isotex couplings attached to ends of Flexible Shaft.
No. 862 — Length 4" — Price \$1.20
No. 863 — Length 7" — Price \$1.35

DEALER'S DISCOUNT 40%

Buy these from your Radio Jobber

BUD RADIO, INC. Cleveland, Ohio

LEARN RADIO

New Classes Now Forming! Send for 40-page catalog, explains fully. 300 licensed graduates placed in past 4½ years in broadcasting, shipping, police radio, aviation, etc. We teach all branches. Oldest, largest and best equipped school in New England. Equipped with Western Electric sound and broadcasting equipment and RCA marine transmitter. Course prepares for United States Government telegraph or telephone license.

MASS. RADIO SCHOOL, 18 Boylston Street, BOSTON

"The Crystal Specialists Since 1925"

PIEZO-ELECTRIC CRYSTALS

Guaranteed Accurate to BETTER than .01%

SCIENTIFIC RADIO SERVICE

UNIVERSITY PARK, HYATTSVILLE, MD.

Your Nearest Dealer Is Your Best Friend

Your nearest dealer is entitled to your patronage. You can trust him. He is equipped with a knowledge and understanding of amateur radio. He is your logical and safe source of advice and counsel on what equipment you should buy. His stock is complete. He can supply your needs without delay. His prices are fair and consistent with the high quality of the goods he carries. He is responsible to you and interested in you.

Patronize the dealer nearest you—You can have confidence in him

<p>CHICAGO, ILLINOIS</p> <p>Allied Radio Corporation 833 West Jackson Blvd.</p> <p>Complete standard lines always in stock—W9PVH—W9IBC—W9RZI</p>	<p>KANSAS CITY, MISSOURI</p> <p>Radiolab 1515 Grand Avenue Amateur Headquarters in Kansas City</p>
<p>CHICAGO, ILLINOIS</p> <p>Chicago Radio Apparatus Company 415 South Dearborn Street (Est. 1921)</p> <p>W9RA and W9PST — Amateurs since 1909</p>	<p>MILWAUKEE, WISCONSIN</p> <p>Radio Parts Company, Inc. 538 West State Street Complete stock Nationally Known products</p>
<p>DENVER, COLORADO</p> <p>Inter-State Radio & Supply Co. 1639 Tremont Place Amateur Radio Headquarters in the Rocky Mountain Region</p>	<p>MINNEAPOLIS, MINNESOTA</p> <p>Electric City 1607 Hennepin Street Headquarters for standard lines of amateur and servicemen parts</p>
<p>DETROIT, MICHIGAN</p> <p>Radio Specialties Company 171 E. Jefferson Avenue Ham Supplies — National & Hammarlund Sets and Parts</p>	<p>MINNEAPOLIS, MINNESOTA</p> <p>Lew Bonn Co. 1124-26 Harmon Place W9BP—W9TLE—W9HOP—W9DKL—W9LEX</p>
<p>DETROIT, MICHIGAN</p> <p>Rissi Brothers 5027-31 Hamilton Ave. at Warren W8KXX Manager Amateur Department</p>	<p>OAKLAND, CALIFORNIA</p> <p>Offenbach Electric Company 2085 Broadway "The House of a Million Radio Parts"</p>
<p>DETROIT, MICH.</p> <p>Serlin Stores 1419 Broadway, near Grand River Amateur parts — receivers — transmitters</p>	<p>SALT LAKE CITY, UTAH</p> <p>Felt Radio Company 150 South Main Street W6IAL—W6HVV—Intermountain Distributors—W6ENI—W6EPN</p>
<p>FRESNO, CALIFORNIA</p> <p>Ports Manufacturing Co. 3265 E. Belmont Ave. Wholesale: RCA-Thordarson-Bliley, All Standard Lines</p>	<p>SAN FRANCISCO, CALIFORNIA</p> <p>Offenbach Electric Company, Ltd. 1452 Market Street "The House of a Million Radio Parts"</p>
<p>DES MOINES, IOWA</p> <p>Iowa Radio Corp. 1212 Grand Avenue Complete amateur stock, W9OCG—W9EMS—W9KAY</p>	<p>ST. LOUIS, MISSOURI</p> <p>Van Sickle Radio Company 1113 Pine Street W90WD invites you to amateur headquarters in St. Louis</p>
<p>KANSAS CITY, MISSOURI</p> <p>Burstein-Applebee Company 1012-14 McGee Street "Specialists" in supplies for the Amateur and Serviceman</p>	<p>TORONTO, CANADA</p> <p>A & A Radio Service Supply 101 Queen Street, West Canada's foremost radio supply house</p>
<p>TORONTO, ONTARIO, CANADA</p> <p>Wholesale Radio Company, Ltd. 1133-37 Bay Street Canada's Largest Radio Parts Distributors — VE-3XB</p>	<p>WINNIPEG, CANADA</p> <p>Electrical Supplies, Ltd. 306-10 Ross Avenue Western Canadian Amateur Headquarters for leading lines</p>

You Are Protected When You Buy From QST Advertisers

“Advertising for QST is accepted only from firms who, in the publisher’s opinion, are of established integrity and whose products secure the approval of the technical staff of the American Radio Relay League.”

Quoted from QST’s advertising rate card.

Every conceivable need of a radio amateur can be supplied by the advertisers in QST. And you will know the product has the approval of the League’s technical staff.

For Your Convenience QST’S INDEX TO ADVERTISERS IN THIS ISSUE

Aerovox Corporation.....	86
Aladdin Radio Industries, Inc.....	94
Amperex Electronic Products.....	86
Astatic Microphone Laboratory.....	102
Autopower, Inc.....	99
Bassett Research Corporation.....	82
Bellefonte Radio Eng. & Mfg. Co., Inc.....	74
Birnbach Radio Company.....	98
Biley Electric Company.....	71
Brach Mfg. Company, L. S.....	118
Bruno Laboratories, Inc.....	90
Brush Development Company.....	106
Bud Radio, Inc.....	124
Burgess Battery Company.....	73
Candler System Company.....	84
Capitol Radio Engineering Institute.....	90
Cardwell Mfg. Corp., Allen D.....	72
Centralab.....	68
Clough-Brengle Company.....	78
Cohen’s Sons, Ltd., I. S.....	105
Collins Radio Company.....	Cov. 2
Cornell-Dubilier Corporation.....	88
Coto-Coil Company, Inc.....	127
Delaware Radio Sales Company.....	105
Delco-Remy Corporation.....	77
Dodge’s Institute.....	105
Eitel-McCullough, Ltd.....	93
Electrical Products Company, Inc.....	106
Electro-Voice Mfg. Company, Inc.....	108
Freck Radio & Supply Company.....	105
General Transformer Corporation.....	108
Gross Radio, Inc.....	107
Gulf Radio School.....	106
Hallcrafters, Inc., The.....	1-10
Hammarlund Manufacturing Company.....	69
Harvey Radio Company.....	104
Harvey Radio Laboratories, Inc.....	117
Heinemann Electric Company.....	92
Heintz & Kaufman, Ltd.....	109
Henry Radio Shop.....	92
Hipower Crystal Company.....	105
Instructograph Company.....	112
International Resistance Company.....	64, 65
Jefferson Electric Company.....	80
Kenyon Transformer Company.....	98
Leeds.....	95
Leuck Electric Service.....	114
Massachusetts Radio School.....	124
McElroy, T. R.....	105
McGraw-Hill Book Company.....	76
M & H Sporting Goods Company.....	119
Mims Radio Company.....	106
National Company.....	Cov. 3, 63
Newark Electric Company.....	91
New York Y. M. C. A. Schools.....	122
Ohmite Mfg. Company.....	88
Omaha Crystal Laboratories.....	119
Port Arthur College.....	99
Precision-Piezo Service.....	114
Radio Mfg. Engineers, Inc.....	79
Radio Shack.....	117
Radio Supply Company.....	109
Radio Transceiver Laboratories.....	112
RCA Institutes, Inc.....	118
RCA Manufacturing Company.....	Cov. 4, 95
Sargent Company, E. M.....	99
Scientific Radio Service.....	124
Shure Brothers.....	67
Sickles Company, F. W.....	119
Signal Electric Manufacturing Co.....	116
Speer Carbon Company.....	66
Sprague Products Company.....	103
Sun Radio Company.....	113
Sundt Engineering Company.....	105
Taylor Tubes, Inc.....	89
Teleplex Company.....	122
Terminal Radio Corporation.....	109
Thordarson Electric Mfg. Company.....	75
Transmitter Equipment Mfg. Company.....	81
Trim Radio Mfg. Company.....	122
Triplet Elec. Instrument Company.....	87
Turner Company.....	94
United Transformer Company.....	128
Universal Signal Appliance Company.....	102
Utah Radio Products Corporation.....	83
Valpey Crystals.....	116
Vibroplex Company.....	118
Ward Leonard Electric Company.....	114
Western Electric Company.....	70
Wilson, Willard S.....	105
Wincharger Corporation.....	119

TWENTY YEARS!



TWENTY years is a long time if you spend it in jail, but twenty years devoted to serving the radio amateur, must, of necessity, build up a reputation.

When, in 1917, COTO began the manufacture of quality radio products, one vision guided us — the vision of producing only those products of which we could be proud. Quick to sense superior products, the amateur fraternity, by their whole-hearted response have placed COTO in an enviable position in the radio industry. COTO products are today a "buy word" among "Hams".

"Hams" know that COTO products will outperform and outlast less worthy units, that they represent greater dollar value, that they are engineered particularly for radio amateur requirements.

If your favorite jobber has no copies of the COTO bulletins available, write us for your copy.

- R.F. CHOKES
- INSULATORS
- COUPLINGS
- INDUCTORS
- INDUCTOR
- MOUNTINGS
- CONTROL
- WHEEL DIALS
- I.F.
- TRANSFORMERS
- HONEYCOMB
- COILS

RADIO



PRODUCTS

COTO-COIL CO., Inc.

PROVIDENCE, R. I.

Export Address: 100 VARICK STREET, NEW YORK, N. Y.

NEW UTC BEAM POWER AMPLIFIERS

The advanced design features and exceptional value offered in the original UTC PAK kits is now extended to the following new units.

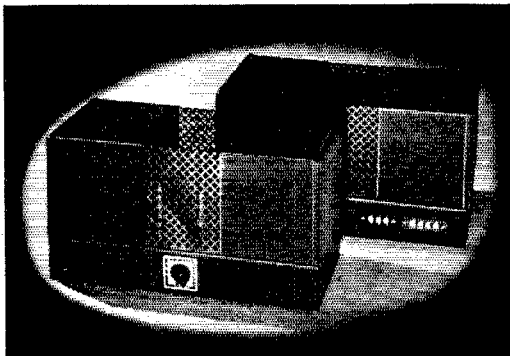

PAK-3 High Power Amplifier

Four 6L6's . . . 70 watts self-bias . . . 110 watts fixed bias. Tubes are 6C5, 6C5, 2-6C5's, 4-6L6's . . . 110 db gain. Separate chassis for power and audio . . . rack mounting. High impedance input . . . 500, 200, 50, 16, 8, 5, 3, 1.5 ohms output. Kit including all accessories, less tubes, net price

\$75

PAK-3X Same as PAK-3, but with Varimatch modulation transformer, net price

\$75

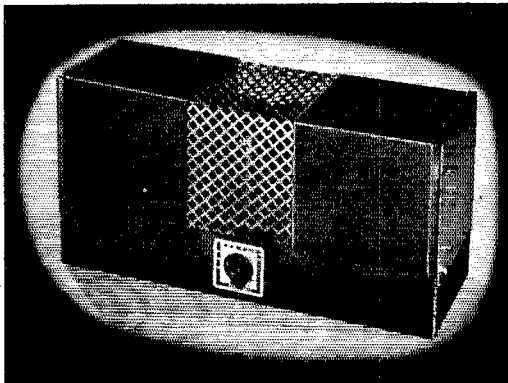

PAK-5 15 Watt Compact Amplifier

Two 6V6 Beam Power Tubes . . . 15 watts . . . power supply and audio amplifier on one chassis 6 x 8 x 16 1/2 inches. Tubes are 6C5, 6C5, 2-6V6's . . . 85 db gain . . . High impedance input . . . 500, 200, 16, 8, 5, 3, 1.5 ohms output. Kit including all accessories and pre-wired resistor-condenser strip, less tubes, net price

\$30

PAK-5X Same as PAK-5 but with Varimatch output, net price

\$30

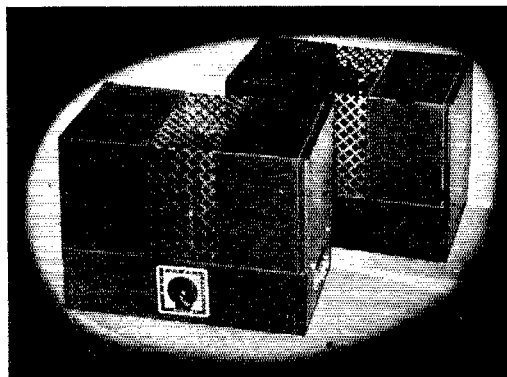

PAK-4 DC-AC Amplifier

Four 25L6 Beam Power Tubes . . . 8 watts output on 115 volts. Tubes are 6C5, 6C5, 4-25L6's . . . 85 db gain . . . High impedance input . . . 500, 200, 16, 8, 5, 3, 1.5 ohms output. The audio section is self-contained (6 x 8 x 10 1/2 in.) and can be operated directly on DC. For AC operation a separate power supply (6 x 8 x 10 1/2 in.) is used.

PAK-4A audio amplifier only, including all accessories less tubes, net price

\$18

PAK-4P AC power supply, net price

\$15

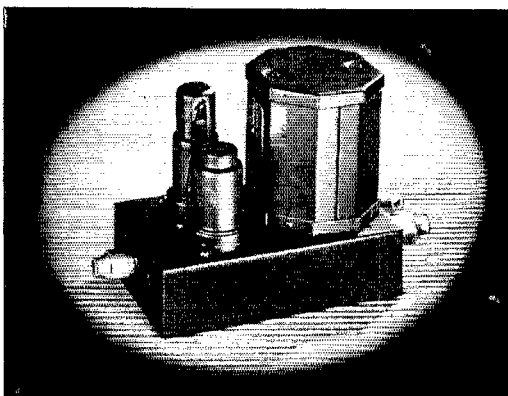

PAK-7A Preamplifier

High gain well filtered preamplifier designed to operate from power supply in main amplifier. High impedance input . . . 6F5 resistance coupled to 6C5 . . . 50, 200, 500 ohm output . . . gain 60 db. Amplifier kit only, less tubes, net price

\$9

PAK-7P power supply, if desired, net price

\$10

PAK-6X Universal 250 watt modulator kit uses two of the new low distortion ZB-120 tubes driven by two 6A5G's. 200, 500 ohm input . . . Varimatch driver transformer . . . Varimatch output. Kit is also designed so that it can be used with 805's, 838's, 203A's, 203H's, 211's, 830B's, RK-31's, HK-354's, 100T, HF100, T55, 822, or similar tubes at 1250 volt operating condition. Driver transformer will accommodate 42's, 45's, 59's, 2A3's, 6A5G's, 6L6's to any of the above tubes. Separate power and audio decks suitable for rack mounting. Including all accessories, less tubes, net price **\$120**

For further details see your dealer or write to UTC

UNITED TRANSFORMER CORP.

72 SPRING STREET

NEW YORK, N. Y.

EXPORT DIVISION: 100 VARICK STREET NEW YORK, N. Y. CABLES: "ARLAB"

CRM

The CRM Cathode-Ray Oscilloscope is the answer to the demand for an inexpensive modulation monitor. It is complete with internal power supply and sweep circuit.

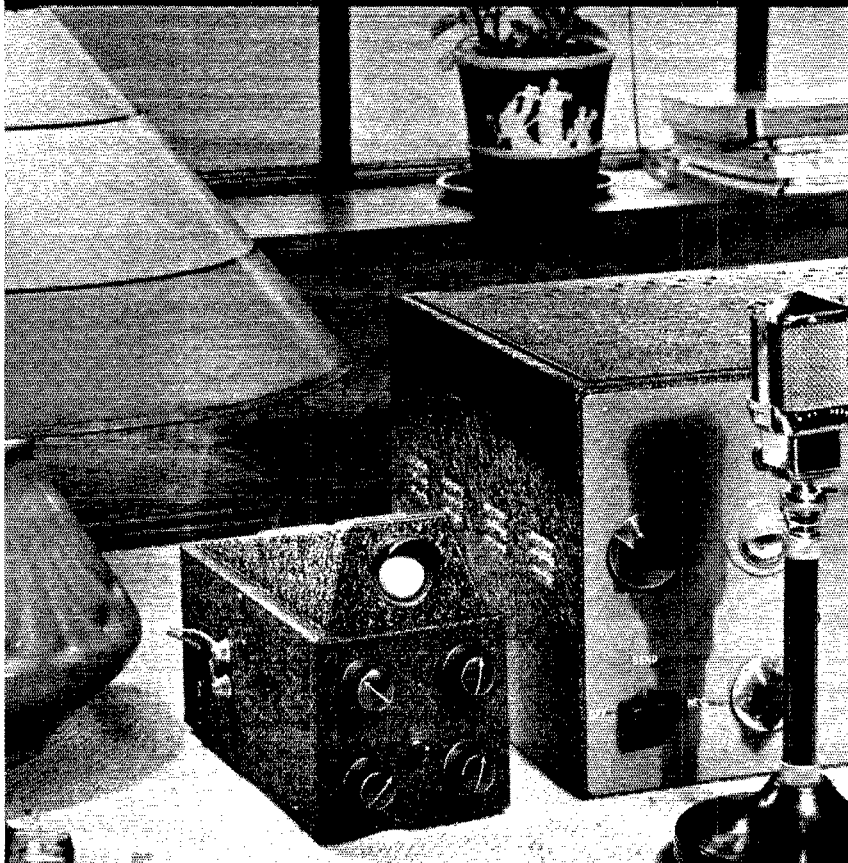

NC-101X

The NC-101X is a special band spread model of the NC-100X Receiver, employing the same circuit, crystal filter* and automatic coil changer. Strictly an amateur receiver it spreads each of the five amateur bands out over the entire useful portion of the dial.

*U. S. Patent No. 2,054,757

NATIONAL COMPANY



RCA TUBES FOR AMATEURS

Now at New Low Prices!

WAS \$4.50
NOW \$3.45



RCA 801

Triode, carbon-anode type. Max. ratings of 600 plate volts, 60 plate milliamperes up to 60 megacycles. Particularly popular for 5-meter transmitters.

WAS \$38.50
NOW \$34.50



RCA 803

Pentode, carbon-anode type, outstanding for grid-or suppressor-modulated service. No neutralization as Class C Amp. Max. ratings of 2000 plate volts, 175 plate milliamperes up to 20 megacycles.

WAS \$18.00
NOW \$15.00



RCA 805

An improved carbon-anode type of the so-called "50-watt" family, suitable for all services. Max. ratings of 1500 plate volts, 210 plate milliamperes up to 30 megacycles.

WAS \$16.00
NOW \$15.00



RCA 845

The standard carbon-anode triode for Class A Modulators.

WERE \$5.80
NOW \$5.00

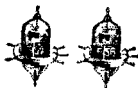

RCA 954, 956

WAS \$3.75
NOW \$3.00



RCA 955

The sensational acorn family for ultra-high frequency application.

WAS \$18.00
NOW \$15.00



RCA 906

The first and leading cathode-ray type for amateur use. Use the RCA-906 in your modulation monitor and be sure of your quality.

Prices effective March 1, 1937

SEE OTHER RCA PAGE ALSO IN THIS ISSUE



for Amateur Radio

AMATEUR RADIO SECTION

RCA Manufacturing Co., Inc., Camden, N. J. • A Service of the Radio Corporation of America