

# QST

APRIL, 1959  
55 cents

# Developed by to amateur radio

5- AND 10-  
METER CONVERTER  
CIRCUIT ON  
ANTENNA SYSTEMS  
CONVERTERS  
CONTEST RESULTS

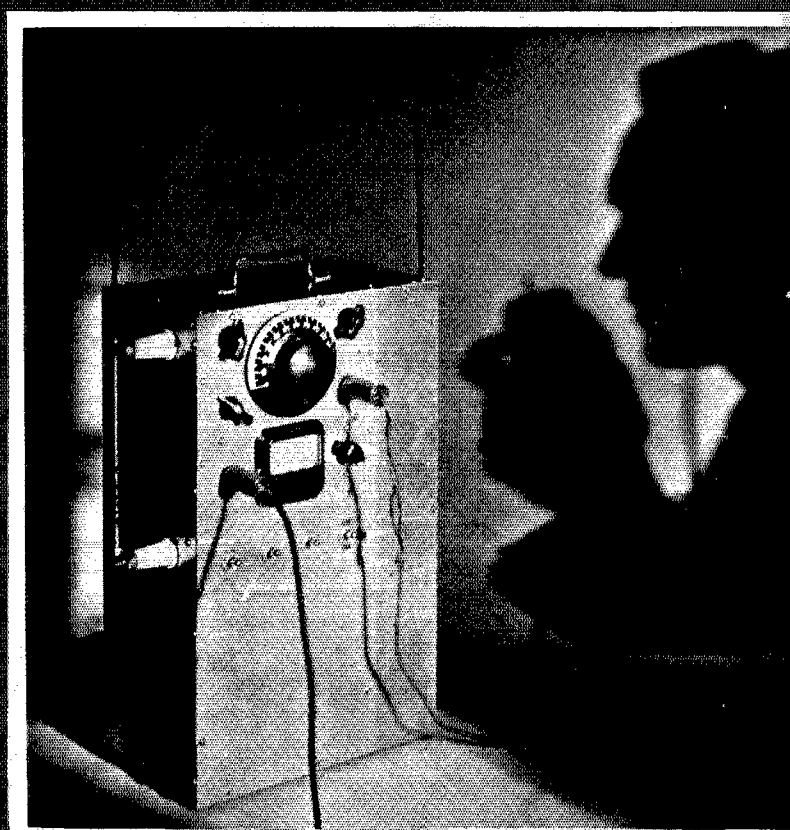

# COLLINS 18M

## Field Set

Exceptional performance, combined with light weight, small size and operating convenience, has been achieved in this new Collins development. The 18M is suited for a wide range of applications including military field service, exploration work, and, with minor modifications, for aircraft and mobile service.

### SPECIFICATIONS

#### RECEIVER SECTION

Superheterodyne type employing 1 tuned R.F. stage on all frequencies.

Tubes: 1—6S7G R.F.; 1—6K8G Converter—Osc.; 1—6S7G I.F.; 1—6T7G Det. & Audio; 1—6C8G Output Audio—c.w. Osc.

Frequency Range: 2 to 16 mc continuous coverage with optional crystal control.

#### TRANSMITTER SECTION

Tubes: 1—6V6G Oscillator; 1—6V6G Modulator; 1—807 Output Amplifier.

Frequency Range: 2 to 16 mc continuous coverage with crystal or master oscillator control.

Emission: A1 and A3.

Modulation: High level.

Power Requirements: 1.8 amp at 6.3 v and .100 amp at 350 v.

Power Output: 12 to 15 watts telegraph, 5 watts telephone.

#### WEIGHT AND DIMENSIONS:

18M Transmitter-Receiver Unit, complete with tubes and crystals in weatherproof case (12"x9"x9½")—20 lb.

Key, headphones, microphone, power cables—6 lb.

415E-1 vibrator power supply and storage battery (8½"x6½"x8¾")—25 lb.

420A Footpower Generator—50 lb.

416M 12 v. dynamotor power supply for aircraft installation—8½ lb.

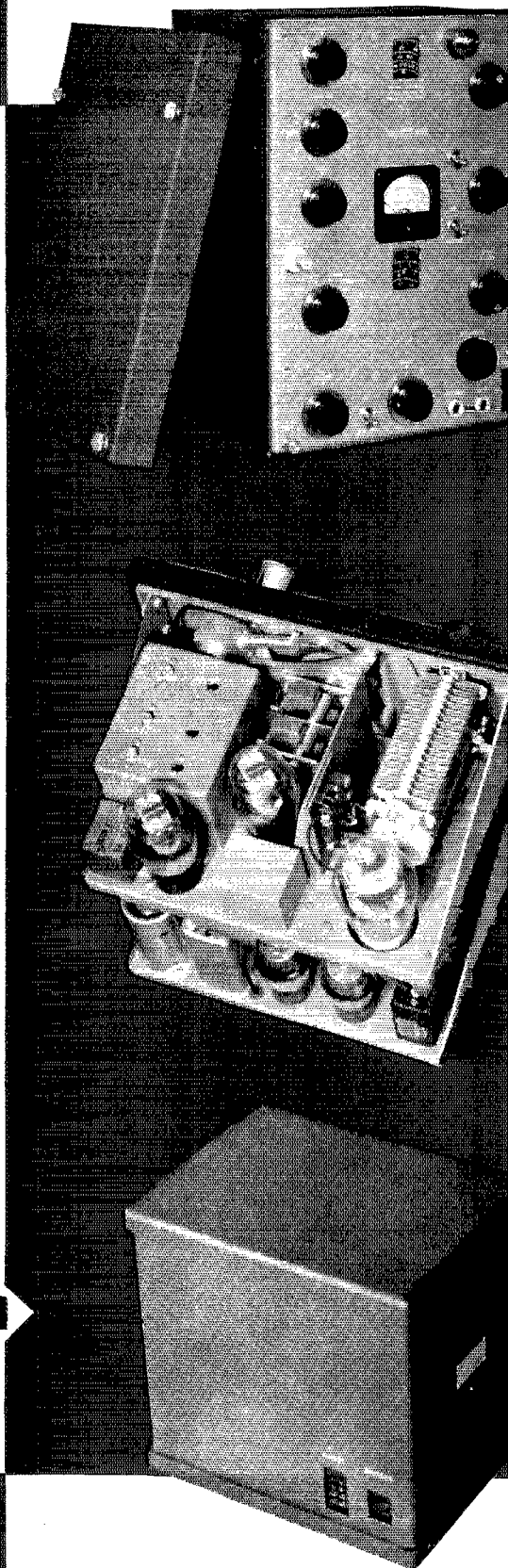

COLLINS RADIO COMPANY

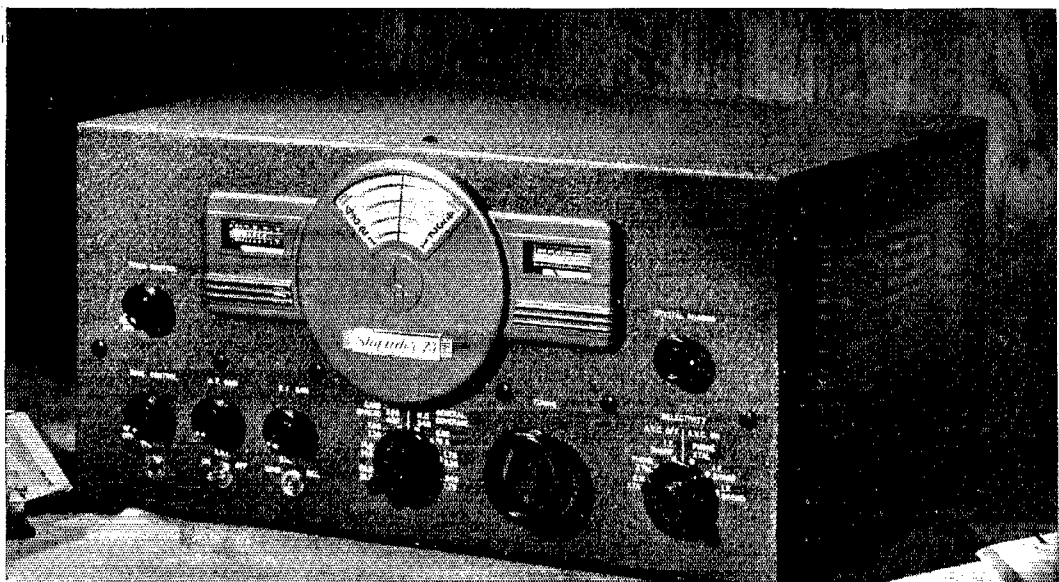

# the *New* SKYRIDER 23 is now IN STOCK at HARVEY'S

★ This latest development of the Hallicrafters engineers is probably the closest approach to the ideal communications receiver for the majority of amateurs. It is a precision receiver, brilliant in its performance, yet priced well within the reach of the average ham's purse.  
Net price, complete, is only ..... **\$127.50**

- ★ General coverage — 34 to .54 MC (8.8 to 556 meters).
- ★ 8 Band positions.
- ★ 11 Tubes.
- ★ 5 Watts audio output.
- ★ Temp. Compensated Permeability-Tuned I.F. Trans. Units (455 Kc).
- ★ Completely Shielded, Permeability-Tuned Crystal Filter Circuit.
- ★ 6 Position Variable Selectivity Switch.
- ★ S Meter calibrated in "S" units and db's.
- ★ Directly calibrated, Indirectly illuminated, "Venetian Blind" Tuning Dial.
- ★ Modern ventilation grills.
- ★ Speaker — P.M. Dynamic in separate cabinet of matching design.

## HARVEY'S

Headquarters for thousands of amateurs who have come to expect of us the type of service that compares in every respect to the unquestioned quality of the merchandise we sell. Harvey's makes it a point to carry all popular items *in stock* . . . at all times . . . A complete line of all the Hallicrafters receivers is here . . . now . . .

**HARVEY RADIO COMPANY**  
103 WEST 43 STREET NEW YORK, N. Y.

— AUTHORIZED AGENTS FOR —

# Buy HALLICRAFTERS



FROM

*Bob Henry*  
W9ARA

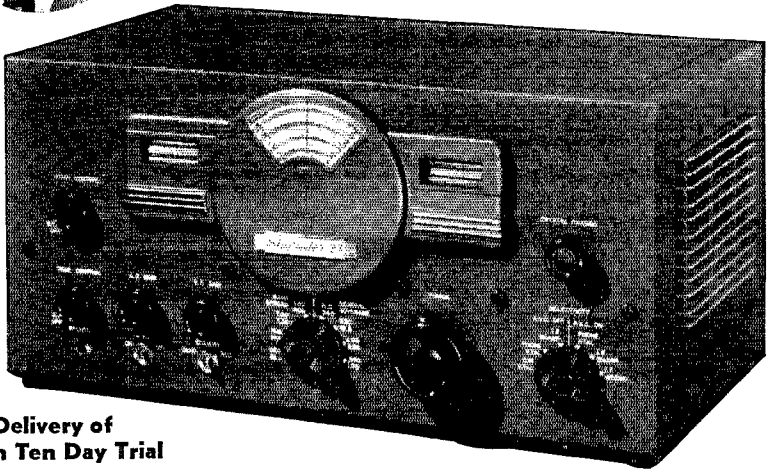

**Prompt Delivery of  
SX-23 on Ten Day Trial**

## COMPARE MY TERMS WITH ALL OTHERS

Model	Cash Price	Down Payment	12 Monthly Payments
SX-23	\$115.50	\$23.10	\$8.16
S-17	125.50	25.10	8.87
S-16	99.00	19.80	6.99
S-18	77.00	15.40	5.44
Sky Champion	49.50	9.90	3.49
Sky Buddy	29.50	5.90	2.08

*All other Hallicrafter receivers on similar terms*

These are some of the benefits you get from Bob Henry, W9ARA:

- Ten days free trial of any receiver.
- Big allowance for your present receiver.
- Easy 6% terms. I finance all sales myself.
- Complete stock. Prompt shipment of all models.
- Shipment direct from factory if you so desire.



You get the personal attention of Bob Henry, W9ARA to help you get the best equipment for your use and to see that you are entirely satisfied. You can reach me by letter, telegram, phone, or visit, nearly 24 hours a day, 365 days a year. Your inquiries and orders invited. Write for full information and for technical bulletin on any receivers.

*Bob Henry*  
W9ARA

**HENRY RADIO SHOP**  
BUTLER, MISSOURI

APRIL 1939

VOLUME XXIII

NUMBER 4



STAFF

Editorial

KENNETH B. WAGNER, W1EH  
Editor and Business Manager

CLARK C. ROBINSON, W1SZ  
Managing Editor

GEORGE GRAMMER, W1DF  
Technical Editor

DONALD H. MIX, W1TS  
BYRON GOODMAN, W1JVE  
Assistant Technical Editors

VERNON CHAMBERS, W1LQ  
Technical Information Service

JAMES J. LAMB, W1AL  
Consultant

Advertising

F. CHEYNEY BEEKLEY, W1GS  
Advertising Manager

CHARLES BRUNELLE  
Asst. Advertising Manager

Circulation

DAVID H. HOUGHTON  
Circulation Manager

RALPH T. BEAUDIN, W1BAW  
Asst. Circulation Manager



OFFICES

38 La Salle Road  
West Hartford, Connecticut

Subscription rate in United States and Possessions and Canada, \$2.50 per year, postpaid; all other countries, \$3.00 per year, postpaid. Single copies, 25 cents. Foreign remittances should be by international postal or express money order or bank draft negotiable in the U. S. and for an equivalent amount in U. S. funds.

Entered as second-class matter May 29, 1919, at the post office at Hartford, Connecticut, under the Act of March 3, 1879. Acceptance for mailing at special rate of postage provided for in section 1103, Act of October 3, 1917, authorized September 9, 1922. Additional entry at Concord, N. H., authorized February 21, 1929, under the Act of February 28, 1925. Additional second-class entries to cover sectional editions authorized March 20, 1935.

Copyright 1939 by the American Radio Relay League, Inc. Title registered at United States Patent Office.

# QST

devoted entirely to

# AMATEUR RADIO

PUBLISHED MONTHLY, AS ITS OFFICIAL ORGAN, BY THE AMERICAN RADIO RELAY LEAGUE, INC., AT WEST HARTFORD, CONN., U. S. A.; OFFICIAL ORGAN OF THE INTERNATIONAL AMATEUR RADIO UNION



## CONTENTS

"It Seems to Us" . . . . .	9
Splatter . . . . .	10
A DX Man's Super . . . . . K. A. Caird, W9ADG	11
A Coupling System for the Close-Spaced Antenna-Director Malcolm P. Mobley, Sr., W6JYH	16
Silent Keys . . . . .	17
The "Economy Forty" . . . . . Fred Sutter, W8QBW-QDK	18
Oregon State Convention . . . . .	19
A "Double-Barrelled" Antenna System. L. M. Swift, W5FDQ	22
What the League Is Doing . . . . .	24
New Tubes . . . . .	25
Checking Beam Antennas with the S-Meter S. Gordon Taylor, W2JCR	26
OQ5ZZ Calling "CQ USA." . . . . Edward A. Ruth, W2GYL	29
A Superhet Converter for 5- and 10-Meter Reception Frank Lester, W2AMJ	30
Canada-U. S. A. Contact Contest . . . . .	35
Dixie Jones' Owl Juice . . . . .	35
A Peak-Limiting Amplifier for Amateur Use Robert MacFarland, W5BKS	36
A Frequency-Checking Superhet . . . . . Dana A. Griffin, W2AOE	38
Safety Devices for Amateur Transmitters George Grammer, W1DF	42
A 6H6 A.C.-D.C. Voltmeter . . . . . Charles W. Carter, W3EZL	45
Extending Freq-Meter Calibrations with the 100-Kc. Oscillator R. L. Bunt, VE3MX	46
WWV Schedules . . . . .	47
A Hurricane Emergency Receiver . . . . . Gale M. Smith, W4PBP	48
Army-Amateur Radio System Activities . . . . .	52
1938 Sweepstakes Contest Results . . . . .	53
Naval Communication Reserve Notes . . . . .	58
I.A.R.U. News . . . . .	59
How Would You Do It? . . . . .	60
Hints and Kinks for the Experimenter . . . . .	63
Correspondence From Members . . . . .	65
Operating News . . . . .	66
Safety ABC's . . . . .	96
A.R.R.L. QSL Bureau . . . . .	118
New Apparatus — New Keying Device . . . . .	122
Hamads . . . . .	123
QST's Index of Advertisers . . . . .	126

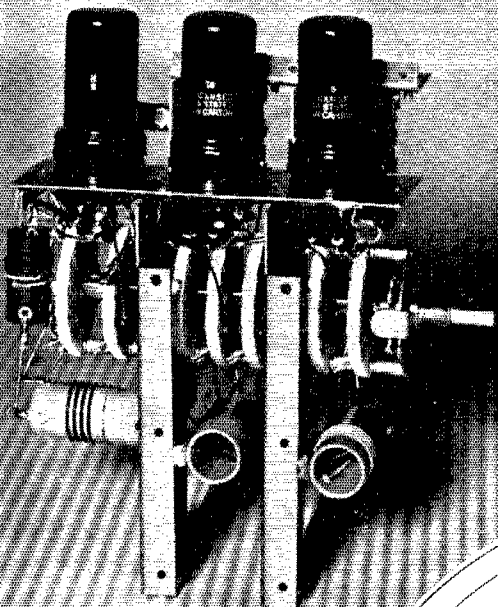

**NEW!**

**DM** (EKA) —  
**DM** (EGACYCLES)  
**3-6**

An all-amateur expander of new design and so highly refined that an actual gain of nearly 20 db is obtained in the two high frequency bands, 28 to 30 and 56 to 60 Mc. New tubes, new circuit design, new construction methods, a new conception of sensitivity without images when using the DM-36.

**NEW UNIT CONSTRUCTION**

1. Two range expander:  
 28 to 30 MC  
 56 to 60 MC
2. Overall R.F. gain — 18 db.
3. Image rejection ratio better than 25,000 to 1 at 30 MC.
4. Signal to noise ratio of 10 db at 1 microvolt using a 30% modulated R.F. signal.
5. Unit construction incorporating exceptional design features.
6. Self-powered and adaptable to any good superheterodyne receiver.
7. Antenna change-over switch provided.
8. Mounted on sturdy aluminum cast frame, adding all important rigidity.

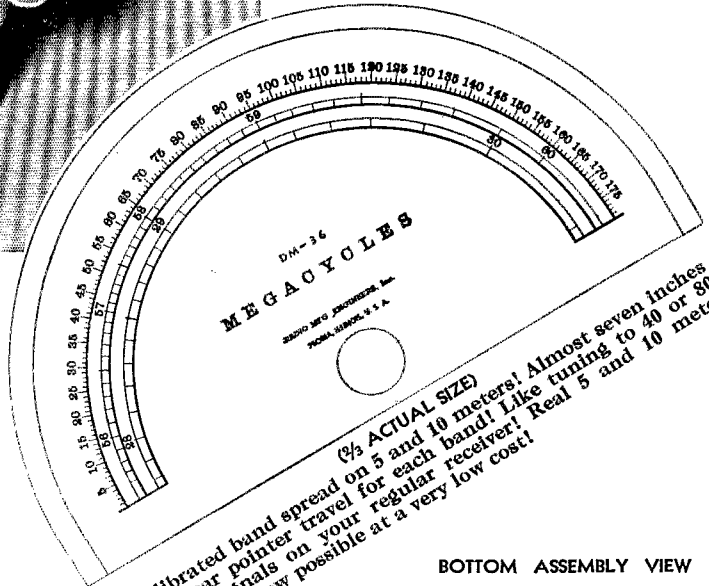

**BOTTOM ASSEMBLY VIEW**

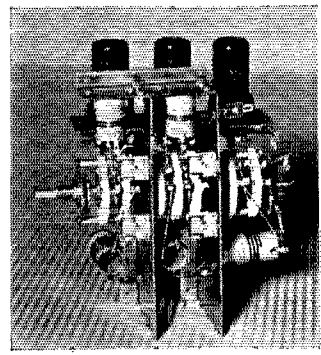

**DM 3-6 70 SERIES**

**READY**

**MARCH 25th**

Literature also  
 Available

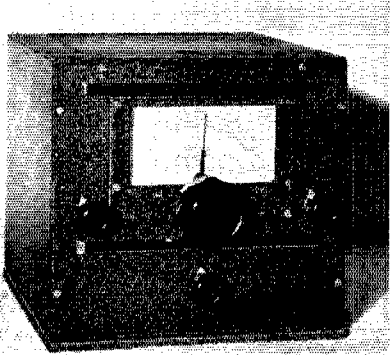

**RADIO MFG. ENGINEERS, INC.**  
 111 HARRISON STREET PEORIA, ILLINOIS

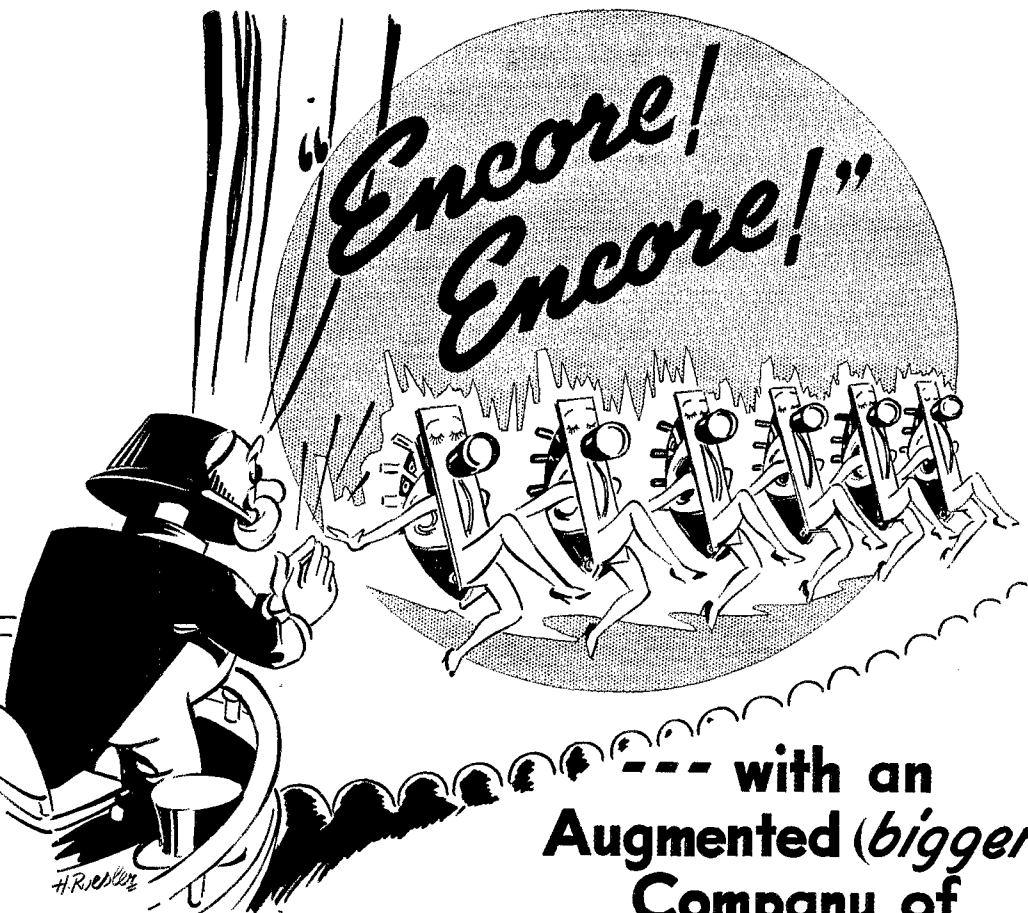

--- with an  
**Augmented (*bigger*)**  
**Company of**

# Centralab

LOW CAPACITY

## LEVER ACTION SWITCHES

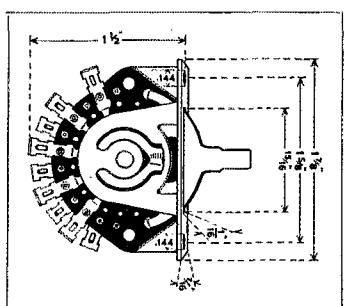

Contact clips of spring brass heavily plated (silver) treated for easy soldering. Switching combinations available use up to 12 clips per section.

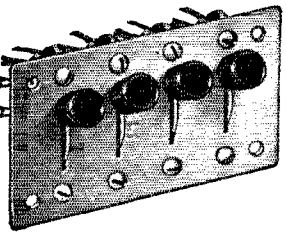

It's been a "sell out" from the very start . . . the audience composed of set manufacturers, P. A. folks, broadcasting engineers, test instrument makers and industrial technicians have been giving this swell chorus their hearty approval.

Now — augmented combinations cover every probable requirement you may have. The program (libretto) now lists the complete line-up. Just write and ask for special Bulletin No. 680 for full details, or see your jobber.

**CENTRALAB: DIVISION OF GLOBE UNION, INC., Milwaukee, Wisconsin**

## Section Communications Managers of the A.R.R.L. Communications Department

All appointments in the League's field organization are made by the proper S.C.M., elected by members in each Section listed. Mail your S.C.M. (on the 16th of each month) a postal covering your radio activities for the previous 30 days. Tell him your DX plans for experimenting, results in phone and traffic. He is interested, whether you are an A.R.R.L. member or get your QST at the newsstands; he wants a report from every active ham. If interested and qualified for O.R.S., O.P.S. or other appointments he can tell you about them, too.

Eastern Pennsylvania Maryland-Delaware-District of Columbia Southern New Jersey Western New York Western Pennsylvania	W3QP W3BAK W3BEI W8CSE W8OFO	<b>ATLANTIC DIVISION</b> John B. Morgan Edgar L. Hudson W. W. Filson Ed Preston Kendall Speer, Jr.	Blue Bell Laurel, Delaware Aulubon Tully Lower	
Illinois Indiana Kentucky Michigan Ohio Wisconsin	W9RMN W9QG W9ARU W8DPE W8AQ W9UIT	<b>CENTRAL DIVISION</b> Leslie M. Dickson Noble Burkhardt Darrell A. Downard Harold C. Bird E. H. Gibbs Aldrich C. Krones	Edellyn Farms R. 4, Box 1 116 N. Longworth Ave. R. F. D. 2 405 Broad St. 3127-A West Madison St.	Waukegan Indianapolis Louisville Pontiac Wadsworth Milwaukee
North Dakota South Dakota Northern Minnesota Southern Minnesota	W9RZA W9YGD W9IGZ W9VNO	<b>DAKOTA DIVISION</b> Ernest Bloch Dr. A. L. Russell Edwin L. Wicklund Millard L. Bender	Box 202 R. F. D. 3 608 N. Huron Ave.	Thompson Phillips Kensington Spring Valley
Arkansas Louisiana Mississippi* Tennessee	W5ABI W5DKR W5GHP W4DWS	<b>DELTA DIVISION</b> H. E. Velte Eugene H. Treadaway Robert E. Barr William Harold Walker	4415 West 12th St. 2749 Myrtle St. 301 Boscobel	Little Rock New Orleans Luedale Nashville
Eastern New York N. Y. C. & Long Island Northern New Jersey	W2LU W2AZV W2GMN	<b>HUDSON DIVISION</b> Robert E. Haight E. J. Baumach Fred C. Read	511 South Holmes St. 102 Central Ave. 1014 North Ave.	Scotia Massapequa, L. I. Elizabeth
Iowa Kansas Missouri Nebraska	W9ARE W9UEG W9OUD W9FAM	<b>MIDWEST DIVISION</b> Clyde C. Richelieu Melvin D. Kirby Miss Letha Allendorf Samuel C. Wallace	Radio Farm 1015 W. 3rd St. Green St.	Hurlington Arlington Joplin Clarks
Connecticut Maine Eastern Massachusetts Western Massachusetts New Hampshire Rhode Island Vermont	W1CTI W1FBJ W1LWC W1YAH W1BFT W1HRC W1KJG	<b>NEW ENGLAND DIVISION</b> Frederick Ells, Jr. Winfield A. Ramsdell Sam Gross W. L. Barrett Carl B. Evans Clayton C. Gordon Clifton G. Parker	19 Merrill Rd. 1188 Washington Ave. Pleasant St. 239 Columbia St. 163 South Main St. 192 Washington Ave. Box 537	Norwalk Portland Marshfield Hills Adams Concord Providence Morrissville
Alaska Idaho Montana Oregon Washington	K7ENA W7EMT W7FL W7DXF W7FCG	<b>NORTHWESTERN DIVISION</b> Leo E. Osterman Carl Eichelberger G. A. Woodhouse Harold W. Johnston W. Beale	Customhouse Route 2 Holter Dam 205 North Grant St. R. 4, School Ave.	Wrangell Kuna Wolf Creek Fondleton Walla Walla
Hawaii Nevada Santa Clara Valley East Bay San Francisco Sacramento Valley Philippines San Joaquin Valley	K6ETF W6BIC W6FBW W6JTV W6SG W6CZY KA1GR W6KUT	<b>PACIFIC DIVISION</b> Francis T. Blatt Edward W. Heim Elbert Amarantes Harold J. Burchfield Alan D. Whittaker, Jr. J. L. C. Buckenham George L. Rickard Edwin A. Address	837 16th Ave. 509 Claremont St. 454 Washington St. 2240 106th Ave. 79 Felton Ave. 2931 24th St. Box 849 2921 North Van Ness Blvd.	Honolulu Reno San Jose Oakland Mill Valley Sacramento Manila Fresno
North Carolina South Carolina Virginia West Virginia	W4CYB W4BQE W3IYA W8HD	<b>ROANOKE DIVISION</b> W. J. Wortman Ted Ferguson Charles M. Waff, Jr. C. S. Hoffmann, Jr.	P. O. Box 566 1213 College St. 2607 Stuart Ave. 47 Lynwood Ave.	Morganton Columbia Richmond Wheeling
Colorado Utah-Wyoming	W9EHC W7CLG	<b>ROCKY MOUNTAIN DIVISION</b> Carl C. Drumeller Ernest E. Parshall	1828 East Kiowa St. Salt Creek Electric Plant	Colorado Springs Midwest, Wyoming
Alabama Eastern Florida Western Florida* Georgia West Indies (Cuba-Isle-of-Pines- Porto Rico-Virgin Islands)	W4DGS W4DVO W4AXP W4AGI CM2OP	<b>SOUTHEASTERN DIVISION</b> James F. Thompson L. A. Connolly Oscar Cederstrom Leland W. Smith Mario de la Torre	1203 South Perry St. 719 So. Willow Ave. Second St. & Bruce Ave. 2010 Pennsylvania Ave. Escobar 110 (Altos)	Montgomery Tampa De Funiak Springs Augusta Habana, Cuba
Los Angeles Arizona San Diego	W6MQM W6KFC W6JRM	<b>SOUTHWESTERN DIVISION</b> Ralph S. Click Victor C. Clark Howard K. Breedlove	1038 Milwaukee Ave. 747 E. Polk St. R. 2, Box 636	Los Angeles Phoenix San Diego
Northern Texas Oklahoma Southern Texas New Mexico	W5DXA W5CBZ W5BEO W5CGJ	<b>WEST GULF DIVISION</b> Lee Hughes Carter L. Simpson Dave H. Calk Joseph M. Eldott	125 N. Main St. 2010 So. 4th St. 6726 Ave. Q	Childress Ponca City Houston Chamita
Maritime	VE1DQ	<b>MARITIME DIVISION</b> A. M. Crowell	69 Dublin St.	Halifax, N. S.
Ontario	VE3EF	<b>ONTARIO DIVISION</b> Dr. L. R. Gunn, (for VE3SG)	Ontario Hospital	New Toronto, Ont.
Quebec	VE2CO	<b>QUEBEC DIVISION</b> Lindsay G. Morris	Apt. 6, 4510 Girouard Ave., N.D.G.	Montreal, P. Q.
Alberta British Columbia	VE4GE VE5HP	<b>VANALTA DIVISION</b> C. S. Jamieson J. Hepburn, Jr.	581 W. Riverside Drive 335 Foul Bay Road	Drumheller, Alta. Victoria
Manitoba Saskatchewan	VE4BG VE4SY	<b>PRAIRIE DIVISION</b> A. J. R. Simpson Arthur Chesworth	635 Garfield St. 1071 4th Ave., N. W.	Winnipeg Moose Jaw

\* Officials appointed to act until the membership of the Section choose permanent S.C.M.s by nomination and election.



# "Like water on a DUCK'S BACK!"

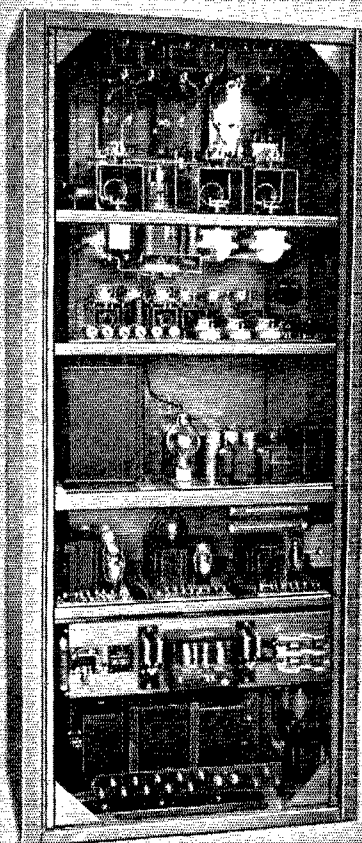

Recently, Radio Engineering Laboratories were commissioned to design and build a series of 500 watt radio telephone transmitters for service in the Tropics where **MOISTURE** is the Enemy of Efficiency!

R. E. L. engineers knew from experience that Kenyon T Line Transformers would fill the requirements not only because all Kenyon Transformers are Sealed-in but because they are completely dehydrated under the Kenyon-control method of manufacture. They knew that moisture, like water on a duck's back, just didn't have a chance! Whatever the conditions, whether in the Tropics or under the handicap of severe Arctic weather — as was the case with the McGregor Expedition — Kenyon Transformers always demonstrate their superiority.

When you purchase transformers, look for the famous "K" on the name plate. It will afford you the same assurance of quality and long reliable service that has made Kenyon the choice of leading industrial manufacturing and utility companies throughout the world.

*Send today for a copy of our new  
1939 Catalog . . . It's complimentary*



**KENYON TRANSFORMER CO., Inc.**

840 BARRY ST., NEW YORK, N. Y.

Export Department: 25 Warren St., New York, N. Y.

# THE AMERICAN RADIO RELAY LEAGUE

## Directors

<i>President</i>	
EUGENE C. WOODRUFF	W8CMP
234 W. Fairmount Ave., State College, Pa.	
<i>Vice-President</i>	
GEORGE W. BAILEY	W1KH
74 Webster Road, Weston, Mass.	
<i>Canadian General Manager</i>	
ALEX REID	VEZBE
169 Logan Ave., St. Lambert, P. Q.	
<i>Atlantic Division</i>	
WALTER BRADLEY MARTIN	W3QV
Box 612, Roslyn, Pa.	
<i>Central Division</i>	
R. H. G. MATHEWS	ex-W9ZN
100 East Ohio St., Chicago	
<i>Dakota Division</i>	
FRED W. YOUNG	W9MZN
107 Hanover St., Mankato, Minn.	
<i>Delta Division</i>	
E. RAY ARLEDGE	W58I
P.O. Box 286, Pine Bluff, Ark.	
<i>Hudson Division</i>	
KENNETH T. HILL	W2AHC
115 Willow St., Douglaston, L. I., N. Y.	
<i>Midwest Division</i>	
FLOYD E. NORWINE, JR.	W9EFC
120 South Fourth St., St. Louis, Mo.	
<i>New England Division</i>	
PERCY C. NOBLE	W1BVR
37 Broad St., Westfield, Mass.	
<i>Northwestern Division</i>	
RALPH J. GIBBONS	W7KV
c/o United Air Lines, Portland, Ore.	
<i>Pacific Division</i>	
J. L. McCARGAR	W6EY
86 Hamilton Pl., Oakland, Calif.	
<i>Roanoke Division</i>	
H. L. CAVENESS	W4DW
State College Station, Raleigh, N. C.	
<i>Rocky Mountain Division</i>	
GLEN R. GLASSCOCK	W9FA
2184 So. Corona St., Denver	
<i>Southeastern Division</i>	
BENNETT R. ADAMS, JR.	W1APU
1512 Grove Place, Homewood, Ala.	
<i>Southwestern Division</i>	
CHARLES E. BLALACK	W6GG
443 Main St., El Centro, Calif.	
<i>West Gulf Division</i>	
WILLIAM A. GREEN	W5BKH
801 Ross St., Abilene, Texas	

THE AMERICAN RADIO RELAY LEAGUE, Inc. is a non-commercial association of radio amateurs, bonded for the promotion of interest in amateur radio communication and experimentation, for the relaying of messages by radio, the advancement of the radio art and of the public welfare, for the representation of the radio amateur in legislative matters, and for the maintenance of fraternalism and a high standard of conduct.

It is an incorporated association without capital stock, chartered under the laws of Connecticut. Its affairs are governed by a Board of Directors, elected every two years by the general membership. The officers are elected or appointed by the Directors. The League is non-commercial and no one commercially engaged in the manufacture, sale or rental of radio apparatus is eligible to membership on its board.

"Of, by and for the amateur," it numbers within its ranks practically every worth-while amateur in the nation and has a history of glorious achievement as the standard-bearer of amateur affairs.

Inquiries regarding membership are solicited. A bona fide interest in amateur radio is the essential qualification; ownership of a transmitting station and knowledge of the code are prerequisite. Correspondence should be addressed to the Secretary.



HIRAM PERCY MAXIM, FIRST PRESIDENT

## Officers

<i>President</i>	EUGENE C. WOODRUFF, W8CMP
	State College, Pa.
<i>Vice-President</i>	GEORGE W. BAILEY, W1KH
	Weston, Mass.
<i>Secretary</i>	KENNETH B. WARNER, W2AHC
	West Hartford, Connecticut
<i>Treasurer</i>	ARTHUR A. HEBERT, W9EFC
	West Hartford, Connecticut
<i>Communications Mgr.</i>	F. EDWARD HANDY, W1BVR
	West Hartford, Connecticut
<i>General Counsel</i>	PAUL M. SHERMAN
	1026 Woodward Building, Washington, D. C.
<i>Address all general correspondence to the administrative headquarters at West Hartford, Connecticut.</i>	

# "IT SEEMS TO US—"

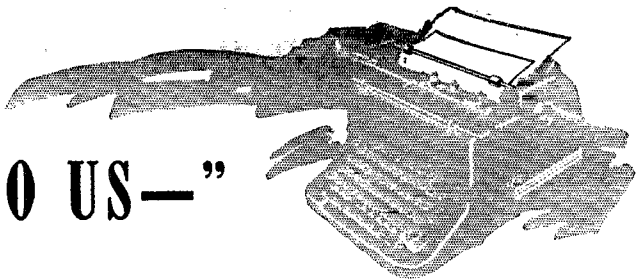

**T**HE monthly pearls of wisdom that grace this page are about to be concocted for another issue, as we sit ourselves at the old editorial mill and sneak up the gain control. That is, if you don't mind our mixing our metaphors. And it isn't as if we didn't have anything on the hook to talk about, what with this being the month we pay our Income Contest and enter the DX Tax. (What these contests do to a fellow!) But there's something a bit hotter:

It's about this business of foreign broadcasting in our 7-Mc. band. We almost blew our modulator tubes telling you what we thought of this subject last August. Now comes news of the first echelon of the advancing Martians and reports of the first actual invader.

Information is received from England that the B.B.C. is building two 100-kilowatt stations, to operate on 7240 and 7260 kc., commencing the first of September when the Cairo allocations go into effect. The stations are to operate east to India with directive antennas, we hear, and are to confine their operations to the afternoon hours in England or morning in America. Now that's all right. That is, it's as nearly all right as anything can be about this technically-screwball, morally-unjustifiable and economically-undesirable invasion of an essential amateur band. The purpose is the contemplated purpose, the hours are the contemplated hours, and the date is legally correct. If the plan is followed as announced, we in America will have small grounds for complaint and probably won't be bothered at all.

Something quite different, however, started about two weeks before this date of writing, in the form of a powerful French broadcasting station calling itself "Paris Mobile" and announcing its frequency as 7280 kc. It has been putting out the usual miscellaneous broadcasting program of music, news, talks and so on, in English. It deliberately addresses itself to the audience of the United States and Canada, and it solicits reception reports. It operates during our evening hours, signing off around midnight, eastern time. It hasn't waited until September 1st to begin operations.

It probably has antennas directed at North America, since the signal has been plenty QSA.

This case, then, is very different. If the station is truly French-owned, as we have every reason to believe it is, the action is inexcusable. France has ratified the Madrid regulations and she signed at Cairo. She is, therefore, obligated to permit only amateur stations to operate in the frequency band 7000-7300 kc., at least until September. In view of this fact the League has promptly appealed to the Department of State and has urgently requested that strong representations be made at once to the French Administration to cease the violation. We know no reason why the effort should not succeed.

There's something queer about this business; why should France thus violate her own amateurs? We don't know, but we do want to say that there is much more to the subject than simply pointing out to France that she must wait until September before she can do such a thing. She ought not to do it at all, she shouldn't even attempt it. Reasons? OK: (1) France needs amateur radio perhaps more than most countries. (2) It's absurd to expect reception of broadcasting on 7280 kc. in America. The delegation of the United States, authorized to speak at Cairo on this subject for all the nations of the Americas, served blunt warning of the intention of the Americas to continue this whole band exclusively for amateurs and pointed out that the intense activity of tens of thousands of stations in this most popular of amateur bands would make any public reception impossible. (3) France needs good will and well wishing on this side of the water, and that's no way to get it. We know at least fifty-one thousand American citizens who will think it a damned outrage that a major nation and a friendly nation and one notable for its grace and courtesy should do such a thing.

Let the French Administration ponder well this matter! If they are well advised they will not only immediately withdraw this senseless offense to the citizens of the American countries but they will abandon all further thought

of doing such a thing, either on September 1st or thereafter.

By the time you read these lines we expect this first of the invaders will have ceased operation. If it hasn't found its solicitation of American reception reports too discouraging it will, we trust, have piped down at the request of our Department of State. But what if it hasn't? What do we do then? Well, what are little transmitters for? We've got a right to work on 7280 kc., too. As one seagull said to the other seagulls, "What're we waiting for, boys?"

And, by T.O.M., the same thing goes for the rest of the world and for the period after September 1st! We intend to keep 7000-7300 only for amateur signals on this side of the water!

K. B. W.

---

## ★ SPLATTER ★

---

**T**HE ole mag is all buttoned up and ready for press; the Hq. gang is a bleary-eyed crew for fair, caused by a 30-hour week-end trying to raise DX. A stimulant has just been received in the form of a comment from Grammer, saying he has an article in the works titled, "How to Feel Peppy on Two Hours' Sleep." We'll give it a whirl this week-end, and if it does the trick we'll dish it up piping hot before another fracas.

★ ★ ★

Any youngster looking at Fig. 3, page 62, is going to be amazed to see that kite in the air — and so are we. The idea is okay, but we suggest other sources of consultation when it comes to adjusting the kite's bellyband.

★ ★ ★

One of our old-time readers dropped us a long spiel of great interest to us, concerning Hamerica in general. One point that particularly upset us was a statement to the effect that the title "Experimenter's Section" smattered too much of uninteresting and untried material — it should have another name to it. We were amazed and dug back into the binders — the last time we used that head was in May, 1932. Then it became "For the Experimenter" until April, 1936, when it emerged as "Hints and Kinks for the Experimenter." And our Perpetual Survey pronounces it the most widely accepted feature of the book.

★ ★ ★

Several of the gang take us to task for the bent arms in the photographs in our recent article, "Resuscitation from Electrical Shock." But our photographs aren't fake shots of a couple of

punks. The two men are members of the safety staff of one of the best-managed power companies in the country and are instructors in the subject. Each of them has saved a man's life by the procedure shown. One has had his own life saved by it. The photos were specially posed for our article in our own office. True, all the dope says to keep one's arms straight, and they are so shown in the Red Cross' photographs: that probably economizes strength by using one's weight more effectively.

★ ★ ★

We have come coasting along merrily for a time without any "busts" in *QST* diagrams. When they have occurred we have endeavored to give them publicity. But we have had the feeling we weren't doing an effective job of making these corrections public, and have wondered how we could improve the situation. W6QQE pops up and suggests we put major corrections under one heading, and he suggests "Feedback." It's a swell idea. They will be on this same page, and will be prominently displayed. Then it's up to individuals to dig up the diagrams referred to and make a suitable notation to the correction. We shall index these annually under the heading "Feedback." But we'll strive to *eliminate* all Feedback from *QST* pages in the future.

### FEEDBACK

#### *Fig. 2, p. 25, Dec. QST*

There should be no connection between the plate of the 6H6 background tube and the grid of the 1852 video amplifier. The 1852 grid connects only to the junction of L21 and L22. The background plate likewise connects only to R35.

-----

#### *Fig. 1, p. 13, Feb. QST*

Values for L1 and L2 should be interchanged.

-----

#### *Fig. 2, p. 50, March QST*

The center-tap of the secondary winding of transformer T1 should be connected to ground.

### OUR COVER

This portable transmitter and receiver operates on 112 Mc. and on one's shoulders without hump-back danger, according to W1JEQ who built it and uses it. Vern has promised us a story on it.

★ ★ ★

W1SZ has a new C W Sked at his house — Cynthia Warner Rodimon. Born Jan. 31 — The sked is one bottle of milk every four hours to suppress howls.

# A DX Man's Superhet

Built for DX reception on the 7-, 14- and 28-Mc. bands, this receiver has the features needed for the purpose, eliminates those not essential. It is a plug-in coil job with one stage of preselection, built-in noise silencer, and crystal filter. Separate tuning controls are provided for the high-frequency oscillator and the signal-frequency circuits. Mechanical construction, so frequently the weak spot in home-built receivers, has been treated with particular care.

## *Plug-in Coil Receiver for the 7-, 14- and 28-Mc. Bands*

BY K. A. CAIRD,\* W9ADG

IT HAS been said of the Dutch that their constant dissatisfaction with everything they do and everything about them is responsible for the high state of progress in that nation. Certainly some such spirit is responsible for our progress in amateur radio. Witness the constant rebuilding of beam antennas, excitors, and so on. In recent years receiving equipment seems to have escaped the wrath of our individual Dutch instincts. The amateur is beginning to regard his receiver as a little black box of sacred content. The limit of his expenditure on it is the twelfth payment. Whether the complication of modern receivers and the technical ability of the modern ham warrant such a situation is not our present theme. We elected to build our own receiver (more out of pride than judgment) and built one with the specific idea in mind that it might be torn apart from time to time. If there still exist a few others who include the receiver in their rebuilding programs, the arrangement of this one may be of interest to them.

He who builds must enjoy the building; otherwise he does not say he is saving money. While

the cost of parts may be considerably less than the cost of a completed receiver of equal performance, the time expended can only be charged to knowledge and experience, or the worthy use of leisure. No doubt about it, the home builder is at a disadvantage for shop and test equipment. Still, a set like this one does not require any more equipment than many amateurs already have. If it boasts a drill press, the home shop can probably handle the mechanical end. One of those popular a.c.-d.c. multi-range meters and the junk box line-up oscillator of the *Handbook* will take care of the test equipment.

An amateur building a set for himself does not need to compete with any manufacturer, so he need only include those features which are necessary to produce the results he desires. Thus, by making a few choices in the beginning the task can be simplified. Our own choice was clear: We wanted weak signal response on a few bands — mostly 10 and 20. We were willing to give up single control tuning, quick band-changing, a.v.c., and an "S" meter, to concentrate on essentials. Too much credit cannot be given W6AUX for many of the features which brought in the

\* 324 East Touhy Ave., Park Ridge, Ill.

The front panel, hand-finished aluminum, is standard relay-rack size, 8¾ by 19 inches. The r.f. and oscillator tuning dials have been fitted with large knobs for tuning ease. Ten tubes in all, including those in the i.f. noise silencer.

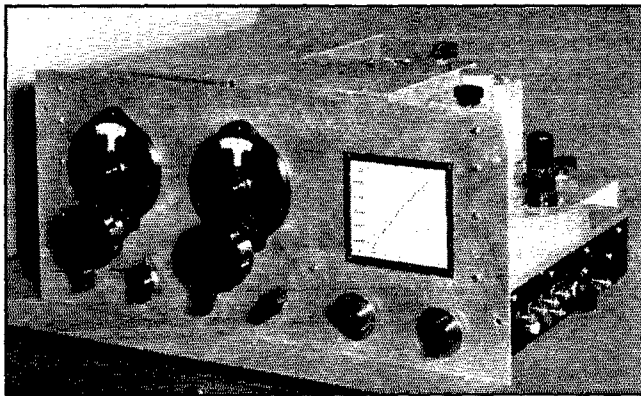

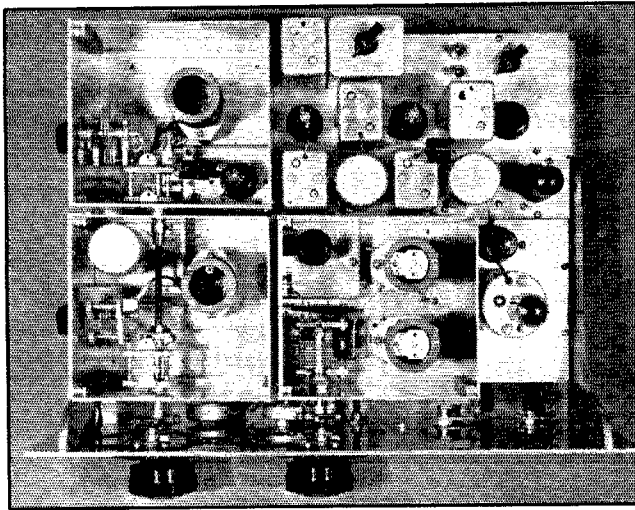

This top view shows the chassis layout clearly. The three coil compartments are generously proportioned and sturdily built. For mechanical stability, much of the chassis structure is cast aluminum. The i.f. section, at the upper right, is arranged so that the lower horizontal row of transformers and tubes is a conventional i.f. amplifier. The noise silencer and crystal filter, above, are thus easily segregated.

weak signals. Two years ago he very ably pointed out what was needed.<sup>1</sup>

#### Mechanical Construction

The first line of attack on any complex problem is to break it up into lesser problems. Mechanically, the entire set is built in sections to permit the quick removal of any stage. Electrically, each stage — r.f., and mixer; i.f., second detector and a.f.; h.f. oscillator and b.f.o. — was completed and tested before the set was ever assembled. Thus it had to work right off the bat — and did. Changes have already taken more time than the original construction. The foundation for the entire receiver is a cast aluminum spider. The pattern for this spider was made from trellis strip and printer's furniture. The floors of the three aluminum boxes are  $\frac{3}{8}$ -inch cast aluminum plates. Patterns for the floors and the side brackets were made from plywood. The open sections are on  $\frac{3}{32}$  aluminum sheet held up on runners of 1 by  $\frac{1}{4}$ -inch aluminum alloy. The construction of these sections and of the boxes is apparent from inspection of the photographs.

The actual cutting and fitting of all this aluminum is not difficult, though it does get laborious. Assuming an elementary amount of shop technique, only a few hints need be added. Use a "beaver" file on the castings and on the sheets wherever possible. Clean out files with the rough end of a piece of drill rod. Do not hand-saw and file sheet stock if you can help it. Have it sawed or sheared and stand right over the gutter-pipe man. Be generous with condensed milk when drilling and tapping aluminum or its alloys. Large holes like  $\frac{3}{8}$  inch or so should be opened up first with a small hole the size of the flat of the large drill.

<sup>1</sup> M. E. Moore, "Improving Weak Signal Response in Superhets," *Radio*, March, 1937.

When the handling is over, all metal can be washed with soap and water.

The metal for the box sides and top should be planned and cut after the base plates are cleaned up square. Likewise, the metal for flat sections (i.f., etc.) is best planned with the boxes finished and in place. When the boxes are in place on the spider, there is no common partition between stages and also no common floor or ceiling. Whether or not all this hardware is justified from the standpoint of shielding may be questioned, but there is no doubt about the value of the rigidity, and the convenience of being able to take out any section. The tube sockets in each of the three boxes are set in little corner platforms made by folding down two laps on a small piece of aluminum. The by-pass condensers, with most of the wiring, are thus between the platform and the compartment floor proper, while the d.c. leads continue through the bottom. This puts only the resistors out in the open where they can be easily adjusted and changed. Some of the resistors can be seen mounted to the long bakelite strips in the bottom view. These strips were drilled and tapped along their entire length beforehand. Many connections terminate in soldering lugs snipped into spade tips and fastened under screw heads. This arrangement paves the way for changes and measurements in the under regions with a minimum of effort and hay-wire.

#### R.F. Circuit Details

There is enough *Handbook* material available to allow a discussion of the various stages to be confined to features peculiar to this set. Beginning at the input end we might call attention to the large coils, large wire, and large compartments in the r.f. and mixer. It seems that such admitted electrical advantages are often martyred in the cause of compactness and easy band-

change. The topic of r.f. coil design enjoyed its glory some years ago. A recent paper in *QST*<sup>2</sup> will provide valuable material for the ham who winds his own today. The top or grid ends of  $L_1$  and  $L_3$  come directly off the form to thumbnuts on the condenser. It is hardly an advantage to run an r.f. lead down through a coil and then back up again to the grid of a tube. Coils should be pruned to hit their bands with the least possible padding capacity. The high *LC* idea could be carried further but it seemed to us that an acorn preselector would be the place to go the limit on that. The presence of the primary on  $L_3$  requires fewer turns on  $L_3$  than  $L_1$  or allows more turns to be crowded on  $L_1$ , whichever way you look at it. Why make up the difference with padding capacity on  $L_1$  when turns are so precious on 28 Mc.?

There is hardly any other choice for an r.f. tube than the 6J7G, unless it be an acorn. Throughout the entire set the sharp cut-off tubes are used in preference to the 6K7-6D6 types.<sup>3</sup> They permit the time-honored ham practice of a little more plate voltage without excessive plate

<sup>2</sup> Dale Pollack, "Factors Influencing the 'Q' of R.F. Coils in Amateur-Band Receivers," *QST*, February, 1939.

<sup>3</sup> The sharp-cutoff receiving pentode develops about 25 per cent less noise than the remote-cutoff type. Unfortunately it does not follow that the signal-noise ratio is increased correspondingly, however, since the determining noise voltage is, or should be, that resulting from thermal agitation in the first tuned circuit. With this the case, only a small improvement in overall signal-to-noise ratio results even when a fairly marked reduction in tube noise can be effected. It is worth while, however, to reduce noise to the greatest possible extent in the interests of weak-signal reception, particularly in the first stage and on the higher frequencies.

In the i.f. amplifier, the tube noise may be safely disregarded, since it will be negligible in comparison with that originating in the first stage and mixer and subsequently amplified. For convenience in volume control, remote-cutoff tubes may be used here with no damaging effect on the signal-noise ratio. — EdrroR.

current. At least our 6C6's seem to thrive on 300 volts plate — 150 volts screen, and it does make a difference in signals.

The 6L7 in the mixer went to work with a minimum of pampering as compared to some injection systems. We still cast frowns on it from time to time, and perhaps with some better arrangements for measuring outputs and inputs we can find an excuse to put a 6J7G in this socket, too.

Similarly, the 6J5 tickler coil h.f. oscillator puts out more h.f. with less coaxing than any other oscillator tried. By careful shielding and filtering we had a 6J7 in the so-called e.c. circuit doing very well here. There was no hum on 20 meters and a barely perceptible one on 10. The 6J5 has more output though, and, of course, as its cathode is grounded, there is no hum at all. The frequency stability of the triode is not equal to the other, but it is surprisingly good; only a big flip of a volume control will change beat notes.

What we liked best about the e.c. oscillator circuits was the possibility of varying output by changing voltages, without shifting the frequency all over. Perhaps a miniature transmitter like an e.c. 6F6 with a separate heater battery would not be so grotesque at that! At any rate, the oscillator-mixer combination is one place for the builder inclined to experiment to have his fun.

The lead from h.f. oscillator to first detector must be as short as possible, rigid, and well away from everything. It is not smart to enclose it in shielding braid, not unless you have output to by-pass away.

Of the two coils seen in the oscillator compartment the rear one is in the circuit. A switching arrangement was tried and abandoned. Now the front socket serves simply as a resting place for the other coil. It takes only 20 seconds per stage to remove covers and change coils. Individual

The cast-aluminum spider which forms the basis of the chassis is visible in this bottom-view photograph. The base-plates for the r.f. stages, at right and lower center, also are heavy aluminum castings. Comparatively little of the r.f. wiring is below chassis.

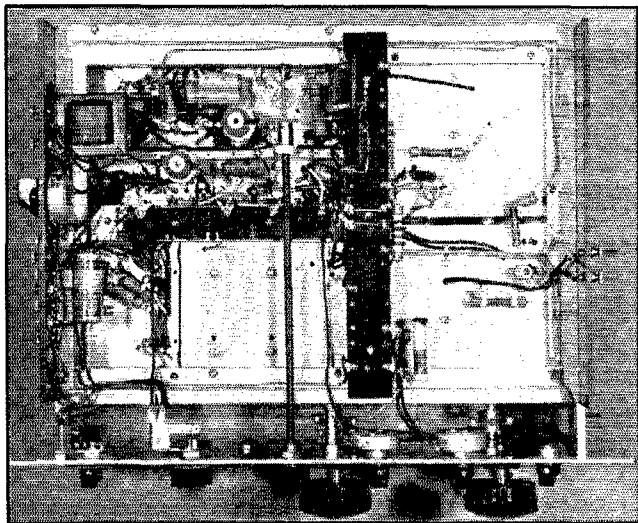

padding condensers in each oscillator coil may be expensive, but they are a real convenience. The oscillator tuning condenser,  $C_5$ , a National SE-50, was selected because of its 270-degree rotation and the ease with which the stator could be cut down. The stator is rebuilt into a 3-plate and a 7-plate section. The latter is not used but is

easily cut in if some "general coverage" is ever wanted.

### I.F. Section

The i.f. was first built for straight superhet and the crystal and silencer added as a detour to the rear. The straight through line-up, mixer,  $T_2$ ,

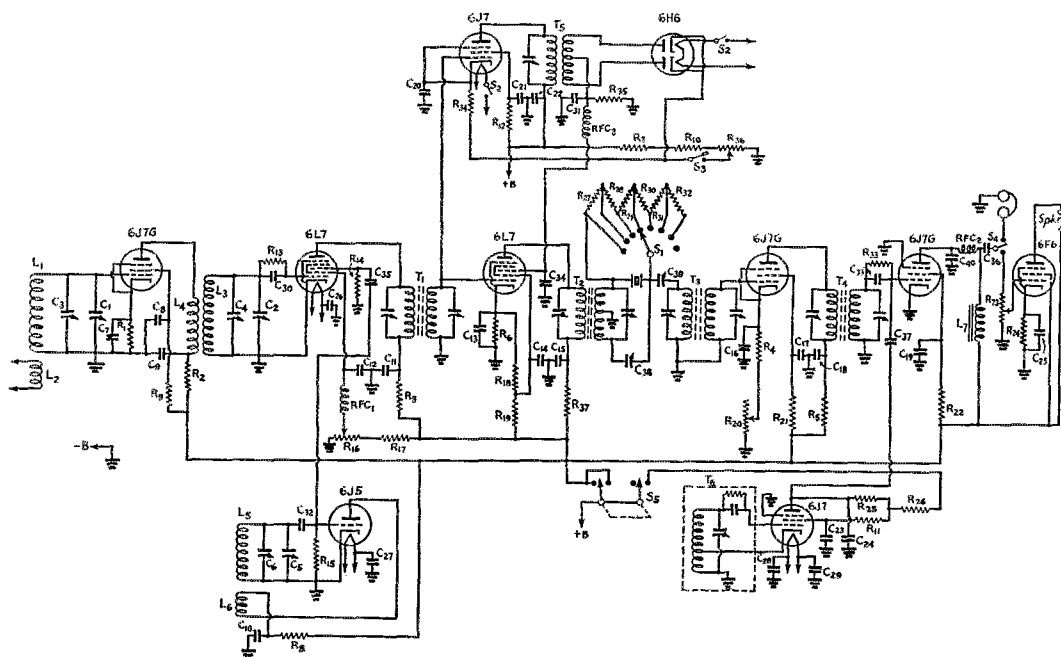

Fig. 1 — The receiver circuit diagram.

- $C_1, C_2$  — 20- $\mu$ fd. variable (Hammarlund MC-20-M).
- $C_3, C_4$  — 50- $\mu$ fd. variable (Hammarlund MC-50-M).
- $C_5$  — Double-section variable (see text).
- $C_6$  — 7 Mc.: 75- $\mu$ fd. air trimmer (Hammarlund APC-75).
- 14 and 28 Mc.: 50- $\mu$ fd. air trimmer (Hammarlund APC-50).
- $C_7$  to  $C_{10}$ , inc. — 0.01- $\mu$ fd. paper.
- $C_{11}$  to  $C_{24}$ , inc. — 0.1- $\mu$ fd. paper.
- $C_{25}$  — 25- $\mu$ fd., 50-volt electrolytic.
- $C_{26}$  to  $C_{29}$ , inc. — 0.25- $\mu$ fd., 200-volt paper.
- $C_{30}$  to  $C_{33}$ , inc. — 100- $\mu$ fd. mica ( $C_{33}$  may be larger).
- $C_{34}, C_{35}$  — 50- $\mu$ fd. mica.
- $C_{36}$  — 0.01- $\mu$ fd. mica, 1000-volt.
- $C_{37}$  — See text.
- $C_{38}$  — 15- $\mu$ fd. air trimmer (National UM-15).
- $C_{39}$  — 10- to 70- $\mu$ fd. mica trimmer (Hammarlund).
- $C_{40}$  — 250- $\mu$ fd. mica.
- $R_1$  — 250 ohms,  $\frac{1}{2}$ -watt.
- $R_2$  to  $R_7$ , inc. — 2000 ohms,  $\frac{1}{2}$ -watt.
- $R_8$  — 2000 ohms, 1-watt.
- $R_9$  to  $R_{12}$ , inc. — 100,000 ohms, 1-watt.
- $R_{13}$  — 10 megohms,  $\frac{1}{2}$ -watt.
- $R_{14}$  — 50,000 ohms,  $\frac{1}{2}$ -watt (low-capacity type).
- $R_{15}$  — 125,000 ohms,  $\frac{1}{2}$ -watt (low-capacity type).
- $R_{16}$  — 10,000-ohm potentiometer.
- $R_{17}$  — 30,000 ohms, 2-watt.
- $R_{18}$  — 50,000 ohms, 1-watt.
- $R_{19}$  — 50,000 ohms, 1-watt (or higher).
- $R_{20}$  — 50,000-ohm potentiometer.
- $R_{21}$  — 750,000 ohms,  $\frac{1}{2}$ -watt.

- $R_{22}$  — 75,000 ohms,  $\frac{1}{2}$ -watt.
- $R_{23}$  — 500,000-ohm potentiometer.
- $R_{24}$  — 500 ohms, 2-watt.
- $R_{25}$  — 10,000 ohms, 1-watt.
- $R_{26}$  — By trial to improve b.o. operation (may be omitted).
- $R_{27}$  — 5000 ohms,  $\frac{1}{2}$ -watt.
- $R_{28}$  — 15,000 ohms,  $\frac{1}{2}$ -watt.
- $R_{29}$  — 60,000 ohms,  $\frac{1}{2}$ -watt.
- $R_{30}$  — 250,000 ohms,  $\frac{1}{2}$ -watt.
- $R_{31}$  — 1 megohm,  $\frac{1}{2}$ -watt.
- $R_{32}$  — 2 megohms,  $\frac{1}{2}$ -watt.
- $R_{33}$  — 10 megohms,  $\frac{1}{2}$ -watt.
- $R_{34}$  — 300 ohms,  $\frac{1}{2}$ -watt.
- $R_{35}$  — 100,000 ohms,  $\frac{1}{2}$ -watt.
- $R_{36}$  — 4000-ohm potentiometer.
- $R_{37}$  — 2000 ohms,  $\frac{1}{2}$ -watt.
- $L_1$  to  $L_6$  — See coil table.
- $L_7$  — 1000-henry audio reactor.
- $T_1$  — 465-ke. iron-core i.f. transformer (Aladdin G101).
- $T_2$  — 465-ke. iron-core crystal input (Aladdin G101C).
- $T_3, T_4$  — 465-ke. iron-core i.f. transformer (Aladdin G101A).
- $T_5$  — Noise-silencer diode transformer (Aladdin G208).
- $T_6$  — 465-ke. beat-oscillator unit.
- RFC<sub>1</sub> — 2.5-mh. choke.
- RFC<sub>2</sub>, RFC<sub>3</sub> — 20 to 30 mh.
- $S_1$  — 3-point tap switch (Yaxley 1311).
- $S_2, S_3$  — S.p.s.t. toggle.
- $S_4$  — S.p.d.t. jack switch.
- $S_5$  — D.p.d.t. jack switch.



## COIL DATA

All on  $1\frac{1}{2}$ " diameter (Hammarlund SWF) forms

### 28 MC.

R.F.	$L_1$	6 turns No. 10 enamel 2" long
	$L_2$	5 turns No. 24 d.s.c. at bottom of $L_1$
Det.	$L_3$	5 turns No. 10 enamel 2" long
	$L_4$	5 turns No. 28 d.s.c. interwound with $L_3$
Osc.	$L_5$	3 turns No. 24 d.s.c. $1\frac{1}{4}$ " from $L_5$
	$L_6$	$1\frac{1}{2}$ turns $\frac{1}{4}$ " from $L_5$

### 14 MC.

R.F.	$L_1$	14 turns No. 14 enamel 2" long
	$L_2$	6 turns No. 24 d.s.c. at bottom of $L_1$
Det.	$L_3$	12 turns No. 14 enamel 2" long
	$L_4$	9 turns No. 28 d.s.c. interwound with $L_3$
Osc.	$L_5$	7 turns No. 24 d.s.c. $1\frac{1}{2}$ " long
	$L_6$	3 turns $\frac{1}{4}$ " below $L_5$

### 7 MC.

R.F.	$L_1$	23 turns No. 16 enamel 2" long
	$L_2$	6 turns No. 24 d.s.c. at bottom of $L_1$
Det.	$L_3$	21 turns No. 16 enamel 2" long
	$L_4$	17 turns No. 28 d.s.c. interwound with $L_3$
Osc.	$L_5$	14 turns No. 24 d.s.c. $1\frac{1}{2}$ " long
	$L_6$	6 turns $\frac{1}{8}$ " below $L_5$

6J7G,  $T_4$ , 6J7G second detector, makes a very good receiver, while saving pennies for the crystal-silencer section or while making alterations on that section. The straight super will have all the gain necessary. However, anyone who has ever heard a crystal-silencer combination clean up the noise and tumult will not have to be urged to add these parts. The presence of glass tubes in the i.f. is the result of gain statistics in the literature of the i.f. transformer manufacturer. The grid-leak second detector does block up a bit on strong signals, but we are generally safe in passing over the signal that blocks the detector. There is certainly no need for audio amplification in front of the 'phones. There might, however, be a desire for more than the single 6F6 to the speaker if a room is to be filled.

The crystal stage is conventional enough with the exception of the selectivity control. This is not new, being another of W6AUX's suggestions. A six-point switch will do about as well as the eight-point shown. Starting with a 20,000-ohm resistor and ending with 1 megohm will give four positions between no crystal and maximum selectivity, which is plenty. Compared to the usual detuning of  $T_2$  for selectivity, this resistor method is said to be superior as it permits tuning  $T_2$  on the nose. Rather we would say that the set can be aligned with  $T_2$  on the nose and a choice of selectivity will not disturb the alignment.<sup>4</sup>

<sup>4</sup> If the secondary of the crystal-input transformer is adjusted to resonance with the crystal out (shorted) for straight superhet operation, it will be found on switching in the crystal that the circuit is no longer in exact resonance. This effect is attributable to the fact that, with the crystal shorted, the circuit is shunted by the phasing condenser in parallel with the net capacity of the output coupling con-

If absolute maximum selectivity was wanted, it might still be necessary to detune  $T_2$  slightly in the alignment process. The resistor method is simplicity itself for the home builder, and is more compact and economical than the usual condenser. The crystal phasing condenser and resistor switch are built into one shield can. The phasing control comes from the bottom to the front panel and the selectivity switch is left a long arm's reach to the rear. This has been no hardship; under actual operating conditions we find enough to twirl without changing selectivity very often.

The silencer is exactly that of the *Handbook* with a little more screen voltage on the 6L7. The rather long lead tying the grids of the 6L7 and 6J7 together does not seem to do any damage. It is bare wire carefully centered between the shield cans. There is nothing dangerous about the long lead from  $T_5$  to the injector grid provided the

(Continued on page 110)

denser and (in this case) the output transformer primary trimmer in series. With the crystal in, these additional capacities are in series with the crystal-holder capacity, which is small, and thus a definite shift in tuning takes place. The effect is greatest when the resistance shunted around the crystal is very high or infinite.

The i.f. transformer preferably should be aligned with the crystal out, which usually will bring the tuning somewhere near the "optimum selectivity" (and maximum response) point when the crystal is cut in. If the transformer is adjusted to resonance with the crystal in, the selectivity will be considerably below optimum, and far below the maximum obtainable; the transformer also will be off resonance in the straight super position.

This type of selectivity control has the disadvantage that the effectiveness of the phasing condenser in balancing out interference is greatly reduced when the resistance in parallel with the crystal is low enough to broaden the response curve appreciably. — Editor.

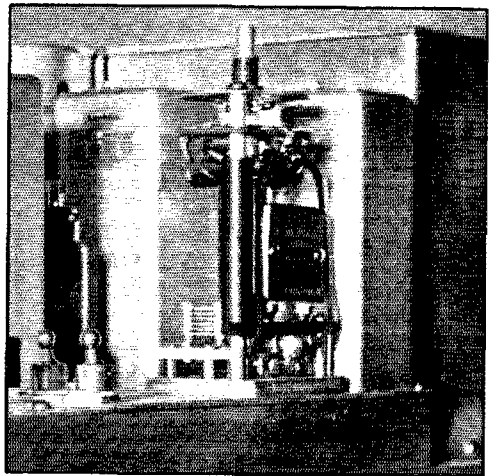

A close-up of the crystal unit, with the shield can removed. The selectivity switch is mounted vertically, with its shaft projecting through the top of the shield.

# A Coupling System for the Close-Spaced Antenna-Director

*Link Coupling to Simplify Matching Problems*

BY MALCOLM P. MOBLEY, SR.,\* W6JYH

THE half-wave antenna-director with one-tenth wave element spacing discussed by W2DFN in the May 1938 issue of *QST*,<sup>1</sup> looked so promising that it was decided to give the system a thorough tryout at W6JYH. The results have been so very satisfactory that we believe others will be interested in our method of application.

Using 300 watts input, our reports on a conventional type of fixed antenna had been averaging S7 to S8 in the Philippine Islands, Japan and other transpacific points. Upon final adjustment of the new antenna our reports have soared to a remarkable level. Our main check station, KA2OV, using an RME-69 receiver, has logged us at 72 db daily on 14-Mc. 'phone. J2MI has logged us consistently at S9<sup>+</sup> plus and up, with parallel reports from all DX contacts. In all respects we have found that the theoretical gain and other advantages are actually realized by a careful application of the theory to practice.

After a study of the conventional methods of matching and tuning it seemed obvious that to attain real efficiency the popular methods would have to be discarded, since this type of antenna tunes very sharply and the impedance at the center of the driven element is exceptionally low. Each experiment with coupling systems made it plainer that a different method of matching and tuning would have to be devised. The answer to the problem was link-coupling at all r.f. coupling points from final tank to the antenna. This was also found to be the most simple method in application, as the tuning is all controlled from one point and the links are operating without standing waves, thus eliminating all tendency toward undesired radiation.

\* 2300 Moss Ave., Los Angeles, Cal.

<sup>1</sup> N. C. Stavrou, "Simple Directional Arrays Using Half-Wave Elements," *QST*, May, 1938.

## Construction

Our antenna is mounted on a tower 43 feet in height, and is fed with EO-1 cable. The elements are spaced 6 feet, 6 inches. The radiators, Fig. 1, are made from the small size thin-walled electricians' conduit, which measures 11/16-inch outside diameter. This conduit is being used by many amateurs and has given universal satisfaction. It is fabricated in 10-foot lengths and sells for about 50 cents per length. Positive compression couplers are also furnished at about 10 cents each.

Six lengths of conduit are necessary. Two of these are halved and the halves joined to the remaining four 10-foot lengths by the compression couplers. These 15-foot lengths comprise the main side pieces of the antenna elements. The slip-on sleeves shown are made from thin-walled brass tubing of 3/4-inch inside diameter; 7 feet will be required. The whole length of tubing is split down the center by any convenient means. The split tube is then cut into one 3-foot length and two 2-foot lengths. The 3-foot piece joins the director section at the center and the 2-foot lengths form the tuning sleeves which slip over the inside ends of the driven section. As indicated in Fig. 1, four clamps are required to compress the sleeves against the radiator tubing. The clamps are made of 1/16- by 1-inch brass strip which is formed into a circle to fit the sleeves and compressed by small brass machine screws. These clamps should be sweated to the ends of the sleeves for the sake of convenience.

$L_1$ ,  $L_2$  and  $L_3$ , Fig. 2, are mounted on 3-inch Johnson ribbed standoff insulators. All coils are made of hard-drawn No. 10 enameled copper wire.  $L_1$  is 16 turns wound 2 1/2 inches in diameter and spaced 1/2 inch between turns.  $L_2$  is a one-turn link and  $L_3$  a two-turn link. The links fit around the center of  $L_1$ .  $L_2$  should fit in between

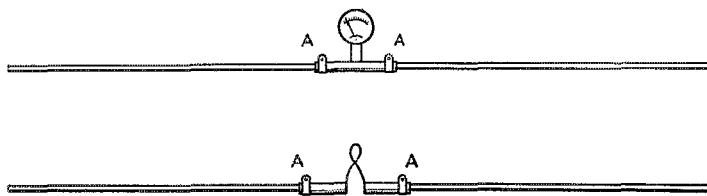

Fig. 1—Top-view of the antenna-director arrangement used by W6JYH. The elements are made of sections of electricians' conduit. Spacing is one-tenth wavelength.

the two turns of  $L_3$ , without touching. A slight air spacing is sufficient, as the center of  $L_1$  is the point of lowest voltage.  $C_1$ , Fig. 3, is composed of three rectangular aluminum plates 2 by 3 inches, spaced about  $\frac{3}{8}$  inch. It is mounted as indicated in the drawing, with provision for rotating the single plate for tuning purposes. The whole matching unit should occupy a space not over 6 by 8 inches, and should be housed in a weather-proof box about 6 by 8 by 8. The box should be mounted quite close to the center of the driven element, and  $L_2$  connected to it by short lengths of No. 10 wire. There should be about a 6-inch space between halves of the driven element.

### Tuning

The antenna is to be tuned entirely from the center, and therefore in mounting it on the tower or pole provision must be made for this purpose by a platform or other means of enabling the operator to reach the various controls. The tuning should be done after the antenna is in position on the tower, since the resonance point depends upon the height above ground.

After the whole array has been mounted, clip the leads of a thermogalvanometer across about 4 inches of tubing at the exact center of the parasitic element and leave it so placed until the tuning is completed. Next, couple the EO-1 cable to the final tank coil by a one- or two-turn link. The other end of the cable is then connected to  $L_3$ .

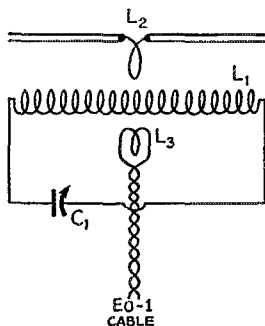

Fig. 2—The coupling system for transferring power to the antenna from an EO-1 transmission line. Constants and adjustment procedure are given in the text.

Apply reduced plate voltage to the final and tune the plate circuit to the usual plate-current dip, then vary  $C_1$  for resonance. If resonance cannot be obtained, vary the length of the driven-element halves by sliding the tubing in or out of the sleeves; the system should tune properly with the halves at approximately 16 feet each.<sup>2</sup> Resonance will be indicated by the highest reading of the thermogalvanometer, which remains clipped to the center of the parasitic element. Again have an assistant dip the final plate meter to resonance and then adjust the length of the parasitic antenna to obtain the highest reading of

<sup>2</sup> For a frequency of 14,208 kc.

After running into difficulties in applying the usual matching methods to the close-spaced antenna-director system, because of the very low value of impedance at the center of the driven element, the author found that the all-link coupled system described here gave him the desired match between a twisted-pair feeder and the antenna. The antenna itself can be rotatable, of course.

the thermogalvanometer; this will slightly detune the driven element and it must be again brought to resonance as described above. Next shorten the parasitic antenna to 32 feet 2 inches and clamp all sleeve tubes tightly. Retune the final tank, and then the antenna tank by a very slight movement of  $C_1$ .

Under these conditions the parasitic antenna functions as a director with a power gain of from



Fig. 3—The tuning condenser is simple to make and inexpensive as shown by this sketch.

5 to 6 db. As indicated by W2DFN, various other orders of power gain or front-to-back ratio can be obtained by further adjustment of the director length. These settings can be readily determined with the cooperation of a distant receiving station which has a receiver with an S-meter.

## Silent Keys

It is with deep regret that we record the passing of these amateurs:

Richard H. Fitch, W9YIF, Sturgis, S. Dak.  
Erland E. Hardy, W1DOZ, Farmington, Maine

Douglas Johnson, W9ASZ, Oak Park, Ill.  
Warren E. Munson, Jr., W2BKM, Scotia, N. Y.

G. Howard Noyes, W1ITC, Stonington, Maine

Paul Petersen, ex-W9DFG, Kansas City, Mo.

Reed E. Stoughton, W1GBD, Sebago Lake, Maine

Morgan C. Sweeney, W5GSF, Enid, Okla.  
Gordon E. Turner, W7CIK, Medford, Oregon

Here's the "QSL Forty" brought up to date. Many of our readers will remember the postcard-size transmitter described by W8QBW about a year ago in *QST*; it turned out to be an extremely popular set. But some of the equipment used in the original no longer is available, hence this "modernized" version. And it costs even less to build — \$15 complete, with 40 watts on 3 bands.

SINCE the "QSL Forty" was described in *QST* about a year ago,<sup>1</sup> some of the components — namely, the transformer and choke — have become difficult to secure, so the present rig was designed to make use of standard parts carried in stock by nearly all supply houses. The result is a simplified and lower-cost transmitter, with an output of 40 watts on 80 and 40 meters and slightly less on 20 meters.

The 6L6G crystal oscillator, with its power supply, is mounted on a chassis  $4\frac{1}{2}$  by  $8\frac{1}{2}$  inches. The cost of the complete transmitter and power supply, using all new parts, is \$15. A constructor who has usable parts on hand can reduce this materially. For example, if he has a crystal, 6L6G and 83 tubes and a midget variable, the outlay drops to about \$8 so that in either case the rig, it would seem, quite justifies its name.

The photographs show mounted on top of the chassis the transformer, the 6L6G and 83 tubes, the crystal and its pilot bulb, and the coil. In front are the plate-condenser knob and the pilot-bulb plate-current indicator. This is protected by a bakelite disc. The nuts shown hold the socket assembly to the chassis and so are not alive. "No metal can touch you"; at least none that is "hot." The little square of aluminum covers up an error of judgment and has no functional value; excuse it, please. At the rear is the

\* 1000 Kensington Road, Grosse Pointe, Mich.

<sup>1</sup> Sutter, "The QSL Forty," *QST*, February, 1938. See also p. 48, *QST*, March, 1938.

<sup>2</sup> Sutter, "What, No Meters?" *QST*, October, 1938. See also p. 62, *QST*, March, 1939.

# The "Economy Forty"

An Inexpensive Three-Band

C.W. Transmitter

BY FRED SUTTER,\* W8QBW-QDK

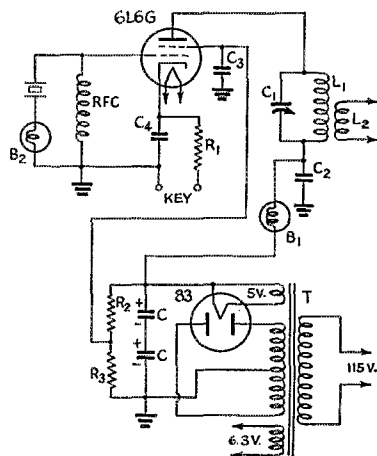

Fig. 1 — Circuit diagram of the "Economy Forty."

- C — 20- $\mu$ d., 450-volt electrolytic (Solar Minicap).
- C<sub>1</sub> — 100- $\mu$ d. variable (Hammarlund MC-100-S).
- C<sub>2</sub>, C<sub>3</sub> — 0.01- $\mu$ d. paper, 1000-volt.
- C<sub>4</sub> — 0.01- $\mu$ d. paper, 600-volt.
- R<sub>1</sub> — 200 ohms, 10-watt.
- R<sub>2</sub> — 3000 ohms, 10-watt.
- R<sub>3</sub> — 25,000 ohms, 20-watt.
- B<sub>1</sub> — No. 46 blue-bead pilot bulb.
- B<sub>2</sub> — No. 40 tan-bead pilot bulb.
- RFC — 2.1-mh. r.f. choke (National R-100).
- T — Power transformer, 400 v. each side c.t.; 6.3- and 5-volt windings (Thordarson T13R16).
- L<sub>1</sub>, L<sub>2</sub> — see text.

divider resistor,  $R_2$ ,  $R_3$ , mounted on a feed-through insulator and a grounded screw. Also on the rear edge are the feed-throughs for taking off the screen voltage, the 110-volt leads and the feed-through and ground screw for the key. The under-chassis view shows the two 20- $\mu$ d. electrolytics, C-C, connected in series and held by an aluminum strip bent to shape, also the three

The filter condensers are held by the bracket at the left, mounted on the side of the chassis. Note the bakelite mountings for the plate-current bulb and the tuning condenser; both must be insulated from the chassis.

QST for

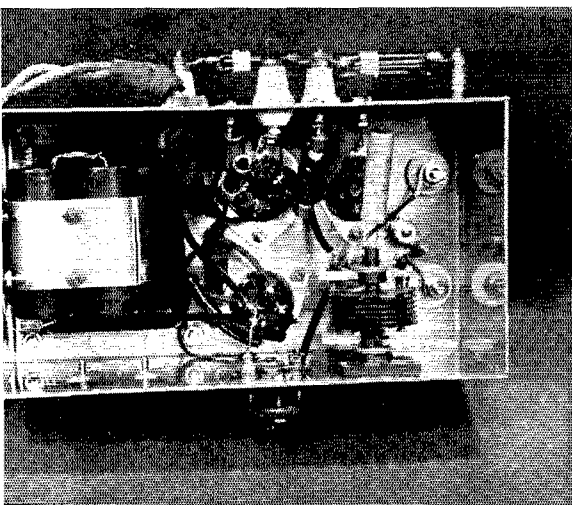

The "Economy Forty" is inexpensive, compact, and delivers 40 watts to the antenna. It can be used on three bands, 3.5, 7 and 14 Mc., for c.w. work. The pilot bulbs are used to indicate crystal current and plate current.

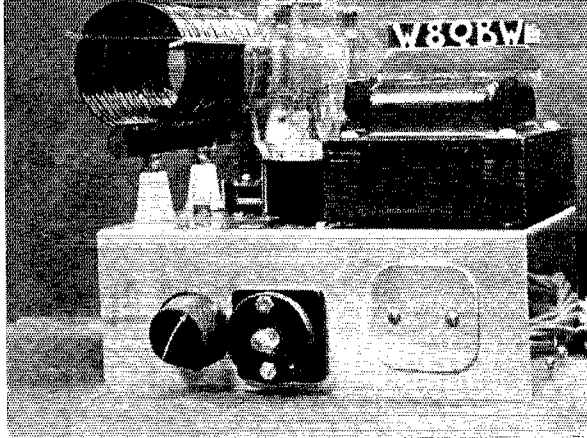

paper tubulars  $C_2$ ,  $C_3$ ,  $C_4$ , the 200-ohm resistor  $R_1$ , the r.f. choke and the midget variable  $C_1$ .

### Transmitter Circuit

The transmitter circuit is that of the "QSL Forty" except that  $C_2$ ,  $C_3$  and  $C_4$  are 0.01  $\mu$ fd. and so easier to obtain. The plate meter has been replaced by a No. 46 blue-bead pilot bulb in the interests of space saving, lower cost and simplicity. If you wish actually to measure the plate current, this may be done easily by unscrewing the No. 46 bulb and clipping on milliammeter leads to the socket lugs. Once you have observed the filament color of the No. 46 at 160 to 170 ma. plate current you will have no further use for a plate meter. The No. 46 bulb is at its full (dazzling) brilliancy at 250 ma., and will show a good bright white (not dazzling) at 200 ma. At normal plate current of 160 to 170 ma. it runs white, just past the yellow stage. Now, if you use pilot bulbs also for your antenna tuning, as described in October *QST*<sup>2</sup>, the tuning procedure is simply to adjust so that the antenna bulb (or bulbs) are brightest while the plate bulb is dimmest.

On 20 meters there may be found a very slight chirp, although it is hardly fair to call it that for only occasionally will your report be plain T9; generally you will draw the usual T9X. Tune for slightly *more* than lowest plate current when on 20 meters. If you can listen to the signal in your receiver or a monitor you can readily determine the plate condenser adjustment which will eliminate the chirp.

### Power Supply

I will admit that I had some doubts about this power supply, which consists only of a transformer, a 10- $\mu$ fd. condenser (two 20- $\mu$ fd. electrolytic units in series) and a dividing resistor. Before writing this story, therefore, the job was given a good work-out on the air and found perfectly satisfactory. Invariably reports were T9X, but since reports are so often figured on the basis of not hurting your feelings rather than on the basis of accuracy, each contact was asked to report again, frankly, on the quality of the signal. The opinion was unanimous that the note was pure d.c., no ripple, no clicks, or words to that effect. Some of the first filters tried used only 4  $\mu$ fd. and showed a slight ripple, but raising the capacity to 10  $\mu$ fd. eliminated this. Any contacts that reported on those first filters and who read this will understand that I am not now describing the rig which they heard.

The transformer delivers 400/400 volts a.c. to the plates of the 83 tube, and after filtering the d.c. voltage is close to 500 volts. The plate voltage, under normal load, will be about 440 volts. The screen voltage will be about 330 volts with load. *Don't* sit on the key. This is a c.w. transmitter and is fully capable of doing its stuff. It is *not* a power house, though, so don't try running it key-down except for the brief tuning periods.

### Dummy Antenna

The sketch shows the simple dummy antenna used at W8QBW. It is merely a Mazda lamp, with a variable condenser across the terminals, clipped to the terminals of  $L_2$ . Should the capacity prove inadequate a small mica unit can be added in parallel. The 80-meter coil specified will light such a 40-watt dummy to full brilliancy. Some coils will deliver energy equally well to the antenna and to such a dummy while other coils, although satisfactory on the antenna, do not transfer maximum energy to the dummy. A 40-meter coil wound as follows will light a 40-watt Mazda fully:  $L_1$ , 12 turns of No. 12 enameled, 2 $\frac{1}{4}$  inches diameter, 2 inches long;  $L_2$ , 6 $\frac{1}{2}$  turns of No. 12 enameled, 2 $\frac{1}{4}$  inches diameter and 1 inch long.

### Coils

There is considerable latitude in the matter of coil constants and you may wish to experiment to determine what is "best" under your par-

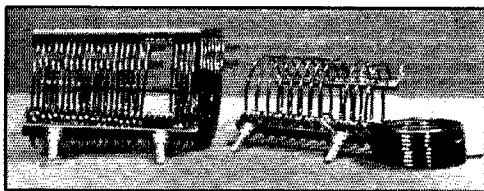

Coils, under way and completed. The loose coil at the right is ready for threading on the drilled bakelite strips. The coil at the left is partly assembled, while a completed coil is shown in the center.

ticular conditions. The coils specified may be taken as a starter at least. Don't let the "commercial" appearance of this type of coil lead you to think that it is difficult to make. In reality these spaced-turn coils are easy to construct, are efficient and cheap. The process merely involves sawing out some little bakelite strips, drilling a row of holes in them (make a template), winding some wire tightly on a can or tube of appropriate size and then threading the strips on the coil thus formed. A roll of stiff paper thrust through the coil axially will hold things snug while you apply cement to the holes and it is hardening.

The bottom strip should be  $\frac{1}{4}$  or  $\frac{5}{16}$  inch thick to take the 6-32 tapped holes for the banana plugs,

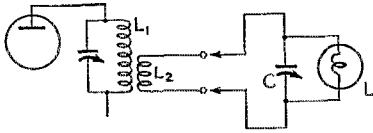

Fig. 2 — The dummy antenna circuit, using an ordinary 40-watt electric-light bulb. Adjustment is described in the text.

which should be fitted, of course, before threading the coil. The ends of  $L_1$  are formed into little loops (flatten them) for the shanks of the plugs. The ends of  $L_2$  also are formed into little loops for handy attachment of the antenna feeder leads. When drilling the holes don't shove the drill right on through — back up the strip with a bit of steel and finish the holes from the other side and so avoid bad breaking out between holes. Countersink the holes so as to provide good "pockets" for the cement. It is all much simpler to do than to describe.

The photograph shows, at the right, a 20-meter coil just removed from the can. To the left of this is a 20-meter coil completely assembled, and to the left again is a 40-meter coil partly finished; the coil  $L_1$  is already threaded through the holes in the strips, and  $L_2$  is partly threaded. Suggested coil dimensions are as follows:

### 80 METERS

$L_1$ , 21 turns of No. 14 enameled, diameter  $2\frac{1}{8}$  inches, length  $2\frac{3}{4}$  inches, holes spaced  $\frac{1}{8}$  inch between centers. Use No. 44 drill.

$L_2$ ,  $6\frac{1}{2}$  turns, same wire, diameter and spacing as  $L_1$ .

Inductance of coil  $L_1$  is about 22 microhenrys.

### 40 METERS

$L_1$ , 18 turns of No. 14 enameled, diameter  $2\frac{1}{8}$  inches, length  $2\frac{1}{8}$  inches, holes spaced  $\frac{1}{8}$  inch between centers. Use a No. 44 drill.

$L_2$ ,  $7\frac{1}{8}$  turns same wire, diameter and spacing as  $L_1$ .

Inductance of coil  $L_1$  is about 14.7 microhenrys.

### 20 METERS

$L_1$ , 8 turns of No. 14 enameled, diameter  $1\frac{7}{8}$  inches, length  $1\frac{3}{4}$  inches, holes spaced  $\frac{1}{4}$  inch between centers. Use a No. 44 drill.

$L_2$ , 3 turns same wire, diameter and spacing as  $L_1$ .

Inductance of coil  $L_1$  is about 2.0 microhenrys.

If you wish to try coils of different inductances from the above they may be figured readily from the formula:

$$L (\mu h) = \frac{0.2 A^2 N^2}{3A + 9B}$$

where  $A$  is the diameter,  $B$  the length (both in inches), and  $N$  the number of turns.

Coils for 80 meters may be 18 to 22  $\mu h.$ , 40-meter coils from  $12\frac{1}{2}$  to  $15\frac{1}{2}$   $\mu h.$ , and 20-meter coils from 1.6 to 2.0  $\mu h.$ , for practicable operation.

The No. 14 enameled magnet wire specified is soft and makes up nicely into coils that will not spring more than about a quarter-inch when removed from the can. Select a can that is about  $\frac{1}{4}$  inch smaller than the finished coil diameter. Punch a small hole at one end, hook the wire into the hole, hold the far end in a vise and wind the wire on the can close and tight, using a strong even tension, as you walk up to it.

Coil  $L_1$  will start and finish at the bottom strip and  $L_2$  will start and finish at the top strip or strips. If two strips only are used, as with small coils,  $L_2$  will have a whole number of turns, as 3 or 6. If three strips are used then  $L_2$  will have a whole number plus  $\frac{1}{3}$  turn, as  $6\frac{1}{3}$ . A variation of a sixteenth of an inch in the diameter of the coil does not matter materially. A half-pound of wire will make several coils.

### Bakelite

You will need two pieces of bakelite about  $1\frac{3}{4}$  inches square for the plate pilot-bulb socket, also some strips  $\frac{3}{8}$  inch or  $\frac{1}{2}$  inch wide and  $\frac{1}{8}$  inch or  $\frac{5}{16}$  inch thick; about a foot or two of these. For the bottom coil strip get a foot or so of  $\frac{5}{8}$ - or  $\frac{3}{4}$ -inch wide by  $\frac{1}{4}$ - or  $\frac{5}{16}$ -inch thick bakelite. Nearly every supply house has a barrel full of scrap bakelite consisting of all kinds of little bits and narrow strips. If you explain what you want when you order parts you can probably get this for a few cents or gratis.

### Crystals

A crystal and coil is needed for each band you wish to operate on. Changing bands takes but a few seconds — not that this is of any importance, however. Just turn off the power, lift out the crystal and coil, plug in the appropriate ones and tune up. The cost of an extra crystal is not really an extra expense because if you try to "save" this by using some circuit involving doubling or quadrupling you will be out just as much or more and may end up with a more compli-

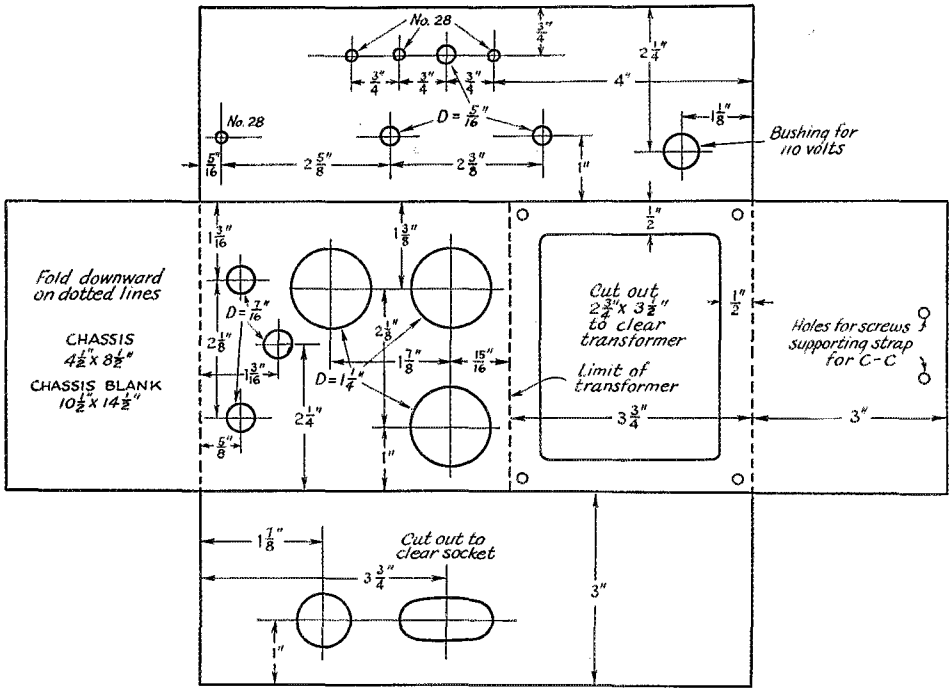

Fig. 3 — Chassis layout template.

ated rig which may give only 10 or 15 watts output.

The crystal current on 80 meters is so low that it will not light the No. 40 tan bead pilot bulb in the crystal circuit. On 40 meters the bulb will show dull yellow and on 20 it burns white but not full. No. 40 at full dazzling brilliancy draws 150 ma. Here at WSQBW we have never lost a crystal and have used the same 6L6G tube for two years on 40 watts output, and are now starting it out on its third year at 60 watts output with 600 volts on the plate. But that will have to be another story.

#### Divider Resistor

The divider consists of a 25,000-ohm, 20-watt unit in series with a 3000-ohm, 10-watt, the screen voltage being taken off the junction. It is mounted on the rear apron of the chassis where it gets free circulation of air. Never put a hard working resistor under the chassis because the considerable heat radiated is apt to fry out the dope from condensers and transformer. It will also heat up the top of chassis and incidentally the crystal, so causing extra frequency drift. The "B"-plus end of the divider is the feed-through partly hidden by the 110-volt leads, and the "B"-minus is the mounting screw at the right. The junction between the 3000-ohm and 25,000-ohm sections is the middle feed-through.

#### Chassis

It seems that the chassis is often something of a problem to many constructors. If you are handy to a machinery supply house you can get No. 16 gauge aluminum in sheets 12 inches wide by any length for about 52 cents per pound. A piece 12 inches wide by 14 1/2 inches long for this chassis costs about 37 cents from such a source. However, any tin shop or roofer can furnish a piece of terneplate or heavy galvanized for a few cents. Some radio supply dealers list cadmium-plated chassis 5 by 9 1/2 by 3 inches, which will serve nicely for this rig.

Anyhow, half the fun of radio is doing nice construction. Haywire and sloppy arrangements offer real hazards, fire and personal, so avoid them and live a longer and happier life. Put a red bulb across your 115-volt leads and don't touch a thing while that light is burning. And on this cautionary note the story will close.

## Oregon State Convention

(N. W. Division)

Date: April 22nd-23rd.

Place: Eugene, Oregon.

Hotel: Osborne Hotel.

Auspices Oregon Amateur Radio Association.

Admission Fee: \$3.00.

# A "Double-Barrelled" Antenna System

## Simplified Flat-Line Feeding for a Two-Band Antenna

BY L. M. SWIFT,\* W5FDQ

AND slide the feeders up and down the stub until a match is obtained." But — did you ever climb up and down from the roof-top, letting down the antenna, pulling it up again, chasing standing waves, and wondering if that match is a match? If so, you know it's not as simple as it sounds.

Usually the next step is to go to an impedance-matching transformer such as the well-known "Q" system. They are calculated in advance; you cut 'em to length, put 'em up and they work — for the single band for which they are cut. But here at W5FDQ we want to operate on 20 and 10 with reasonably quick band-change. We like untuned-line feed, and we have a natural prejudice against two antennas as closely spaced as our small back-yard dictates. Furthermore, cost is a major factor here as elsewhere. We have used the familiar single-wire-feed with fair success, but r.f. feed-back usually shows up on 'phone, and 'phone constitutes a major part of our activity. However, the following line of reasoning produced a feed system that operates equally well on 10 and 20, with absolutely no change necessary when changing bands.

If an antenna is to operate as a center-fed half-wave flat-top on its fundamental, then it automatically becomes two collinear half-waves in phase on the second harmonic. The impedance at the center of a half-wave flat-top is known to be about 72 ohms. The impedance at the center of the two half-waves in phase is not as well established, but it is probably on the order of 2400 ohms. (This assumption is fairly well borne out in practice.)

When the antenna is operating as a half wave (Fig. 1-A), the stub is a quarter-wave long, and the voltage on the stub will be a maximum at the "B" or open end of the stub and a minimum at "A," where the stub joins the antenna. When the antenna is operating as a full wave (Fig. 1-B), the

stub is a half-wave long, and the voltage will be a maximum at A and B and a minimum at C, the midpoint. A point D, one-third the stub-length from A, is one-sixth of a wavelength from a voltage loop (B) when working on the fundamental, and also one-sixth of a wave-length from a voltage loop (A) when working on the second harmonic.

When working on the second harmonic, the voltage at point D will be one-half that at A or B. The impedance will be one-fourth the end impedance, or 600 ohms, and a 600-ohm line could be connected at this point to feed the system. On the fundamental, the same point will show 600 ohms if the stub has a characteristic impedance of 416 ohms ( $\sqrt{72 \times 2400}$ ). Since it is entirely practical to build a 416-ohm line, this gives a practical method of feeding a center-fed half-

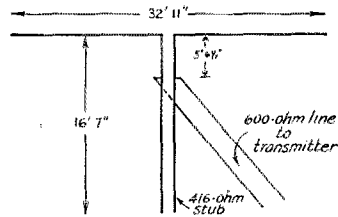

Fig. 2 — A practical 14- and 28-Mc. antenna fed by an untuned line on both bands. The 416-ohm line is made of two No. 10 wires spaced 1.65 inches.

wave antenna with a flat line on either the fundamental or the second harmonic.

In practice, the 416-ohm stub was made with No. 10 wire spaced 1.65 inches. Since no spreaders of this spacing were available when the stub was built, they were made from celluloid knitting needles cut to length and drilled so they could be slipped over the wire and tied in place. No trouble has been experienced with losses in the line, and any good insulating material should be satisfac-

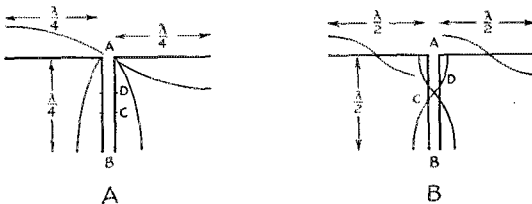

Fig. 1 — The voltage distribution on a center-fed doublet with quarter-wave matching stub. A point "D," one-third of the stub length from the antenna, is one-sixth wavelength from a current loop on both the fundamental and second-harmonic frequencies.

\* Engineering Laboratories, Inc., Tulsa, Okla



tory. The 600-ohm line is standard, and may be coupled to the transmitter in your pet manner.

The antenna system with which this feed method has been used is shown in Fig. 2. It is cut for 14.2 Mc., which makes the flat top 32 feet 11 inches long. The stub, being of fairly low impedance for such construction, is cut to 0.96 of a full quarter-wave, or 16 feet 7 inches. The antenna resonates on its harmonic at about 29 Mc. (not 28.4 Mc.) because of the familiar end effects. However, it is not critical as to frequency, and operates satisfactorily over the entire bands.

One word of caution. Don't "slide the feeders up and down the stub." Tie them to a point one-third the length of the stub from the antenna and leave them alone. They will work there — and that's the only place they will.

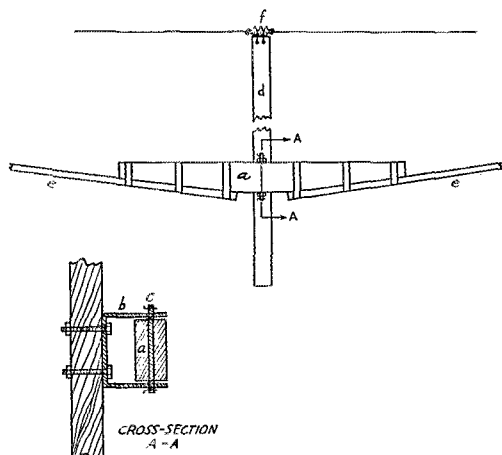

Fig. 3—Constructional details of the antenna support. The structure is greatly simplified by the necessity for only 90° rotation.

### Rotating the Antenna

Since early tests with the antenna showed considerable broadside directivity, particularly on the harmonic, it was apparent that provision should be made for rotation. Further, the weight of the stub and feeders causes considerable sag when the antenna is supported between two towers, reducing the effective height and making a center support desirable. Because the antenna is bi-directional and the "nose" is rather broad, rotation of about 90° is all that is necessary for good general coverage. Accordingly, the following "bow and arrow" mount was devised.

A piece of "two-by-four" ("a," Fig. 3) about 3 feet long was cut and tapered at the ends as shown. A U-bracket "b" was bent of 3/16-by-1-inch strap iron, and piece "a" was pivoted between the arms of the U by a 3/8-inch brass rod "c," which was held in place by cotter-pins, as shown. Sufficient clearance was left to allow "a" to swing about 90 degrees or more in its mount.

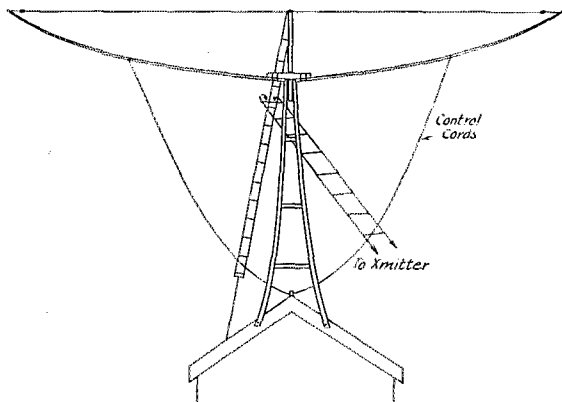

Fig. 4—The complete installation shows how the entire height of the support is utilized in the "bow and arrow" construction. The position of the antenna is changing by means of two control cords.

The bracket "b" was securely bolted to a 5-foot length of two-by-two "d," about 1 foot from the lower end.

Two 24-foot cane poles were purchased at the local hardware store for a total of 50 cents. The tips of these were cut off, leaving a length of 18 feet each. The large ends of these were strapped to the lower sloping edges of "a," as shown. (Half-inch sheet iron straps, as found on shipping crates, nailed to "a" and stretched tightly around the poles, did a good job at W5EGQ; wire was used here.) An ordinary 2-inch antenna insulator "f" was fastened rigidly to the top of "d" by means of wires through holes in the two-by-two and around the body of the insulator. The flat-top was strung between this insulator and the tips of the cane poles, just like stringing a huge bow. The 416-ohm stub was strung from "f" to a convenient point near the base of the supporting tower, with the 600-ohm line tapped on at the proper point, as previously described. The insulator "f" does not move when the antenna is turned, so that there is no twisting of the stub or feeders, and they may be stretched as tightly as desirable.

The two-by-two "d" was bolted to the top of a 16-foot A frame, made of a split two-by-four

(Continued on page 102)

The merit of flat (untuned) lines for feeding antennas is unquestioned, but the widespread use of such systems has been delayed by the fact that, except for terminated rhombics and single-wired fed antennas, their use was confined to one band. W5FDQ takes us a step in the right direction by showing how two-wire flat lines can be used on two bands.

---

# ★ WHAT THE LEAGUE IS DOING ★

---

## NEW RADIO LEGISLATION?

SEVERAL bills have been introduced in the Congress to reorganize the F.C.C. The first of these is an Administration measure, S. 1268, introduced in the Senate in early February by Senator Wheeler after the way had been paved by letters from President Roosevelt. In mid-month the same bill was introduced in the House by Representative Lea. These bills would reduce the Commission to a board of three men, who would delegate all normal administrative work to three sections of the Commission presided over by administrative officers appointed by them. Countering this move to reduce the size of the Commission, Senator White later in the month introduced another White bill, S. 1520, which would increase the Commission to eleven men, one an executive chairman and five assigned to each of two autonomous divisions, one for broadcasting and one for common carriers. The full commission would allocate frequencies to all radio services and would handle the non-public radio services such as amateurs and police.

The examination of these bills by Congress, amateurs should note, is going to be done in a highly political atmosphere. Most of the politics will revolve about broadcasting, because next year is election year and broadcasting plays an important part in that story. There are going to be long and bitter wrangles, investigations, counter-attacks. The political atmosphere will not be conducive to sober examination of facts, and things will not be what they appear. The situation at the moment of writing is highly uncertain. Hearings are expected to begin in the Senate in early April, but current Washington opinion is that action at this session of Congress is quite unlikely. The League is on the job, keeping a very watchful eye on the proceedings, and will do whatever proves to be necessary or advantageous to protect amateur rights. At this writing, the issues are too confused to warrant an opinion, but A.R.R.L. will be ready when it becomes apparent what the program is to be.

## LICENSING

THERE has been a rumor that, because of war scares, F.C.C. has held up all amateur renewals. This is without foundation. There is greater delay than usual in issuing licenses, because they have run behind during this busy season, but there is no interruption of amateur licensing.

In February F.C.C. announced that the total

of licensed amateur operators in the United States exceeded 51,000.

## 7-MC. 'PHONE QRM

THE terrible interference from Cuban 'phones at the low end of our 7-Mc. band has not yet been cured by the Inter-American Arrangement of Habana. The reason is that the government of Cuba has not yet accepted the Inter-American Arrangement and ordered it into effect as concerns its amateur licensees. The cause for this, in turn, rests indirectly upon a broadcasting matter that has caused some international confusion. Government officials hope to get the matter straightened out soon.

## BOARD MEETING

THE A.R.R.L. Board of Directors has its annual meeting in San Francisco in early May. The alternate directors of the League are to be permitted to attend, as non-participating observers, at their own expense. The agenda for the meeting, so far as they are then known, will be published in our next issue. Watch for it.

## SIGNING LOGS

OUR new regulations require that persons other than the licensee shall sign the station log when they speak over the station microphone. Some amateurs have asked us to what extent this rule applies in cases where the signals of other amateur 'phone stations are being retransmitted. The answer is that the requirement to sign the log applies only at the originating amateur station where the other person is doing the talking over the microphone. However, amateurs retransmitting the signals of another amateur station should make a log entry covering the period of the transmission and indicating in the log the name of the person speaking at the originating station. This information would then be on record in case some question arose concerning the operation of the relay station. . . . In cases where the person speaking is at the far end of a private telephone circuit connected to the amateur station, and not personally present in the station to sign the log, our best advice is that the operator should log the person's name with a brief statement of the circumstances.

**"DUPLEX"**

WE HEAR fellows saying that Section 152.43 of our new regs prohibits duplex working. Apparently there is an awful lot of confusion about what duplex means. If some hams' version of duplex necessitates leaving the carrier on unmodulated, then it is true that the effect of the reg would be to stop it. But voice-operated relays, or any other device that turns on the carrier only while one is talking, would escape this criticism and still provide what hams mean when they speak of duplex. The carrier doesn't have to be on continuously to provide "duplex." The rule itself, we would point out, relates solely to the business of leaving the carrier on when it is not being modulated for communication — the regulations don't say a thing about "duplex" one way or the other.

Incidentally, we can't get around this reg by jacking up the gain on our speech equipment so the loud-speakered reception of the other fellow goes out over the air at "normal" volume. F.C.C. has cited a number of stations for this attempt at evasion, on the basis that such modulation is not for communication purposes.

-----

**FINANCIAL STATEMENT**

THE business affairs of the League yielded a good report for the fourth quarter of 1938, with a gain from normal operations of nearly \$8000 before disbursements against appropriations. As we entered that quarter about even, that is also the approximate size of the year's net gain. By order of the Board, the figures are here published for your information:

**STATEMENT OF REVENUE AND EXPENSES, EXCLUSIVE OF EXPENDITURES CHARGED TO APPROPRIATIONS, FOR THE THREE MONTHS ENDED DECEMBER 31, 1938**

REVENUES		
Membership dues.....	\$19,548.40	
Advertising sales, QST.....	21,656.39	
Advertising sales, Handbook....	6,803.09	
Advertising sales, booklets.....	400.00	
Newsdealer sales, QST.....	10,979.53	
Handbook sales.....	21,933.46	
Spanish edition Handbook revenues.....	68.50	
Booklet sales.....	3,506.76	
Calculator sales.....	336.85	
Membership supplies sales.....	2,875.14	
Interest earned.....	418.45	
Profit on sale of bonds.....	219.00	
Cash discounts received.....	262.53	
Bad debts recovered.....	9.51	\$89,017.61
<i>Deduct:</i>		
Returns and allowances.....	\$ 2,899.90	
Exchange and collection charges..	23.68	
Cash discounts allowed.....	489.08	
Increase in reserve for newsdealer returns of QST.....	139.60	3,552.26
Net Revenues.....		\$85,465.35

EXPENSES		
Publication expenses, QST.....	\$16,877.23	
Publication expenses, Handbook..	18,983.37	
Publication expenses, booklets...	1,407.57	
Publication expenses, calculators.	317.17	
Spanish edition Handbook expenses.....	45.00	
Salaries.....	26,181.46	
Membership supplies expenses...	1,690.76	
Postage.....	2,397.73	
Office supplies and printing.....	1,644.30	
Travel expenses, business.....	924.28	
Travel expenses, contact.....	140.57	
QST forwarding expenses.....	1,044.85	
Telephone and telegraph.....	646.53	
General expenses.....	1,280.52	
Insurance.....	41.20	
Rent, light and heat.....	1,140.25	
General Counsel expenses.....	767.68	
Communications Department field expenses.....	152.19	
Headquarters stations expenses..	558.30	
Alterations and repairs expenses..	186.42	
World's Fair exhibit expenses....	15.00	
Bad debts charged off.....	608.87	
Provision for depreciation:		
Furniture and equipment.....	301.07	
Headquarters station.....	402.80	
Total Expenses.....		77,760.12
Net gain before expenditures against appropriations.....		\$ 7,705.23

★ **NEW TUBES** ★

*New "Bantam" Receiving Tubes*

THE following types are now available in the recently announced "bantam" series of receiving tubes: 6A8GT, 6F5GT, 6J57GT, 6K6GT, 6K7GT, 6Q7GT, 6V6GT, 6X5GT whose operating characteristics correspond to similarly numbered tubes in the standard "G" series. Several types, designed primarily for a.c.-d.c. use, are also available with higher-voltage heaters. These include the 12A8GT, 12F5GT, 12J5GT, 12J7GT, 12Q7GT, 25L6GT, 25Z5GT, 35L6GT, 35Z4GT and 50L6GT. The 50L6GT is similar to the 25L6GT, except for heater requirements, but the 35L6 requires a slightly higher load resistance (2500 ohms) and has a lower output rating (1.5 watts). The 35Z4 is a high-vacuum half-wave rectifier with a maximum r.m.s. plate-voltage rating of 250 (when used with a 100-ohm series resistor) and maximum d.c. output-current rating of 100 ma. All heaters in this series operate at a current of 0.15 ampere with the exception of the 25L6GT which draws 0.3 ampere.

*New Single-End Tubes*

Two new types have been added to the 6.3-volt series of single-end metal tubes. The

(Continued on page 116)

# Checking Beam Antennas with the S-Meter

## Converting Meter Readings to Decibels for Signal-Strength Comparisons

BY S. GORDON TAYLOR,\* W2JCR

THE "S" meters now so commonly employed in communications-type receivers are valuable primarily as an aid in giving uniform signal strength reports, and in the constant check on the operating condition of the receiver. But with the growing use of rotary beams for transmitting and receiving such meter equipment is finding a new and important application in checking the radiation characteristics, and even in plotting radiation patterns.

Many hams recognize the possibilities in this latter application but fail to take advantage of it because they (1) are unfamiliar with the procedure, (2) are reluctant to undertake the calculations ordinarily involved, or (3) lack data from receiver manufacturers which permits variations in S readings to be interpreted in terms of decibels, power ratios or voltage ratios.

It is the purpose of this article to provide data on a number of standard receivers, describe simple methods of checking characteristics and plotting patterns of rotary beams, and provide a chart which reduces calculations to a matter of simple arithmetic — with not an awful lot of that.

If you have a rotary beam and ask different stations for checks, the results will normally be of only the most general value because for the most part these reports will be given in terms of the number of S points difference between your minimum and maximum signal. A three-S dif-

ference on one standard receiver may, in terms of power ratios, equal a difference of five S's on another receiver, four S's on a third, and so on. For this reason the S reports from different receivers are not directly comparable, and it is impossible to arrive at any sort of average suitable for use in plotting antenna characteristics.

Nor can this problem be solved by arbitrarily assuming some standard db value per S point, a practice which is quite common. Measurements show that the "db per S" may average anywhere from 3 to 6 on different standard receivers. This is another way of saying that with one receiver model S9 may be around 50 db "up" from S1 while in another model it may be only 25 db up. What is more, the db difference between S3 and S4, for instance, may be quite different from that between S8 and S9 on the same receiver and S meter.

What is needed is knowledge of the actual db calibration of the S meters for the different receiver models, and this data will be found in Fig. 1 for nine standard receivers. The data on which this chart is based was obtained from the individual manufacturers, for this purpose (or from their literature in some cases), and most of it appears in print here for the first time.

The utility of this chart is obvious. It serves to provide a useful calibration for owners of any of these receivers. Of equal importance, it enables the ham to interpret, in terms of db, the

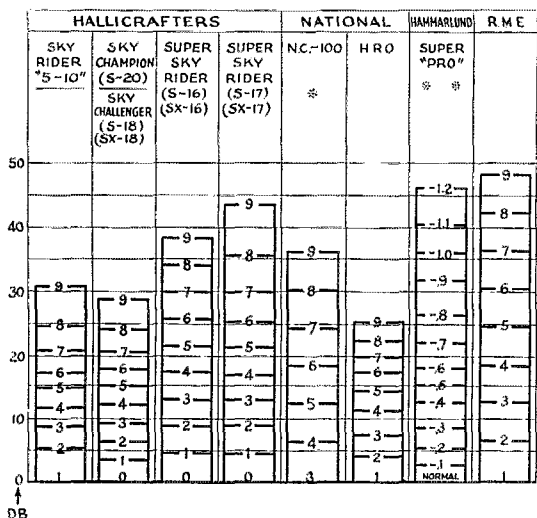

Fig. 1 — S-meter calibrations of various receivers in terms of decibels. The S scales are arbitrarily chosen by the manufacturers, hence the wide variation in "db per S point." All values are relative to the lowest S-scale reading on the receiver, and are independent of the receiver sensitivity. That is, the fact that, in this chart, one receiver may show a reading of S7 while another shows S4 for the same db value above does not mean that the signal input would be the same in both cases.

\* The NC-100 utilizes an electric eye in conjunction with the r.f. gain control, which has a 0-10 scale. With a signal tuned in the gain control is backed off until the signal barely registers on the eye, then the S reading is taken from a curve plotted in terms of gain-control settings. The combination is therefore the equivalent of a meter.

\*\* The Super-Pro meter is not calibrated in S-points but instead has a 0-5-milliamper scale. With the antenna disconnected and no signal tuned in this will read somewhere around 4. As signals are tuned in the reading drops and it is the amount of this drop from the normal no-signal level that appears in the figure. Thus if the normal level is 4.1 and a signal drops it to 3.6, then that signal is 15 db above the "zero" level, etc.

With rotary beams sprouting like mushrooms, the receiver S-meter takes on a new importance in furnishing a means for giving information on radiation patterns — provided its readings can be reduced to some standard. The important thing, of course, is the relative signal strength, easily expressible in terms of decibels. Since no two receiver S-point calibrations are alike, the information in this article is particularly timely and useful, and gives the beam owner a means of correlating signal reports.

comparative reports received from others who are using any of these receivers.

Perhaps your receiver has a meter which you installed yourself and on which you scaled off your version of the S scale. In that case you can obtain the decibel calibration by comparing your readings on given signals with those of a friend who owns one of the receivers of Fig. 1. This comparison must of course be made with the two receivers in the same location and switching the same antenna. It will be most simple if you calibrate your meter to correspond with the S scale of the other; then its decibel calibration as given in Fig. 1 will apply to yours also.

It is perhaps well to point out that the varying heights of the columns in Fig. 1 have nothing to do with the relative sensitivity of the different receivers. In each case the column height simply represents the relative values which each receiver manufacturer chooses to employ in designing and calibrating his S meter circuit, and it is obvious that the different scales are not in agreement. The fact that some calibrations start at S° and others at S1 is of no importance; this again simply represents the manufacturer's choice of zero db

**TABLE I—TYPICAL BEAM-PATTERN WORK SHEET**

Direction of Beam	S's	Db Above S°	Db Above Min. Sig.	Power Ratios
NE.....	9.1	45	30	1000
ENE.....	8.9	42.5	27.5	560
E.....	8.6	40	25	300
ESE.....	8.5	39	24	250
SE.....	8.1	36	21	130
SSE.....	7.5	33	18	64
S.....	6.5	27	12	16
SSW.....	7.1	30	15	32
SW.....	7.4	32	17	50
WSW.....	5.6	23	8	6.5
W.....	3.7	15	0	1
WNW.....	4.6	19	4	2.5
NW.....	7.2	31	16	41
NNW.....	8.5	39	24	260
N.....	8.8	41.5	26.5	450
NNE.....	9.0	43.5	28.5	700

level but does not in any way alter the utility of the db data of this chart.

When the owner of a rotary beam receives reports on his front-to-back ratio in terms of decibels these reports from different stations can be directly compared with a far greater degree of accuracy than would be the case were the reports simply given in S points. For example, suppose two receiving stations gave him reports. One, equipped with a "Sky Challenger" receiver reports readings of S9 for the front and S3 for the back. The other, using an "NC-100" reports S9 for the front and S6 for the back. On the basis of straight reports (without the data of Fig. 1) it would appear that the signal variation as observed at the first station is twice as great as at the second. Convert both to decibels, however, and the reports are nearly the same — 19½ db and 18 db respectively.

**A Translation Scale**

Fig. 2 provides another tool of great value in checking beams and plotting radiation patterns. Here the decibel scale again appears, and related directly to it are power- and voltage-ratio scales. In the last column is the S scale of the Sky rider SX-17, which happens to be the receiver used at W2JCR. Those having other receivers should substitute the appropriate S scale.

To illustrate the use of the chart, assume that a

Fig. 2 — Voltage, power and db scales for quick conversion. The S scale of the receiver in use may be plotted as shown in the right-hand column so that reports can be given readily in terms of db gain or loss.

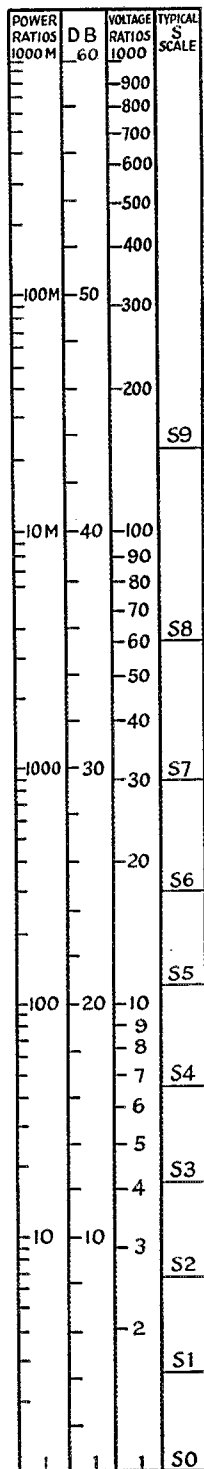

rotary beam is being checked. "On the nose" a reading of S5 is obtained and off the back end the reading is S5. The db equivalents taken from column 2 are 36 and 21 and the difference is 15 db. Now referring to column 1 it is seen that 15 db represents power ratio of slightly over 30, and this is the front-to-back ratio of this particular beam. Thus a specific and decidedly useful report can be given to the station being checked.

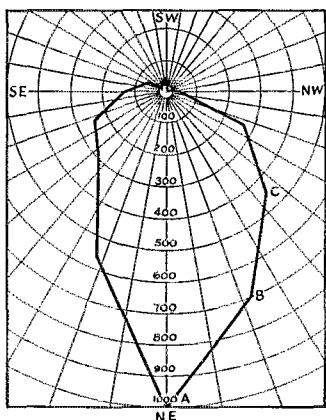

Fig. 3 — A sample rotary-beam directional characteristic determined by the method described in the text. The curve could be smoothed out if desired.

The power ratio could be arrived at immediately without the intermediate conversion of the S readings to db, but if this is done we get a ratio of something like 3600 to 120, which is rather unwieldy. To reduce it to the simpler terms involves some mental gymnastics which are much more arduous than the S-db-power conversion scheme. Although beams are evaluated by hams almost entirely in terms of either db or power ratios, there are occasions when the voltage ratios are desired and for that reason they are included in the chart.

Connecting his rotary beam to his receiver, the owner can check its characteristics by tuning in some other station and noting the meter readings as the beam is rotated. The conversion to terms of power ratio is then made as described above.

### Plotting Patterns

Obviously the only additional work necessary for plotting the radiation pattern of a beam is to take a number of readings as the antenna is rotated, instead of just the two needed to check front-to-back ratio. There are several precautions to be taken in such checks, however, and the procedure followed at W2JCR may prove helpful.

The first thing is to determine the antenna position which puts the strongest signal into the receiver. If this is above S9 the antenna coupling to the receiver should be reduced so that the

meter reads S9 or slightly lower, thus keeping within the range of the db calibration. Having found this position for the beam, and with the receiver antenna coupling suitably adjusted, the exact course of procedure is then agreed on between the two stations: The beam to be rotated in steps of not more than  $22\frac{1}{2}$  degrees and to be stopped in each of these positions for at least 30 seconds; at each stop the position of the beam to be announced, then the carrier left unmodulated for the balance of the period.

At the receiver end the selectivity should be high to reduce the possibility of QRM, because an interfering signal will make the check valueless. Leaving the antenna coupling at the adjustment mentioned above, at each position of the beam make a note of the announced direction, then during the unmodulated period make sure the signal is exactly in tune and note the resulting reading. This retuning is important because changes in signal strength may otherwise tend to throw the receiver oscillator slightly out of tune, making readings unreliable. If modulation were present, that too might confuse the readings by "wobbling" the meter.<sup>1</sup> The meter readings are noted in fractional S points; usually it is possible to estimate to one-tenth of a point.

Table I is the work-sheet of an actual check made by W2JCR and will be briefly described to illustrate the orderly method of recording the measurements and compiling the desired data.

The directions as announced were entered in column 1 and the S readings in column 2. The transmitting station was then asked to stand by for a few minutes while the desired information was worked out in columns 3, 4 and 5.

In column 3 the db values for the various readings are noted. These are taken from the second column of Fig. 2. We note that the lowest value here is 15 db, and inasmuch as we are interested only in the relative values shown by this particular beam we adopt this as a new zero level and deduct 15 from each of the values in column 3, entering the result in column 4. From these figures we see that the maximum signal is 30 db above the minimum; that the "head-on" signal is 13 db above the back (southwest) signal, etc. Incidentally, we note that this beam is apparently not functioning "according to Hoyle" because it should have minimum radiation off the ends, which would be the SE and NW positions.

In this particular report the power ratios are entered in column 5. Had the owner of the beam been interested in voltage ratios these would have been shown instead. In either case the data are

(Continued on page 118)

<sup>1</sup> Obviously, when making such a check with a distant station, it is also necessary to take the effects of fading into account and, if necessary, make the measurements over a sufficiently long period so that fading averages out. The measurements in such a case should be attempted only when conditions are relatively stable. — Editor.

The Gatti Expedition "roughs it" in these two de-luxe trailers which house, among other things, a 5-kw. a.c. lighting plant, air conditioning, an electric range, electric refrigeration, a bathroom with full-sized tub and, of course, the ham transmitter and two receivers.



## OQ5ZZ Calling "CQ USA"

### *Amateur Radio to Furnish Communication with Gatti African Expedition*

BY EDWARD A. RUTH III,\* W2GYL

**T**HE 10th Gatti African Expedition, under the leadership of Commander Attilio Gatti, has a variety of objectives in the Congo. Supported in part by the Belgian and Colonial governments, it

\*Ereo Radio Laboratories, P. O. Box 16, Hempstead, L. I., N. Y.

will make surveys, shoot moving pictures, study the flora and fauna, and investigate possibilities for further Colonial development in the Congo, during the two-year stay in the jungle. The expedition is also under the auspices of the Royal Zoölogical Societies of Rome and Antwerp, and has assignments from them which include explorations in great areas still known as "zones of mystery."

This is the first time that radio has been used on one of the Gatti trips, and the commander assured me that if the radio equipment fulfills only half its purpose of maintaining communication between trucks and with the outside world it will be worth its weight in insect spray. That's saying something, in that bug-infested country!

Fortunately, the radio equipment wasn't held down to any stringent weight or power limitations. A.c. power up to 5 kw. will be available, and this eliminates the need for batteries, chargers, motor-generator sets and all the attendant headaches. Two Hallicrafter SX16 receivers, one for each truck, make up the receiving equipment. The transmitter was custom-built and designed for operation on 3950, 3990, 14,320 and 14,364 kc. The r.f. portion consists of an RK39 crystal oscillator driving an RK51 amplifier which runs at 100 watts input. The amplifier is plate-modulated by a pair of 6L6G's operating in Class AB1. A panel switch selects the crystal and proper oscillator plate coil, and it is only necessary to change final tank coils when changing bands. All resistors, condensers and transformers were selected for a wide margin of safety, and after the wiring was in place and cabled it was given two coats of glyptol varnish to insure the exclusion of moisture.

(Continued on page 80)

OQ5ZZ, the portable station of the 10th Gatti African Expedition, was built in this country and exemplifies the trend in modern construction. It is designed for 'phone operation in the 3.9- and 14-Mc. bands. The upper deck carries the r.f. portion and the modulator and power supplies fill in the lower deck.

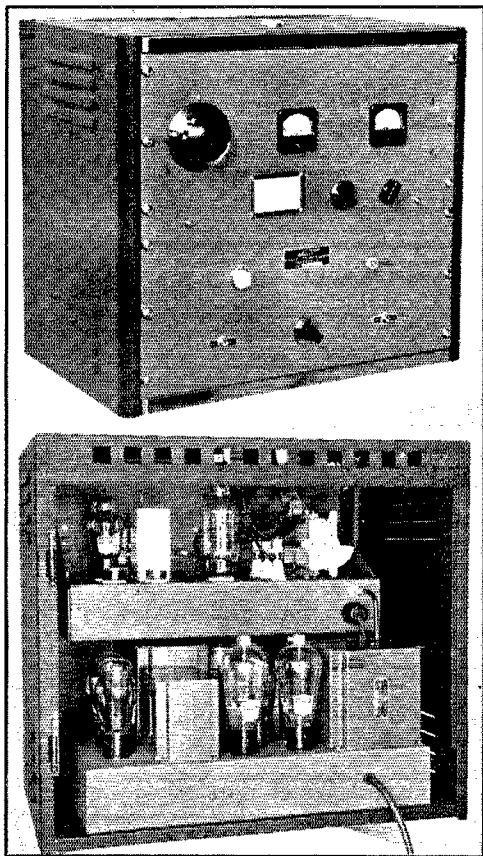

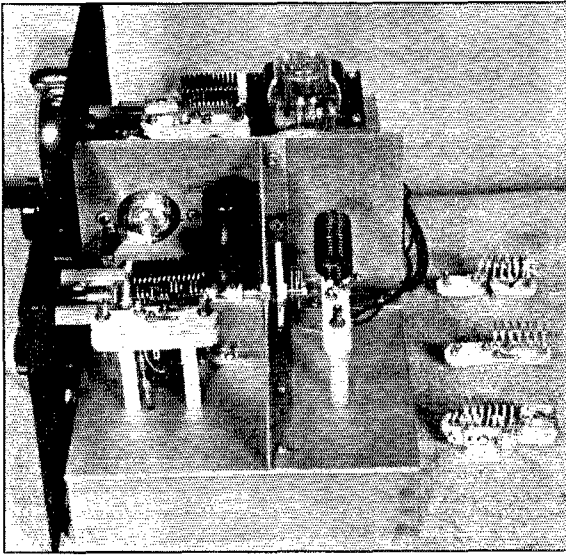

With gain and stability at 56 Mc. the primary objectives, the converter described here developed out of a considerable amount of on-the-air experimental work, has proved to be a highly-successful piece of u.h.f. equipment. The reasons for the various design points are fully discussed. And the tube combination is one which is rapidly acquiring a deserved popularity for this work.



The arrangement of the r.f. and mixer input circuits is shown in this side view of the converter. The 10-meter coils are in place; the set for 5 meters, to the right, shows the method of construction.



# A Superhet Converter for 5- and 10-Meter Reception

*Self-Powered Plug-in Coil Unit Using U.H.F. Tubes*

BY FRANK LESTER,\* W2AMJ

**M**ANY of those who were in Chicago at the National Convention last summer, and who were able to get up rather early on the Sunday morning in question, heard the writer describe a 5- and 10-meter converter. That unit, using a Sylvania 1231 tube as a tuned r.f. amplifier ahead of a 6K8 converter tube, proved so successful that we decided to investigate further in an effort to produce an even better one. The present arrangement is the result of several months of comparisons and tests, and represents an even higher order of performance. It is adaptable to any communication receiver, or even broadcast set, capable of being tuned to the range 2000-6000 kilocycles.

In considering the design of a converter, the mixer or converter tube should be selected with care, since it is really the heart of the unit. Characteristic charts and engineering data show that the 6K8 is the outstanding tube of its class, because of its higher conversion conductance, lower input capacity, and other features. The 6J8 is a close second. However, actual comparisons prove that the data sheets do not lie, and that the 6K8 is superior. A little trouble may be experienced in

realizing some of the advantages of the tube because the input or mixer section does have a tendency to become regenerative when employed in conjunction with a decent coil and condenser, on frequencies from 28 megacycles up. This is the result of some feed-back inherent in the tube itself, and applies not only to both metal and glass versions, but also to tubes from different manufacturers.<sup>1</sup> The 6J8 tube is free from this effect, which might account for its choice by some of the gang, especially those who want single control.

When a 6K8 is substituted for a 6J8 the mixer tuning is very much sharper, consequently a more troublesome tracking problem presents itself. The amount of regeneration will vary with different loading conditions; lighter loading will result in more regeneration and heavier loading in less. Without any load the tube has a tendency to oscillate. After various remedies were tried, it was found that the simplest and best was simply to insert a small loss resistor ( $R_s$  in Fig. 1) in series with the signal grid. The size of this resistor will

<sup>1</sup> The effect is actually a space-charge coupling phenomenon inherent with this type of tube. A complete explanation is to be found in an engineering bulletin of the Ken-Rad Tube and Lamp Corporation.

\* Wholesale Radio Service Co., New York.



vary slightly with different layouts; however, it has been found that usually it will be between 5 and 50 ohms. For the layout shown here, 10 ohms was found to be the optimum value.

### *Oscillator Circuit*

The circuit used with the oscillator section of the 6K8 is one of the most stable and sure-fire on high frequencies. It will be recognized under several different names; possibly it is most popular as the "minute-man" superregenerative circuit. One disadvantage, if it can be called that, is the fact that the tuning condenser must be insulated, since both sides of the condenser and the coil are "hot." The slight additional mechanical problem introduced by insulating the variable condenser is easily offset by the advantages this particular circuit offers.

In connection with oscillator stability, attention should be called to the fact that mica trimmers are employed in this circuit. These are recommended from a cost angle, as well as a practical angle, and really represent no compromise. With the climatic conditions that prevail in the vicinity of New York City, no advantage whatsoever could be detected when air-dielectric trimmers were used. It is therefore believed that if there is any difference between a good mica trimmer and air dielectric trimmer, it is mighty small in this particular case. It is true that where high humidity is encountered the air trimmer should be superior. It must be remembered, however, that we still have the drift of the high-frequency oscillator in the receiver to which the converter is connected, and this, in most cases, will account for more drift than can be attributed to the high-frequency oscillator employed in the converter. These statements are being made after actual comparison in the checking of oscillator stability over a period of a few months. During this time, in the particular area in question, we had rather pronounced temperature and humidity changes, but at no time during this period was the drift of the high-frequency oscillator in the converter noticeable. It is assumed, therefore, that it must have been less than approximately 50 kilocycles, which is about one dial division of the oscillator tuning condenser.

### *R.F. Amplifier*

It is a pretty well-known fact that in order to obtain maximum gain from almost any r.f. amplifier, both its grid and plate circuits should be tuned. It is also pretty well known that when this is attempted, one is looking for trouble, for along with optimum r.f. gain, oscillation and instability are also likely to be present. Again, the mechanical

The outfit is turned on its side in the accompanying plan view. Layout details in the oscillator section are clearly shown, together with part of the r.f. section. The output transformer is in the round shield can.

problem also pops up because the plate-tuning condenser must be insulated, since the low potential side of this condenser is usually 250 to 300 volts above ground. Despite all this, the plate-tuned circuit was used and has definitely proved its superiority. The question of oscillation and general instability can usually be licked by the choice of by-pass condensers, a little common sense in the mechanical layout, and last, but by no means least, ground returns. The layout chosen is very effective in accomplishing the desired result, regardless of the type of tube employed.

In the first version of the converter, using the 1231, no trouble of any kind was experienced in tuning the grid and plate; the circuit was as stable as an r.f. amplifier on the lower frequencies. This unit also employed the usual capacity coupling between r.f. plate and mixer grid circuits with the plate choke-fed. However, as previously mentioned, it was found advisable to change to the circuit shown, since this eliminates a doubtful r.f. choke and also affords greater gain.

During the course of the subsequent tests, four tubes were actually tried, the 1231, 954, 1853 and 1852, with the following conclusions:

It was found that the gain of the 1231 exceeded the possible gain of the 954, with the additional advantage of broader tuning. This applied also to the 1852 and 1853 tubes. For those desiring better selectivity and resultant better image ratio, the 954 type of tube is preferable. Since, however,

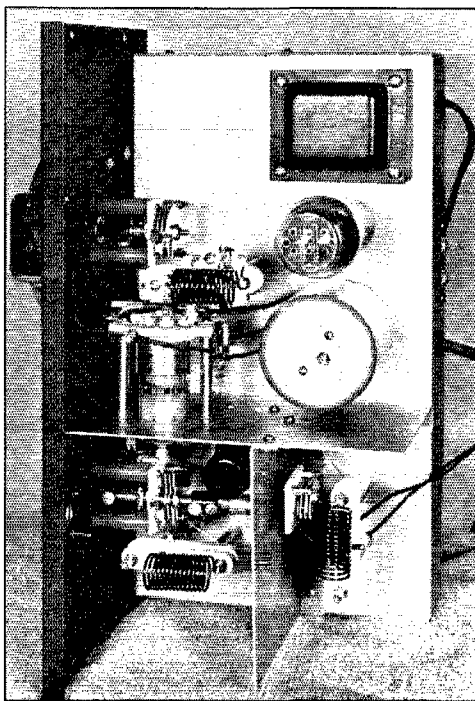

in a u.h.f. converter using a high intermediate frequency we do not care so much about image ratio or selectivity in the r.f. stage, but are really after maximum gain, the high mutual-conductance tubes are preferable. It is apparent that any i.f. above 2000 kilocycles will result in the image's being outside of the 56-60-megacycle range, and therefore there is nothing to be concerned about. The 1853 checks approximately the same as the 1231, undoubtedly because it has the same mutual conductance, and also approximately the same input and output capacities. With the 1852 it was found that high gain is possible, but with more instability. For the same degree of stability, all three tubes are about equal. That is, the 1852 had a tendency to oscillate without antenna loading, and to prevent oscillation and obtain the desired degree of stability the antenna had to be over-coupled to the point where the r.f. gain realized was so close to that obtained with the other tubes that there was practically no difference.

Since the 1851 is so close to the 1852 in characteristics, it is assumed that this tube can be added to the group in question. More instability may be experienced if care is not taken in the layout and in choice of ground points, using the 1851, because the control grid comes out the top of the tube and there may be a slightly longer grid-return path.

It is of interest to note if an 1852 is substituted for the 1853 the latter tube may appear to be slightly better. The reason for this is that the 1852 has a higher input capacity and also, loads the grid circuit more. To compensate for this, it is necessary to retrack the grid circuit. It was found that one less turn in the grid coil (six turns instead of seven) resulted in practically perfect tracking throughout the 56 to 60 megacycle range, where the majority of these tests were conducted.

### *Tracking*

Tracking is a phase of converter and high-frequency receiver construction that has been covered rather too lightly, especially when one considers that possibly the constructor may be building his first superhet. It is for this reason, along with other advantages, that separate tuning is used in this converter. Not only is the tracking problem greatly simplified, but also optimum performance is assured at any one frequency. In addition, it is possible to spread the oscillator tuning over any desired number of dial divisions without having to worry about tracking.

In the circuit diagram, the series oscillator trimmer,  $C_4$ , is the band-spread adjustment, while the parallel padder,  $C_5$ , is the band-setting condenser. To avoid re-tuning when the converter is shifted from 5 to 10 meters, the series and parallel mica trimmers are part of the plug-in coil assembly, as illustrated. The National PB-16 plug and XB-16 socket lend themselves well to this work, since they are not too large and have five contacts.

If two-dial control seems objectionable, a moment's thought will show that it is no worse than employing a pre-selector ahead of the receiver, which many do already. The tuning will be no more complicated. Also, the possibility of mis-tracking is removed entirely, and optimum performance at any given frequency is practically assured. The r.f. tuning has absolutely no effect on the oscillator tuning; in other words, there is no noticeable pulling.

An additional advantage of this arrangement is that full oscillator-dial coverage for the 5- and 10-meter bands is possible. If single-dial control was used, the 5-meter band would be squeezed into approximately 40 degrees of a 0-100 dial. It is true that this could be corrected by using series and parallel padders on the other two tuned circuits, but this would result in a poorer  $L-C$  ratio, since the coils would necessarily have to be smaller to allow for the parallel capacity. In addition, there would be six trimmer adjustments to play with for proper tracking.

On 5 meters the oscillator was tuned to the low-frequency side of the incoming signal to get a higher  $L-C$  ratio. This is more or less standard practice, since it gives better oscillator stability. On 10 meters the oscillator was tuned to the high-frequency side. However, the choice of the high or low side can be made by each individual to suit particular location requirements. In some cases when the oscillator is tuned to the low-frequency side of the incoming signal, police and other high-frequency experimental stations may come within the range of the band being covered.

There is room for individual experimentation in the choice of intermediate frequency as well as of oscillator tuning. With the particular receiver used in conjunction with this converter, it was found that approximately 5.7 megacycles was one good possibility. It must be remembered that the high-frequency oscillator in the receiver has harmonics, and that only by proper choice of intermediate frequency can the receiver oscillator harmonics be prevented from falling into the tuning range covered by the high-frequency converter. Using 5.7 megacycles, one of the receiver high frequency harmonics will fall at approximately 54 to 55 megacycles. By proper adjustment of oscillator band spread this one harmonic can very easily be pushed off the dial, and approximately 90 degrees of a 0-100 dial be employed to cover from 56 to 60 megacycles. This same band-spread is possible on 10 meters, as is freedom from oscillator harmonics.

### *Construction*

Despite all this discussion, reference to the schematic diagram and the photographs of the unit show that there is nothing very revolutionary or startling. Nothing tricky is involved, and one has only to use a little common sense when duplication of the unit is attempted. Ground points

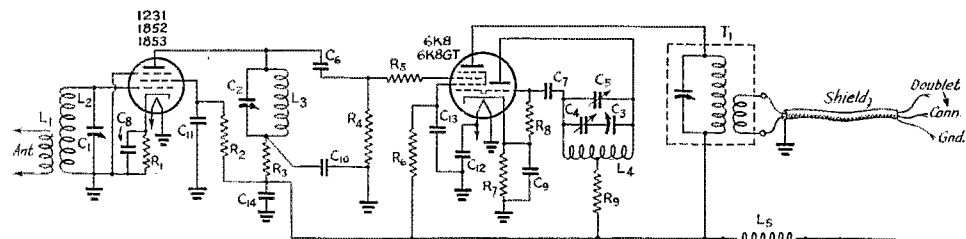

Fig. 1 — Circuit diagram of the converter.

- |  |  |
|--|--|
| C <sub>1</sub> , C <sub>2</sub> — 10- $\mu$ fd. midget (Cardwell ZR-10-AS).  | C <sub>14</sub> — 0.1- $\mu$ fd. paper.                  |
| C <sub>3</sub> — 15- $\mu$ fd. midget (Cardwell ZR-15-AS).                   | C <sub>15</sub> — 8-8- $\mu$ fd. electrolytic, 450-volt. |
| C <sub>4</sub> , C <sub>5</sub> — 3-30- $\mu$ fd. trimmer (Hammarlund MEX.). | R <sub>1</sub> — 250 ohms, $\frac{1}{2}$ -watt.          |
| C <sub>6</sub> — 100- $\mu$ fd. mica.  | R <sub>2</sub> — 30,000 ohms, $\frac{1}{2}$ -watt.       |
| C <sub>7</sub> — 50- $\mu$ fd. mica.   | R <sub>3</sub> — 3000 ohms, $\frac{1}{2}$ -watt.         |
| C <sub>8</sub> , C <sub>9</sub> , C <sub>10</sub> — 0.01- $\mu$ fd. paper.   | R <sub>4</sub> — 1 megohm, $\frac{1}{2}$ -watt.          |
| C <sub>11</sub> , C <sub>12</sub> , C <sub>13</sub> — 0.005- $\mu$ fd. mica. | R <sub>5</sub> — 10 ohms, $\frac{1}{2}$ -watt.           |
|  | R <sub>6</sub> — 60,000 ohms, $\frac{1}{2}$ -watt.       |
|  | R <sub>7</sub> — 300 ohms, $\frac{1}{2}$ -watt.          |

- L<sub>1</sub> — 56 Mc.: 4 turns No. 18, diameter  $\frac{3}{8}$  inch, interwound with L<sub>2</sub>.  
 28 Mc.: 5 turns No. 18, diameter  $\frac{1}{2}$  inch, interwound with L<sub>2</sub>.
- L<sub>2</sub>, L<sub>3</sub> — 56 Mc.: 7 turns No. 14, outside diameter  $\frac{5}{8}$  inch, length  $1\frac{1}{4}$  inches.  
 28 Mc.: 14 turns No. 14, diameter  $\frac{3}{4}$  inch, length  $1\frac{1}{4}$  inches.
- L<sub>4</sub> — 56 Mc: same as L<sub>2</sub>, but with center-tap.  
 28 Mc.: 12 turns No. 14, diameter  $\frac{3}{4}$  inch, length

- $1\frac{1}{4}$  inches, center tapped.
- L<sub>5</sub> — 30 henrys, 50 ma.
- T<sub>1</sub> — Plate winding, 22 turns No. 24 d.c.c. on  $\frac{3}{4}$ -inch form, tuned with 3-70- $\mu$ fd. mica trimmer; output winding, 10 turns No. 28 wound on same form near B-plus end of plate coil.
- T<sub>2</sub> — Power transformer, to deliver 300 volts at 30 ma., with 5- and 6.3-volt windings.
- Sw<sub>1</sub> — D.p.s.t. toggle.  
 Sw<sub>2</sub> — S.p.s.t. toggle.
- R<sub>8</sub> — 50,000 ohms,  $\frac{1}{2}$ -watt.  
 R<sub>9</sub> — 125,000 ohms, 1-watt.

are, as usual, very important for freedom from oscillation and good circuit stability. All ground points should be made as closely as possible to one point on the chassis, for each tube circuit, and the various ground and by-pass condenser leads made as short as possible.

A separate bracket is provided for mounting the r.f. tube socket. This elevates the tube, and the grid prong can be towards the shield between the r.f. grid and plate circuits. Since the plate prong is directly opposite, short leads result. A hole approximately  $\frac{1}{8}$  to  $\frac{3}{16}$  inch in diameter is provided in the shield for the grid lead to come through. The plate lead comes from the tube socket to the stator side of C<sub>2</sub>. From this point the mixer-coupling condenser, C<sub>6</sub>, is also supported. The other side of C<sub>6</sub> ties to a single-terminal bakelite mounting strip across which is mounted the 1-megohm mixer grid leak. The suppressor resistor, R<sub>5</sub>, forms the rest of the mixer grid lead.

Before fastening the r.f. tube socket bracket, the socket should be mounted as previously described, and all wiring to this socket finished. The grid and plate leads should be made by soldering approximately 4 inches of wire to each prong, with 12- to 15-inch leads provided for the filament and screen connections. In mounting by-pass condensers C<sub>8</sub> and C<sub>11</sub> it is possible to provide a little shielding between the grid and plate by mounting C<sub>11</sub> on its edge, and placing it so that it comes between the grid and plate prongs. One side of the heater is grounded, along with the suppressor and tube shield, and all of these terminals are tied

together and a lead from them soldered directly to the metal bracket. When this wiring has been completed, it is only necessary to pull the leads through the holes in the chassis, and then fasten the bracket securely in place after the leads have been trimmed and soldered at the proper points.

The 6K8GT bantam tube is mounted horizontally, as is indicated in the photograph. This model of tube was chosen because of its lower input capacity, because we may try 2 $\frac{1}{2}$  meters some day. The metal 6K8 may be used with no noticeable difference other than the slightly higher input and oscillator capacity.

It will be noticed that the power supply for the converter is incorporated in this unit, since this makes installation simpler. It is also too much to ask any standard receiver to furnish the additional power, since the two tubes will draw approximately 30 ma. The power transformer delivers the required 300 volts at the current drain of the two tubes, and is of the "4-tube midget broadcast receiver" variety.

Two switches are employed, one in the primary of the power transformer and the other in the high-voltage center-tap lead. The latter is of the single-throw double-pole variety, with one set of contacts brought out to terminals on the rear of the chassis for connection to the receiver "B" switch. The receiver "B" supply is thus broken at the same time the switch is thrown in the stand-by position. The entire unit is mounted in a 7- by 14- by 8-inch standard steel cabinet, which accommodates a 7- by 13- by 2-inch chassis.

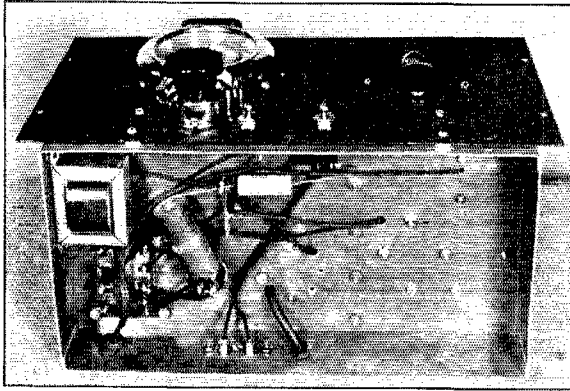

Very few parts are underneath the chassis: a few odd by-pass condensers and resistors, and the filter choke. The oscillator is tuned by the large dial at the left; r.f. and mixer input stages by the smaller dial at the right.

### Coils

The coil plug bases are used just as they are supplied. It is a good idea to tighten all the nuts and brass studs before mounting the coils. One side of the coil is soldered directly to one brass stud with the wire pushed into the threaded hole; this lead is kept very short. By doing this, a mechanically stable coil is obtained. When mounting the oscillator trimmers to the plug, at least No. 14 bus bar should be employed, and likewise only short leads used, so that the condensers will be vibration-free. The series padder on the oscillator coil has one of its lugs bent down and soldered directly to the brass stud on the other end of the plug. The photographs should give sufficient detail to make further comment unnecessary.

The output coil of the converter is shielded to prevent i.f. pickup. The 3-70- $\mu$ fd. mica trimmer connected across the plate coil will provide more than ample tuning range, approximately 6000 to 2000 kc. A few turns can be removed from the plate coil if a higher intermediate frequency is desired. Some experimenting with the amount of coupling between the tuned plate circuit of this transformer and the output winding may be advisable. Fairly loose coupling is recommended, with the two coils being wound next to each other on the same form. The coil specified does a pretty fair job of matching the input of most receivers.

### Alignment Procedure

After assembly has been completed and the wiring checked, the alignment procedure is as follows, assuming that a modulated signal generator is not available. The coils for a particular band should be plugged into their respective sockets, and the converter turned on and allowed to warm up for a few moments.

The output transformer trimmer condenser

should be set at near minimum capacity, assuming that 5.7 megacycles is the intermediate frequency.  $C_5$  is then set at near minimum capacity, while  $C_4$  is set near maximum. Assuming that the dials are adjusted to give zero reading at maximum capacity, the r.f. dial is set at approximately 40 to 50 degrees, and the antenna connected to the converter.

The receiver is then set to 5.7 megacycles and the r.f. gain advanced to the maximum position. Using an insulated screw driver, the capacity of  $C_5$  is then slowly increased. It is possible to operate the oscillator either above or below the frequency of the incoming signal, and this range is covered by  $C_5$ . For purpose of illustration, we will assume that the oscillator is to be adjusted to the low-frequency side. The oscillator dial should be set at approximately half scale. As the

capacity of  $C_5$  is increased, the noise level will peak at a point corresponding to working the oscillator on the high-frequency side of the signal. Since it is desirable to operate on the low-frequency side, the capacity of  $C_5$  should be further increased until the noise level again peaks. This adjustment must be made slowly, and it must also be remembered that when screw driver is removed oscillator tuning will be slightly affected.

When this stage of adjustment is reached, the r.f.-stage tuning control is adjusted for maximum signal. The output transformer trimmer is then adjusted for maximum signal by increasing or decreasing the capacity of the trimmer connected across the plate coil.

The band-spread tuning of the oscillator is then checked by tuning in 5-meter signals of known frequency. If it is desirable to increase the band-spread,  $C_4$  is loosened slightly and the frequency range again checked. By making minor adjustments to  $C_4$  and  $C_5$  any desired spread is readily obtained. Decreasing the capacity of  $C_1$  will spread the band, and vice versa.

The last check is to track the r.f. circuits. The grid-tuning condenser is temporarily ungangged by loosening the screw on the insulated coupling. With the converter tuned to a signal,  $C_1$  is then rotated above or below the setting of  $C_2$ , and any mis-alignment taken care of by varying the between-turn spacing of either  $L_2$  or  $L_3$ . If oscillation develops during this final adjustment, the coupling should be tightened between  $L_1$  and  $L_2$  by bringing  $L_1$  nearer the grid end of  $L_2$ . If the 1853 is employed, there should be no trouble whatsoever with oscillation.

In closing, we believe it advisable to mention that the noise level of the combination will exceed the noise level of the receiver alone. This, of course, is because of the additional gain the combination provides. This also means that S-meter

(Continued on page 108)

# Canada-U. S. A. Contact Contest

April 14-16, 1939

**T**HE 1939 W/VE Contest will be sponsored by the Quebec Division, A.R.R.L., in collaboration with the Montreal Amateur Radio Club and Les Amateurs Canadiens-Francais de la T.S.F. This activity is growing in popularity from year to year and provides an interesting period for plentiful contacts between Canadian and U. S. A. amateurs. Read over the results of the 1938 W/VE get-together, page 25, September '38 QST, and don't miss this year's fun!

**Dates and Times:** Starts — 6:00 P.M., local time, Friday, April 14th. Ends — 6:00 P.M., local time, Sunday, April 16th. Duration of the contest is 48 hours. "Local time" refers to the time at each individual participating station.

**Frequency Bands:** Any and all amateur bands may be used, 'phone and/or c.w.

**Object:** For each VE to work as many W's in as many United States A.R.R.L. Sections as possible. Each W will work as many VE's in as many Sections as possible. See front pages of QST for list of Sections.

**Scoring:** The same log form as for last year's contest will be used. Message preambles will be exchanged. Each preamble sent will count *one point*, each preamble received will count *one point*. It is not necessary for preambles to be exchanged *both* ways before a contact may count, but one must be sent or received before credit is claimed. All preambles must be handled under approved A.R.R.L. procedure. Mark each new Section as it is worked. The "check" portion of the preamble will be the RST report of the station worked. On 'phone the "T" will be omitted, of course. Sample preamble: NR 1 VE2CO CK 589 Montreal Que 6:02 P Apr 14. W stations multiply number of points by the number of VE Sections worked and multiply the final score by nine, there being approximately nine times as many U. S. A. Sections. VE stations multiply the number of points by the number of U. S. A. A.R.R.L. Sections worked.

**Power and Operator Handicap:** Each station having less than 100 watts input to the final stage shall multiply the score by  $1\frac{1}{2}$ . When more than one operator normally operates a station the total score of the station shall be accepted, provided a certificate is attached to the log giving the names and call signs of the operators making the score.

**Prizes:** A Certificate of Merit will be awarded to the leader in each of the A.R.R.L. Sections. There will also be additional prizes for the highest scoring Canadian and American stations, and for the several highest ranking VE's aside from the very highest scorer.

**Logs:** All logs should be mailed to VE2HG and VE2EU, Les Amateurs Canadiens-Francais de la T.S.F., Lapalestre Nationale, 840 Cherrier Street, Montreal, Quebec, not later than midnight, April 30, 1939.

**Operator's Certificate:** The following certificate is requested on each log submitted:

"I hereby state that in this contest I have not operated my transmitter outside any of the frequency bands specified on my station license, and also that the score and points set forth in the above summary are correct and true."

Let's see a big turn-out for this contest. CQ VE to raise Canadians; CQ W to raise United States stations. Best of luck to all!



## DIXIE JONES' OWL JUICE

**A**ND the Lord said unto Moses: "Go ye up on top of the Mount and receive the Ten Commandments." So Moses picked up his ham rig and toted it up the hill. He set his coherer on a stump, put the cans on his conk, picked himself up a flat piece of rock, fished his hammer and chisel out of his pocket, cranked up his haywire and says "K." Then the lightning flashed and the thunder rolled and Moses said: "QRN QRN, send louder please, there is skip distance." And the Mount trembled and shook as Moses copied on the stones:

1. Thou shalt not make more than six dots for the letter "h."
2. Thou shalt sign thy call at least once every 100 CQs.
3. Thou shalt not have loud harmonics nowhere nohow no time.
4. Thou shalt not thump BCLs much.
5. Thou shalt not modulate over 300 per cent.
6. Thou shalt not say "r r" when you didn't git it.
7. Thou shalt not shoot at 4th Corps Area fone men.
8. Thou shalt love the ham that squawks all over thy freq even as you do his'n.
9. Thou shalt gobble ZCB contests and always copy the Armistice Day message.
10. Thou shalt keep thy haywire in the ham bands so that thy days may be long in the Call Book.

— W4IR of the Dixie "Squinch Owl"

# A Peak-Limiting Amplifier for Amateur Use

**Increasing Communication Efficiency and Preventing Over-Modulation by Speech-Compression**

BY ROBERT MACFARLAND,\* W5BKS

A DEVICE for preventing over-modulation is a valuable asset to any amateur station. If this same device will allow an increase in average modulation of 3 or 4 db, then the device is still more valuable (and attractive!) to the amateur.

Numerous schemes have been proposed for preventing over-modulation, and a number of peak-limiting amplifier circuits have been sug-

gested, but the peak-limiting amplifier to be described performs better than anything previously tried at W5BKS. It will give an increase of at least 3 db in average modulation which, in the words of broadcast equipment manufacturers, is as good as doubling the carrier power without peak-limiting.

The system used is relatively simple. If two transformers are connected as in Fig. 1-A, the equivalent circuit will be as at B when the values of  $R$  become quite high. By following the arrows, it will be seen that any audio current induced in  $T_2$  cannot flow in transformer  $T_3$ , and therefore no signal will appear in the secondary of  $T_3$ . On the other hand, if  $R$  becomes a very low value, the equivalent circuit will be as at C, and the signal will be transmitted with no appreciable loss. At intermediate values of  $R$ , the signal passed will be in inverse proportion to the resistance. In practice, the resistors  $R$  are replaced by the plate resistance of vacuum tubes, as in Fig. 1-D. The value of the plate resistance is controlled by the grid bias voltage, and this bias or control voltage is obtained from an amplifier-rectifier system tapped on to the secondary of  $T_2$ . The net result is that, as higher audio input is applied to the input of the amplifier, more voltage is developed by the control-voltage amplifier-rectifier tube and applied to the grids of the control tube, which in turn increases the plate resistance and the attenuation in the control circuit. Inputs greater than that where compression starts to take place will not increase the output of the amplifier by more than about 2 db. A variable bias control on the control-voltage rectifier sets the point at which the diode starts rectifying and thus the point at which compression starts to take place. The output of the amplifier is controlled by a volume control placed after the compressor circuit.

Reference to the complete circuit in Fig. 2 will show how the compressor is incorporated in a speech amplifier of typical design.

## Adjustment

It might be wise to use a loud speaker for the amplifier load until the preliminary adjustments have been completed. If an audio oscillator and a volume indicator are available, no trouble in ad-

\* 1325 N.E. 15th St., Oklahoma City, Okla.

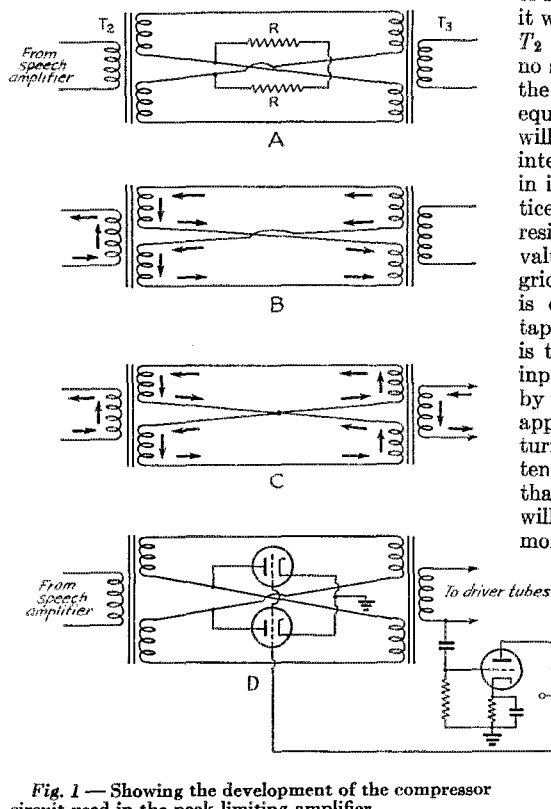

Fig. 1 — Showing the development of the compressor circuit used in the peak-limiting amplifier.

When transformers connected as at A have current induced in the secondary of  $T_2$ , no current will flow in  $T_3$  if  $R$  is high. This can be seen readily by following the current flow in B. However, when the value of  $R$  becomes low, the circuit changes over into that shown at C, and current can flow in  $T_3$ . In practice, the resistors are replaced by the plate resistance of vacuum tubes, and bias for the tubes is obtained from an amplifier-rectifier system, as in D.

Perhaps you have no interest in a story on a simple way to keep your modulation up to nearly 100 per cent all of the time without running the risk of over-modulation. But knowing that the same article tells you how to put out a consistently stronger 'phone signal for the same carrier power might change your mind.

justment should be encountered. Otherwise one's own judgment must be used as to how much compression is employed.

Feed an audio signal to the input of the amplifier and, with  $R_{11}$  in its maximum resistance position, remove the 6N7 control tube from its socket. There should be a sharp drop in output from the amplifier. The resistance of  $R_{23}$ ,  $R_{24}$ ,

$R_{25}$  and  $R_{26}$  may have to be increased to 500,000 ohms or 750,000 ohms in order to get the proper control range in the compressor network.

With the control tube back in its socket, slowly turn the control  $R_{11}$  toward minimum resistance. A point will be found where the reading of the meter in the cathode circuit of the control tube starts to decrease. This is the point where peak-limiting or compression is just starting to take place. Now you should be able to increase the input level to the amplifier approximately 5 db with only about 2 db increase in output from the amplifier, showing that the audio signal is being compressed about 3 db. The reading of the meter in the 6N7 cathode should be noted, or a mark made on the scale to show where the meter swings to with this 3 db compression. The input to the

(Continued on page 114)

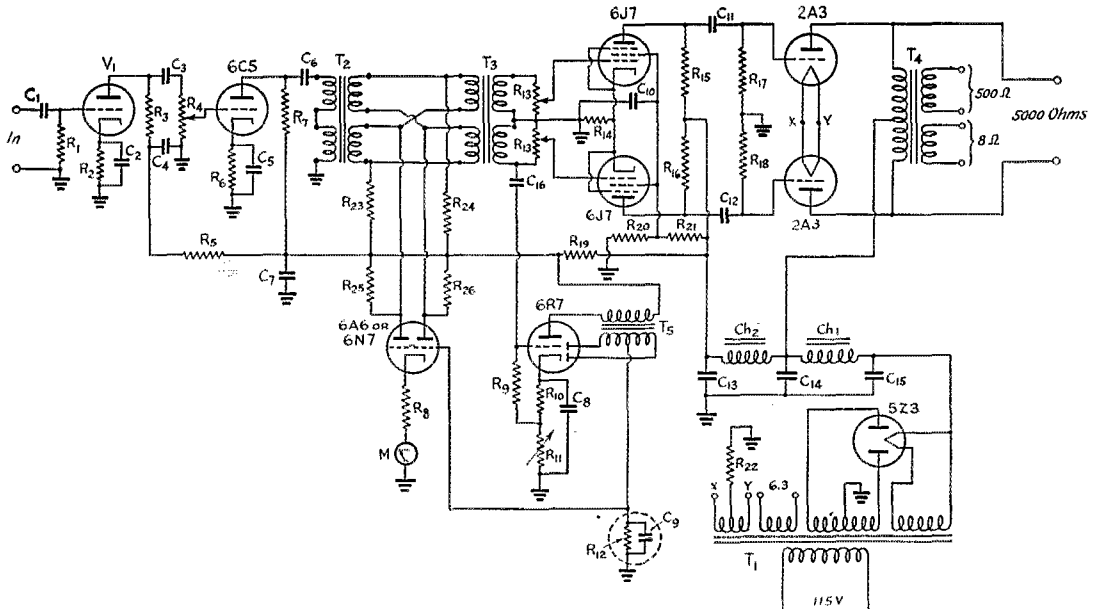
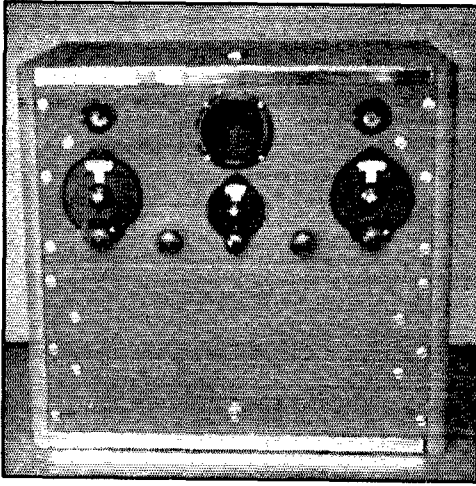

Fig. 2 — The peak-limiting amplifier.

- $C_1, C_3, C_6, C_{11}, C_{12}, C_{16}$  — 0.1  $\mu$ fd., 600-volt.
- $C_2, C_5$  — 20  $\mu$ fd., 25-volt.
- $C_4, C_7, C_{13}, C_{14}, C_{15}$  — 8  $\mu$ fd., 475-volt electrolytic.
- $C_8, C_{10}$  — 0.5  $\mu$ fd., 400-volt.
- $C_9$  — 0.1  $\mu$ fd. (See text.)
- $R_1$  — 3 megohms.
- $R_2$  — 8000 ohms for 6R7 tube, 4000 ohms for 6Q7.
- $R_3$  — 250,000 ohms.
- $R_4$  — 500,000-ohm volume control.
- $R_5$  — 50,000 ohms.
- $R_6$  — 5000 ohms.
- $R_7$  — 100,000 ohms.
- $R_8$  — 500 ohms.
- $R_9$  — 750,000 ohms.
- $R_{10}$  — 2000 ohms.
- $R_{11}$  — 20,000-ohm volume control.
- $R_{12}$  — 500,000 ohms. (See text.)
- $R_{13}$  — 500,000-ohm dual volume control.
- $R_{14}$  — 1200 ohms.
- $R_{15}, R_{16}$  — 250,000 ohms.
- $R_{17}, R_{18}$  — 500,000 ohms.

- $R_{19}$  — 10,000 ohms.
- $R_{20}$  — 25,000 ohms.
- $R_{21}$  — 250,000 ohms.
- $R_{22}$  — 750 ohms, 20-watt.
- $R_{23}, R_{24}, R_{25}, R_{26}$  — 250,000 ohms. (See text.)

- All above are one-watt, with exception of  $R_{22}$ .
- $CH_1$  — 12-henry, 150 ma.
- $CH_2$  — 30-henry, 80 ma.
- $V_1$  — 6R7 if high-output microphone is used. 6Q7 if low-output microphone is used.
- $T_1$  — Power transformer to deliver 360 volts at 150 ma. through filter.
- $T_2, T_3$  — Push-pull interstage transformers, with two-section secondaries.  $T_3$  is worked backward.
- $T_4$  — Output transformer for 2A3 tubes. The two plates of the 2A3 tubes go to the driver transformer primary when the amplifier is used to drive a modulator. The center tap of the driver transformer need not be connected to the amplifier.
- $T_5$  — Push-pull input transformer, 3-to-1 ratio.
- $M$  — 0-5 milliammeter.



# A Frequency-Checking Superhet

BY DANA A. GRIFFIN,\* W2A0E

◆  
A panel view of the combination frequency checker and transmitter-control e.c.o. described in the text. The power supply is behind the lower panel.  
◆

## *Utilizing Broadcast Stations for Amateur Transmitter Frequency Control*

**WORKING** close to band edges under the new regulations obviously requires a frequency-checking means that can be used continuously. The principal means suggested to date is the use of a 100-kc. e.c. or crystal oscillator accurately adjusted and checked against broadcast stations when WWV is not on the air. Unfortunately a requirement of this method is that a broadcast station operating one of the 100-kc. multiples is necessary if the checking is to be continuous. There are many sections where such signals are not available in daylight and are "smeared" by other stations at night. A further disadvantage is that an extra receiver is required to check the oscillator frequency against the broadcast station. Also if any attempt is going to be made to adjust to true zero beat, a magic eye or meter in a visual indicator arrangement is absolutely essential. Zero beat to the ear should not be depended upon as it can easily be off 20 or 30 cycles.<sup>1</sup>

The writer has approached the problem from a different angle and has developed a checking system, useful for those operating in or near the larger cities, where a large number of broadcast stations provide accurate frequencies during a considerable portion of the day. It is of particular interest to the electron-coupled oscillator fans, as

\* 136 Liberty St., New York City.

<sup>1</sup> Granting that a visual indicator is desirable, there are many who will disagree that accurate adjustment to zero beat is not possible by aural means. By observing the rise and fall of background noise, when the beat frequency is below audibility, it is readily possible to bring one oscillator into exact isochronism with another. The condition of zero beat is readily recognized when the incoming signal is modulated, since voice and music will sound unnatural or will pulsate when the two frequencies are not exactly the same.  
— Editor.

a new wrinkle is incorporated in the circuit to be described. If the proper constants are chosen, check points can be secured at the band edges, or within 10 kc. of them, in practically every metropolitan area.

Let us examine the principles involved in the system. The unit can be quite properly divided into two parts: First, the frequency-checking system shown in Fig. 1; and second, the e.c. oscillator-buffer amplifier of Fig. 2. The complete unit is a superheterodyne of peculiar design, the h.f. oscillator of which is also the e.c. oscillator of the transmitter. Naturally if the frequency of the h.f. oscillator of the superhet can be determined, this same oscillator can be used as the transmitter control without any further checks or monitoring.

The method of checking may sound a bit involved at first, but it is based on principles familiar to every amateur. Let us take a definite situation as an example. WOR operates on 710 kc. If we pick them up on a superhet equipped

By devious means it is possible to transform a broadcast frequency into another one which is useful for amateur frequency-checking purposes, as this article demonstrates. The next step is to use the "transformed" frequency for transmitter control, which is what the equipment discussed does. However, the idea can be used for frequency measurement alone; or, if you want just an e.c.o.-buffer unit for transmitting purposes you can "lift" that relatively-simple part of it from the circuit.



with an i.f. amplifier tuned to 2840 kc., we can tune the h.f. oscillator to 3550 kc. to receive them. Then in order to determine the h.f. oscillator frequency accurately, we have only to determine the i.f. frequency accurately. This is easily accomplished by zero-beating an oscillator against WOR's fundamental. If this b.f.o. is adjusted accurately to 710 kc., its fourth harmonic will fall precisely on 2840 kc. Then when the h.f. oscillator is tuned exactly to 3550 kc. zero beat will be obtained at the second detector output. If an audible beat is heard, obviously the h.f. oscillator is set incorrectly.

Now if the b.f.o. is left tuned to 710 kc., the fourth harmonic will continue to beat with any signal fed into the i.f. amplifier. If we now tune in WEAF (660 kc.), the h.f. oscillator must be set at 3500 kc. exactly, when zero beat is obtained. Likewise WJZ (760 kc.) will provide a 3600-kc. check point, WNYC (810) a 3650 point and WABC (860) 3700 kc., and so on. The accuracy of the system depends on three factors: First, the accuracy of the broadcast stations; these are generally held to 10 cycles or better so that to all intents and purposes we can disregard their deviation.<sup>2</sup> Second, the accuracy of setting the b.f.o. to

<sup>2</sup> This is generally true, but it is well to keep in mind that the permissible tolerance is 50 cycles. — EDROR.

the "i.f. frequency-determining station." Inasmuch as this can be checked continuously while the broadcast station is on the air, and as the checking is done with a magic-eye indicator, the error can be held to ten cycles or less. The fourth harmonic may be up to 40 cycles off frequency. Third, the accuracy of the setting of the h.f. oscillator, operating in the 3.5-Mc. band. This can be held to 50 cycles or better so that the total error is not likely to add up to more than 100 cycles on 3.5 Mc. It is an easy matter to multiply out the safety factor required for the higher frequencies.

Before going into circuit details, let us look at the possibilities of the system in other areas. If WLW is used as the key station the i.f. becomes 2800 kc. and a 3500-kc. point is provided. Any broadcast station in the band between 700 and 1200 kc. can then be used to give check points in the 3.5-Mc. band. Stations operating between 700 and 740 kc. may be employed, utilizing the fourth harmonic of the b.f.o. as the "i.f. determining frequency." Another group ranging between 880 and 1000 kc. may be used, with their third harmonics determining the intermediate frequency. A fourth group ranging from 1170 to 1330 kc. can be used, with their second harmonics determining the i.f. As a final example, if 1330 kc.

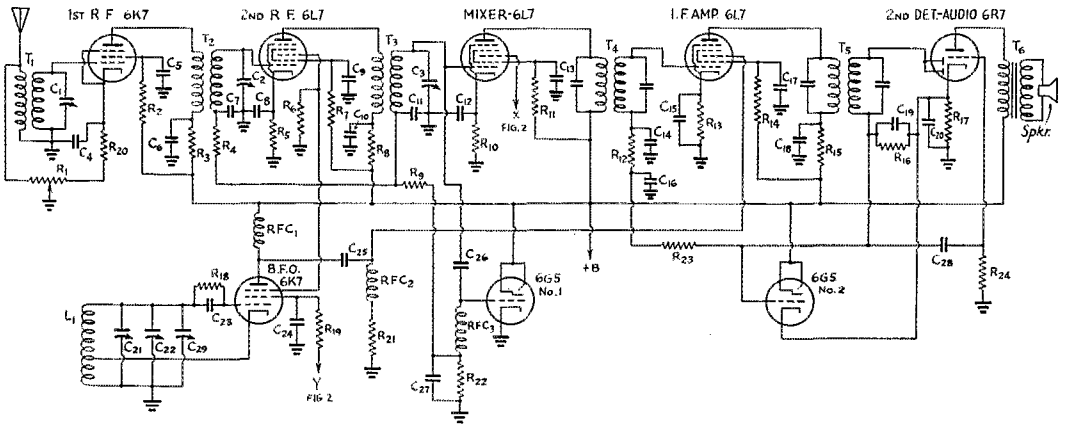

Fig. 1 — Circuit diagram of the superhet frequency checker. The high-frequency oscillator is in the e.c.o. unit shown in Fig. 2; its output is connected to "X" in the mixer circuit above.

- |   |   |
|---|---|
| C <sub>1</sub> , C <sub>2</sub> , C <sub>3</sub> — 350- $\mu$ fd. variable, gauged. | C <sub>19</sub> — 100- $\mu$ fd. mica.                  |
| C <sub>4</sub> , C <sub>5</sub> , C <sub>6</sub> — 0.1- $\mu$ fd. paper.            | C <sub>20</sub> — 10- $\mu$ fd., 25-volt electrolytic.  |
| C <sub>7</sub> , C <sub>8</sub> — 0.01- $\mu$ fd. paper.                            | C <sub>21</sub> — 350- $\mu$ fd. variable.              |
| C <sub>9</sub> , C <sub>10</sub> — 0.1- $\mu$ fd. paper.                            | C <sub>22</sub> — 5- $\mu$ fd. variable.                |
| C <sub>11</sub> , C <sub>12</sub> — 0.01- $\mu$ fd. paper.                          | C <sub>23</sub> — 50- $\mu$ fd. mica.                   |
| C <sub>13</sub> — 0.1- $\mu$ fd. paper.   | C <sub>24</sub> — 0.1- $\mu$ fd. paper.                 |
| C <sub>14</sub> , C <sub>15</sub> , C <sub>16</sub> — 0.01- $\mu$ fd. paper.        | C <sub>25</sub> , C <sub>26</sub> — 25- $\mu$ fd. mica. |
| C <sub>17</sub> , C <sub>18</sub> — 0.1- $\mu$ fd. paper.                           | C <sub>27</sub> — 0.001- $\mu$ fd. mica.                |
| C <sub>29</sub> — 400- $\mu$ fd. low-drift mica (Silvercap).                        | C <sub>28</sub> — 0.01- $\mu$ fd. paper.                |
| R <sub>1</sub> — 10,000-ohm potentiometer.  |   |

- |  |
|--|
| R <sub>2</sub> , R <sub>7</sub> , R <sub>11</sub> , R <sub>14</sub> , R <sub>18</sub> — 50,000 ohms, 1/2-watt. |
| R <sub>3</sub> , R <sub>8</sub> , R <sub>15</sub> — 5000 ohms, 1-watt.   |
| R <sub>4</sub> , R <sub>6</sub> — 250,000 ohms, 1/2-watt.  |
| R <sub>5</sub> , R <sub>10</sub> , R <sub>13</sub> , R <sub>20</sub> — 300 ohms, 1/2-watt.                     |
| R <sub>9</sub> , R <sub>12</sub> — 100,000 ohms, 1/2-watt.   |
| R <sub>16</sub> , R <sub>22</sub> , R <sub>23</sub> — 1 megohm, 1/2-watt.                                      |
| R <sub>17</sub> — 1000 ohms, 1/2-watt.   |
| R <sub>19</sub> — 10,000 ohms, 1/2-watt.   |
| R <sub>21</sub> — 30,000 ohms, 1/2-watt.   |
| R <sub>24</sub> — 500,000 ohms, 1/2-watt.  |
| T <sub>1</sub> , T <sub>2</sub> , T <sub>3</sub> — Broadcast r.f. coils.                                       |
| T <sub>4</sub> , T <sub>5</sub> — High-frequency i.f. transformers (2840 kc.); see text.                       |
| T <sub>6</sub> — Speaker transformer.  |
| L <sub>1</sub> — 90 turns No. 24 d.c.c., close-wound on 1-inch diameter form; tap at 30th turn from ground.    |
| RFC <sub>1</sub> , RFC <sub>2</sub> — 0.5-mh. r.f. choke (Miller).   |
| RFC <sub>3</sub> — 10-mh. r.f. choke.  |

is the frequency of one of the local stations, the i.f. would be 2660 kc. The station would give a check point at 3990 kc. and any stations from 1350 kc. down to 840 kc. can be used for check points within the 3.5-Mc. band. It is easy to see that every amateur has a wide choice of i.f. to make his local stations check at or near band edges. In the case of WEAf, for example, if the beat oscillator were tuned to 660 kc. and the sixth harmonic picked up, we secure 3960 kc. as the only harmonic falling within the 3.5-Mc. band. Yet we can convert this 660 kc. to a more useful frequency at 3500 kc. by using the superhet method.

We have, then, a system of frequency-checking that uses the thousands of dollars' worth of equipment maintained by the broadcasters — without any cost to us except that of the construction of the unit. This can be done in the "grand manner" or corners can be cut in those ways known best to the amateur. Let us now take a look at the box and see what makes it tick.

### Circuit Arrangement

The cabinet job shown in the photograph is somewhat more elaborate than necessary. The actual unit is built on the upper standard 8 $\frac{3}{4}$ -inch rack panel and a chassis 12 inches deep. The power supply is strung along the back edge of the 12-inch chassis on the lower 8 $\frac{3}{4}$ -inch panel, leaving room for an additional unit which will eventually "use up" the blank panel space below.

On the left is the dial that controls the tuning of the three-gang b.c.l. condenser shown in Fig. 1. The first three stages make up a receiver consisting of two r.f. stages and a detector. The magic eye directly above this dial is used to determine zero beat with the b.f.o., which is tuned by the smaller dial in the middle. Between them is a knob controlling the r.f. gain and signal input

( $R_1$ ). At the right is the dial controlling the ganged tuning of the e.c. oscillator and 6L6 buffer ( $C_2$ - $C_{12}$ , Fig. 2). To the left of this dial is  $SW_1$ , Fig. 2, which enables the operator to zero-beat the oscillator against an incoming ham signal without turning on the rig. The buffer is inoperative in one position, and neither tube operates in the other unless the key is closed.

Returning to Fig. 1, the third tube is the mixer of the superhet. It receives the high-frequency oscillator energy at injector grid "X." The next stage is the i.f. amplifier, tuned to 2840 kc., and it receives an injection of the 2840-kc. signal from the fourth harmonic of the b.f.o. The second r.f. stage receives an injection of the 710-kc. fundamental of this oscillator. Of course when the t.r.f. stages are detuned from 710 kc. this injection disappears, practically speaking. Magic eye No. 1 gives visual indication of the zero beat between the b.f.o. and the "i.f. frequency determining station." Magic eye No. 2 gives a zero-beat indication between the checking broadcast station and the transmitting frequency of the e.c. oscillator.

The b.c.l. portion of the checker can be built from any old b.c.l. set of the t.r.f. type, or a new condenser gang and the inexpensive shielded Meissner coils can be used for this purpose. The cheaper mica-tuned air-core 3000-kc. Meissner i.f. transformers should be used in the i.f. amplifier as they have sufficient range to cover any of the intermediate frequencies involved. A 3-inch Oxford permanent-magnet dynamic is included for monitoring purposes, and of course the unit can be used as a b.c.l. receiver in the shack by making the b.f.o. inoperative.  $C_{22}$  in the diagram is a 10- $\mu$ fd. Cardwell Trimair with one stator plate removed to make zero-beating easy. If the stator plate is bent the b.f.o. can be shorted out by rotating the condenser to maximum capacity.

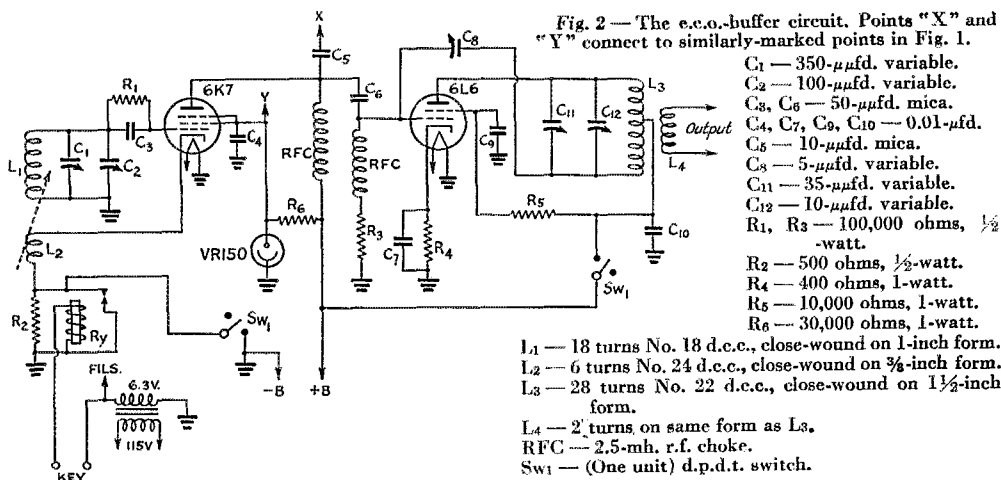

The  $\frac{1}{2}$ -millihenry chokes in the b.f.o. plate and i.f. injector tune these circuits in the vicinity of 2840 kc., thus accentuating the 2840-kc. harmonic on the injector. The b.f.o. and e.c.o. coils are wound on 1-inch diameter isolantite forms and are housed in 3-inch diameter coil shields.

### H.F. Oscillator

Fig. 2 requires little in the way of explanation. The two tubes comprise an electron-coupled 6K7 oscillator driving an impedance-coupled 6L6 neutralized buffer. Stabilization of the screen-grid voltage by the use of the VR150 regulator, the novel method of keying, and the other design features make this an interesting unit in itself. Two constructional points should be mentioned. The first is that the keying relay should be mounted on sponge rubber, otherwise the "slap" on "make" will cause sufficient vibration to develop modulation. The second point is the method used to vary the coupling between  $L_1$  and  $L_2$ . The cathode coil is wound on a piece of bakelite tubing  $\frac{3}{8}$  inch in diameter and 2 inches long. This slides inside the grid coil. It is mounted on a flat bakelite strip which is long enough to span two of the mounting screws for the coil shield diagonally. These two screws are  $1\frac{1}{2}$  inches long and are supplied with lock nuts on both sides of the flat strip, so that once the proper coupling is obtained, the cathode coil can be locked in position.

The remainder of the construction is straightforward, and does not involve any tricks. It might be well to point out that a power supply capable of delivering 300 volts with good regulation is a necessity. A current capacity of 150 ma. is required. A double-section filter is also needed to insure T9 note.

### Lining Up

Assuming that the unit has been built and that no serious mistakes have been made in the wiring, we can proceed with the alignment. The first step is momentarily to place a pair of 'phones, bypassed by a 0.001- $\mu$ f. condenser, in the plate circuit of the 6L7 mixer. This will make possible the alignment of the t.r.f. stages and calibration of the dial. One of the reasons for the use of the Type B dial was the fact that a slot is provided in the face for logging purposes. The 10:1 ratio also comes in handy when setting the e.c.o. frequency accurately. Of course one should be sure that this part of the set is stable before proceeding further. As all circuits are decoupled, little or no instability should be encountered. Magic eye No. 1 should function when the various broadcast stations are tuned in. This tube supplies a.v.c. voltage to the mixer and second r.f. stages, and this voltage should be checked.

The b.f.o. can now be put into operation by tuning in the broadcast station that is to be used as the "i.f. determiner" and then rotating  $C_{21}$

until a beat is heard.  $C_{21}$  should be set so that zero beat falls in the middle of the dial scale of the panel-controlled vernier,  $C_{22}$ . The size of  $L_1$  should be changed if stations at the high-frequency end of the broadcast band are used, but it is an easy matter to modify the coil so that a sizeable amount of  $C$  is kept in the circuit.

The b.f.o. circuit should be well shielded and coupled very loosely to the broadcast circuits. This is because the oscillator tends to pull into step with the broadcast stations as zero beat is approached, particularly if the station puts in a large signal and the r.f. gain of the receiver is high. The condition of zero beat can be obtained readily and observed by the magic eye's slowly fluttering to a motionless state between the two audible and visible beats on either side. But when the t.r.f. circuits are tuned to another station for checking purposes, the b.f.o. no longer receives energy to lock it in, and consequently its frequency may shift slightly. With suitable shielding and loose coupling, plus avoidance of high signal inputs when setting the b.f.o. on frequency, this can be eliminated. The eye will come to rest at zero beat and will not pick up speed as the t.r.f. dial is detuned from the "determiner" station.

The b.f.o. can then be cut out and the i.f. amplifier aligned, preferably with a test oscillator, to the proper frequency. Magic eye No. 2 should function and a.v.c. voltage developed by the 6R7 should be present on the i.f. grid. Next, the 'phones should be replaced by the i.f. primary in the first-detector plate circuit. By increasing the r.f. gain, sufficient voltage can be developed to cause cross-talk in the i.f. amplifier and consequently signals can be heard in the monitoring speaker before the r.f. oscillator of the superhet is placed in operation. These signals will vanish if the r.f. gain is reduced.

The high-frequency oscillator of the receiver (the e.c.o.) can next be put into operation by turning  $SW_1$  to the "monitoring" position, in which the plate voltage is cut off the buffer and the oscillator is turned on even though the keying relay is open. The coupling of  $L_1-L_2$  should be close. Then if the h.f. oscillator panel control ( $C_2$ ) is turned to maximum capacity, the t.r.f. portion of the receiver should be tuned to the station which is going to give the check point nearest to 3500 kc.  $C_1$ , located below the chassis, should then be tuned carefully until this station is tuned in. With the constants given,  $C_2$  will then just cover the 3.5-Mc. band.

An explanation of the keying system is now in order as its adjustment comes next. In practically all keyed e.c.o. circuits previously described the tuned circuit is disturbed or the current drawn by the tube is cut off or materially reduced in the key-up position. The arrangement employed here does neither of these things and for this reason contributes greatly to the stability of the keyed

(Continued on page 88)

# Safety Devices for Amateur Transmitters

*A Résumé of Representative Manual and Automatic Methods*

BY GEORGE GRAMMER,\* WIDE

**T**HERE is one thing to be remembered about devices designed to protect you from shock when you're working on a transmitter — don't let the fact that they're there lull you into a false sense of security. In amateur practice at least, these devices should be regarded as purely supplementary to the all-important rules of personal conduct outlined in last month's *QST*<sup>1</sup> and re-

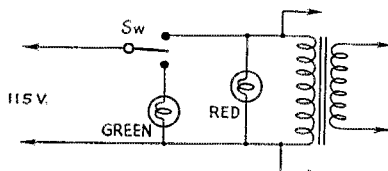

Fig. 1 — A simple and positive warning-light circuit. "Safe" is indicated only when the green lamp alone is lighted; one or the other must be on at all times. Burn-outs are immediately apparent.

peated elsewhere in this issue. The ABC of safety is not to be found in tricky gadgets, but in your own behavior.

With that in mind, we are prepared to discuss the last of the three phases of the safety problem mentioned in March *QST*, that of special arrangements whose purpose is to prevent power's being

\* Technical Editor.

<sup>1</sup> "Safety Technique in Transmitter Operation and Construction," *QST*, March, 1939.

## DID YOU READ THE ARTICLE ON ARTIFICIAL RESPIRATION?

There may be some amateurs who have not yet read the article on "Resuscitation from Electrical Shock" beginning on page 16 of our February issue; if so, we want now to call it to their attention. We consider it vital for every amateur to absorb the substance of that article or its equivalent. Knowledge of the technique of resuscitation may enable you to save a fellow amateur's life. Instructing others about it may save your own. We recommend that amateurs practice artificial respiration upon each other, and we commend the subject particularly to the attention of all radio clubs.

on the transmitter circuits when the operator goes near it. The number of ideas that has been proposed is large, but practically all of them fall into one or another of a few classifications which we shall characterize broadly as warning signals, manually-operated devices of a positive nature, automatic devices, and special insulation. We won't attempt to credit the sources of the various ideas discussed; many of them, indeed are as old as the proverbial hills, while most of the rest have occurred to more than one individual.

## Warning Signals

The gleaming pilot light is an almost irresistible attraction to the amateur constructor, and we commonly find several on even an unpretentious transmitter. Pilot lights aren't of much value, however, as warning signals. They may burn out at any time, and too seldom are they placed

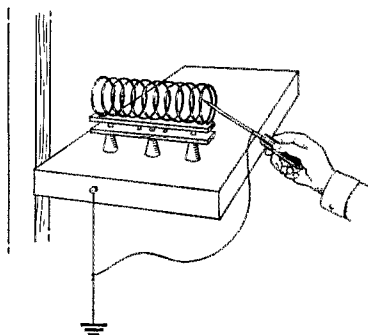

Fig. 2 — A ground wire and probe forms a simple means of finding whether voltage is on a component about to be touched. It will also discharge filter condensers.

where they can be seen from anywhere except in front of the transmitter, which is already a safe enough place to be if the construction rules listed in March *QST* are followed.

To be most effective, a warning signal ought to be at the point where the danger lies. If you want to be warned that the power is on when you go to change coils, put the lamp right where you can't help but see it when you approach the dangerous spot. It doesn't have to be conspicuous from safe positions — in fact, it may be advantageous not to have it stand out too prominently under those circumstances; it won't become so familiar as to be overlooked when you do go back of the trans-

mitter. Make it big enough and bright enough to thrust itself into your consciousness even though your primary thought is to get the coil changed or the adjustment made.

The danger of burnout can be minimized by using two lamps in parallel. If the light is for warning purposes and not merely for decoration, a single lamp is actually a hazard; you can't tell whether or not it means what it says when it gives the "all clear—go ahead" signal. With two lamps in parallel, the chances are slight that both will burn out at the same time. When one of them does go, as it will in time, it should be replaced immediately.

The best place to connect signal lamps is across the primary of the plate transformer, or across the 115-volt line supplying all the power circuits in the transmitter. This means 115-volt lamps, of course. Low-voltage lamps working from an unused transformer secondary are not quite as reliable; there is one more piece of apparatus between them and the line, one more possible point of unexpected failure. Use first-quality lamps.

A useful variation of the signal-lamp idea is shown in Fig. 1. It has the advantage of giving positive indications for "on" and "off" and requires only the use of a single-pole double-throw switch instead of the customary s.p.s.t. The two lamps can be differently colored—the conventional red for "danger" and green for "safe" are good because they are familiar to everyone. The switch must be of the type (such as a toggle) with no open position so that when one circuit is broken the other is made automatically. In any event, look out for trouble when both lamps are out, and don't touch the transmitter unless the "safe" signal, and that one alone, is on.

A lamp is probably the most generally useful type of warning signal, since it is compact and quiet in operation. A buzzer could also be used, and has the advantage of calling attention to itself regardless of whether or not you look at it, but its noise might not be tolerable under all circumstances. If it is muffled down, it may not be loud enough to be effective as a signal.

One device which combines warning and utility is an electric fan, connected across the line or transformer primary, to remove some of the heat

from the transmitter. A strategically-located fan can hardly be ignored when you go to change coils.

### Manually-Operated Protective Devices

The usefulness of a manually-operated protective device depends almost entirely on how thoroughly one forms the habit of using it. In this respect it is no better than the line switch. However, a few of them do have additional merits over the plain switch, and since they are simple to install they deserve incorporation in transmitting layouts.

For instance, take such a simple arrangement as the ground wire and probe shown in Fig. 2. More explanation than the picture gives should hardly be necessary; the grounded probe is simply contacted to the exposed metal of the coil or whatever it is one intends to handle. If the power is on, or the bleeder has burned out, there will be no doubt whatever about it when the contact is made. The operator is perfectly safe, since he is on the grounded side of the circuit. Of course, the transmitter itself should be grounded, as recommended in March *QST*.

An ice pick or any similar easily-handled gadget with a sharp point can be used for the probe. The flexible wire need not be insulated, since it is used altogether for shorting purposes. A wooden handle on the probe is desirable psychologically and also practically, since it can be fitted out with a screw-eye and the probe kept on a convenient hook on the transmitter. The thing is so simple and, if used habitually, so effective that it deserves to be added to any transmitter.

A metal chain has been suggested for the same purpose. The goodness of the contact between links may be questioned, however, and for that reason the flexible wire will be preferred by many. The chain does have a high order of flexibility, however, and readily can be thrown over a chassis so that all dangerous components can be simultaneously and continuously grounded while the coil is being changed.

The series shorting plug scheme shown in Fig. 3 also is very simple and effective, providing one forms the habit of using it every time the transmitter is approached. The socket should be mounted in a convenient place on the operating table; when the plug is out, no power can get to the transmitter. If you carry the plug with you, you know the power is off and that no one can turn it on. This is likewise a good gadget for making sure that the transmitter is dead when you're not in the station; if the junior operators try throwing a few switches in your absence nothing can happen. Incidentally, the socket also will take a plug-in extension switch for use when you have to look into the rig with the power on—when shooting trouble, for instance.

This idea can be elaborated on a bit by installing a combination switch and lock of the type

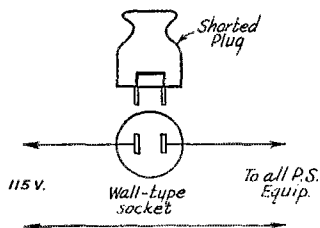

Fig. 3—A series shorting plug is easily installed and makes sure the power is off when carried with the operator.

used for automobile ignition circuits instead of the socket and shorted plug. Also, warning lights can readily be installed as a reminder to pull out the plug or key.

### Automatic Devices

In the field of automatic devices for turning off power there is so much room for variation in detail that it is impossible to describe specific arrangements. The "interlock" idea is inherent in all of them. A specified operation, such as opening the door of a cabinet, is made to turn off the power automatically before the operator can reach

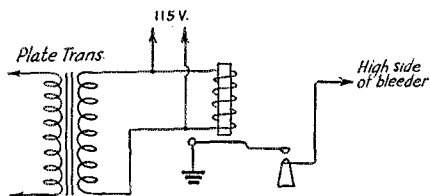

Fig. 4 — Circuit of gravity-operated relay for shorting the output of the power supply when the primary power is cut off, thus ensuring the discharge of filter condensers.

any dangerous apparatus. Included in this classification are such things as railing off the transmitter so that it must be approached through a gate which opens the power circuits, moving floor-board arrangements which accomplish the same purpose, rope barriers, door interlocks and other devices of a similar nature. Several systems of this type were described some time ago in *QST*.<sup>2</sup> So much depends upon the method of transmitter construction and the location of the set that it is impractical to attempt detailed treatment; the necessary adaptations of the general principle must be made by the individual. On the whole, these devices are excellent in principle and, if completely followed through, equally so in practice. The points against them are two — the extra trouble and difficulty of installation, and the tendency to put jumpers around the interlocks when some testing is to be done and then to forget to remove them subsequently. A safety device out of commission is worse than none at all because of the reliance placed on it.

Closely associated with the automatic device for turning off power is the type which, when the power is turned off, automatically shorts the power supply. This is positive protection against bleeder failure, and therefore worth while. A good example of this type of device is the gravity-operated relay recently described in *QST*<sup>3</sup> and reproduced here diagrammatically in Fig. 4. Because it is gravity-operated, there is no danger of

failure to operate because of a weak spring, and the contacts cannot stick in any position which is dangerous to the operator — although a sticking contact might not be so good for the power supply. The transformer primary should be fused to protect the power supply; an overload circuit breaker also could be used for the same purpose, although its coil should be connected in the circuit between the rectifier and filter so that the shorting path for the gravity relay is directly across the filter output and not through the circuit-breaker coil.

This same idea can be adapted to the interlock system; that is, opening the door of the cabinet can close a switch across the filter output at the same time that the normal interlock opens the primary power circuit.

### Insulation

As additional protection, an insulating barrier to isolate grounded objects in the vicinity of the transmitter is a sound idea. Concrete floors, for example, have been the cause of more than one shock, because concrete is a fair conductor, especially when moisture from the ground seeps into it. If the operating room floor is not dry wood or a similarly-good insulating material, it is advisable to surround the transmitter with rubber matting, or to mount it on a wooden platform of ample dimensions so that you are isolated from the floor when changing coils or making adjustments.

The same sort of protection ought to be applied to radiators or other grounded conducting objects near enough to the transmitter so that they can be touched when adjustments other than tuning are carried on. These precautions constitute an extension of Rule F of the ABC's. In even more general terms, never let any part of your body touch any grounded objects when you are handling a part of the circuit normally at high voltage.

In passing, rubber gloves should be mentioned in connection with the subject of extra insulation. Available information indicates that the ordinary "kitchen" variety of glove is not to be trusted because of the possibility of pinholes. Regular linesman's gloves are, of course, too heavy for work around a transmitter. At any rate, dependence should not be put on gloves unless they can be tested regularly.

On the whole, this brief review of the general subject of safety devices serves but to emphasize the importance of personal precautions over those of a mechanical nature. If an automatic safety device can be installed, so also can it be taken out of service — temporarily perhaps, but restoring it to service *may* be overlooked — while the manually-operated devices depend wholly on memory or habit. In the end, then, there is no substitute for "Always Be Careful."

<sup>2</sup> "How Would You Do It?"; *QST*, June, 1937.

<sup>3</sup> See page 54, *QST*, March, 1939.

A simple a.c. voltmeter utilizing two 6H6 rectifiers instead of the usual oxide-film type. The case contains the multiplier resistors, a small flashlight cell and a transformer for the 6H6 heaters. The correction-curve is fastened to the cover of the case.

# A 6H6 A.C.-D.C. Voltmeter

BY CHARLES W. CARTER,\* W3EZZ

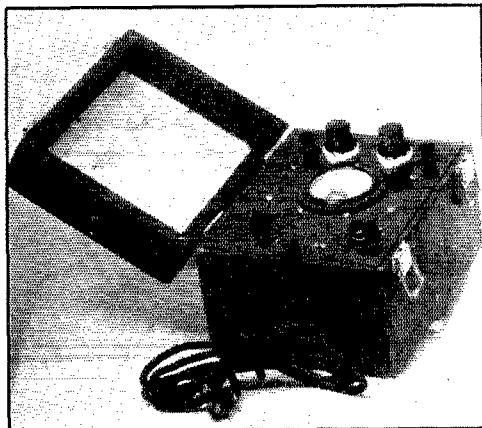

CERTAIN poor qualities that are inherent in the average oxide-film rectifiers used in high-resistance a.c. voltmeters resulted in the development of a rugged instrument that is not affected by extreme temperature variations. It uses two 6H6 diode rectifiers connected in a full-wave bridge circuit, a 0-1-ma. meter and suitable series resistors. Current for the heaters of the tubes is furnished by a small 115/6.3-volt transformer contained in the instrument.

The circuit is conventional with the exception

\* RFD 2, Charlottesville, Va.

of  $SW_1$ , which permits line voltage to be read directly without the necessity of connecting leads from the line to the voltage terminals. This switch also disconnects the 10-volt scale, to preclude possible burn-out of the instrument should  $SW_2$  have been left on point 1. The meter will read line voltage accurately down to 60 volts, although at this point the heaters have only one-half rated voltage. It is interesting to note that the total instrument burden compares favorably with commercial a.c. voltmeters.

In setting up the circuit it was found that when the cathodes of the 6H6 tubes were heated, stray electrons would strike the plates, even when unpolarized, resulting in a steady-state current of about 0.4 ma. A small amount of negative voltage obtained from a single flashlight cell applied to the plate corrected this difficulty. This voltage is not critical.

The multiplier resistors were chosen so as to have minimum inductance. This was accomplished by having the fixed resistor in each range a non-wire type with a small wire wound adjustable in series for calibration purposes. The values in this case were for 0-10, 0-100, 0-300 and 0-1000 volt ranges.

Inspection of the calibration curves will show that, for practical purposes, the scale represents a straight line with increasing voltage. Correction curves are mounted under a celluloid cover in the top of the instrument case. Further examination of the curves will show that the internal resistance of the diodes does not increase until a current of 0.7 ma. has been reached. The use of two more tubes, one in parallel with each of the two shown, would hold the internal resistance constant within range of the meter. A more practical solution would be to use a 500-microampere meter, with a proportionate increase in multiplier resistance. This would eliminate the necessity of correction curves.

This instrument reads direct current voltage

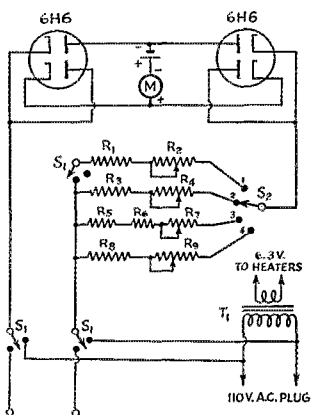

Fig. 1 — The 6H6 Voltmeter.

- R<sub>1</sub> — 5000-ohm carbon.
- R<sub>2</sub> — 1000-ohm wire-wound adjustable.
- R<sub>3</sub> — 70,000-ohm carbon.
- R<sub>4</sub> — 15,000-ohm wire-wound adjustable.
- R<sub>5</sub> — 200,000-ohm carbon.
- R<sub>6</sub> — 25,000-ohm carbon.
- R<sub>7</sub> — 50,000-ohm wire-wound adjustable.
- R<sub>8</sub> — 800,000-ohm carbon.
- R<sub>9</sub> — 100,000-ohm wire-wound adjustable.
- $SW_1$  — 3-pole two-position switch.
- $SW_2$  — Single-pole 4-position switch.
- T<sub>1</sub> — 6.3-volt transformer.
- M — 0-1-ma. meter.

with the same accuracy as indicated for alternating current voltage. The terminals are unpolarized.

Although we do not have available a precise standard for audio frequency voltages, sufficient tests have been made to indicate an accuracy within 5 per cent throughout the audio-frequency range.

The series resistors can be accurately adjusted by comparing the meter with a borrowed a.c. voltmeter, or a d.c. source and comparison meter can be used. In the latter case, however, the meter will indicate average values when used with a.c., and so the resistors are adjusted to give readings that are 10 per cent low. For example, if 100 volts d.c. is used, the resistor is adjusted so that the meter reads 90 volts. If the d.c. source were 90 volts, the meter should read 81 volts. Following this procedure, the meter will correctly indicate r.m.s. values when used with a.c. and will always read 10 per cent low on d.c.

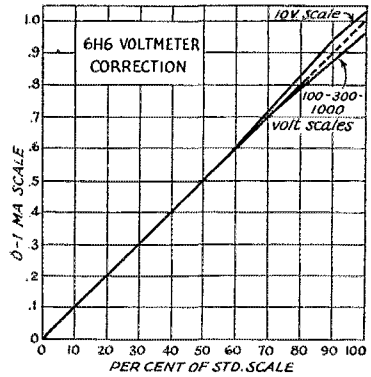

The correction curve used with the a.c. voltmeter. The slight correction is only necessary in the higher portion of the scale (see text).

# Extending Freq-Meter Calibrations with the 100-Kc. Oscillator

*A Simple Method for Determining Intermediate Calibration Points*

BY R. L. BUNT,\* VE3MX

FOR the past month or so I have been experimenting with a 100-kc. oscillator similar to that described in the 1938 *Handbook*. Not being satisfied with calibration points at every 100 kc.

across the freq-meter graph (i.e., at 1700, 1800, 1900, 2000 and 2100 kc.), an arrangement was evolved whereby additional calibration points were easily obtained.

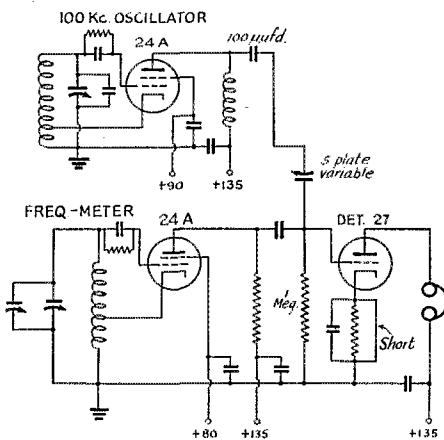

Fig. 1—The 100-kc. oscillator is coupled to the freq-meter monitor through a small variable condenser, and points between the 100-kc. spots can be determined.

The equipment used was the usual two-tube freq-meter monitor shown on page 369 of the 1938 *Handbook* closely coupled to the 100-kc. oscillator shown on page 371, with the plate power furnished by batteries. Only one simple modification was found necessary in order to secure the extra calibration points, and that was to short out the cathode resistor of the detector tube. This increased the sensitivity of the tube to such an extent that dozens of new beat notes were heard as the freq-meter dial was turned. It occurred to me that if I could identify at least a few of these "birdies," it would be possible to check the calibration very closely over the whole range.

In order to avoid confusion in identifying the new points, a midget 5-plate variable was inserted between the 100-kc. oscillator output and the grid of the detector, to act as a variable-coupling control. This coupling was reduced until it was possible to hear but one beat note between each of the original 100-kc. calibration points. On checking

\* 251 Fifth Ave., Apt. 2, Ottawa, Ont., Canada.



Freq-meter Frequency Kc.	Harmonic	beating with	100-Kc. Oscillator Harmonics
1700.....	1		17
1725.....	4		69
1733 $\frac{1}{2}$ ....	3		52
1740.....	5		87
1750.....	2		35
1760.....	5		88
1766 $\frac{3}{4}$ ...	3		53
1775.....	4		71
1780.....	5		89
1790.....	10		179
1800.....	1 (5)		18 (90)
1825.....	4		73
1833 $\frac{1}{2}$ ....	3		55 91*
1840.....	5		92
1850.....	2		37
1860.....	5		93
1866 $\frac{3}{4}$ ...	3		56
1875.....	4		75
1880.....	5		94
1890.....	10		189
1900.....	1		19

\* Beats with 5th F-M harmonic of 1820.

with the curve drawn from the five original points, and with the assistance of pad and pencil, it was deduced that these extra points resulted from second harmonics of the freq-meter beating with the 35th, 37th, 39th and 41st harmonics of 100 kc., producing beats at 1750, 1850, 1950 and 2050 kilocycles.

After locating and identifying the 50-kc. points, the coupling was increased, revealing a trio of new beat notes in each 100-kc. section. The first of these notes was readily identified as 1725 kc. The second beat which was located approximately one degree and a half on the dial from the first beat (1725 kc.) proved to be a poser for awhile, but it was finally identified as the third freq-meter harmonic of 1733 $\frac{1}{2}$  beating with the 52nd harmonic of 100 kc. The third tied in at 1775 on the curve. Similar beats were found in each 100-kc. section across the freq-meter dial and were plotted on the graph.

In view of the recent change in the 160-meter band, the calibration curve was made to cover

1750-2050 kc., to include two points at 1700 and 2100 kc. respectively, which serve as reliable guide-posts in identifying the first and last 50-kc. points which mark the edges of the band itself. The attached table shows the frequencies produced by beating together the various harmonics produced by both freq-meter and the 100-kc. oscillator. The 100-kc. oscillator harmonics have been segregated in order to show the definite order of progression which the harmonics follow. Using the same freq-meter harmonics as shown in the table, simply add 100 kc. to each frequency listed and continue the series throughout the 1900-2000 section. The same procedure may be followed for the 2000-2100 section.

By increasing the coupling still further, many other beat notes will be heard, but it is difficult to identify many of these. However, with at least six reliable calibrating signals available in each 100 kc., accurate calibration should prove an easy task with this method. Needless to say, the 100-kc. oscillator should always be kept at exactly zero beat with the broadcast marker station used for setting the 100-kc. oscillator.

## WWV Schedules

**E**ACH Tuesday, Wednesday and Friday (except legal holidays), the National Bureau of Standards station, WWV, transmits with a power of 20 kw. on three carrier frequencies as follows: 10:00 to 11:30 A.M., E.S.T., on 5000 kc.; noon to 1:30 P.M., E.S.T., on 10,000 kc.; 2:00 to 3:30 P.M., E.S.T., on 20,000 kc. The Tuesday and Friday transmissions are unmodulated c.w. except for 1-second standard-time intervals consisting of short pulses with 1000-cycle modulation. On the Wednesday transmissions, the carrier is modulated 30% with a standard audio frequency of 1000 c.p.s. The standard musical pitch A = M440 c.p.s. is also transmitted from 4:00 P.M. to 2:00 A.M., E.S.T., daily except Saturdays and Sundays, on a carrier frequency of 5000 kc., power 1 kw., 100% modulation. The accuracy of the frequencies of the WWV transmissions is better than 1 part in 5,000,000.

## ~~Strays~~

We understand that W. L. ("Lou") North has been named as F.C.C. radio inspector at Miami. In addition to having been for some years operator and assistant chief engineer of KVI, he is better known to our gang as W7BHE. Another active ham and League member as RI, so whoops! Congratulations, Lou.

-----

A recent correspondent, explaining that he was not a League member, wrote that he "buys a copy of *QST* from the newsstand every week." Wonder what he does with 'em!

# A Hurricane Emergency Receiver

*A Simple Battery Job for General Use When Power Fails*

BY GALE M. SMITH,\* W4BPB

EVERY summer, when Floridians tear the June leaf off their calendars, they begin to think about hurricanes. They know that there will be at least one hurricane alarm before November has passed, for from six to ten tropical hurricanes will be born east of the Windward Islands between July 1st and December 1st and will spin slowly northwestward toward the United States. All our eastern coastline from Brownsville, Texas to Eastport, Maine is exposed to these storms, but Floridians have always been more "hurricane-conscious." Since the New England hurricane, perhaps the rest of the nation will also become aware of the menace of these tropical disturbances.

A hurricane emergency brings about intense activity in many radio channels. Broadcast stations run telephone loops to the Weather-Bureau offices and give broadcasts of the progress of the storm. The Department of Commerce aeronautical radio stations near 1100 meters give weather reports at regular intervals. Ships send in weather observations. Coastal telegraph stations broadcast special weather advice to ships. Amateur nets are set up to function in case of emergency. Power companies, telephone companies, telegraph companies, national guard units, etc., have emergency radio equipment which they prepare to place in operation.

Whether or not a ham is participating in an emergency net, he finds a receiver very necessary

\* 4170 Ingraham Highway, Miami, Fla.

to keep posted on the progress of a storm. If the storm comes too close, power lines will be de-energized as a matter of public safety, or will be broken by falling trees. The man with the a.c. receiver is then cut off from all contact with the outside until days or weeks later, when power service is restored. At the time when he needs his receiver the most, it is not functioning.

In 1935, the value of a battery receiver was demonstrated to the writer. The house had been

prepared for nasty weather by placing storm shutters over all windows. When the force of the wind became too great for comfort, there was nothing to do but to retire inside and await developments. Wind-lashed limbs soon broke the power lines and further weather bulletins were received over a battery receiver. Soon the wind tore down the antenna towers of the local broadcast stations, so the receiver was tuned to 600 meters and the complete storm information

was picked up from nearby coastal telegraph stations. The distress signals of the steamship "Dixie" were also received. The coastal stations advised of the passage of the center of the storm over Miami, at which time there was a complete cessation of the wind for fifteen or twenty minutes. The uninformed might have ventured outside, thinking that the storm was over. This was far from the truth, for as soon as the center of the disturbance passed over, the wind commenced to blow violently from the opposite direction and the hurricane continued for several hours.

Here is a simple battery-operated receiver covering the range 2 to 2000 meters made chiefly from spare parts from the junk box. It should be of interest not only to those who prepare themselves to take part in emergency communications but also to anyone who wishes to keep posted on the progress of an emergency when power fails.

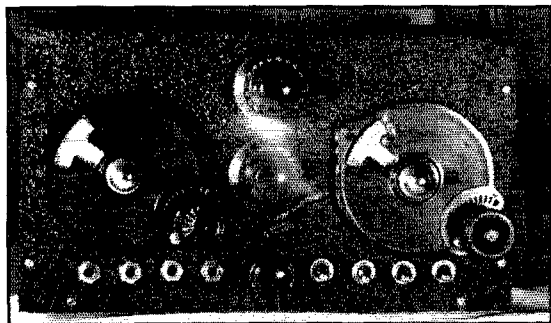

The left-hand dial is the main tuning control and the right-hand dial is for the band-spread condenser. In the center, the top knob is the regeneration control resistance, the one immediately below it the regeneration-control condenser and the bottom knob is the volume control and on-off switch. From left to right the jacks under the main tuning control are: detector, first audio and two in series for the second audio. Under the band-spread dial, the four toggle switches are: plate on-off switch, doublet-Marconi antenna switch, antenna tuning-condenser switch, and superregeneration switch.

At the lower left is the shielded detector tube. Directly above it is the plug-in coil. Above the coil is the band-spread condenser with its insulated shaft coupling and the midget double-pole double-throw switch for changing the tuning circuit. Close to the switch may be seen the screw-driver-adjusted filament rheostat. At the right of the plug-in coil is the shielded quench-frequency oscillator coil. At the right of the detector tube is the terminal strip for the doublet antenna and beside this is the antenna trimmer condenser. The large regeneration-control condenser is in the center at the top and at the extreme right is the main tuning condenser. The two tubes and transformers below are components of the first and second audio stages. Note that radio-frequency leads and ground bus are run above the chassis with stiff self-supporting bus bar to provide short, direct connections.

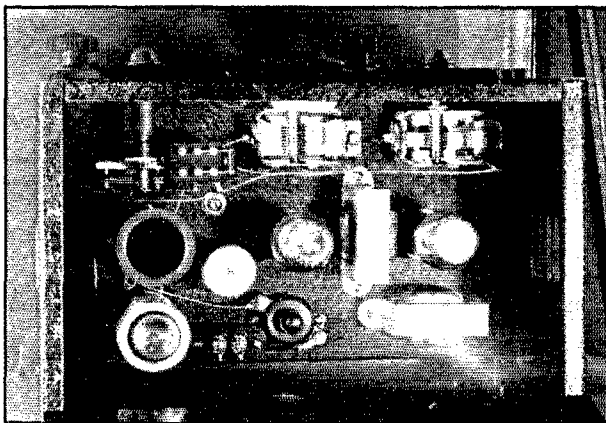

From experience gained with this early hurricane receiver, the present receiver was designed to overcome the difficulties experienced with the first model. The new receiver gave excellent service during the 1938 storm season and was successfully used in two local Field Day contests. The principal requirements in mind when the little set was built were simplicity, low cost, low power consumption, reliability, and wide tuning range. Low cost was considered to be of prime importance because of the present unemployment situation in the radio engineering field. As a result, nearly everything that went into the receiver was resurrected from the junk box. Less than a dollar was spent on additional parts. If any ham wants to build up a simple emergency receiver like this, undoubtedly he can find enough parts in the junk box to do the job without incurring any expense whatsoever.

The circuit, shown in the diagram, will be recognized as a modification of the old reliable regenerative detector circuit with two stages of audio. It was chosen because of its simplicity and reliability as well as from the consideration of economical battery requirements. With suitable coils, the receiver will cover all frequencies between 112 and 0.15 Mc. Besides the amateur bands, these include the broadcast band as well as the marine and coastal frequencies below the broadcast band in frequency.

Provisions are made for superregenerative operation at the ultra-high frequencies. At these frequencies, the special coil is connected between grid and plate. By throwing  $S_3$ ,  $C_2$  is also connected between grid and plate forming an ultraudion circuit.  $S_4$  cuts in the quench-frequency circuit. The chokes labelled *r.f.c.* are small in size and are designed to be effective at the higher frequencies. Parallel feed is effective at the lower frequencies by virtue of the impedances provided by  $R_1$  in the grid circuit and  $L_3$  in the plate circuit.

The problem of tuning was solved by the midget double-pole double-throw switch  $S_3$  in the

detector tuned circuit. The switch in one position connects band-spread condenser  $C_2$  between grid and plate, for tuning on ultra-high frequencies, as previously mentioned, and disconnects the main tuning condenser  $C_4$ . In the other position, the switch places both condensers in parallel for conventional low-frequency operation. In this circuit the band-spread condenser rotor must be insulated from ground.

Regeneration control is effected by means of a variable resistance  $R_5$  in series with the plate supply of the detector. This provides smooth regeneration control with practically no change in frequency. The detector is first set near regeneration by adjusting the large throttle condenser  $C_3$ , which does affect the frequency of the detector tuning; fine adjustments are then made with the resistance control. The detector oscillates readily on all wavelengths. Oscillations were obtained, as an experiment, even by clipping a 1½-inch jumper from pin No. 3 to pin No. 5 of the coil socket. With the coils used, the point of oscillation varied widely from coil to coil, so that the combination of condenser and resistance control turned out to be not only convenient but absolutely essential to satisfactory operation.

On the lower frequencies there was a slight tendency toward fringe howl. This was cured completely by placing a shield can over the detector tube.

In order to reduce the power-supply requirements to a minimum, it was decided to use transformer-coupled audio stages which will function quite satisfactorily on as little as 22½ volts of "B" battery, if a higher voltage is not available. But the use of transformer-coupled stages in a damp tropical climate is not as simple as it sounds, for audio transformers are generally a great menace to reliability. The original receiver had been discarded because a set of transformers would not last longer than two months and noise often developed within a week after installation. This trouble was overcome by shunt feeding the audio

stages, leaving the transformer primaries grounded. Connected in this manner, even the cheapest audio transformers will last indefinitely. Cutting the "B-plus" lead when the receiver is not in use is an alternative, since transformer disintegration is brought about by maintaining the primary winding at a high positive potential. Electrolysis occurs, especially in the tropics and near the seacoast, and the fine wire of the primary is soon turned into verdigris.

With voltages as low as  $22\frac{1}{2}$ , feeding an audio amplifier plate through a resistor was out of the question, leaving the use of choke feed as the only solution. Audio chokes are subject to the same effects of electrolysis as audio transformers; besides this, there were no audio chokes in the junk box. What to do? Well, just slap in two midget filter chokes. These chokes are many times as sturdy as audio transformers and, with the additional protection of a switch  $S_6$  to cut the "B-plus" lead when the receiver is not being used, they should last many years. In spite of the fact that these chokes are not designed for the purpose, the audio quality is perfectly satisfactory for code reception and is surprisingly good on broadcast reproduction.

The detector and first audio stages are provided with jacks and the second audio stage has two jacks in series permitting the use of two sets of 'phones at the same time. Thus, failure of one of the audio stages does not prevent the use of the remainder of the receiver. If one tube burns out

and no spares are available, good tubes may be placed in the detector and first audio positions and the set will give good results. If one tube is available, the 'phones can be plugged into the detector output and excellent earphone reception may be obtained using the set as a one-tube receiver.

The antenna circuit was designed to use a doublet antenna on short waves. By throwing the double-pole double-throw toggle switch  $S_1$  to the downward position, both legs of the doublet are tied together and the antenna feeds through the antenna coil  $L_1$  to ground. This makes the doublet function as a Marconi antenna for broadcast and long-wave reception. A small adjustable trimmer condenser  $C_1$  is used to vary antenna coupling and is shorted out by a single-pole single-throw toggle switch  $S_2$  when the antenna is being used as a doublet.

The only coils available were two sets of ICA plug-in coils. The broadcast and short-wave coils had six prongs, but the long-wave coils had four prongs. A six-prong socket was used in the receiver; this necessitated the use of an adapter on long waves. This adapter is easily constructed by removing the solder from the pins of an old tube base and dropping a wafer socket down on top of it in such a way that short leads from the wafer-socket lugs come out through the hollow pins of the tube base. Solder secures these leads to the pins and holds the wafer socket firmly in place on top of the tube base, making an excellent adapter.

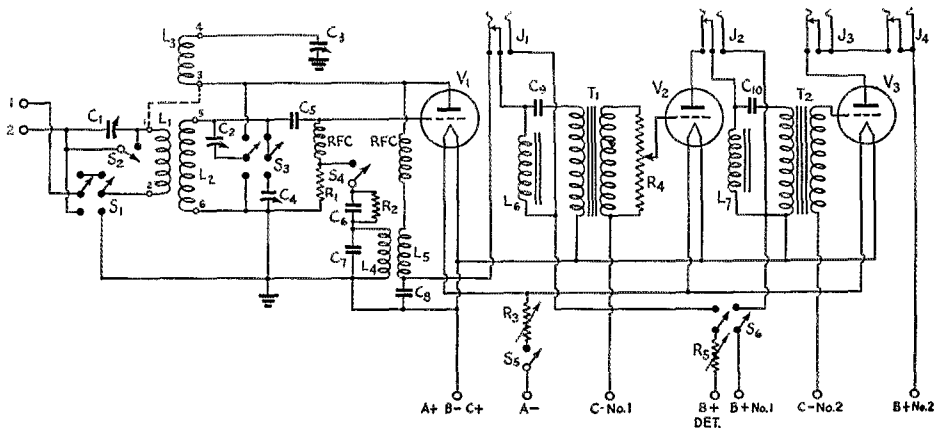

Fig. 1 — Circuit diagram of hurricane receiver.

- $C_1$  — 5-30- $\mu$ fd. antenna trimmer.
- $C_2$  — 15- $\mu$ fd. bandspread condenser.
- $C_3$  — 0.00025- $\mu$ fd. regeneration control condenser.
- $C_4$  — 0.00015- $\mu$ fd. tuning condenser.
- $C_5$  — 0.000125- $\mu$ fd. mica grid condenser.
- $C_6$  — 0.00025- $\mu$ fd. grid condenser.
- $C_7$  — 0.0005- $\mu$ fd. condenser.
- $C_8$  — 0.005- $\mu$ fd. by-pass condenser.
- $C_9, C_{10}$  — 0.1- $\mu$ fd. tubular coupling condensers.
- $R_1$  — 6-meg. detector grid leak.
- $R_2$  — 3000-ohm quench-oscillator grid leak.
- $R_3$  — 30-ohm filament rheostat, screwdriver adjustment.

- $R_4$  — 100,000-ohm volume control.
- $R_5$  — 50,000-ohm regeneration control.
- $L_1, L_2, L_3$  — plug-in coils, short-wave, ICA No. 1428 (see Coil Table); broadcast, ICA No. 1476; u.h.f., ICA No. 1475; long-wave, ICA No. 1484.
- $L_4, L_5$  — National OSR oscillator coil.
- $L_6, L_7$  — 30-henry filter chokes.
- $T_1, T_2$  —  $3\frac{1}{2}$ -to-1 audio transformers.
- RFC — 2 $\frac{1}{2}$ -millihenry chokes.
- $V_1, V_2, V_3$  — RCA Type 30.
- S — See text for discussion of switches.

COIL TABLE

Range Meters	Grid Coil			Antenna Coil			Tickler Coil		
	Turns	Wire Size	Length Winding	Turns	Wire Size	Length Winding	Turns	Wire Size	Length Winding
9.5-21	3 $\frac{3}{8}$	20 d.c.c.	1 $\frac{3}{8}$ "	2 $\frac{7}{8}$	28 e.c.	Inter-wound	7 $\frac{3}{8}$	28 e.c.	Close wound
16-38	7 $\frac{7}{8}$	16 e.c.	1 "	4 $\frac{1}{2}$	30 d.s.c.	"	5 $\frac{1}{2}$	28 e.c.	"
35-75	17 $\frac{7}{8}$	30 e.c.	1 $\frac{1}{4}$ "	7 $\frac{7}{8}$	30 d.s.c.	"	6 $\frac{1}{2}$	28 e.c.	"
73-137	28 $\frac{7}{8}$	30 e.c.	$\frac{3}{8}$ "	11 $\frac{7}{8}$	30 d.s.c.	"	13 $\frac{1}{2}$	28 e.c.	"
135-200	49 $\frac{7}{8}$	30 e.c.	1 $\frac{5}{8}$ "	16 $\frac{7}{8}$	30 d.s.c.	"	17 $\frac{7}{8}$	28 e.c.	"

All coils except the 10-meter coil are wound on 1 $\frac{1}{2}$ -inch ribbed bakelite forms; the 10-meter coil is wound on a 1 $\frac{1}{4}$ -inch ribbed bakelite form. The antenna coil for each band starts at the ground end of the grid coil and is wound between the turns of the grid coil. Each tickler coil is close-wound and spaced  $\frac{1}{4}$ -inch from the ground end of the grid coil, with its B-plus end closest to the grid coil. The ground end of the grid coil connects to pin 6, the grid end to pin 5. The ground end of the antenna coil connects to pin 2, the antenna end to pin 1. The plate end of the tickler coil connects to pin 3 and the B-plus end to pin 4. All windings are made in the same direction.

The long-wave coils are bank-wound and cannot be readily duplicated.

An additional connection, shown in the diagram in dotted lines, is made inside the adapter so that some form of antenna coupling is provided for long-wave operation. The long-wave coils have but two windings, so the tickler coil serves double duty as feed-back and antenna coil.

The ultra-high-frequency coils are homemade. The windings are self-supporting, and are placed *inside* old tube bases, the bases providing the necessary six-prong plugs as well as protecting the coils. The tuning coils and antenna coils are mounted horizontally, in inductive relation, with the ends of the wires soldered firmly into the proper pins. The antenna coils are connected to pins 1 and 2, and the tuning coils to pins 3 and 5. The range covered by each coil as well as the results obtained depend in large measure upon the placement of the various circuit components and the shortness of connecting leads. It is therefore necessary to arrive at the correct coil dimensions for a specific u.h.f. band by a process of experimentation, rather than following some coil-winding recipe. For this purpose a Lecher wire system was loosely coupled to the coil under test, and was employed very much as an absorption-type wavemeter would be used. Setting the detector in oscillation, and sliding a shorting bar along the Lecher wires, a loud click marked each point where the Lecher system came into resonance with the detector and killed oscillation. The distance between any two of these points was converted into wavelength.

The coil finally adopted for the five meter band is  $\frac{3}{8}$ -inch in diameter, and consists of 5 $\frac{1}{2}$  turns of No. 18 enamelled wire spaced so that the ends of the coil drop into the proper pins. The antenna coil is  $\frac{1}{4}$ -inch in diameter, and consists of two turns of No. 22 enamelled wire, lighter wire being used so that the coil may be bent to change the degree of coupling. Checked on the Lecher wires, this particular coil in this particular receiver covered from 4.2 to 6.1 meters. On higher frequencies it was found that the dimensions of the coil became less and less important, and the placement of parts increasingly more important, so that no definite specifications can be recommended.

Chassis construction was determined by the holes which were already in the chassis. The audio tubes are mounted subpanel but the detector and plug-in coil sockets are mounted on small spacing collars over the socket holes since this provides shorter leads for the high-frequency circuit and reduces coil-to-chassis effects. The midget double-pole double-throw change-over switch  $S_2$  is mounted on a small stand-off insulator as near as possible to the coil socket and the bandspread condenser as shown in the photograph.

The audio transformers are mounted on top of the chassis where there is adequate ventilation and the chokes are mounted directly below them on the same mounting screws. It was found that the enclosed subpanel space would grow a nice crop of green mold over all the wires and parts enclosed within the course of a month. For this reason, the audio transformers were placed where they would not be subjected to this condition. All other parts which might be adversely affected were also mounted above the chassis, even though this resulted in appearance not quite as neat as it would have been if most of the parts were hidden under the chassis. For a damp climate it would apparently be preferable to use a chassis of the open type to permit ventilation, but in dry climates lack of ventilation should cause no difficulty.

In order to use large-size National dials, it was necessary to mount them sideways to clear the row of jacks and switches at the bottom of the panel. This turned out to be very convenient, since the operator's head is nearly always cocked to one side when he writes; tilting the dials also raises the knobs to a more convenient height. The power connection is made by a 7-prong plug which plugs into a socket at the rear of the chassis.

One Burgess 4F2H battery will give long service as an "A" supply. The voltage is dropped through a 30-ohm rheostat  $R_2$  of the screwdriver-adjustment type. Only occasional adjustments are necessary to take care of dropping voltage in the dry cells. Filaments are turned on by means of a switch  $S_5$  mounted on the volume-control shaft. The receiver will function on any plate voltage from 22 $\frac{1}{2}$  to 90 volts. The use of 90 volts on the audio stages, applying 4 $\frac{1}{2}$  volts of "C"

(Continued on page 106)



## ARMY-AMATEUR RADIO SYSTEM ACTIVITIES

**T**HE following article, entitled "Hand Keys Gone Pfft?", appeared in "Army Amateur Time" of the Seventh Corps Area.

This age of high speed seems to have somewhat of an effect on radio amateurs as well as on the rest of us pedestrians. We make our music, our automobile driving, our eating, sleeping and living keep up a pace that kills. Then, when we do have a chance to relax at our favorite pastime — radio — we try to make that keep up a pace that may not kill but surely stuns some of us.

The old hand key just can't be slapped fast enough to tell the lad at the other end all we have on our minds in the same length of time it would take to say the same thing verbally, so, instead of building a 'phone rig, we dig down in the old sock and buy a "bug." Then the fun begins! Those weights will sure slide back a long way and, boy! are those dots plenty fast and snappy! The very sound of those clipping dots immediately stamps us as a "pro." So-o-o, we rattle out a snappy CQ, sign our call a few dozen times just to hear what it sounds like in our monitor, and finally start looking for a possible "bite" on the receiver, hoping, of course, that no one has heard us this first time because we'd sure like to send out that snappy CQ at least once more. But we are unfortunate and hook up with a guy right off; he signs and we go at it again, telling him a lot of valuable information about our rig, weather, ancestry, etc., thus taking up a mere five minutes or so for the benefit of our new love, the "bug." He comes back, after our little spasm, and sorrowfully informs us that QRM is unaccountably bad, stating, "Sure is funny, 'cuz you had a clear channel when we first hooked up." So we just sign off and catalog him as "one of those lugs who couldn't pass the code speed test if he had to take it again." And so, far into the night.

But, let's get down to facts. The A.A.R.S. maintains its existence by the fact that it trains operators for emergencies and, if it fails in this function, it will be valueless to all who are interested in such existence. Therefore, it is the primary objective of every person engaged in the A.A.R.S. activities to help the new or lesser trained operators.

A fast "bug" only adds to the confusion of a slow operator. He cannot give his mind to proper operating tactics if he is being "burned up" by the fast "bug." A net should always operate at the speed of its slowest operator, within reach of

course. There are very few nets in this Corps Area which are made up of nothing but high speed operators. So, the good old hand key must still have a place in our shacks.

The drill period on Monday nights should especially be kept at a slow speed for, even though all the operators in the net are high-speed artists, there may be some outsider who would be interested if he could read what we were saying. And we must also remember that the word "drill" has no hidden meaning that suggests the exclusion of recruits. There is no "awkward squad" to care for the newcomers until they get their stride. We are indebted to them to the extent of what we already have learned.

In cases where time is limited or traffic is stacked up there is a good reason for pushing the "bug" a bit fast, but in the case of traffic, if the Z signals and general operating processes are sent slowly, the messages themselves could be "revved up," and the slow operator listening in would lose none of the value of the drill. Even the report messages should be sent at a reasonably low speed to enable the beginners to become accustomed to the procedure, etc. Oh, yes, it's all in the books and circulars, but "book larnin" seldom is as complete and accurate as actual experience. When we were beginners we liked to copy the ways of more experienced operators, so let's give the beginners a chance to copy our ways by allowing them to hear what we are doing!

The traffic schedules on week nights are a slightly different matter. Here we have the proposition of getting something done in the quickest possible manner. We are still confronted with the fact that to do a thing the quickest way is to do it right the first time, and sending too fast to another operator is not a time saving method of moving traffic.

To move traffic just imagine yourself as a machine that has a certain amount of work to accomplish. Set your speed so the "receiving machine" will record what you send with one hundred per cent accuracy and then keep grinding away.

There are those operators who shy away from "breaking" a sending operator because it allows that operator to determine the maximum speed at which they can copy. The Army has never, to our knowledge, given any extra K.P. duty to any

*(Continued on page 86)*

# 1938 Sweepstakes Contest Results

*Greatest National QSO Contest of All Time*

BY E. L. BATTEY,\* WIUE

**T**HE week-ends November 12th-13th and 19th-20th, 1938, were busy days on the amateur bands as the Ninth A.R.R.L. All-Section Sweepstakes Contest made "CQ SS" the password to practically every ham QSO. It was the most successful, most enjoyable "SS" ever held! There are three major indices to contest success: (1) the amount of activity, (2) the enthusiasm of participants, (3) actual results as measured by scores submitted. On all three counts the '38 Sweepstakes put all previous national QSO parties in the background. It was a real QSO-fest and a good time was had by all except one ham who wasn't in it and couldn't find anyone to work. Yeah, we mean that bird you heard calling "CQ No SS"! Hi.

Let us delve into statistics for a moment to see just how the 9th SS beat all others. The score list records the accomplishments of 1269 reporting operators, a far higher figure than for any earlier contest embracing only the A.R.R.L. Field Organization Sections. There were 1131 c.w., 113 'phone logs entered. Twenty-six operators participated in both the c.w. and 'phone. Scores ran generally higher, and it should be remembered that the multiplier for power below 100 watts was 1.25 instead of 1.5 as in the two preceding Sweepstakes. In the '37 SS (the most outstanding national contest at that time) 7 c.w. operators had totals over 60,000; in the '38 get-together 20 topped 60,000 . . . in '37 there were 25 over 50,000; in '38, 42 reached 50,000 or higher. In the 'phone group, 38 made scores over 3000, while only 25 hit this total in '37.

In point of actual contacts established, the '38 SS brought 300 or more QSO's to 73 code operators; only 24 rolled up this number in '37. Eighteen voice operators made 80 or more contacts in '37; 21 'phones worked 100 or more stations in '38. Contacts were far more widespread in the 9th Sweepstakes, too . . . in '37 QSO's were effected with 60 or more Sections by 51 c.w. operators; in '38, 113 c.w. participants worked 60 or more Sections. . . . And among the 'phones, in '38, 34 operators worked 30 or more Sections, while in '37, 22 contestants hit the 30 mark.

Statistics may seem dry, but they mean much more than the mere figures. The more participants, the more for everyone to work; the more for everyone to work, the more contacts; the

more contacts, the more pleasure for all; the more pleasure for all, the more successful contest! Do you see now why we're boosters for bigger and better statistics?

## *The Winners*

We're introducing a new feature with this contest report, a list of all winners with their scores, transmitter line-ups, receivers and bands used, as complete as information given on the logs permits. We hope you find it as interesting as we do. Seventy c.w. awards are being made (in all Sections except Alaska) and 47 'phone awards (including Alaska), so all 71 Sections were active. We know that all participants join us in extending congratulations to the winners!

## *Outstanding Scorers*

For a real success story we call attention to Jerry Mathis, W3BES. Third high in '36, second high in '37, Jerry came through the '38 contest with "SS" ringing in his ears to the tune of 84,001 points, the leader of all participants. If you wonder how he did it, ask *him*. We have given up trying to dope it out. We do know that an e.c.o. helped, but there must have been a whale of a lot of "operator" and other factors mixed in. FB, Jerry! Other national high scorers include W3DUK 78,809, W6KFC 75,375, W2IOP 71,998, W3ENX 70,560, W9VFZ 70,380, W3CHH 69,694, W5KC 69,680, W9RSO 69,020, W8OFN 66,430, W9VKF 66,163, W8JIN 65,423, W2GSA 65,100, W2HMJ 65,000, W4ECI



*Heroes of the '38 SS*

Thompson McNeal, W6LDJ, and Kenny Langenbeck, W6LVB, of Santa Ana, Calif, and the "SS Special" in which they took a portable layout to Nevada especially for the contest. With W6LVB/6 they made it possible for at least 290 contestants to work that elusive state. Many operators completed W.A.S., thanks to these gentlemen.

\* Assistant Communications Manager, A.R.R.L.



*W5KC, O.R.S., Plaquemine, La.*

W5KC is a well known contest call and its operator, Vincent L. Rosso is an old timer from "way back when." The transmitter employs a 59 Tri-tet crystal oscillator, 802 doubler, 807 buffer-doubler, HK54 buffer, P.P. 100TH's final. The final stage was omitted for Sweepstakes operation, when W5KC won for Louisiana with 69,680 points on 3.5, 7, 14 and 28 Mc. The silver cup on the NC101X receiver was won for excellence in N.C.R. work.

64,488, W1TS 62,531, W9RQM 62,238, W7CMB 61,556, W8OKC 60,795 and W1AW (W1JTD opr.) 60,192.

Leader in number of contacts was W8OFN with 514 stations worked, a new high figure for 40-hour SS contests. W3BES also topped the 500 mark with 502 stations, followed by W2IOP 482, W3DUK 471, W1AW (W1JTD opr) 458, W6KFC 450, W3CHH and W9ELL 445, W3ENX 443, W2GSA 420, W9VFZ 417, W5KC 416, W2APT 407, W9RSO 406, W9VDY 402 and W2HMJ 400. From the standpoint of contacts-per-operating hour among this group, W2IOP and W1AW lead with 13 per hour, with W8OFN batting 'em down at the rate of 12.8 per hour, W3BES 12.5 p.h. and W3DUK 12.4 p.h. Practically all contestants had a "best hour" with 10, 15, 20, 25, perhaps more QSO's, but to maintain the average that these fellows did for 35-40 hours is a sterling example of operating efficiency!

#### *Sections Worked*

Many SS participants get their chief pleasure from the contest in trying to contact as many sections as possible. To work all sections is the ambition of these chaps. Their goal was tougher than ever in the '38 Sweepstakes because, with the creation of separate Georgia and West Indies Sections, there were more sections than ever to work — 71. Although no contestant made the grade, W1TS (c.w.) and W6ITH ('phone) each succeeded in snagging 69 of the 71, no mean accomplishment! W1TS missed P.I. and Alaska, W6ITH worked all but Quebec and West Indies. Others who bore down particularly hard on sections were W6OCH ('phone), W3JTT, W9RSO,

W9VES and W9VFZ, each of whom worked 68; W3BES, W3DUK, W3FAX, W4APU, W4ECI, W5KC, W6KFC, W7CMB, W8DOD, W9CWW and W9VKF with 67; W1AW (W1JTD op) W3FRY, W3GHM, W6MUR, W8AVB, W8CMH, W8JIN, W9ELL and W9IU, 66; VE2EP, VE5VO ('phone), W1AVJ, W1KFE (W1IQZ opr), W2APT, W2HMJ, W3GAU, W5WG, W6QAP, W8OFN, W9GY, W9RQM and W9YCR, 65.

#### *Leading 'Phone Participants*

For the third consecutive year W6ITH (45,126 points) leads the 'phone group. He had some stiff competition from W6OCH in his own Section (East Bay), who was second among 'phones with 36,652, and from VE5VO, whose 33,963 points placed him third high. W4AKA and W4EPX, operating W4EQK, scored 22,491. Additional outstanding 'phone scorers: W2JUJ 17,820, W9YQN 17,280, W5CXH 16,110, W9FUH 15,160, W9JIE 13,552, VE3AIB (VE3AIB and VE3APG oprs.) 13,475, W9TTS 13,144, W9USI (W9USI and W9USH oprs.) 13,034, W7FLT 13,020, W9TQL 12,960, W9UYD 12,584, VE5FZ 12,514, W9ZTO 11,040, W6EJC 10,608, W4CDG 10,176 and W9GDB 10,125.

Leader in 'phone contacts, W6ITH worked 327 stations, 8.6 per hour. W6OCH made contacts with 274 in 29 hours, an average of 9.4 per hour. VE5VO worked 210, W4EQK (two oprs.) 182, W5CXH 180, W2JUJ 168, W9YQN 160, W9TQL 152, W9USI (two oprs.) 133, W9TTS 125, W9UYD and VE3AIB (two oprs.) 123, W9JIE 121, W9ZTO 115, W7FLT 113, W9FUH 112, W6QEU 111, VE5FZ 110, W6EJC and W9HZL 102, W6AM 100.

'Phone leaders in working sections, in addition to W6ITH (69), W6OCH (68) and VE5VO (65) were W4EQK (two oprs.) 63, W9FUH and

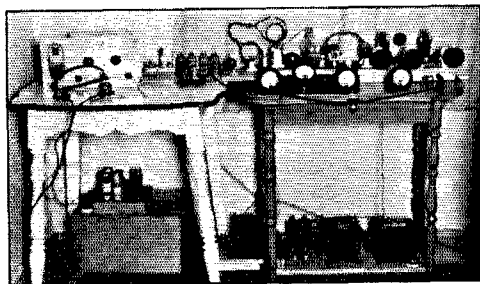

*Portable W6LVB, Las Vegas, Nev.*

This is the famous Nevada portable installation of W6LVB and W6LDJ, set up in an auto camp on the outskirts of Las Vegas. The rig was a 6L6G crystal oscillator, 6L6G doubler and 100TH final, operated on 7, 14 and 28 Mc.; receiver a 3-tube, t.r.f. Antenna was a 200-foot Zepp, about 40 feet high, supported by a pole borrowed from the Las Vegas Lumber Co. W6LVB/6 was on the air for the entire second week-end of the contest.



**WINNERS, NINTH A.R.R.L. SWEEPSTAKES CONTEST**

**RADIOTELEGRAPH**

Section	Winner	Call	Score	Transmitter Line-Up	Receiver	Bands Used (Mc.)
E. Penna.	Jerry Mathis	W3BES	84,001	6J7-6V6-6F6-809-P.P. 809's (c.c./e.c.o.)	NC101X	3.5, 7, 14
Md.-Del.-D. C.	Clyde L. Bunch, Jr.	W3DUK	78,809	802 e.c.o.-807-807-100TH	NC101X	3.5, 7, 14
So. New Jersey	Wm. T. Robinson	W3GZH	48,900	802 e.c.o.-807-RK18	NC100X	3.5, 7, 14
W. New York	Roger T. Wilson	W8JTT	56,695	802-6L6-35T	SX16	3.5, 7, 14
W. Penna.	Rexford M. Ackley	W8IZS	26,966	89 e.c.o.-6L6G	SW45	3.5, 7, 14
Illinois	Robert Middleton	W9VFZ	70,380	P.P. 6L6G's e.c.o.-6A6-6N7G- 807-35T	NC101X	28, 14, 7, 3.5
Indiana	L. D. Gregg	W9IU	58,400	Pair 6L6's final	—	3.5, 7, 14, 28
Kentucky	W. R. R. LaVielle	W9ELL	58,740	—	—	3.5, 7, 14
Michigan	R. F. Coughaine	W8CMH	49,995	42 e.c.o./76 c.c.-802-809	—	3.5, 7, 14
Ohio	H. E. Stricker	W8OFN	66,430	6A6-35T-250TH	RME69	14, 7, 3.5
Wisconsin	Reno W. Goetsch	W9RQM	82,238	59 e.c.o./6L6 c.c.-807-T55	Breting 12	3.5, 7, 14
No. Dakota	Carlisle R. Norman	W9ZOU	41,907	6L6-6L6-TZ40-100TH	—	7, 14, 28
So. Dakota	Carl G. Strauss	W9FOQ	17,625	'47 c.c.-'10-T40	McMurdo Silver 5B	3.5, 7, 14
No. Minn.	C. W. Davies	W9YCR	51,025	6L6-6L6-809	RME9D	7, 14
So. Minn.	L. A. Morrow	W9VKF	66,163	6K7-6L6G-6L6G-814	RME	3.5, 7, 14, 28
Arkansas	Lester Woolsey	W5ELJ	19,845	'47 c.c.-Par. '46's	Sky Champion	7, 14
Louisiana	Vincent L. Rosso	W5KC	69,680	59 c.c.-802-807-HK54	NC101X	3.5, 7, 14, 28
Mississippi	Fred L. Ford	W5AVF	32,118	6L6G c.c.-Par 6L6G's	—	7, 14
Tennessee	Benton White	W4PL	32,760	'47 c.c.-'46-'10-P.P. 50T's/ 100TH's	—	3.5, 7, 14
E. New York	Elbert L. Taylor	W2EWD	32,890	'47 c.c.-'46-'46-809's	—	3.5, 7, 14
N. Y. C. & L. I.	Larry Le Kashman	W2IOP	71,998	6L6-RK39-T55	NC101X	3.5, 7, 14
No. New Jersey	Robert Morris	W2GSA	65,100	42-6L6-6L6-T55	RME69	3.5, 7, 14
Iowa	Harold Hamm	W9RJE	29,380	6A6 P.P. c.c.-T20-T55	Sky Buddy	7, 14
Kansas	A. B. Unruh	W9AWP	52,054	6A6 c.c.-807-100TH	RME69	3.5, 7, 14
Missouri	O. L. Short	W9RSO	69,020	59-6L6-RK39-RK12's	3-tube, t.r.f.	3.5, 7, 14, 28
Nebraska	Kenneth Petersen	W9ZAR	53,156	6L6-c.c.-809-T55	FB7A	3.5, 7
Connecticut	Edmund R. Fraser	W1KQY	46,116	6F6-6L6-809-P.P. T55's	NC101X	3.5, 7, 14
Maine	Burton E. Mullen	W1IQZ, opr. at W1KFE	38,480	59-802-809-P.P. 35T's	NC81X	3.5, 7, 14, 28
Eastern Mass.	Roger F. Hathaway	W1RY	51,188	59-6L6G-808 (e.c.o. or c.c.)	"D.C. Blooper special"; 2 201A's	3.5, 7, 14, 28
Western Mass.	Victor Paounoff	W1EOB	45,905	802 e.c.o.-807-RK47	SX9	3.5, 7, 14
New Hampshire	Carl B. Evans	W1BFT	44,545	RK23-RK20	—	3.5, 7, 14
Rhode Island	Warren W. Anthony	W1BBN	26,779	'47-'46-'2-838	HRO	3.5, 7, 14
Vermont	Merwin B. Forbes	W1KTB	13,915	6L6 c.c.-Par. 6L6's	NC8OX	3.5, 7, 14
Idaho	Robert Thode	W7FFQ	27,638	802 c.c.-211E	NC81X	3.5, 7
Montana	Tony Schuler	W7GRR	32,681	6L6 e.c.o./c.c.-6L6G-809	—	3.5, 7, 14, 28
Oregon	Richard D. Dawson	W7GPP	15,985	'47 e.c.-6L6-P.P. T20's	9-tube, homemade	7
Washington	Harold G. Ingledue	W7CMB	61,556	24-58 e.c.o./42 c.c.-HY61-808	Homemade SS super	3.5, 7, 14
Hawaii	Sadami Katahara	K6FAZ	10,537	P.P. T40's final	HRO	7, 14, 28
Nevada	K. H. Langenbeck	W8LVB	19,014	6L6-6L6G-100TH	3 tube, t.r.f.	7, 14, 28
Santa Clara V.	R. W. Johnson	W6MUR	43,725	—	—	7, 14, 28
East Bay	John Woerner	W6ONQ	30,508	802 e.c.o./c.c.-807-35T-P.P.	—	7, 14, 28
San Francisco	Joseph Horvath	W6GPB	29,760	100T's-P.P. 450T's	—	7, 14, 28
Sacramento V.	Wilfred C. Dodds	W6NHA	29,320	RK23-800-P.P. 800's	—	7, 14, 28
Philippines	James P. Clarke	KA1AX	299	6A6 c.c.-807-35T-P.P. HK54's	—	7, 14, 28
San Joaquin V.	Frank Valentich	W6MEK	38,130	6L6G-'10-P.P. '10's	—	7
North Carolina	H. L. Caveness	W4DW	32,671	6L6-6L6-35T	9-tube super	7, 14
South Carolina	V. E. Howell	W4CZA	7,387	6A6 c.c./6L6 e.c.o.-807-pair of '10's	—	3.5, 7
Virginia	C. A. Rudloff	W3FMY	41,856	Par. 6L6's-'03A; 6L6G-T55	—	3.5, 7
West Virginia	Kenneth Leiner	W8LCN	33,280	42-807-808-P.P. 100TH's	NC101X	3.5, 7, 14, 28
Colorado	E. F. Miller	W9WTW	37,620	6A6 c.c.-6A6-6A6-809-150T	NC101X	3.5, 7, 14
Utah-Wyoming	Floyd Wickenkamp	W7DES	25,370	6L6-6L6-P.P. 809's-P.P. T55's	5-tube, t.r.f.	7, 14
Alabama	E. Conway Atkerson	W4ECI	64,488	Pair 89's e.c.o.-41-6L6G-6L6's- 35T's	ACR175	7, 14
E. Florida	James L. Dyer	W4GOB	29,580	—	—	3.5, 7, 14, 28
W. Florida	George Eggart	W4EPT	32,003	6J5G-807-809-P.P. T40's	—	3.5, 7, 14, 28
Georgia	Leland W. Smith	W4AGI	41,009	6L6-T55; 6L6-6L6-T55	NC101X	7, 14
West Indies	Mario de la Torre	CM2OP	6,708	6L6-T20-T40	—	3.5, 7, 14
Los Angeles	W. A. Lippman, Jr.	W6SN	25,830	6L6G-'10-'03A	SX16	7, 14
Arizona	V. C. Clark	W6KFC	75,375	35T-35T-150T	—	7, 14
San Diego	G. Vandekamp	W6GCX	29,618	59 e.c.-59-T20-35T; '47 c.c.- '46-T20	NC81X	3.5, 7, 14
No. Texas	Billy R. Bowen	W5ELE	40,610	6L6-801-RK20-150T	—	7, 14, 28
Oklahoma	Fred W. McKelvey	W5AQE	34,178	6L6 c.c.-6L6G's-P.P. T55's	—	7, 14
So. Texas	Bruno M. Wojcik	W5CWW	44,000	6L6G c.c.-RK25-800	—	7, 14
New Mexico	Sheldon H. Dike	W5HAG	11,845	6F6 e.c.o.-6L6-807-T125	HRO	7, 14
Maritime	W. J. White	VE1EX	14,858	6L6 c.c.-6L6-809	—	3.5, 7, 14
				2A5 c.c.-'46-P.P. RK23's	Sky Challenger	3.5, 7, 14

W9JIE 56, W2JUJ and W9YQN 54, W4CDG and W9TTS 53, W6EJC and W9UYD 52 and W9GDB 50.

### Club Scores

Third-time winner of the gavel for the club whose members submitted the highest aggregate

SS score was the Frankford Radio Club of Philadelphia . . . 598,546 points by 20 participants. W3BES was the highest individual scorer in this group. The Frankford Club says it isn't going to stop winning gavels until it has one for each member! The Milwaukee Radio Amateurs' Club,

Section	Winner	Call	Score	Transmitter Line-Up	Receiver	Bands Used (Mc.)
Ontario	S. B. Trainer, Jr.	VE3GT	46,320	6L6-809.....	6F8G "June 38 QST"	3.5, 7, 14
Quebec	F. A. Greene	VE2EP	46,963	6N7 c.c.-6L6G.....	Sky Chief	14
Alberta	Jim Smalley, Jr.	VE4GD	34,728	6A6-P.P. 6L6's-P.P. '10's.....	SX17	7, 14, 28
British Columbia	J. Hepburn, Jr.	VE5HP	34,050	RK23-RK23-250TH; 6J5-6C5-'45's-P.P. 6L6's.....	-----	1.75, 3.5, 7, 14
Manitoba	G. G. Williams	VE4SO	23,669	6L6 c.c.-'46-P.P. T20's.....	-----	7, 14
Saskatchewan	J. A. Jinks	VE4ZC	30,595	T20 s.e.o.; Pair '46's s.e.o.....	-----	7, 14, 28

### RADIOTELEPHONE

E. Penna.	Clarence C. Deppen	W3FFG	820	6L6-6L6G-T20-P.P. 800's.....	-----	28
So. New Jersey	F. C. South	W3AIR	280	6L6-6L6-807-P.P. 808's.....	HFS9N-HRO	28, 56
W. Penna.	R. H. McCague	W8KBJ	2,550	Pair HF300's '03A.....	-----	3.9, 14
Illinois	W. J. Nolan, Jr.	W9TQL	12,960	53-'10-pair T40's.....	RME69	1.75, 3.9
Kentucky	Wm. E. Leatherman	W9YQN	17,280	802-807-807-P.P. T40's.....	RME69	3.9, 14, 28
Michigan	Zeph Willison	W8JAH	7,140	42 c.c.-804-P.P. HK254's.....	-----	3.9, 14, 28
Ohio	W. Davidson	W8IAW	10	6K7 e.c.o.-6J7-6V8-807-35T.....	-----	14
Wisconsin	C. E. Smith	W9ZTO	11,040	Meissner Signal Shifter-807-35T-250TH.....	HRO	14, 28
So. Dakota	William R. Mattison	W9USI	13,034	6L6-809-TZ-40-pair T55's.....	-----	1.75, 3.9, 28
No. Minn.	R. C. Harshberger	W9JIE	13,552	802-807-808-P.P. 50T's.....	HRO	14, 28
Arkansas	Dr. Wm. E. Gray	W5FPD	72	-----	-----	28
Louisiana	Dawkins Espy	W5CXH	16,110	6L6-T20-TZ40-100TH.....	-----	3.9, 14, 28
E. New York	S. Staniszewski	W2FQG	23	6L6-e.c.o.-6L6-pair '10's.....	SW3	3.9
N. Y. C. & L. I.	G. McDonald	W2CHK	1350	6L6-6L6-T20-T55.....	Comet Pro	14
No. New Jersey	James A. Wotton	W2JUJ	17,820	802-807-35T-pair 100TH's.....	HRO	3.9, 14, 28
Iowa	C. C. Richelieu	W9ARE	480	-----	-----	3.9
Kansas	Ralph Copening	W9TTS	13,144	6L6G-TZ20-T20-P.P. T55's.....	-----	14, 28
Missouri	Walter Hampel	W9UYD	12,584	6L6 c.c.-6L6-TZ40-T200.....	PR15	3.9, 14, 28
Nebraska	B. H. Hansen	W9GDB	10,125	'47-'46-'10's-261A.....	57-58-2A5 Autodyne	1.75, 3.9, 14
Maine	F. Norman Davis	W1GKJ	6,665	6L6G-6L6G-TZ40.....	-----	3.9, 14, 28
Western Mass.	J. P. Saunders	W1BDV	10	6L6G c.c.-802-T20.....	2-tube regen.	3.9
New Hampshire	Albert Bellerose	W1LJB	4,125	807-'10-806; 2A5-6L6G-TZ20.....	FB7	3.9, 28
Alaska	R. W. McCrary	K7AOC	112	-----	-----	14
Idaho	Ray Harland	W7FRA	23	802 e.c.o.-807-T55.....	-----	28
Montana	Dan Fulton	W7FFT	13,020	6V6 c.c.-6N7-807-35T.....	Homemade super	1.75, 3.9, 14, 28
Oregon	Carl Austin	W7GNJ	4,031	6L6G c.c.-T20-T55-P.P. T55's..	-----	3.9, 14
Washington	Frank G. Chaddock	W7FLG	32	802-803-P.P. 354's.....	-----	14
East Bay	D. Reginald Tibbetts	W6ITH	45,126	6C5-6L6-807-814-P.P. 806's.....	Super pro & home-made	1.75, 3.9, 14, 28
Sacramento V.	Barton N. Carrick	W6EJC	10,608	250TH final.....	RME69 & DB20	14, 28
San Joaquin V.	Peter Onnigian	W6QEU	6,105	6L6G-RK11.....	10-tube super (ARRL HB)	1.75
North Carolina	Richard V. Frazier	W4CDG	10,176	6L6-6L6-RK25-RK25-P.P. 35T's.....	13-tube super, home-made	3.9, 14, 28
South Carolina	Ted Ferguson	W4BQE	5,719	89-807-P.P. 809's-P.P.'03A's.....	-----	14
Virginia	Ted P. Mathewson	W3FJ	1,320	6A6-6L6-'03's.....	ACR-136	3.9, 14
Colorado	Leonard Gulman	W9FUH	15,610	6L6-807.....	RME69 & Super Skyrider	1.75, 3.9, 14, 28
East Florida	W. J. Herrin	W4AKA opr. at W4EQK	22,491	6J5G-807-814-pair 250TH's; '47-807-211; 6J5G-807-35T-100TH.....	HRO	1.75, 3.9, 14, 28, 56
Los Angeles	Don C. Wallace	W6AM	3,845	P.P. 300T's final.....	RME69	1.75, 3.9, 14, 28, 56
San Diego	G. Vandekamp	W6GCX	1,044	6L6-801-RK20-150T.....	-----	28
Georgia	Norman Fincher	W4FTJ	88	6L6-6L6-T40.....	9-tube super	28
No. Texas	W. E. Varley	W5FAB	9,506	53-'10-pair HY25's.....	-----	1.75, 3.9, 14
Oklahoma	L. M. Swift	W5FDQ	7,264	24A e.c.o.-6L6G-T20.....	-----	14, 28
New Mexico	Sheldon H. Dike	W5HAG	10	6L6 c.c.-6L6-809.....	-----	14, 28
Maritime	Ted Rowe	VE1BK	1,639	6L6G c.c.-6L6G-6L6G-P.P.'46's	SX7	14, 28
Ontario	J. L. Weir	VE3AIB	12,094	42 e.c.o.-6L6-P.P. 801's.....	9-tube super	1.75, 3.9, 14, 28
Alberta	E. M. McNair	VE4WJ	7,556	Meissner Signal Shifter-6L6-pair T40's.....	-----	14, 28
British Columbia	E. J. Fowler	VE5VO	53,963	6L6-809-808.....	SX17	1.75, 3.9, 14, 28
Manitoba	J. W. Hartley	VE4SR	4,847	6L6 c.c.-6L6-T-40's.....	8-tube super, home-made	14
Saskatchewan	Victor R. Neal	VE4HU	32	-----	-----	14

Inc., with a score more than four times the size of its '37 total, was second among clubs with 399,554 . . . 33 participants. W9EYH (c.w.) and W9PTE ('phone) were leaders in the Milwaukee A.R.A. Third high was the Delaware Amateur Radio Club (Wilmington), 262,863, more than double its '37 score. W3DUK was winner in the Delaware Club. The York Radio Club (Elmhurst, Ill.) made a strong bid with 239,720 points; W9NST (c.w.) and W9CJP ('phone) receive the Y.R.C. awards. Watch your competition, Frankford!

Special certificate awards were offered to the leading participants (c.w. and 'phone) in each club having three or more participants. Thirty-eight clubs in addition to the above are eligible for such awards, and are listed in order of aggregate scores, together with the calls of the winners. Except where otherwise indicated the winners used c.w.: Beacon Radio Amateurs (Philadelphia), 185,407, W3FLY; York Road Radio Club (Glenside, Pa.), 169,039, W3EEW; Birmingham (Ala.) Amateur Radio Club, 150,509, W4ECI; Washington Radio Club, 144,837, W3EUI; Philadelphia Wireless Association, 141,528, W3GUV; Merrimack Valley Amateur Radio Association (Concord, N. H.), 133,702, W1BFT (c.w.), W1LJB ('phone); Richmond (Va.) Amateur Radio Club, 118,937, W3FMY; Elmira Amateur Radio Association (N. Y.), 100,170, W8DZC; Oakland Radio Club (Calif.), 90,623, W6LTH ('phone); Bridgeport Amateur Radio Association (Conn.), 81,136, W1DOV; Westlake Amateur Radio Association (Cleveland, Ohio),



*Veteran of SS Contests*

The 1938 contest was the sixth consecutive Sweepstakes for A. B. Unruh, W9AWP. Kansas high in '34, '35 and '36, W9AWP came through again in '38 to lead his Section with 52,054 points. Transmitter: 6A6 crystal, 807 buffer-doubler, 100TH final. Receiver: RME69. Note the coffee implements! The wise contest man doesn't overlook these details.

78,341, W8LVH; Northern Nassau Wireless Association (Long Island), 64,155, W2BWC; Mountaineer Amateur Radio Association (Fairmont, W. Va.), 63,961, W8OXO; Montreal Amateur Radio Club, 62,733, VE2DR; Hi-Q Radio Club (Lynn, Mass.), 61,432, W1JEA; Southtown Amateur Radio Association (Chicago), 57,776, W9MGN; Merrimack Valley Radio Club (Lawrence, Mass.), 56,985, W1IQH; West Side Radio Club (Toronto), 56,081, VE3AD (c.w.), VE3AIB ('phone); Chester Radio Club (Pa.), 54,520, W3DGM (c.w.), W3DRQ ('phone); Dayton Amateur Radio Association (Ohio), 50,579, W8LCO; Austin Radio Club (Chicago), 50,169, W9ZMG; Trenton Radio Society (N. J.), 48,770, W3AWH (c.w.), W3AIR ('phone); Queens Radio Amateurs Club (Queens, N. Y.), 42,815, W2CWE; Starved Rock Radio Club (Illinois), 40,968, W9NGG; Chair City Radio Association (Gardner, Mass.), 40,545, W1AUN; Horse Shoe Radio Club (Altoona, Pa.), 39,055, W8OIX; Asheville Amateur Radio Club (N. C.), 37,677, W4TO (c.w.), W4CDG ('phone); Waltham Radio Club (Mass.), 36,028, W1JOX; Southern Montana Amateur Radio Association (Billings, Mont.), 34,146, W7JC (opr. W7EC) (c.w.), W7CT ('phone); Electric City Radio Club (Great Falls, Montana), 35,527, W7FYN (c.w.), W7BOZ ('phone); Nashua Mike and Key Club (N. H.), 32,636, W1HTO (c.w.), W1KLD ('phone); Delaware Valley Brass Pounders Association (Port Jervis, N. Y.), 32,529, W2KXF; Georgia Tech Radio Club, 23,227, W4DXI;

*(Continued on page 96)*



*Kentucky 'Phone Winner*

Wm. E. Leatherman, W9YQN, O.P.S.-O.B.S., Louisville. On the operating table: RME69 receiver, speaker, bug and mike. The rack and panel transmitter: 802, 807, 807, P.P. T40's, 200 watts on 3.9, 14 and 28 Mc.

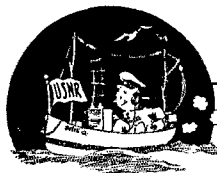

# NAVAL COMMUNICATION RESERVE NOTES

## Fourth Naval District, Naval Communication Reserve

BY COMMANDER E. C. ROGERS,  
U.S.N.

**T**HE Naval Communication Reserve of the Fourth Naval District is organized in the same general manner as the Reserve in other districts. There are six sections with the geographical limitations of each section as follows:

- Section I — Eastern Pennsylvania
- Section II — Central Pennsylvania
- Section III — Western Pennsylvania
- Section IV — New Jersey (Southern Half)
- Section V — Philadelphia suburbs and Wilmington
- Section VI — Master Control Station NDM

Inasmuch as previous articles under this heading have outlined the general organization of Sections and Units of the N.C.R., such will be omitted except to note the various section commanding officers, many of which are "old timers" in amateur radio. These officers are:

- C.O. Section I — Lieut. (jg) P. W. Moor (N3SB)
- C.O. Section II — Ensign H. E. Hiner (N8FUW)
- C.O. Section III — Lieut. (jg) B. P. Williams (N8ZAE) (N8ZD)
- C.O. Section IV — Lieut. (jg) C. E. Biele (N2AOS)
- C.O. Section V — Lieut. (jg) W. B. Martin (N3QV)
- C.O. Section VI — Lieut. (jg) W. M. Uhler (N3AKY) (N3GX)

The Master Control Station, NDM, is located in the Navy Yard, Philadelphia, and the Alternate Control Station, NDC, is located in the Old Federal Building at Pittsburgh. Each of these stations is equipped with three transmitters and three receivers and able to work on different frequencies simultaneously. In addition, the alternate control station is equipped with an excellent portable transmitter and receiver. The transmitter power is obtained from three sources; gas generator, battery-driven generator and hand generator. The unit control station at Johnstown, Pa. (the home of the famous Johnstown flood), is also equipped with a 300-watt gas-engine-driven generator for emergency use.

Although the Fourth Naval District is not particularly large in area, it certainly is near the top in N.C.R. activity. Many years ago, before the days of government assigned frequencies for drill purposes, the frequency of 3610 kc. was chosen for the then "NAVY NET." This frequency has been maintained for much N.C.R. activity in the district although the drills are now

conducted on assigned government frequencies in the 2-3-Mc. band. The Fourth District has about 55 officers and 500 men on the N.C.R. roll. Of the officers and rated men, which number about 375, there are about 350 of these holding valid FCC licenses. The traffic circuit on 3610 kc., which is in operation every night, handles several thousand dispatches a month between various stations of the organization. These are not the usual amateur messages but are official dispatches relative to the activity of the organization and all are handled in authorized Naval methods.

From point of service, the oldest officer is Lieut. Comdr. F. Mousley (N3FI). He is one of the pioneer radio operators in the commercial field, served in the U. S. Navy during the war and has been active in the N.C.R. ever since its organization. He is now the Commanding Officer of the largest unit in the District and is located at the Frankford Arsenal, Frankford (Philadelphia). This unit is also one of the best in the district.

In the Fourth District there are 31 units and only one of these is not assigned public quarters. Practically all these units are uniformed and have government radio and ordnance equipment. Realizing that a Navy radioman should also know how to shoot as well as operate, several of these units have taken up target practice in their spare time and are engaged in competition with other units.

The District is also organized for emergency work. During the flood two years ago, excellent work was done by many of the N.C.R. men and in some cases afforded the only communications available. When the U.S.S. *Akron* crashed off the Atlantic Coast some years ago, the Master Control Station was manned for four days by officers and men volunteering for this duty. This station joined the Lakehurst-Philadelphia-Washington circuit and handled a large amount of emergency traffic in an efficient manner. Others were assigned to the Reserve Aviation Base at Philadelphia and served as radio operators in aircraft which were engaged in searching for the survivors. In some cases these operators had never been in a plane before.

Recent instructions from the Navy Department have curtailed the enlistment of men in the N.C.R. and the qualifications also have been changed. Previously a holder of any class amateur license could enlist in the N.C.R. as a radioman third class if also found physically qualified. Now a man must enlist as seaman first class and can

(Continued on page 86)

# ★ I. A. R. U. NEWS ★

Devoted to the interests and activities of the

## INTERNATIONAL AMATEUR RADIO UNION

*Headquarters Society: THE AMERICAN RADIO RELAY LEAGUE, West Hartford, Conn.*

### MEMBER SOCIETIES

American Radio Relay League  
Asociata Amatorilor Romani de Unde Scurte  
Associazione Radiotecnica Italiana  
Canadian Section A.R.R.L.  
Ceskoslovenski Amatéri Vysilaci  
Deutscher Amateur Sende-und-Empfangs Dienst  
Esti Raadio Amatooride Uhing  
Experimental Radio Society of Egypt  
Experimenterende Danske Radioamatorer  
Federation des Emetteurs Belges  
Irish Radio Transmitters Society

日本アマチュア無線聯盟 Japan  
Liga Colombiana de Radio Aficionados  
Liga Mexicana de Radio Experimentadores  
Magyar Rövidhullámú Amatőrök Országos Egyesülete  
Nederlandsche Vereeniging voor Internationaal Radioamateurisme  
Nederlandsch-Indische Vereeniging Voor Internationaal Radioamateurisme  
Newfoundland Amateur Radio Association  
New Zealand Association of Radio Transmitters  
Norsk Radio Relæ Liga

Polski Związek Krotkofalowców  
Radio Club de Cuba  
Radio Club Venezolano  
Radio Society of Great Britain  
Rede dos Emissores Portugueses  
Reseau des Emetteurs Français  
Reseau Luxembourgeois des Amateurs d'Ondes Courtes  
South African Radio Relay League  
Suomen Radioamatöörlitto r.y.  
Sveriges Sandareamatorer  
Unión de Radioemisores Españoles  
Union Schweiz Kurzwellen Amateure  
Wireless Institute of Australia

### W.A.C.—1938

THE I.A.R.U. issued during 1938 a total of 958 certificates in recognition of two-way communication with the six continents; 738 were for c.w. work, and 220 for 'phone. The number of W.A.C. certificates issued each year from 1930 to 1937 is as follows:

1930 — 170	1934 — 349
1931 — 178	1935 — 458
1932 — 137	1936 — 711
1933 — 180	1937 — 803

In the 1938 figures, England placed highest by far in any country (outside the United States) in both 'phone and c.w. work; in c.w. work, Belgium was second, with Germany, New Zealand, South Africa and Australia right behind. In the U. S. A., the 9th was the highest district, with the W6's a nose behind. Here are the figures:

C.W.	'Phone	C.W.	'Phone
CE.....	1	LA.....	3
CM.....	2	LU.....	2
CO.....	2	LY.....	1
CR7.....	3	NY.....	3
CT1.....	3	OA.....	1
D.....	23	OE.....	1
EI.....	9	OK.....	14
F.....	12	ON.....	22
FM.....	1	OZ.....	6
G.....	75	PA.....	10
GI.....	1	PK.....	5
GM.....	8	PY.....	6
GW.....	2	SM.....	11
HA.....	5	SP.....	17
HB.....	6	SU.....	3
HC.....	1	TI.....	1
I.....	3	VK.....	18
J.....	9	VO.....	1
J8.....	1	VQ8.....	1
KA.....	1	VU.....	5
K4.....	3	VE1.....	1
K5.....	1	VE2.....	1
K6.....	4	VE3.....	1
K7.....	1	VE4.....	2

C.W.	Phone	C.W.	Phone
VE5.....	7	XE.....	2
W1.....	31	XU.....	2
W2.....	40	YM.....	1
W3.....	31	YR.....	11
W4.....	22	YV.....	2
W5.....	28	ZB1.....	1
W6.....	59	ZD2.....	1
W7.....	35	ZD6.....	1
W8.....	55	ZL.....	19
W9.....	65	ZS.....	23

### CHANGE OF ADDRESS

THE address of the new headquarters of the *Experimental Radio Society of Egypt* is c/o Poste Restante, Sidi Gaber, Alexandria. J. Frazer Robinson, SU2JR, is the Hon. Secretary.

### MEMBERSHIP APPLICATION

THE *Lietuvos Trumpjuju Banqu Radio Megeju Draugija* (Radio Amateur Association of Lithuania), whose membership includes all of the 45 licensed Lithuanian amateurs, has applied for membership in the I.A.R.U. Petr. Jastrzembkas, LY1J, is president, and Jul. Satas, LY1S, is secretary.

### QSL BUREAUS

ALL those amateurs and bureaus having occasion to use the QSL-forwarding service in sending cards to American amateurs should check the names and addresses of the nine U. S. managers against the list published regularly in another section of *QST* to prevent delays and reforwarding expense. Bring your mailing list up to date, and check it periodically!

The following corrections should be made in the list of bureaus as published in the October, 1938, issue:

*(Continued on page 90)*

# HOW WOULD YOU DO IT?



## SCHEMES FOR REPLACING BROKEN ANTENNA HALYARDS ON MASTS

**P**ROBLEM No. 24 (see January *QST*) is almost as old as amateur radio itself. Nevertheless, the gang certainly went to work on it and we think that you will agree that many of the ideas are new and novel as well as thoroughly practicable. The ingenuity shown in many instances is really refreshing. If you have been wondering how to replace that broken halyard on your 60-footer without risking your neck, at least one of the solutions should make it easy. If you don't have such a problem at the present time, it would be a good idea to save this issue for a rainy day. The scheme which will best fit your particular problem will depend upon location and construction of the mast, surrounding objects and the material to which you may have access.

In most cases, it will be a much simpler job to replace the old pulley rather than to attempt to thread new rope through the old pulley, although this may often be done without great difficulty. Several schemes make use of the top guy wires in coaxing a new pulley, fitted with a new halyard, to the top of the mast. If you have a second mast or can make use of a tree or housetop or temporarily erected support, the scheme shown in Fig. 1A is probably one of the easiest to execute. One of the top guys is set free. The new pulley with

halyard is fitted with a heavy metal ring or a loop of several turns of heavy wire and the loose end of the guy wire is passed through this loop. The loop should be large enough to pass easily over the guy-wire insulators. A light cord is tied to the loop and the free end of the guy wire is tied to the halyard from the second support, hoisted up and pulled tight. It should then be possible to make the loop slide along the guy wire towards the top of the mast by shaking the new halyard and pulling on the assister cord from a distance. In some cases, it may be possible to coax the loop up over the top of the mast if one has sufficient patience and the top guys are not fastened too far from the top of the mast, although this isn't necessary. When the loop has been worked up close to the mast, it may be held there by the assister cord while the guy wire is lowered. While holding the free end of the guy wire, several turns about the mast should be made by walking around the mast outside all other guys. This will bind the loop securely to the mast. A sharp yank will break the assister cord after the job is finished.

Another scheme which may be tried is shown in Fig. 1B. A loop of wire, as previously described, is passed around the rear top guy wire. If the loop is covered with tape or a section of old bicycle tire

Fig. 1

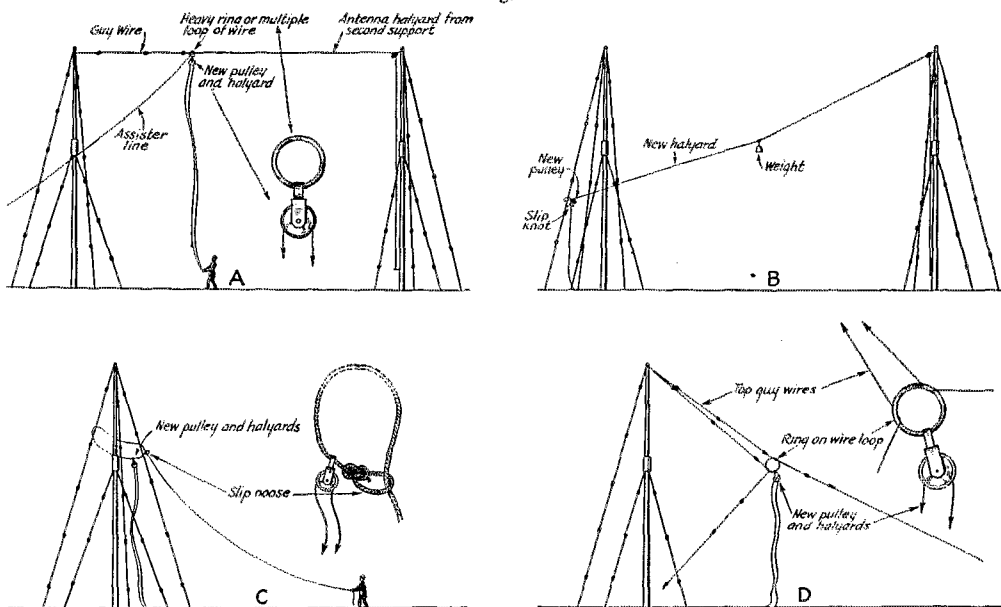

or garden hose, it may slide more readily on the guy wire. The new halyard and the halyard from the second support are tied together and a large slip-knot is tied in the other side of the new halyard to prevent the new halyard from running through the pulley when it is pulled up the guy. Alternatively, the two ends of the new halyard may be tied together and then tied to the halyard from the second support. An assister cord tied to the wire loop might be helpful in getting the loop over insulators; shaking the guy wire should also help. When the pulley reaches the top of the mast, the guy wire is wrapped around the top of the mast as previously described. A sharp yank on the free end of the new halyard will take the slip-knot out. It might be a good idea to tie some sort of weight between the two halyards to make sure that they will fall to the ground when released.

If you can't make use of a second support, there are other ways of doing the job. Take, for instance, the idea shown in Fig. 1C. Pass a heavy rope around the outside of all top guy wires. Then pass the rope through the eye of the new pulley fitted with the new halyard and form a slip noose. By shaking and pulling the rope, it should be possible to work the loop up the guy wires to the top. Best results will be obtained by working the rope at a fairly good distance. If the loop becomes caught on an insulator, a friend can assist by sliding the pulley along the loop to a point near the insulator and whipping the halyard. When the noose reaches the top of the mast, its rope should be made fast to the base of the antenna.

In the scheme shown in Fig. 1D, the ring to which the new pulley is attached should be as

smooth as possible and fairly heavy. Two top guys are loosened and the ends are passed through the ring. By pulling the guy wires in as nearly opposite directions as possible, the ring will be forced towards the top of the mast. Temporary extension of each guy wire will make the job easier and some whipping or shaking may be required to get the ring over the insulators. The ring is fastened to the top of the mast by making a few turns with each guy about the top of the mast as previously described.

If you don't wish to disturb the guy wires, one of the schemes shown in Fig. 2 may be used. In A, a series of light sticks is used to push a loop carrying the new pulley up along one of the top guy wires. The loop should be large enough to pass easily over the top of the pole. The side of the loop opposite the pulley is stapled to the end of the first stick and the loop is held in an approximately vertical position by means of a piece of light string. Each section of stick is fitted with loops of wire passing around the guy wire, the loops of sufficient size to pass easily over the guy-wire insulators. These loops should be spaced about every 3 or 4 feet. Lines or cords about 3 feet long carrying weights are attached near the top end of each section. These are to hold the stick steady on the top side of the guy wire. As the assembly is pushed up along the guy wire, additional sections are added, splicing them together with wire so that there is very little play between sections. When the loop has been maneuvered into a proper position, a sharp pull on the halyard will break the holding cord and bring the loop down over the top of the mast.

Fig. 2

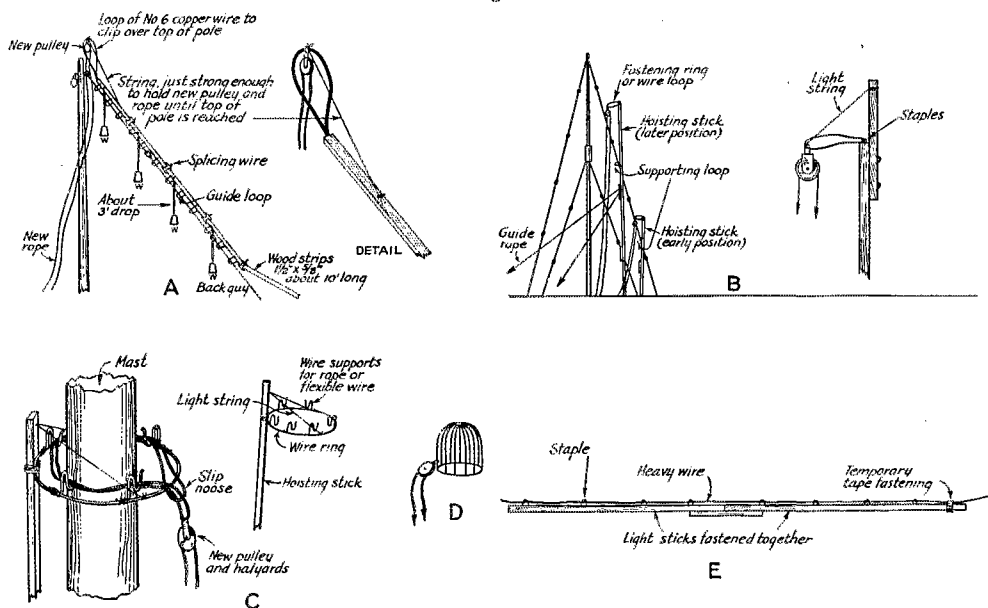

Another pull on the sticks should pull out the staples holding the loop to the sticks and the pusher may then be removed and disassembled.

Sometimes the top guy wires are fastened some distance down on the mast so that it would be impossible to pass the loop over the top of the mast by this scheme. In this case, another idea may be used. It is shown in Fig. 2B. The loop carrying the pulley is stapled to the top of a light stick. A guide loop is passed around one of the top guy wires and fastened to the stick a few feet from the top end. As the stick is raised, additional sections are spliced on rigidly. Providing sufficient distance has been left between the pulley loop and the guide loop, the pulley loop may eventually be lifted above the top of the mast and lowered over it. If the weight of the halyard is too great for the strength of the hoisting stick, light cord may be substituted temporarily during the hoisting process and replaced with the halyard when the pulley is in place. Guide cords attached at points along the stick and operated by a friend may help to keep the stick from buckling and to maneuver the loop over the end of the pole. It may help some in getting over the insulators to release the guy wire and bring it into a more nearly vertical position near the mast. If the diameter of the pole does not vary too greatly between top and bottom, a similar series of sticks might be fitted with larger guide loops encircling the mast itself instead of the guy wire.

The details of a scheme which may be used where no guy wires or only a set of guys at the top of the mast interfere are shown in Fig. 2C. A stiff ring which encircles the mast is fitted with a series of wire hooks bent as shown in the drawing. This ring is attached to a section of light stick by means of staples or light cord. A slip-noose of heavy rope or flexible wire to which the pulley is fastened rests above the ring supported by the

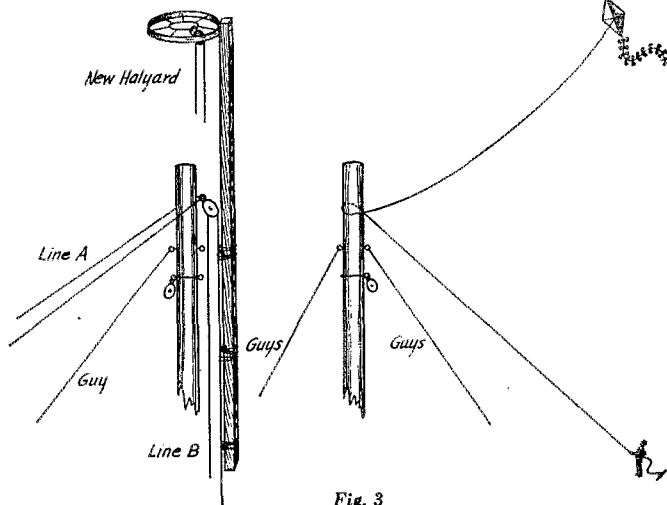

Fig. 3

### PROBLEM NO. 27

Our Hero has plans for a unidirectional rotatable antenna. One detail is yet to be solved, however, and that is some method of feeding the antenna which will permit continuous rotation in the same direction. He has seen one or two systems suggested in *QST* but wonders if some better or simpler solution isn't possible. He would like to hear of any bright ideas on the subject.

wire hooks. Braces made of string keep the loop or ring at right angles to the hoisting stick. The ring with the noose is then pushed up the pole, adding sections of stick as required. If the stick starts to bend, it may be supported by attaching additional loops of wire at points along the stick. When the loop has been pushed to the top of the mast, a jerk on the halyard will tighten the noose about the pole and then the hoisting stick may be lowered. Should the noose have a tendency to loosen up and slide down the pole, this may be prevented by soaking the noose in varnish or some other adhesive which will bind the noose to the mast when it dries.

We think you'll agree that the risk of climbing to the top of a 50- or 60-foot pole is not only unnecessary but extremely hazardous. If you don't agree, you might read the following letter written in reference to this Problem Contest.

"In answer to Problem 24, I submit the following: Don't climb the mast. I had a 65-footer with three sets of guys and I had the same difficulty with the halyards. I climbed my mast but came down a lot faster than I went up. When I reached the top, one of the top guys broke and I and the mast came down. It gave me a nice vacation of three weeks in the hospital with a spinal fracture. So, as the 'Voice of Experience,' I say, 'Don't climb it. Do anything else but climb it.'

Douglas A. Parsonage,  
Grimsby, Ontario."

Several ideas submitted involve the use of a 25- or 30-foot extension ladder to reach up to or above the first set of guy wires. Such a ladder may be used with reasonable safety provided suitable precautions are taken. Before climbing the ladder, all guy wires and anchorages should be inspected.

(Continued on page 98)





# HINTS AND KINKS

FOR THE EXPERIMENTER

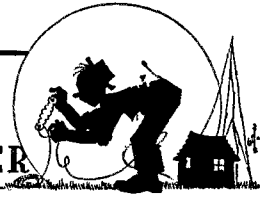

## INEXPENSIVE LOW-CAPACITY ANTENNA SWITCH

THE construction of an inexpensive low-capacity antenna switch, built by R. J. Blaho, W8EEP, is shown in the drawing of Fig. 1. Two triangular ceramic transposition blocks (Lynch) form the end supports for the rotating switch bar. These blocks have holes in each corner. Two of these in each block may be used for mounting on a baseboard by means of strips of angle stock. The third hole is used as the bearing for the rotating bar. This bar consists of an ordinary six-inch feeder spreader (Johnson) with fittings at each end to fit the holes in the transposition blocks. The switch blades are formed from  $\frac{5}{16}$ -inch outside-diameter copper tubing.

The detail drawing shows the construction of the end fittings for the feeder spreader. A "U"-shaped clamp is formed from  $\frac{1}{4}$ -inch brass to fit the end of the spreader. The holes in the ends of the spreader will just pass a 6-32 screw which may be used to fasten the fitting in place. A  $\frac{1}{4}$ -inch hole should be drilled, as accurately centered as possible, in the end of the "U" clamp for the  $\frac{1}{4}$ -inch-diameter brass screw which will form the shaft upon which the bar will turn. This screw should be clamped tightly with a nut and soldered.

To make the blades, a length of  $\frac{5}{16}$ -inch-diameter copper tubing is slit lengthwise for a distance of approximately an inch. The two sections are spread out and flattened and bent to fit around the spreader. Before mounting on the spreader, the tubing should be flattened for a distance of an inch or so at the opposite end.

The holes in the triangular blocks are not quite large enough to pass the  $\frac{1}{4}$ -inch screws so that it will be necessary to file the screws slightly before they will fit the holes. A large washer in the inside of each block should be used to prevent binding against the surface of the block.

After the switch has been assembled, a collar should be fitted to one of the projecting screws. This collar should be drilled and tapped for a length of brass rod which will serve as a set screw as well as an extension for the handle. The switch jaws, which may be taken from a cheap switch, are mounted on stand-off insulators which, in turn, are mounted on the baseboard in line with the switch blades.

Some small lengths of thin spring brass or flexible wire may be used to make connection between the blades and anchoring screws inserted in the central holes in the triangular blocks. There is sufficient room underneath the bar to mount

an antenna relay on the baseboard. W8EEP uses the switch to switch from one antenna to a second. The relay is used to switch from transmitter to receiver.

## MORE ON NEON-TUBE OSCILLATION IN VOLTAGE-REGULATED SUPPLIES

"I SHOULD like to call to your attention a circuit kink which I discovered and seems to spell death to oscillation by the neon bulb in the voltage-regulated receiver supplies described in *QST* and the *Handbook*.

"As indicated in *QST*, connecting a 0.1- $\mu$ fd. condenser across the neon bulb may cure, aggravate or shift the frequency of the oscillations.

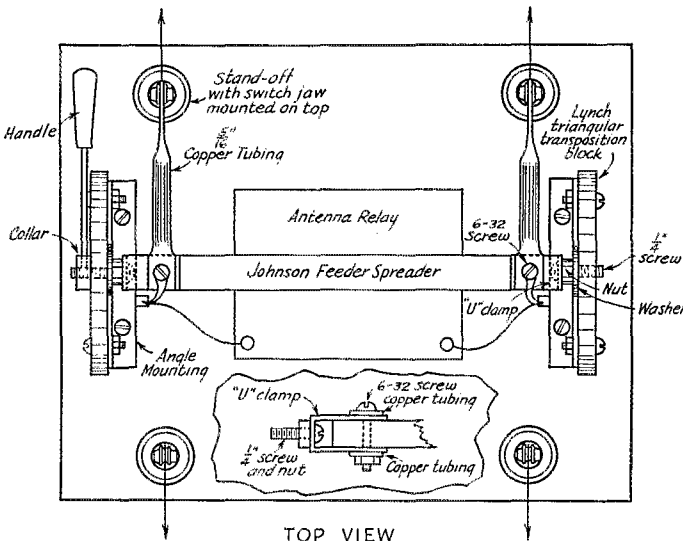

TOP VIEW

Fig. 1

In my case, the latter occurred. After a great deal of tinkering, I finally connected a 0.01- $\mu$ fd. condenser in series with a 50,000-ohm resistor across the neon. The oscillations ceased and have not appeared since. The size of the resistor seems to be fairly critical; a value of 2500 ohms, for instance, makes the oscillations worse, while 500,000 ohms is uncertain in its effectiveness.

"It might be wise to point out that a high resistance between the control-tube cathode and the positive output terminal is a compromise; more current with regulation may be drawn, but the percentage of regulation suffers."

— Harry G. Burnett, W1LZ

— — — — —

The photograph of Fig. 2 shows a double-section neutralizing condenser built by Thomas Bayne, W9SRS. The plates are cut from  $\frac{1}{8}$ -inch sheet aluminum. The movable plates are 2 inches in diameter and the stationary plates have a  $\frac{5}{8}$ -

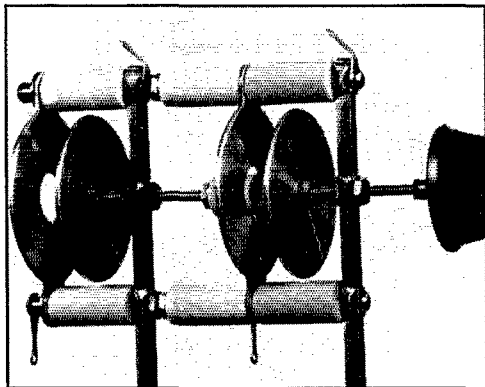

Fig. 2

inch-diameter hole cut in the center for the shaft. The four plates were clamped together for the final shaping so that they would be of equal diameter. The stationary plates are provided with ears or tabs for mounting. The National type GS-1 stand-off insulators used to support the stationary plates are fastened together by 6-32 machine screws whose heads have been removed. The two movable plates are fastened to lengths of brass rod with 6-32 threads which form the two sections of the control shaft. These two sections are insulated from each other by another GS-1 insulator, the two sections of rod threading into opposite ends of the insulator. The entire assembly is mounted on two sections of  $\frac{1}{4}$ -inch square brass rod which, in turn, are mounted on stand-off insulators. The rotor of the rear section may be adjusted to match the capacity of the front section. In many cases, it may be possible to mount the condenser directly upon the tank-condenser frame.

## NEW METHOD OF LOWERING CRYSTAL FREQUENCY

"I'D LIKE to pass on to QST a suggestion that I have just hit upon. It applies to one of those little tragedies so common in the life of the ham who grinds his own crystals. I mean those crystals which have been pushed a kilocycle or two too far and are irretrievably past either the desired frequency, or perhaps, the band edge. There have been various means tried to bring them back; I think the best one is still the expedient of having them silvered, but this process is quite a chore, whereas the stunt I will suggest takes but a moment and works equally well. Briefly, the idea is merely to paint the surfaces of the crystal with either iodine or mercurochrome; either the tincture or the aqueous solutions will work. The iodine gives the most pronounced effect although the mercurochrome will probably be more permanent, since there is a possibility that the iodine will undergo what is called sublimation, somewhat like evaporation. Thus far, this has not happened to the several rocks I have treated, but it is mentioned for what the observation may be worth.

"The best way to apply either treatment is first to clean the crystal thoroughly in soap and water, then rinse thoroughly in warm, clean water. Next, lay the crystal flat on a level surface and, placing one drop of either solution in the center of the surface, guide it around over the crystal face until the whole surface is covered. Let it dry and then repeat the job on the other side. The effect may be increased, up to a certain limit, by repeating the treatment two or three times. Before replacing the crystal in the holder, it should be wiped with a very soft cloth, or a piece of Japanese lens tissue, to remove any particles of lint or dust which might have settled on it.

"This treatment will usually move an 80-meter crystal three or four kilocycles; I moved one 40-meter AT-cut crystal nearly thirteen kilocycles. Instead of impairing the crystals, as do most of the hit or miss treatments such as India ink, this one seems actually to improve the activity of the crystal up to a certain point.

"I don't recommend this stunt as a substitute for proper grinding but, as an emergency measure, it is well worth while, particularly for the fellow who has a good frequency-measuring device. I've managed to get several of the boys around here to try it out and they all report good results. Except for silvering, it is the only thing I've ever found that will do any good."

— B. P. Hansen, W9KNZ

## Strays

W8FU points out that dial lights for receivers without them may be operated from the filament-heating transformer in the receiver.



## CORRESPONDENCE FROM MEMBERS

The Publishers of *QST* assume no responsibility for statements made herein by correspondents.

### DIRECTOR ELIGIBILITY

107 Hanover St., Mankato, Minn.

Editor, *QST*:

Several members of the Board of Directors of the League are making an effort to have By-Law 12 changed. The first sentence of By-Law 12 reads as follows: "Any candidate for the office of Director shall have been both a member of the League and a licensed radio amateur for a continuous term of at least four years preceding the receipt by the Secretary of his petition of nomination, as hereinafter provided."

It would be well, I think, to have this matter presented to members of the League, together with the circumstances, so that the Board might know how members feel about the proposed change. To that end I wish to present a few circumstances related to the proposed change.

Members should first remember that Mr. Mathews, who has urged a change in the by-law in January *QST* and in another radio publication, does not meet the requirements. Neither does Mr. Blalack, who has recently stated to the Board that he proposed to have the by-law changed if possible.

Members might also like to know that the Board decided at its last meeting that the by-law was not too strict, since 30 days grace period was permitted before a member's name was taken from the list of members of the League. By mail the Board recently indicated that it wished the by-law to mean four years just preceding the nomination.

I know of many amateurs in the Dakota Division, and I am sure that the same is true in other divisions, who take a great deal of pride in the length of time that they have held a license and League membership without any breaks. It seems to me that this is some kind of evidence of a lasting interest in amateur radio. Is it right to reduce the requirements for serving on the Board to a point where almost anyone can serve as a director?

It seems important to me that active amateurs who have demonstrated a long-time interest in amateur radio both by keeping up their League memberships and their licenses are the type that should serve on the Board of Directors. Members should realize the importance of nominating such men to the directorship. The interests of the League would be best served, I feel, if there were always several eligible nominations so that members would really get a chance to elect their representative to the Board.

W9BBL of the Dakota Division has suggested that the membership certificate show the length of time of continuous membership, to assist in the nomination of eligible men. There are large enough numbers of active eligible men who would make very good directors in each division if some effort is made to get them nominated. I hope that members will express themselves on these points both to their own director and to League headquarters.

*Fred W. Young, W9MZN*  
Dakota Division Director

EDITOR'S NOTE. — Lest Mr. Young unwittingly cause misunderstanding as to just what has been proposed in the way of change of by-laws, it should be mentioned that the only formal proposal now before the Board for study would not change the present requirement for four years' continuous membership in the League. Nor, basically, would this proposal alter the present requirement that director candidates shall also have been licensed amateur operators for the same time. With respect to the latter point, however, it would provide that lapses in license term for periods not exceeding ninety days would not disqualify. The intent is said to be to allow leeway for F.C.C. delays in handling the renewal applications, delays arising from unintentional errors in making out applications, etc. — the recent elections having shown that most "breaks" in license continuity were due to such technicalities and not to actual lapse over an extended period. Neither Mr. Mathews' nor Mr. Blalack's eligibility status would be affected by the change proposed.

### IT'S NOT "MASONITE"—IT'S "PRESDWOOD"

725 Third St., Kalamazoo, Mich.

Editor, *QST*:

I have frequently noticed in the pages of *QST* reference to "Tempered Masonite" as a suitable material for panels and the like. As this particular terminology is one of my pet gripes, I am writing a mild protest. "Masonite" as it is known in the building trade is an insulation board made in two standard thicknesses,  $\frac{1}{2}$ " and 1". There is no such product known as "Tempered Masonite." The Masonite Corporation, makers of Masonite, hold the patent on a material called "Presdwood." It is this latter material which makes the fine panels. "Presdwood" is available in an oil-tempered form known as "Tempered Presdwood" and as such is a vastly better material for radio usage. Both varieties of board are obtainable in  $\frac{1}{8}$ "",  $\frac{1}{4}$ "",  $\frac{3}{8}$ "",  $\frac{1}{2}$ " and  $\frac{3}{4}$ " thicknesses. Tempered Presdwood is also avail-

(Continued on page 84)



**F. E. HANDY**  
W1BDI, Communications Manager

**E. L. BATTEY**  
W1UE, Asst. Communications Manager

**T**HE "big event" of the season for those to whom amateur radio means simply "DX" will be over about the time you read these words. We expect the contest participation in this continent may approach the record set by the "SS" reported elsewhere in this issue.

**Operating with e.c.o.'s** came up substantially in this DX contest. The use of the QHM-QML series of tuning designation added much to operating efficiency where it was used. The contest proved that the foreign DX stations have a very real control, and the power to direct us (helpfully) where to transmit. We suggest all stations in foreign lands at once make MH-ML-HM-etc. tuning designations of frequency the universal order. It will help to reshape DX operating for the better.

E.c.o.'s and self-excited oscillators admittedly have greater flexibility in getting about the bands, having potentially large advantages. There has been a growing feeling that the e.c.o. is definite retrogression in the matter of "frequency insurance," however, and also retrogression in many cases in signal quality and frequency stability, as well. This is a serious indictment, not so much of the technical principle as of the operating practices involved. It also becomes increasingly true that the more amateurs change to e.c.o. and s.e.o., the less important the advantages to us personally in having such equipment, except for specialized emergency applications, since the stations equipped can "come to our frequency," making it unnecessary for us to fly about (butterfly fashion) to make QSOs.

There is no good reason why the whole fraternity and each of us individually should suffer from a "plague" of poor e.c.o.'s wantonly operated. Until the animal is made fool proof, each of us who builds one should consider that he *has no right* to operate it until the note and signal are just as closely the equivalent of that produced by quartz-controlled rigs as contemplated by the requirements of our F.C.C. regulations.

**On e.c.o.-s.e.o. practice:** All good general operating rules should be remembered and applied when using a "rubber" oscillator. Above all, make calls *short*, and pause frequently to listen. Do not attempt to break into routine communications, or you may deserve all that is said

to you and the low opinion other operators will form of your behavior. Use discretion, and always wait until they sign off unless you have something of public-emergency importance. Until the sign off, attention of an operator is focussed on his QSO. The moment this operator listens, at the end of a contact, is the time to be ready with a call.

Remember that QRM is always resented whether it is deliberately caused or not. Consider that the responsibility for causing interference is yours, and your reputation depends on the way in which you operate, and that you want to be considered a gentleman instead of a pirate.

In tuning up never *swish* from one frequency to another. Tune up the oscillator by your receiver; never allow the final amplifier to be on the air when tuning. Tune *near* but not exactly on either station's frequency, as well as using discretion in choosing your time for making a call. If working DX, remember that the DX amateur is going to work stations he can pick out of the QRM, not any of the ten stations piled up on his own frequency if none is outstanding in strength, but the station of the good operator out about 12 kc. in the clear! And after you have moved near a frequency to work a station, remember to move off again after you are through, so that others will have a chance. Do not open up with a CQ or a random call giving what amounts to deliberate interference to others! Do as you would be done by.

— F. E. H.

## BRIEFS

### 56-Mc. DX

Paul Muller, W1HXE, Lawrence, Mass., reported hearing G5ML on that long-to-be-remembered day, June 5, 1938, when DX was pouring through on "five meters." He has now received a confirmation from G5ML which states that W1HXE's reception checks perfectly with transmissions from ML HXE logged G5ML on 56 Mc. at noon, EST, Q5 85-6. 5ML was running 300 watts to a vertical 4-element stacked array.

— . . . —

### Polish DX Contest

Polski Zwiasek Krotkofalowcow, Polish Section, I.A.R.U., announces a 1939 DX contest for Polish amateurs and those throughout the rest of the world. The competition starts at 0001 GT, April 16th, and continues until 2359 GT, April 30th. Additional details are not available at this writing, but it is expected that rules will be along the order of the '38 Polish contest. (See page 66, May 1938 QST.)

## PRIZES FOR BEST ARTICLE

The article by Mr. J. Camden, VE3GZ \* wins the C.D. article contest prize this month. Each month we print the most interesting and valuable article received marked "for the C.D. contest." Contributions may be on any phase of amateur operating or communication activity (DX, 'phone, traffic, rag-chewing, clubs, fraternalism, etc.) which adds constructively to amateur organization work. Prize winners may select a 1938 bound *Handbook*, *QST*, Binder and League Emblem, six logs, eight pads radiogram blanks, DX Map and three pads or any other combination of A.R.R.L. supplies of equivalent value. Try your luck. Send your contribution to-day!

## The "How" of a Good Fist

BY J. CAMDEN, VE3GZ \*

**T**HERE are many rotten fists on the air. When you speak to anyone about his poor fist, he usually has what he considers a good excuse. As a general rule, it is a "glass arm" or a "poor key." The writer has yet to see a key with which it was impossible to send good code, even though the speed might be low. It is absolutely necessary that all dots should be the same length, all dashes should be the same length, and all spaces should be the same length. If one will take a key and buzzer and sit down to a little practice it is amazing what can be accomplished. Most operators with poor fists are trying to send much faster than the condition of their arm will permit. The arm must be in condition or it will seize or cramp in the middle of a letter and spoil the sending. Almost any glass arm can be cured if the owner of that arm is willing to do something about it.

The chief effect of a glass arm seems to be poor timing. This can only be cured by slowing down and learning the code over again. The correct grip of the key is very important. According to an article by T. R. McElroy, which appeared in *QST* some months ago, the correct way to take hold of the key is to space the thumb and the first two fingers evenly around the edge of the key. I have found that the fingers should be slightly curved and the forefinger should tend to be slightly on top of the key. The back of the wrist should be parallel with the operating table. The whole hand and arm should be firm but flexible, not rigid. The wrist should be kept off the table. At first it will be found that it is practically impossible to keep the arm from becoming rigid. This can be cured by sending a string of dots, slowly at first, taking great care that each dot is the same length and the spacing between them is uniform. It will take a lot of practice to cure this stiffening of the arm, but it can be done in this manner and will be well worth it. When the arm is properly loosened up, it will be possible to send uniform dots for a period of at least a minute, without cramping the arm or materially tiring it. The dots, however, must be kept uniform, or the practice is worth nothing. When the arm has been loosened up in this manner, it is time to start sending individual letters. These should be taken quite slowly, and great care should be taken with the length of dots and dashes and the spacing of them. Some will probably claim that they can't send certain letters unless they send fast. Their arm is not properly loosened up. Anyone who can send fast properly can also send smoothly and evenly at low speeds. When you are satisfied that your arm is loosened up and that you are making your characters properly, it is time to start sending words. This may be done by sending from a book, or by chewing the fat with your best friend on the air.

\* 57 Strathcona Ave., S., Hamilton, Ont., Canada.

However, you *must* forget the other fellow's speed and send at the speed that you can send evenly and smoothly. It is also advisable to spell out each word, so that you don't get too much practice on some letters and not enough on others. You should be able to send for one-half to one hour solid without your arm tiring appreciably. All the while you are sending, you should be looking out for incorrect spacings and timing. This slow speed may seem very boring, but unless you can control your speed you cannot control your spacing and timing. *Every time you resist a desire to speed up past your natural speed you have won a point toward good sending.*

When your arm is properly loosened up you will know it. It will feel different when you are sending and your sending will have a new positiveness and sound. Then, and only then, is it time to speed up. The speed should be increased gradually, making sure that the feel and spacing do not change. When you have fully developed your fist you should be able to send at any speed from eight to twenty-two, or faster, evenly and correctly and for an indefinite period without any signs of cramping or undue tiring. It can be done. The writer licked a glass arm by following the very suggestions set forth in this article. Yours for a better fist.

## Fire Disaster, Val d'Or, Quebec

On February 11th the mining village of Val d'Or in northern Quebec was almost wiped out by fire. All existing communication was cut off between that town and Kirkland Lake, Ont., the nearest city. VE3ALT was asked by several agencies in Kirkland Lake to see if he could get through by amateur radio. After seven hours of effort he contacted Dr. Fisher, VE2MT, the next morning; 3.9-Mc. 'phone schedules were then arranged with VE3AGG, also of Kirkland Lake. These three stations maintained contact throughout the day and provided the outside world with all news coming from the stricken town, rendering valuable assistance both to the railway and to the relief agencies.

W4FNC, O.P.S., Ware Shoals, S. C., has just submitted an application for W.A.S. award and claims a record for working all states on 1.75-Mc. 'phone in seven months. All states were worked from July 22d, '33 (when he received his license) to February 22d, '39. For good measure he threw in a contact with Puerto Rico!



A.R.R.L. Group at Columbia, S. C., December 4, 1938. Seated, left to right: Gus Browning, W4BPD, O.P.S., N.C.S. 1.75-Mc. 'Phone Net; Charles Furr, W4BNN, O.P.S.; Vivian E. Howell, W4CZA, R.M.-O.R.S., N.C.S. S.C. 3.5-Mc. C.W. Net; Ted Ferguson, W4BQE, S.C.M.; H. L. Caveness, W4DW, O.R.S., Director Roanoke Division; Bannie L. Stewart, W4CE, P.A.M.-O.P.S.-O.R.S.

Standing, left to right: J. C. Whittington, W4FNC, O.P.S.; Charles E. Kirkwood, W4FFO, O.P.S.; J. K. Chapman, W4COL, O.P.S.; Sanders R. Guignard, W4DQY, O.P.S.; R. D. Bass, W4CQG, O.P.S.; George W. Warren, Jr., W4EXJ, O.P.S.-E.C.; R. D. Mitchell, W4EDQ, O.P.S.; Claude H. Ragsdale, Jr., W4EGH, O.P.S.; Roy H. Setzler, W4ETF, O.P.S.; Walter L. O' Cain, W4DPN, O.P.S.; M. C. Lennon, W4ECG, O.R.S.; Joe Walker, W4DNR, O.R.S., Asst.-to-S.C.M.-on-Emergency Coordination; J. Allen Davis, W4CZN, O.R.S., N.C.S.-A.A.R.S. S.C. Net.

# West Virginia Flood Emergency

**R**ADIO amateurs in West Virginia were called into emergency service, on February 3rd, as wire communications with Logan, Madison, Danville and Ivydale were cut off by flood conditions.

On the job at Logan were W8PNE and W8KHB on 1.75-Mc. 'phone, working with the American Mutual Emergency Net, and W8ELJ (S.N.C.S., A.A.R.S.) and W8LGB on 3.5-Mc. c.w., working with the West Virginia State Net. At Madison W8SNO on 1.75-Mc. 'phone did some splendid work in keeping Madison in contact with Charleston. The snow was so heavy in the mountains that for at least two days Madison's telephone communication was disrupted. W8SNO had an output of only 12 watts, W8NSE at Ivydale was without power for 12 hours and had to use batteries for most of his transmissions.

Outstanding during the emergency period was W8SES (1.75-Mc. 'phone) of Dunbar, outside of Charleston. On the night of February 3rd, with communication needed by the isolated towns, he raised W9HQD, Harrisburg, Ill., who contacted W8MOL, A.R.R.L. Emergency Coördinator of Huntington, W. Va. W8MOL in turn contacted W8DMF, who established communication with Logan. Yeoman service was rendered by members of the American Mutual Emergency Net in clearing and keeping clear the frequencies used by the 1.75-Mc. 'phones in West Virginia. W2JLQ, Woodmere, L. I., was particularly helpful in this respect, contacting W8SES and finding out his needs. With the frequencies cleared W8SES and W8PNE handled much of the urgent traffic for Western Union and others. Half hourly schedules were kept with the A.M.E.N. until 6:00 A.M. on Saturday, the 4th. The emergency frequencies were monitored all day Saturday, with W1AW assisting in this work. W2JLQ reestablished contact with W8SES at 6:00 P.M. when SES advised that Logan, W. Va., had a telephone line once more. Madison, however, was still without communication, and W8SNO was operating with a portable rig. Many urgent messages were handled from Madison. At 6:30 P.M. W2KVV took over from W2JLQ the control of the frequency-monitoring network. The circuit closed at about midnight, upon advise from West Virginia that traffic would not warrant a continuance of schedules. However, a special schedule for 6:00 A.M., Sunday, was arranged between W8SES and W2KVV. At that time it was reported that telephone service to Madison had been restored.

W8PNE and W8KHB of Logan handled W.U. traffic, including a death message. A.P. dispatches were copied from Huntington for the Logan newspapers. The 3700-Kc. State Net was on for at least 12 hours, handling reports on river conditions. W8ELJ handled messages for the American Legion and Red Cross, assisted by W8LGB. Through W8ELJ-W8KHB, wire for the telephone company was ordered, as well as costs and blankets for the American Legion. Normal contact with Logan was reestablished by about noon of the 4th, but amateurs continued a close watch. W8NSE, operating with water surrounding his home, and on a portable supply, 2 watts input, worked into the 3700-Kc. Net. In addition to W8DMF (Charleston), W8CZ also handled traffic between Huntington-Charleston-Logan, including distress messages and some W.U. traffic, via the C.W. Net. W8FNM, Detroit, Mich., handled 'phone traffic in conjunction with W8DMF. W8RFV, Vanderbilt, Mich., stood by with his 3.9- and 1.75-Mc. rigs, ready to lend assistance. W8ATT, Nellis, W. Va., assisted in the handling of traffic on 1.75-Mc. 'phone. W8NAU and W8MCL of Bluefield, W. Va., were active on 3700 kc. In Huntington, several hams "nearly got their feet wet," namely W8EL, W8QEC and W8BDD. The flood waters necessitated their moving. W8SFT and W8BWK were helpful to W8QEC, sending river reports. At Wheeling, preliminary preparations for service were made by W8BWK, A.R.R.L. Emergency Coördinator, W8BTV, W8DYB and W8HD, S.C.M., but conditions did not reach the point where amateur communication was needed.

Those participating on the 3700-ke. W. Va. C.W. Net who were either O.R.S. or A.A.R.S. included W8ELJ, BTV, CZ, BWK, DYB, LGB, LII, HUK, KYJ, MCL, NAU,

PSR, PTJ, NSE and HD. 1.75-Mc. 'phone participants in W. Va. included W8MOL, W8SNO, W8QFN, W8PNE, W8HHH, W8SES, W8KHB, W8DMF and W8ATT; W8LNR assisted at W8SES. Working with the American Mutual Emergency Net in monitoring frequencies and assisting in general were the following: WIPI, LOS, DAV, CPI, LGZ, ERX, KFA, KXM, KPW, IKR, IDL, JMJ, W2JLQ, KVW, AFR, HAC, HAP, HRZ, JHC, LUI, KFA, IUQ (had 7-Mc. branch of A.M.E.N. ready for action had they been needed), HLL, LBF, LDB, KON, JNQ, W3FDY, FME, BILL, W4EWP (handled some traffic from W. Va.), W5EZH, W8HHO, QYL, RSR, RTX, PDU, EDK, PMG, FYN, W9FRZ, ZXS, ZUY.

## CQ ML, ETC.

Attention has been called to one defect in the present practice of using the QHM, QML series as an indication of what part of the band you will start tuning. The procedure generally is to call the usual CQ and, with the final call-sign, include the appropriate indicator (LM, MH, etc.). It is necessary to wait until the fellow is all through with his CQ before knowing where he intends to tune; if he doesn't happen to select the portion of the band near your frequency, the time you spent listening to him is usually wasted. It is now suggested that the indicator be included as a part of the CQ call in order to show immediately where you will tune and allow those listening to either adjust their transmitters to that part of the band where you will tune, or enable them to look for a CQ from another station. W3CAB suggests that this new procedure be standardized as follows: CQ CQ ML (etc.) DE W3CAB, repeated several times until the final call CQ CQ ML DE W3CAB W3CAB W3CAB ML K. Give it a try.

## M. E. N.

The Missouri Emergency Net operates each Sunday at 8:00 A.M. CST. Procedure is as follows: The Net Control, operating on 3775 kc., uses the general call MEN. Following each call the entire 3.5-Mc. band is monitored for answers. At the end of fifteen minutes the net is considered formed and the control repeats the calls of the stations in the net and their frequencies. Each station in turn is then asked to act as N.C.S., contacting all the other net stations and then signing. This finally leaves just two stations in the net so the order of listing is changed each drill so that one station will not always be at the end of the roll. This system gives all hands experience at handling the control job and enables everyone to familiarize himself with the frequencies of active Missouri stations in case contact were needed in emergency. There is no rag-chewing and no traffic handled on the net, it being more of a weekly mobilization of Missouri stations than the term "net" usually implies.

G2PL will be on the 1.75- and 3.5-Mc. bands until the end of March for DX contacts.

W2LRC, Richmond Hill, N. Y., and W8RGC, Paxinos, Pa., held a continuous QSO on February 5th, from 1:00 P.M. until 8:15 P.M., seven hours and a quarter, at the end of which period the rag had been quite thoroughly chewed! They did not continue this contact over such a long period as a mere stunt, however. Their idea was to test the reliability of low power over a protracted period. W8RGC used a 6L6 crystal oscillator with 15 watts input, powered from a Mallory Vibrapak and 6-volt storage battery. W2LRC used a 6L6 c.o. with about 27 watts input. Operation was on c.w. in the 3.5-Mc. band.

## O.B.S.

The following is a supplement to the list of A.R.R.L. Official Broadcasting Stations in October QST (page 71): W2JUX, W4CUE, W5GED, W8GAV, W8OQU, W9UNQ, W9WTD, W9ZIZ, W9ZSX, VE4EO, VE4NQ.

## BRIEFS

A new style "round table" was inaugurated by a group of six Chicago stations on February 16th. In the case of this round table each operator visited and operated each of the stations involved. It worked as follows: Each operator at his own station established contact with each of the other stations. The key station/operator, W9QWR (who furnished the only automobile used), left his shack at 12:47 p.m. and went to W9VEZ, who in turn took the auto and went to W9LSQ. W9LSQ went to W9WNA; W9WNA to W9RMO; W9RMO to W9SOZ; W9SOZ to W9QWR. This rotation continued until each participant had visited and operated all of the other stations. A relief operator, W9KRK, was used to take over the station of the operator who was en route. Upon completion of the circuit, putting W9QWR back at his own shack, the total mileage was 82.6. The purpose of this unique stunt was to discover how the six transmitters sounded at six different locations over six different receivers. Elapsed time was 5 hours, 38 minutes.

— . . . —

### American Legion Net

An American Legion Net to cover the State of California has been organized by W6BVC and W6ZM, A.R.R.L. Route Manager for the East Bay Section. Each A.L. post throughout the State will have a station assigned to it for net purposes; 135 stations are already lined up, and operation on a spot-frequency of 2045-kc. is planned when the 1.75-Mc. band limits are changed. Anyone interested in additional details on this net should communicate with W6BVC or W6ZM.

— . . . —

Mr. (W2OJ) and Mrs. (W2JZJ) Clifton Foss announce the arrival, on February 20th, of Barbara Jeanne. "Cliff" will be remembered as operator on the Schooner *Morrissey*, W1OXFP, in 1936. Congratulations, OJ and JZJ — may she be another hamess!

— . . . —

W4FB, on his way to club meeting, stopped in front of a member's house and blew "CQ" on the auto horn, intending to rout him out. Just as the CQ was being sent, a gentleman, who with his wife was passing the house at the time, stopped, came over to the car and said, "You don't happen to be an amateur, do you?" . . . "Yes, I'm W4FB" . . . to which the stranger replied, "Well, I'm Inspector ——— out of the New Orleans office. . . ." As a result the Inspector attended the meeting of the Mobile Amateur Radio Club. CQ's in Mobile sure get results!

— . . . —

### Re Book Messages

Messages of exactly the same texts but addressed to different addressees are known as "book" messages. They are sent as per the following example: "HR BOOK FOUR FM W1BVR CK 6 WESTFIELD MASS 630P APR 5 BT SEE YOU AT THE CONVENTION FRIDAY BT NOBLE AR NR 24 TO . . . . . NR 25 TO . . . . . NR 26 TO . . . . . NR 27 TO . . . . ." (Complete name and address in each case.)

This information is given as useful information to round out the knowledge of those especially interested in traffic handling. The League recommends that book-messages, numbered-texts, and rubber-stamp types be avoided and INDIVIDUALLY WORDED MESSAGES be used instead of stereotyped forms in every case possible. (Since many amateurs rate the value of the message by its text, a deferred type of service often results from improper relays in handling any traffic "quantitatively" by the special methods of numbered texts or "books.") These methods of the specialist are for particular schedules and circuits where operator behavior and discipline and experience of the highest type prevail.

— . . . —

A flycasting competition by radio was held between teams at San Francisco and Long Beach, Calif. As each cast was made, the information was sent to the opposing team via the

## Brass Pounders' League

(January 16th-February 15th)

Call	Orig.	Del.	Rel.	Extra Del.	Total
W4PL	21	112	3600	96	3829
W5DAQ	1700	423	184	423	2730
W4RE	11	138	1565	107	1824
W5BN	780	278	374	374	1806
W7EBQ	0	0	1715	0	1715
W5FDR	148	178	1176	164	1666
W8CZ	7	17	1388	14	1426
W3CIZ	20	115	1025	115	1273
W4BAQ	12	28	1064	28	1132
W3BWT	33	82	832	66	1013
W4FJR	2	4	996	2	1004
W4FEI	7	10	978	5	1000
W8HCS	0	0	992	0	992
W9GIL	61	127	678	121	987
W6IPG	37	75	724	75	911
W9ZDZ	13	13	879	5	910
W6IOX	10	35	792	31	868
W6CDA	34	28	798	3	863
W2CGG	20	147	620	27	814
W5DKR*	262	114	213	218	812
W8LVU	4	8	798	2	812
W7KTR	8	83	600	79	770
W6BAZ	34	99	531	99	763
W2GVZ	24	302	134	291	751
W2SC	24	116	514	29	683
W5ROE	23	145	476	12	661
W5MN	35	119	398	102	654
W6CEZ	32	110	485	10	637
W8QGD	59	107	371	88	625
W1INU	84	37	492	0	613
W4FX	7	25	564	0	596
W6GUK	140	52	200	200	592
W8CFP	27	193	417	37	586
W6LMN	16	32	512	26	586
W8JTT	12	22	522	15	571
W9NFL	10	12	538	11	571
W5FXX	255	84	110	110	559
W6IMI	21	74	384	77	556
W6CUD	38	21	469	5	533
W6LUT	56	192	84	188	530
W4AXP	24	13	476	9	522
W6LMD	6	9	493	6	514
W6LLW	21	67	418	7	513
W8PIH	17	10	480	5	512
W3EML	45	105	268	90	509
W4XCH	2	29	470	7	509
W5FRE	12	7	483	7	509
W8IXJ	42	16	450	1	509
W7WY	10	52	398	42	502

### MORE-THAN-ONE-OPERATOR STATIONS

Call	Orig.	Del.	Rel.	Extra Del.	Total
W4DUG	3310	15	10	15	3350
W5OW	216	290	1556	136	2198
KALHR	843	604	404	0	1851
W4DVO	1	30	582	20	633
W9BNT	40	114	407	13	574

These stations "make" the B.P.L. with total of 500 or over. One hundred deliveries + Ex. Del. Credits also rate B.P.L. standing. The following one-operator stations make the B.P.L. on deliveries. Deliveries count.

W6EJA, 386	W9NCX*, 131	W1JYJ, 105
W9ESA, 280	W6JTV, 123	W1GQJ, 104
W5EDY, 257	W4CZN, 122	W3GKC, 103
W7AFS, 230	W1KTN, 119	W1FSV, 101
W2JHB, 209	W9LCT, 118	W4AOB, 100
W9FLG, 188	W6ZM, 115	More-than-one-opr.
W6ZX, 180	W9VS, 115	W8RYE, 225
W2JZX, 169	W3AOC, 113	W1AW, 180
W9BDQ, 144	W6MQM, 112	W2HWI, 100
W8JQE, 131	W3CXO, 110	

A.A.R.S.

WLNB (W2DBQ) made the B.P.L. on 194 deliveries.  
WLLE (W9QC) made the B.P.L. on 137 deliveries.

### MORE-THAN-ONE-OPERATOR STATIONS

Call	Orig.	Del.	Rel.	Extra Del.	Total
W1M (W3CXL)	160	225	4127	111	4623
WLN (W2SC)	52	804	67	48	971

A total of 500 or more, or 100 deliveries Ex. D. Cr. will put you in line for a place in the B.P.L.

\* All traffic handled on radiophone.

\*\* December-January.

following net: W6GYO, portable on 28 Mc. at the S. F. pool, W6CSX on 3.9-Mc. 'phone to W6FVE to W6IWU to W6QJZ and then to W6ERS, portable at the Long Beach pool. The set-up worked splendidly and amateur radio won some new boosters.

# How's DX?

## HOW:

**N**O DOUBT a few of the readers of this page envy those fellows up near the top of the DXCC, what with all their confirmed countries and stuff. The listing is designed, of course, to be the rating of those fellows interested in working a flock of countries, and confirmation is required simply as evidence that the foreign station worked was not a phoney or a product of the DX man's imagination. The rush for new countries and cards has developed a few cut-throat operating practices with which everyone is familiar, so they don't need mentioning here. Some of that can be forgiven and excused on the basis of over-enthusiasm (or selfishness), but a new practice seems to be cropping up that isn't going to be tolerated on any ground. Believe it or not, some of your big-gun DX idols, listed in the CC, have been so anxious to improve their standing that they have been altering and forging cards submitted as evidence! Nice guys, what? The obvious insult to the intelligence of W1JMY (who handles the CC listing) might be overlooked, but one can't dismiss the fact that, if the DXCC is to mean anything, there isn't any room in the list for lugs like that. So, because anyone who has worked towards the thing wants the award and list to mean something, the lads who submitted the forged cards, and any subsequent offenders, will be dropped from the list. If there must be DX idols in this game, they aren't going to have feet of clay if it can be helped.

On the other hand, the large majority of the gang listed there is a mighty decent lot, and it's unfortunate that they have had to be associated with a few undesirables. Our apologies — the situation will be remedied as soon as possible.

## WHERE:

**A**JURCY one that showed up last month, to the delight of the devotees, is CR4HT (14,435 T9c). He gives his address as Henrique Torres, Box 61, Praia, Cape Verde Islands, and should be OK . . . . No doubt you guys gave out with a snicker or two when XU4XA's cards came through, proving our suspicions completely groundless. W4FJK, ex-XU4DW, knew him in Shanghai, and says he is now at Chung-king. 117 of the cards came through to W2CMY — you can claim yours with a stamped envelope to CMY . . . . Asians on 40 coming through on the east coast make good news, which is why you'll be glad to know that W3ATR worked YI2BA (7090 T7) and W3CHH

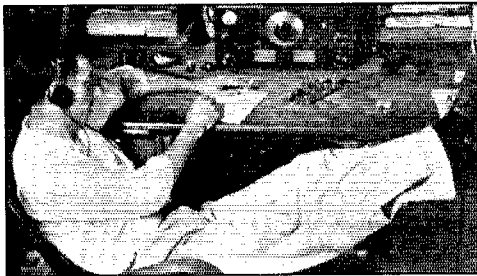

This peaceful-looking gentleman is none other than Claude Moore, W9HLF, who has every right to sit back and take it easy. On January 6th he worked AC4YN (14,295) to give the Tibet station his WAC and first W contact. W2CMY and W2JT have also worked 4YN, but Moore gets the credit for grabbing him first.

W9HLF uses a pair of 354E's in the final and a 3-element Bassett rotary, but, best of all, he has what it takes to beat the boys to that elusive Asian, AC4YN.

and W3BGO worked ZC6RL (7050 T9), YI2BA is on around 5 p.m. EST, Saturdays and Sundays — the ZC6 was on around midnight . . . . W8GER says that CX2AJ has had 10,000 cards printed, so you're in line for one if you've QSL'd . . . . VK2CI tells us that he knows the operator who was using POPI, PR1VY, OH2BU and AH2BU, and if you want to send cards you can do so care of 2CI. Gordon says "the lucky ones will be greatly surprised when they receive their QSL's." No doubt . . . . We don't know about FP8AA (14,410 T7). The dope is that he was coming to New York and would send us a list of QSO's, but so far we haven't heard . . . . Don't let the prefix "LB" get you all h. & b. LA6A radiograms to inform us that it's the new Norwegian portable-prefix . . . . If you worked PY1JW during I936, send a card to J. C. Williams, Box 687, Liberty, Texas. He *wasn't* in Brazil, and may give you a new country . . . . We have a lot of cards on hand for BITOO — if he reads this we wish he'd claim them . . . . W5HIP worked a station signing LD8Z (14,390) who claimed to be on a treasure-hunting expedition at some island off the coast of Uruguay. Maybe so — there are several such expeditions out . . . . W2WC says that W9AM/KDRC, the whaling ship in the Antarctic, is now on 14,350, having to give up 28-Mc. 'phone because of the punko conditions. He was at 62° S 31° E on February 4th . . . . The N.A.R.A. says that cards coming through for VOIDD and VOIDL have to be scrapped, since there are no two-letter VO's as yet . . . . W6QAQ says VQ1TR (14,410 T9x) said to QSL care of Radio VPZ, Zanzibar . . . . W2HHF gives the new QTH of EL2A (14,275 T7) as Pete Kondik, Monrovia, Liberia, and also worked ZC2MA (14,300), who said to QSL via PK4ES.

## WHEN:

**W**8KWA and VE1EA have been going after the 160-meter DX with good results. Wick worked FA8BG, but top honors go to VE1EA for FA8BG, F8, G and GW contacts. FA8BG heard W5FQQ on 160, which spells real DX on that band. Incidentally, VE1EA has contacts on *five* bands with FA8BG, G2PL and G6XL.

The 3.5-Mc. band still produces a goodly bit of transatlantic stuff, with ON4HC, G6WV, G2PL, HA9U, PAOAG, F8IH, F8BB and HB9BB the most consistent. More unusual, however, is the consistent working on 3.9-Mc. 'phone of ZL2BE (3900), ZL2BN (3965) and ZL1KN (3930) by W4ECZ. Around 6 a.m. seems to be the best time for the Zedders.

Best bit of 28-Mc. cream we've heard about is by W3CBT, who blames his new lazy-H-with-director for pulling, through PK2WL (28,240) and PK1VS (28,220), just about the time the VK's fade out. W1WV and W2JGF report Europeans and FA8BG the only thing on 10 there.

Good old 40 (how one's attitude changes!) has been kicking through with a fine performance. The one we like is VK2AKF in the late afternoon, worked by W1HME, which makes it the long way 'round and very nice going. HME also finds that time good for Europe and Africa . . . . Besides YI2BA mentioned previously, W3ATR has been knocking off FA3RY (7120 T9x), CT3AN (7060), SP1YX (7055), LY1AD (7015), HI3C (7080) and CT2BJ (7030 and elsewhere). ATR says that he was told by G8QQ that VU2AN is on 40 now . . . . W3BZE worked HPIX (7110 T9x), QSL via W8DOD only, HR5CB (7215 T7), HA2L (7050 T9), YR5BF (7225), CE2BF (7230) and OZ2NU (7220) . . . . W7GZN has heard G2PU (7050), and W7CKH heard both sides of a 7-Mc. QSO between ZL2MM and a G5 . . . . W1KKS adds SU5KW (7180 T8) and VP2SC (7265 T7), and W2GTW has a swell list including UK5KJ (7220 T8), FA3WW (7270 T9x), EI9N (7055 T9x) and LA7C (7250 T9) . . . . G8OK (7270



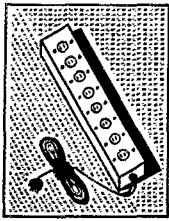

WE HAVE just completed a 100 kc. crystal oscillator for our own use that we think is pretty nifty. It is designed for relay rack mounting, is completely self-contained and has a front-of-panel control for the crystal holder air-gap, so that the frequency can be checked and adjusted against WWV or any of the "even 100 kc." broadcast stations by adjusting the proper harmonic for zero beat. The oscillator tube is an 1851, and the rectifier a 6X5. Useful harmonics for receiver calibration can be had as high as

the 14 mc band. Thus when used in connection with a good ham receiver the frequency measuring requirements of the new FCC regulations can be complied with on the 160, 80, 40 and 20 meter bands. Of course our "National" parts were used throughout except for the crystal, which is one of Herb Hollister's. As this space is much too small to give further details here, we have prepared a small descriptive pamphlet (with the hope, of course of selling a few of our parts) which can be had from any of our regular franchised dealers, or free by mail.

Talking about making things brings to mind another handy gadget we recently made for our own home lab and shop. It is a multiple AC outlet unit. In fact, we found the first one so handy that we soon made several more, one for the back of the relay rack, one for the work table on which we do most of our circuit experimenting, and one for the photographic darkroom. The illustration above gives the general idea. The chassis is the standard National unit made for the fixed-tuned high fidelity band tuners. The socket holes were enlarged to the right size for the standard flush-type AC outlets by means of a Greenlee punch, although a plumbers reamer could, if necessary, have been used for the same purpose. Additional holes were added between the former socket holes so that in the 17 x 3 x 1 $\frac{1}{4}$ " chassis eight outlets could be mounted. The AC cord was brought in through the rubber-grommet lined hole originally intended for the power supply cord.

In the past, we have strongly recommended the HRO's equipped with 2.5 volt tubes over those equipped with 6.3 volt tubes where operation was to be from an AC power pack rather than batteries. This recommendation was based largely upon the difficulty experienced with modulation hum encountered in the vicinity of 15 mc. when AC was used on the 6.3 volt tube heaters. For some months now, the 6.3 volt tubes we have been receiving from both of our suppliers have been so completely free of this former trouble that we are now able to offer a 6.3 volt tube HRO for AC operation that in every way equals the 2.5 volt tube model. A new power unit, the No. 697 (same rating as the No. 5897 but with 6.3 volt, rather than 2.5 volt, heater supply) is also now available. This new power unit should not be used with the 6.3 volt HRO's heretofore supplied for battery operation, as the plate voltage will be much too high. Incidentally, all National power packs are now furnished complete with rectifier tubes, at no additional charge.

JAMES MILLEN



Is it any wonder —

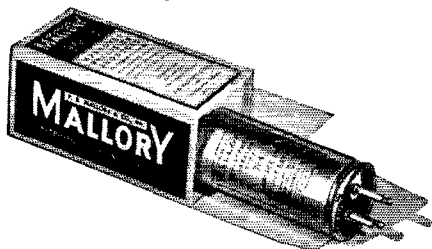

**P. R. MALLORY & CO., Inc.**  
**MALLORY**  
**V** Replacement  
**I** B R A T O R S  
**L**ead the field?

Mallory Vibrators are original equipment in the auto radio receivers built for Buick, Chevrolet, Ford, Hudson, Nash, Oldsmobile, Pontiac, Sears-Roebuck, Western Auto and Firestone. They are also standard in the receivers built by RCA, Zenith, Stromberg-Carlson, Stewart-Warner, Crosley, Spartan and 15 other outstanding manufacturers.

Such universal confidence in the performance of a product is Mallory's most cherished possession. Here is a selection by experts . . . the very tops in the industry.

Mallory Replacement Vibrators offer you the same outstanding performance that has won the manufacturer's acclaim. They will give long life, and maintain the "B" voltage at its initial value throughout practically their entire life span.

**P. R. MALLORY & CO., Inc.**  
**INDIANAPOLIS INDIANA**  
 Cable Address—PELMALLO

Use  
**P. R. MALLORY & CO. Inc.**  
**MALLORY**  
 APPROVED RADIO  
 PRECISION PRODUCTS

Use  
**YAXLEY**  
 APPROVED RADIO  
 PRECISION PRODUCTS

T9) in the Channel Islands is on regularly, according to W3BGD, who also reports a QSO with YV4AX (7260 T9) . . . . . W6PMV adds J6CD (7045), J2IX (7080 T9), J3HF (7085 T9), and KD6QLS (7025 T8) on Midway . . . . . The smart tone on 40 seems to be the late afternoon, according to most of the gang, so you might give it a whirl when April showers break up that golf game.

It's a shame we can't show you all of W2HHF's list, but the choice stuff worked includes CR6AI (13,900 T8), OQ5AV (14,035), PK4KO (14,355 T8), U5KY (14,360), VU2EB (14,360), VS7RA (14,260), VQ2JC (14,360), VS1AL (14,330), VS3AD (14,255), VK4HN (14,290), PK1MF (14,350), KA1SP (14,310), PK4FS (14,320) and VU2AN (14,320) . . . . . W6SN certainly is spoiled, because after working a whole mess of stuff which includes VK9BW (14,095 T9), ZD2H (14,350 T9), CR7BC (14,350 T5), FB8AD (14,340 T9), KF6DSF (14,395 T9), HH3JL (14,400 T9), VP1JR (14,420 T7) and VS2AL (14,405 T7), he says the band sounds lousy! . . . . . New DX at W6PNO is stuff like HCLHM (14,425), HA2N (14,365), SUI1DM (14,290), VP8AD (14,400) VQ2GW (14,340), ZC6EC (14,300) and ST6KR (14,350) . . . . . W8LCN worked XU4XA (14,290 T9) and PK4KS (14,320), and heard VS6AH (14,410) and TC9BA (14,285) . . . . . Random bets, thanks to W1WV, W2KZP and W7ENW: KF6PMO (14,385 T8), YM4AS (14,410 T9), FY8C (14,340), VQ8AI (14,325), PK1RI (14,320), CR7AF (14,290), XZ2JB (14,000 and 14,300 T9), TF5M (14,300 T9), VS7RF (14,300 T9) and VQ3HJP (14,335).

**'PHONE:**

**W**6ITH has a nice lot of stuff, including 11TKM (28,080), VK9VG (14,260), KF6ODC (14,035), KG6NVJ (28,390), HK3CL (14,035), ES5D (14,050), OAA4C (14,275), HH2PB (14,340), FB8AH (14,380), CT1AY (14,015), XZ2EX (14,060), XZ2DX (14,040), OX7ZL (14,025) and PK4KS (14,325). FN1C (14,210 and 14,040) was heard . . . . . W61KQ contributes SUI1RD, SUI1WM, OH2OI, VP3AA, KF6DHW, VP4TK and VP9L, without benefit of frequency, except that they were on 20 . . . . . At W8AAJ it's PK1VM (14,060), PK2AY (14,015), PK2WL (14,125), XU3AA (14,075), VQ4ECJ (14,010), and plenty of KA and ZS . . . . . W2AZ worked K7EST when he was on in Siberia, bringing his total to 106 on 'phone . . . . . VK5WR says KA1JM, who has a native accent

(Continued on page 74)



It's a well-known fact that a large majority of antennas go up by moonlight the night before the Contest, so we sent our ever-vigilant candid cameraman to visit some ham-shacks on that all-important evening. There wasn't any moon that night, but the snooper got some good shots, or so he says. Because of space limitations (and because there was a marked similarity between pictures), a composite view is presented.

That fellow in the upper left-hand corner is none other than W3EMM, splashing into the lake as he tripped over a stake, on his way to add another leg to a rhombic. That spot in the lower right is the pipe of W2UK, glowing with satisfaction as Tommy finds that his rotary only sticks in three places now that he has climbed the pole and oiled the mechanism again. Those streaks in the center are the ribbons W5VV has just finished tying to his skywire, in an effort to entice more of the power to leave his final and come up and see what the party's all about, while W8OSL is over there in the lower left soldering empty beer cans together for a new vertical.

That prominent black spot is a group shot of 11,762 electric razors, planning how they can most effectively gum up the whole works.

# NOW! RAYTHEON QUALITY TRIODES AT A NEW LOW PRICE!

**\$6.95**

RK 51 and RK 52



**SPRING MOUNTED THORIATED FILAMENT**, substantially built to "take the bumps"

**LAVA INSULATORS**, not Mica, to guarantee perfect alignment and freedom from gassing.

**OVERSIZED GRAPHITE ANODE**, will neither warp nor show color!

**HARD GLASS BULB**, permitting higher temperatures without danger of tube going soft!

**BIG 4—PILLAR STEM**, assuring rigid support!

**ISOLANTITE BASE**, for efficient high frequency operation.

**E**LECTRICALLY, too, as well as mechanically, these high quality RAYTHEON TRIODES represent outstanding values! Here's a 28.1 watt filament, 30% higher than ordinary tubes, that provides a lasting steady source of electrons and will take those big surges. The tubes are hand pumped extra hard, and every part has been carefully and painstakingly processed. In fact, Raytheon Amateur Transmitting Tubes are hand made by tube engineers for greater precision. It's these unseen values that guarantee the long life and dependable performance for which Raytheons are noted.

Both these tubes are rated at 60 Watt plate dissipation. The RK 51 is a low mu (20) tube, particularly designed for RF work. The RK 52 is a high mu (150) tube engineered primarily for class B audio. At 1500 volts, the RK 51 puts out 170 watts at 70% efficiency. A pair of RK 52's at 1250 plate voltage and zero bias deliver 250 watts of audio at less than 5% distortion. You will be amazed at how little it takes to drive them.

Here's performance, operation, high quality, long life, now at a new low price.

Ask your parts jobber for "Raytheon RK's" for the biggest tube values.

RK 51	RK 52
<b>Class C—1 Tube</b>	<b>2 Tubes—Class B</b>
EF — 7.5 volts	EF — 7.5 volts
IF — 3.75 amp.	IF — 3.75 amp.
EP — 1500 volts	EP — 1250 volts
IP — 150 ma	IP — 300 ma.
EG — 250 volts	EG — 0 volts
Driving Power—10 watts	Driving Power 7.5 watts
Output—170 watts	Power Output 250 watts

## RAYTHEON RK TRANSMITTING TUBES

NEWTON, MASS. • NEW YORK • CHICAGO • SAN FRANCISCO • ATLANTA •

**"WORLD'S LARGEST EXCLUSIVE RADIO TUBE MANUFACTURERS"**

# BUILT TO OUTLAST A LOT OF RIGS!

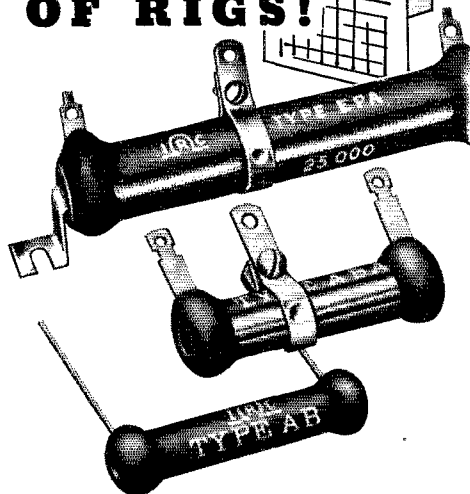

**T**ubes and circuits change, but power supplies go on forever. It pays to use rugged resistors because they never become obsolete. Long after this year's hook-up has been dismantled, and yesterday's overloads shaken off and forgotten, your IRC Power Wire Wound Resistors will be looking for new worlds to conquer.

## INTERNATIONAL RESISTANCE CO.

401 N. Broad St., Philadelphia, Pa.

### OTHER IRC PRODUCTS

Insulated Metallized Resistors • Precision Wire Wound Resistors • High-Voltage Resistors • High-Frequency Resistors • Attenuators • Rheostats • Metallized Controls • Resistance Analyzers, etc.



**Cement Coated**

**POWER**

**WIRE WOUND**

**RESISTORS**

does it this way: "This is KA1JM, calling any 20-meter phoney stations!"

## WHO:

**D**UNNO how he does it, but W6QD moved his QTH to a place where there are already a flock of DXers, and then talked some of them into helping him put up a couple of 70-footers! Page Dale Carnegie . . . . . PK6XX is due back in a few months, and will QSL everybody he worked . . . . . YV2CU got the rig down on 10, and has been working a few of the boys there . . . . . ZS2AG (14,310) needs Alabama, Arizona, Idaho, Tennessee, Minnesota and Mississippi, for the same reason that VK3QB (7250) wants Delaware, North and South Dakota, Tennessee, Mississippi, Arkansas, Wyoming, Kentucky, Missouri and South Carolina . . . . . After trying in vain for a long time to find a loquacious W or VE, W1AFG worked VK2ADE for two hours and himself into the RCC . . . . . We were all wrong about VK9XX. He ain't a phoney and he's still at Rabaul . . . . . W9MUX worked G16TK on four bands, nice work from that part of the country . . . . . If you worked OA4AB after December, 1938, you can get a card by writing to W9GLG. Incidentally, OA4AB was probably the highest permanent station in the world, sitting a mere 14,340 feet above sea level . . . . . It's bad news, but ZS3F has been transferred, so there is no more Southwest Africa contact for a while . . . . . G6IA may be tough from now on, according to the grapevine. The Isle of Man station doesn't think he should be counted as a separate country, and is fed up with the publicity he's had and the requests for cards . . . . . VP8AD is anxious to get on 'phone, but salaries being what they are it's out of the question. He'd probably appreciate it if anyone sent him some of the old gear that's around every shack. No, he didn't ask us to print this — we heard it from G6QX . . . . . W6LTM was F1NC's first W, about two years ago . . . . . G5MP (3580) is on every morning between 06 and 0730 GT, looking for W, South Americans and ZL, and would appreciate reports . . . . . New DX at VK2AGH (ex-VK3WO) includes HB9BD (14,375 T9), ZE1JT (14,300 T9), UK3AH (14,320 T7), CR7AF (14,350 T9) and a threeway with AC4YN and VK2VA . . . . . VK2DG is unemployed and hence his QSL's are handmade and take time. However, he will QSL all those who sent him cards . . . . . We're inclined to agree with W9GMV that this business of a W station calling a DX station he hasn't even heard is rather silly. GMV has the clincher, though. It seems that last summer he had a sked with KA1BC, but on the day of the sked he called KA1RW instead of 1BC, out of habit, since when he was W5FSE a few years ago he kept a daily sked with 1RW. GMV caught his error just as he signed. When he listened in, there was W9—, right on the same frequency, merrily calling KA1RW. RW left KA1 in June, 1937!

## DX CONTEST:

**W**E CAN'T give you anything but the Connecticut slant on the first three days of the fracas, on account of this has to get to the printer (Jeeves, did I hear you ask "Why"?), but there has been enough time to get a few impressions. Europe is good on 40 but seems to sail right over our heads on 20 and 10, and the Africans are best on 10 and only fair on the other bands. Asians are pretty fair on 20 and nil on the other bands. Oceania is good on all bands and so is South America. Europe and its many multipliers will decide the story, and it things keep up the way they are, the W6's are going to be way out in front unless the W2's and W3's come to our rescue. Ah, DX!

## Hamfest Schedule

**April 2d, at Richmond, Va.:** The Richmond Amateur Radio Club will be host to the Virginia Floating Club and all other hams who wish to come to a hamfest to be held in Richmond, Va., on April 2d. Meetings of the various nets are scheduled, 1.75-Mc. 'phone, 3.9-Mc. 'phone, A.A.R.S., etc. Registration will begin at noon, regular meeting at 2:00 p.m., feed bag at 5:00 p.m. Come early and stay late. Additional details are available from Larry Arnold, W3FBL, 527 West Broad, Richmond.

**April 15th, at Framingham, Mass.:** The Sixth Annual Hamfest of the Framingham Radio Club will be held at the

*the*  
**RUSH**  
**IS**  
**ON!!**



*for the*

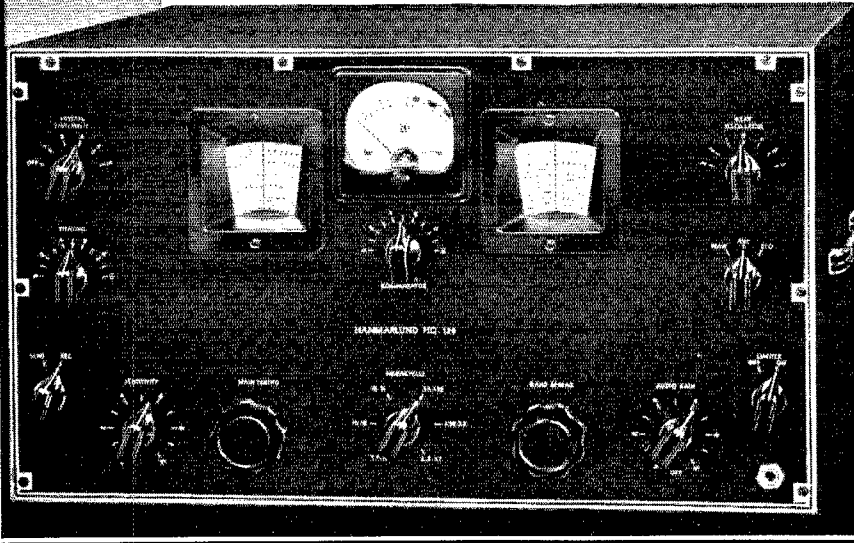

**HQ-120**

"IT'S HOT", that's what hams everywhere are saying about the new "HQ-120-X". Never before have they been so impressed by the performance of a moderately low priced receiver. The ability of the "HQ-120-X" to pull in weak signals has utterly amazed all who have tried it. This high sensitivity is uniform throughout all bands and provides accurate "S" meter readings. "Phone-men" are finding the phone bands effectively doubled in width because the new variable selectivity crystal filter works as well on phone as on CW. Then there's the highly accurate

calibrated band spread dial—this is the greatest operating convenience ever offered in a receiver. Only precision construction throughout made this possible.

**Write for booklet!**

HAMMARLUND MFG. CO., INC.  
 424-438 W. 33rd St., N. Y. C.

Q-4-39

Please send 16-page booklet

Name.....

Address.....

City.....State.....

Canadian Office: 41 West Ave. No.  
 Hamilton, Ont.



**HAMMARLUND**

# HERE IT IS... HAMPS

A New  
A.C. and D.C.  
Pocket  
Volt-Ohm-  
Milliammeter

with ranges to  
5000 volts —  
self-contained.



Size: 3-1/16"  
x 5 3/4" x 2 3/4"

MODEL  
666-H

*Will handle all  
Amateur Requirements*

\$14.50  
Net Price



● Now, a new Triplet A.C. and D.C. Pocket Volt-Ohm-Milliammeter that will handle voltages to 5000 volts without external multipliers. It will check the high voltages and circuits of transmitters and receivers — just the instrument for amateur use.

Ranges: AC-DC Voltage at 1000 Ohms per volt 0-10-50-250-1000-5000; D.C. Milliamperes 0-10-100-500; Resistance 0-300 shunt type 10 ohm reading at center scale; 0-250,000 series type, 3700 ohms at center scale.

Black Molded Case and Panel. Complete. Net Price.....\$14.50

Model 666—uses same case as 666-H. Reads to 1000 volts at 1000 ohms per volt. Complete with Alligator Clips, Battery and Test Leads. Net Price.....\$14.00

**EXCLUSIVE TRIPLET LOW LOSS SWITCH**—Incorporated in Models 666-H and 666. Uses two silvered contacts instead of one, insuring lower contact resistance. On actual breakdown test, on and off operation exceeded 10 million times without failure.

The Triplet Electrical Instrument Co.  
254 Harmon Ave., Bluffton, Ohio

Please send me more information on  
 Model 666-H     Model 666  
 Thermo-Ammeters

Name.....

Address.....

City..... State.....

## THERMO-AMMETERS

Prices greatly reduced. For a more efficient antennae circuit, investigate Triplet Thermo-Ammeters at your parts jobber.

WRITE FOR  
CATALOG!

Hotel Kendall, Concord St., Framingham, Mass., on April 15th. Registration \$2.00, including 56-Mc. treasure hunts, lectures, contests and banquet at 7:00 P.M. Activities start at 2:00 P.M.

**April 15th, at Roseville, Calif.:** Plans are being made for a big hamfest in Roseville, Calif., April 14th, under the auspices of the Placer Radio Club. There will be many valuable prizes, and the committee is working on a very interesting program. Price will be \$1.00. Advance registration or notice of attendance is requested. Address the club president, A. S. Gulliford, W6FPN, Box 73, Lincoln, Calif.

**April 22d, at Newark, N. J.:** The Union County Amateur Radio Association, Inc., is going to run another hamfest at Kreuger's Auditorium, Belmont and Springfield Avenues, Newark, N. J., on April 22d, at 8:00 P.M. There will be several well-known speakers, demonstrations, entertainment, prizes, refreshments and dancing. As feature prizes there will be two RME-70 receivers complete, a gross of Taylor and Eimac transmitting tubes, and twenty-five type 301 Weston meters. As in previous years the Association is planning to accommodate 2500 people. The price of admission, which includes refreshments, is \$1.00.

**April 30th, at Birmingham, Ala.:** The Birmingham Amateur Radio Club, a 100 per cent A.R.R.L. club, announces that it will stage a hamfest in Birmingham on Sunday, April 30th. All amateurs within range are invited to attend. Further details are available from the B.A.R.C. secretary, E. W. Smith, W4ERW, R. 2, Box A-1, Birmingham, Ala.

## Simulated Emergency

Amateurs of Oakland, Calif., tested their emergency facilities and capabilities on January 9th, simulating conditions as they might be found following an "earthquake of unprecedented proportions." Working under the Red Cross Emergency Disaster Relief Plan, it was serious business for the operators involved, and they could hardly have performed better had there actually been a disaster. Coöperating in the test were members of the Naval Communication Reserve, Oakland Radio Club, Society of Amateur Radio Operators, Mission Trail Net and the Berkeley Police Department.

On February 1st a meeting was held in Oakland to go over the performance in the January 9th test and to make plans to better future work, if possible. The N.C.R., Oakland Radio Club, S.A.R.C.O., Mission Trail Net, the Alameda Chapter of the Red Cross and several others met at the call of Mr. Charles A. Turner of the Oakland Red Cross chapter. The delegates present were appointed a committee to formulate a plan to coordinate the efforts of the various groups in case of actual emergency.

On February 16th, O. L. Day, W6OBJ, of the Oakland Radio Club attended a Red Cross meeting as representative of the club and was presented with a certificate of appreciation in recognition of service faithfully performed. This certificate was signed by President Roosevelt and Admiral Cary T. Grayson.

The start of the A.R.R.L. QSO Party on January 8th took an unexpected turn at W4CZA, Ft. Moultrie, S. C. W4CZA and W4CZN went into the shack about 5:00 P.M. to warm up the gear. Taking a listen on 3.5 Mc. to see how things sounded, W4CZN heard "CQ Fort Moultrie de W4CWM." Knowing that their buddy (CWM) was normally stationed at the C.C.C. Camp at Fort Moultrie, the lads wondered what was going on. Firing up W4CZA they made contact and discovered that W4CWM was on Bulls Island with an important message for the Post hospital. A patient was being sent by boat from Bulls Bay to arrive at Moores Landing about 6:15. Bulls Bay is about 20 miles north of Ft. Moultrie and 4 miles from the mainland through mud flats and marshes—difficult territory to navigate at night. Leaving W4CZN to maintain contact with CWM, W4CZA jumped into his car and rushed the message to the hospital. Instructions were issued to have an ambulance proceed to Moores Landing. Details on how to reach the Landing were received from W4CWM, and W4CZA marked the route on a map for the officer in charge of the ambulance. "Tell Bulls Bay that we will be at the Landing by 6:30," said the officer. The patient reached the hospital an hour or so later. Once again amateur radio had "turned the trick." W4CWM was using emergency power, being located on Bulls Island with a C.C.C. company. Radio and boat were the only means of communication.

# AMATEUR RADIO

## Gets Its MAN

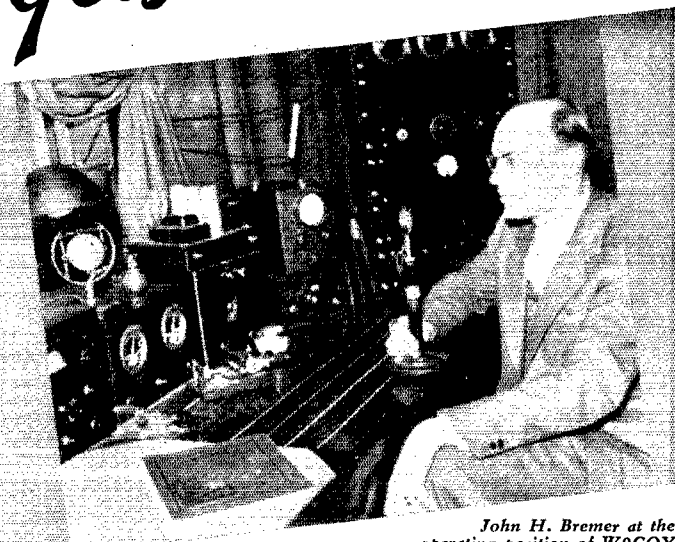
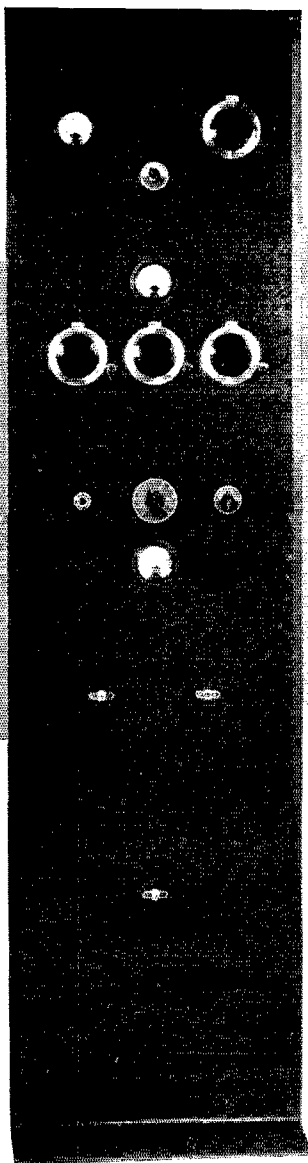

*John H. Bremer at the operating position of W9CQY*

A young Chicagoan, hunting caribou in the wilds of Alaska far beyond the reach of regular communication, recently had amateur radio to thank for calling him to his dying mother's bedside, thus granting one of her last wishes.

Members of his family were put in touch with John H. Bremer, W9CQY, who is in charge of amateur radio activities for the Chicago Park District and director of River Park. Bremer and members of his River Park Radio Club immediately sought contact with Alaskan hams who were nearest the area where the Chicago youth was known to be. Hams all along the line gave aid and arrangements were made for Robert R. Gould, K7ATO, to maintain a regular schedule with W9CQY. Gould located the hunter the following day. An Alaskan patrol boat, a U. S. Coast Guard cutter, and a regular airline plane brought him to Chicago.

W9CQY uses a 1000 watt transmitter completely equipped with Thordarson transformers and chokes. Another example of Thordarson dependability.

**THORDARSON ELECTRIC MFG. CO.**

**500 W. HURON ST., CHICAGO, ILL.**

*Demand "Power by Thordarson"*

# It's the one and only "HAMMETER"

**3,000 VOLTS,  
self-contained**

No External Multipliers necessary

## The tester YOUR NEEDS designed

**Y**ES, the Hammeter is the first self-contained, pocket-size-tester built lock stock and barrel for your needs. It gives you everything you can ask for in checking high voltage, steps of construction, and trouble shooting. And the most remarkable thing about it, when range and quality is considered, is that modest price of \$14.75.

The Simpson D'Arsonval movement with expensive bridge-type construction and soft-iron pole pieces, gives life-time accuracy to the Hammeter. Both A. C. and D. C. ranges have resistance of 1,000 ohms per volt. Test cables are insulated for 5,000 volts; tips and clips are also heavily insulated. In fact, the Hammeter is shock-proof from case to test prod.

Its appearance speaks quality—a handsome black formica panel with gold lettering—a silver etched scale as used in the finest instruments—a modern, accurate, knife-edge pointer. The Hammeter measures only 5 1/4 x 2 7/8 x 1 3/4" and weighs only 20 ounces. Note its ranges. See it. Use it.

## The finest of panel instruments at lower prices

The value of Simpson Panel Instruments with bridge-type construction has been made all the more sensational by these new low prices:

**R. F. AMMETERS**—Internal thermo-couple radio frequency ammeters (1, 1/2, 2, 2 1/2, 3 or 5 Amps.) **\$4.59**

**HIGH RANGE VOLTMETERS**—D. C. plate voltmeters, complete with external resistors, (1,000-1,500-2,000-2,500-3,000 or 4,000 volts). **\$8.90**

(5,000 volt range \$12.00 net)

**DECIBEL METERS**—Rectifier type volume level indicator [—10 to +6 db (500 ohm line; 6 M.W.)] **\$7.84**

**OTHER OUTSTANDING VALUES ARE:**

D.C. plate milliammeters (all popular ranges from 0-5 to 0-1,000 milliamps). List \$6.35. **\$4.15**

A.C. filament voltmeters (0-10 or 0-15 V.) List \$6.35. **\$4.15**

Illuminated dials for all popular ranges, including 6V. lamp, 50c net additional.

**SIMPSON ELECTRIC CO.**

5210 Kinzie Street,

Chicago, Ill.



**MODEL  
240**

### NOTE THESE RANGES:

A. C. volts: 0-15-150-750-3,000. D. C. volts: 0-15-75-300-750-3,000.

D. C. milliamps: 0-15-150-750. Ohms: 0-3,000 (center scale 30) and 0-300-0-500 (center scale 3,000).

Your net price..... **\$14.75**

### MEMBERS, DX CENTURY CLUB

G6WY (No. 5)....	144	VK5WR (No. 49)....	109
W8CRA (No. 1)....	135	PA0XF (No. 43)....	108
W1TW (No. 3)....	134	W3EVT (No. 51)....	108
W2GTZ (No. 12)....	134	W8BKP (No. 65)....	108
W6GRL (No. 15)....	134	W3DDM (No. 72)....	108
W1SZ (No. 7)....	133	W4CYU (No. 78)....	108
W8DFH (No. 14)....	133	W2DC (No. 79)....	108
W2GT (No. 32)....	133	W6HX (No. 21)....	107
W6CXW (No. 4)....	132	G6CL (No. 24)....	107
G2ZQ (No. 6)....	130	W6FZL (No. 48)....	107
W8BTI (No. 56)....	129	W2AAL (No. 81)....	107
ON4AU (No. 40)....	128	W2ZA (No. 88)....	107
W1TS (No. 9)....	127	G5BJ (No. 93)....	107
W2GW (No. 11)....	125	G5RV (No. 64)....	106
W6KIP (No. 28)....	125	G2TR (No. 83)....	106
W9ARL (No. 18)....	124	D4AFF (No. 99)....	106
W1LZ (No. 10)....	123	VE2AX (No. 84)....	105
W3EMM (No. 58)....	122	W4DRD (No. 94)....	105
HB9J (No. 13)....	121	W9TB (No. 95)....	105
W8DHC (No. 27)....	120	W9UM (No. 108)....	105
W1DF (No. 29)....	120	W2OA (No. 73)....	104
J5CC (No. 46)....	120	W3GAU (No. 96)....	104
W1FH (No. 71)....	119	E1SF (No. 19)....	104
W1BUX (No. 2)....	118	G5QY (No. 103)....	104
W9KG (No. 16)....	118	G6KP (No. 45)....	103
W8OSL (No. 23)....	118	W2CJM (No. 47)....	103
W5BB (No. 37)....	118	W1CH (No. 91)....	103
W8OQF (No. 30)....	117	W3AG (No. 107)....	103
W8ADG (No. 63)....	117	W6FZY (No. 115)....	103
W4BPD (No. 70)....	117	W4CBY (No. 20)....	102
W8DWV (No. 17)....	116	W1WV (No. 69)....	102
W2UK (No. 33)....	116	W8NJP (No. 90)....	102
W3EPV (No. 74)....	116	W5KC (No. 92)....	102
W8JMP (No. 22)....	115	G2DH (No. 101)....	102
W8LEC (No. 25)....	115	W2BYP (No. 102)....	102
W7AMX (No. 26)....	115	W1ADM (No. 110)....	102
W9PST (No. 35)....	115	F8RJ (No. 8)....	101
W5VV (No. 38)....	115	VK3KX (No. 57)....	101
W9EF (No. 44)....	115	ZL1HY (No. 59)....	101
W9TJ (No. 67)....	114	W1ZB (No. 62)....	101
W3CHE (No. 87)....	113	W4AJX (No. 75)....	101
G6RH (No. 36)....	112	W6DOB (No. 76)....	101
W9KA (No. 42)....	112	W1DUK (No. 82)....	101
W6GAL (No. 50)....	112	W2CBO (No. 86)....	101
W4CEN (No. 60)....	112	SUIWM (No. 89)....	101
W3EUV (No. 55)....	112	F8RR (No. 98)....	101
W2BHW (No. 39)....	112	W1AXA (No. 104)....	101
W2CMY (No. 68)....	111	W1CC (No. 106)....	101
W9FS (No. 77)....	111	W3FRY (No. 85)....	100
ON4UU (No. 31)....	110	W8EUY (No. 97)....	100
W6ADP (No. 34)....	110	W2DXB (No. 100)....	100
W9GDH (No. 41)....	110	G6NF (No. 105)....	100
W2CYS (No. 52)....	110	W8KKG (No. 109)....	100
W3EDP (No. 53)....	110	W2AER (No. 111)....	100
W2HHF (No. 54)....	110	VK2DG (No. 112)....	100
W9ADN (No. 61)....	110	W6KRI (No. 133)....	100
W1JPE (No. 66)....	110	W6TJ (No. 114)....	100
W2GVZ (No. 80)....	110	W9UQT (No. 116)....	100

The following have submitted proof of contact with 75-or-more countries: PA0QF, W9AJA 99; W1BGY, W1GDY 98; G5BD, G6GH, W1ZI, W8AU, W8OXO 97; G2MI, VE2EE, W1FTR, W1GXC, W8BOX 96; HB9BG, W1GNE, W8RES 95; W1LX 94; FB8AB, W3BEN, W6BAM, W6GHU 93; J2JJ, W4CCH 92; HB9J, W1BXC, W3KT, W3ZX, W8AJJ, W8DOD 91; G6MK, G6YR, PA0QZ, W1RY, W8KTW, W9CWW 90; W2GRG, W6ITH, W8CJJ 89; G2DZ, VK6SA, W3A00, W3JM, W5ASG 88; W2BMX, W3EMA, W9AEH 87; W2IOP, W3AIU, W4DMB, W8IQB, W9FLH 86; W6FKZ, W8LAV, ZS2X 85; G6ZO, SM6WL, W3AGV, W3OP, W4CFD, W8BSF, W90VU 84; SPIAR, W1BFT, W6GPP, W9BEZ, W9RBI 83; W2ALO, W8JAH 82; G6XL, W8DAE, W9RCQ 81; W3BVN, W3EPR, W3FLH, W3GEH, W4EQK, W6LDJ, W8BWB, W8DGP 80; LU7AZ, W3GHD, W6MVK, W6TT, W8JFC 79; VE2GA, W4TZ, W1EWD, W8AAT, W8BFG, W8FJN, W8MTY, W9MRW 78; SP1LP, W1ICA, W6AM, W6KUT, W8QDU, W9GMP 77; PA0JMW, W3AYS, W3BSB, W6DTB, W8LZK, ZE1JI 76; D3CSC, W2BJ, W3CKT, W6GK, W9JDP 75. Radiotelephone: W4CYU 82; W2IXY 80; W6ITH 78.

# SIMPSON

INSTRUMENTS THAT STAY ACCURATE



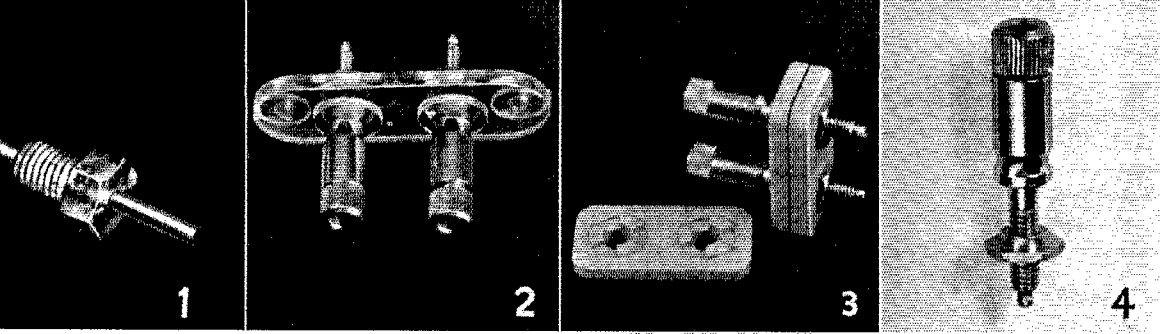

## NEW SMALL PARTS

**ONE** ■ The new Through Point Bushing, of injection-molded Victron, is ideal for a variety of uses, particularly as a bushing or as a stand-off. It is supplied with a .093" conductor molded in, but this can be removed without damaging the material. Losses are very low. Illustration is approximately actual size. The price is only \$.45 Net per box of 12.

**TWO** ■ A Victron terminal strip for high frequency use, originally designed for antenna connections on the One-Ten Receiver. Two Type FWA Binding Posts (Fig. 4) are used. Net Price, insulator only, Type FWB \$.06 Net.

**THREE** ■ Type FWC Insulators are molded of R-39 and mount either FWA Binding Posts or FWE Jacks on  $\frac{3}{4}$ " centers. Serrated bosses allow the thinnest panels to be gripped firmly, yet have ample shoulders. Maximum panel thickness with FWA Binding Posts is  $\frac{1}{4}$ ". Type FWC Insulators, without Jacks or Posts, \$.21 Net per pair. Type FWE Jacks for above, Net Price \$.09 each.

**FOUR** ■ The new FWA Binding Post accepts banana plugs at the top and wires through the hole. Its clamping action is unusually positive, for the husky screw top is shaped down to a small rounded end at the point where it clamps the wire. It is illustrated approximately actual size. Type FWA, Net Price \$.15 each.

**FIVE** ■ The new National Jack, Type GSJ, screws into the top of GS-3, GS-4 and GS-4A Standoff Insulators, as illustrated. It receives banana plugs of standard size, making it a convenient mount for plug-in coils, etc. Net Price, Type GSJ Jack, \$.06 each.

**SIX** ■ This new insulated plug of molded R-39 mounts two banana plugs on  $\frac{3}{4}$ " centers, and may be used with jacks or jack-top binding posts. Leads may be brought out through the top or through the side, and connections are made by binding screws inclosed within the body of the plug. When used with Type FWE Jacks and Type FWC Insulators, all metal parts are safely guarded when plugged in. This assembly, complete with plug, two jacks and two insulators, is known as Type FWD (Net Price \$.96) Type FWF Plug only, Net Price \$.60 each.

**SEVEN** ■ The Type SPG Safety Plate Grip is of molded R-39 and is an important aid to safety when using 866's or other tubes having  $\frac{9}{16}$ " Diameter Caps. The conductor opening is large enough to receive high tension (spark plug) cable, but an insulated bushing is supplied for smaller wire. Type SPG, Net Price \$.21 each.

**EIGHT** ■ A friction drive is now available for use with Type O Dials for fine adjustment. Type ODD Friction Drive (Dial not included), Net Price \$.36.

## BY NATIONAL

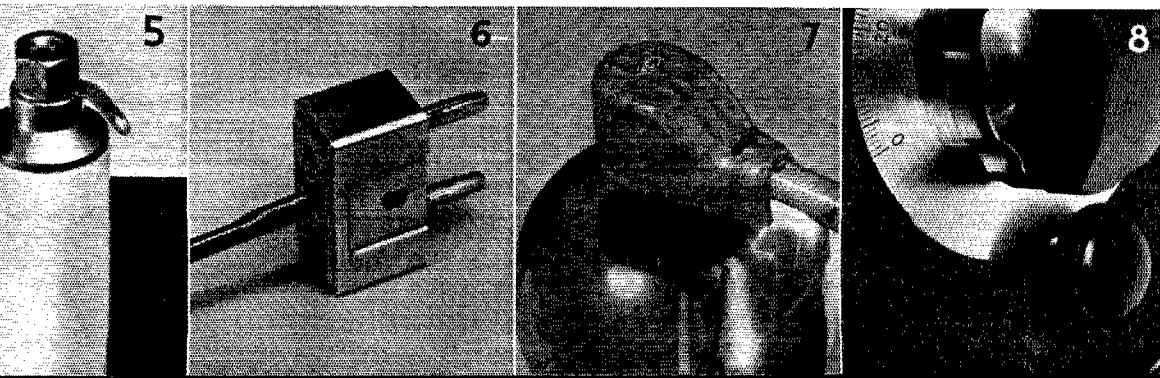

3000 VOLTS A.C. and D.C. Available in the  
**New "PRECISION" Automatic**  
 PUSH-BUTTON A.C.-D.C. MULTI-RANGE TESTER

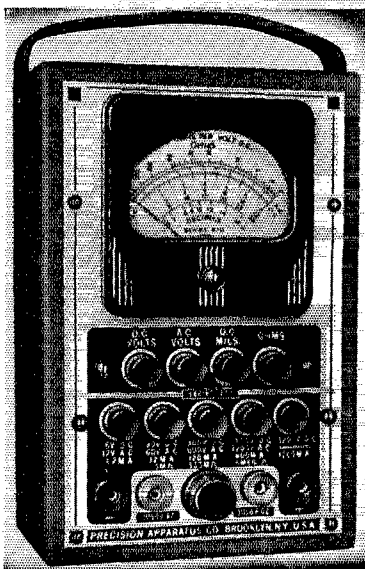

**29 RANGES including a  
 3000 VOLT A.C. — D.C. RANGE  
 SERIES 870**

Precision engineers once again bring you an advanced and highly practical improvement in test equipment. This instrument offers a novel and simplified method of complete push-button circuit and range selection, making available all A.C. and D.C. measurements, except the 3000 volt. A.C.-D.C. range, from only two polarized tip jacks. Usual PRECISION STANDARD OF ACCURACY. Wire wound shunts and matched metallized multipliers are accurate within 1%. Large 3 inch D'Arsonval type meter of 2% accuracy. Housed in walnut finished wood case. Compact size: 7 x 4 1/2 x 3. Net to amateurs, complete with 3 v. battery . . . . . **\$16.95**

**FEATURES**

- \* 29 RANGES . . . COMPACT
  - \* D.C. VOLTAGE RANGES at 1000 ohms per volt: 0 to 6/30/300 600/1200 and 3000 v.
  - \* A.C. VOLTAGE RANGES at 500 ohms per volt: 0-12/60/600 1200 and 3000 volts.
  - \* D.C. CURRENT RANGES: 0-1.2/12/120/600/1200 milliamperes.
  - \* RESISTANCE RANGES: 0-5000 ohms (20 ohms at center of scale) 0-500,000 ohms (powered by self contained battery) 0-5 megohms (powered by external battery).
  - \* DECIBEL RANGES: -10 to +64 DB. ODB (-10 to +16 DB) +14 DB (+4 to +30 DB) +34 DB (+24 to +50 DB) +40 DB (+30 to +56 DB) +48 DB (+38 to +64 DB).
  - \* OUTPUT METER INDICATIONS on Five A.C. voltage ranges: 0 to 12/60/600/1200 and 3000 v. A.C.
  - \* D.C. CURRENT MEASUREMENTS OF LEAKAGE IN ELECTROLYTIC CONDENSERS.
  - \* QUALITATIVE PAPER CONDENSER TESTS.
- SIMPLE TO OPERATE** ● Depress the button to automatically select the TYPE of measurement you desire ● Then depress the button clearly identified with the desired range ● Direct reading on meter. All tests are obtained at only 2 tip jacks (except 3000 volts A.C. and D.C.). The center knob between the jacks is rotated only for zero adjustment when ohmmeter scales are employed.
- SEE this new Series 870 as well as any of the other Twelve Popularly Priced "Precision" test equipment models on display at all the leading radio parts distributors.

**PRECISION**  
**APPARATUS CO.**  
 821 EAST NEW YORK AVENUE  
 BROOKLYN, NEW YORK

**January '39 O.R.S.-O.P.S. Parties**

ALL records were broken at the January get-togethers of O.R.S.-O.P.S. appointees and League officials. In the O.R.S. Party, fourteen operators scored more than ten million points! W3BES was third-time winner with a staggering total; take a look at his score! W1TS also went over the "20" mark.

In the O.P.S. Party, the 10,000 figure was hit for the first time — by W2JZX and W8LUQ, who had a nip and tuck fight for first place. W2JZX has a slight edge with 10,528 against LUQ's 10,237. Three additional scores over 9000 indicate the great success of the party.

The next O.R.S.-O.P.S. Parties will be held April 22nd-23rd.

**Official Relay Station Scores**

Station	Score	Diff. Stns.	Diff. Sects.	Heard	(Watts) Power Input	Operating Time
W3BES	22,753,919	247	60	17	250	20 hrs.
W1TS	20,104,350	228	59	—	350	20 hrs.
W6KFC	17,000,000	—	—	—	—	—
W1JTD	15,022,305	197	53	48	80/130	20 hrs.
W2HMJ	14,056,335	187	56	5	300	18 hrs., 15 mins.
W1EOB	11,859,897	187	52	13	125	18 hrs., 5 mins.
W1UE	11,752,320	180	60	33	110	20 hrs.
W8JTT	11,182,480	166	60	40	200	17 hrs.
W3GZK	11,081,380	181	55	5	—	16 hrs., 53 mins.
W1KQY	10,501,480	180	52	11	200/400	19 hrs., 50 mins.

Station	Score	Stat.	Sect.	Station	Score	Stat.	Sect.
W4AGI	10,414,100	166	57	W5KCC	6,147,600	138	50
W4APU	10,408,177	171	56	VE3EF	5,626,487	124	49
W9LEZ	10,405,180	164	59	W4DWB/A	5,224,254	124	49
W3CHH	10,316,450	183	46	W1IGN	4,187,358	128	39
W2JEB	9,826,824	186	46	W7CZY	4,168,471	93	46
W3GKN	9,032,070	172	50	W8PIH	4,026,207	115	44
W8CMH	8,632,050	158	52	W9TQD	3,648,940	108	48
W3GDI	7,944,150	161	50	W1LAB	3,469,680	122	36
W4NC	—	—	—	W9RQM	3,456,960	109	47
(Several oprs.)	7,380,720	153	48	W1BFT	3,443,360	122	42
W8KIU	—	—	—	W1FSV	3,414,340	115	40
(2CPT, opr.)	7,064,442	147	51	W5FZD	3,300,000	102	48
W8IZS	6,493,284	140	49	W3AOC	3,294,480	106	42
—	—	—	—	W7FFQ	3,082,430	92	39
—	—	—	—	W6LMD	3,049,578	84	42
—	—	—	—	W1ITI	3,018,384	119	34

The score of W1AW, not competitive with any of the above, is recounted for the information of members: W1AW (Geo); 10,913,584; 180; 56; 19; 1000; 18 h.

**Official Phone Station Scores**

Station	Score	QSO's	Sections	Heard	(Watts) Power Input	Operating Time
W2JZX	10,528	64	28	23	700	6 hrs., 30 mins.
W8LUQ	10,237	59	29	29	400	7 hrs.
W2EOA	—	—	—	—	—	—
(2HXQ, opr.)	9,570	58	29	20	250/700	6 hrs., 30 mins.
W4DCC/2	9,308	62	26	24	125	7 hrs., 36 mins.
W2HNP	9,075	61	25	29	450	5 hrs., 46 mins.
W8CGU	8,316	56	27	14	300	7 hrs., 25 mins.
W8ICQ	7,944	61	24	13	135-150	7 hrs., 13 mins.
W9WXL	6,925	41	25	36	200	7 hrs., 47 mins.
W2DC	6,390	53	22	15	450	6 hrs., 15 mins.
W8VZ	6,360	52	20	29	400	7 hrs., 16 mins.

Station	Score	QSO's	Sect.	Station	Score	QSO's	Sect.
W8KNF	6,168	45	24	W8BTP	4,900	37	20
W4CYB	6,118	46	23	W4CVQ	4,769	31	19
W8NNJ	5,712	47	24	W1BNO	4,636	40	19
W5CXH	5,548	40	19	W1DWP	4,275	33	19
W8AQ	5,481	37	21	W8JAH	4,060	29	20
W8PUN	5,208	42	21	W4EM	3,969	35	21
W9TRN	5,104	42	22	VE3KM	3,888	40	18
W8DSJ	4,997	45	19	W9UNS	3,798	35	18

\* On-off times not given.

# Featuring hallicrafters Skyrider 23

★ General Coverage—34 to 54 MC (8.8 to 556 Meters).

## GENERAL COVERAGE

- ★ 8 Band Positions —  
 Band 1 — 11.0 to 34.0 MC  
 Band 2 — 5.2 to 16.5 MC  
 Band 3 — 1.7 to 5.2 MC  
 Band 4 — .54 to 1.7 MC

## BAND SPREAD

- Band 10 — 3.5 to 4.0 MC  
 Band 20 — 7.0 to 7.3 MC  
 Band 40 — 14.0 to 14.4 MC  
 Band 80 — 28.0 to 32.0 MC

- ★ Tube Complement — Total Number of Tubes — 11.  
 1st R.F. — 6SK7 1st Det. — 6SA7 B F O — 6SJ7  
 H. F. Osc — 6SJ7 Amplified AVC — 6B8 Rectifier — 80  
 1st I.F. — 6SK7 2nd Det., 1st Audio — 6SQ7 Noise Limiter — 6N7  
 2nd I.F. — 6SK7 Power Output — 6F6G

- ★ Audio Output — 5 Watts.  
 ★ Temp. Compensated Permeability-Tuned I. F. Trans. Units (455 K.C.)  
 ★ Completely Shielded, Permeability-Tuned Crystal Filter Circuit  
 ★ 6 Position Variable Selectivity Switch  
 ★ Controls { Pitch Control Selectivity Switch Automatic Noise Limiter Switch  
           Tone Control A.F. Gain Crystal Phasing Control  
           Band Switch R.F. Gain Phone Jack  
           Standby Switch Main Tuning Knob  
 ★ S Meter calibrated in "S" units and db's. "Venetian Blind" Tuning Dial.  
 ★ Directly calibrated, Indirectly illuminated, "Venetian Blind" Tuning Dial.  
 ★ Modern ventilation grills.  
 ★ Speaker — P. M. Dynamic in separate cabinet of matching design.  
 ★ Cabinet Finish — Machine Tool Gray, Crystal finish with Gunmetal and chrome finish  
 escutcheon. ★ Cabinet Dimensions — Width — 19", Height — 9 1/4", Depth — 12 1/2".

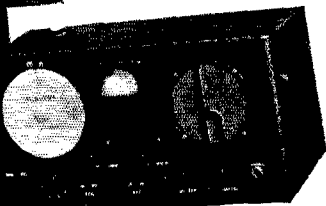

The New  
**SKY BUDDY**  
 10 METER BAND  
 with  
 ELECTRICAL  
 BAND SPREAD  
 Check These  
 Features

**AMATEUR CASH PRICES**  
 Skyrider 23 with crystal, less speaker... \$115.50  
 Skyrider 23 with crystal and speaker... 127.50

**EASY TIME PAYMENT PLAN**

Model	Down Payment	Per Mo. for 6 Mos.	Per Mo. for 12 Mos.
S23 with crystal, less speaker.....	\$23.00	\$16.25	\$8.28
S23 with crystal and speaker.....	25.40	17.95	9.15
S19 Sky Buddy.....	5.50	4.83	—
S20 Sky Champion..	9.50	7.33	—

- 6 Tubes with 8 Tube Performance
- 4 Bands
- Complete Coverage 44 MC to 545 KC
- Separate Band Spread Dial
- Built-in Speaker
- Beat Frequency Oscillator
- Pitch Control
- Send-Receive Switch
- Phone Jack
- Band Switch
- AVC Switch

**HALLICRAFTER SKY CHAMPION**  
 A Proven Performer  
 CASH PRICE..... \$49.50

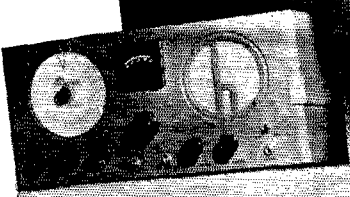

MAIL ORDERS PROMPTLY FILLED  
 ★  
 Write for FREE 72-page Catalog  
 ★  
 BUY ON EASY TERMS

**"The IRADII (O) SHIACIK**  
 46 BRATTLE ST. - BOSTON, MASS. - U.S.A.



Actual Size

## BANTAM JR. SERIES

Available in three types and offering many interesting applications to the experimenter. Wearable hearing aids — Miniature receivers — Remote controls — Microphone pre-amplifiers — Meteorological instruments — Sensitive measuring devices.

### Data Sheets

supplied on request

### Type HY113 Triode

R. F. Oscillator or Detector

Filament voltage.....	1.4 volts
Filament current.....	70 ma.
Plate voltage.....	45 volts
Grid voltage.....	-4.5 volts
Plate current.....	0.4 ma.
Transconductance.....	250 umhos.
Amp. Factor.....	6.3
Plate resistance.....	25,000 ohms

Price \$1.75 Net

### Type HY115 Pentode

High Gain, High Impedance, Audio Voltage Amplifier

Filament voltage.....	1.4 volts
Filament current.....	70 ma.
Plate voltage.....	45 volts
Screen voltage.....	22½ volts
Grid voltage.....	-1½ volts
Av. Plate current.....	0.03 ma.
Av. Screen current.....	0.008 ma.
Av. Amp. Factor.....	300
Transconductance.....	580 umhos.
Plate resistance.....	5.2 megohms

Price \$2.50 Net

### Type HY125 Pentode

A. F. Power Output Amplifier

Filament voltage.....	1.4 volts
Filament current.....	70 ma.
Plate voltage.....	45 volts
Screen voltage.....	45 volts
Grid voltage.....	-3.0 volts
Av. Plate current.....	0.9 ma.
Av. Screen current.....	0.2 ma.
Load impedance.....	50,000 ohms
Power Output.....	11.5 milliwatts

Price \$2.50 Net

## HYTRONIC LABORATORIES

DIVISION OF HYTRON CORPORATION

76 Lafayette Street, Salem, Mass.

## ELECTION NOTICES

To all A. R. R. L. Members residing in the Sections listed below:  
(The list gives the Sections, closing date for receipt of nominating petitions for Section Manager, the name of the present incumbent and the date of expiration of his term of office.) This notice supersedes previous notices.  
In cases where no valid nominating petitions have been received from A. R. R. L. members residing in the different Sections in response to our previous notices, the closing dates for receipt of nominating petitions are set ahead to the dates given herewith. In the absence of nominating petitions from Members of a Section, the incumbent continues to hold his official position and carry on the work of the Section subject, of course, to the filing of proper nominating petitions and the holding of an election by ballot or as may be necessary. Petitions must be in West Hartford on or before noon of the dates specified.

Section	Closing Date	Present SCM	Present Term of Office Ends
Manitoba *	Apr. 3, 1939	A. J. R. Simpson	Feb. 15, 1939
No. New Jersey	Apr. 3, 1939	Fred C. Read	Feb. 15, 1939
Rhode Island	Apr. 3, 1939	Clayton C. Gordon	Apr. 15, 1939
Western Florida	Apr. 3, 1939	Ellis R. Curry	Apr. 15, 1939
Indiana	Apr. 3, 1939	Noble Burkhart	Apr. 15, 1939
Nevada	Apr. 14, 1939	Edward W. Heim	June 14, 1937
Nebraska	Apr. 14, 1939	S. C. Wallace	Aug. 17, 1938
Philippines	Apr. 14, 1939	George L. Rickard	Oct. 15, 1938
San Francisco	May 15, 1939	Alan D. Whittaker, Jr.	May 28, 1939
North Dakota	June 1, 1939	Ernest Bloch	June 14, 1939
Maine	June 1, 1939	Winfield A. Ramsdell	June 7, 1939
No. Minnesota	June 1, 1939	Edwin L. Wicklund	June 15, 1939
Idaho	June 1, 1939	Carl Eichelberger	June 15, 1939
So. New Jersey	June 1, 1939	W. W. Filson	June 15, 1939
No. Texas	June 1, 1939	Lee Hughes	June 15, 1939
Sacramento Valley	June 1, 1939	J. L. C. Buckenham	June 15, 1939
Md.-Del.-D. C.	July 3, 1939	Edgar L. Hudson	July 15, 1939

\* In Canadian Sections nominating petitions for Section Managers must be addressed to Canadian General Manager, Alex Reid, 169 Logan Ave., St. Lambert, Quebec. To be valid such petitions must be filed with him on or before the closing dates named.

1. You are hereby notified that an election for an A. R. R. L. Section Communications Manager for the next two-year term of office is about to be held in each of these Sections in accordance with the provisions of the By-Laws.

2. The elections will take place in the different Sections immediately after the closing date for receipt of nominating petitions as given opposite the different Sections. The ballots mailed from Headquarters will list in alphabetical sequence the names of all eligible candidates nominated for the position by A. R. R. L. members residing in the Sections concerned. Ballots will be mailed to members as of the closing dates specified above, for receipt of nominating petitions.

3. Nominating petitions from the Sections named are hereby solicited. Five or more A. R. R. L. members residing in any Section have the privilege of nominating any member of the League as candidate for Section Manager. The following form for nomination is suggested:

(Place and date)

Communications Manager, A. R. R. L.,  
38 La Salle Road, West Hartford, Conn.

We, the undersigned members of the A. R. R. L. residing in the..... Section of the..... Division hereby nominate..... as candidate for Section Communications Manager for this Section for the next two-year term of office.

(Five or more signatures of A. R. R. L. members are required.) The candidates and five or more signers must be League members in good standing or the petition will be thrown out as invalid. Each candidate must have been a licensed amateur operator for at least two years and similarly, a member of the League for at least one continuous year, immediately prior to his nomination or the petition will likewise be invalidated. The complete name, address, and station call of the candidate should be included. All such petitions must be filed at the headquarters office of the League in West Hartford, Conn., by noon of the closing date given for receipt of nominating petitions. There is no limit to the number of petitions that may be filed, but no members shall sign more than one.

4. Members are urged to take Initiative immediately, filing petitions for the officials for each Section listed above. This is your opportunity to put the man of your choice in office to carry on the work of the organization in your Section.

— F. E. Handy, Communications Manager

## ELECTION RESULTS

Valid petitions nominating a single candidate as Section Manager were filed in a number of Sections, as provided in our Constitution and By-Laws, electing the following officials, the term of office starting on the date given.

Arkansas	H. E. Veltz, W5ABI	Feb. 15, 1939
Vermont	Clifton G. Parker, W1KJG	Feb. 15, 1939
San Joaquin Valley	Edwin A. Andrews, W6KUT	Feb. 15, 1939
North Carolina	W. J. Wortman, W4CYB	Mar. 18, 1939

In the Hawaii Section of the Pacific Division Mr. Francis T. Blatt, K6EJF and Mr. Henry S. Lau, K6GAS, were nominated. Mr. Blatt received 44 votes and Mr. Lau received 35 votes. Mr. Blatt's term of office began February 28, 1939.

These men have made TERMINAL the LEADING HAMRADIO SUPPLY HOUSE in the EAST! Their interest in amateur radio is genuine; you'll find them sincerely friendly, and always at your service.



BILL FILLER, W2AOQ

JACK SIMON



SAM LAINE, W2BKU

FRANK MILLER, W2BUS



PAUL BURKE



HARRY ADELMAN, W2JYV



STANLEY KOJALA



ADOLPH GROSS



# A *Crowning* Achievement

## the hallicrafters SX23

### a *FIRST* at TERMINAL!



The new HALLICRAFTERS SX23 receiver, complete with 11 tubes, crystal and 10" P.M. speaker in deluxe matching cabinet

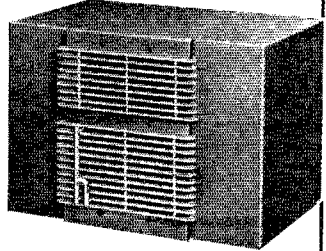

# \$127.50!

We're extending to every radio amateur a cordial invitation to visit either Terminal store in New York City to see and hear the SX23 in action. You'll like the friendly "hamfest" atmosphere that makes each visit to TERMINAL a pleasant one!

All Hallicrafters models are in stock and on demonstration here at our two stores, and they're available on time payments, if you wish.

*We'll gladly forward complete descriptive literature if you just mail us a card.*

# TERMINAL *Radio Corp.*

2 STORES IN NEW YORK CITY  
80 CORTLANDT ST. • 68 WEST 45th ST.

Cable Address: TERMRADIO

# GAMMATRONS

Are easy to  
neutralize

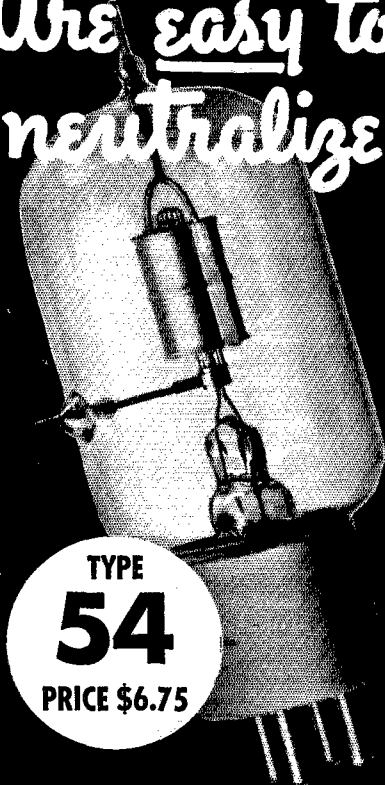

Yes, all GAMMATRONS are easy to neutralize because the scientific design by Heintz and Kaufman engineers provides that GAMMATRONS have very low interelectrode capacities, and the grid and plate leads are short, direct and conveniently located.

This means greater freedom from parasitic oscillations, more efficient high frequency operation, and a better sounding phone job on the air in less time. Write for data.

**HEINTZ AND KAUFMAN**  
SOUTH SAN FRANCISCO CALIFORNIA U.S.A.

## It's not "Masonite" — It's "Presdwood"

(Continued from page 68)

able in black and green coloration in addition to the standard brown. The added cost for the tempered board and for coloring generally runs about a cent and a half per square foot additional for each function. Many other manufacturers buy Masonite Presdwood and sell it as their own. Generally this material is referred to as "Hardboard." Celotex and Johns-Manville are two of the many doing this. The electrical properties of "Tempered Presdwood" or "Tempered Hardboard" are very good. Its insulation properties closely approximate those of hard rubber.

I might mention at this juncture that I am not selling anything but rather have in mind relieving the mental strain on the retail lumber dealer when the ham asks for his panel material. . . .

— Paul Kreitsck, W8QQE

## "QST'S" NEW DRESS

Wolcott, N. Y.

Editor, *QST*:

Please accept my hearty congratulations on the new *QST*. Noticed the difference the instant I removed the wrapper. I like the new arrangement inside the covers. Here's hoping the change in type, etc., will encourage the boys to read it from cover to cover and thereby obtain more lasting benefit therefrom.

— W. C. Pearson, W8COD

LOS ANGELES CALIF

EDITOR, *QST*:

CONGRATULATIONS ON FINE NEW STYLE *QST*  
STOP WONDERFUL IMPROVEMENT SUCH AS THIS  
MAKES AMATEURS PROUD OF MEMBERSHIP

(sig) W6PMV and W6QNV

1501 Broadway, New York City

Editor, *QST*:

The new issue of *QST* looks very pretty. I read it twice; once to learn what was going on in amateur radio, and the second time to admire the typography.

— Robert Hertzberg

97 Horatio St., New York City

Editor, *QST*:

. . . I hope somebody likes the new appearance of *QST*. I don't. Furthermore, I think it's lousy with two esses . . .

— S. P. McMinn, W2WFD

Editors' NOTE. — To many other commentators on *QST*'s modernized format, grateful acknowledgment is made. Apart from styling and appearance, we hope members will find its improved editorial and reading efficiency attractive.

## ABOUT "HQ SALARIES"

932 Wesley Ave., Evanston, Ill.

Editor, *QST*:

. . . I want to comment on K6PTY's letter in January 1939 *QST* regarding headquarters' salaries. It would be nice to reduce the price of *QST* to 15¢ per copy, but for my part I would hate to see it done by cutting salaries. The number and average wage of the clerical employees must be fixed by the volume of work they handle and the prevailing wages in the community. To cut wages would mean that either the quality or quantity of the administrative and experimental personnel would have to be reduced. I don't believe many of us would be in favor of such a move. . . .

— Miles H. Lusher, W9ZWF

822 Schumacher, Ontario, Canada

Editor, *QST*:

When one gets to be an old man of 23, with eight years of hamming behind him, a placid content creeps into one's

★ ★ ★ ★ ★ ★ ★ ★ Skyrider 23 ★ ★ ★ ★ ★ ★ ★ ★

# SEE THE NEW SKYRIDER 23



## with DRIFT COMPENSATION and WIDE RANGE SELECTIVITY

We are proud to offer the new SKYRIDER 23 as the closest approach to the ideal communications receiver amateurs have ever seen. It has features that are so modern that they could not have been included a year ago, such as the new Temperature Compensated I F Transformers offering practical frequency stability and eliminating drift. And this is but one of the truly outstanding features of the new SKYRIDER 23. It has everything amateurs have wanted and needed in a communications receiver. Step into any Radio Electric Service store. See the New Skyrider 23, or write for complete information today.

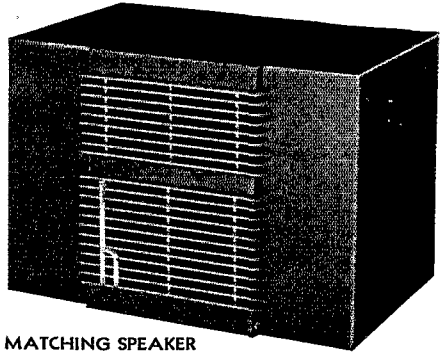

MATCHING SPEAKER

- Complete Coverage 34 to .54 MC (8.8 to 556 Meters)
- Band Spread Positions for 10, 20, 40 and 80 Meter Bands
- Wide Range Variable Selectivity
- Noise Limiter
- "S" Meter
- "Venetian Blind" Tuning Dial
- 8 Position Band Switch
- 11 Tubes
- Permeability-Tuned Crystal Filter Circuit
- Drift Compensation

# RADIO ELECTRIC SERVICE CO.



N. W. Corner 7th & Arch St. Philadelphia, Pennsylvania

1042 Hamilton St., Allentown, Pennsylvania ■ 5133 Market St., Philadelphia, Pennsylvania ■ 811 Federal St., Camden, New Jersey  
 3145 N. Broad St., Philadelphia, Pennsylvania ■ 219 W. Eighth St., Wilmington, Delaware ■ 9 North Second St., Easton, Pennsylvania

★ ★ ★ ★ ★ ★ ★ ★ the hallicrafters inc. ★ ★ ★ ★ ★ ★ ★ ★

# ALL in ONE



The 10-T Combination

This self-contained transmitter-receiver consists of a tunable 4 tube superheterodyne receiver covering a frequency range of 550-4500 kcs. (which includes standard broadcast band) and a 10 watt crystal controlled telephone transmitter with four frequency operation in the range of 1500-4500 kcs. Built to the exacting standards of all Harvey equipment this unit is simple to operate — just hook on a battery and antenna, and you're on the air. This versatile combination can be used as a portable unit in the field — in any small space in your operating room — on your boat for Marine Telephone Service — or on expeditions where AC current is not available. Examine the new 10-T — you'll agree that for value, utility and performance this set *has no equal*. Write to **HARVEY RADIO LABORATORIES, INC., 25 Thorndike Street, Cambridge, Mass.**, for complete details. Export: 25 Warren Street, New York City. Cable: "Simontrice."



soul along with an aversion to taking part in the sordid brawls of the outside world. But Mr. Grimes' letter in the Jan. Correspondence Section rouses me from lethargy to this extent:

If Mr. Grimes had a brain in his head he would know that the large increase in the amateur ranks from year to year would require more Hq. employees. If he read his *QST* now and then instead of just looking at the Station Activities to see his call letters in print, he would see that A.R.R.L. Hq. actually has enlarged its staff from time to time (and incidentally moved into larger offices); also, that *QST* has grown larger to the extent of some 20 or 25 pages during the last two or three years.

Finally, if he had an ounce of business sense or a grain of appreciation for a good job well done, he would not have the temerity to crab at paying a mere \$2.50 for a year of *QST*. Personally, I often wonder how the A.R.R.L. can do it; and if I were told that you were a millionaire and Rod, Jim and George bought new cars every month (like the West Coast crew tried to make out three years ago), I am afraid I would still hand out my two bucks and four bits every year. . .

— Fred C. Allen, *VESSA*

E. Falls Church, Va.

Editor, *QST*:

. . . I hope you folks that run League business and operations up there aren't Scrooges, and that your employees are amply compensated. I believe most of the members will be with me in this. Underpaid employees are not part of the American system.

About the subscription fee, I think *QST* is more than worth that fee itself. The League membership seems to be more or less thrown in with it. I believe *QST* to be the best periodical of its kind published, and I wouldn't like to see its style changed just to lower the selling price. . .

Clement M. Goo On, *W3EVT*

## A.A.R.S. Activities

(Continued from page 58)

operator for copying slowly and breaking the sender, but the O.M.'s carpet gets "stood on" when the ops guess (and guess *wrongly*). You are not in the lower caste just because you can't read code at high speed — just think of the millions of people who can't read the stuff at all!

\* \* \*

The following cryptogram is designed for interested cipher busters and solutions will be acknowledged if sent to the Liaison Officer, A.A.R.S., 3441 Munitions Bldg., Washington, D. C.: **EEERV SEORP TERRD OIEND ECSCU ORNTO EARKT ENODU TERRD OIPNE OODHT ENNEO**

## U.S.N.R. Notes

(Continued from page 58)

be advanced to radioman third class as soon as found qualified for that rate. It is interesting to note that about 50% of the applicants for the N.C.R. are rejected for physical defects.

Recently the rating of signalmen was added to the N.C.R. and many young men who have tried to be radio operators, but have been unable to succeed, are getting into the visual communication branch.

Men living in the Fourth Naval District and interested in joining the N.C.R. either as radiomen or as signalmen should communicate with the Commander, Naval Communication Reserve, Building No. 1, Navy Yard, Philadelphia, Pa. The Fourth District comprises the states of Pennsylvania, Delaware and the southern half of New Jersey.



GET "OUT FROM UNDER" THE QRM!

with  
**SIGNAL SHIFTER**

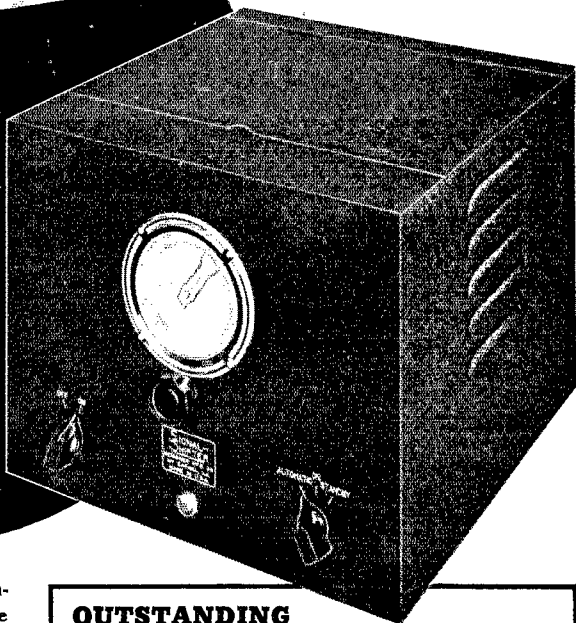

**B**OY, oh boy! Have we been receiving congratulatory letters on the efficiency of the MEISSNER Signal Shifter getting hams "out from under" the QRM!

And no wonder! Its unbelievable frequency stability—superior to that of many crystals—is obtained by the use of special Hi C electron coupled oscillator circuit and dual buffer arrangement to isolate the load.

As the Signal Shifter is variable—you can cover any amateur band right from your operating position. And for remote control—there's plenty of excitation available. Comes to you completely assembled, wired, adjusted and ready for use (except for tubes). Ask your Parts Jobber for a demonstration of this remarkable instrument. For further information—write Dept. Q-4, Mt. Carmel, Ill. Ask for FREE 44-page Catalog!

**OUTSTANDING EXCLUSIVE FEATURES!**

- ★ Accurate and Stable Calibration! (Dial calibrated 0-100 with vernier pointer).
- ★ Can be Link-Coupled or Capacity-Coupled to next stage.
- ★ 5 Sets of Plug-in Coils Cover 10, 20, 40, 80 and 160 Meter Bands!
- ★ Readily Adaptable to ANY transmitter.
- ★ Output Constant Over Entire Range of Each Band.
- ★ Power Output More Than Sufficient to Eliminate the Use of One or Two Doubler Stages.
- ★ Tubes Remain at Constant Operating Temperature Whether Signal Shifter is in Use or "Standing-by."

**NEW! 120-PAGE INSTRUCTION BOOK!**

Easy-to-understand theory and technical data, graphs, charts, pictorial and schematic diagrams, alignment data, construction data and operating instructions for 20 new Meissner receiver kits. Also information on adapters and converters. At your Parts Jobber—or order direct, addressing Dept. Q-4. Price 50c.



NET PRICE  
 ONLY \$39<sup>95</sup>

*Meissner*

MT. CARMEL, ILLINOIS

"A FAMOUS NAME FOR TWO DECADES"

"... now, with the  
Verti-Flex, practically  
every call I make re-  
sults in an answer!"

Theodore P. Lewenberg,  
W1HZU  
Brookline, Mass.

## Here's Why

The Verti-Flex Transmitting-Receiving GIANT ANTENNA is a self-supporting vertical radiator, towering 34 feet into the air, requiring no guy wires or overhead insulators. Micrometer fit joints between sections giving perfect electrical connection and great mechanical strength. Construction allows sway without buckling but prevents rotary oscillation of pole. Light-weight—built of aluminum alloy. Strong ceramic insulator base—almost a foot in diameter. Extra large iron base mounting—either bracket or type illustrated. Verti-Flex GIANT ANTENNAS have withstood 45 m.p.h. gales without damage. Amateurs' special price, complete, \$21.95.

ASK YOUR PARTS JOBBER

*Verti-flex*  
GIANT ANTENNA

**VERTI-FLEX DIVISION**  
2138 N. Racine Ave., Chicago



## A Frequency-Checking Superhet

(Continued from page 41)

signal and to freedom from drift during the stand-by periods. The explanation is simple. The coupling between the cathode coil and the grid coil is adjusted so that stable operation will be obtained in the key-down position, but with the 500-ohm resistor in the circuit sufficient loss is introduced to prevent oscillation. When this occurs, the grid-leak bias disappears; however, the cathode resistor furnishes bias at this time, so that the load drawn by the tube is nearly constant. As the heating of its elements also remains nearly constant, drift and chirp are reduced greatly. The VR150 regulator on the screen voltage helps materially in keeping the oscillator on frequency.

When the e.c.o. is adjusted, it is possible, by tuning both dials, to tune in the reliable broadcast stations that are going to furnish checking frequencies. These checking frequencies can then be roughly logged on the h.f.-oscillator dial. The key can then be closed and  $SW_1$  turned to the transmitting position. By tuning  $C_{11}$ , which is another below-chassis adjustment, maximum output from the 6L6 can be secured. The two circuits track quite well throughout the band, thus giving fairly constant output. The 6L6 should be neutralized to give best results with minimum reaction on the oscillator.

To work close to the band edges, it is necessary to use broadcast stations that give band-edge check points. When they are available, the procedure to get check points within the limits described is as follows: First set the b.f.o. to zero beat with the "i.f. determining" broadcast station. When this is accomplished, the setting of the b.f.o. should be left strictly alone. It is a simple matter to recheck the accuracy of the b.f.o. setting at any time by tuning the left-hand t.r.f. dial back to the "determining" station and checking against magic eye No. 1 without disturbing the setting of the e.c.o. Then if the t.r.f. dial is tuned to the proper station for the band-edge check, and the e.c.o. is also tuned to zero beat with this same station both audibly, and visibly on magic eye No. 2, the setting is precise within the limits previously indicated. By maintaining an audible beat on the "low capacity side" of zero beat when operating on the low-frequency edge of any band, and vice versa on the high-frequency edges, the operator is doubly safe.

We have then a number of accurately-known frequencies on which to operate, plus the possibility of operating on all frequencies in between. Band-edge operators have a means of working very close to the edge without danger and in compliance with the F.C.C. rule. The e.c.o. circuit alone has much to recommend it to those interested in such a unit. And the cost compares very favorably with less flexible systems, if complete costs are considered.

# Taylor HEAVY CUSTOM BUILT DUTY Tubes

## IT'S HERE!!!

### NEW HEAVY DUTY SHIELDED 866

### HALF WAVE MERCURY VAPOR RECTIFIER **\$1.50**



Actual Size  
New shielded 866

**PEAK INVERSE 10,000 VOLTS MAX.**

The new, fully shielded, Taylor 866, sets a new standard of rectifier tube performance by delivering all the characteristics of an 866-A in an 866. Here is tube value that will set the pace for 1939. We are again passing on to radio amateurs a price advantage, by calling this new rectifier an 866 instead of an 866-A. Every dollar we save you allows you to buy better gear, and keep your station up to the minute. Instead of selling this new tube for \$2.50 and calling it an 866-A, we are selling it to you for \$1.50—giving you the performance of an 866-A in an 866. Use this new mercury vapor rectifier in any power supply that calls for an 866 or 866-A. Ask your favorite parts distributor.

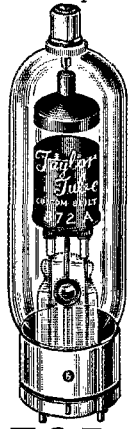

**872-A.** A heavy duty rectifier that has already scored a big hit in scores of large stations. Carbon anode and shield. Will handle 3,500 Volts D.C. at 2.5 amps. ....\$10.50

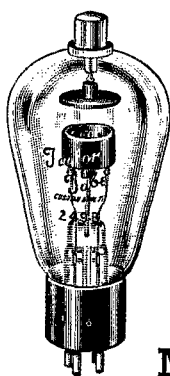

**249-B.** Used widely in commercial transmitters. Carbon anode and shield. For power supplies up to 3,300 Volts D.C. at 1.25 amps....\$5.00



**866 Jr.** Popular as well as efficient. Used in thousands of rigs. Half Wave delivers up to 250 MA at 1000 Volts D. C. ....\$1.00

### MERCURY VAPOR RECTIFIERS FOR EVERY PURPOSE

*"More Watts Per Dollar"*  
TAYLOR TUBES, INC., 2341 WABANSIA AVE., CHICAGO, ILLINOIS

# For DX!

## THE AMATEUR RADIO MAP OF THE WORLD

★ On a sheet of heavy map paper 30 x 40 inches Rand McNally, world's premier map-makers, have — to A.R.R.L. specifications — imprinted in six colors and black every single bit of map information useful to the radio amateur.

The special modified equidistant azimuthal projection permits great circle distance measurements in miles or kilometers accurate to better than 2%. Local time in all parts of the world is shown, as well as Greenwich corrections. The official I.A.R.U. WAC continental sub-divisions are given. Principal cities of the world are shown, including, in the U. S., all district inspection offices and examining points.

Perhaps most useful of all is a list of countries of the world, arranged on a basis of geographical and political divisions — clearly shown by color breakdown and the detailed reference index. There are 230 countries shown, 180 prefixes (the prefixes in large open red lettering that you can't miss). More than that, all known national districts and other sub-divisions are shown.

Entirely new in conception and design, large enough to be *useful*, complete in every detail — here is the map radio amateurs have been waiting for these many years. Make a place for it on your wall now — it'll be the most *interesting* object in the shack.

PRICE **\$1.25**  
POSTPAID

**American  
Radio Relay League**  
West Hartford, Connecticut

## I.A.R.U. News

(Continued from page 59)

Luxembourg: W. Berger, LX1AB, 20, Rue Louvigny.

U.S.A., Ninth District: Alva A. Smith, W9DMA, 238 East Main St., Caledonia, Minn.

### NEW ZEALAND

It is pleasing to note from *Break-In* that the N.Z.A.R.T. have assurance from official quarters that there is no intention, at present, of utilizing the 7200-7300-ke. band of frequencies for broadcasting channels.

### HERE AND THERE

Lt. ANDREW C. WOODS, EI5L, is the Hon. Secretary of the I.R.T.S. . . . Total number of licenses issued to amateurs in Ireland is 46. . . . J2JJ is providing the Asia contact from a number of recent American WAC'ers. . . . D.A.S.D. has about 5000 members, of whom 500 hold transmitting licenses. Although German amateurs declare that American apparatus and parts would be of value to their experimental work, they cannot obtain import permits for them. . . . Mr. R. T. Stanton, ZL3AZ, is the new communications supervisor for the N.Z.A.R.T. This Association, by the way, is considering installing a full-time paid executive officer at its headquarters.

### GREECE

REGARDING the report that Greece might soon issue amateur licenses, we find there is great doubt that any further licenses will be issued. The apparent reason is that in view of the general press censorship in Greece, the licensing of amateurs would establish means for the dissemination of information now banned by the government. SV1KE holds the only such license, but cooperates with government agencies to such an extent that he partakes of a semi-official status.

### 0Q5ZZ Calling "CQ USA"

(Continued from page 29)

Operation will be mainly in the 14-Mc. amateur band, although the 3.9-Mc. band will be relied upon for relaying information to the second trailer during separation in the field. A three-wavelength "V" beam will be used as the main 14-Mc. antenna system. In confined locations, half-wave doublet radiators will be used on both 14 and 3.9 Mc. to supplant the beam. The radiator systems are fed by low-impedance cable to provide an easy means of installation and coupling to the final amplifier. When the trailer is on the move between locations the antennas are wound on wooden reels and stored away. Portable masts are also part of the antenna equipment, for use in open country where natural supports are not available.

Further details as to schedules and times of transmission from the expedition will be given in future issues of *QST*.

# PRIZES *for Photographs*



## *Enter* **ASTATIC PICTURE CONTEST**

TO become better acquainted with its great family of Astatic Crystal Microphone fans in all parts of the world, Astatic Microphone Laboratory, Inc. has planned this Picture Contest. If you are proud of your Astatic equipment and installations, send us photographs showing Astatic Microphones or Pickups in actual use and you will be eligible for one of the 11 cash prizes to be awarded for photographs accepted. No expensive photographs are required. Any camera picture, small or large, will do, providing it is sharp and distinct. Short wave amateurs, especially, are urged to take part in this contest.

### **\$100 IN PRIZE MONEY**

One grand prize of \$50.00 will be awarded to the Astatic fan submitting what the judges (Officials of the Astatic Microphone Laboratory, Inc.) consider the best picture. Ten other awards of \$5.00 each will be made to winning contestants. No fee is required to enter. Perhaps, even now, you have a picture you can send. If not, we urge that you get busy with your camera or have a friend make a snapshot of you and your outfit within the next day or so. Don't delay.

#### **Contest Will Close August 1**

Photographs will be accepted until midnight, August 1, 1939, when the contest closes. Awards will be made August 15. In addition to the \$100.00 offered in cash prizes, \$1.00 additional will be given for any other photographs accepted for publication.



### **CONTEST RULES**

1. Any person, excepting an employee of Astatic Microphone Laboratory, Inc., is eligible to enter this contest.
2. All photographs must include operator or other individual and must show Astatic Microphones or Pickups in actual use or installations.
3. All photographs received will become the property of Astatic Microphone Laboratory, Inc.
4. Contestants must agree to the release of accepted photographs for advertising or trade purposes.
5. Photographs may be any size, large or small, providing they are clear and distinct.
6. Contest closes August 1 and awards will be made August 15.
7. All photographs must bear the name and address of the sender and station call letters, if any.
8. Entries must be mailed direct to Astatic Microphone Laboratory, Inc., Youngstown, Ohio.

**ASTATIC MICROPHONE LABORATORY, INC.**

*Pioneer Manufacturers of Quality Crystal Devices*

**YOUNGSTOWN, OHIO**

*Licensed Under Brush Development Co. Patents. Astatic Patents Pending*

# 2MN'S SPY-RING DISCOVERY!

"... the most valuable service ever rendered by a radio operator to his country. . . ."

## THAT'S WHAT THE PAPERS SAID!

Packed into a single page of this story is the fascinating work done by 2MN in 1915 when the Telefunken station at Sayville was broadcasting reports of shipping movements to German submarines! "This story" is the Story of Amateur Radio — starting 'way before the war, telling what happened to hams in the war, and giving the whole A.R.R.L. story. It's TWO HUNDRED METERS DOWN, the thrill-packed book by Clint DeSoto.

**BETTER READ IT!** Maybe you can get someone with a Kleinschmidt to stick it on the air for you — but our guess is that you'll want to turn the pages faster than twenty-five per! **BETTER BUY IT!**

Flossy cloth binding for two silver dollars. Or wrap a three-cent stamp around a dollar bill for the paper bound edition. Order TWO HUNDRED METERS AND DOWN from the

**AMERICAN  
RADIO RELAY LEAGUE**  
West Hartford, Connecticut

## How Would You Do It?

(Continued from page 62)

Tie substantial guying ropes or wires to the top of the ladder, raise it into position as nearly vertical as possible and fasten these ladder guys to substantial anchorages. Before you start work at the top of the ladder, be sure to equip yourself with a safety belt of some sort. This will not only keep you from falling off the ladder but will permit you to work with both hands if necessary.

If the ladder is available, the scheme shown in Fig. 2B is made easier since the length of the sticks may be made much shorter. This makes for easier handling of the sticks and lessens the danger of collapse. Since the sticks are shorter, they may be made stronger for the same weight and WIKFN suggests that a cap of soldered or welded wire, as shown in Fig. 2D might be easier to boost over the end of the pole than the rings or loops mentioned previously. This idea prevents any possibility of the pulley sliding down the pole even if the mast is not fitted with guy wires.

One or two of the contestants have been ambitious enough to suggest that a new halyard may be threaded through the old pulley. This doesn't seem so impossible as it might at first thought. One idea which seems entirely feasible is to fasten a series of light wood strips together, as shown in Fig. 2E, which will reach from the top of the ladder to the pulley. A line of staples is arranged along the length of the strips, placing them 8 to 12 inches apart. Stiff wire, such as No. 14 house wire or metal clothesline is then passed through the staples with six inches or so protruding from the top end. If desired, the end of the stick might be fitted with a guide made from copper tubing. The wire, whose total length should be somewhat more than twice the length of the stick is prevented from dropping by a temporary tape binding at the bottom of the stick. With this arrangement, it should not be too difficult to fish the end of the wire through the pulley opening from the top of a ladder. If necessary, two or three stout cord lines may be attached to the top of the stick and held steady by helpers. As soon as the top end of the wire has been passed through the pulley opening, the binding at the bottom of the stick may be taken off and the wire pushed upwards until it falls over by its own weight and starts descending. Continued pushing will bring the end of the wire down within reach where the new halyard may be spliced to it and hauled back through the pulley. W7BIA recommends  $\frac{1}{8}$ -inch diameter iron pipe as a substitute for the stapled sticks and suggests that it might be possible to do the job from the ground with 50 or 60 feet of pipe which may be raised section by section. Cord bracing may be used to prevent buckling of the pipe.

If you wish to mix a little sport with your work of replacing the lost halyard, you might try the scheme suggested by W8AMS and shown in Fig. 3. The idea is to choose a windy day and fly a kite in the vicinity of the mast. As soon as the kite is flying well, the string is maneuvered around the top of the mast. It is now necessary to wait until

*Only*  
**GRAPHITE  
ANODES**

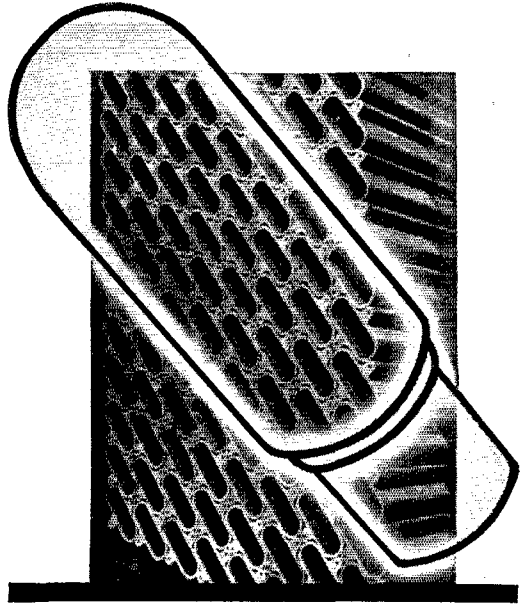

*are:* **VOLTAGE PROOF • HEAT PROOF  
WARP PROOF • GAS ABSORBING**

Graphite Anodes, as supplied by SPEER CARBON COMPANY to leading tube manufacturers have ALL these properties. No other anode material now in use has these characteristics. For tubes with anodes you cannot damage by overloads . . . that will not fuse, blow out or soften . . . that cannot warp . . . that emit no gas and absorb gases given off by other tube elements . . . use tubes with SPEER Graphite Anodes. Why be satisfied with less? Write for Anode Booklet No. 80 and list of tube makers using SPEER Graphite Anodes.

**SPEER CARBON COMPANY**

ST. MARY'S



PA.

Chicago

Cleveland

Detroit

Milwaukee

New York

Pittsburgh

**SPEER GRAPHITE ANODES**

# OHMITE

## R.F. PLATE CHOKES



Widely-used, small, single-layer-wound 5 meter high frequency choke. Avoids fundamental or harmonic resonance in the amateur bands. Low

power factor Steatite core. Moisture proof, 1000 MA rating. Available also in lug-type for 10, 20, 40, 80, and 160 meter bands. Write for Bulletin 106.

## New Type P300 PARASITIC SUPPRESSOR

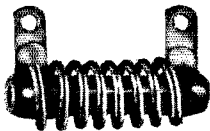

A new, convenient, compact Parasitic Suppressor to prevent u.h.f. parasitic oscillations. Non-inductive vitreous-enamelled resistor combined with a choke into one integral unit. Small and light. Only  $\frac{3}{8}$ " diameter,  $1\frac{1}{2}$ " long overall. Very easy to mount.

Ask Your Jobber or Write for Catalog 17

**OHMITE MANUFACTURING CO.**  
4863 Flounoy Street, Chicago, Ill., U. S. A.

Be Right with **OHMITE**  
RHEOSTATS • RESISTORS • TAP SWITCHES.

the wind dies down or the kite takes a nose dive unless you want to fly another kite to snag the first one and bring it down by force. A rope is then spliced to the kite string and pulled up around the mast top replacing the string. A pulley, fitted with a halyard long enough to reach between the top of the mast and ground is tied to the first rope and hoisted to the top of the mast and fastened temporarily by walking around the mast several times. The second halyard is then used to hoist the arrangement shown in the detail drawing. The outer ring is a barrel hoop or something similar. The central ring or rectangle is shaped to fit loosely over the top of the mast and is suspended from the outer hoop by a network of strings. The central ring carrying the new pulley and halyard for the antenna is maneuvered over the top of the mast and dropped over it. The string network may be broken loose by anchoring the antenna halyard and working on the auxiliary line. If you find that your string is too tough, a few days out in the weather should weaken it.

The awarding of prizes this time was quite a problem in itself. Several duplicate solutions were received. After carefully weighing the pros and cons for each particular solution, papers were compared for completeness in detail and the following were finally declared the winners:

First Prize: Dan O'Brien, W7GPY, Portland, Ore.

Second Prize: Arnold J. Morrison, W7BIA, Bothell, Wash.

We wish also to thank the following for their contributions: W1ALJ, 1BDV, 1JFX, 1KOS, 1KRK, 2ISJ, 2KKG, 3CSY, 3FWL, 3VX, 4FPE, 4UE, 5CQL, 6NLZ, 7BJS, 7DVY, 7EXB, 80MM, 8PUN, 8QBW, 8RJK, 9GOG, 9JN, 9MCS, 9NVV, 9NZS, 9PAH, 9PTI, 9VFM, 9VIR, K6PTY, VE1DQ, 3GZ, 5DG, A. R. Anderson, R. Bennett, E. J. Drumm, H. M. Haslett, L. Jones, Jr., W. Kurysch, R. Murray, F. H. Travers and F. Wessely.

Rules under which the contest is conducted are as follows:

1. Solutions must be mailed to reach West Hartford before the 5th of the publication month following that of the issue in which the problem has appeared. (For instance, solutions of problem given in the April issue must arrive at QST before May 5th.) They must be addressed to the Problem Contest Editor, QST, West Hartford, Conn.

2. Manuscripts must not be longer than 1000 words, written in ink or typewritten, with double spacing, on one side of the sheet. Diagrams must be neat and legible.

3. All solutions submitted become the property of QST, available for publication in the magazine.

4. The editors of QST will serve as judges. Their decision will be final.

Prizes of \$5 worth of A.R.R.L. station supplies or publications will be given to the author of the solution considered best each month, \$2.50 worth of supplies to the author of the solution adjudged second best. The winners are requested to specify the supplies or publications preferred.

## RADIO ENGINEERING



RCA Institutes offer an intensive course of high standard embracing all phases of Radio and Television. Practical training with modern equipment at New York and Chicago schools. Also specialized courses and Home Study Courses under "No obligation" plan.

Illustrated Catalog on request

**RCA INSTITUTES, INC.** Dept. ST-39

A Radio Corporation of America Service

75 Varick St., New York 1154 Merchandise Mart, Chicago

## FASTEST WAY TO LEARN CODE

Easy, Fascinating — LEARN BY EAR to be a GOOD OP.

The New All Electric Master-Telex Code Teaching Machine is exactly what thousands are looking for. No experience needed. Excellent for beginners — steps up WPM for ALL Ops. There is no guesswork with Master Telex, because it records your sending in visible dots and dashes. You SEE and HEAR exactly how you are making your signals. You learn code the way you'll be using it — by SOUND. That's why schools teaching code use TELEPLEX. Complete course included at no extra charge. Used by many schools and several governments for teaching code. Low cost, easy terms. MONEY BACK GUARANTEE. Send now for booklet Q-4, no obligation. Post card will do.



The "Ham" Special TELEPLEX CO.

Standard Telex — a highly efficient code teacher using heavy specially prepared waxed paper tape, having two rows of perforations. Write for Free folder QT-4 67-68 PARK PLACE NEW YORK, N. Y.

In Canada, write CANADIAN ELECTRONIC INST., TORONTO, ONT.



*Announcing...*

# a new **Jensen** AUDITORIUM SPEAKER . . .

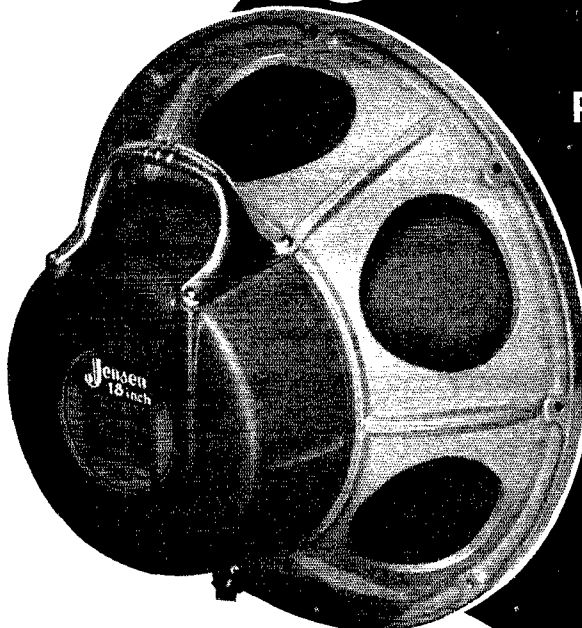

# 18<sup>INCH</sup> PERMANENT MAGNET

Efficiency and Power Handling Capacity fully equal to the well known 18-inch Jensen Field Coil Speaker.

*A distinguished  
new Member of  
JENSEN'S  
Auditorium Family*

## FOUR TYPES DIFFERING ONLY IN RESPONSE CHARACTERISTICS . . .

- **Type PMJ-18** For voice and music reproduction.
- **Type PHJ-18** High Fidelity for improved quality where input is free from high frequency distortion.
- **Type PVJ-18** Where reproduction of voice is the principal requirement.
- **Type PLJ-18** For reproduction of low frequency in combination systems.

For Theatres, Public Address, Phonographers or any application where high speaker efficiency, superlative quality and exceptional power handling capacity are requisites, these new 18-inch Auditorium Speakers are unrivalled. And, of course no field coil power is required.

Jensen quality is not confined

to products such as these new 18-inch speakers. The most complete line of speakers known are trademarked **Jensen** and every one from the small 5-inch size up are built to meet the high standard of Jensen quality. There is no price premium for quality of this kind; why not insist on it — always.

Literature, Prices and Technical Data on Request

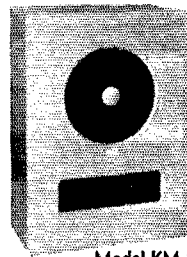

Model KM-18

## PERI-DYNAMIC REPRODUCERS with Bass Reflex ARE NOW AVAILABLE WITH 18" PERMANENT MAGNET SPEAKERS

Jensen Peri-dynamic Reproducers with Bass Reflex are offered with 8, 10, 12, 15 and 18-inch speakers and some with dual speakers. No baffle required. Enclosures are shipped in knock-down kit form for convenience and low cost. Write for Peri-dynamic Catalog.

**JENSEN RADIO MANUFACTURING COMPANY**

6601 SOUTH LARAMIE AVENUE

CHICAGO, ILLINOIS

*"The Name Insures the Quality"*

CORNELL-DUBILIER

Start Hit ★ ★ ★ TYPE TJU OF THE MONTH



TYPE TJU X-MITTING CAPACITORS

- 1 - Dykanol (Chlorinated Diphenyl) Impregnated and Filled - Long life; small size; lower power factor; non-inflammable.
2 - Hi-Purity Aluminum Foil - Lower R.F. resistance; light weight.
3 - Hi-Purity Multi-Laminated Kraft Tissue - Higher voltage breakdown; minimum leakage; high I.R.
4 - Hermetically Sealed - Not affected by moisture, time or temperature up to 200° F.
5 - Universal, Steel Mounting Strap - Allows mounting unit in any position.

For a complete listing of the entire CORNELL-DUBILIER line, send for Catalog No. 161, FREE ON REQUEST.

MICA • PAPER • DYKANOL • WET AND DRY ELECTROLYTICS



CORNELL-DUBILIER ELECTRIC CORPORATION

1013 Hamilton Blvd., So. Plainfield, N.J.

Cable Address: "CORDU"

RADIO

ENGINEERING, broadcasting, aviation and police radio, servicing, marine telegraphy and telephony, Morse telegraphy and railway accounting taught thoroughly. 48 weeks' engineering course, equivalent to three years of college radio work. School established 1874. All expenses low. Catalog free.

DODGE'S INSTITUTE, Day Street, Valparaiso, Indiana

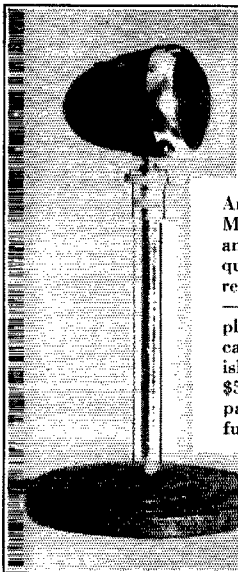

Model B

TIBBETTS MONOBAR-CRYSTAL MICROPHONE

An advanced type of Crystal Microphone having fine quality and a high voltage output, requiring less amplifier. Order direct and save nearly five dollars - money back guarantee. Complete with base and 7 feet of cable - black and chrome finish. \$10.45 cash - \$11.45, \$5.45 with order and promise to pay \$1.00 monthly until paid in full.

TIBBETTS LABORATORIES Camden, Maine



ALWAYS BE CAREFUL



- (A) Kill all transmitter circuits completely before touching anything behind the panel.
(B) Never wear 'phones while working on the transmitter.
(C) Never pull test arcs from transmitter tank circuits.
(D) Don't shoot trouble in a transmitter when tired or sleepy.
(E) When working on the transmitter, avoid bodily contact with metal racks or frames, radiators, damp floors or other grounded objects.
(F) Keep one hand in your pocket.
(G) Develop your own safety technique. Take time to be careful.

★ ★ ★

Death Is Permanent!

Strays

W2LQC and a friend were disappointed to find, upon investigation, that the owner of the New York car bearing the license-plate number CQ-20 was not a ham.

SS Contest Results

(Continued from page 57)

Butte Amateur Radio Club (Montana), 27,941 W7FRS; Hamfesters Radio Club, Inc. (Chicago), 27,121, VE4UN; Providence Radio Association (R. I.), 19,915, W1KYK; Ozark Empire Radio Club (Springfield, Mo.), 19,793, W9QMD; Lane Tech Ham Club (Chicago), 16,236, W9WQB.

SS Briefs

If you ever feel pity for the lad who checks contest scores, shed a tear for Joe Moskey, W1JMY, who did the lion's share of SS verification work. . . Joe had a queer gleam in his eyes as he tackled some of the logs, such as the one from the fellow who wrote, "Enclosed find 8 feet and 6 inches of SS log," but we have heard of no fatalities. . . . To keep a perfect record of time on the air, W8OXO hooked up a Telechron self-starting clock to filament circuit of transmitter. . . . The W6LVB/W6LDJ combination in Nevada certainly boosted stock in the W.A.S. award, as did the contest in general. . . . Several operators worked all states. . . . W8FYH figures he spent half of his time repeating his QTH - Cheektowaga, N. Y.! . . . Said W7GPP, "Twas my first SS but not my last. May the best guy win." - It was good to see him win for Oregon. . . . If the contest did nothing else, it proved that those "rubber crystals" sure have snap! . . . One-band hams were few and far between in the SS but one-band operation brought honors to several. For example, W7GPP won using 7 Mc, only; VE2EP led Quebec and

# Utah 5, 10, 20 METER KIT

—WITH A COMPLETE BAND SWITCHING SYSTEM

Now ONLY  
**\$69.75**  
LESS CRYSTAL, METERS  
AND TUBES

This new transmitter kit, originated and engineered by UTAH has won nationwide enthusiastic approval. Real power is provided on 5, 10 or 20 meters without resorting to plug-in coils or pruning of condenser capacities. Two separate class "C" Amplifier stages are used with a special low loss ceramic selector switch, which automatically selects the proper tube sequence.

All parts are of the highest grade — RF sockets, condensers, etc., have Steatite insulation. A complete high fidelity speech amplifier and modulator with provision for both high and low gain inputs furnishes up to 35 watts audio and very low distortion. Power supply is self contained.

A dual plate and filament supply is furnished and is contained on the bottom chassis to provide well regulated current to the RF unit.

Metering facilities for accurate adjustment, tone control, professionally styled chassis and cabinet, modern dial plates, etc., complete the unit. Furnished in platinum grey wrinkle.

Write for schematic diagram and complete information

## Utah

### FEATURES

- 1. Complete Band-Switching of circuits "Not coils."
- 2. Dual independent Amplifier stages.
- 3. Provision for two crystals.
- 4. 45 watts input C.W. or phone.
- 5. High gain speech amplifier — modulator.
- 6. Two complete power supplies with three filters.
- 7. Steatite insulation — air wound coils.

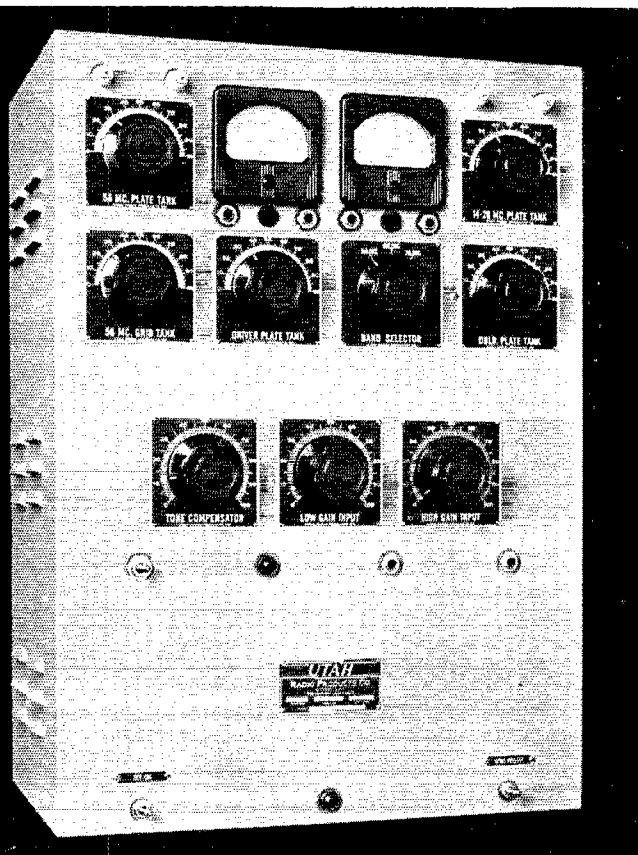

## UTAH RADIO PRODUCTS COMPANY

CHICAGO, ILLINOIS • CABLE: UTARADIO, CHICAGO

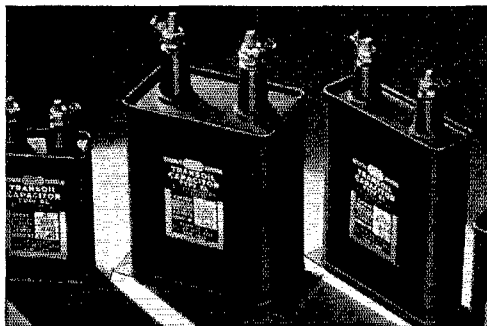

## TRANSOIL

for transmitting

**HIGHEST QUALITY  
OIL CAPACITORS**

Write for Catalog 2-X  
listing complete lines

TRANSOIL—SOLAREX—TRANSMICA

SOLAR  
MFG. CORP.



599 BROADWAY  
NEW YORK CITY

## BRAZILIAN QUARTZ CRYSTAL

Largest and most varied stock of Brazilian quartz crystals in the United States. Finest quality suitable for manufacturing piezoelectric crystals, lenses, and prisms. Shipments received regularly from our Brazilian Branch. Also in stock tourmalines for making crystals to control the higher frequencies and quartz for fusing purposes.

## BRAZILIAN TRADING CO., INC.

377 Fourth Ave., New York City

Murray Hill 4-2891

Enjoy Sending at Its Easiest and Best  
with the Great New Easy-Action

## VIBROPLEX No. 6 Semi-Automatic Key

Japanned Base \$17

Nickel-Plated Base \$19

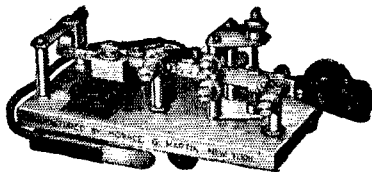

Enjoy the treat of a finer, smoother, more efficient bug than most operators have

## JUNIOR Only \$12.50

Slightly smaller base but in all other details similar to the improved model shown in catalog. All standard features. A low priced key with world-famous Vibroplex quality.

ever owned. It thrills you with its strong, clear signal, machine speed and ease of operation. Its free easy-action eliminates tiring arm work and enables you to enjoy sending at its easiest and best. Place your order NOW! Money order or registered mail. Liberal allowance on old Vibroplex. Write for catalog.



The BUG trade mark identifies the Genuine Vibroplex.

THE VIBROPLEX CO., INC., 832 Broadway, New York, N. Y.

all of Canada using but one band—14 Mc.; W6QEU did a fine job and won for San Joaquin Valley using 1.75-Mc. 'phone only; W4BQE took South Carolina 'phone honors with 14-Mc. operation; VE4SR did likewise for Manitoba. . . . W3EEW claims the best single-band score—46,183, all 7 Mc. . . . Two participants have the distinction of sending no CQ's during the contest—W8KAU and W8NUG. . . . W3BES writes, "SS participation was so widespread that you either SS'ed or else. The 3.5-Mc. band again showed off its superior operators; average 17 QSO's per hour on that band. Think, other things being equal, 100 watts with e.c.o. better than 1 kw. with crystal. Know several fellows in my club who started the contest greenhorn operators but ended up veterans." . . . We noticed several YL's and XYL's among the participants; Lillian Ryan, VE3HE, 26,123 points; Dot Schwerdtfeger, W1IGN, 22,100; Mary LeVan, W3FXZ, 16,313; Dot Evans, W1FTJ, 15,161; Letha Allendorf, W9OUD, 13,500; Gladys Nichols, W8SJF, 10,560; and Frances Rice, W3AKB, 2340. . . . Wonder how many called them "OM." . . . Your contest reporter lost a 4-bit bet with his office co-worker, By Goodman, W1JPE, who claimed that JPE's score of 25,110 in 19 hours would be higher than that of any other operator working an equal number of hours; By was right. . . . "Our club activity was somewhat better in the contest this year due to having made it an intra-club contest, with the gang divided into two groups and the losers throwing a dinner for the rest"—Starved Rock Radio Club. . . . W4COB is waiting for the list of scores so he can collect on several bets he had

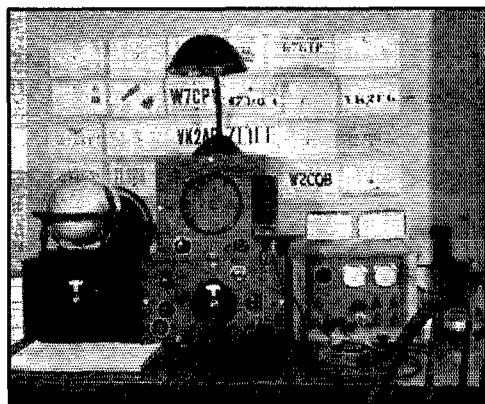

W7FLT Control Position

Dan Fulton, W7FLT, Mackenzie, Mont., won the 'phone award for that Section with a score of 13,020. On the table is an SW3, which acts as front end of superhet; lower center box contains i.f. amplifier and high-frequency oscillator. Upper box contains speaker, power supply and audio amplifier. Right-hand box carries send-receive switch, transmitter power switches, mike and key jacks, a.c. ammeter and a.c. voltmeter. Transmitter, not shown in photo, uses 6V6 crystal oscillator, 6N7 doubler, 807 and 35T final, with crystal switching and coil switching in low-power stages. Located on a ranch 30 miles from town and commercial a.c. current, W7FLT produces his own juice with Dodge generator rewound for 115 volts a.c., driven by Briggs and Stratton gasoline engine.

# New 4 Band

## EXCITER • AMPLIFIER

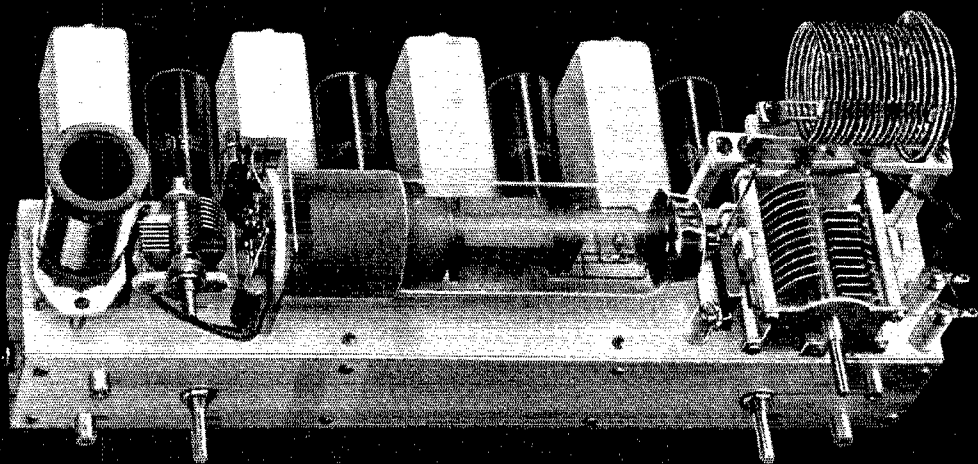

## FOUNDATION • UNIT

THE "ED-4" is the latest Hammarlund transmitting foundation unit. This is a complete 100 watt transmitter measuring only 17 x 8 x 9 $\frac{1}{4}$  inches and capable of four band operation with an 80-meter crystal. There are four 6L6 frequency multipliers in the exciter portion. Band switching is accomplished with a single 4-point switch. Another 4-point switch serves for metering each of the four stages. This exciter is flexible, fool-proof, and economical to build. The amplifier mounted on top of the exciter is an RK-47 (any similar tube can be used) and provides plenty of output for the ham who is interested in medium power. For high power it is recommended that this unit be

used to drive the "PA-500" described in last month's ad. The "ED-4" is available with ready-wound exciter coils. This entire unit can be assembled and wired in a single evening. Write for new 1939 catalog containing complete information.

### SEND COUPON FOR DETAILS

HAMMARLUND MFG. CO., INC.  
424-438 W. 33rd St., N. Y. City

Q-4-39

Please send 1939 catalog

Name .....

Address .....

City ..... State .....

Canadian Office: 41 West Avenue,  
No., Hamilton, Ont.



# HAMMARLUND



# Recommended

**FOR EFFICIENCY ... EASE OF CONTROL ... ALL 'ROUND DEPENDABILITY! ... AIR INDUCTORS ARE FIRST CHOICE AGAIN!**

In QST last month, Hammarlund announced their new PA-500 Foundation Unit ... specified B & W TYPE TVL Variable Link coils in the plate circuit and TYPE BL Fixed Link coils in the grid circuit.

The reason? ... because exhaustive tests proved conclusively that AIR INDUCTORS assured more efficient operation at *less cost* than anything else on the market!

That's why we say: *You'll never know what maximum efficiency means until you try AIR INDUCTORS!* Why not find out — today? See your jobber, or write for details about the B & W line!

**BARKER & WILLIAMSON**

Radio Manufacturing Engineers • ADDMORE, PENNSYLVANIA

## SICKLES COILS

SECURE A COPY OF OUR NO. 939 CATALOG FROM YOUR JOBBER

F. W. SICKLES COMPANY

300 Main Street

Springfield, Mass.

## PRECISION CRYSTALS

Highest quality crystals carefully prepared for frequency stability and maximum output — rigidly tested to assure you of dependable operation. Be sure of your transmitter frequency — use

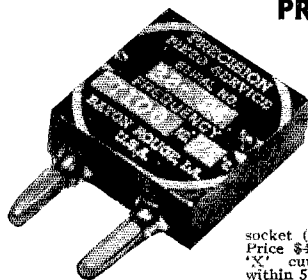

### PRECISION CRYSTALS

Low frequency drift unit supplied within 5 Kc. of your specified frequency in the 40, 80 or 160 meter bands calibrated to within .03%. Supplied in holder as illustrated to plug into G.R. type jacks or in round holder to plug into a tube socket (See Jan. issue QST).

Price \$4.50. Highest quality 'X' cut crystals supplied within 5 Kc. of your specified frequency in the 40, 80 or 160 meter bands and calibrated to within .03% supplied mounted. Price \$4.00. Please state if holder as illustrated or round holder for tube socket is wanted.

Precision crystals for commercial requirements quoted on at your request. Now in our tenth year of business.

**PRECISION PIEZO SERVICE**

427 Asia Street

Baton Rouge, La.

with the operators of W4EQK. . . . Lesson learned by hundreds: The great value and importance of break-in operation. . . . One of the best low power records of the contest was made by W9FUH, Colorado 'phone winner, who worked 112 stations in 56 sections using not over 33 watts input. . . . On c.w. W8IZS is the Western Pennsylvania winner, running only 14 watts to a 6L6G final; he worked 212 stations in 51 sections. . . . W9JID, located in a 22-foot house trailer at Champlin, Minn., used a single 6L6 oscillator with 10 watts input. He worked 181 stations in 46 sections and totalled 20,585 points. . . . Our vote for the "most frank contestant" goes to the fellow who reported, "I had the necessary equipment with which to make a good score. If there had been a good op at the key instead of a tin-eared punk, the layout here might have gone to town." . . . Lucky VE5VO; on 1.75 and 3.9-Mc. 'phone he had the use of the aerial at the broadcast station where his rig is located. . . . W6KFC was among those to work all states; he worked them all at least twice, with the exception of Nev., New Mex., S. C. and Vt. . . . Despite what SS participation may have led you to believe, it is not true that all W3's are in Philadelphia. Heavy club activity may account for the abundance of stations in that area. . . . A word from the Frankford Radio Club regarding contest procedure: "In contests most all members sweep the 3.5-Mc. band first, creeping in a few kilocycles from the edge once in a while to snag 'em. When the edges get dull the middle is worked. Then it's up to 7 Mc. and the same story. Then back again to 3.5. This, of course, applies to the national SS, ORS, ARRL, W/VE competitions. During the DX contest the members are usually more individualistic and prefer to follow their own schemes according to experience. Some use *jiling systems* to expedite contest work." . . . It is said that the real sport in any sort of competition comes

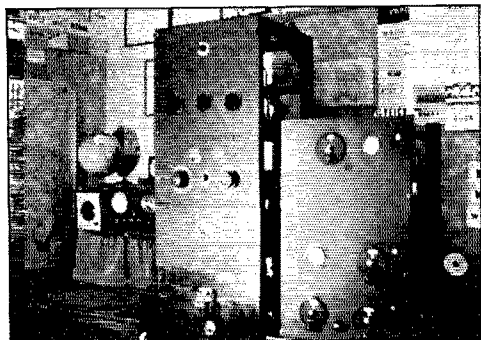

VE2EP, St. Lambert, Quebec

Winner in the Quebec Section, VE2EP is also highest Canadian scorer (46,963), edging out VE3GT for this honor by 643 points! At the left of the Sky Chief receiver is 28-Mc. converter. Frequency meter, monitor and control switches are under the receiver shelf, hidden by curtain. Large rack contains 6N7G crystal oscillator-doubler, 6L6G buffer, parallel 808's final. In small rack: All speech equipment including power supplies for same. During the SS only the 6N7G-6L6G combination was used, with 289 contacts in 65 sections on 14 Mc.

# PORTABLE OPERATION



This Power Supply Unit Makes  
Howard Models  
430 and 438\*  
ALL-PURPOSE  
RECEIVERS

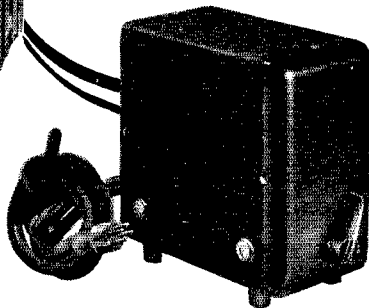

Model  
610 D.C.  
Power  
Supply  
for 6-V.  
Storage  
Battery  
Operation

**Howard Model 430**  
Communication Receiver for operation  
on 110-V. A.C. or 6-V. STORAGE BATTERY  
Amateur Net Price, Complete.....\$42.45

The investment now provides you with a communication receiver that you can use at home in your shack on 110-V. A.C. . . . or that you can use on 6-V. storage battery operation for portable or emergency use; on your summer vacation; camping, marine or pleasure boat use. Model 430 above makes a dandy mobile receiver for the popular 10-meter band. Ideal for trailer installations.

The compact size and light weight of Howard Models 430 and 438 makes them easy to handle for portable operation. The same standard of performance is achieved on 6-V. (D.C.) operation as when used on 110-V. A.C. Meticulous engineering of the 430 and 438 insures the all-around ham of the greatest degree of utility and convenience. For example, to change these receivers from 110-V. A.C. to 6-V. D.C., all that is necessary is to pull out A.C. plug, put in the D.C. plug from the power supply unit and connect terminals to storage battery.

For the most per dollar in Communication Receivers, insist on HOWARD

\*Model 438, 4 Bands, 8 Tubes, Built-in Speaker, Complete with 6-V. Power Supply Unit (but less crystal), Amateur Net.....\$62.45  
Crystal, Net.....\$10.00

Pacific Coast and Export Prices Slightly Higher. Available for Long Wave, 25 Cycle, or special line voltage at additional cost.

*Synchronous Vibrator Type . . . Output 300 V. at 60 mills. Shielded cable with locking type 4-prong plug. Switch for disconnecting filaments and high voltage supply from receiver. Power Supply units available for all owners of Howard Models 430 and 438. Net . . . \$12.50*

**FREE . . . Technical Information . . . Just Send in Coupon**

**HOWARD RADIO COMPANY**  
1731-35 W. Belmont Ave., Chicago, Ill.

Please send me technical data on Model 610  
Power Supply and Portable Operation of

Model 430     Model 438

Name \_\_\_\_\_

Address \_\_\_\_\_

City \_\_\_\_\_ State \_\_\_\_\_

**HOWARD RADIO CO.**

1731 West Belmont Ave., Chicago, Illinois

*America's Oldest Radio Manufacturer*

# FOR REAL CODE SPEED WRITE CANDLER

When you've seemed to reach the limit of your speed — when further practice doesn't seem to bring progress — then see Candler! In a few weeks time you'll be sending and receiving code as easily as you speak and read the written word — and you'll double the fun you're now having on the air.

It's easy to learn code the Candler way. You are taught the correct fundamentals, to start with, you learn sound consciousness, and get the proper mental training.

Soon you'll be sending with a fist you'll be proud of, and reading fast code without strain or conscious effort.

Let Candler help you with your code! It's not expensive — and you'll get twice the pleasure out of your rig. Write Candler for the FREE "Book of Facts." It tells all about the Candler System, and you will read how it has helped others, beginners and advanced operators alike.



## CANDLER SYSTEM CO.

Box 331, Dept. Q-4, Asheville, No. Carolina, U.S.A.

British Address: Rm. 56, Craven House,  
Kingsway, London, W.C.2

## ONAN ELECTRIC PLANTS

Supply the "JUICE"  
WHEN POWER LINES FAIL  
OVER 40 MODELS — 350 TO 50,000 WATTS

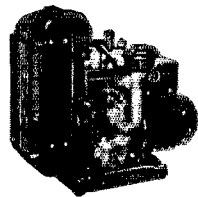

COMPLETE — READY TO RUN  
HUNDREDS OF ONAN ELECTRIC PLANTS serve Amateur and Commercial operators. When Power Lines fail and Communication is needed most, they supply Power for Lights and Radios — Save Property and even Lives.

Portable — Dependable — Economical  
Thousands in use in all parts of the World. Highest Quality Materials — Modern Design. 110 and 220 Volt A.C. — 12, 32 and 110 Volt D.C. and Dual Voltage Generators. Manual, Self-Starting and Full Automatic Starting Types. Write for Details.

D. W. ONAN & SONS, 343 Royalston Av., Minneapolis, Minn.

## LEARN RADIO — TELEVISION —

500 Licensed graduates placed in past 7 years in shipping, broadcasting, aviation, police, etc.; we also teach radio servicing and repairing; new beginners class now forming, day or eve.; 52-page catalog free; one of the oldest, largest and best equipped schools.

### MASS. RADIO SCHOOL

18 Boylston Street, Boston

G. R. Entwistle, Pres.  
Established 1899

R. F. Trop, Treas.  
Hancock 8184

not from winning but from doing. This seems particularly true in the SS judging from the number of comments along the line, "Win or Lose, I sure had a swell time." That's the true SS spirit. If you win, fine; if not, you take steps to improve both your equipment and operating technique in order to do better next time — and that's just what many of the boys are doing in preparation for the '39 encounter. From all the threats we are hearing we judge it will be too good to miss! So long until CQ SS.

*The complete list of individual scores by Sections will be published next month.*

## A "Double-Barrelled" Antenna

(Continued from page 28)

which, in turn, was bolted to the gable end of the house. The whole array was guyed back and front by only two guys, fastened at the top of the A frame. For turning the antenna, light cotton cords were tied about half-way out on the cane poles and brought down through screw-eyes to a convenient point. This arrangement, even on a one-story house, gives a total height of over 35 feet, all of which is used, since there is no sag in the antenna proper.

This layout has been found very satisfactory here and at W5EGQ, in the five months or more that it has been in service. The rotation, although limited, has been found very worth while, especially on 10 meters. Of course it is not as permanent an installation as might be built, but it has weathered several high winds and storms with no ill effects. The total cost of mast, supports, antenna, stub, and transmission line was under \$5, and you can't get very far on self-supporting towers and tubular antenna elements with that kind of money.

### Performance

When the antenna was first installed, the line was carefully checked for standing waves. No indication of any was found on either frequency, and it was also found that a 600-ohm resistor could be substituted for the line at the antenna relay with no change in loading on either band. Field strength tests were made from a distance of about four miles, readings being taken on the "S" meter of a high-quality receiver. Rotating the antenna from "broad-side" to "end-on" caused a drop of 18 db on 14 Mc. and 24 db on 28 Mc., indicating that there is a minimum of radiation from the feed line.

This antenna feed system has materially increased performance and flexibility here at W5FDQ, and similar systems have been installed at W5EGQ, W5ERS and W5FFW, all with favorable results.

No, we haven't figured out how to use a reflector or director in conjunction with the antenna. Perhaps some of you birds who know something about antennas will come to our rescue.



# WANT SOME DOPE ON TRANSMITTERS?

## INDEX

Transmitters:	
Antenna Coupling.....	179, 302-305, 310
Band-Switching.....	199
Bias Supplies.....	171, 354-355
Blocking and By-Pass Condensers.....	149-150
Cathode Bias.....	148
Center-Tap.....	149
Chokes, R.F.....	150
Constructional:	
Exciters or Low-Power Transmitters:	
15-Watt Output 6L6G Oscillator.....	179-180
25-Watt Output 6L6-6L6 Transmitter.....	181-182
35-Watt Output 6L6-807 Transmitter.....	182-184
40-Watt Output Band-Switching Ex- citer.....	199-202
75-Watt Output 3-Stage Transmitter.....	184-187
125-Watt Output 6L6-RK47/814.....	187-189
150-Watt Output Gang-Tuned Trans- mitter.....	205-208
Power Amplifiers:	
200-Watt Input 1-Tube Amplifier.....	189-191
400-Watt Input Push-Pull Amplifier.....	193-195
450-Watt Input Band-Switching Ampli- fier.....	202-205
750-Watt Input Push-Pull Amplifier.....	195-197
750-Watt Input 1-Tube Amplifier.....	191-192
1-Kilowatt Input Push-Pull Amplifier.....	197-199
Crystal Control.....	154-158
Crystals, Cutting and Grinding.....	152-153
Crystals, Mounting.....	154
Efficiency.....	170-171
Electron-Coupled Circuit.....	151-152
Excitation.....	169-170
Exciters.....	177
Filament Center-Tap.....	149
Frequency Multipliers.....	145, 174-176
Frequency Stability.....	151
Grid Bias.....	147-148, 171
Grid Neutralization.....	162
Grounds.....	178
Harmonic Generation.....	166
Harmonic Suppression.....	208
Hartley Circuit.....	151
Interstage Coupling.....	159-161
L-C Ratios.....	166
Link Coupling.....	44, 150, 161
Load Impedance.....	165
Metering.....	177-178
Neutralizing.....	161-163, 173
Oscillator Circuits.....	145, 150-152, 154-158
Parallel Feed.....	147
Parallel Operation.....	158
Parasitic Oscillations.....	176
Pentode Crystal Oscillators.....	155-156
"Phone (see "Radiotelephony")	
Plate Neutralization.....	161-162
Portable (see "Portable")	
Power Amplifiers.....	145, 159-174
Power Supply (see "Power Supply")	
Push-Pull Operation.....	158, 192
Rack Construction.....	87-89
Screen-Grid Amplifiers.....	163-164
Self-Controlled Oscillator Circuits.....	150-152
Series Feed.....	147
Tank Circuits.....	145-147, 165-169, 208
Tetrode Crystal Oscillators.....	155-156
Triode Crystal Oscillators.....	154-155
Tri-Tet Circuit.....	156-157
Tubes.....	62, 177
Tubes (Tables of Characteristics).....	75-82
Tuned Grid-Tuned Plate Circuit.....	153-151
Tuning.....	156, 157, 172-174
Ultra-High Frequency (see "Ultra-High Fre- quency")	
Voltage-Dropping Resistors.....	148-149

# GET THE HANDBOOK

1939 Edition

tells the things which are needed for a comprehensive understanding of Amateur Radio. From the story of how Amateur Radio started through an outline of its wide scope of the present — from suggestions on how to learn the code through explanations of traffic handling procedure and good operating practices — from electrical and radio fundamentals through the design, construction, and operation of amateur equipment — this book covers the subject thoroughly. It includes the latest and the best information on everything in Amateur Radio.

**American Radio Relay League, Inc.**  
West Hartford, Connecticut, U. S. A.

Gentlemen:

Please send THE RADIO AMATEUR'S HANDBOOK to .....

.....

- Enclosed find \$1.00 continental U.S.A.  
 Enclosed find \$1.25 elsewhere  
 Send C.O.D.

(Spanish Edition — \$1.50)

# Station Activities



## WEST GULF DIVISION

**NORTHERN TEXAS** — SCM, Lee Hughes, W5DXA — EOE reports T.L. "M" working fine. GTL is gaining in traffic. DNE has been in hospital, but going strong now. ECE is building "Stancor 500." HTH is new ham in Childress. EAV is rebuilding. HFN is active in A.A.R.S. HIP now has 6FC6, 807, HK24, PP HK54's, 600 watts. SP has been appointed Emergency Coördinator for Abilene and FEG for Wichita Falls. All amateurs in these towns are requested to register equipment, working hours, telephone, etc., with these two stations.

Traffic: W5EOE 661 FRE 509 AUL 155 DXA 134 BKH 130 CDU 90 GTL 52 DNE 49 GJW 29 EZY 26 AZB 4.

**OKLAHOMA** — SCM, Carter L. Simpson, W5CEZ — DTU purchased a 101X receiver. EIO made visit at shack of the S.C.M. GVV has a pair of RK-11's in final. EGP is always rounding up a recruit for the Okla. Net. DAK is beginning plans for new rig. FRB helped his brother get a ticket. "Ed," Chief Opr. at YJ, met with minor accident, and the doc had to button up his scalp. GAQ has new e.c.o. CEB moved to new QTH. GZR is down to a single 6L6 osc. GZU is temporarily located in Drumright. The Enid Amateur Radio Club station call is HTK. CVO announces arrival of a strong second YL Harmonic. Congrats. The Tulsa Amateur Radio Club announces plans for state convention early in June. Start saving your nickels. There is a crying need for Official Observers. In 50 minutes' time this office logged and identified eight stations off frequency between 7400 and 8000 kc., due to 2nd or 3rd harmonics. Let's have some applicants for O.O. appointments.

Traffic: W5CEZ 637 (WLJC 88) (HEBC 77) GFT 179 (WLJE 20) FSK 168 FOM 151 DTU 73 EIO-GVV 48 EGP 46 (WLJL 5) DAK 45 FOJ 43 FRP/FRW 42 FRB 41 EMD 32 YJ 25 (WLJO 8) GAQ 23 GFH 19 CEB 17 GZR-GZU 4.

**SOUTHERN TEXAS** — SCM, Dave H. Calk, W5BHO — Notice the totals of our traffic handlers this month! Congrats to OW, FDR and MN on B.P.L. ratings. FJM runs 300 watts to 211 final on 7 and 14 Mc. EWZ reports the Rio Grande Valley hams organizing a club. FJX is prospective O.P.S. GST is working out nicely on all bands. EBN is ship operator out of Port Arthur. DSH is heard on 28-Mc. 'phone. FNH received 89 from VU on 14-Mc. 'phone. HDY increased power. HNB keeps daily schedule with his brother, 9AHY. DIG keeps weekly Gulf Coast Storm Network schedules. HRH, BTK and CDD are building. ZG is preparing to build a rig around modern tubes. Active on 7 Mc.: HAS, FYP, BEH and OV.

Traffic: W5OW 2198 FDR 1666 MN 654 EWZ 104 FZD 64 DDJ 62 FJM 52 HGG 41 BEF 17.

**NEW MEXICO** — SCM, Joseph M. Eldott, W5CGJ — GSD is organizing High School Radio Club in Roswell. ZM has an automatic tape sender. ZA is doing fine with 28 Mc. in his car. CGJ has a pair of T55's on 28-Mc. 'phone and a T-40 on 14- and 7-Mc. c.w.

Traffic: W5ENI 65 ZM 47 (WLJG 15) ZU 35 HJF 23.

## MARITIME DIVISION

**MARITIME** — SCM, A. M. Crowell, VE1DQ — R.M.: Wm. MacLean, VE1EY. In the future MK will transmit the O.P. on 3690 kc. each Mon., Tues., Fri. and Sat. at 7:30 p.m. A.S.T. HJ operated MK during O.R.S. party. BB is on 3.5 Mc. with portable at Richibucto. CP is now on; QTH — Sydney. HK delivered a most interesting talk and gave a demonstration on 112-Mc. operation at H.A.R.C. meeting. FO is going to rebuild final. GR plans higher power. HV is new Halifax call. AY is active in Bedford. FQ has tubing ready for new signal squitter. GH is now located in Charlottetown. KB has new rig on 14-Mc. 'phone. OM has been recommended for O.R.S. OB gets good results from T20. OO is on 3558 kc. AY is putting good signal into the States. NK is rebuilding using T40. OM gets FB reports around the Maritimes with 6L6G crystal osc. OE is building 1.8-Mc. 'phone rig. NV is newcomer. NW is using pair of '46's. KJ is rebuilding again for higher efficiency. LE visited KJ. The gang will be glad to hear GQ is OK again after an appendix operation. LI has daily schedules with MJ on 1.9 Mc. and reports FF and FS new stations on this band. EV

has been pinch-hitting for LP in the Net. CX is getting fired up for 28 Mc. DC operates on 28 Mc. every Sunday afternoon. IL visited some of the Fredericton boys. IJ is preparing for comm. ticket. ND is putting up doublet for 7 Mc. IP is working on new rig. LW is working out well on 3.9-Mc. 'phone. JG is experimenting on 56 Mc. GS has been getting out nicely on 7 Mc. OP is new ham in Moncton. The M.A.R.C. dedicated the new club transmitter (using 42-802-T55-pair '52's) . . . input 450 watts on 3.5, 7 and 14 Mc. IO will be on from new QTH. RC is in line for O.R.S. KL has been giving 3.9-Mc. 'phone a whirl. MQ is on 1.75-Mc. c.w. and 3.9-Mc. 'phone.

Traffic: VE1MK 74 EV 35 EY 23 KL 41 LO 32 LP 16.

## ONTARIO DIVISION

**ONTARIO** — SCM, Fred H. B. Saxon, VE3SG — Ass't SCM — Dr. Donald R. Gunn, VE3EF. AJB is new O.B.S. in Ottawa; schedule: Wed., 6:30 p.m., 3576-kc. c.w.; Sun., 2:00 p.m., 3829-kc. 'phone. AMJ is new O.B.S. in St. Thomas. OJ is Emergency Coördinator for Hamilton, and all members in that district are urged to get in touch with him and sign up in the Emergency Corps. ST and ABZ are new O.P.S. AJB in Ottawa gives Code practice each Wed., 7:00 p.m., commencing with 'phone announcement on 3829 kc. and then code on 3750 kc. at speed of 5 to 10 words per minute, followed by reading of text transmitted on 3829-kc. 'phone. DA follows same routine on Thurs. at 7:00 p.m., but uses 3869 kc. for entire period. FF in New Toronto broadcasts code practice on 3792 kc., Wed. and Fri., at 7:00 a.m., commencing with one or two eight-minute transmissions of cypher, followed by plain English text with punctuation for remainder of the half hour. Speed ranges from 15 to 25 words per minute. JO moved from Bracebridge to Toronto. ST has been having fun with an 8-watt miniature station (15 x 7 x 7 inches, complete). ACV says the gang at Ft. William is showing interest in 56 Mc. with UA, AOD and ACV active and DX, GS and FQ rebuilding. 56-Mc. 'phone rigs installed at Fort William District Ski Meet gave excellent communication between starting line and judges' stand. There is an active Trans-Canada 'Phone Net meeting each Wed. morning at 11:30. Regular members include VO2N (the only YL in the group), VE1FQ, 1DQ, 1CK, 2CW, 3ADB, 4SS, 4JV and 5AEJ. In addition, 2CP, 3ST, 3AHA, 4JJ and 9HP join in from time to time. The gang will welcome anybody who is interested. They will be found between 14,115 and 14,140 kc. The Inter-City A.R.C. in St. Thomas now has 45 members. DD formerly of St. Thomas is now R.L. in Sioux Lookout. KC, UC and GC visited the Montreal Radio Club. VT is working nice DX. The I.A.R.A. has taken up prone-pressure method of resuscitation as a regular club activity; at each meeting a special period is set aside for instruction and practice. AOR reports for Hamilton, which has an active and enthusiastic club. MZ gets out well with HK54 final. RV is new Hamilton amateur. AMI has pair of 807 Jrs. in final. ANA is now YR. DC works out well on 3.9-Mc. 'phone. GZ has daily schedule with SF, who works into both Maple Leaf and Beaver Net. ALT had a 100% QSO with K4EZR, a 13-year-old YL in Porto Rico. AGN and AWW are on the staff of CJKL. AFR has pair of 808's plate modulated by a pair of the same. AGG gets FB reports with grid-modulated '03A on 3.9- and 14-Mc. 'phone. VN gets rather nice results on 14 Mc. AWB and AUW are doing nicely with 6L6G finals. OD is pounding brass on 7 Mc. AGM on 14 Mc. is trying hard for W.A.C. ATX has been working some DX on 1.75-Mc. 'phone. AMM is new Perth ham. PE rebuilt rig with 6L6-6L6G-P.P. 809's modulated with 57-56-'45-P.P. '46's. When the 110th City of Toronto Squadron of the R.C.A.F. went to Port Carling for the annual winter training period, 9AL, 3AGI, LJ and LW hooked up to provide communication between the training base and the Toronto HQ. 9AL acted as the home station for the net, which was very successful.

Traffic: VE3SG 145 EF 108 SF 73 AJB 65 WK 50 QK 34 EH 23 VD 31 OI 28 CP 20 GZ-WX-ALL 18 ATF-BB 14 DU 12 JO 11 AON-ST 7 PL 5 ABZ 3. VE9AL 42.

## QUEBEC DIVISION

**QUEBEC** — SCM, Lindsay G. Morris, VE2CO — Congratulations to CD for making the first VE2/W 56-Mc. QSO with W8XYR. KH, LK, KW, FO, GT and EB are also going great guns on this band. VO2N visited BO. QE is one of Montreal's newcomers. JG uses pair of 809's on 7 Mc. DR hooked up G2PL with W1AW on 3.5 Mc. EE has DX Century Club award within his grasp, but finds the last

half dozen pretty tough. DE is back from three months' trip as commercial on oil-tanker. CR finally hooked a VS. HL has new YL op at his shack — congrats, Henri! The Quebec Club held a dance January 27th; also presented President AB with a gift on his birthday. The ACF-TSF's new permanent quarters were officially opened Feb. 3rd. The club owns and operates station 2DN. VE3CJ visited Montreal. CP, the McGill Radio Association, is putting out hefty signal on 7 Mc. BH completed neat outfit ending in T-55. HP uses Class B modulation on T-40. CS is heard on 14 Mc. RE has been giving 28-Mc. 'phone a whirl with low-power rig. BK is experimenting with e.c.o. BU is beginning sixth year of schedule with W1GKM! HV gives official League broadcasts at 6 p.m. nightly on 1785 kc. BM came back on 7 Mc. Old 2BB, now VE3NM at Mille Roches, near Cornwall, Ont., sends regards to the gang via AP, who recently went up to see him. MV, T.L. alternate, is new O.R.S. OR and PS are new hams in Montreal West, the latter overcoming the affliction of total blindness to successfully pass his test.

Traffic: VE2DR 181 LC 106 HL 99 J1 80 KM 55 FF 36 CH 16 JG 14 MV 47 HT-HG 10 BU 7 HV-FS 6 CO 3 JX 2 DN 1.

#### VANALTA DIVISION

**ALBERTA** — SCM, C. S. Jamieson, VE4GE — JP is active on 3.9-Mc. 'phone. KP now happily married has new Sky Champion. GG plans new TZ40 final. ACF built rig up in a rack with 809's in final. AJJ is working a bit of 14 Mc. BP is with T20 final. HM has W.A.C. now. NU reports that seven of the Edmonton boys have rigs on 56 Mc. ADW works all hands except 1.75 Mc. VJ, AEA and AKK are on 56 Mc. ANH is building 3.5-Mc. rig. AJS organized a "Varsity Net," and reports inter-varsity schedules going fine. AON had a pair of secondhand '10's willed to him. The Edmonton Club had a visit from AMW, a real old-timer, having been on the air away back when 200 meters was considered high frequency. AQY is on with 6-watt rig. Here are the calls of the New Edmonton Y.L.'s: WE, WH and WY! WH will be on 7 and 3.5 Mc. WY is active on 7 Mc. AQG has been second op at ANH, but has his own wee rig now. AOC completed new freq-meter. AH is knocking over some nice DX. EA spends more time on 3.9-Mc. 'phone than any other band. HJ will be on 7 Mc. from now on. LQ made W.A.C. by snagging a ZC6. AEV joined the ranks of the Benedictics. ZW and KK keep the name of Grande Prairie on the air. TC and TF are on 3.9-Mc. 'phone. ID is sticking close to 14 Mc. AES can be heard over QL. Dates for the Edmonton Hamfest: July 22nd and 23rd. Reserve those days for your trip to Edmonton. The hamfest is going to be bigger and better than ever!

Traffic: VE4GE 39 ACF 11 QK 4.

**BRITISH COLUMBIA** — SCM, J. Hepburn, Jr., VE5HP — TX has new Jr. op. FI directs rhombic on his homeland and hears G's by the score. MQ is on 14 Mc. at new QTH. KP keeps schedule with the frozen North. AAK is well on way to W.A.S. with 6L6 osc. 5AHZ, ex-4PH, is now located at Cranbrook with Dept. of Transport. IO is building 'phone rig using 807. IS and SI are proud possessors of rack and panel job using HF100. AGU boasts of new receiver. The Victoria gang staged their annual hamfest with record attendance of 101. HR won Burrows Cup in annual V.S.W.C. contest. EC put up 81K beam. AHV uses single 19 tube in receiver. ID is on T.L.'s "F" and "I." VE5LU now boasts of a YL op. ADI is rebuilding for more power. SW put in T20 to push 35T to bigger things. For information on emergency work get in touch with AS, the Emergency Coördinator. We need a bigger emergency line-up in this Section. HP has oscilloscope working. DQ is now a proud poppa; that makes ACR an uncle. ADB works VE1 on 1.75-Mc. 'phone. PA and EG landed job with TGA at Winnipeg. VA is new member of West End Club, Vancouver.

Traffic: VE5ADB 75 HP 73 ABN 50 UI 47 ID 36 SW 26 EP 22 BL 12 PU-MJ 8 MK 6 EZ 5 PH 3 EG 2.

#### PRAIRIE DIVISION

**MANITOBA** — SCM, A. J. R. Simpson, VE4BG — New station to come on 3.5 Mc. is II of Waskada. ALT of Portage La Prairie rebuilt receiver. AMT on 7 Mc. is working VK and ZL DX. Attending radio school VE3AHD is resident in Winnipeg. With heavy snowfall in Winnipeg, ZK finds feed line to his rotary beam completely buried. GL completed erection of rotary beam. SS has had 'phone contacts with fifty countries, and reports the Wednesday noon trans-Canada 'Phone Net going FB. QF has recovered

from serious illness, but will be laid up for several months. DU is rebuilding to a transmitter to end all transmitters! KF hunts DX on 14 Mc. UX is arranging to remote-control transmitter. 28 and 14 Mc. are favorite bands for SR. EJ prefers 14 Mc. The S.W.E.C. held meeting of Winnipeg amateurs on Feb. 15th; the highlight was an address by D.R.P. Coates on television.

Traffic: VE4AAW 69 JN 12 AJC 5 SS 2.

**SASKATCHEWAN** — SCM, Arthur Chesworth, VE4SY — ACR schedules following every Mon., Wed. and Fri.: AFF, ACO, CM, QT, AEX, MD, EN, AEG, RS and W7FIS, QZ reports 7-Mc. DX very good. Eight hams now in Weyburn, with AQL and ARC as the latest. WF is building new modulator. WS gets out well on 1.75-Mc. 'phone. ES, with power cut to 1 watt, raised station in Prince Albert. SY again hooked in South America. OP is getting out well since his '52 died. JV reports 28-Mc. DX very good. KS is now with Airways at Hudson, Ont. AJA has new receiver. ZJ is new Moose Jaw ham. ACO gets out well on 3.9-Mc. 'phone. Let's have more reports!

Traffic: VE4ACR 66 QZ 3 SY 2 ACO 9.

#### SOUTHEASTERN DIVISION

**ALABAMA** — SCM, James F. Thompson, W4DGS — R. M.'s: 4DS, 4APU; P.A.M.'s: 4DHG, 4BMM; E.C.'s: 40A, 4CRG, 4ECI; O.O.'s: 4EBZ. "HEAR YE! HEAR YE! HAMFEST IN ALABAMA!" It is with a great deal of pleasure that we call attention to a HAMFEST to be given by the B'ham Amateur Radio Club. The date is April 30th (Sun.). All amateurs within range are invited. We look forward to meeting all the new hams and renewing our friendship with all of the old timers. The B'ham Club appointed a "Monitoring Committee," which will operate under the name of the club and report to the club any violations of rules of the F.C.C., and then assist the ham to correct the trouble. APQ of Miami, Fla., made the B'ham Club a nice technical talk. EBB is back in B'ham. CJZ visited DGS and WMPM in Mtgy. FPB is rebuilding for 7 and 3.5 Mc. EHH, Pres. of B'ham Club, has a pair of 810's with a kw. on 14 Mc. ERX has T55's with 800 watts on 1.75-Mc. 'phone and 250TH's with a kw. on 28 Mc. DDN returned to the fold on 1.75-Mc. 'phone with 25 watts. EYY has new rig with 6L6-6L6-35T. ERW has new 807 buffer. FUR, new B'ham call, is on 1.75-Mc. 'phone. FJA, also new call, has pair of '46's on 1885 kc. FVU is another new B'ham call. EPP has new HQ120X. FNI has all 2A5 rig with 6 watts. EVI has RK49-46-RK10 on 7 Mc. DHG reports from Mobile. The Mobile Club is stressing safety in amateur stations, and plans to have the APC rescue crew at the club for instruction of the members. CNI of Mobile paid DGS and WMPM a visit. FRT pounds 7 Mc. every night. CNI lost Class B transformer, so returned to c.w. How many remember 4AGI Tarrant? Well — he is the new S.C.M. for Georgia. FLS is giving 1.75 Mc. a swirl. FWB of the Lanier Club reports nice traffic total. FHD is back on 7 Mc. CVM has new e.c.o. EBD, CVM and FUJ, with Jr. ops. and XYL's, visited DVJ until wee-sma' hours. EQZ has Class "A" ticket. DVJ schedules 9QHR in Wisc. FTV doubled power. CUE, the B'ham Club, is O.B.S. CWB is new O.R.S. EHH and EYV applied for O.R.S. EYV reports for Tusky Club: AAO is new member of gang at Tuscaloosa Airport. JX built new receiver. FSA worked New Mexico and Nevada in one week. Congrats to FEY on new Jr. op. EKJ on 7 Mc., with 7 watts, worked a G6. CRG rebuilt around a Meissner Signal Shifter. FLS visited the 5th district and took in a hamfest at Hodge, La.; he spent two weeks with his brother, 5GMR. CRG sends more dope from Tusky: 3GVQ (2FGH) is student at U. of Ala. EUI is on 1.75-Mc. 'phone. The Tusky Club has been operating its emergency rig. The Club met at AKP's place. 3GVQ/4, AAO, CPE and FLS sent A.E.C. applications. DS says 'T.L. "D" is working nicely to the coast. EEU reports a radio club organizing at Troy. EDR is working T.L. "J" and is acting N.C.S. EKI and AUP have W.A.S. AUP worked four ZL's on 3.9-Mc. 'phone. FDZ, AUP, EKI, KB and FCE have nice morning round-table on 1.75 Mc. EIJ is 1.75-Mc. 'phone in Wetumpka. DPX, ECF and FUM hold 28-Mc. 'phone open in Mtgy. CWB on 14 Mc. worked HABC, ZSIGN and several VK's. ATTENTION, ALL ALABAMA HAMS: There will be held Sunday afternoon, April 2nd, from 3 p.m. until 6 p.m., another of those Alabama QSO Parties. The rules this time are slightly different: Scoring: One point for each station worked. Two points for

(Continued on page 108)

# ★ A NEW ULTRA HIGH FREQUENCY DUAL Transmitting Condenser

This popular "N" series is now augmented by the new type NT-50-GD, shown here with a pair of the new "M" mounting feet.

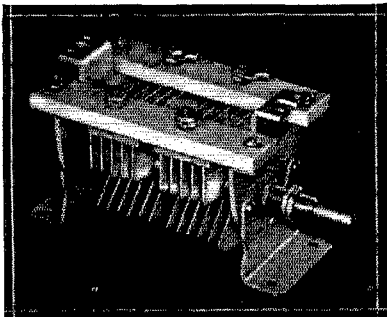

NT-50-GD  
(Protected by U. S. Pat. No. 1626391)

The wide popularity of our type NP-35-ND for diathermy machines, ultra high frequency oscillators and P.P. amplifiers, has indicated its versatility, and we are flattered by its universal acceptance.

A dual 50 mmfd. unit has been requested, capable of operating in a push pull class "C" amplifier, 100% plate modulated, using such tubes as a pair of T-20's etc.

★ SPECIFICATIONS ARE AS FOLLOWS: ★

### TYPE NT-50-GD

Frame—Same as NP-35-ND.  
Capacity—7-50 mmfd. per section.  
Airgap—.070"—3000 volts peak.  
Plates—Buffed and polished—rounded edges.

LIST PRICE ..... \$6.00 each

AMATEUR NET PRICE... \$3.60 each

Oh yes, those type "M" brackets shown, which make for short lead lay-outs for "N" or MIDWAY condensers, are put up individually in envelopes with screws and lock washers for 20c list each, 12c net each to amateurs.

See these at your nearest dealer or write for further information.

**THE ALLEN D. CARDWELL  
MANUFACTURING CORPORATION**  
83 PROSPECT STREET, BROOKLYN, NEW YORK

## A Hurricane Emergency Receiver

(Continued from page 51)

bias, and 45 volts on the detector is recommended. If sufficient batteries are not available, the "C" battery leads may be connected to "B" negative and the audio stages operated at reduced voltage. With 90 volts on the plates, loudspeaker reception may be enjoyed on broadcast stations and some short-wave stations as well with a small indoor antenna. Equally good results have been obtained in an automobile with nothing more than an ordinary fishpole antenna.

The finished set is a pleasure to use and it has satisfactorily met all the specifications which were set up before it was constructed. Less than a dollar was spent on the construction. There is no question of the reliability of the receiver since the failure of two tubes or both audio transformers still leaves the set usable as a one-tube receiver. Battery drain is small and few batteries are required. Although a receiver of this type cannot, of course, compare with a modern super-heterodyne, the reception is amazingly good. Band-spread and selectivity are both better than expected and the results on 600 meters are excellent. Though designed and intended to be a hurricane emergency receiver, this little set has proved to be so handy that it is kept in commission not only during the storm season, but all the year. It serves as a stand-by receiver on 600 meters and as a spare to use in case the regular station receiver goes out of commission. It has also come in handy to take on trips and picnics. In the North it would be a fine thing to have during the winter in case of power failures or interrupted communications from blizzards.

## Superhet Converter

(Continued from page 54)

readings are useless except for comparison purposes.

If the receiver gain is wide open, the noise level on both 5 and 10 meters may at first seem objectionable. There is undoubtedly some noise caused by the converter itself, but the actual signal-to-noise ratio is quite high. By reducing the receiver gain to the point where there is practically no noise, plenty of hop will be available on the converter combination, and low inter-station noise level will result. It is also possible to use maximum r.f. gain and cut the audio gain. A little experiment with the combination will enable the user to obtain optimum performance to suit his requirements.

We want to take this opportunity of expressing our sincere thanks for the cooperation and assistance rendered by W1EYM when making various tests.

**Strays**

"W3CEZ tells me that he has just put up a diamond and is 'beaming' all over." — W3VG.

Two  
Quartz Crystals

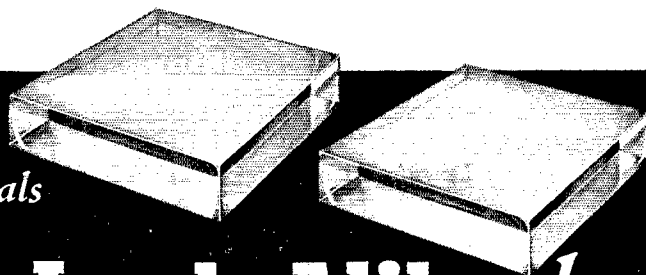

**They Look Alike** *but*  
*in performance there is a vast difference!*

One of these crystals is an erratic performer; has a wide frequency change due to "drift"; gives low power output and operates on more than one frequency. The other crystal is excellent; gives dependable performance on only one frequency at high power output and is little affected by temperature change.

In appearance they are identical but proper choice of raw material, selection of the cutting axis and precision fabrication make one vastly superior to the other.

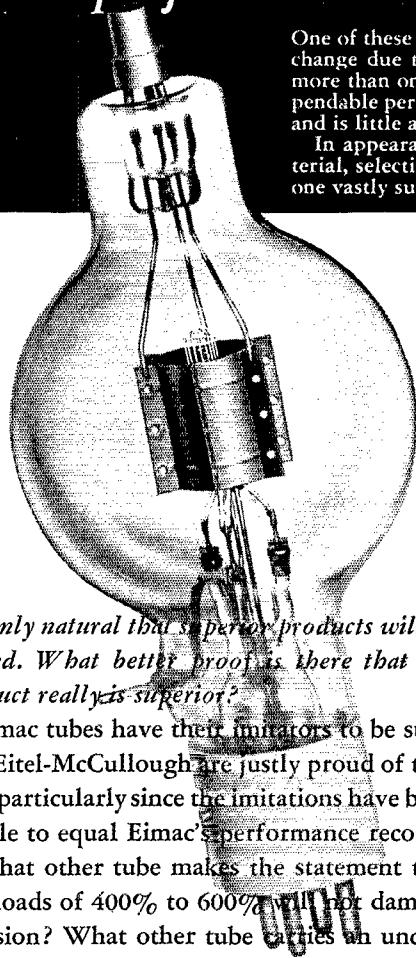

*and so it is with*  
**VACUUM TUBES**

*It's only natural that superior products will be copied. What better proof is there that the product really is superior?*

Eimac tubes have their imitators to be sure, and Eitel-McCullough are justly proud of that fact, particularly since the imitations have been unable to equal Eimac's performance records.

What other tube makes the statement that overloads of 400% to 600% will not damage emission? What other tube carries an unconditional guarantee against tube failures which are caused by gas released internally? What other tube will operate at equal efficiencies?

Last season the DX contest saw every winner (first, second and third in both phone and CW contests) using Eimac tubes. This is a record that probably will never be equalled.

That Eimac tubes do have superior characteristics is a fact recognized by the world's leading radio engineers and thousands of progressive amateurs. Step into line with the world's leaders by installing Eimac tubes in your transmitter. With proper handling you too can rank at the top in amateur radio communications.

*See your dealer for information or write.*

**Eimac**  
TUBES

**EITEL-McCULLOUGH, INC., San Bruno, California**

(Continued from page 105)

each Official A.R.R.L. Station worked. These A.R.R.L. Official Stations are: All O.R.S.-O.P.S.-R.M.'s-P.A.M.'s-E.C.'s-O.O. The Alabama QSO Party general call is "CQ Ala." The first and third hours are suggested for same-band contacts, with the 2nd or middle hour for cross-band contacts. April 2nd is the first Sunday in April. 73 — DGS.

Traffic: W4DS 132 EDR 88 CRG 28 ERW 27 AUP 18 FWB 12 EYV 15 EPP 6 DVJ 5 CWB 16 FMI16.

EASTERN FLORIDA — SCM, Lewis A. Connolly, W4DVO, Assistant SCM, 4AGR — R.M.: 4COB, P.A.M.: 4DDB. PB is building modulator for 28-Mc. 'phone. FVN is new 3.5-Mc. A.A.R.S. in Jax. 5GOH/4 left the C.C.C. for the Signal Corps at Ft. Benning, Ga., and we all wish him success. Reckon everybody heard DUG at Pan American De Soto Exposition, Tampa, operated by Tampa Amateur Radio Club on 3.5 and 7 Mc., daily, beginning Jan. 31st. Operators at DUG were: FIK, ECJ, ERU, ALF, COV, DVO, EFK, EMF, CZS, FCP, DRX, EGL, EOA, BNR, EZX, AJX, DCZ, EUF and others. EPV received QSL from country number 75. FGQ is prospect for A.A.R.S. DNA is on T.L. "J." pinch-hitting for COB. PEI will soon have 500-watt final, and shelved the lil' pair of 6L6's with 11 watts input, with which he handled 1000 messages this month! Arthur Lynch, 2DKJ, visiting Tampa, crashed the Florida Fair, with his A.R.R.L. World's Fair pass. DWU has new rig, HK-54 final with 300 watts on 7 Mc. FWJ is new ham in St. Pete on 7 Mc. DAP will be on 7 Mc. FUV is on 7 Mc. at Jax with "QSL-40" and Sky Buddy. EPY has grid-modulated rig on 3.9-Mc. 'phone. FOG graduated from Port Arthur College and got job with BC station at Huntsville, Ala. DDB received W.A.S. Certificate No. 727. EUN is applying for O.R.S. EPV is member of R.C.C. KK is doing FB handling traffic at Miami.

Traffic: W4DUG 3350 DVO 633 PEI 1000 KK 70 CBK 3 DXH 509 CNZ 58 DNA 118 DDB 7 EUN 8 COV 17.

WESTERN FLORIDA — Acting SCM Oscar Cederstrom, W4AXP — AXF, Mrs. MS, has Collins 4A working 14, 7 and 3.5 Mc. MS is working on band-switching device. 6QCQ is on 28-Mc. 'phone modulating a pair of T55's Class B. 6QAW/4 assisted 6QCQ with rig. 6OAP/4 is getting a "4" call. OA4N is in Pensacola. UW rewired VR's receiver, and VR says it works FB. EAD is on 28 Mc. EFG is new call in Pensacola. EPT is really getting the DX. QK gets out on 3.5 Mc. FAA has a rotary beam. Here is some N.C.R. news reported by R.M.-DXQ: The Chief of Naval Communication Operations, Washington, advised Comdr. Hardesty, our D.C.O., that the Eighth Naval District is setting a record in drill attendance never before reached by any district. DAO has been putting in '08A final. CDE has been handling traffic. FCE is putting a 1.75-Mc. 'phone together. FVJ is on 1.75-Mc. 'phone. 5HDA/4 is on 7 Mc. FJR ran schedules with DUG at the Tampa Fair, moved a lot of their traffic and made the B.P.L. FRQ is rebuilding 7-Mc. rig. BJF is rebuilding. FJM read the QST warning about high voltage, shoved his kw. rig in the corner, and decided to go on 7 Mc. with low power. ACB is coming back with pair '08A's in final. EAP is member of Fla. Net. DLO has been going to town handling traffic into Fla. AXP sprouted out with new pair of T40's. ECM has 1.75-Mc. 'phone going.

Traffic: W4FUR 1004 AXP 522 DLO 194 EAP 42 EPT 27 CDE 10 FCE 2.

GEORGIA — SCM, Leland W. Smith, W4AGI — VX and ECZ are new R.M. and E.C., respectively. More A.E.C. registrations are urgently needed in Georgia. Write your S.C.M. for registration forms. ANN has HK54 final and new vertical "J" antenna. EFS has a kw. on 56 Mc. FJL, ERS and EYK are on 7 Mc. The Southeastern Emergency 4-Mc. 'Phone Net recently reported 100 different stations into the net within 16 minutes. Good work, VF! The S.A.R.A. held its annual banquet, Feb. 25th, with Mr. F. E. Handy as guest of honor. Fire destroyed the country home of VO in Rome, where the annual hamfests of the North Georgia Radio Club are held. The Birmingham Amateur Radio Club will give its annual hamfest in Birmingham, on April 30th, and Georgia amateurs are cordially invited to attend. BPG has new QTH atop one of the seven famed hills of Rome. BAC, DAY, DQT, GY and BBR are on 14-Mc. 'phone. AAR has a 6L6 in combination 'phone-c.w. transmitter. BAZ enlarged his shack. ENQ has new QTH. AOB is taking this traffic business seriously. BGU, EKS and DNY are getting back on. The Georgia Tech Radio Club, AQL, has four separate transmitters, each with push-button band-switch-

ing. The masts at AGI fell in high wind, one of them crashing through the roof of the shack. FCZ, FCW, FQW, EQB, BZD and FFD are on 1.75 Mc. DXW has rotary beam on 14 Mc. ENS moved to McRae and acquired XYL. Congrats, OM! ARS reports pair of 801's in final. FFI is using e.c.o. EJS and EUE are on 14 Mc. ERS, new O.P.S., is erecting 1.75-Mc. vertical. EJN is active in Atlanta U.S.N.C.R. Unit. DQT, ECZ and VX visited the S.C.M. ECE is building 500-watt 'phone for 1.75 Mc. 5HEK, XYL from Texas, is now in Augusta. There isn't a single Official Observer appointment in Georgia, and letters from anybody with frequency measuring equipment will be welcome. And O.R.S., O.P.S., O.B.S. appointments are available to those qualified. Don't forget your reports promptly on the 16th of each month.

Traffic: W4R 1824 BAQ 1132 AOB 442 AGI95 MA 20 FDJ 17 VX 13 AQL 15.

WEST INDIES — SCM, Mario De La Torre, CM2OP — K4RJ, A.R.R.L. QSL Mgr., was worked by CM2OP, and he promised to send a monthly report of the K4 gang. CO2JJ works 14-Mc. 'phone with T-55 final. CM2AU got a baby on last Christmas! CM2AD QSO'd J2JJ on 14 Mc. CO2JM is back after long time. CM2OP uses SX-16 receiver. Don't forget to send me your monthly report. It will be welcome. 73.

## DELTA DIVISION

ARKANSAS — SCM, Henry E. Veltz, W5ABI — 5GYR A is headed for Tenn. HDC has new rack and panel job with T55 on 1.75, 7 and 28 Mc. HND is new station at Osceola. GLZ is working hard on band-switching kilowatt. HSK is new station at Lepanto; WK is "her" dad. HSQ gets out FB with 15 watts on 1.75 Mc. GJL is working such distances as Pittsburgh with 8 watts on 1.75 Mc. GSY has been working good DX on 28 Mc. with his rotatable beam. GSC is building 100-watt job. GNV keeps schedules twice daily with EIP, who is portable in Chicago. HHZ is building an 80-watt c.w. rig. BJR has new 60-foot sky hook. HCP is rebuilding an all-band job with 807's final. DZK is rebuilding kw. job on 7 Mc. with '52's in final; also operates his  $\frac{1}{2}$  kw. on 1.75-Mc. 'phone. HFP has 80 watts on 7 Mc. FAU is on 1.75 Mc. DSW is on 3.9-Mc. 'phone from new location. EAR is on 1.75-Mc. 'phone. SI works 3.9- and 1.75-Mc. 'phone and 3.5- and 7-Mc. c.w. DNX visited hams in L.R. FPU gets FB reports on 1.75-Mc. 'phone with 28 watts. GMB is new 1.75-Mc. voice in L.R. FA and FB are keeping Hazen on the 1.75-Mc. map. QI is portable at Smackover. GIF at Stamps gets out FB on 1.75-Mc. 'phone with FYX at the mike quite often. HMK and HTJ are newcomers in Smackover. ESA is doing his share for Ark. on 14-Mc. 'phone. FWD, HBK and GDB are busy in Eldorado with 28-Mc. 'phone. ABE puts out FB signal on 1.75-Mc. c.w. EWX is shoving off on 160 fone with 20 watts. BMI is heard just any time you turn on your receiver. ANR is holding down Trunk Line "D" in fine shape. FGS is working 7 and 3.5 Mc. after about a year's absence from ham bands. The Greater Little Rock Amateur Radio Club has been organized with EEA, pres.; GWG, vice-pres.; EKD, secy.-treas., and GIC activity mgr. The Paragould gang sponsored the last meeting of the Moarky Amateur Radio Association, and everybody had a swell time. Besides BJR, DZK, HCP and HFP, who put on the meet, state hams in attendance were GHJ, RW, GJL, GSY, HND, GNV, SI, EAR and HAE. SI attended club meetings and hamfests in Nashville, Tenn.; Monroe, La.; Camp Beauregard, La.; Paragould, Ark., and Little Rock, Ark. The Fort Smith Radio Club has been approved for affiliation with the A.R.R.L. GED has been appointed O.P.S. and O.B.S. EVERY Arkansas amateur is invited to send a report to the SCM on the 16th of each month.

Traffic: W5ANR 32.

LOUISIANA — SCM, Eugene H. Treadaway, W5DKR — R.M.'s: 5BN, 5DWW, 5GHP. P.A.M.'s: 5ADJ, 5CXH; E.C.'s: 5DAQ, O.O.'s: 5FXX, 5GDU. DWW worked all G districts on 7 Mc. HET has new SW3. HSN is new ham at Tech. DRX added 225-watt final. HGT has new rig under construction. HPW will install T55 final. KC has new 28-Mc. three-element, close-spaced rotary beam. EQP says 3.9 Mc. gave him a whirl. DNW has FB rotary. Attention, All Louisiana Amateurs: In case of emergency or communication failure, wire collect J. Allen Swanson, Jr., E.C., 5DAQ, 823 Perdido St., New Orleans, giving frequency available. Contact will immediately be made and instructions given for proper routing, etc. The Red Cross and public authorities have a list of more than 150 stations in Louisiana

and Mississippi available for emergency communication facilities. HCE reports HQP, portable-mobile off coast of Calif., very anxious to contact New Orleans stations. ERV is active on 28-Mc. 'phone; he is a grand fellow, only 67 years young. FUS likes working VK's and ZL's. BHL, EEE and HTT are 28-Mc. 'phones in Shreveport. 98YE-5 has brand-new Jr. op. Congrats, OM. FPZ is building new exciter. EEL is building radio-controlled gas model plane. HCE is proud owner of home-brewed 28- and 56-Mc. converter. BYY runs 800 volts at 90 mills on his 807. ZS likes 14-Mc. 'phone. The New Orleans Radio Club held another of its famous banquets on Feb. 4th. Prizes were won by GKJ, the luckiest guy in New Orleans, CIQ, who told the best joke, and EBB and FSX. HOU got his T40's going on 7 Mc. HSH is new 7-Mc. ham in Shreveport. CXH has new three-element fixed beam. GDU has new e.c.o. perking FB. AVO has new 101X receiver. GLH is a 'phone man now. ECO has keen signal on 14-Mc. 'phone. FPO backed a truck in front of DKR's shack and unloaded a complete station for the OM.

EVS is a live-wire activities manager of N.O.R.C. EDY pulls in DX with his SW3. JW changed his SW3 into a pre-selector. EOY received worked card from Scotland. FZQ is rebuilding. GIA hears plenty DX. EBB reports that DYR, N.O.R.C., will be active soon on all bands. GUK is low-power 1.75-Mc. 'phone. HOA works about town on 7 Mc. GMF enjoys his 28-Mc. ragchews. The Delta "75 and 160 Emergency Net" Hamfest of Feb. 12th at Alexandria was an outstanding success. GUX, N.C.S. "Delta 160," reports an attendance of 66. The brawl started with a banquet featuring fried chicken. Honored guest of the day was 58I, Director Arledge of the Delta Division, who gave a short speech on A.R.R.L. activities. A dance in the evening completed the affair. FUM is getting on 28 and 1.75 Mc. with TZ40. BRR is a big N.C.E. man. FVK is building 500-watt rig. GXQ is half way on with 6L6 final. GDA is putting in 100TH. EQQ decreased power to a 6L6 osc. GEF is working on new rig. GEB's 807 final is FB. HPM and HPN are new hams in Baton Rouge. HEZ is on with FB rig. EVZ changed QTH from Baton Rouge to Thibodeaux. HMV has Utah rig on 1.75-Mc. 'phone. 4BGO-5 has 150-watt job on 14-Mc. 'phone. AFW installed an RK-28 with 200 watts. MH is new activities manager for B.H.A.R.C. FVK, GAL and HEZ have new NC-44's. Attention, Ham Clubs and Groups: It is about time to be making plans for our 1939 Louisiana State Convention. Anyone interested in sponsoring the convention, please get in touch with Yours Truly. ACY heard some FB DX on 3.9 Mc. BSR is building new receiver. HMV has new Thordarson 100 'phone and c.w. rig. BN is leading traffic man in the Section. FXX is active trunk line station. GEF, former S.C.M. of Mississippi, is now No. Louisiana R.M. and active in Springhill. CJO has been doing a little 1.75-Mc. 'phone work. ANA, a real old-timer, is active again. 6UZ is active portable in New Orleans. 5CQJ of Jackson, Miss., says the Ham Club of that city is working hard, and hopes to place a bid for the 1939 Delta Div. Convention. HEJ and HEK are Mr. and Mrs. EGK has new 81X receiver. CNG is active 3.9-Mc. 'phone in Monroe. Fellows, we are interested in getting our state to issue licenses for our automobiles with our call letters on them instead of the regular numbers, and are working toward that goal. May we have the support of yourself and your club? Anyone interested, get in touch with 5FJW, Mrs. Jewel L. Cawaway, Monroe, who is in charge.

Traffic: W5BN 1806 DKR 812 GUK 592 EDY 349 FXX 559 DWW 83 DAQ 59 CXH 18 KC 14 CXQ 18 GLH 10 HCE 1 HOU 2.

MISSISSIPPI — Acting SCM, Robert Barr, W5GHF — FCH has new Howard receiver. HAD has new Hallcrafters transmitter. EKV has Shure crystal mike, got DAN to build speech amplifier and is on 1.75 Mc. with low-powered rig. FQL got new Sky Buddy. HMV visited DAN and GXO. EGE is having DAN give his old rig a trimming up.

TENNESSEE — SCM, W. H. Walker, W4DWS — R.M.'s: 4PL, 4CXY, FDT. Coördinator for Memphis, reports one of the best emergency organizations in the State. FCU applied for O.R.S. FFF wants schedule on 7 Mc. with anyone! DLK is our new O.B.S. RO is one of the oldest O.R.S. in the Section. PL is still in the lead so far as traffic is concerned; look at that report! FX and DEP have not been idle, either. Fine work, fellows! The Birmingham Club is sponsoring a hamfest on Sunday, April 30th. You are all invited according to APU, Director of Southeastern Division. Tennessee should be well represented. Several Nashville

amateurs, with the coöperation of the U. S. Engineers, executed a Field Day, Sunday, Jan. 29th. Under EYQ, the N.C.S., AWB, AXD, BAF and APA went into the field. The work was under conditions very similar to those of the last great emergency. PL, DEP, FX and the N.E.N. listened. Here are the Memphis district boys who are really prepared for emergency work. (Basic) CQX, CMC, EIS, FRU, FCC, FW, ETD. (Supporting) FQD, FEB, BFI, EWC, EYO, FDT. Our goal is for every Tennessee city to be as well organized.

Traffic: W4PL 3829 FX 596 DEP 277 FFF 156 FCU 118 RO 86 DWS 61 ERN 62 ETD 35 BQK 30 FDT 25 APC 11 DLK 2.

### ROANOKE DIVISION

NORTH CAROLINA — SCM, H. S. Carter, W4OG — As retiring S.C.M. I want to thank all the fellows for their fine coöperation during my term in office. It has been a real pleasure working with you all. I pledge my loyalty to the new S.C.M., and sincerely hope every amateur in North Carolina will do the same. FJS is rebuilding to work from 1.75 to 14 Mc. ALT is always on for A.A.R.S. drills. DWB reports for the Chapel Hill Club. WE has transmitter under construction. 2GUM is member of the Club. 8GHS/4 has T85 going FB on 7 Mc. The Club applied for affiliation with A.R.R.L. BHR gets on for A.A.R.S. drills. DLX is handling plenty of traffic on T.L. "C." FCB took Commercial Second exam. CDD's new call in Louisville, Ky., is 9BWQ. ATC, State College Radio Club, is on with 300 watts to final. HCG on 7 Mc. is working plenty with an osc. DOU keeps 14 Mc. hot. BRT will be on with 250 watts in final. DGV has kept a schedule with 8MZY every Sunday morning for a year. 4NC had a visitor — Mr. F. E. Handy, A.R.R.L. Communications Manager. Everyone enjoyed his talk, and is looking forward to his next visit. ACA is putting up rotary beam. Don't forget to report to your new S.C.M.!

Traffic: W4DLX 318 EYA 22 ALT 16 ATC 14 BRT 9 FJS 8 NC 7 BHR 5.

SOUTH CAROLINA — SCM, Ted Ferguson, W4BQE — CQU is active in the nets. FFH is dividing time between 'phone and c.w. EDQ works 28- and 1.75-Mc. 'phone and handles traffic on 7 Mc. The wind blew down one of ECG's poles. DRE has new HQ120X receiver. EZF has new rig with P.P. 809's, and worked his first W6 on 1.75-Mc. 'phone. EPJ worked the O.R.S./O.P.S. Party with FB results. BRF has daily schedules with Blakely and Atlanta, Ga. FEH's emergency organization is coming along nicely. AUW has rotating 28- and 14-Mc. Johnson beam. CUR will be on with new rig using 55T. CZA worked his first DX on 3.5 Mc. CQG has his W.A.S. at last. FSL is active in S.C. and A.A.R.S. Nets. DNR operates 3.5-Mc. c.w. and 1.75-Mc. 'phone. BZX is changing modulator system. EXJ will have 4 half-waves in phase on 28 Mc. ETF is rebuilding using rack and panel. GB will be on 3.5 Mc. BPD worked 145 stations in 36 states in W.A.S. Party. CZN and the A.A.R.S. net handled much traffic. CKA changed QTH to Lyman. EOP visited Lyman gang. FRY gets out OK with his 6L6's. CHQ changed QTH to Fort Sill, Okla. BDT made nice report on Lyman gang.

Traffic: W4CZN 325 CZA 321 DXF 155 BRF 71 EOP 59 CQU 48 ECG 39 DGD 32 FFH 25 FSL 23 FDN-FKX 21 FMZ 20 BPD-FHE 17 EDQ-CUS 13 EOZ-FNC 12 BDT 9 EZF-EXJ 8 EZF 7 EHF-ETF 6 EPJ 4 EGH 3 DNR-BZX-DQY 2.

WEST VIRGINIA — SCM, C. S. Hoffmann, Jr., W8HD — The biggest news of February was the sudden rise in several rivers, which caused slight floods in the vicinity of Huntington and a complete cut-off of communication at Dunbar, Madison and Logan. Stations reported to have participated are: O.R.S. and A.A.R.S. in the vicinity of 3700 kc.: ELJ, BTY, CZ, BWK, DYB, LGB, LII, HUK, KYJ, MCL, NAU, PSR, PTJ, NSE, HD; 'Phones on 1.75 Mc.: MOL, QFN, PNE, KHB, SES. BWK was appointed Emergency Coördinator of Wheeling and Ohio County; PNE was appointed E.C. for the Logan district. OXO, newly-appointed R.M., accepted appointment formerly held by BTY on Trunk Line "B"; GBF is Alternate (also new O.R.S.). Congrats, OMs! New Wellsburg station: SYJ, KLP moved to Cleveland. 2BXR/8, located at Elkins airport, expects to be moved to Baltimore Airport, to be replaced at Elkins by 2BYJ. The S.C.M. thanks QEC, NSE, SES, PNE and SUW for their first reports. 3ZD visited Wheeling; MOP visited Charleston. MIP visited Baltimore. HGA has worked 98 countries, 91 verified.

(Continued from page 16)

capacity is kept low, as it only carries d.c. If any r.f. is getting through, it can be detected by the appearance of c.w. birdies when  $T_5$  is tuned through i.f. resonance. There should be no trouble if  $RFC_2$  is big enough. A slight increase in  $C_{81}$  will surely stop stray r.f. but will also cut down on silencing efficiency. We chose the chassis arrangement after considerable checker playing with possible combinations. It permits removal of the crystal-silencer section or the removal of the silencer connections only. When W9ADG gets that perfect location, a 6J7G can be slipped into the 6L7 socket. In the meantime, we are most grateful for the amazing effectiveness of our noise suppressor.

Few will have any trouble making a b.o. work if they do not run astray on the wrong birdie. The usual complaints in this department are stray coupling and hiss. The coupling to the second detector,  $C_{37}$ , is the last unshielded half-inch of the lead seen entering the tube shield. It just rests in there about a half inch from the grid cap. Removal of this lead, with the b.o. on, should diminish the c.w. beat note to almost nothing. About half of the hiss disappeared with the placing of generous by-pass condensers on both sides of the heater at the b.o. socket. Most of the rest was cleaned up by an increase in b.o. plate voltage. Adequate filtering of all supply leads is, of course, important. Because of the sectional mechanical arrangement of the under-panel parts of each stage are automatically shielded from the others, though it is doubtful if this contributes much electrically.

### Parts Layout and Wiring

A circuit diagram is not much use as an indication of where to place various resistors and condensers physically. Only thought as to function can tell the builder when he must concentrate on short leads and when he can wander around. Such combinations as  $C_{10}$  and  $R_8$ ,  $C_{11}$  and  $R_3$ , etc., are placed just as close to the equipment they filter as possible. For example,  $C_{10}$  and  $R_8$  are in the oscillator box right at the coil socket. Better filtering and shielding in an r.f.-detector combination or an i.f. amplifier simply means farther advancement of gain controls before something breaks into oscillation.

While the diagram calls for 0.1- $\mu$ f. filter condensers in the i.f. circuits, 0.05 or 0.01 will probably have to be used in crowded spots. Thought of filtering needs and voltage requirements can determine where smaller units can be used.

We don't know why  $C_{35}$  should have such a hard time of it, but two 600-volt paper condensers passed out there, hence the specified mica unit.

$R_{16}$  does not need to be a panel potentiometer if the best screen voltage is determined on some slider arrangement. There is a definite best spot

**NOW...**

## TRANSMIT AUDIO- FREQUENCY TONES

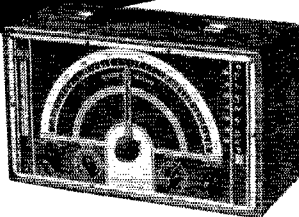

### From Your Station!

*New F.C.C. rules permit it for test purposes— and this RCA Beat Frequency Oscillator is just the instrument with which to do the job.*

Stock No. 154 RCA Beat Frequency Audio Oscillator illustrated here gives a variable frequency source of alternating current voltage from 30 to 15,000 cycles. It provides choice of three output impedances through medium of tapped output transformer, and has large  $8\frac{3}{4}$ " dial over approximately 160 degrees. Your RCA Test Equipment Distributor will be glad to demonstrate the many other features of this instrument. Its price is only \$49.95 net.

For finer radio performance—RCA Radio Tubes.

*Listen to the Magic Key of RCA every Sunday, 2 to 3 P. M., E. S. T., on NBC Blue Network.*



# Test Equipment

RCA Manufacturing Co., Inc., Camden, N. J.  
A Service of Radio Corporation of America

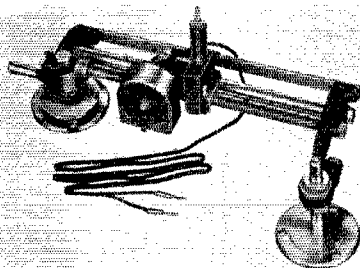

## Build Your Own Recorder with REK-O-KUT RECORDING MECHANISM

REK-O-KUT answers the popular demand for a recording assembly which will record on acetate and can be attached to your own public address system or phonograph-radio combination easily and without extensive mechanical changes.

It consists of a spindle and worm gear, driven at the center of the turntable, feed screw, cutting head mounting and cutting head. Mechanism can be aligned with turntable. Operates with as little as 2 watts driving power from amplifier. Cutter impedance of 8 ohms matches secondary of output transformer.

NET TO AMATEURS..... **\$29.55**

WRITE for literature

## REK-O-KUT CORPORATION

254 CANAL STREET NEW YORK, N. Y.

Export Division — 458 Broadway — New York, N. Y.

U. S. A. — Cable Address: Morhenex



# HALLICRAFTERS' LATEST AND NEWEST RECEIVER!



New Skyrider 23

Only **\$22.50** Down

Buy on Newark's

## EASY TERMS

- Only \$18.58 per month for 6 months
- or \$12.50 per month for 9 months
- or \$9.47 per month for 12 months



### \$127.50 CASH PRICE

Complete with Crystal, Tubes and Speaker, Mounted in Cabinet to match

## 14 FEATURES OF THE NEW SKYRIDER 23

- ★ General Coverage — 34 to .54 MC (8.8 to 556 Meters).
- ★ 8 Band Position — **GENERAL COVERAGE**
  - Band 1 — 11.0 to 34.0 MC
  - Band 2 — 5.2 to 16.5 MC
  - Band 3 — 1.7 to 5.2 MC
  - Band 4 — .54 to 1.7 MC
- ★ **BAND SPREAD RESET ACCURACY** — Each Amateur Band is spread out over the entire outer calibration scale of the large 3 1/2" diameter dial.
- ★ **Tube Complement** — Total Number of Tubes — 11.
  - Band 10 — 3.5 to 4.0 MC
  - Band 20 — 7.0 to 7.3 MC
  - Band 40 — 14.0 to 14.4 MC
  - Band 80 — 28.0 to 32.0 MC
- ★ 1st. R.F. — 6SK7; 2nd I.F. — 6SK7; BFO — 6SJ7.
- ★ 1st Det. — 6SA7; 2nd Det., 1st. Audio — 6SQ7; Rectifier — 80.
- ★ H.F. Circ. — 6SJ7; Amplifier AVC — 6B8; Noise Limiter — 6N7.
- ★ 1st. I.F. — 6SK7; Power Output — 6F6G.
- ★ Audio Output — 5 Watts.
- ★ Temp. Compensated Permeability — Tuned I.F. Trans. Units (455 K.C.).
- ★ Complete Shielded, Permeability-Tuned Crystal Filter Circuit.
- ★ 6-Position Variable Selectivity Switch.
- ★ Controls: — Pitch Control, Tone Control, Band Switch, Standby Switch, Selectivity Switch, A. F. Gain, R. F. Gain, Main Tuning Knob, New and Improved Design Automatic Noise Limiter controlled by Switch, Crystal Phasing Control, Phone Jack.
- ★ S Meter calibrated in "S" units and db's.
- ★ Directly calibrated, Indirectly illuminated, "Venetian Blind" Tuning Dial.
- ★ Modern ventilation grills.
- ★ Speaker — P. M. Dynamic in separate cabinet of matching design.
- ★ Cabinet Finish — Machine Tool Gray, Crystal finish with Gunmetal and chrome finish escutcheon.
- ★ Cabinet Dimensions — Width, 19", Height, 9 1/4", Depth, 12 1/4".

Now in Stock for Immediate Shipment!

## LOOK AT THESE BIG NEWARK SPECIALS!

### New Foreign Order Dept.

Special Attention given to FOREIGN ORDERS in this new Export Department. Hams outside the U. S. be sure to WRITE TODAY for Big New Catalog and full details of Newark's New Foreign Order Dept.

ORDER Direct from NOW This Ad

### Oil Filled, Oil Impregnated FILTER CONDENSERS

Only \$1 1500 V. DC. 1 1/2 mfd.

2" Diameter Round Can, 2 3/4" high, Weight 1/2 lb. Well Known Makes. Only a few of each left... and they're going fast. Order Now. Guaranteed at rated voltages.

2 mfd., 2000 V. DC 4 1/4 x 3 1/4 x 1 3/4, 1 1/4 lbs.....	\$1.50
3 mfd., 1250 V. DC 3 1/4 x 3 1/4 x 1 1/4, 1 1/4 lbs.....	1.25
3 mfd., 1500 V. DC 5 x 3 1/4 x 1 3/4, 1 1/2 lbs.....	1.50
4.4 mfd., 1500 V. DC 5 x 3 1/4 x 1 3/4, 1 7/8 lbs.....	1.75
8 mfd., 2000 V. DC 5 x 3 1/4 x 3 1/4, 2 3/4 lbs.....	2.75

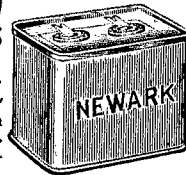

### Your CALL LETTERS in GOLD ..... 10c

Big shadowed decalcomania letters nearly TWO INCHES high. Put them on your HAM SHACK door, auto window, etc. Send dime for yours today. Be sure to give your call letters

We will have all the New Receivers as Announced by the Manufacturers. ★

## WRITE TODAY

FOR OUR FREE CATALOG FOR TIME PAYMENTS ON OTHER RECEIVERS. Brand new 76-page book describing and illustrating thousands of items, sets, tubes, parts and supplies. Write for your copy TODAY. It's Free!

# NEWARK Electric Company

323 W. MADISON ST. Dept. Q CHICAGO, ILL.

# It's a **REAL** X-mitting Job!

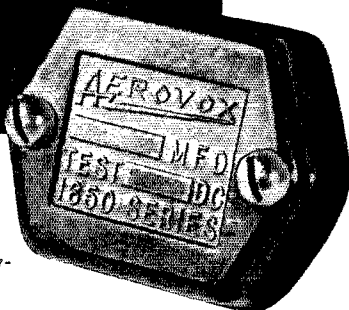

Bakelite-molded mica capacitor. Screw terminals. Tapered sides.

A high-voltage low-loss unit.

1000 to 10,000 v. D.C. test.

All popular capacities from .00005 to .05 mfd.

One of 15 types of mica capacitors in the AEROVOX complete line.

● Give these AEROVOX Series 1650 your toughest assignments. They'll stand up. With low loss, too. ● Ask local jobber about them. Get our latest catalog from him. ● Or write us direct.



for a given tube.<sup>5</sup> Lowering this voltage makes a very effective way of controlling gain, the noise apparently dropping off faster than the signal. Variable antenna coupling in a separate coupling unit is our favorite r.f. gain control. An additional r.f. stage (acorn) will be added soon to take those 'phone images out of the 28-Mc. c.w. band.

The practice of supporting small parts by their own leads can be carried too far. Our favorite dodge is to use pillars of bakelite at congested d.c. junction points, and of ceramic when it is r.f. In the r.f., first detector and oscillator compartments bakelite pillars one-half inch in diameter hold the coil socket an inch or so above the compartment floor.

There is no need for discussing the power supply excepting to advise making it as big as possible. Terminal voltages should be at least 280 and heaters a full 6.3 with all tubes on. If the largest receiver type transformer is used there will be plenty to spare, permitting the use of adjusting resistors.

Most of the controls on the panel can be identified from the top and bottom views of the set. The extreme left-hand knob is a blank; at least, it was at the time the picture was taken. At the extreme right is the off-and-on switch. Throwing it one way closes the "B" circuit to the entire set, except the b.o.; the other side includes the b.o. The spacing of these six lower knobs is not even, but looks it because of dials on the two right ones. The detector-r.f. control need not be a vernier dial — an ordinary knob might do — but there are times when the other seems helpful. A  $\frac{3}{8}$ "-to- $\frac{1}{4}$ " reducer permits using the large knobs on these dials; it is a worth-while change. A little black enamel does wonders for the dignity of the dial center-pieces and the chart frame. Instead of a graph in the chart frame, tables of dial settings at 10-ke. intervals might be more practical. Another suggestion is a piece of ground celluloid which can be used for a memo pad. We have the habit of recording our memos on the aluminum panel itself. Panels of rubbed aluminum have more than this advantage. They can be kept clean, and future equipment will always match. The dull finish is easily obtained by hand rubbing with fine sandpaper, steel wool and soap cleanser in turn.

An accurate computation of costs shows a total of \$74 for all "radio" parts. Ten or fifteen more should be added for the metal and general hardware.

Omitting the silencer would mean a saving of about \$6, and omitting the crystal perhaps \$15 more. We would never recommend omitting the crystal, although the need of a silencer depends on individual location.

At its highest, the parts cost is fairly low, so it may be necessary to sound the warning that the job is not something to be pushed through in a few evenings and a week-end; neither is it some-

<sup>5</sup> The mixer circuit arrangement is rather unusual, in that the No. 1 grid of the 6L7 is signal-biased rather than cathode-biased as in the conventional circuit. Under these conditions the screen voltage must be kept considerably below normal to prevent excessive screen and plate currents. — Editor.

## HOW TO PASS RADIO LICENSE EXAMINATIONS



## Answers YOUR Questions HOW TO PASS Radio License Examinations

By CHARLES E. DREW, I.R.E., A.I.E.E.

This book is more than just a new edition of a famous work. It has been completely rewritten, and will serve as an excellent guide to all radiomen. Important phases of the subject are given thorough treatment, so that the man who understands the content of this book will be well qualified to pass the examination for his commercial license. **\$2.00**

### ON APPROVAL COUPON

John Wiley & Sons, Inc.  
440 Fourth Avenue, New York, N. Y.

Kindly send me a copy of Drew's HOW TO PASS, on ten days' approval. If I decide to keep it, I will remit \$2.00; otherwise I will return the book postpaid.

Name .....

Address .....

City and State .....

Employed by .....

QST 4-39

# Station Operating Supplies

*Designed by A.R.R.L. Communications Department*

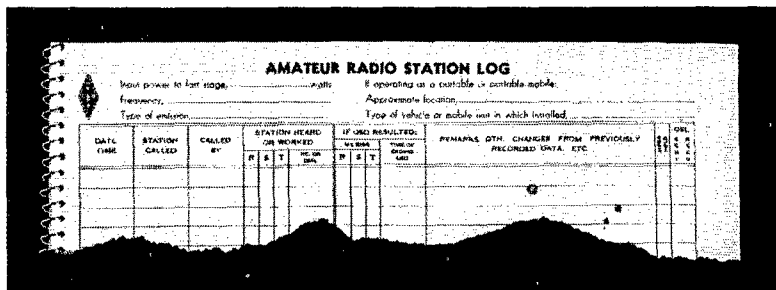

★  
**THE  
 LOG  
 BOOK**  
 ★

As can be seen in the illustration, the log page provides space for all facts pertaining to transmission and reception, and is equally as useful for portable or mobile operation as it is for fixed. The 38 log pages with an equal number of blank pages for notes, six pages of general log information (prefixes, etc.) and a sheet of graph paper are spiral bound, permitting the book to be folded back flat at any page, requiring only the page size of  $8\frac{1}{2} \times 11$  on the operating table. In addition, a number sheet for traffic handlers is included with each book. The LOG BOOK sells for 35c per book or 3 books for \$1.

## OFFICIAL RADIOGRAM PADS

The radiogram blank is now an entirely new form, designed by the Communications Department to comply with the new order of transmission. All blocks for fill-in are properly spaced for use in typewriter. It has a strikingly new heading that you will like. Radiogram blanks,  $8\frac{1}{2} \times 7\frac{1}{4}$ , lithographed in green ink, and padded 100 blanks to the pad, are now priced at 25c per pad, postpaid.

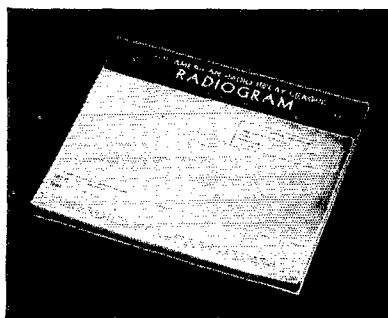

## and MESSAGE DELIVERY CARDS

Radiogram delivery cards embody the same design as the radiogram blank and are



available in two forms — on stamped government postcard, 2c each; unstamped, 1c each.

**AMERICAN RADIO RELAY LEAGUE, Inc.**

**West Hartford, Connecticut**

THE  
**NEW KEYING** *Grid Control*  
**RECTIFIER**



PRICE  
**\$3.00**

Key your rig the modern electronic way with this worthy companion of the famous UNITED 866. Put out a signal that does justice to your list, by eliminating tails and chirps.

FILAMENT . . . 2.5 volts; 5 amps.  
PLATE CURRENT (average) .25 amp.  
PLATE CURRENT (peak) 1.00 amp.

Your dealer has them or we will ship to you

**UNITED ELECTRONICS CO.**  
42 SPRING STREET • NEWARK, NEW JERSEY

**STACO** *Antenna*  
**CHANGE-OVER RELAYS**

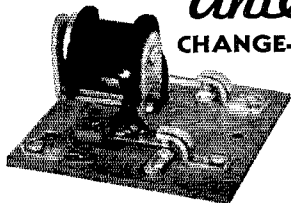

- Mycalex Insulation
- 4 Ampere Contacts
- Ball-Bearing Pivot
- Shorter R.F. Path
- No AC Chatter
- Floating Armature

Type ABA. XPLW Insulation, 110v, AC } **\$3.00 net**  
Type ABD. XPLW Insulation, 6v, DC }  
Type AMA. MYCALEX Insulation, 110v, AC } **\$4.50 net**  
Type AMD. MYCALEX Insulation, 6v, DC }

See Your Jobber or Write for Details

STANDARD ELECTRICAL PRODUCTS COMPANY  
316 Sibley Street St. Paul, Minnesota

**SEND FOR FREE  
ANTENNA BOOKLET**

Over 30 new ideas and diagrams for erection and feeding of Rotary and Vertical Antennas—the first to be published. Ask your jobber or write



**PREMAX PRODUCTS**

DIV. CHISHOLM-RYDER CO., INC.  
3919 HIGHLAND NIAGARA FALLS, N. Y.

thing for a beginner to cut his teeth on. The procedure is to resign yourself to the idea that you will eventually get it done, and plug along. If each stage is tested beforehand, there is no reason to worry that the completed super might not work.

Whether all the time invested is worth while depends on the satisfaction one derives from shop work and from the use of his own equipment. Knowing every inch of his set, the builder will be more able to keep it at peak performance. Then, too, he will not be afraid to dive into it to make an alteration, if that alteration may bring about an improvement.

**A Peak-Limiting Amplifier**

(Continued from page 37)

amplifier can now be increased above the point where compression starts to take place, by 10 or 15 db, and the output from the amplifier will only increase approximately 2 db. The circuit will take care of any unexpected peaks, but too much compression should not be used in normal use as it will result in unnaturalness of speech, if not in actual distortion.

A word about the resistor-condenser combination  $R_{12}-C_9$ . The capacity of the condenser determines the speed with which compression starts to take place, while both the resistance and capacity determine the time it takes for the circuit to return to normal gain, since the condenser must discharge through the resistor. The values shown proved satisfactory in our case, but some cut-and-try might be in order. Some commercial equipment uses as much as  $0.25 \mu\text{fd.}$  or  $0.5 \mu\text{fd.}$  at  $C_9$ , but this proved too slow for our work.

One point to remember is not to work the compressor circuit at too high an audio level. If you use triode tubes following the compressor network, it will probably take at least three stages of amplification to get the proper output.

The peak-limiting circuit described was incorporated in an existing amplifier and added practically no distortion. Tests made with an RCA 68-A beat frequency oscillator and 69-A distortion meter showed the average distortion between 100 and 5000 cycles to be only 4 per cent, and only 6 per cent at 70 and 6500 cycles. These checks were made with from 3 to 4 db compression, and indicate less than 2 per cent increase in distortion with the introduction of the compression. The p.p. 6J7 stage seems to contribute the major portion of the distortion, but no attempt was made to decrease the distortion since the quality sounds quite good on the air.

To sum up the advantages of the amplifier:

- (1) Properly adjusted, it will prevent over-modulation. In fact,  $R_{13}$  can be adjusted for any modulation percentage you desire.
- (2) It will increase the average modulation by at least 3 db and, under some conditions, 5 or 6 db compression could be used. The greater compression will help to over-ride QRM.
- (3) The possibility of arc-overs in the transmitter is reduced by preventing excessive drive to the modulators. This is particularly useful when the margin of safety is quite small.

# Amateurs Service Men

# Here's something you REALLY need!

You need a dual-frequency crystal calibrator! Why? Because it is a flexible, inexpensive device which will enable you to rapidly and accurately calibrate radio receivers, signal generators and amateur monitors or to perform general frequency measurements. In conjunction with your station receiver, it is an excellent frequency monitor. If you are a serviceman, it will mean increased accuracy and greater speed when frequency aligning all-wave receivers.

Certainly you need a dual-frequency calibrator! And you can have such an instrument by obtaining a Bliley SMC100 Dual-Frequency (100kc. and 1000kc.) Crystal Unit. Only a small number of standard parts in a simple circuit will do the trick.

Your Bliley distributor can supply you with the SMC100 Crystal Unit at \$7.75. For constructional details and application notes ask for Bulletin E-7 or consult January, 1939 QST, page 38. Bliley Electric Company, Erie, Pa.

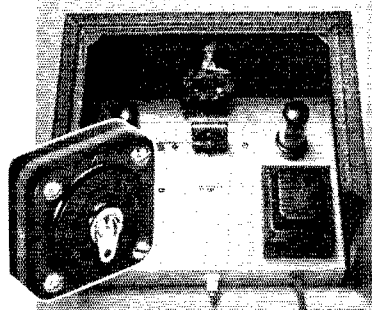

## BLILEY SMC100 CALIBRATOR CRYSTAL UNIT

## Put Him Wise to Pyranol Capacitors, XYL; They'll Give Him No Trouble

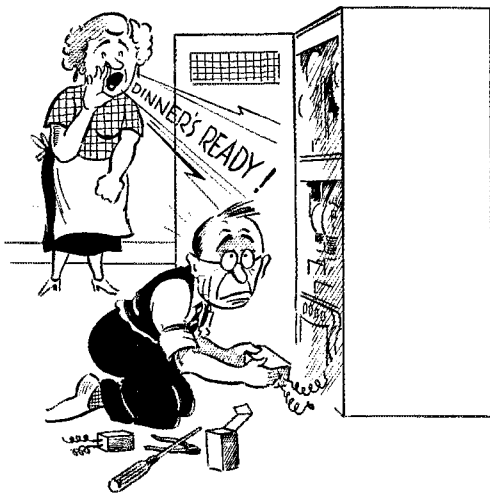

Don't let a bad-acting filter condenser spoil your evenings, O.M. Install a G-E Pyranol capacitor. It will help you put out clear signals and will give you thoroughly dependable performance. Proof is the acceptance of these capacitors by builders of amateur, commercial, and aircraft transmitters throughout the world.

Pyranol capacitor units are unusually small, too. That's because Pyranol, a remarkable liquid dielectric, has exceptionally good dielectric properties. Moreover, it will not burn or explode.

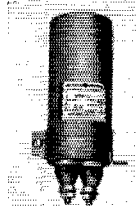

Cylindrical  
Pyranol capacitor

Do you want more information on G-E capacitors? The following publications are available from your dealer or from the Radio Department, General Electric Company, Schenectady, N. Y.

*GEA-2021A and GEA-2818, on rectangular capacitors*

*GEA-3018, on cylindrical capacitors*

*GES-1996, azimuthal projection map of the world (Northeast U.S.A.)*

*GES-1999, azimuthal projection map of the world (West Coast, U.S.A.)*

# GENERAL ELECTRIC

900-19

115

# WANTED — MORE AMATEURS

to know all about a house that caters to the Ham in every respect — NEW ITEMS — NEW IDEAS, together with the type of service and attention that has won us a host of friends and Boosters. All letters given immediate attention.

## SAME DAY DELIVERY

Powerful mounted crystals. X-cut. 40-80-160 Band. 5 k.c. Guaranteed — actually tested in oscillator — complete for. . . . **\$2.29**

## EVERY HAM CAN OWN ONE NOW —

An electric world time clock, three clocks in one. Has everything — Divisions shown for seconds — A.M., P.M., midnight, noon, and G.M.T. Shows authentic time at any zone and can be set for any of 24 zones. Modernistic design of brushed brass. Size 4¾" x 5¼" — 4" face — 110-120 volt A.C. Fully guaranteed and a real ham value. . . . . **\$3.95**

**FREE** — Get our big new 1939 Ham BARGAIN Catalog and large 4½' x 3½' colored Map of U. S. A. — send 5c to cover cost of mailing map. Hundreds of separate items, tubes, parts, receivers illustrated in detail. Send today for this 80-page catalog.

## LOOK OVER OUR LOW FINANCE PLAN ON PARTS, TRANSMITTERS AND RECEIVERS

### SPECIAL DEAL ON PARTS

Amt. of parts	Cash with order	Pay monthly
\$15.00	\$3.00	\$4.30 for 3 mos.
\$25.00	\$5.00	\$4.30 for 5 mos.
\$35.00	\$7.00	\$4.30 for 7 mos.

Write for details on any amount. Our low payment plan is possible as we handle our own finance. WHAT HAVE YOU TO TRADE? — Fair allowances on all equipment and the personal attention of W9GFQ on all sales.

Receiver Model	Cash Price	Down Payment	12 Monthly Payments
New Skyrider 23	\$115.50	\$23.10	\$8.16
HQ120X	\$129.00	\$25.80	\$9.11
RME-70	\$138.60	\$27.72	\$9.79

Also all Hallicrafters, National, Breting, and all makes of Ham transmitters

May we be of service to you?

**WHOLESALE RADIO LABORATORIES**  
746 W. Broadway Council Bluffs, Iowa

## New Tubes

(Continued from page 25)

6SA7 is a pentagrid converter whose characteristics approximate those of the 6A7. The 6SC7 is a twin high- $\mu$  triode designed particularly for phase-inverter circuits. The 12SA7, 12SC7, 12SJ7, 12SK7, 12SQ7 are new 12.6-volt single-end tubes corresponding to similarly numbered tubes in the 6.3-volt series. The 12C8 is a new metal duplex-diode-pentode in the 12.6-volt series.

## New Battery Tubes

Two new tubes in the 1.4-volt series of battery tubes are announced by Kenrad. The 1G4G is a low- $\mu$  triode operating at a plate voltage of 90 and requiring a grid-biasing voltage of 6. It is designed for general audio or Class-B driver service. The 1G6G is a Class-B double triode with an output rating of 450 milliwatts at 90 volts. The filament of the latter has a 100-ma. rating.

## New Special-Purpose Tubes

Types 1620, 1621 and 1622 are special-purpose tubes announced by RCA. The 1620 is a triple-grid metal tube recommended especially for applications requiring very low microphonic and noise response. The physical and electrical characteristics are similar to those of the 6J7.

The 1621 is a power amplifier pentode of the metal type recommended especially for applications where extremely low distortion and continuity of service are of prime importance. It is similar in characteristics to the 6F6.

The 1622 is a beam power amplifier of the metal type intended especially for applications where extremely low distortion and continuity of service are of prime importance. Its characteristics are similar to those of the 6L6.

## New A.C.-D.C.-Mobile Tubes

SYLVANIA has announced a new group of tubes designed particularly for a.c.-d.c. and mobile service. The heaters have a nominal rating of 7 volts although they are designed to operate at any voltage between 6.3 and 7.

The 7A6 is a double diode with separate cathodes, similar to 6H6G. The 7A7 is a single-ended r.f. pentode similar to the 6K7G except that it has a substantially higher mutual conductance. The 7A8 is a converter similar to older pentagrid types except that a suppressor grid is provided. It is of single-end construction. The 7B7 is a single-ended r.f. pentode similar to the 6S7G. The 7C6 is a double triode of single-end construction similar to the 75. Type 7Y4 is a rectifier similar to the Type 84. The 35A5 is a beam-type power amplifier similar to the 25L6 but slightly smaller. The 35Z3 is a half-wave rectifier for use where the 35A5 is used as the output tube. With the exception of the 7A7, which has a rated heater current of 0.3 ampere, these tubes have heater-current ratings of 0.15 ampere. Tubes in this series are fitted with the new "locktal"-type bases.

# MORE NEW GEAR!

## New De Luxe 20-Meter Arrays:

2-element . . . . . **\$73.50**  
 3-element . . . . . **\$96.50**

Also De Luxe 3-Element for 10-Meter Band. ALL THESE USE THE NEW, IMPROVED, SUPER-POWERFUL **ROTATOR**, which is weather-proofed and permanently oiled, is 15" across the base and has 2" drive shaft. All above items in addition to previously announced Signal Squirters. All feature Inductostub; open-wire, non-resonant feed, etc.



## WRITE DIRECT FOR FULL DATA!

SHOWN ABOVE is **Direction Indicator**. Price for use with Signal Squirters is \$24.50. Adaption kit, enabling use with almost any type rotary beam is priced, net, at only

**\$2.80**

*"Put Your Signal Where You Want It When You Want It There"*

**MIMS RADIO CO.**  
**SIGNAL SQUIRTER**  
 PRODUCTS  
 TEXARKANA ARK. TEX.



## ACME VOLTROL . . .

For regulating voltage or testing all electronic functions this new Acme Voltrol offers many advantages. Manually operated. Continuous duty. Complete *stepless* control from 0 to 130 volts. Panel mounting type illustrated especially adapted for radio work. \$12.00. Write for Free Bulletin.

THE ACME ELECTRIC & MANUFACTURING CO.  
 38 Water Street Cuba, N. Y.

## Piezo-Electric Crystals Exclusively

• Quality crystals of all practical frequencies supplied SINCE 1925. Prices quoted upon receipt of your specifications.

Our Pledge: **QUALITY FIRST**  
**SCIENTIFIC RADIO SERVICE**

"The Crystal Specialists Since 1925" University Park, Hyattsville, Md.

## • TELEGRAPHY—TELEVISION—TELEPHONY •

AVIATION  
 TRANS RADIO  
 PRESS  
 TELETYPE  
 TYPEWRITING



PRACTICAL  
 EXPERIENCE  
 STUDIO —  
 TRANSMITTER —  
 ANNOUNCING

The major technical training equipment owned by Port Arthur College and in operation on the college campus consists of the 500-Watt Commercial Broadcast Transmitter of Station KPAC; two-way Television Transmitter and Receiver; Latest Type RCA Marine and Airways transmitter installation complete; SOS Automatic Alarm; Marine Direction Finder; Trans-radio Press Receiving Equipment, and Laboratory complete where students assemble composite transmitters, amplifiers, audio amplifiers, R. F. amplifiers, etc.

Port Arthur College pioneered the teaching of Radio with classes in 1909, and for thirty years has maintained an active Employment Bureau for the placement of its graduates.

*If interested in details about Radio Course, write for Bulletin R*

**PORT ARTHUR COLLEGE ■ PORT ARTHUR (World-Known Port), TEXAS**

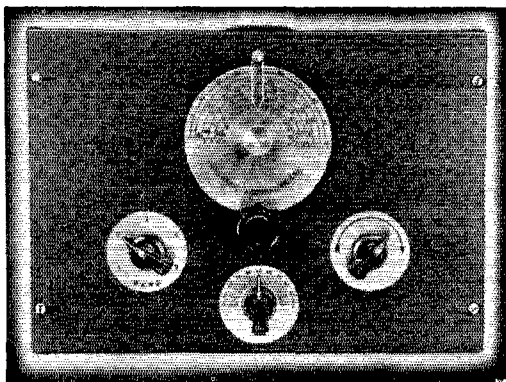

## MORE SIGNAL LESS NOISE!

Positively the last word in Pre-Selection! 5 to 185 meters. Reduces image interference! Uses new 1852 Pentode. 5 Band calibrated dial. Will increase performance of any set. Complete kit with filament transformer \$13.50. Wired and tested \$16.50 (less tube). All good ham jobbers have these units.

Send for free catalog of complete line to

**BROWNING LABORATORIES**  
750 Main Street Winchester, Mass.

★ **THANK YOU . . .** Calcutta, India  
for your F. B. Report of Jan. 30 on your contact with Scotland, England, Egypt, Finland, Belgium, Tibet and U.S.A.

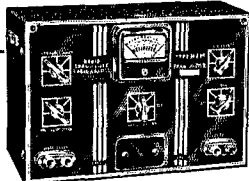

### using our TYPE HFM TRANSMITTER

■ Six Bands 1715 — 60,000 K.C. on two crystals  
■ All Frequencies Crystal Controlled ■ Instantly Changeable Mobile or Portable ■ Final Tube Input 21 to 36 Watts.  
Net to Amateurs . . . \$57.60  
WRITE for bulletins listing complete specifications on our new, APPROVED transmitters, etc.

**RADIO TRANSCEIVER LABS.**  
8627 115 Street Richmond Hill, New York City  
Cable Address: "RATRALAB"

## Genuine Broadcast Quality!

Yours at Low Cost with  
New Balanced Line  
**TURNER DYNAMIC 999**

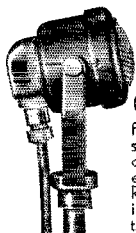

**MODEL 999**  
Positive contact — polarized removable connector with locking ring. 25-ft. cable. Order today.

GET broadcast quality and studio styling with the sensational new 999. Voice and transformer lines balanced to ground for critical installations. Not affected by climate, temperature or rough handling. Built especially for experienced broadcast and public address operators. Range 50-9000 cycles. Level, -56DB. All impedances. Impressive appearance. Get details at once.

Write for Bulletin B-40

**The TURNER Co.**  
CEDAR RAPIDS, IOWA

## ★ A.R.R.L. QSL BUREAU ★

FOR the convenience of its members, the League maintains a QSL-card forwarding system which operates through volunteer "District QSL Managers" in each of the nine United States and five Canadian districts. In order to secure such foreign cards as may be received for you, send your district manager a standard No. 10 stamped envelope. If you have reason to expect a considerable number of cards, put on an extra stamp so that it has a total of six-cents postage. Your own name and address go in the customary place on the face, and your station call should be printed prominently in the upper left-hand corner.

- W1 — J. T. Steiger, W1BGY, 35 Call Street, Willimansett, Mass.  
W2 — H. W. Yahnel, W2SN, Lake Ave., Helmetta, N. J.  
W3 — Maurice Downs, W3WU, 1311 Sheridan St., N. W., Washington, D. C.  
W4 — G. W. Hoke, W4DYB, 328 Mell Ave., N. E., Atlanta, Ga.  
W5 — E. H. Treadaway, W5DKR, 2749 Myrtle St., New Orleans, La.  
W6 — Horace Greer, W6TI, 414 Fairmount Ave., Oakland, Calif.  
W7 — Frank E. Pratt, W7DXZ, 5023 So. Ferry St., Tacoma, Wash.  
W8 — F. W. Allen, W8GER, 324 Richmond Ave., Dayton, Ohio.  
W9 — Alva A. Smith, W9DMA, 238 East Main St., Caledonia, Minn.  
VE1 — L. J. Fader, VE1FQ, 125 Henry St., Halifax, N. S.  
VE2 — C. W. Skarstedt, VE2DR, 236 Elm Ave., Westmount, P. Q.  
VE3 — Bert Knowles, VE3QB, Lanark, Ont.  
VE4 — George Behrends, VE4RO, 186 Oakdean Blvd., St. James, Winnipeg, Manitoba.  
VE5 — H. R. Hough, VE5HR, 1785 First St. Victoria, B. C.  
K4 — F. McCoww, K4RJ, Family Court 7, San-turce, Puerto Rico.  
K5 — Norman F. Miller, K5AF, 15th Air Base Squadron, Albrook Field, Canal Zone.  
K6 — James F. Pa, K6LBH, 1416D Lunalilo St., Honolulu, T. H.  
K7 — Jerry McKinley, K7GSC, Box 1533, Juneau, Alaska.  
KA — George L. Rickard, KA1GR, P. O. Box 849, Manila, P. I.

## Checking Beam Antennas

(Continued from page 28)

obtained directly from Fig. 2. If a power unit value of 1 is given to the minimum signal position, then the maximum signal, which is 30 db up, would represent 1000 times this power, etc.

With these figures completed a detailed report



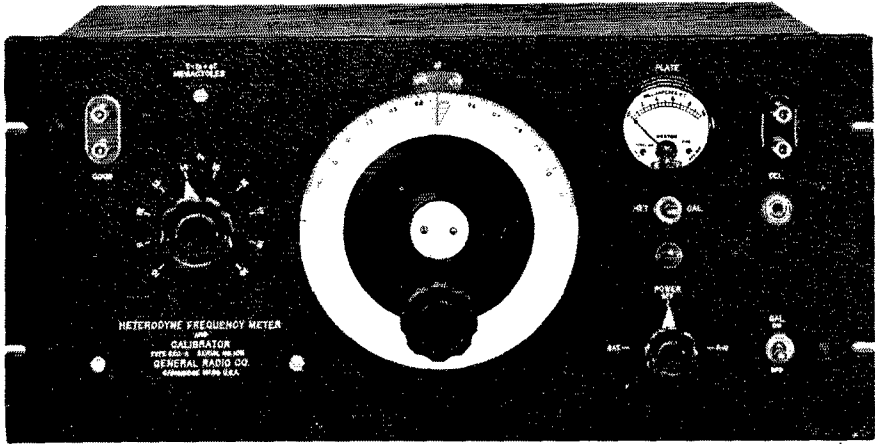

● **HIGH-FREQUENCY MONITORING** with the G-R Type 620-A Heterodyne Frequency Meter and Calibrator is simple. Its range is from 300 kc to 300 Mc. . . accuracy 0.01% . . . direct-reading scale . . . built-in crystal oscillator for checking calibration instantly . . . particularly designed for use in all services operating above 10 Mc. where the transmitter tolerance is 0.02% or better. Price . . . relay-rack model . . . . . **\$490.00**

● WRITE FOR BULLETIN 390 FOR COMPLETE DATA

## GENERAL RADIO COMPANY, CAMBRIDGE, MASS.

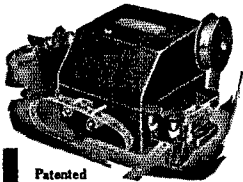

### A Perfected AUTOMATIC SENDER

Patented

Save your fist. Let the Automatic Sender raise your stations for you. Repeats calls or messages indefinitely. Length of messages practically unlimited. Sends from 2 to 70 words a minute. Motor driven. Entirely automatic. Built-in tape perforator. Absolute uniformity in spacing of characters.

Speed up your receiving. Connect Automatic Sender with a buzzer or oscillator. Accustom yourself to receiving any speed you select up to 70 W.P.M. Makes excellent code teacher for novice. Complete with 6 rolls of tape and full instructions. No extra equipment needed. If your dealer can't supply, write us.

FULLY GUARANTEED

Postpaid **\$12.50**  
in U. S. A.

**\$13.50**  
West of  
Denver

**Gardiner-Levering Co.** Haddon Heights  
New Jersey, U. S. A.



**NEW HOLDER DESIGN**  
15 SECONDS TO  
INSTALL CRYSTAL

For All Bands  
**GREATER STABILITY**  
Plugs in 5 prong tube socket

Beautiful Appearance

**MODEL AH HOLDER \$1.00** At your dealer  
or direct

**HIPOWER LOW DRIFT CRYSTALS:**  
within 10 kc. or Choice of stock

AH-10, 1700-3500 Kc. bands \$2.35

AH-10, 7000-7300 " bands 3.90

WRITE FOR NEW LITERATURE

Hipower "Low Drift" Broadcast and Commercial  
Crystals Are Approved by F.C.C.

Hipower Crystal Co., 2035 Charleston St., Chicago

## A GOOD NAME GOES A LONG WAY

Ken-Rad makes a complete line of quality receiving tubes, backed by a continuous record of over 40 years in the manufacture of electric lamps.



# Ken-Rad Radio Tubes

**KEN-RAD TUBE & LAMP CORPORATION - OWENSBORO, KY.**  
Manufacturers of all types of radio tubes and Ken-Rad Electric Lamp Bulbs

## Gross Transmitters for Dependability and Economy

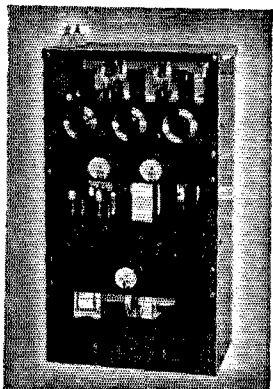

★ Write for free descriptive bulletin on our CB-150 and CB-250 Radiophone Transmitters

### GROSS CB-55 RADIOPHONE TRANSMITTER

FB. for 30 MC. — Input: 95 watts. Uses: 2-T20 tubes in R.F. and 6L6's in modulator. Coils available for 30, 14, 7, 3.5, and 1.7 mc. Descriptive bulletin on request.

**GROSS RADIO, INC.**  
51 Vesey Street New York  
Cable Address: GROSSINC

This is the fourth issue of *QST* for 1939. Can you readily pick up the first three issues? You can if they are kept in a

**QST BINDER PRICED AT \$1.50 POSTPAID**

(Not available outside of the United States and Possessions, and Canada.) One set of yearly labels (1922-1941) now provided with each binder

American Radio Relay League, West Hartford, Connecticut

## AMATEUR RADIO LICENSES

Day and Evening Classes in Code and Theory  
HOME STUDY COURSES

Reasonable, Efficient and Thorough, Hundreds of Licensed Students Now on the Air  
American Radio Institute, 1123 Broadway, New York, N. Y.

**HARD TO BEAT**  
FOR  
value—performance—accuracy  
AND  
stability

A complete line of frequency control units available to choose from. Our catalogue upon request

**THE VALPEY CRYSTALS**

P. O. Box 321

Holliston, Mass.

was given to the owner of the beam by reading off to him the figures of columns 4 and 5. Later, as a matter of interest, the pattern of his beam was drawn up as shown in Fig. 3, using polar graph paper.<sup>2</sup> Lacking this it could have been drawn on plain paper on which a dot is first placed to represent the transmitter and lines drawn radiating from this at angles of  $22\frac{1}{2}$  degrees — like the cuts of a pie that has been divided into 16 pieces.

The scale selected for use depends on the ratios involved. In this case the maximum is 1000 to 1, so the scale used was 200 per inch, making the front lobe 5 inches long. The other values were laid out on each of the lines corresponding to the beam positions and the resulting points were joined together with a line and this made up the pattern of the beam.

Had more readings been taken, perhaps at every 10 degrees, this pattern would have been less angular in appearance and more truly representative, because obviously the actual radiation pattern is not likely to have sharp points such as those shown at the front and back. Even in drawing the present pattern it would have been entirely legitimate to round off the corners; in fact this is usual practice although it is easier to draw as shown in Fig. 3.

Attention has been centered, in this discussion, on the use of the S meter and the data of Figs. 1 and 2 as aids in checking beams. But they have other applications as well. Power gain or loss for different degrees of antenna coupling at the transmitter, and different adjustments of the transmitter or transmitting antenna can be checked in the same way providing the "before and after" readings are made under similar conditions of receiver adjustment, line voltage, etc. The effectiveness of any two fixed transmitting antennas can likewise be determined, especially if they are so arranged that the transmitter can be switched from one to the other quickly. Such comparative checks obtained from several receivers located in different directions from the transmitter will provide helpful information, but the radiation pattern of a fixed directional beam can be determined in this manner only if the antenna used for comparison is non-directional or of known directional characteristics.

In conclusion, it is well to emphasize the fact that measurements such as those described in this article are not perfect. The human element plays an important part, as in accurately reading the meter, determining the exact angle between different positions of a beam, etc. A bad tube in the receiver may alter the meter calibration, but fortunately many of the ailments to which receivers are at times heir, while they may change the reading of the meter for a given signal voltage input, do not materially alter the relationship within the scale itself and therefore do not change the db calibrations given in Fig. 1. In any event, the system outlined represents the most accurate, generally available method of checking and is far superior to the old system of "three S's down," "two S's up" now in common use.

<sup>2</sup> Polar Coördinate paper No. 358-31. Keuffel and Esser, 127 Fulton St., N. Y. C.

# Where to buy it

A directory of suppliers who carry in stock the products of these dependable manufacturers.



ALBANY, N. Y. Uncle Dave's Radio Shack 356 Broadway  
 ATLANTA, GEORGIA 265 Peachtree Street  
 Wholesale Radio Service Co., Inc.  
 BOSTON, MASS. Radio Shack 46 Brattle Street  
 BOSTON, MASS. 110 Federal Street  
 Wholesale Radio Service Company, Inc.  
 BRONX, N. Y. 542 East Fordham Rd.  
 Wholesale Radio Service Company, Inc.  
 BUTLER, MISSOURI 211-215 N. Main Street  
 Henry Radio Shop  
 CHICAGO, ILL. 833 W. Jackson Blvd.  
 Allied Radio Corp.  
 CHICAGO, ILL. 901-911 W. Jackson Blvd.  
 Wholesale Radio Service Company, Inc.  
 CINCINNATI, OHIO 1103 Vine Street  
 United Radio, Inc.  
 COLUMBUS, OHIO 203 N. Fourth St.  
 Bell Radio Parts Co.  
 DETROIT, MICH. 325 E. Jefferson Ave.  
 Radio Specialties Co.  
 DETROIT, MICHIGAN 11800 Woodward Ave.  
 Radio Specialties Co.  
 HARTFORD, CONNECTICUT 227 Asylum Street  
 Radio Inspection Service Company  
 HOUSTON, TEXAS 4021 Huey Street  
 R. C. Hall & L. F. Hall  
 JAMAICA, L. I. 90-08 166th Street  
 Wholesale Radio Service Company, Inc.  
 KANSAS CITY, MO. 1012 McGee Street  
 Burstein-Applebee Company  
 NEW ORLEANS, LA. 902 Poydras Street  
 Shuler Supply Company  
 NEW YORK, N. Y. Harrison Radio Co. 12 West Broadway  
 NEW YORK, N. Y. 100 Sixth Ave.  
 Wholesale Radio Service Co., Inc.  
 NEWARK, N. J. 219 Central Ave.  
 Wholesale Radio Service Co., Inc.  
 OAKLAND, CAL. 2085 Broadway  
 Offenbach's  
 READING, PENN. 404 Walnut St.  
 George D. Barbey Company  
 SACRAMENTO, CAL. 1310 K Street  
 Offenbach's  
 SAN FRANCISCO, CAL. 1452 Market Street  
 Offenbach's  
 SPRINGFIELD, MASS. T. F. Cushing 349 Worthington St.  
 WASHINGTON, D. C. 938 F Street, N. W.  
 Sun Radio & Service Supply Co.

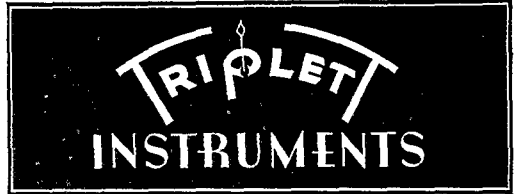

ALBANY, N. Y. Uncle Dave's Radio Shack 356 Broadway  
 ATLANTA, GEORGIA 69 Forsyth Street, N. W.  
 Garvin Electric Company  
 ATLANTA, GEORGIA 265 Peachtree Street  
 Wholesale Radio Service Company  
 BOSTON, MASS. Radio Shack 46 Brattle Street  
 BOSTON, MASS. 110 Federal Street  
 Wholesale Radio Service Company, Inc.  
 BRONX, N. Y. 542 East Fordham Rd.  
 Wholesale Radio Service Company, Inc.  
 BUTLER, MISSOURI 211-215 N. Main Street  
 Henry Radio Shop  
 CHICAGO, ILLINOIS 833 W. Jackson Blvd.  
 Allied Radio Corp.  
 CHICAGO, ILLINOIS 95 North Franklin Street  
 Electric & Radio Supply Co., Inc.  
 CHICAGO, ILL. 901-911 W. Jackson Blvd.  
 Wholesale Radio Service Company, Inc.  
 CINCINNATI, OHIO 1103 Vine Street  
 United Radio, Inc.  
 DALLAS, TEXAS 1905 Commerce Street  
 Southwest Radio Supply  
 JAMAICA, L. I. 90-08 166th Street  
 Wholesale Radio Service Company, Inc.  
 LITTLE ROCK, ARKANSAS 409 W. 3rd St.  
 Beem Radio Company  
 MINNEAPOLIS, MINNESOTA 1124-26 Harmon Place  
 Lew Bonn Company  
 MONTREAL, CANADA 285 Craig Street, West  
 Canadian Electrical Supply Co., Ltd.  
 MUSKOGEE, OKLAHOMA 204 No. Twelfth Street  
 Home Radio Mart  
 NEW ORLEANS, LA. 902 Poydras Street  
 Shuler Supply Company  
 NEW YORK, N. Y. 100 Sixth Avenue  
 Wholesale Radio Service Company  
 NEWARK, N. J. 219 Central Ave.  
 Wholesale Radio Service Company  
 OAKLAND, CAL. 2085 Broadway  
 Offenbach's  
 READING, PENN. George D. Barbey Co. 404 Walnut Street  
 SACRAMENTO, CAL. 1310 K Street  
 Offenbach's  
 SAN FRANCISCO, CAL. 1452 Market Street  
 Offenbach's  
 WASHINGTON, D. C. 938 F Street, N. W.  
 Sun Radio & Service Supply Co.

Listings on this page do not necessarily imply endorsement by QST of the dealers or of other equipment sold by them.

*Want to make a  
Good Investment?*

## **HINTS & KINKS**

*selling at 50c*

Pays big dividends with its money saving ideas for the

WORKSHOP  
RECEIVERS  
TRANSMITTERS  
PHONE UNITS  
KEYING  
MONITORS  
METERS  
POWER SUPPLIES  
ANTENNAS  
UHF

Invest 50c and save dollars

**American Radio Relay League**  
West Hartford, Conn. U. S. A.

## **THE RADIO AMATEUR'S LICENSE MANUAL**

Going after your first ham "ticket"? You need the manual for its instructions on where to apply, how to go about it in the right way — and, most important of all, for the nearly 200 typical license exam questions and answers.

Already licensed? The manual is still necessary for its dope on renewal and modification procedure, the Class A exam (with typical questions and answers), portable procedure, etc.

**ALL the dope on every phase of amateur licensing procedure, and, of course, the complete text of the new regulations and pertinent extracts from the basic radio law.**

*25¢ postpaid*

**THE AMERICAN RADIO RELAY LEAGUE**  
West Hartford, Connecticut

In plotting radiation patterns it should be borne in mind that two patterns plotted on the same beam but by different receivers in different directions will not necessarily be the same. There are numerous factors, such as reflection, absorption, and refraction, which may differ in different directions and different locations. But by obtaining checks from several different stations it is usually possible to strike some sort of average which will not only indicate the characteristics of the beam but may indicate specific faults such as a nearby structure which is affecting its operation.

## ★ **NEW APPARATUS** ★

### *New Keying Device*

**D**ASHES, as well as dots, are formed automatically by the Moto-Key, a new keying device which fits in between the semi-automatic key or "bug" and the fully automatic tape transmitter.

The Moto-Key mechanism includes a 110-volt a.c. induction motor which is geared through suitable speed-changing cones to a spindle carrying two pairs of friction discs. Associated with these discs or clutches are two cams, one for sending dots and spaces and one for sending dashes and spaces. One or the other of these cams is released to revolve by pressing the operating lever to the left or to the right. Either cam will continue to revolve and repeat its proper-length dots or

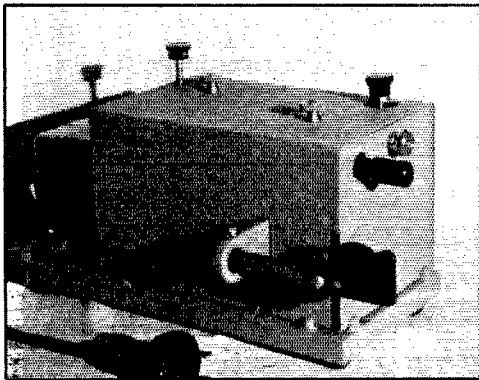

dashes and spaces so long as the lever is held over and will continue to revolve to complete its cycle after the lever has been released. An interlock prevents one cam from releasing until the other has finished its cycle.

It is not necessary to hold the lever over for the entire duration of a dot or dash; an instantaneous contact will release either. The human element enters only in spacing. While it is impossible to run characters together by cutting spaces too short, the space length in other respects must be controlled by the operator. Speed is at an enforced even rate adjustable from approximately 18 to 40 words per minute.

The Moto-Key is manufactured and sold by Howard F. Mason, 2709-4th West, Seattle, Wash.

— D. H. M.

# HAM-ADS

(1) Advertising shall pertain to radio and shall be of nature of interest to radio amateurs or experimenters in their pursuit of the art.

(2) No display of any character will be accepted, nor can any special typographical arrangement, such as all or part capital letters be used which would tend to make one advertisement stand out from the others.

(3) The Ham-Ad rate is 15¢ per word, except as noted in paragraph (6) below.

(4) Remittance in full must accompany copy. No cash or contract discount or agency commission will be allowed.

(5) Closing date for Ham-Ads is the 25th of the second month preceding publication date.

(6) A special rate of 7¢ per word will apply to advertising which, in our judgment, is obviously non-commercial in nature and is placed and signed by a member of the American Radio Relay League. Thus, advertising of bona fide surplus equipment owned, used and for sale by an individual or apparatus offered for exchange or advertising inquiring for special equipment, if by a member of the American Radio Relay League takes the 7¢ rate. An attempt to deal in apparatus in quantity for profit, even if by an individual, is commercial and all advertising by him takes the 15¢ rate. Provisions of paragraphs (1), (2), (4) and (5) apply to all advertising in this column regardless of which rate may apply.

**Having made no investigation of the advertisers in the classified columns, the publishers of QST are unable to vouch for their integrity or for the grade or character of the products advertised.**

QUARTZ — direct importers from Brazil of best quality pure quartz suitable for making piezo-electric crystals. Diamond Drill Carbon Co., 719 World Bldg., New York City.

RADIO engineering, broadcasting, aviation and police radio, servicing, marine and Morse telegraphy taught thoroughly. All expenses low. Catalog free. Dodge's Institute, Byrd St. Valparaiso, Ind.

USED receivers. Bargains. Cash only. No trades. Price list 3¢ W3DQ, Wilmington, Del.

RADIO control — Send stamp for circulars showing latest equipment. Lightweight, reliable, guaranteed to perform. Radio Control Headquarters, Granby, Conn.

QSL'S, all colors, cartoons, snappy service. Write for free samples today. W1BEE, 16 Stockbridge Ave., Lowell, Mass.

CALLBOOKS — Spring edition now on sale containing complete up-to-date list of radio hams throughout entire world. Also world prefix map, press schedules and new time conversion chart. Single copies \$1.25. Canada and foreign \$1.35. Radio Amateur Call Book, 610 S. Dearborn, Chicago.

QSL'S. Cuts. Cartoons. Free samples. Theodore Porcher, 7708 Navahoe, Philadelphia, Pa.

IPS rubber crystal, QSY remotely, varies completely 160 to 10 meters. Approximately 20 watts output, \$19.80. Radio Apparatus Mfg., 1522 No. Clark, Chicago. W91PS.

QSL'S — SWL's. Rainbow effects. Stamp. Fritz, 455 Mason, Joliet, Ill.

CRYSTALS, mounted, 80-160 \$1.25, V-cut 40 \$2.25. R9 Crystals, 338 Murray Ave., Arnold, Pa.

QSL'S. Free samples. Printer, Corwith, Iowa.

MACAUTO code machines: low monthly rental 50,000 words practice tapes. Write N. C. Ayers, 711 Boylston St., Boston, Mass.

QSL cards. Samples. Meador, Box 241, Columbus, Miss.

1000 watt G.E. transformers 1100-2200-4400 volts each side c.t. Guaranteed. \$13.50. Dawson, 5740 Woodrow, Detroit, Mich.

QSL'S, SWL's. 100 — 3 color — 75¢. Lapco, 344 W. 39th, Indianapolis, Ind.

FREEE catalog. Order direct or from dealers. 160-80 meter Y crystals, 75¢. Faberadio, Batavia, Ill.

QSL'S: new, colorful. Samples free. Brownie, W3CJI, 523 No. Tenth St., Allentown, Pa.

GRAFLEX Series II and accessories. Two used WE276A's trade for communications receiver. W5FJU, Norco, La.

SELL: like new SX16, \$85. Also Dural tubing (3 element array). W2LCD.

DANGER high voltage signs, neat, impressive. Two for a dime. Coin only. Gallagher, 700 Franklin St., Elizabeth, N. J.

TRADE \$65. Bausch & Lomb microscope — want a good 10-meter receiver. W9CZG, Gering, Neb.

WANTED: any used general radio equipment. Give description or number. Best price and condition. Also cases off of analysers, etc., meters. Bob Eubank, W3WS, 2817 Montrose Ave., Richmond, Va.

HALLICRAFTERS Marine, practically brand new, perfect tubes. \$52. W5CQS, Dover, Ark.

SELL two hundred fifty watt output telegraph transmitter, Hammarlund Standard Pro, five ten super-regen. receivers, hundred dollars. W3SW.

QSL'S? Samples? (Stamp) Patronize the ham, W8DED, Holland, Mich. (Biley crystal sales.)

SELL: complete 10 to 80 meter transmitter; relay-rack cabinet, engraved, commercial finish; 50 watts phone, suppressor modulated, 160 watts CW; band switching; 4 crystal selector; Amertran audio channel, best parts obtainable throughout; cost over \$400, sell for \$140., freight packing extra. Photos available. W3FIL, 1008 Morgan Ave., Drexel Hill, Pa.

HAVE 100w. — 350w. — 750w. phone transmitters. Want to sell two. Also spare r.f. units, modulators, power supplies, microphones, etc. W9UFD, 3176 So. 13, Omaha, Neb.

PRACTICALLY new 203A, \$5.; 250 ma. 800 volt transformer, \$2.25. W2GMM.

SELL: brand new ACR-111 16 tube single signal super, 200 watt CW transmitter complete. Atlas screw cutting lathes, drill press, Driver jig saw. Cash or terms. W5GNF.

QUARTZ — importers of highest quality tested Brazilian quartz suitable for making piezo-electric crystals. Donald M. Murray Co., 18 Pearl St., New York City.

BE wise — economize. Use the new improved more flexible Douglas Universal modulation transformers. Others may imitate, but Douglas leads. 50 watts audio, \$4.95 pair; 100 watts audio, \$7.75 pair postpaid in U. S. One year guarantee. Write W9IXR, Rice Lake, Wis.

HYVAC midget tubes only 5/8" diameter — screen grid. \$1.50; triode, \$1. Used in Wearable hearing aids, radio controlled miniature airplanes, boats, etc. Single Brush crystal phone less cord, \$2. Write for surplus parts list. All new and guaranteed. Audio Development Co., Minneapolis, Minn.

ULTRA Skyrider model S10 with crystal 1937 model, ten tubes, 5.6 to 79.5 megacycles in four bands, completely realigned on oscillograph, used very little, \$40. E. A. Turner, 188 Lovell Rd., Watertown, Mass.

QSL'S. W8BZK, Newark, Ohio.

SKYRIDER: SX11 will trade for xmmitter, CW or phone. J. Frank Helton, 3524 Lee Blvd., Arlington, Va.

HAMS like pictures. Send photo stamps on your QSL's made from your favorite photograph. \$1. for 100. U. S. Ultra Service, 27A, Upper Sandusky, Ohio.

BUY: Candler System advanced course. C. Gumley, Box 44, Florence, Ky.

QSL cards a specialty. Deluxe Print Shop, 9602 Holton Ave., Cleveland, Ohio, or W8AKY.

RME receiver, speaker, tubes. A-1 condition, at less than half new price. Gerst, 3539 Broadview, Cleveland, Ohio.

SELL: one pair good condition RK-20's, \$6.; one slightly used 100TE, \$10. W8OAA.

WANTED to buy a good medium power transmitter receiver and frequency measuring equipment for complete station. Describe fully; quote price in first letter. Lloyd Watson, Moultrie, Ga.

WANTED: used communications superhet. W2GYA.

KEEP license like new with unique holder. Both sides visible thru glass. Add distinction to shack or carry in pocket. \$1. net. W8YFG, 1197 E. 112 St., Cleveland, Ohio.

SELL W8MAH complete station. For description write W2AVK.

EXCELLENT used transmitters, receivers, meters, etc. QST complete 1930-1937. Trade for photographic equipment. Write for list. Glassford, W2EQK, 12 Beekman Place, N. Y.

WANTED: direct current generator for plate supply. Write to William Hassing, W9FAJ, Jackson, Minn.

QSL'S. Finest at lowest prices. Samples. Maleco, 1805 St. Johns Place, Brooklyn, N. Y.

10 meters easy, with Harvey transmitters and Howard receivers. Trades. Paul Cooper, Sank, Mo.

CRYSTALS in holders: 40X, \$1.60; 160-80M, \$1.25; C.O.D.'s accepted. Pacific Labs., 344 Fetterly, Los Angeles.

SELL or trade 300' 3/8" commercial coaxial. W6MLY, San Mateo, Calif.

QSL'S as you want them. Radio Printer, Union, N. Y.

SALE: 150 w. phone transmitter complete. High quality. Also Thordarson dual power supply. Bargains. W3FTC.

**CRYSTALS:** airmailed; 160-80AT, 40X, \$1.95. 40M lo-drift, \$2.75. 100 kc. bars, 80M vari-frequency and 20M crystals mounted, \$4.50. Large stock. C.O.D.'s accepted. Commercial crystals quoted. C-W Mfg. Co., 1170 Esperanza, Los Angeles.

**SELL:** pair used 204A's, \$10. each. Wanted: old 35mm. sound movie film. W8KZ, 531 Cambridge, Buffalo.

**HAMMARLUND Super-Pro**—SP110SX new condition. practically unused, \$165. cash—no trades. Dr. Stauch, Kiefer Hospital, Detroit.

**TRANSMITTER** 275 watts push-pull TZ40's. Brand new. Wired and tested. Less power. \$50. W3ARR.

**ROTARY** central. Motor driven heads as low as \$15. Alu-malloy beam elements, verticals. Selsynchronous direction indicators, no stops, no gaps. Tilting heads, Bassett cable, elements, drives. Rotary Array Service, W8ML.

**SERVICE** men. Write for Service Man list. Orders prepaid. Special discounts. Amateur headquarters. Write for Amateur list. Remember, I sell all lines of transmitting equipment. Write to Southern Ohio's only amateur owned amateur business. Jos. N. Davies, W8ANT, 2767 No. Bend Rd., Sta. A., Cincinnati, Ohio.

**LISTEN** for high frequency broadcast station W9XA, 26,450 kilocycles, Kansas City. Programs of interest to short wave listeners and radio amateurs.

**CRYSTALS**—unconditionally guaranteed, X-cut, 1750-2000; 3500-4000; = 20 kc., \$1.; = 5 kc., \$1.50; spot frequency, \$2.50. Three small, X-cut, 80 meter blanks, including carborundum \$1.45. Holders, \$1. William Threm, W8FN, 3071 Moosewood St., Cincinnati, Ohio.

**QSL'S**—printed day order received. Samples. W5GG, Cleveland, Miss.

**YOUR** call, monogram, handle, spun in chain tieclip. Gold filled. On pearl brooch for ladies. One dollar. W9SZB.

**CREL** products. A new line of high quality economical transmitting units. Send for catalog describing exciters, r.f. amplifiers, power supplies, Class B amplifiers. Start with foundation unit and add later. Nothing to become obsolete. Lifetime quality. Cincinnati Radio Engineering Labs., Box 2, Sta. A, Cincinnati, Ohio.

**FOR** sale—one used Jenkins-Adair No. FR-6 condenser microphone. Good condition. J. F. Hewson, Standard Oil Co., 910 So. Michigan Ave., Chicago, Ill.

**PAIR RK20's**, used 50 hours, \$10. Want receiver. W4CRO, Box 339, No. Miami, Fla.

**CRYSTAL** buyers, bear in mind, when you buy an Eidson T9 crystal you get a uniform high quality product absolutely guaranteed. We sell no seconds at any price. Thousands of repeat orders and unsolicited testimonials tell the true story—more good crystals for less money. 40 and 80 meter bands or 7300-7500 kc. range, \$1.60 postpaid. Improved T9 ceramic holders, \$1. C.O.D.'s accepted. Send for commercial crystal folder if interested. These and other reputable dealers sell and vouch for T9 crystals: Frank Anzalone, 375 W. 46th St., N. Y. C.; Henry Radio Shop, Butler, Mo.; Pemberton Labs., Ft. Wayne, Ind.; Espy's, 2223 State St., New Orleans, La.; Hieronymus Radio, 88-34 209th St., Queens Village, N. Y.; The Hargis Co., Austin, Texas; Casa Edison, Havana, Cuba; Hamrad Wholesale, Kensington, London, England and Eidson's, Temple, Texas.

**FOR** sale: 150 watt phone and CW transmitter. Rack and panel job. Complete with power supply, tubes and xtal. \$85. cash. Astatic D-104 new, \$8. W9JIR, Glenn E. Webster, 6535 No. Artesian Ave., Chicago.

**BARGAINS:** reconditioned guaranteed amateur receivers shipped on ten-day trial. Practically all models at big savings. Terms. List free. Write. W9ARA, Butler, Mo.

**P. R.** crystals X 40, \$1.85; 80, \$1.65; low-drift 40—80, \$2.20; 160, \$1.65. Complete stock—immediate shipment. Wholesale Radio Labs., Council Bluffs, Iowa.

**COMPACT** portable 56 mc. superhet and xtal transmitter, \$55. SW3 power and speaker, \$18. 30 watt rack panel modulator, \$30. 1 kw. power transformer rack panel, \$18. W8GWA.

**SACRIFICE:** 204A's, \$60. 217C's, meters, used equipment. Write for list. W9EUL, La Grange, Ill.

**SELL:** pair 150T tubes, \$8. each; pair RK20's at \$5. each, all guaranteed first class. W9UM, Lake Wauwesa, Ind.

350 watt phone, CW T55's final 10, 20, 40 coils & xtals cabinet. Complete—\$350. W3GXX.

**RECEIVER** Hallcrafters SX17, tubes, xtal, less speaker. Used five months. Cost \$137.50. Guaranteed perfect. Price \$87.50 cash. Buying Super Pro. E. C. Atkinson, c/o Underwood, Elliott, Fisher, 2019 First Ave., No., Birmingham, Ala.

**YOUR** call in 2 1/4" aluminum letters mounted for studio use or license plate—\$1. each; \$1.50 ordered together. E. Bailey, W. Newton, Pa.

**BARGAIN:** Comet Pro, xtal, A.V.C., 10 and broadcast coils—Hammarlund cabinet speaker. Complete, \$50.; hardly used. William Goodell, 132 E. 5th Ave., Roselle, N. J.

**CHICAGO** area hams. Custom built 42-802-803 phone CW 160 to 20 meters, \$150. f.o.b. Glen Ellyn, Ill. 100X excellent condition. \$90. Write W9KJY, Box 1, West Hartford, Conn.

**QSL'S.** Latest designs at moderate cost. W2FJE, 101 Hanson Place, Brooklyn, N. Y.

**TELEPLEXES,** Instructographs, omnigraphs bought, sold. Ryan's, Hannibal, Mo.

**BARGAINS:** 6-8VDC DPDT relays, 10 amp contacts, \$1. postpaid in U. S. A. Tapped rheostats 1.5—4—6—10 ohms, 2 1/2 amps with switch, 25¢ each. Dymac, W8RRL, 216 E. Genesee St., Buffalo, N. Y.



• There's  
**Another Man**  
waiting  
for YOUR Job!

It's your job today—to train  
for a Better job tomorrow!

● The radio industry is crammed with "pretty good" men . . . that's why your boss can afford to be "choosy" in selecting men for better jobs. The good men always get the good jobs. If you're thinking of tomorrow instead of today, you'll get busy and safeguard your future in Radio, by *training now*. Equip yourself to be ready for the better jobs and higher salaries that await the man with modern technical training. We can train you at home in your spare time like we are doing for so many other ambitious men. Our story is vital to your future—send for complete details today!

"A Tested Plan for a Future in  
PRACTICAL RADIO ENGINEERING"

Write for your Free Copy

48-page illustrated booklet will show you how CREL men get better jobs. It's worth reading

**CAPITOL RADIO**  
ENGINEERING INSTITUTE

Dept. Q-4

3224 16th St., N. W., Wash., D. C.

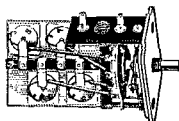

### 8 CRYSTALS

(40, 80, or 160) plus the switch, wiring and fuse lamp, all in one compact unit. Completely enclosed by shield; single hole mounting; electrically correct. Real economy for users of "unmounted" crystals.

P8 Holder (less crystals and lamp) \$5.25 net, at your dealer. Kelvin Apparatus Co., 4248 Fullerton Ave., Chicago

## EASY TO LEARN CODE

It is easy and pleasant work to learn the modern way— with an **Instructograph Code Teacher**. Ideal for the beginner or advanced student. Many tapes available ranging from alphabet for beginners to typical messages on all subjects. Speed range 5 to 40 WPM. Always ready, no QRM, beats having someone send to you.

### FOR SALE OR RENT

**STANDARD** with 10 tapes and book of instructions . . . \$20.25

**JUNIOR** with 5 tapes and book of instructions (not rented) . . . \$12.00

**RENTAL** Standard with 10 tapes and book of instructions \$3.00 first month, \$2.25 each additional month. (Deposit or references required.)

Write for details today

## INSTRUCTOGRAPH COMPANY

Dept. Q-4, 912 Lakeside Place, Chicago, Illinois

Representatives for Canada:

Radio College of Canada, 863 Bay Street, Toronto



# Your Nearest Dealer Is Your Best Friend

Your nearest dealer is entitled to your patronage. You can trust him. He is equipped with a knowledge and understanding of amateur radio. He is your logical and safe source of advice and counsel on what equipment you should buy. His stock is complete. He can supply your needs without delay. His prices are fair and consistent with the high quality of the goods he carries. He is responsible to you and interested in you.

Patronize the dealer nearest you—You can have confidence in him

## ATLANTA, GEORGIA

Wholesale Radio Service Company, Inc.  
265 Peachtree Street  
"The World's Largest Radio Supply House"

## NEWARK, N. J.

Wholesale Radio Service Company, Inc.  
219 Central Avenue  
"The World's Largest Radio Supply House"

## BALTIMORE, MARYLAND

Radio Electric Service Co.  
3 N. Howard St.  
Everything for the amateur

## NEW HAVEN, CONNECTICUT

Hatry & Young, Inc.  
86 Meadow Street  
National, Taylor, Triplett, Radiotron, RME, Howard, etc.

## BOSTON, MASS.

Wholesale Radio Service Company, Inc.  
110 Federal Street  
"The World's Largest Radio Supply House"

## NEW YORK, N. Y.

Wholesale Radio Service Company, Inc.  
100 Sixth Avenue  
"The World's Largest Radio Supply House"

## BRIDGEPORT, CONNECTICUT

Hatry & Young, Inc.  
177 Cannon Street  
Time Payments On All Types Of Equipment

## NEW YORK, N. Y.

Harrison Radio Company  
12 West Broadway  
Harrison Has It! Phone WOrth 2-6276 for information or rush service

## BRONX, NEW YORK

Wholesale Radio Service Company, Inc.  
542 East Fordham Road  
"The World's Largest Radio Supply House"

## PHILADELPHIA, PENNSYLVANIA

Eugene G. Wile  
10 S. Tenth Street  
Complete Stock of Quality Merchandise

## BUFFALO, NEW YORK

Radio Equipment Corp.  
326 Elm Street  
W8PMC and W8NEL — Ham, service and sound equipment

## RICHMOND, VIRGINIA

The Arnold Company  
Broad at Harrison St.  
W3EQQ — "The Virginia Ham Headquarters" — W3FBL

## HARTFORD, CONNECTICUT

Hatry & Young, Inc.  
203 Ann Street  
Trade Your Old Communication Receiver

## ROCHESTER, NEW YORK

Radio Parts & Equipment Co.  
244 Clinton Avenue, North  
Complete stock amateur-BCL parts. Standard discounts

## JAMAICA, L. I., NEW YORK

Wholesale Radio Service Company, Inc.  
90-08 166th Street (Merrick Road)  
"The World's Largest Radio Supply House"

## TORONTO, CANADA

A & A Radio Service Supply  
101 Queen Street, West  
Canada's Foremost Radio Supply House

## MONTREAL, CANADA

Canadian Elec. Supply Co., Ltd.  
285 Craig St., W.  
Quality parts and equipment for discriminating buyers

## WINNIPEG, CANADA

Electrical Supplies, Ltd.  
306-10 Ross Avenue  
Western Canadian Amateur Headquarters for Leading Lines

YOU ARE PROTECTED  
WHEN YOU BUY FROM

**QST**

ADVERTISERS

“Advertising for *QST* is accepted only from firms who, in the publisher’s opinion, are of established integrity and whose products secure the approval of the technical staff of the American Radio Relay League.”

*Quoted from QST’s advertising rate card.*

*Every conceivable need of a radio amateur can be supplied by the advertisers in QST. And you will know the product has the approval of the League’s technical staff*

*The Advertisers*

Acme Electric & Mfg. Company, The	117
Aerovox Corp.	112
American Radio Institute	120
Astatic Microphone Laboratory, Inc.	91
Barker & Williamson	100
Bitley Electric Company	115
Brazilian Trading Company	98
Browning Laboratories, Inc.	118
Candler System Company	102
Capitol Radio Engineering Institute	124
Cardwell Mfg. Corp., Allen D.	106
Centralab	5
Collins Radio Company	Cov. 2
Cornell-Dubilier Electric Corp.	96
Dodge’s Institute	96
Eitel-McCullough, Inc.	107
Gardiner-Levering Company	119
General Electric Company	115
General Radio Company	119
Gross Radio, Inc.	120
Hallicrafters, Inc., The	1, 2, 81, 83, 85
Hammarlund Mfg. Company, Inc.	75, 99
Harvey Radio Laboratories	86
Heintz & Kaufman, Ltd.	84
Hipower Crystal Company	119
Howard Radio Company	101
Hytronic Laboratories	82
Instructograph Company	124
International Resistance Company	74
Jensen Radio Mfg. Company	95
Kelvin Apparatus Company	124
Ken-Rad Tube & Lamp Corp.	119
Kenyon Transformer Company, Inc.	7
Mallory & Company, Inc., P. R.	72
Massachusetts Radio School	102
Messner Mfg. Company, Inc.	87
Mims Radio Company	117
National Company, Inc.	Cov. 3, 71, 79
Newark Electric Company	111
Ohmite Mfg. Company	94
Onan & Sons, D. W.	102
Port Arthur College	117
Precision Apparatus Company	80
Precision Piezo Service	100
Premax Products	114
RCA Institutes, Inc.	Cov. 4, 110
RCA Mfg. Company, Inc.	127
Radio Mfg. Engineers, Inc.	113
Radio Shack, The	118
Radio Transceiver Laboratories	73
Raytheon Production Corp.	110
Rek-O-Kut Corp.	117
Scientific Radio Service	100
Sickles Company, F. W.	78
Simpson Electric Company	98
Solar Mfg. Corp.	93
Speer Carbon Company	114
Standard Electrical Products Company	116
Sun Radio Company	89
Taylor Tubes, Inc.	94
Teleplex Company	77
Thordarson Electric Mfg. Company	96
Tibbets Laboratories	76
Triplet Elec. Instrument Company, Inc.	118
Turner Company	114
United Electronics Company	128
United Transformer Corp.	97
Utah Radio Products Company	120
Valpey Crystals, The	88
Verti-flex Division	98
Vibroplex Company, Inc., The	116
Wholesale Radio Laboratories	112
Wiley & Sons, Inc., John	72
Yaxley	92



# R M E

## INSIDE FACTS

(THE THIRD of a SERIES)

**TIME WILL TELL** whether the investment you made in the choice of your receiver was a good one. Only **TIME** knows the answer since you are on the outside looking in and taking the word of the manufacturer, the dealer, and the salesman for the statements made when you first exchange dollars for receiving equipment. We can assure you that you will be dollars ahead if you also investigate an RME receiver.

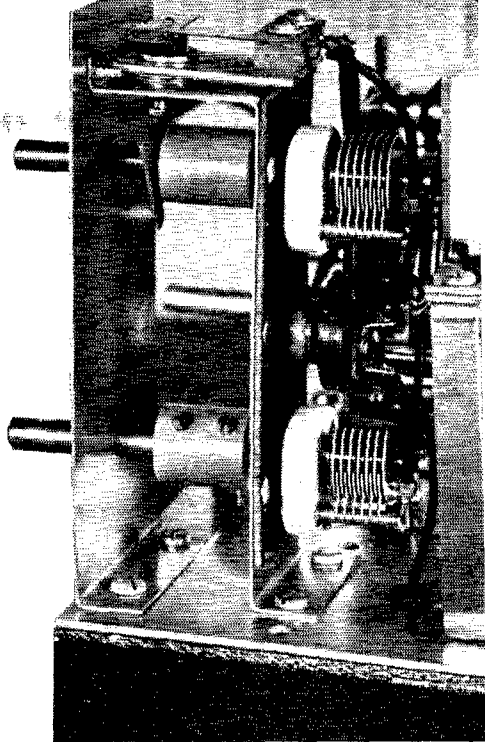

**"COMBINING VARIABLE SELECTIVITY AND VARIABLE REJECTION"**

When the variable phasing feature was incorporated in the crystal filter circuit of an RME, some fourteen months ago, the previously used series — parallel — crystal device was replaced. Through the introduction of a variable condenser (top unit in photo) it is now possible to control crystal anti-resonance over several kilocycles above and below the actual series resonant frequency. Any interfering signal coming in can thus be rejected very effectively when in the vicinity of the desired signal.

The variable selectivity feature is still considered very important in any communication receiver.

The variable condenser (lower unit in photo) is shunted across the secondary of the first I.F. transformer and serves to alter the reactance component at this point in the circuit. Being able to shift smoothly from low to high impedance gives the operator a selectivity control very advantageous when working DX.

You will do well to check up on the above operating principles regarding the crystal filter circuit by referring to your 1939 Radio Amateur's Handbook, page 130. *Variable phasing and variable selectivity* crystal circuits are considered essential features in a good communication receiver today.

**RADIO MFG. ENGINEERS, INC., PEORIA, ILLINOIS**

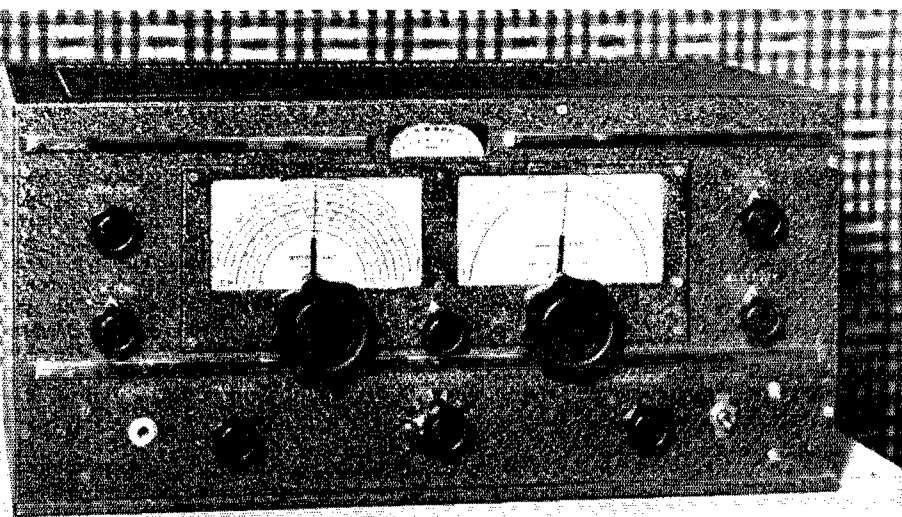



# to Commercial Standards...

The new UTC PA power transformers and chokes have been designed to commercial standards and A.I.E.E. specifications.

## NEW POWER SUPPLY COMPONENTS

These transformers and reactors are designed for temperature rise less than 55 degrees C., and are tested for breakdown on all windings at twice working voltage plus 1,000 volts. In addition, plate transformers are given a surge test at 2½ times normal applied voltage using a 500-cycle supply.

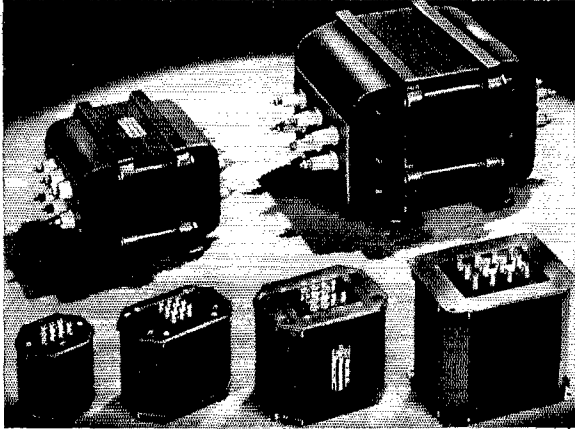

## HIGH POWER PLATE TRANSFORMERS

Primaries for 105, 115, 220, 230 volts, 50/60 cycles. For reduced power secondary voltages can be reduced to half by using 220V. Pri. on 110 volts. These transformers may be used on 35 to 45 cycles if 220V. Pri. is used on 110 volts.

Type No.	High Voltage	D.C. Voltage	D.C. MA	Case No.	Net Price
PA-300	625-515-0-515-625	500/400	200	PA-3	\$ 6.00
PA-301	580-530-300-0-300-530-580	475/425/230	300	PA-4	8.40
PA-302	950-750-0-750-950	760/610	325	PA-4	19.20

Type No.	High Voltage	D.C. Voltage	D.C. MA	L	W	H	Wt. lbs.	Net Price
PA-303	1500-1235-400-0-400-1235-1500	1250/1000/300	300	175	8	7 1/4	5 1/2	32 \$15.00
PA-304	1500-1235-0-1235-1500	1250/1000	800	14	11	9 1/4	11 1/2	39.00
PA-305	2400-1750-0-1750-2400	2060/1500	300	10	7 1/4	5 1/2	50	21.00
PA-306	2400-1750-0-1750-2400	2000/1500	300	14	11	9 1/4	120	39.00
PA-307	3500-3000-2400-0-2400-3000-3500	3050/2500/2000	300	13	11	9 1/4	110	36.00
PA-308	3500-3000-2400-0-2400-3000-3500	3000/2500/2000	500	15	11	9 1/4	140	51.00
PA-309	3500-3000-2400-0-2400-3000-3500	3000/2500/2000	1000	17	14	11 1/4	210	81.00
PA-310	4600-4050-3500-0-3500-4050-4600	4000/3500/3000	600	15	14	11 1/4	168	63.00
PA-311	1500-1235-0-1235-1500	1250/1000	500	10	7 1/4	5 1/2	50	21.00

## VARITRAN VOLTAGE CONTROL UNITS

The UTC VARITRAN makes possible continuously variable output voltage from 0-130 volts.

Standard units are designed for 115 volts input.

Type No.	Watts Rating	Max. Amps.	Dimensions	Weight Lbs.	Net Price
V-1	570	5	7 1/4 x 6 x 4	14	\$10.00
V-2	570	5	7 x 5 x 4	13	9.00
V-3	850	7.5	8 x 8 x 6	20	14.00
V-4	1,250	11	10 x 10 x 7	35	20.00
V-5	2,000	17.5	10 x 10 x 8 1/2	45	32.00

Licensed under U. S. Patent No. 2009013

### FEATURES

- ★ Smooth control
- ★ High efficiency
- ★ Excellent regulation
- ★ Low cost

### APPLICATIONS

- ★ Motor control
- ★ Heat control
- ★ Rectifier control
- ★ Light control
- ★ Line voltage control

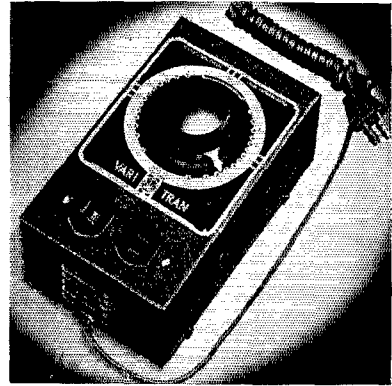

## VARI-POWER AUTO-FORMERS

Designed for line voltage control, filament voltage control and reduced power operation. Varipower units permit control of filament voltage at the tube socket to within 2 1/2% of desired value simultaneously with line voltage control and plate voltage control. Taps at 25, 55, 75, 95, 100, 105, 110, 115, 120, 125 and 130 volts permit output voltages from 0 to 130 volts in 5 volt steps.

Type No.	Watts Output	Dimensions	Weight Lbs.	Net Price
VA-1	150	4 3/4 x 3 1/4 x 3 1/2	6	\$ 3.60
VA-2	250	4 3/4 x 4 1/2 x 3 1/2	9	4.50
VA-3	500	5 1/2 x 4 1/2 x 4	11	6.00
VA-4	1000	5 1/2 x 6 x 4	19	9.00
VA-5	2000	7 x 6 x 5 1/4	25	12.00

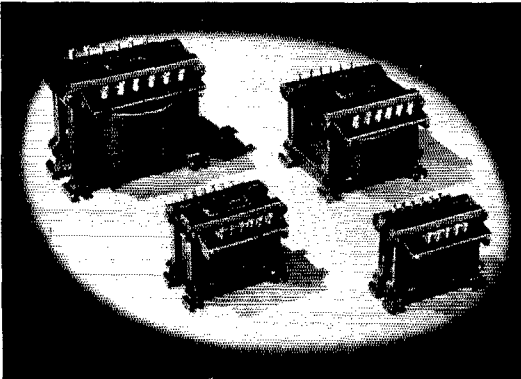

# UNITED TRANSFORMER CORP.

Write: COMMUNICATIONS DIV. ★ 150 VARICK ST. ★ NEW YORK, N. Y.  
 EXPORT DIVISION: 100 VARICK STREET NEW YORK, N. Y. CABLES: "ARLAB"

QST for April, 1939, SOUTHERN Edition

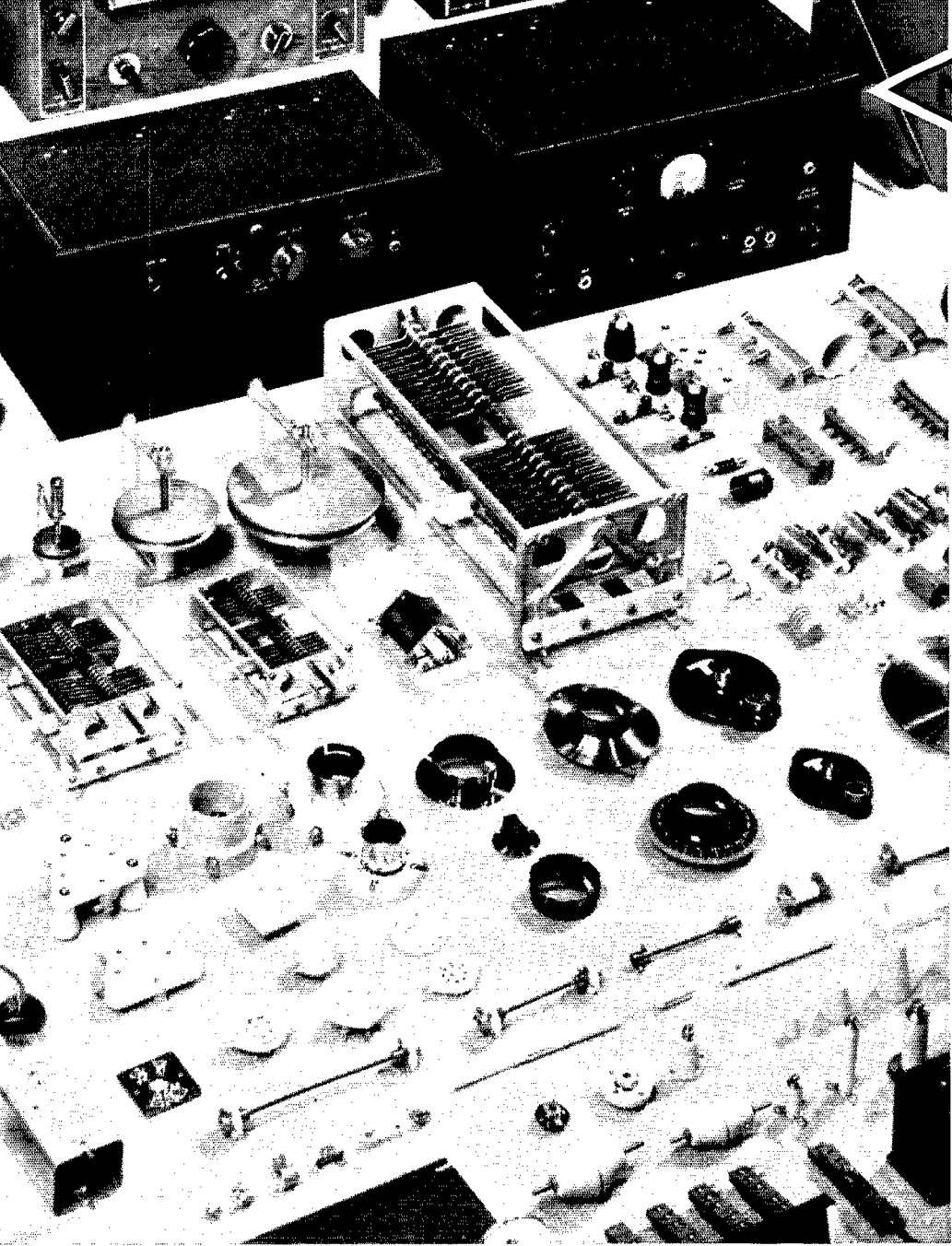

# NATIONAL PARTS

National makes a complete line of parts for amateur use, ranging from acorn tube sockets to complete transmitters. Right down the line, every item is designed to meet amateurs' needs dependably, conveniently and at low cost. And equally important, it has the versatility that makes each purchase a long term investment. Look them over at your dealer's.

# RCA Beam Power Tubes Give You LOWER DRIVING POWER PER WATT OUTPUT

## OUTSTANDING PERFORMANCE AT LOW COST!

Compare these RCA Transmitting Beam Power Amplifiers against all others for low driving power in relation to high output power. You'll find their power sensitivity cannot be matched. Offering you unusual versatility of application and high circuit efficiency, these RCA transmitting tubes are noted for their modern design, rugged construction, uniform characteristics, reliable performance, and long life.



**RCA-813** ... A real "r-f factory" ... 260 watts output at 2000 volts with less than 1 watt of driving power... Makes high-power band-switching transmitters easy... Delivers 150 watts as a crystal oscillator for c.w. and 100 watts plate-modulated... No neutralization. *Amateur net* **\$28.50**

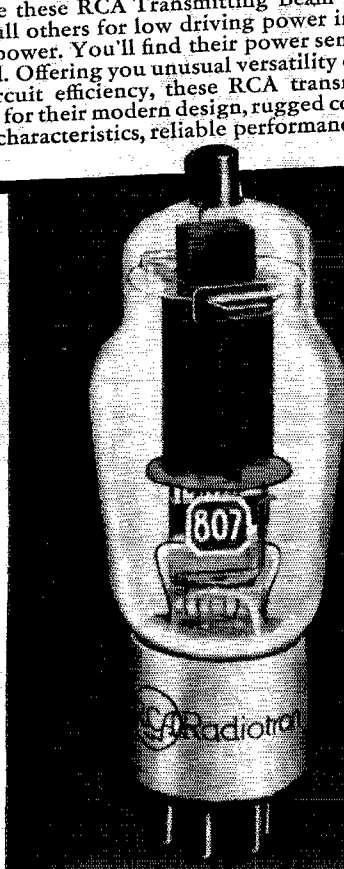

**RCA-807** ... The multi-purpose tube ... Your logical choice for crystal-oscillator, buffer, doubler, and low-power final amplifier stages ... Two 807's in push-pull provide 75 watts output at 600 volts with less than 1/2 watt of driving power... No neutralization required up to 30 Mc. *Amateur net* **\$3.50**



**RCA-814** ... Delivers 130 watts output at 1250 volts with only 1 1/2 watts driving power... A medium-power final amplifier or drive a one-kilowatt stage... Simplifies exit unit design for band switching... away with neutralization problems. *Amateur net* **\$17.50**

RCA presents Magic Key Sundays, 2 to 3 p.m., E.S.T., on NBC Blue Network • For Full Details about these Tubes, Write to the Address Below



# Radio Tubes

FIRST IN METAL  
FOREMOST IN GLASS  
FINEST IN PERFORMANCE

RCA Manufacturing Co., Inc., Camden, N. J. • A Service of the Radio Corporation of America