

QST

devoted entirely to

amateur radio



may, 1939

25 cents

— TWENTY-FIVE YEARS OF, BY AND FOR THE RADIO AMATEUR — 1939

Collins Autotune* Sets Records

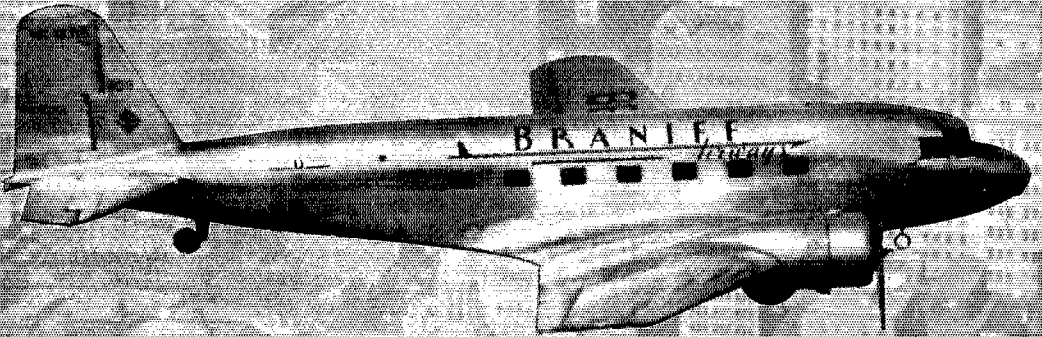

Braniff Airways, operating a fleet of Douglas and Lockheed transports throughout the great Southwest, uses the Collins 17D Autotune, 100 watt, 10 frequency Transmitter in all ships. Ten 17D's have been in constant service for two years and ten new 17D's have just been delivered to take care of increased operations.

The 17D is

- the first high powered transport transmitter.
- the first 10 frequency aircraft transmitter.
- the first 100 watt set to receive CAA approval.
- the first modern aircraft transmitter to be proved out during millions of miles of flying.

*Autotune—The exclusive Collins device used on aircraft and ground transmitters to accomplish quick automatic frequency shift with absolute reliability.

COLLINS RADIO COMPANY

CEDAR RAPIDS, IOWA

NEW YORK, N. Y. 11 WEST 42 ST.

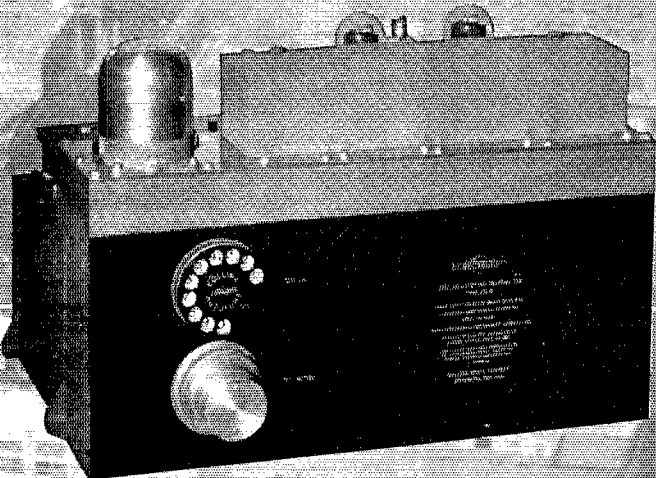

110,000 MILES IN 1½ HOURS!

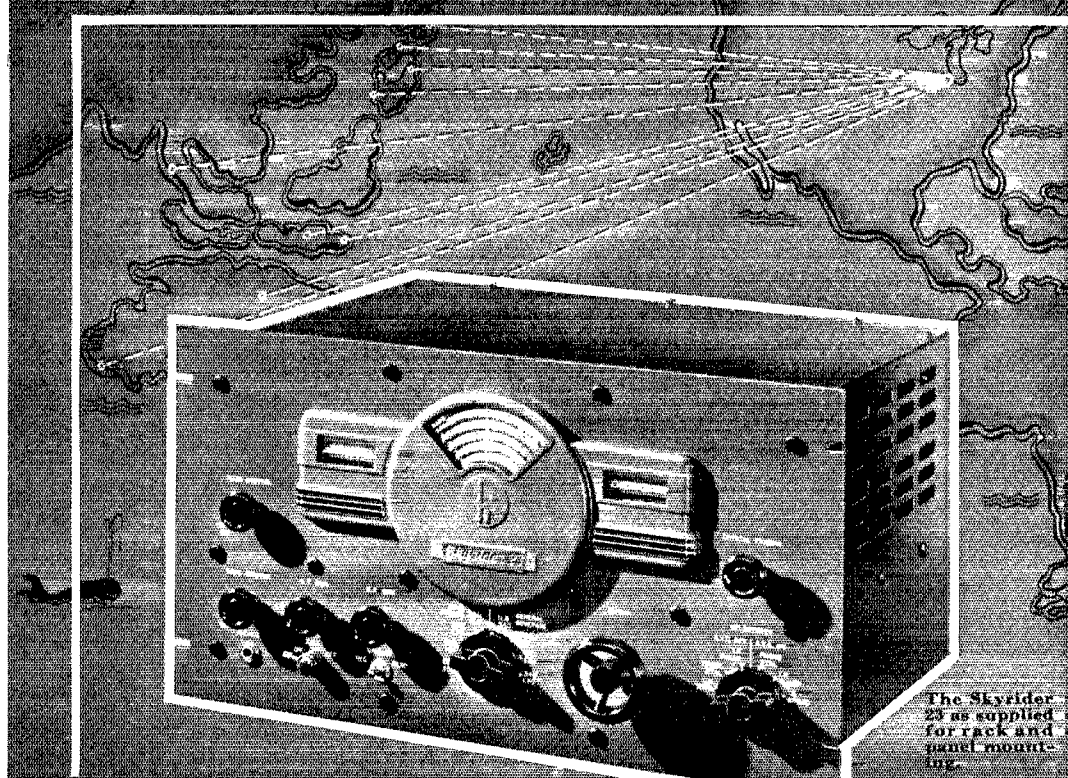

The Skyrider 23 as supplied for rack and panel mounting.

The NEW Skyrider 23 demonstrates its performance in DX Contest!

ONLY a few short weeks since the New-SKYRIDER 23 was announced, and already it has received its "baptism of fire" in the hardest test of all, the A. R. R. L. International DX Contest—and it has come through with colors flying.

In the phone contest, W9NLP, using the Skyrider 23 for the first time, reports 100% QSO's with the following stations between the hours of 7 A.M. and 8:30 A.M. on March 21st—VK2NS, KA1ME, KA1LB, PK1RI, VK2AJC, PK3WI, KA1FH, XZ2DX, KA1CS, VK9DK, KA1AP, PK2LZ.

And here are a few comments by other amateurs who have had the opportunity of using the Skyrider 23 in the DX contest:

"I believe you have the finest CW receiver that has ever been built."

"Drift is no longer a problem! I brought the SX23 in from my car with an outside temperature of about 20°, hooked it up, and logged a signal immediately. After 4 hours operation in a room temperature of 75° I checked the drift on the same signal. It was less than 3 divisions on the Band Spread Dial!"

"Mechanically it's practically perfect—no backlash—absolutely smooth in operation! It's really a precision-built job!"

"The Signal-to-Noise ratio is the best I've ever seen—why, with the R.F. Gain wide open and the dial off signal, I thought the set was dead!"

"You've really got crystal 'stability' in the 23. I set her square on the peak of a signal and then tried to jar it loose. All the pounding on the table, even on the set itself, didn't budge it, the signal kept coming right in strong as ever! Not only that, but it's just as good on an R3 signal as on an R9."

"The action of the selectivity switch is really sensational! In the first place you've got single control selectivity, handy to the key or mike! Then when you've tuned in a CW signal on sharp crystal position it comes in as clear and sharp as a lighthouse on a clear night. Then turn your selectivity switch to the phone crystal position, and, boy, your background noises come up and your signal flattens out. I noted, too, that your phone crystal position is plenty sharp but not so much so that intelligibility is jazzed up, in other words, the side bands are not too attenuated. It's a beautiful job all the way through!"

All Hallicrafters Receivers Sold on Liberal Time Payments.

See the Skyrider 23 at your Hallicrafters dealers, or write for descriptive booklet.

the hallicrafters inc.

2611 Indiana Ave., Chicago, U. S. A. • Cable Address: HALLICRAFT, Chicago

"WORLD'S LARGEST BUILDERS OF AMATEUR COMMUNICATIONS EQUIPMENT"

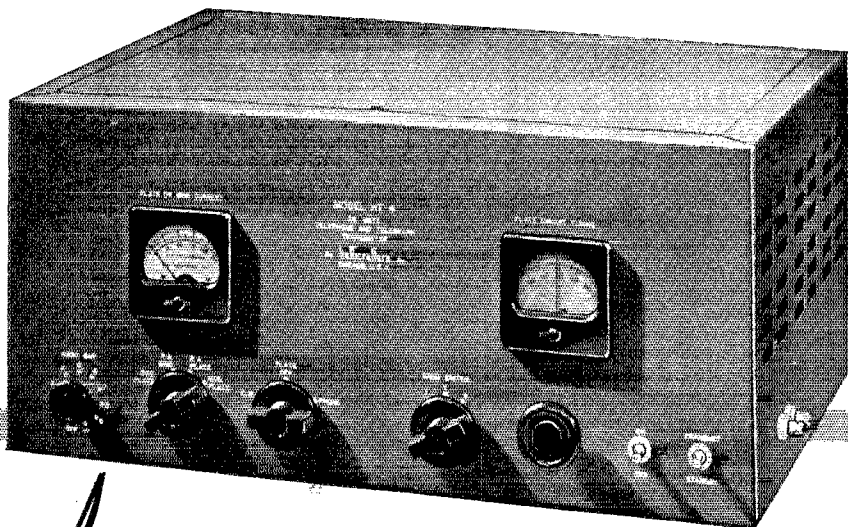

Announcing the MODEL HT-6

25 WATTS PHONE OUTPUT • ELECTRON-COUPLED OSCILLATOR

A NEW Hallicrafters Transmitter

IT'S news—important news to amateur radio men—when the Hallicrafters announce a new transmitter. For Hallicrafters transmitters are built for amateur requirements, functionally designed to perform at highest efficiency under the conditions imposed by amateur transmission.

The new Model HT-6 is no exception—a phone and CW transmitter with 25 Watt Output, designed to operate on any 3 bands and with all circuits switched from the front panel.

Electron-coupled Oscillator Units are available to permit frequency shifting, so that the operator can dodge QRM.

The Model HT-6 makes an ideal extra transmitter, normally operated on 110 V. AC current, with provisions for operation by any type of separate power supply it is perfect for emergency, mobile portable and marine service. The HT-6 also provides for crystal controlled 5 meter operation.

And by no means least among its desirable features is its extremely modest price.

SPECIFICATIONS

POWER OUTPUT—25 Watts Phone or CW
FREQUENCY RANGE—1.7 to 60 MC •
FREQUENCY CHANGE—Coils for any 3 Bands may be pre-tuned and plugged-in. All circuits switched from front panel. •
ELECTRON-COUPLED OSCILLATOR—Additional units available to convert 20, 40, 80, 160 meter coils for Electron-Coupled Oscillation. Units are equipped with temperature compensated padding condensers for frequency stability. •
POWER SUPPLY—110 V. AC. •
FOR EMERGENCY SERVICE—Connections provided for external power supplies. •
KEYING—Done in oscillator to permit break-in operation.

AMATEURS NET PRICE \$99.00
less crystals and coils

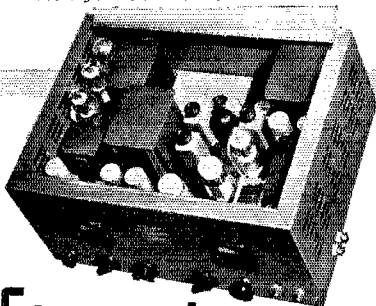

Note the clean, modern, "commercial" design of the HT-6. See the HT-6 at your Hallicrafters Dealer or write for complete information!

the hallicrafters inc.

2611 Indiana Ave. • Chicago, U. S. A.
 Cable Address: HALLICRAFT, Chicago

"WORLD'S LARGEST EXCLUSIVE BUILDERS OF COMMUNICATIONS EQUIPMENT"

MAY 1939

VOLUME XXIII

NUMBER 5



STAFF

Editorial

KENNETH B. WARNER, W1EH
Editor and Business Manager

CLARK C. RODIMON, W1SZ
Managing Editor

GEORGE GRAMMER, W1DF
Technical Editor

DONALD H. MIX, W1TS
BYRON GOODMAN, W1FE
Assistant Technical Editors

VERNON CHAMBERS, W1JQ
Technical Information Service

JAMES J. LAMB, W1AL
Consultant

Advertising

F. CHEYNEY BEEKLEY, W1GS
Advertising Manager

CHARLES BRUNELLE
Asst. Advertising Manager

Circulation

DAVID H. HOUGHTON
Circulation Manager

RALPH T. BEAUDIN, W1BAW
Asst. Circulation Manager



OFFICES

38 La Salle Road
West Hartford, Connecticut

Subscription rate in United States and Possessions and Canada, \$2.50 per year, postpaid; all other countries, \$3.00 per year, postpaid. Single copies, 25 cents. Foreign remittances should be by international postal or express money order or bank draft negotiable in the U. S. and for an equivalent amount in U. S. funds.

Entered as second-class matter May 29, 1919, at the post office at Hartford, Connecticut, under the Act of March 3, 1879. Acceptance for mailing at special rate of postage provided for in section 1103, Act of October 3, 1917, authorized September 9, 1922. Additional entry at Concord, N. H., authorized February 21, 1929, under the Act of February 28, 1925. Additional second-class entries to cover sectional editions authorized March 20, 1935.

Copyright 1939 by the American Radio Relay League, Inc. Title registered at United States Patent Office.

QST

devoted entirely to

AMATEUR RADIO

PUBLISHED, MONTHLY, AS ITS OFFICIAL ORGAN, BY THE AMERICAN RADIO RELAY LEAGUE, INC., AT WEST HARTFORD, CONN., U. S. A.; OFFICIAL ORGAN OF THE INTERNATIONAL AMATEUR RADIO UNION



CONTENTS

Editorial	9
Twenty-Five Years Ago	11
The 1939 Dog Fight	12
Exploring Below One Meter	
<i>J. P. Tynes, W6GPY and J. W. Babcock, W6ZA</i>	16
A Long-Distance Receiving Set That Tunes	<i>F. C. Beekley, 3JS</i> 19
"The Least of These My Brethren"	<i>H. W. Castner, W1IIE</i> 21
56-Mc. Tests	22
What the League Is Doing	23
A Three-Element Rotary Beam for \$16.61	
<i>Albert J. Meyer, W7GBY</i>	26
A Rig for the Lean Purse	<i>Adolfo Dominguez, Jr., CM2AD</i> 28
Preselection Pointers	<i>Dana W. Griffin, W2AOE</i> 30
Oklahoma State Convention	33
John C. Stadler, VE2AP	33
Building Reliability into the Portable Rig	
<i>W. K. Thomas, W8QAN</i>	34
Dakota Division Convention	36
Velocity Modulation of Electron Beams	37
A Compact and Economical 500-Watt All-Band Transmitter	
<i>"Chuck" Jones, W6GNR</i>	38
New England Division Convention	40
Input Resistance of R.F. Receiving Tubes	
<i>George Grammer, W1DF</i>	41
A Simple 5-, 10- and 20-Meter Converter for Home or Car	
<i>Wells Chapin, W9DUD</i>	44
An Old-Timer Builds a Broadcast Receiver	46
"Safety" Becomes a Watchword	<i>Clinton B. DeSoto</i> 47
Copying Bee Results	49
Wave-Shape Plots for Checking Amplifier Distortion	50
Naval Communication Reserve Notes	52
How to Lay Out a Metal Chassis	<i>Don H. Mix, W1TS</i> 53
How Would You Do It?	55
Volume Compression Simplified	<i>W. C. Lamb, Jr., W6OCC</i> 58
Dixie Jones' Owl Juice	59
I.A.R.U. News	60
Hints and Kinks for the Experimenter	62
Correspondence Department	65
Operating News	66
Silent Keys	96
Station Activities	100
A.R.R.L. Affiliated Club Honor Roll	102
Field Day, June 17th-18th	102
Safety ABC's	106
New Apparatus	108
A.R.R.L. QSL Bureau	116
Ninth Sweepstakes Contest Scores (By Sections)	120
Hamads	123
QST's Index of Advertisers	126

RCA and NBC Announce TELEVISION

Television Broadcasting Begins on April 30th in the New York Area

...and *RCA Victor* Television
Receivers Are Ready Now!

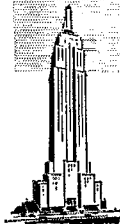

Years of patient effort in RCA Laboratories—millions spent on research—now convert a fantastic dream into a splendid reality . . .

April 30th marks the birth of a new industry—television. On that day sight will join with sound to bring you a wealth of new experiences.

Television offers something everyone wants. If you live in the New York metropolitan area you can have it right now. No prediction can be made as to how soon television will be available nationally, but RCA is bending every effort to meet popular demand.

When television becomes a nationwide service it should provide new opportunities for workers. Think how recently radio was an experiment and a toy. Swiftly it became a great industry. Today, radio is a source of livelihood to thousands. RCA hopes to help in a similar growth of television in the future.

The development of television has required much research. To insure success RCA gathered in Camden, a distinguished group of scientists and engineers. A long step forward was their development of the

Iconoscope, the “eye” of television, and the Kinescope, the “screen.” These are the bases of RCA electronic television, and have been made available to the entire industry.

Television also had to be proved in the field. RCA has spent more than two million dollars in practical field tests of television in New York. RCA and its various subsidiary companies have been, and are, engaged in every phase of television research, engineering, manufacturing, installation, broadcasting and service. This experience is unmatched anywhere. Now the great day has arrived. A new era begins. Through RCA Victor Television Receivers you can take part in one of the greatest adventures in all scientific history. It is an adventure you will never forget.

The development of television is one more example of the ceaseless research of RCA and its various subsidiary companies. By always looking ahead, RCA seeks not only to improve the general services of radio, but to produce equipment of highest standards at moderate prices for home, industry and laboratory. That's why, in radio and television . . . it's RCA All the Way.

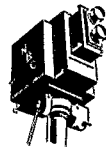

FACTS YOU'LL WANT TO KNOW ABOUT TELEVISION

Indications point to the operation, in the near future, of three stations in the New York area; also one at Schenectady, N. Y., and one at Los Angeles, California . . . At the average electric rate it will cost about one cent an hour to operate a television

receiver. Sizes of pictures are shown in set descriptions on these pages. Beginning about April 30, 1939, NBC will provide two one-hour programs per week, plus special event pick-ups of sports, visiting celebrities, etc.

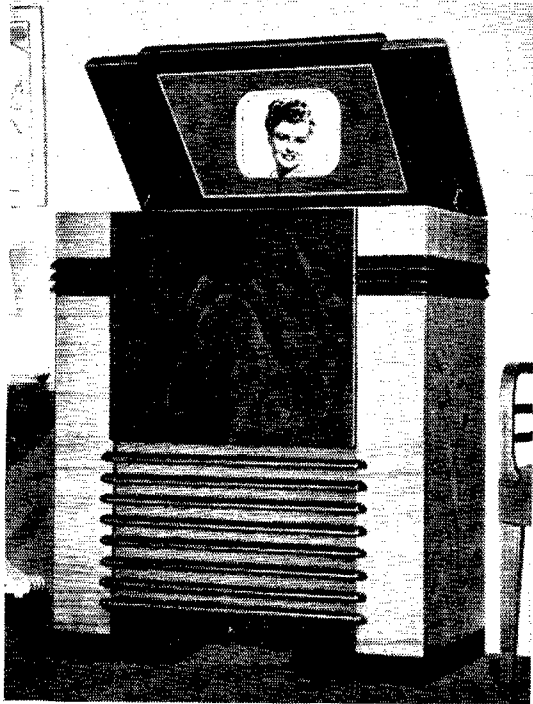

(AT LEFT) MODEL TRK-12 is the finest television instrument offered by RCA Victor. It contains an RCA 12" white screen Kinescope which provides a picture size of 7 $\frac{3}{8}$ " by 9 $\frac{3}{4}$ ", viewing is indirect through mirror attached to cabinet top. Other fine features of this instrument are as follows: 36 tubes exclusive of Kinescope, 4 chassis (1 video, 1 power supply for video, 1 all-wave, 1 power supply for all-wave), 5 television channels, selector switch for television tuning, 12-tube all-wave sound chassis, 12 watts (pentode push-pull) sound power output, high fidelity reproduction, inverse feed-back included with control, 12" high fidelity speaker, phonograph jack. This instrument uses sprayed silver compensated condensers and Styrol R-F and I-F transformers as mentioned below in description of Model TRK-5. Backed by \$2,000,000 field test.

RCA Victor Model TRK-9 (not illustrated) is similar to Model TRK-12, except that it is direct viewing and uses a 9" Kinescope



(BELOW) MODEL TT-5 RCA Victor Television Attachment is for use connected to modern radios through which sound is heard. It contains an RCA 5" white screen Kinescope . . . presents a picture about 3 $\frac{3}{8}$ " by 4 $\frac{3}{8}$ " in size . . . uses direct method of viewing . . . has 16 tubes exclusive of Kinescope . . . is a table model . . . has 5 television channels and selector switch for television tuning. Like the TRK-5 this instrument uses sprayed silver compensated condensers and Styrol R-F and I-F transformers. Backed by \$2,000,000 field test.



(ABOVE) MODEL TRK-5 RCA Victor Television Console. Features of this instrument in which you will be interested include an RCA 5" Kinescope with white screen . . . 24 tubes exclusive of Kinescope . . . 3 chassis, one an all-wave radio receiver, one an all-wave power supply and one for television . . . 5 television channels . . . a selector switch for television tuning . . . an 8-tube, 3-band push-button radio . . . 5 watts (pentode push-pull) of sound power output and a 12" loudspeaker. This instrument reproduces a picture in size of about 3 $\frac{3}{8}$ " by 4 $\frac{3}{8}$ ". Picture may be seen by direct method of viewing. Sprayed silver temperature compensated condensers are used in this instrument. These have proper temperature coefficient to maintain circuit stability regardless of temperature changes. This instrument uses Styrol R-F and I-F transformers to give highest type insulation. Backed by \$2,000,000 field test.

You can buy RCA Victor Television Receivers on C.I.T. easy payment plan . . . For finer radio and television performance — RCA Victor Tubes, In Radio and Television — It's RCA All the Way. Trademark "RCA Victor" Reg. U. S. Pat. Off. by RCA Manufacturing Company, Inc.



RCA Victor TELEVISION RECEIVERS

RCA Manufacturing Company, Inc., Camden, New Jersey • A Service of the Radio Corporation of America

Section Communications Managers of the A.R.R.L. Communications Department

All appointments in the League's field organization are made by the proper S.C.M., elected by members in each Section listed. Mail your S.C.M. (on the 16th of each month) a postal covering your radio activities for the previous 30 days. Tell him your DX, plans for experimenting, results in phone and traffic. He is interested, whether you are an A.R.R.L. member or get your QST at the newsstands; he wants a report from every active ham. If interested and qualified for O.R.S., O.P.S. or other appointments he can tell you about them, too.

ATLANTIC DIVISION			
Eastern Pennsylvania Maryland-Delaware-District of Columbia Southern New Jersey Western New York Western Pennsylvania	W3QP W3BAK W3BEI W8CSE W8OFO	John B. Morgan Edgar L. Hudson W. W. Filson Ed Preston Kendall Speer, Jr.	Blue Bell Laurel, Delaware Auburn Fully Lowber
CENTRAL DIVISION			
Illinois Indiana Kentucky Michigan Ohio Wisconsin	W9RMM W9QG W9ARU W8DPE W8AQ W9UIT	Leslie M. Dickson Noble Burkhart Darrell A. Downard Harold C. Bird E. H. Gibbs Aldrich C. Kroner	Edellyn Farms R. 4, Box 1 116 N. Longworth Ave. R.F.D. 2 405 Broad St. 3127-A West Madison St.
DAKOTA DIVISION			
North Dakota South Dakota Northern Minnesota Southern Minnesota	W9RZA W9VOD W9ICZ W9YNQ	Ernest Bloch Dr. A. L. Russell Edwin L. Wicklund Millard L. Bender	Box 202 R.F.D. 3 608 N. Huron Ave.
DELTA DIVISION			
Arkansas Louisiana Mississippi Tennessee	W5ABI W5DKR W5EWD W4DWS	H. E. Velte Eugene H. Treadaway Jewell W. Cole William Harold Walker	4415 West 12th St. 2749 Myrtle St. c/o City of McComb Water Dept. 301 Boscobel
HUDSON DIVISION			
Eastern New York N. Y. C. & Long Island Northern New Jersey	W2LU W2AZV W2GMN	Robert E. Haight E. L. Baunach Fred C. Read	311 South Holmes St. 102 Central Ave. 1014 North Ave.
MIDWEST DIVISION			
Iowa Kansas Missouri Nebraska	W9PIR W9UEG W9OUD W9FAM	L. B. Vennard Melvin D. Kirby Miss Letha Allendorf Samuel C. Wallace	(for W9ARE) 2749 Myrtle St. 1015 W. 3rd St. Green St.
NEW ENGLAND DIVISION			
Connecticut Maine Eastern Massachusetts Western Massachusetts New Hampshire Rhode Island Vermont	W1CTI W1FBJ W1HIL W1IAH W1BFT W1HRC W1KJG	Frederick Ellis, Jr. Winfield A. Ramsdell Larry Mitchell William J. Barrett Carl B. Evans Clayton C. Gordon Clifton G. Parker	19 Merrill Rd. 1188 Washington Ave. 51A North Ave. 239 Columbia St. 163 South Main St. 192 Washington Ave. Box 537
NORTHWESTERN DIVISION			
Alaska Idaho Montana Oregon Washington	K7ENA W7EMT W7FL W7DXF W7FCG	Leo E. Osterman Carl Eichelberger G. A. Woodhouse Harold W. Johnston W. Beale	Customhouse Route 2 Holter Dam 205 North Grant St. R. 4, School Ave.
PACIFIC DIVISION			
Hawaii Nevada Santa Clara Valley East Bay San Francisco Sacramento Valley Philippines San Joaquin Valley	K6ETF W6BIC W6FBV W6JIV W6SG W6GZY KA1GR W6KUT	Francis T. Blatt Edward W. Heim Elbert Amarantes Harold J. Burchfield Alan D. Whittaker, Jr. J. L. C. Buckenham George L. Rickard Edwin A. Andress	837 16th Ave. 309 Claremont St. 434 Washington St. 2240 106th Ave. 79 Elinor Ave. 2931 24th St. Box 849 2921 North Van Ness Blvd.
ROANOKE DIVISION			
North Carolina South Carolina Virginia West Virginia	W4CVB W4BQE W3UYA W8HD	W. Workman Ted Ferguson Charles M. Waff, Jr. C. S. Hoffmann, Jr.	P. O. Box 566 1313 Colledge St. 2607 Stuart Ave. 47 Lynwood Ave.
ROCKY MOUNTAIN DIVISION			
Colorado Utah-Wyoming	W9EHC W7CLG	Carl C. Drumeller Ernest E. Parshall	1828 East Kiowa St. Salt Creek Electric Plant
SOUTHEASTERN DIVISION			
Alabama Eastern Florida Western Florida Georgia West Indies (Cuba-Isle-of-Pines- Porto Rico-Virgin Islands)	W4DGS W4DVO W4AXP W4AGT CM2OP	James F. Thompson L. A. Connolly Oscar Cederstrom Leland W. Smith Mario de la Torre	1203 South Perry St. 719 So. Willow Ave. Second St. & Bruce Ave. 2010 Pennsylvania Ave. Escohar 110 (Altos)
SOUTHWESTERN DIVISION			
Los Angeles Arizona San Diego	W6MQM W6KFC W6JRM	Ralph S. Chick Victor C. Clark Howard K. Breedlove	1038 Milwaukee Ave. 747 E. Polk St. R. 2, Box 636
WEST GULF DIVISION			
Northern Texas Oklahoma Southern Texas New Mexico	W5DXA W5CEZ W5BHO W5ENI	Lee Hughes Carter L. Simpson Dave H. Calk Dr. Hilton W. Gillett	125 N. Main St. 2010 So. 4th St. 6726 Ave. Q
MARITIME DIVISION			
Maritime	VE1DQ	A. M. Crowell	69 Dublin St. Halifax, N. S.
ONTARIO DIVISION			
Ontario	VE3EF	Dr. L. R. Gunn, (for VE3SG)	Ontario Hospital New Toronto, Ont.
QUEBEC DIVISION			
Quebec	VE2CO	Lindsay G. Morris	Apt. 6, 4510 Girouard Ave., N.D.G. Montreal, P. Q.
VANALTA DIVISION			
Alberta British Columbia	VE4GE VE5HP	C. S. Jamieson J. Hepburn, Jr.	581 W. Riverside Drive 335 Foul Bay Road Drumheller, Alta. Victoria
PRAIRIE DIVISION			
Manitoba Saskatchewan	VE4SS VE4SY	Alf. G. Sheffield Arthur Chesworth	135 Sunnyside Blvd. 1071 4th Ave., N. W. Winnipeg Moose Jaw

* Officials appointed to act until the membership of the Section choose permanent S.C.M.s by nomination and election.

AGAIN KENYON

Makes a Hit!

Another manufacturer has gone Kenyon! Mr. Glenn Browning, following closely his policies of giving the Amateur only the best merchandise available has wisely associated his equipment with the "tops" in transformers.

Today, Kenyon T Line leads all others in original equipment for Amateurs

— The reason? Completely dehydrated — Conservatively rated — and with a record of one thousandth of one percent RETURNED FOR ADJUSTMENT! Mr. Amateur, don't take a chance with inferior equipment. Follow the Smart Manufacturer's idea and

GET KENYONIZED TODAY!

*New 1939 Catalog is yours for the asking.
See your Jobber or write direct.*



*The Sensational Browning Preselector
5 Bands, Calibrated Dial, High gain circuit and of course
—a Kenyon filament transformer!*



KENYON TRANSFORMER CO., Inc.

840 BARRY ST., NEW YORK, N. Y.

Export Department: 25 Warren St., New York, N. Y.

THE AMERICAN RADIO RELAY LEAGUE

Directors

President
EUGENE C. WOODRUFF W8CMP
234 W. Fairmount Ave., State College, Pa.

Vice-President
GEORGE W. BAILEY W1KH
74 Webster Road, Weston, Mass.

Canadian General Manager
ALEX REID VE2BE
169 Logan Ave., St. Lambert, P. Q.

Atlantic Division
WALTER BRADLEY MARTIN W3QV
Box 612, Roslyn, Pa.

Central Division
R. H. G. MATHEWS ex-W9ZN
109 East Ohio St., Chicago

Dakota Division
FRED W. YOUNG W9MZ
107 Hanover St., Mankato, Minn.

Delta Division
E. RAY ARLEDGE W58I
P.O. Box 286, Pine Bluff, Ark.

Hudson Division
KENNETH T. HILL W2AHC
115 Willow St., Douglaston, L. I., N. Y.

Midwest Division
FLOYD E. NORWINE W9EFC
120 South Fourth St., St. Louis, Mo.

New England Division
PERCY C. NOBLE WIBVR
37 Broad St., Westfield, Mass.

Northwestern Division
RALPH J. GIBBONS W7KV
c/o United Air Lines, Portland, Ore.

Pacific Division
J. L. McCARGAR W6EY
66 Hamilton Pl., Oakland, Calif.

Roanoke Division
H. L. CAVENESS W4DW
State College Station, Raleigh, N. C.

Rocky Mountain Division
GLEN R. GLASSCOCK W9FA
2164 So. Corona St., Denver

Southeastern Division
BENNETT R. ADAMS, JR. W4AFU
1512 Grove Place, Homewood, Ala.

Southwestern Division
CHARLES E. BLALOCK W6GG
1273 Main St., El Centro, Calif.

West Gulf Division
WILLIAM A. GREEN W5BKH
801 Ross St., Abilene, Texas

THE AMERICAN RADIO RELAY LEAGUE, INC., is a non-commercial association of radio amateurs, bonded for the promotion of interest in amateur radio communication and experimentation, for the relaying of messages by radio, for the advancement of the radio art and of the public welfare, for the representation of the radio amateur in legislative matters, and for the maintenance of fraternalism and a high standard of conduct.

It is an incorporated association without capital stock, chartered under the laws of Connecticut. Its affairs are governed by a Board of Directors, elected every two years by the general membership. The officers are elected or appointed by the Directors. The League is non-commercial and no one commercially engaged in the manufacture, sale or rental of radio apparatus is eligible to membership on its board.

"Of, by and for the amateur," it numbers within its ranks practically every worth-while amateur in the nation and has a history of glorious achievement as the standard-bearer in amateur affairs.

Inquiries regarding membership are solicited. A bona fide interest in amateur radio is the only essential qualification; ownership of a transmitting station and knowledge of the code are not prerequisite. Correspondence should be addressed to the Secretary.



HIRAM MERCY MAXIM, FIRST PRESIDENT

Officers

President EUGENE C. WOODRUFF, W8CMP
State College, Pa.

Vice-President GEORGE W. BAILEY, W1KH
Weston, Mass.

Secretary KENNETH B. WARNER, W1EH
West Hartford, Connecticut

Treasurer ARTHUR A. HEBERT, W1ES
West Hartford, Connecticut

Communications Mgr. F. EDWARD HANDY, W1BDI
West Hartford, Connecticut

General Counsel PAUL M. SEGAL
1026 Woodward Building, Washington, D. C.

Address all general correspondence to the administrative headquarters at West Hartford, Connecticut.

"IT SEEMS TO US—"

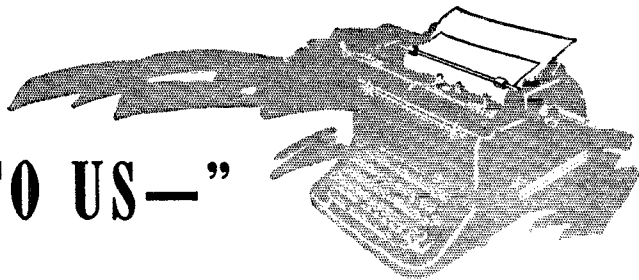

It is the American Radio Relay League's Silver Anniversary! Twenty-five years ago this month there was born in the city of Hartford, Connecticut, the lusty infant which has since grown into the great League we love so much — a quarter-century of as thrilling progress as has ever marked any of man's arts and a period of useful service doubtless greater than the total years of some of you our readers!

Let us set the stage. It is the beginning of the year 1914. There are about 5000 amateurs in the nation, all operating on spark. The audion detector has begun to replace the crystal detector, the fixed gap is rapidly giving way to the rotary. Spark-coil transmitters have a range of about ten miles, an occasional transformer set does a hundred miles or better. In January the Radio Club of Hartford has its first meeting, one of many amateur clubs springing up around the nation. Two of its active members are Hiram Percy Maxim, famous as a pioneer automobile engineer and the inventor of the Maxim silencer, and Clarence D. Tuska, a college youth. Interested in their club, they conceived, between them, the project of a vast national organization of amateurs based on the idea of relaying communications from station to station to overcome the handicap of short range. Each could relay for the others; thus united, any amateur could get his communications anywhere. In April they took their idea to their club and sold it. A relay committee was set up, the name American Radio Relay League was agreed upon, Maxim became its president and Tuska its secretary, and the club furnished funds to prosecute the work. By middle May application blanks were ready and letters were being written to every known amateur, inviting his membership. This was the real beginning of A.R.R.L., the date from which we count our years.

The idea took hold of amateur imagination and spread like wildfire. Applications rolled in. In June of 1914 the League actually relayed a message all the way from Hartford to Buffalo and a Boston-Denver route was being organized. In September the League published a U. S. map showing the location of its 237

member-stations in 32 states, and the following month it brought out a list showing the particulars of 400 stations that by then belonged to A.R.R.L. In January of 1915 the League and the Radio Club of Hartford decided to go their separate ways, the club being local in scope and the League obviously destined to national proportions. That month A.R.R.L. was incorporated as a Connecticut non-stock non-profit association. *QST* did not yet exist; it was not until December of 1915 that it first appeared, as a "relay bulletin" of the A.R.R.L. Privately published by Tuska and Maxim, and owned by Tuska, it was devoted exclusively to the activities of the League; its subscription price was \$1 a year. That first issue is now a collector's piece.

By this time much real work was being accomplished. January, 1916, saw the formation of the first trunk-lines, three east-west routes and three north-south. It was a full year later, though, before the first transcontinental relay succeeded, the route being Los Angeles to Denver to Jefferson City to Albany to Hartford. Ranges had increased too! Following month, February of 1917, a real record was set up when a transcon message went across and back in an hour and twenty minutes. *QST* boldly predicted eventual coast-to-coast communication in twenty minutes.

All this time the League had functioned solely under the guidance of Maxim and Tuska. They decided that the time had come to better their organization and in February, 1917, a meeting was held in New York with prominent local amateurs present, where the first formal constitution was adopted and the first Board of Directors elected. Maxim was destined to remain president until his death in '36; Arthur Hebert became vice-president and general manager in charge of the operating department, as the Communications Department was called in those days, with his office in New York; and Tuska carried on the secretarial and editorial work at Hartford. Except for Tuska's income from his *QST*, all of which he promptly poured back into the magazine, none of these men got a cent for their efforts on behalf of amateur radio. There were no sal-

aries, no formal headquarters, no staff. It was of course but shortly after perfecting this organization that war came — in April. *QST* drifted along until September, doing noble recruiting work but running heavily into debt as the League members went into war service, and finally folded up “for the duration.” Early in 1919, the war over, the Board commenced the reorganization of the League. Membership was almost non-existent, the treasurer reported but \$33 in the kitty, all amateur transmission was still prohibited by war-time restrictions. Nonetheless, the work was started. Capital was needed and it was decided to borrow it from amateur enthusiasts. There wasn’t even money enough to finance an appeal for loans. The hat was passed and \$90 raised in the Board meeting. That was enough to start the ball rolling. Several thousand dollars were borrowed from League members on A.R.R.L. bonds, which were paid off in two years. *QST* was purchased from Tuska in May, 1919; in April the League opened its post-war headquarters in Hartford, and in June the first post-war issue of *QST* appeared — 32 pages it had, too, by cracky! The war-time ban was still on transmission, and to the removal of this the League addressed all its efforts. At last the effort succeeded, and on Oct. 1, 1919, post-war amateur radio got started on its glorious career.

There followed such a period of progress and development as has scarcely ever been seen in any art. We’re going to tell you a few of the important dates. The average amateur of today has probably been in the game three or four years; he found crystal control and high-frequency technique and world-wide DX waiting for him. But it was not always so. Those things came by painful development: we crawled before we walked before we ran before we flew. Many of our readers of to-day probably have little idea of our early history, of our rich background, of the step-by-step development that made amateur radio what it now is. We started out, after the war, with our same old pre-war spark gear, the same old restricted ranges. Now watch the story unfold:

January, 1921: After months of planning, transcontinental relays were held through selected stations while all the rest of amateur radio piped down and listened. From Hartford to Chicago to Roswell, N. M., to Los Angeles and back, a message went from coast to coast and the answer was returned by relaying in a total elapsed time of 6½ minutes. Try it to-day by relay!

March, 1921: Vacuum tubes made their first appearance on the amateur market; a 5-watter cost \$8, such a tube as you can buy to-day for 46 cents; 50-watters cost \$30! Despite the cost, the trend to c.w., which a few hardy pioneers had been pushing ever since

1919 with war-time bootleg tubes, got new impetus — although it was to be many years before spark was finally outlawed.

August, 1921: A.R.R.L. held its first national convention at Chicago, with 1200 present from 36 states, with every call area represented for the first time at any ham gathering.

December, 1921: Believing that our signals could be heard well across the ocean, A.R.R.L. sent Paul Godley, America’s most expert receiving experimenter, to Scotland to listen during transatlantic tests, on special superhet gear of his own devising. He heard 18 c.w. stations, 9 sparks, and European amateurs heard a few more; 30 hams got across the pond on 200 meters.

In late 1921 broadcasting came to metropolitan centers.

April, 1922: First QSO between California and Hawaii.

September, 1922: ICCZ on Cape Cod worked every U. S. district in one night — first time it ever happened.

November, 1922: Record-breaking relay, 1AW to 9AWM to 6ZAC in Hawaii and return to Hartford in elapsed time of 4 mins. 18 secs.

December, 1922: More transatlantic tests. 316 American amateurs got over the ocean on 200 meters, from all districts. A.R.R.L.’s cable bill for reporting the results was \$1900. More important, 20 U. S. hams heard three British and French amateurs for the first time.

June, 1923: The first expedition using amateur radio sailed; MacMillan’s “Bowdoin,” WNP, with 1TS as operator, set out for the Arctic, A.R.R.L. paying 1TS’s salary to demonstrate what amateur communication could do.

September, 1923: VK2CM works ZL4AA, 1500 miles away, on 0.004-watt c.w.

November, 1923: First transatlantic two-way communication occurred when IMO and 1XAM in Connecticut worked F8AB in France, on about 2560 kc.

December, 1923: First QSO between America and England occurred, with Yours Truly on the American end. Italy and Holland quickly followed.

December, 1923: A.R.R.L. adopts new constitution providing for directors elected by the members of divisions, and the old Board of Directors votes itself out of office to give League members self-government.

May, 1924: More continents united when New Zealand and Argentina work for the first time, with a new DX record of 6400 miles. Same month saw North and South America united for first time.

July, 1924: With all previous “short-wave” work only on experimental licenses or by special temporary authority, the government after months of ground-work by A.R.R.L.

came across with short waves for amateurs; 3500-4000 kc. and some higher frequency bands assigned for first time to all amateurs.

July, 1924: First article on crystal control appears in *QST*.

September, 1924: First authenticated trans-pacific work occurs, between California and New Zealand.

October, 1924: New DX record of 9000 miles when Connecticut works New Zealand. Quickly outshadowed the same month by the first linking of the Antipodes when England and New Zealand tied up, followed in November by the first England-Australia contact.

December, 1924: Amateur signals first heard across the continent in daylight when John Reinartz in Connecticut, using the new 20-meter band, is intercepted by Frank Jones in California.

April, 1925: First published theory of short-wave propagation appears, Reinartz' article in *QST*.

April, 1925: Following a missionary trip by Hiram Percy Maxim at the instance of the A.R.R.L. Board, the International Amateur Radio Union is formed in Paris, Maxim elected president, Warner secretary.

1925 also saw the formation of the N.C.R. and the A.A.R.S., the development of strong alliances between A.R.R.L. and the Services.

April, 1925: Getting leave of absence from his job as A.R.R.L. Communications Manager, Fred Schnell takes NRRL with the U. S. Fleet to Australia, sells short waves to the Navy.

May, 1925: Australia and England unite the Antipodes in the first daylight QSO, on 14 Mc.

April, 1926: W.A.C. started, with 8 initial members. (Present number, 4478!)

May, 1927: A.R.R.L.'s first annual DX contest held.

March, 1928: The 10-meter band is opened.

And so on and on and on. We could fill pages and pages with the entrancing tale, as Clint deSoto in fact has done in his fascinating history of amateur radio, *Two Hundred Meters and Down*. Our little thumbnail sketch above highlights only the operating accomplishments of amateurs, says nothing about our innumerable legislative fights for existence and our invariable success, our gradual transition from a lawless unorganized mob into a closely coordinated institution of recognized national value. It makes no mention of our tremendous record of public service in emergencies, our conquest of the ultra-highs, our constant sallying forth to attack new problems.

To-day we have 51,000 licensed amateurs in the country, several thousand more in Canada. Our magazine is read by almost every active amateur in the world, our headquarters has a staff of 37 persons rendering membership serv-

ice of every description, we possess a great communications system and a fine headquarters station, our society is the pattern for the other amateur organizations of the world. We are public-service conscious as never before, appreciated and valued by the public as never before. It has taken a generation to do this job. On such an occasion as this it should be pardonable to look over our progress with a little pride. It seems to us that A.R.R.L. has flourished because it was founded on sound principles. It is of, by and for the amateur. Since the beginning, private profit has been kept out of our affairs. We are indissolubly bound to the principles of deciding our problems in terms of the greatest good to the greatest number, and of making all our decisions on the highest possible standards of integrity, democracy and fraternalism. Our quarter-century of mutual service and progress can scarcely better be summed up than in the language we have used for many a year on the directory page of each issue of *QST*, where we say that our League has a history of glorious achievement as the standard-bearer in amateur affairs. True words they are, and we should be proud that we can say them to-day!

K. B. W.

Twenty-Five Years Ago—

IN THE June, 1914, issue of *The Wireless Age* there appeared this announcement:

"Hiram Percy Maxim is authority for the statement that The Radio Club of Hartford, Conn., of which he is chairman, has organized a committee whose object is to develop a system of relay stations throughout as much of the country as seems possible. At the present time messages are being forwarded by relay from Hartford, Conn., to Buffalo, N. Y., via Northampton, Mass., and one of several intermediate stations. This plan has worked so well that there seems no reason why it should not be improved still further in detail and also extended to cover a wider range.

"The club believes that the number of good amateur stations in the country is great enough to make it possible for an amateur to reach the far West and possibly the Mexican border, if the stations were organized. The only thing needed is to secure the names and addresses of the owners of stations able to transmit fifty to one hundred miles. If amateurs will write to Mr. Clarence D. Tuska, Secretary, Radio Club of Hartford, No. 136 Oakland Terrace, Hartford, Conn., blank forms will be supplied which when filled out will be used as a basis for appointing official relay stations.

"This plan seems to be about the only one by
(Continued on page 122)

The 1939 Dog Fight

or

Why Don't I Live in Norfolk?

IF YOU are a normal, peace-loving amateur, unaccustomed to vicious violence and carnage, don't read any more of this. The terrible

tale of ruthless aggression that is about to be unfolded will bring too many horrendous shudders — unless, of course, you were in the thing yourself. If you lasted through the fracas, you can really take it, and nothing said here can possibly bother you. And if you've never been in a DX Contest — well, mister, you should try your hand at pitting your station and operating skill against some of the super-warriors of the 7-14-28 circuit.

None of this is news to one with a knowledge of astrology, since he would have noted long ago that the c.w. battle comes under the influence of *Pisces*, the fishes, and the 'phone meleé under *Aries*, the ram. Fishing and ramming aptly describes it. Your correspondent believes that the bands themselves were entirely innocent and in no way deserving of the punishment dished out to them; as a matter of fact, Messrs. 14 and 28 often tried to hush up the whole thing by refusing to talk, but it did no good, although the taciturnity of Old Man 28 was fairly effective at times.

On the other hand, the DX stations didn't have a chance. Just let one open up with an innocuous "CQ W VE" and BANG! the war lords descended! The heavy drone of kilowatt bombers, the versatile aerobatics of the thousand-and-one e.c.o.'s, the persistence of the single-place d.c.-xtal attack jobs and the inevitable fast pursuit signals, revved up on a bug at 40 per, all combined to form the largest mass attack on DX Contest scores that has ever taken place. According to neutrality to the 1.8- and 3.5-Mc. bands only made the battle more relentless on the higher frequencies.

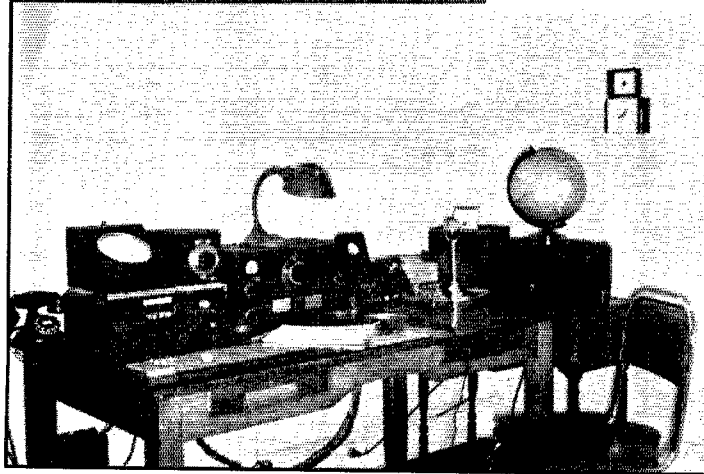

The consistent and dependable Penton Priest, W3EMM of Norfolk, Va., broke all records in the 'phone contest by running up 142,000 points, after having made the third-highest score in the c.w. test. A kw. final with push-pull 250TH's, modulated by a pair of 805's, did the work, aided and abetted by an e.c.o.

Here's where Dan Smith, W3CHE of Norfolk, Va., set a new high-score record of 181,000 points in the c.w. contest. Although far from a newcomer to DX, this is the first time Dan has smoked out the favorites.

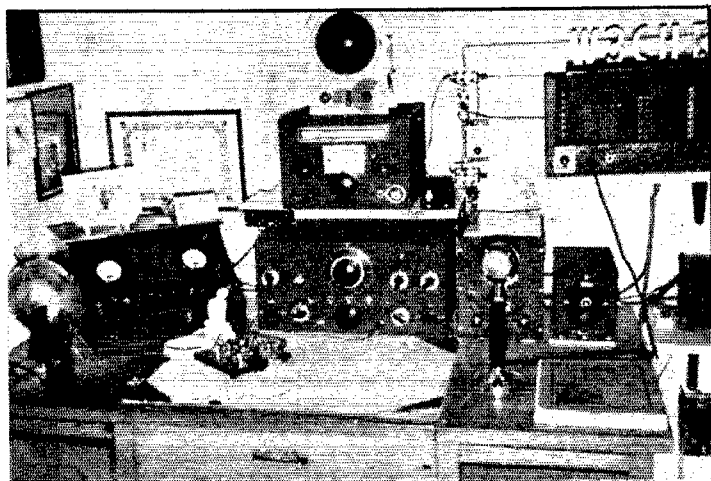

Although the nurses and flight surgeons kept things pretty well in line, with remarkably few cases of band-limit amnesia, the dreaded plague of e.c.o.'s did turn up. Surprisingly enough, however, it was kept under control and resulted in not too many severe cases. Most of the trouble caused by the variable-frequency contingent can be attributed to DX stations who insisted on listening for replies on their own frequency. PK4KS was the easiest signal to find — just look in the middle of the mess calling him and there he was, struggling to copy a W who had about half a chance of getting through. Conversely, a smart one like XU4XA, for example, used "QHM" and "QMH" and kept the W's off his own frequency, to everyone's satisfaction except the few who had grooved themselves into calling all DX on the DX's frequency.

The 7-Mc. band had its good and bad points. It was a lifesaver in that it was the most consistent band of the lot, with good signals throughout the contest. On the other hand, it was an ear-opener to many who hadn't tried it for some time and didn't know that the regular habitués exiled there are completely cut off from the world. They must be — they don't seem to be familiar with what is going on. As one well-known DX man said only the other day (he must remain anonymous because of his inherent modesty and political ties), "It was easy to spot the DX on 40 — anyone calling 'CQ' more than ten times without signing was bound to be a W."

The most amazing thing about these contests seems to be the utter disregard the top scorers have for conditions. Julius Q. Sol, acknowledged boss of the Heavyside district, had an attack of indigestion or something and was none too kind during the Contest, but in spite of the handicap of poor signals and restricted effective times, the big boys topped last year's scores! Step into the parlor and take a look.

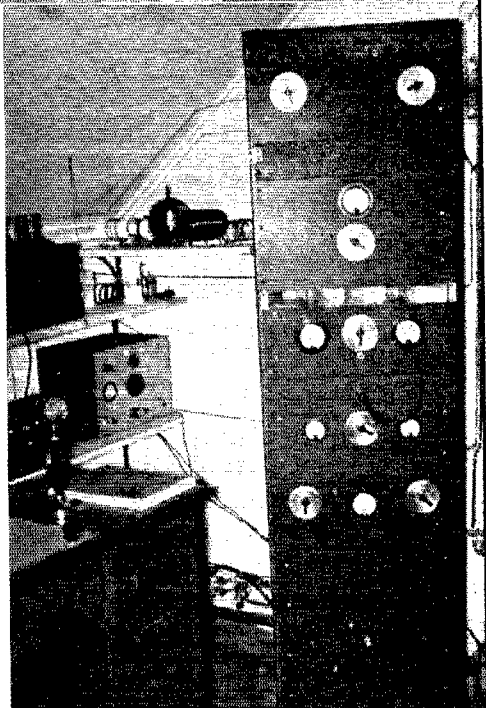

The C.W. Contest

One might as well expect to hear nothing but T9x signals as to have a Contest go by without Juan Lobo y Lobo, XE2N, showing up rather prominently. This one ran true to form, and for those of you interested in higher arithmetic, XE2N made 1910 contacts in 85 hours for an average of 22.5 QSO's per hour and a score of 230,584 points! If he hadn't missed one district on 28 Mc., XE2N would have had the perfect 42

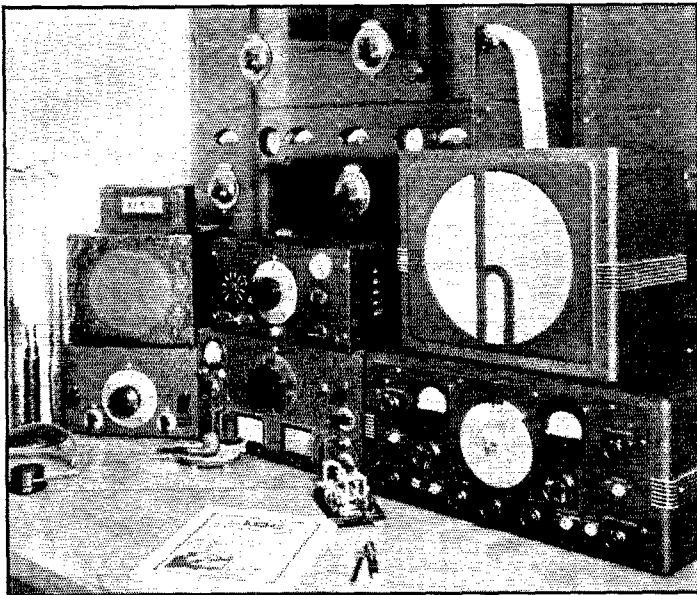

The gear used by Tommy Thomas, W2UK of Quoque, L. I., N. Y., is designed for accessibility. Tommy was the second-high scorer on c.w. and the third-high on 'phone. Note that the meters on the transmitter are set behind the panel, for safety.

multiplier, but he didn't do so badly without it, coming very close to his previous year's score which was made on five bands. The rig is 150 watts to an HF100 final, with band-switching.

One of our better spies reports that ZL1MR made 118,000 points, and we don't doubt it, the way he was batting them out.

All scores herein are "claimed" scores — it will be some time before the tremendous job of cross checking logs, which always involves some necessary corrections is completed.

Other high foreign scores reported include: K5AF, 91,020; K6KLN, 85,000; VK2ALU, 83,000; EI4J, 70,770; G6NF, 70,115; ON4NW, 61,346; G6WY, 60,440; K4KD, 53,244.

On the domestic side, we bring you a new ace. He hails from that now famous-for-DX city of Norfolk, Va., and answers to the name of Dan Smith. You know him as W3CHE, and if you didn't hear him going to town you just weren't on the air. Without benefit of 80, Dan still managed 360 contacts with a total multiplier of 168, for the new W-high record of 181,440 points! W3CHE worked a total of 80 different countries; 75 on 20, 51 on 40 and 42 on 10. Best DX was a J8 on 40.

Right at Dan's heels, and almost too close for comfort, comes that battle-scarred veteran who very, very nearly pulled the trick of being high man three times in a row. Tommy Thomas, W2UK, blasted through the QRM to collect 347 contacts and a multiplier of 170 for a total of 177,000 points. Tommy's rig was much the same as last year except for a pair of new 3-element beams which apparently didn't hold him back.

Go right back to Norfolk for your next high

score, because W3EMM's 175,000 points look like they'll take show money. Fenton Priest always turns in a swell performance and this year was no exception. He admits that the addition of an e.c.o. helped a lot, but our guess is that he knows what he wants and goes after it; 354 contacts and a multiplier of 165.

Head and shoulders above any other W6 (and most of the rest of the

country) comes Doc Stuart, W6GRL. In there all the time with a walloping signal that couldn't be denied, W6GRL ran up a score of 162,342 points, to outclass completely any previous scores from the coast and cinch his position as Number 1 contest man out that way.

Bill Atkins, W9TJ, made a strong bid for top honors by running up 159,372 points, with 318 contacts and a multiplier of 171. W9TJ's work was really something, including WAC 12 times and 85 different countries worked, a remarkable performance from his part of the country.

First of the New Jersey gang to draw blood is Clem Giberson, W3PC, whose 295 contacts and multiplier of 151, for a total of 133,635 points, confirm any suspicions about his being a hard one to beat. Trailing Clem, but not by much, comes the guy who makes the going tough for the Headquarters men foolish enough to try to compete with him — Roddy of W1SZ tied a can to us that read "279 contacts and a 155 multiplier equals 129,700 points." Down around Philly they're tipping their hats to W3BES and his 120,000 points, and Texas is pretty proud of W5EHM and his score of 114,000. Others over 100,000 include W4CEN, 112,572; W9TB, 111,390; W1TW, 109,350; W2DC, 100,584; W8BTI, 100,000 — all tried and true DX men.

Some other high scores, collected at this early date and subject to slight revision, as are all the above: W1KHE, 96,000; W4BPD, 93,000; W1TS, 92,000; W8LEC, 86,304; W2BHW, 85,000; W4YC, 85,000; W6CXW, 82,000; W8QDU, 80,000; W3FRY, 72,000; W3COP, 71,875; W9GRV, 70,000; W5KC, 67,144; W9FS, 66,267; W8AU, 64,512; W3BEN, 62,370; W4ECL, 62,208;

W6QYT, 60,000; W2CBO, 58,000; W8JIN, 58,000; W5VV, 57,600; W6CUH, 53,000; W6GRX, 53,000; W9GY, 50,800.

Highest W7 heard of so far is W7AMX with 24,400.

The 'Phone Contest

That statement about the leaders not caring about poor conditions goes double for the 'phone gang. In spite of mediocre conditions most of the time, it is amazing to note that, while last year no one topped 100,000, this year at least five surpassed that score. And the highest? Well, if anyone had told us before the contest that someone was good for 125,000 points in the tonsil tussle we should have stuck his head under a shower and opened a can of tomato juice. But just to show that anything can happen in this mad mélange, last year's high 'phone man decided to increase his score by over 45 per cent, and Fenton Priest, W3EMM, talked his way through QRM and indifferent conditions for 484 contacts and a multiplier of 98, for a grand total of 142,000 points! You can call it luck or anything you want — we know that such a performance indicates only one thing; that there was a real operator at W3EMM during the contest!

Perhaps a Southern drawl does the trick and gives the signal that necessary "Umph," but the

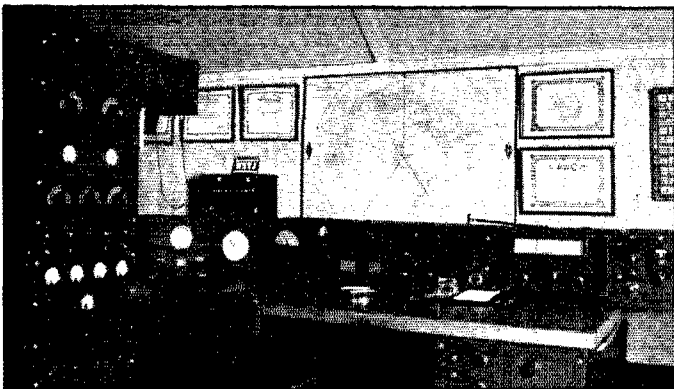

Bill Atkins, W9TJ of Raymore, Mo., did a swell job in running up a score of 159,372 in the c.w. test. Push-pull T125's in the final, c.c.o. and band-edge temperature-controlled crystals, and five V-beams for full coverage, all indicate that W9TJ didn't decide to enter the contest at the last minute.

next highest station had that kind of a voice too, unless Dave Evans has gone Hollywood and acquired a bit of British. In any event, W4DHz took over the mike at W6GRL's and rolled up the tidy little sum of something over 110,000 points for the Ventura station, which stack of chips is not likely to be topped by anyone but the impossible Mr. Priest.

Of course, W2UK was in there all the time too, swinging with both tonsils and an adenoid left over from the Notre Dame-Northwestern game, and Tommy ran very close with 109,000, 404 contacts and a 90 multiplier. But the coast can never be discounted in anything dealing with DX, and W6OCH, Larry Barton, comes marching along with 103,488; 393 contacts and 88 multiplier, doggedly determined by Reg Tibbetts, W6ITH, and his 101,304 points, 404 and 86, to give three of the five "Over 100 G" places to the W6's. All of which leaves one with the impression that DX can be worked on 'phone — and how!

Oh, no, that isn't all. Far from it. For exam-

(Continued on page 118)

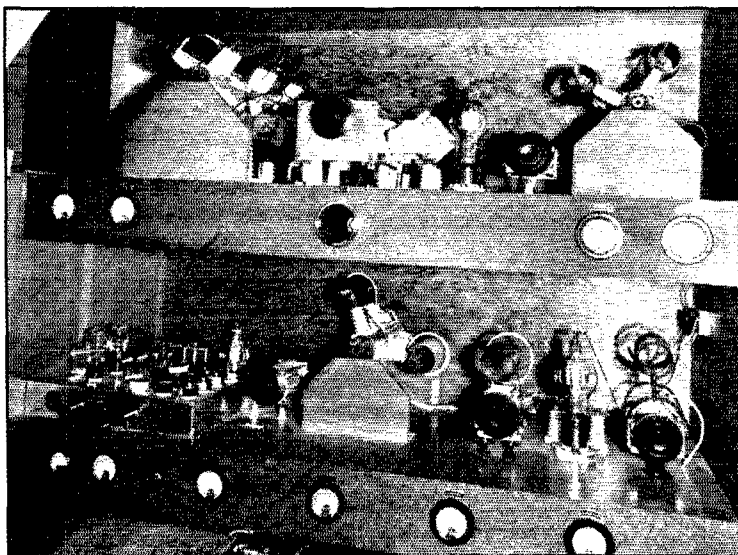

Dr. Charles Stuart, W6GRL of Ventura, Calif., believes in quick band-change, as indicated by his turret-coil transmitter. Always a big threat in any contest, GRL was second-highest in the 'phone contest and fourth-highest in the c.w.

Exploring Below One Meter

Practical Equipment for Operation on 325 Megacycles

BY J. P. TYNES,* W6GPY, AND J. W. BABCOCK, W6ZA**

VERY little amateur work of a practical nature has been done on the ultra-ultra high frequencies, and several months ago the writers took it upon themselves to find out just what the possibilities were on wavelengths of less than one meter. An entirely satisfactory voice channel is now in operation on 325 Mc. over a path approximately 5 miles long, and it is hoped that this brief description of the equipment and the results obtained may help stimulate further work along these lines.

An interesting series of tests was carried out for an extended period of time by the Bell Telephone Laboratories on wavelengths from 1.6 to 5.0 meters, over a 70-mile path between Highlands, New Jersey and East Moriches, Long Island. The results of these tests are given in an article entitled "Ultra-Short-Wave Transmission

While in our case it has not been possible as yet to extend the distance between the stations in order that more comprehensive data might be obtained, several very interesting phenomena have been observed, and are worthy of comment. The first of these is the almost complete lack of automobile ignition interference in the receivers. This is probably due to one of two things: either lack of sensitivity in the receivers, or too high radio-frequency losses in the ignition systems at the frequencies on which we are operating. It is our belief that the latter is the explanation, since the receivers give indication of adequate sensitivity. It is evident that the higher frequencies are going to be as satisfactory as 5 meters, and may be more satisfactory in some respects. While most of our tests have been over an optical path, in one case it has been possible to obtain a readable signal

This view shows the hairpins of No. 12 wire which form the filament line. It is not necessary to ground the filament center tap and the grid leak to the same point on the chassis.

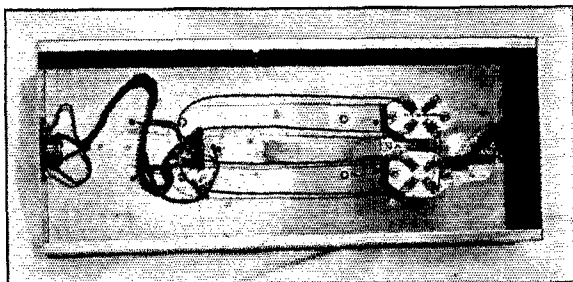

and Atmospheric Irregularities," by Englund, Crawford and Mumford, in the October, 1938, issue of *The Bell System Technical Journal*. This article should be of interest to anyone contemplating work of this kind.

* 3044 1/2 Telegraph Ave., Berkeley, Calif.

** 984 Santa Barbara Road, Berkeley, Calif.

in a receiver located approximately five miles away with a hill in between.

Several weeks were spent in experimenting with self-excited oscillators using inexpensive tubes of the 37 and 45 variety. No attempt was made to put these oscillators on the air during this experimental period, as it was felt necessary first to

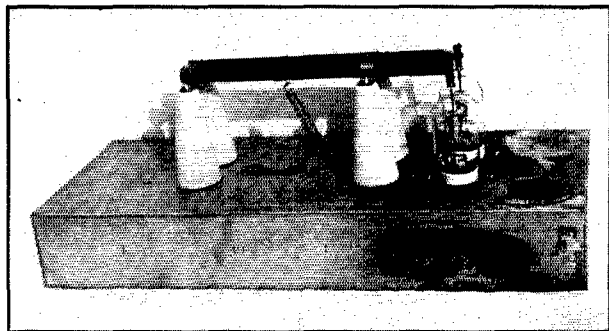

The transmitter is built on a conventional chassis, with the plate tank line supported on standoffs. The tubes are HK-24's, operating at a plate voltage of 650.

A transmitter and two of the receivers used in the 325-Mc. experiments described in the text.

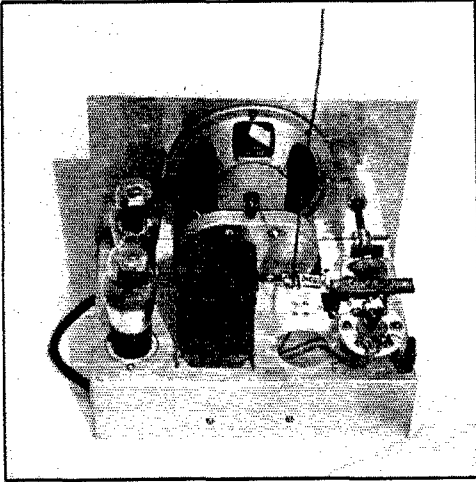
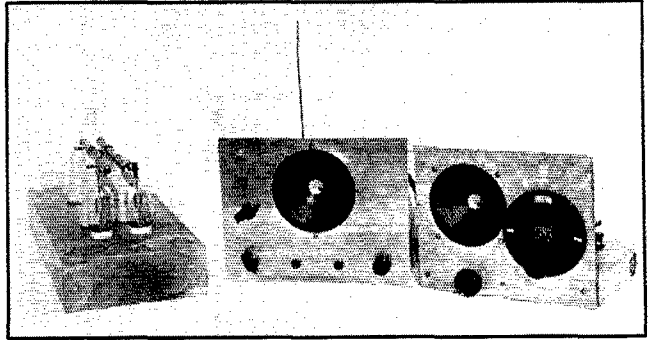

This rear view of one of the receivers shows the r.f. section, at the right, and the quarter-wave antenna mounted on a standoff near the center of the chassis. The tuning condenser is turned by an insulated shaft.

determine definitely just what possibilities these tubes had. It was very shortly found that the 45 tube would oscillate on 224 Mc., but its efficiency was very low and for this reason it was necessary to run the plate current to abnormally high values to obtain any appreciable output. It was naturally expected that the life of the tubes would be very short when operating under these conditions. Attempts to make the 45's oscillate at frequencies above 230 Mc. resulted in failure. The 37 tubes seemed to offer better possibilities, and were actually made to oscillate at frequencies as high as 275 Mc., but the operation became very erratic at this point. It was, therefore, decided to abandon the idea of using tubes of this type.

The Receivers

We dug up an old superregenerative receiver which was used several years ago on 5 meters and which had an RCA 955 tube as a detector. It soon became evident that the insulation in the r.f. circuit, which was passable on 5 meters, was a long

way from satisfactory on 1 meter or less. A "mud" socket for the 955 was replaced by one having good insulation, and a similarly-insulated condenser was discarded for a Cardwell midget having isolantite insulation. All of the r.f. leads were made as short as possible (this is very important) and additional by-pass condensers were installed. After considerable time was spent in trying different values of grid leak and grid condenser it was found that the receiver would function very nicely on 325 Mc. The values of the grid leak and grid condenser seem to vary widely for different receivers, and for that reason it is impossible to give definite values. Considerable experimenting must be done with each receiver until it superregenerates over the entire tuning scale and has no tendency to howl.

The circuit connections for the receiver are shown in Fig. 1. The circuit is the old stand-by superregenerative arrangement, with a little extra doctoring for operation on the higher frequencies. Once again we stress the necessity for keeping all r.f. leads as short as possible, and also for using good insulation. All r.f. by-pass condensers must be run to a common ground point. A good place for this is the point where the cathode of the 955 is grounded to the chassis. In the receivers built so far the panels and sub-panels have been iron, which has been used rather than copper because we considered these receivers to

One factor which has delayed realization of amateur communication on centimeter waves has been the lack of low-cost tubes capable of developing a reasonable amount of power at 300 Mc. and above. The 316-A and similar types have been outstanding performers, but expensive. This situation is rapidly being remedied, however, and cost is no longer a real deterrent. In this article, W6CPY and W6ZA break ground in a field in which hams have had little experience. Let's get going and find out what these waves will do for us!

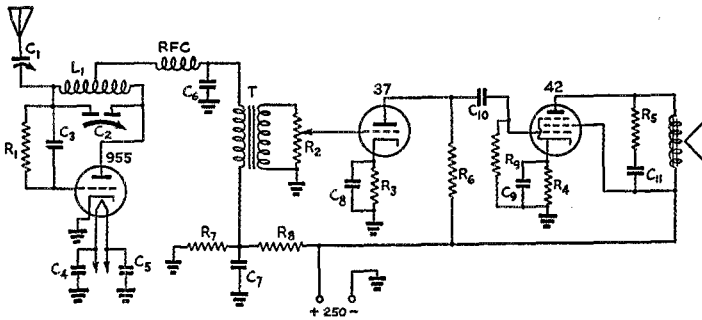

Fig. 1 — Circuit of the 325-Mc. receiver.

- C₁ — Midget padding condenser, very low minimum capacity.
- C₂ — Cardwell midget variable; two rotors and one stator. Stator plate sawed in half.
- C₃ — 50 μ fd., approx. It may be necessary to vary the size of this condenser.
- C₄, C₅, C₆, C₁₁ — 0.002 μ fd.
- C₇ — 0.5 μ fd.
- C₈, C₉ — 10- μ fd. electrolytic.
- C₁₀ — 0.02 μ fd.
- R₁ — 1 to 5 megohms; trial will be necessary.
- R₂ — 100,000-ohm potentiometer (volume control).
- R₃ — 3000 ohms. R₆ — 100,000 ohms.
- R₄ — 1500 ohms. R₇ — 50,000 ohms.
- R₅ — 10,000 ohms. R₈ — 75,000 ohms.
- R₉ — 250,000 ohms.
- L₁ — Two turns of No. 16 bare wire, $\frac{1}{4}$ -inch inside diameter, turns spaced the diameter of the wire. Tap is located near the grid end of coil.
- RFC — 25 turns No. 26 d.s.c. wire, $\frac{1}{4}$ -inch inside diameter.
- T — Interstage audio transformer.

be temporary and therefore did not feel that the additional expense for copper was justified. We do feel, however, that for a permanent receiver it would be desirable to use sheet copper, at least for the chassis.

The difficulties of coupling an antenna to the receiver usually experienced on 5 meters were also experienced on the higher frequencies. We have a 954 tube on the top shelf which we are saving for the day when we find time to try this tube as an r.f. amplifier ahead of the detector. We don't expect much, if any, r.f. gain from the tube at 325 Mc., but we may find that we can then couple the antenna closer to the r.f. end of the set and not pull it out of superregeneration.

The Transmitters

Before we go very far into a discussion of the

- L₁, L₂ — No. 12 bare wire bent in form of hairpin. Length from loop to filament sockets, 9 inches.
- L₃, L₄ — $\frac{1}{2}$ -inch outside diameter copper tubing, 1/64-inch walls. Total length of each plate line, 4 $\frac{1}{4}$ inches. Spacing between lines, $\frac{1}{2}$ inch.
- RFC — 25 turns No. 20 d.s.c. wire, $\frac{1}{4}$ -inch inside diameter.

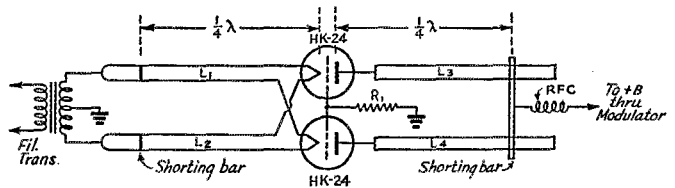

Fig. 2 — The transmitter circuit.

transmitters, we must say this one thing: Our ideas of conventional oscillator circuits were abruptly changed about the time we really went into the work on the high-frequency oscillators. Instead of the usual plate tank circuit consisting of an inductance and condenser, we suddenly found ourselves working with an infernal machine that, at first glance,

had somewhat the appearance of a plumbing shop. The plate inductance was replaced with a one-quarter wave tuned plate line, made of copper and tuned by means of a shunting bar. The usual untuned filament circuit was discarded for a tuned affair somewhat similar to the plate circuit, and the tuned grid circuit was replaced by an untuned circuit. For this circuit we owe our thanks to Heintz and Kaufmann.¹ A pair of their new HK-24 tubes are used as oscillators, and the transmitter really works very satisfactorily. The circuit connections are given in Fig. 2. The modulators and power supplies are entirely standard and so no mention of them is made here except to say that any modulator having an output of 15 or 20 watts of audio power will be satisfactory when the transmitter is supplied power at approximately 650 volts. This is just about the maximum rated voltage of the HK-24 tubes when operated at 325 Mc.

In actual operation, the position of the shunting bar in the plate circuit of the transmitter is changed until minimum plate current is obtained. The frequency is then checked by means of Lecher wires. If the frequency is too low, the shunting bars on the filament lines are moved to shorten the effective length of the lines and a new position for the shunting bar in the plate circuit is found. These operations are continued until the transmitter is functioning on the desired frequency. When the antenna is coupled to the

(Continued on page 118)

¹ This circuit also is used in several of the transmitters described in the 1939 Handbook. It appears to have been discovered independently by several experimenters; its probable first description in print was in the *Review of Scientific Instruments* about a year ago. — Editor.

A Long-Distance Receiving Set That Really Tunes

BY F. C. BEEKLEY, 3JS

The editorial desk harbors a folder marked "Possible QST Material." Perennially we receive a blast from Would-Be-Author Beekley asking us when we are going to dig his masterpiece out of that folder. He says that if we don't want it, he is going to send it to "Wireless Age." For a long time we were not quite able to make up our minds what to do. Beekley now threatens action, so we can't stall him off longer. Without further ado, we invite you to "dive in" and see what he suggests in the way of modern receiving equipment. This receiver was built in 1915 and the story was turned in for publication in the first issue of QST. Ordinarily we don't hold material quite this long before publication, but then most of our articles are much better than this one.

THE problem of interference between stations is becoming more serious every night. With more and more stations using high power, even many amateurs who use receivers with audion detectors are forced to simply stand by until nearby amateur or commercial stations finish. This interferes badly with handling messages — and it takes a lot of the fun out of amateur radio to finally have a fellow two or three hundred miles away answer your call and then never hear him again because some local opens up with a spark-coil.

At the rate amateur radio is growing now, in about two years it won't be worthwhile to be on at all unless you have three kilowatts and a super-receiver. My vote goes for limiting the number of amateur licenses in this country to 4000 or 5000, because if we get beyond that, amateur radio won't be any fun for anybody.

From the top, looking down. Two-point switch at left of rheostat knob doesn't do anything and is there for sake of symmetry.

A good receiver helps a lot, though, in the present overcrowded situation, and perhaps you will be interested in the one just built for 3JS which is proving itself by far the best the writer has ever seen or used.

To those who have only used crystal or electrolytic detectors, the audion is a great revelation. But an audion is of little use unless the receiver can really tune sharply. It does no good just to make all the signals and the static louder, if NAI still comes in all over the tuner! So this receiver has been designed to tune to knife-edge sharpness. As proof that it does, I counted the other evening 7 different stations between 200 and 250 meters, all of them at least loud enough to copy easily, without enough overlap between them to cause serious interference.

This receiver uses a tuned-primary and tuned-secondary circuit and will tune from about 200 to 1000 meters, thereby covering most amateur and commercial stations except the long-wave ones. Primary tuning is by taps only and secondary tuning by taps and a variable condenser. Loading coils can be used for the long-wave stations, but an entirely separate receiver is recommended for that purpose.

The most important improvement incorporated in this receiver is the new ultra-audion circuit. Properly tuned, the strength of signals is amazing — and signals from stations over a

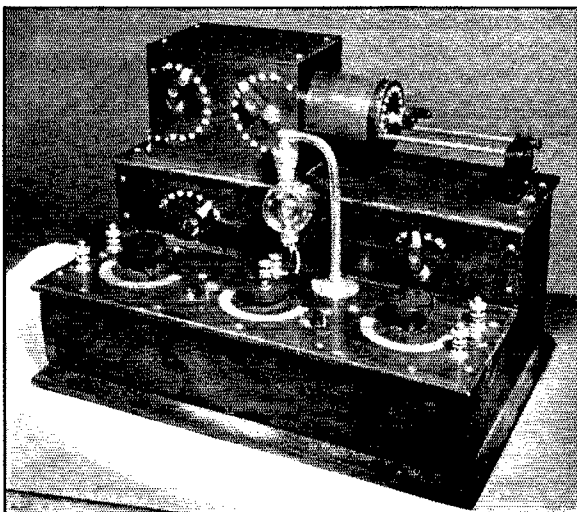

thousand miles away are not uncommon when conditions are good. That may seem a strong statement but it is no exaggeration. The ultra-audion circuit often imparts a peculiar sharp tone to signals which makes them easier to read through static. This is particularly true of signals from quenched gaps which may otherwise be pretty mushy.

The photographs show pretty well the general construction. The "front-stoop" layout was chosen as being most logical. Credit for this design goes to Ye Editor, Clarence Tuska, 1WD, and this receiver is patterned closely after his — except that he does neater wiring than I do. It provides ample space within the box for the high-voltage batteries, and puts the loose-coupler and variable condensers in easy reach. Remember that this is a receiver you've got to tune — you can't just let it set all evening. It is important to keep the variable condensers covered to exclude dust, moths, mosquitoes, etc. The tight wooden cabinet is an advantage in this respect. Do not use oil-filled variable condensers in a set of this kind. While it is true that the oil dielectric will increase the capacity and hence the tuning range, the oil will creep and make a mess of the whole set. It doesn't make much difference what make of variable condenser you use — the ones in the receiver I have are Bunnell Mascots and have a maximum capacity of about .007 mfd. (They don't need to be that big.) This also applies to the other parts — good loose-coupler kits can be bought from manufacturers or large dealers such as Electro Importing Company or Wm. B. Duck Company.

The particular loose-coupler used here is an Arnold Navy Type which seems to me to be about the best. (That ought to help *QST* sell 'em advertising.) For the ultra-audion circuit, it is important to use a loose-coupler in which the secondary can be slid completely out of the primary. Peculiar as it may seem, signals will frequently be louder that way than when the sec-

ondary is inside the primary. (Don't ask me why — I don't know. I tried sliding the secondary off the primary of a spark-coil, but apparently the same thing doesn't hold true.)

The circuit diagram is shown as it seems to work best — although there are several variations of the ultra-audion circuit. The variable condenser which is shown connected from the grid to filament can be connected in several other ways and may work better for you. Most fellows find it operates best when connected across the 'phones and batteries. The best way to find out is to try it in various parts of the circuit. You can tell it is working right when you get a loud click in the 'phones when you touch your finger to the grid connection.

For the tuning range mentioned above, the loose coupler should have about 250 turns on the primary and 500 on the secondary. Some will prefer to use a loose-coupler with a slider on the primary instead of the switches shown. The slider has the advantage of giving very fine tuning but it does not give as professional an appearance. If you use two switches, as shown, make one for steps of two turns per contact and one 20 turns per contact. The secondary switch can be 50 turns or so per contact.

Care should be taken to solder all connections and to do wiring neatly. Particularly in an ultra-audion circuit, you can't get away with just twisted, unsoldered connections because they will surely cause noises sooner or later.

Don't forget to try reversing the filament battery on the audion. It usually works much better one way than the other.

Note that in connecting the taps on the battery switches, only every other contact point should be used. This is to prevent the switch lever from dropping between two points and thereby short-circuiting one cell of the battery. One bad cell in the battery will spoil the operation of the receiver entirely. Speaking of that subject, don't operate the audion at too

high a voltage on either the filament or the plate. Sometimes in an ultra-audion circuit there is a temptation to do this to force it to "regenerate." It shouldn't need to have more than normal voltage and if it seems to need too much voltage, you can be sure the circuit isn't working properly. Try hooking that variable condenser in some other places! If it seems to regenerate all the time and you can't get it adjusted to just the critical point where it is most sensitive, you can adjust it with the filament rheostat. If you do run it at a high plate voltage, maybe

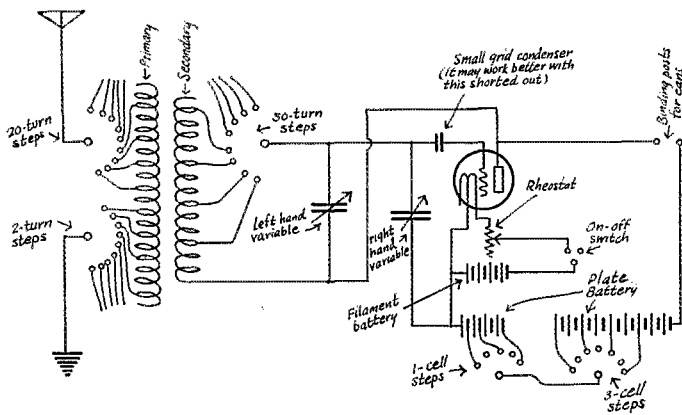
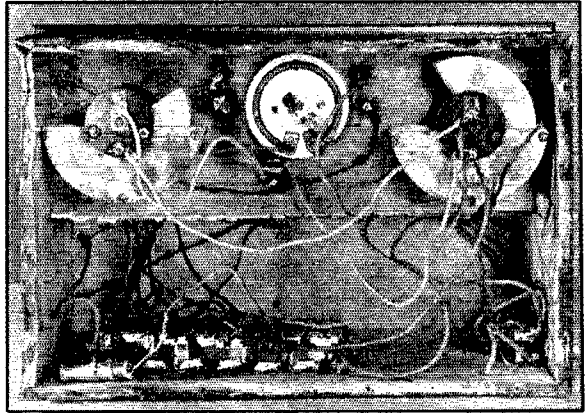

Fig. 1

From the bottom, looking up. Gimmick at lower left corner is grid condenser made from pill-bottle. Generous application of soldering paste provides automatic grid-leak. All wiring is short and direct as will be seen by close inspection.



with blue glow showing in the audion, the audion will probably get too high a vacuum and won't work right. The cure is to "cook" the bulb over a gas stove or over the chimney of an oil lamp. Do this gently; heat it up very slowly and evenly all over, and keep praying it doesn't crack while you are doing it. Just when it is so hot you can't possibly hold on to it another second is when it ought to be "done." And then don't lay it down on anything cold or cool it too quickly.

An external magnet is frequently a great help on an audion. About the best type is one of the large ones from an automobile magneto on which the two poles are wide enough apart to spread completely around the bulb. The audion manufacturers say magnets shouldn't be necessary — but they'll come around to it sooner or later.

As mentioned before, this receiver can be used for long waves by use of loading coils. While it is usually best to load both the primary and the secondary, it is perfectly possible to get good reception with just a loading coil in the secondary circuit. It should be a coil of about 1000 turns on a form 9 or 10 inches in diameter, with either taps to a switch or else a slider, connected right in series with the secondary of the loose coupler so

that the variable condenser is across it as well as the secondary. Tuning the long-wave arc or alternator stations is very critical on the ultra-audion; even the capacity of one's hand near the receiver will affect it. The long-wave, undamped stations seem to tune much more sharply than short-wave stations.

All in all, a receiver like this will add a lot of pleasure to your operating. Many stations can be copied with the phones lying on the table. Here at 3JS such stations as 8ZW, 1VN, 1WH, 2ZH, 8YC, 3DV are heard very well considering the distances and closer stations such as 3JL, 3ZS, 3PP, 3LM, 3XC, 3CH are almost invariably loud enough to hear across the room.

Remember that a good station has to have a receiver with a longer range than the transmitter — no matter how good your transmitter is, you can't talk to 'em unless you hear 'em.

"The Least of These My Brethren"

BY H. W. CASTNER,* WIIIE

WITH the approach of the twenty-fifth anniversary of the American Radio Relay League, my thoughts go back in tender memory to those days of long ago; when A.R.R.L. was holding its "britches" up with a safety pin and Irving Vermilya, 1ZE, was making headlines in bold type with his "wireless telephone" from the New York boat to us hams in Portland, Maine.

Some of us were old timers even then. I was grunting out an assorted bunch of noises as 1BI with a doubt about the two-tenths decrement. And as the scenes of those days pass over the canvas of memory, I see a young man pounding out commercial brass at old WBF on Filene's in

Boston! He became a fine operator and was with me during the war. He is now the band leader for Kate Smith, the one and only Jack Miller. Not long after this I see a young fellow, looking pretty green and wearing his white hat at the wrong angle, racing around the Harvard Radio School trying to keep up with those doggoned bugle calls in "Callahan's Navy" and wondering what they meant by a transformer. He is now W6QUT — "Amos" of "Amos and Andy." Long before this, Fred Schnell out in Chicago had decided he knew all there was about radio and told us so later. If you contact W9UZ, he will convince you! "Shorty" Chisholm, W1FI, had been shaking up the ether around Squantum, Mass. . . . Space will not permit the mention of so many

*Damariscotta, Maine.

others who were listed in the thin white booklet the Government sent us free of charge, containing the names and calls of all licensed amateurs. All concerned were regarded by government and commercial operators as dumb and disagreeable, but necessary.

I shall never forget my one unpardonable sin. This was the time I convinced Jack Swanson, who was my shipmate at the old Marconi station in Belmar, N. J., and who was new and green but very promising, that the "peeping" on a steam radiator was "detonation" from the big antennas overhead and could be read. Jack sat up in bed for a heck of a while trying to copy it! My reason for mentioning it is to bring out the point of my story. As a rule these "flat feet" of yesteryear are the dignified experts of to-day. Anyone who takes advantage of their faith is not a ham in any sense of the word, and we all have a solemn duty to offer all the help and encouragement we can to the assortment of "lids," "sputterers," "young

squirts" and what have you, that are trying to get a start in our grand old game of ham radio.

I received word one day to go to a certain wharf in Portland, Maine, and test a Shipping Board vessel called the "Mayport," with the call letters WTIE. It was reported that the rig was out. When I arrived I found it to be the "Ferris Type" wagon that the shipping board built so many of during the war days, with the "shack" in the superstructure amidships. Anyone who remembers those shacks will agree there were more buttons, switches and gadgets than Carter has pills. It seems that the ship had a new crew and was going to clear, in ballast, for a trip somewhere down in the Caribbean Sea. When I stepped over the bulkhead I found a real barnacle-crusted, two-fisted old skipper, standing there with all the glory of his ilk. Almost crouched in the corner was a young lad who looked as though he had been struck by lightning. It seems that the lad had just graduated from Entwhistle's Radio Emporium in Boston and this was his first assignment. He had come aboard, and just as he entered the density of gadgets he was surprised by a roar, directly behind him bellowing, "What's the matter with this radio!!!" How many of you know the picture? Those rough old skippers with a cast-iron covered heart entirely filled with honey inside. It scared the kid almost out of his pants. He stumbled and muttered and finally got enough air intake to bluster out that the rig was out of order and would have to be inspected and sealed. Consequently I was drawn into the picture.

Knowing a lot about these old fellows and even anticipating something of the sort, it took me about a minute to size up the situation. I went to work. I took one look at the boy and then to the skipper I said, "I don't know this boy but he certainly is reliable. I congratulate him on having the care and thought to call for an inspection. It's lucky you didn't shove off with this rig." I thought I detected that both the boy and OM relaxed, and it apparently did the trick. Anyway, it was enough to shoo off the skipper, and he disappeared. Bear in mind, I haven't even thrown a switch yet! I sat down and looked at the lad and said: "What's the matter?"

"Well," he said, "I guess everything may be all right, but I came in here and took one look at all those buttons and switches, and he hollered at me and I guess it scared me." I looked at the primary of the OT. All the three leads of waves "G," "J" and "M" were sealed and I figured the closed circuit was OK. A hasty test all through showed the rig in working condition. I got old NBD and NAC on a QSO and said I would test on "G," "J" and "M" and for them to QSL on "J," which was then 600 meters. They both said OK all around.

I then had a chance to work on the boy, and

(Continued on page 64)

56-Mc. Tests

May Week-Ends Set Aside for 56-Mc. Get-Together

THE month of May has been the big 56-Mc. period for the past few years, with DX peaking at this season. In anticipation of similar conditions this year an "open period" for "five-meter" work is announced for each week-end in May. All operators are urged to take advantage of this opportunity to give "56" a real work-out at a time when a large number of stations will be active. Tune up your gear and give it a whirl.

It is suggested that special efforts be concentrated on the periods 4:00 a.m. to noon, CST, and 5:00 p.m. to 8:00 p.m., CST, on each Saturday and Sunday during May, although activity should be heavy throughout the entire week-ends. Don't miss the chance to give 56 Mc. a serious test and possibly establish some new DX records for your station.

The handsome gold cup offered by the Milwaukee Radio Amateurs' Club, Inc., to the first United States amateur who establishes two-way 56-Mc. contact between continents (a great circle distance in excess of 2000 miles) is still unclaimed. Although the May tests are primarily for domestic contacts this cup would look FB in your shack! Go to it, and please report to A.R.R.L. HQ's all contacts and reception made during May week-ends. Good luck to all!

★ WHAT THE LEAGUE IS DOING ★

BOARD AGENDA

THE A.R.R.L. Board of Directors has its annual meeting in San Francisco on May 5th and 6th. Following is the list of subjects to be considered, so far as they are known now. It is suggested that members having opinions on the desirability of any of these items convey them at once to their respective directors, for the information of the latter in representing the divisions at the meeting.

After the usual formalities of the roll call, examining the minutes of the previous meeting, accepting the reports of the officers, ratifying the actions of the Executive Committee during the preceding year and the Board's own mail decisions during that period, the Board will hear reports from each director. The background thus established, new business is taken up.

Last year the Board approved in principle the establishment of a system of retirement income for A.R.R.L. headquarters employees, to be based on an arrangement with an insurance company. The first item of new business is to hear the report of a special committee appointed to work out the details; Mr. Martin is the chairman. The headquarters does not know what the committee will propose.

Next place on the agenda is given over to motions originated by directors. The only items in this category known to the headquarters are those concerning amendments to the constitution or by-laws on which formal advance notice has been given, as follows:

1. Mr. Young is sponsoring a proposal to amend the provision in Article IV of the constitution that directors shall serve without compensation from the League in any capacity, to provide that "the compensation of each of the directors of the League shall be the sum of \$1,000.00 per annum, exclusive of expenses allowed by the League. . . ." It is stated that the directors are called upon to perform a multitude of duties, involving a great mass of correspondence, attendance at meetings and conventions, etc. A group of amateurs in the Twin Cities who originated the project states that it is unjust to expect a director to perform his present arduous duties without remuneration.

2. Mr. Arledge proposes an amendment of Article IV of the constitution to strike out reference to the Vice-President in Paragraph 1 which states the composition of the Board of Directors, so that the Vice-President would be eliminated as a member of the Board except during such time

as he was serving in the President's stead in the latter's absence. The purpose is stated to be to exclude the Vice-President from voting on the Board, on the basis that he does not represent a constituency of amateurs. It is part of this proposal that he would be retained as a member of the Executive Committee and would attend the meetings of the Board.

3. Mr. Norwine proposes an amendment of the tenth paragraph of Article IV of the constitution to provide that the Executive Committee, rather than consisting of the officers of the League, shall consist of the President, the Vice-President, the General Manager and two members of the Board — elected each odd-numbered year — who shall reside west of the 85th meridian. It is stated that substituting two directors for the Communications Manager and the Treasurer would increase the geographical representativeness of the committee.

4. Mr. Adams proposes an amendment of By-Law 20 to specify that if there are no eligible nominees for director, additional nominations shall be sought by another solicitation in *QST* two months after the first solicitation and, if necessary, solicitations shall be made at two-month intervals until an eligible candidate is nominated, the candidate elected then to serve the remainder of the term.

5. Mr. Blalack proposes to amend By-Law 12, governing the eligibility of candidates for director, to provide that lapses of not over 90 days in renewing operator licenses, or of 30 days in renewing League membership, shall not make a candidate ineligible. This relates to the provision of four years' continuous membership and operator license. The 30-day grace period with respect to League membership is already provided by the by-laws. It is stated that there are cases where a candidate, although an active amateur, may fail to file his license renewal application in time, or may make an error in the application and have it returned by the F.C.C., causing a technical lapse which should not be the basis for disqualification from the directorate.

After the directors' motions are all acted upon, an appropriation must be made from the League's surplus for the expenses of the meeting. The headquarters estimates the cost at this writing at \$6200.

Next on the agenda is a request by the President that the Board examine the financial position of the League and its policy regarding appropriations from surplus. The President states in his annual report that an organization must

have a surplus for special needs and that the surplus must be built up from year to year to meet increasing needs. He calls upon the Board to examine our surplus to see whether the Board's present policy is meeting this condition.

The President also proposes that nominations in the elections of President and Vice-President be by written ballot, as well as the actual voting thereon. There are no elections this year but he suggests that the Board discuss the question at this meeting with a view to applying the practice at next year's elections.

The Secretary points out the need for the League to be represented at the next Inter-American regional radio conference, to be held in Chile in 1940, and recommends that the Board authorize the attendance of Assistant Secretary Budlong and himself to that end, and appropriate \$2600 for the estimated expenses of their participation.

The Secretary proposes that the Board examine the desirability of increasing the length of term of directors. It is stated that this would provide a greater period of experienced usefulness in the management of League affairs and at the same time would require fewer elections per year, resulting in a slower annual turn-over in the Board and giving greater continuity and purpose to Board policies.

The Secretary asks the Board to clarify its instructions of the previous year concerning the publication in *QST* of the minutes of Executive Committee meetings, also suggesting that it is not a very interesting use of *QST* reading space.

It is proposed that the Board again adopt resolutions expressing its appreciation for the services of the A.R.R.L. standard-frequency stations and the volunteer district QSL Managers.

The Communications Manager requests the Board to study plans for the more effective employment of certain bands, notably to increase the use of 7200-7300 kc. in view of European broadcasting in these frequencies, and in reducing BCL interference in the 1800-2000 kc. 'phone band.

Time is short. Your director will be leaving home in a very few days. You should therefore write him at once, either at his home address or in care the Clift Hotel, San Francisco.

NEW U.H.F. ALLOCATIONS

IN MIDDLE March the F.C.C. issued a new allocation of the frequencies 30-300 Mc. Since 1936 the F.C.C. has studied and restudied the problems of allocation of the ultra-high frequencies to the various services. The idea is to take them out of the general experimental classification and make them available for regular television, high-fidelity broadcasting, aviation, amateur, and other dependable service. You have probably noticed the footnote on the specification of the 112- and 224-Mc. bands in our regs, indi-

cating the possibility of change in final specification of these bands. With other interested services we now have a definite place in the u.h.f. tables. The Commission amended its previously issued Order 19, reevaluating the needs of the various services on the grounds of public interest, convenience and necessity. Radio is considered indispensable to aviation, and in consideration of its status as an essential safety service, the F.C.C. granted additional frequencies to aviation in the range 140-144 Mc. for plane-ground service. Giving aviation additional frequencies involved moving some channels previously earmarked for frequency-modulated broadcasting (which takes about 150 kc. per channel) to 116-118 Mc. This in turn resulted in a reallocation of the amateur services' 2½-meter band to the frequencies of 112-116 Mc., 2 Mc. less for us than was originally contemplated. The Commission with its order stated it believed the provision for amateurs adequate, especially in view of the possible duplication of frequencies at short distances without sky-wave interference, when using this range. The allocation of 56-60 and 224-230 Mc. was reaffirmed. The new F.C.C. table becomes an effective part of the regulations, April 13th.

LICENSE WARNING

IT WILL be remembered that our new regulations now provide that the holder of a Class-C license who is living within 125 miles of an examining point, either by having moved or through the establishment of a new examining office, must qualify for Class B within four months or forfeit his license. The F.C.C. has now decided to apply this provision only to cases where new applications must be filed. If a Class-C holder moved to within 125 miles airline of an examining point prior to December 1st, when the new regs took effect, his license will be permitted to run its course until it is necessary to renew or to apply for a modification by reason of again changing address. In either of these cases the applicant must qualify for Class B through personal examination. Moreover, any holder of Class C who moved to within 125 miles of any examining point after December 1, 1938, must qualify for Class B within four months of such move or forfeit his license. There are so many such cases that you may not receive individual advance warnings from the Commission. It is up to you to make your own arrangements to be examined, and the F.C.C. has requested us to spread this word to the amateurs concerned. Some of the examining offices have only a single inspector, who is frequently traveling for some weeks at a time and not available to give amateur examinations. Consequently it is exceedingly desirable that all amateurs subject to this rule communicate with their inspectors in ample time to arrange for the examination sufficiently early, so as not to cause a

lapse in license. Remember that it takes four or five weeks after examination before the license is received.

PAN-AMERICAN TRAFFIC

WE MAY now handle third-party messages with the amateurs of Haiti and Panama — messages of a type that would not normally be sent by a paid commercial service. This flows from the Inter-American Radio Arrangement of Habana. The arrangement has so far been ratified by the United States, Canada, Chile, Peru, Haiti and Panama. We already had separately-negotiated arrangements with Canada, Chile and Peru, so only the other two countries are new — but there will be more of them as additional countries ratify the Arrangement.

WORLD'S FAIRS

AT THE San Francisco World's Fair, W6USA, an entirely modern amateur station, is being operated by a group of W6 amateurs. At the New York fair it is expected that W2USA, with modern equipment on each band, will be in operation under the auspices of a group forming for the purpose and known as the New York World's Fair Radio Club. This organization also has several hamfests under contemplation, *the first of which is now announced for Memorial Day.* A.R.R.L. has embraced an opportunity to develop plans in collaboration with the American Institute of Science for an elaborate amateur radio exhibit to be shown at the New York Fair. This is to be an animated display of some 50 feet of counter and panel space, illustrating the complete circuit diagram of a transmitter and a receiver. The counter will carry the actual components of transmitter and receiver, wired up and operating, with indicating instruments, oscilloscopes, etc. On the glass panel behind the counter will appear the schematic diagrams, keeping step with the actual apparatus. The diagram is made of 7000 electric lights of various colors and, by intricate circuits and rotary switching devices, is brought to life to illustrate the flow of electricity in the various components: r.f. currents oscillate through inductances, condensers charge and discharge, the functioning of tubes is portrayed, and the effect of modulation is made evident. Our staff designed this exhibit; the actual construction, at a cost of several thousand dollars, is being done by the American Institute of Science and Westinghouse. We hope that it will prove well worth seeing. Look for it when you visit the Fair.

C.C.I.R.

THE United States has begun preparation for the fifth meeting of the C.C.I.R., which is to be held in Stockholm in June, 1940. A.R.R.L. has

been invited to participate on behalf of amateur radio and we are collaborating in some of the studies. The subjects are almost exclusively technical and, so far as we can see, will have no impact upon amateur radio. However, we hope to be able to contribute some useful technical data from the experiences and observations of amateurs on some of the topics under discussion.

PUNCTUATION AGAIN

WE HAVE been asked which punctuation marks should be learned by a candidate for the amateur examinations, the old ones or the new ones that supposedly took effect the first of the year. The answer is that the interrogation mark is the only punctuation character occurring in the amateur code examination, and this has not been changed — so it makes no difference.

CHIMES, ETC., PROHIBITED

THE F.C.C. has decided that amateur 'phone stations may not use chimes, whistles or similar distinctive identifying sounds in signing off. They say that 'phone stations should be used solely for voice communication with the exception of the authorization of single audio-frequency tones for developmental tests and the transmission of tone in formulating code characters for the purpose of conducting code practice in the authorized A.R.R.L. code-lesson stations. They say, "It is believed that distinctive sounds such as gongs, whistles and other unnecessary sounds would add nothing of value to the amateur's communication and, on the contrary, may be considered a form of entertainment."

RECORD PLAYERS

THERE are several makes of phonograph record players on the market, intended to operate on about 540 kc. to transmit a signal across the room from player to broadcast receiver to use the latter's reproduction system. While none of these makes has been approved by the Commission, they operate under its Temporary Rule 25 and, when used for the purpose intended, are permitted if there is no interference to radio reception. Where interference develops through this "legitimate" use, the F.C.C. warns the owners to desist, because such operation without license is in violation of the Act. Some BCL's, however, have been putting antennas on their record players and entertaining their friends over a radius of several blocks. This unlicensed use for broadcasting entertainment, or for private communication, of course is altogether unlawful. Upon receipt of bona fide complaints on this score, the F.C.C. will investigate, collect evidence and prosecute.

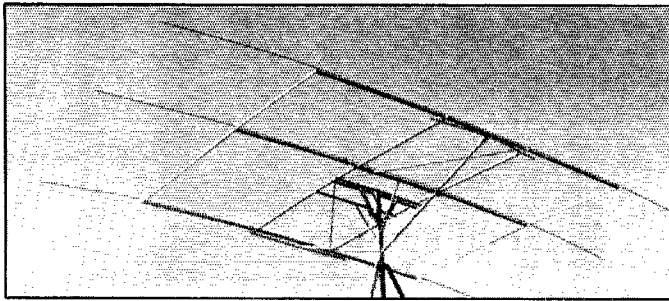

Here's a 14-Mc. rotary that's up in performance, down in expense and, unless the Wyoming winds ain't what they used to be, can take it with the best of them.

An inexpensive 3-element 14-Mc. rotary beam. Plumber's hardened copper tubing is used for the elements.

A Three-Element Rotary Beam for \$16.61

BY ALBERT J. MEYER,* W7GBY

SO MUCH has been said about rotary beams and their results that I decided that, if I was to work any DX on 14 Mc., I had better get one up. On looking over all the dope on beams built throughout the country, the conclusion was reached that one should be able to build one fairly cheaply. After finishing mine, the cost of parts totalled only \$16.61, and so I thought the design might be of interest to other hams looking around for inexpensive rotary-beam construction.

The necessary material and its cost was as follows:

1 4" x 4", 24 feet long	\$2.25
3 2" x 2", 20 " "	1.20
2 2" x 2", 18 " "	.72
2 2" x 2", 6 " "	.24
2 1" x 2", 20 " "	.80
2 1" x 2", 16 " "	.64
2 2" x 2", 10 " "	.40
Pin, cement and sand	.50
101 feet 3/4" plumber's hardened copper tubing	6.06
2 1/2"-long 1/4" bolts	.30
2 3/4"-bolts, 8" long	.10
50 feet of twisted-pair feed line	.80
15 1 1/2" stand-off insulators	.75
Collar for guys	.50

* Powell, Wyo.

Guy wire, No. 9	.75
Labor, blacksmith	.60
Total	\$16.61

The Support

To support the antenna pole, dig a foot-square hole about two feet deep and fill it with concrete. A half-inch steel pin is set in the concrete before it hardens, to serve as a guide for the antenna pole, and a plate of any type of iron is used on the top of the concrete to serve as a bearing surface. The pin projects through the iron plate and above the surface about 5 or 6 inches. A hole is drilled in the center of the bottom of the 4 by 4 pole so that it may rest on the iron plate and rotate about the pin as a center.

To rotate the pole, a large gear is fastened to the pole and a smaller one, on a shaft projecting through the wall of the house from the operating shack, provides reduction and allows the antenna to be rotated from the operating position. We used a pair of gears from an old grain binder, given to us by a farmer friend who had them lying around. (A junk yard might supply them in case

A close-up view of the structure, showing the location of the various braces and cross-members; 2 by 2 braces run from the pole out to the midpoint of the reflector and director supports.

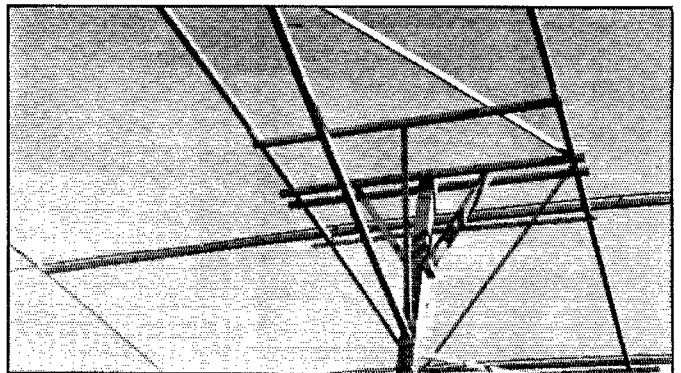

your farmer friends can't.) The center of the large gear was cut out enough so that the gear could be slipped over the 4 by 4, and it was fastened in place by straps welded to the gear and screwed to the pole. The shaft on which the small bevel gear is mounted runs into the shack and has an old automobile steering wheel attached, for easy turning of the system.

The pole bearing for the upper part is an iron collar supported by two wood braces and suitable guy wires. At a point a suitable distance down from the top of the pole, the pole is rounded and the iron collar (made in two half-sections) is bolted together around the pole. The collar should be large enough to allow the pole to turn freely. The wood braces, which act as compression members to hold up the collar, are attached to the eaves of the house with wire. If the house were high enough, the braces could be eliminated by bolting the collar directly to the side of the house. In our case, the combination of the two wood braces and the four guy wires gives a surprisingly rigid product.

Antenna Framework

The framework which supports the antenna elements measures 20 feet by 17 feet 4 inches. It is assembled on the ground, and an idea of the arrangement of members can best be obtained by reference to the photographs and drawings. All members are bolted together, although the stand-off insulators that mount the antenna, reflector and director can be fastened with wood screws. One important thing, after the frame has been completed and the copper tubing used for the beam elements has been cut and put in place, is to be sure that the framework balances about the point where the 4 by 4 pole is to be fastened.

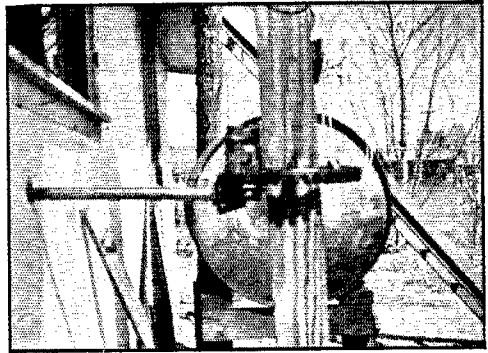

The entire structure is rotated from inside the shack by direct drive to a bevel gear on the supporting pole.

In our case, we did the final trimming by cut and try, moving a spare piece of 2 by 2 out on the light side of the frame until the whole assembly balanced.

The copper-tubing antenna elements are conventional in length. The antenna measures 34 feet, the director, set 10 feet 5 inches ahead, is 32 feet 3 inches long, and the 34-foot 8-inch reflector is 6 feet 11 inches behind the antenna. The antenna is fed by a 70-ohm line which taps on the antenna at points 13 inches each side of center. Some experiment will probably be necessary to remove standing waves, depending on the exact impedance of the line and antenna.

When the antenna framework is completed and balanced, it is attached to the pole and raised. Care should be taken at this point, not only because the assembly weighs about 75 pounds, but because it is easy to break the stand-off insulators.

If the support is well guyed, no trouble should be encountered with winds. It has been given an excellent test here in the Wyoming winds, ones that could never be classified as "zephyrs" or "gentle breezes"!

Results

The results obtained with the beam have been very gratifying. Comparison checks against a half-wave Hertz indicate a power gain of about 10 times, and very few stations worked will believe that the power input here is only 50 watts. We had never worked out of the country before, but HK5EE and several K6's have yielded S9 reports. The beam should of course be used on receiving as well. An antenna relay will make this possible automatically. Signals drop about 4 to 6 S points in the opposite direction, and drop out completely off the sides.

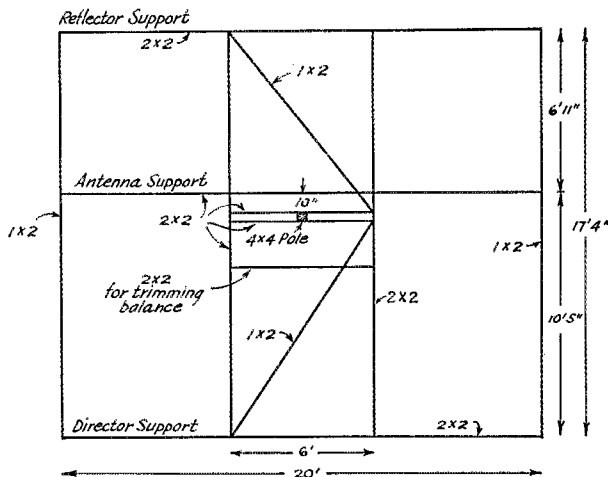

A schematic sketch of the antenna support. The antenna elements, not shown, are mounted on their respective supports with stand-off insulators placed every four feet.

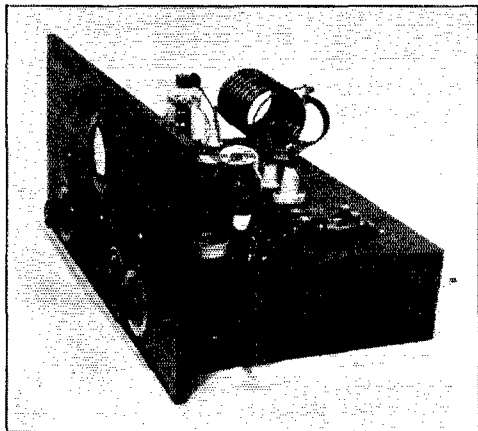

Even if your tastes run to kilowatts and rhombics, it will do no harm to see how one of our Cuban friends licks the cost bugaboo and still retains the desirable conveniences in a low-powered rig. And the keying system can be adapted to almost any transmitter, in case you've been having trouble.

An inexpensive 60-watt transmitter, mounted on a wooden chassis and panel. The double-pole double-throw switch alongside the tank coil switches the antenna tuning from series to parallel.

A Rig for the Lean Purse

Simplified Transmitter Construction for the Low-Power DX Man

BY ADOLFO DOMINGUEZ, JR.,* CM2AD

WE HAD very little difficulty in deciding how much would be spent on our transmitter — our pocketbook settled that question — but we did want as much as possible for the available money. Since 40- and 20-meter operation is our mainstay, it was possible to design and build a simple rig that provides adequate output on both bands with practically a minimum of equipment. The rig is compact, but its 60 watts output has been as effective in our DX work as the output from a larger and more complicated transmitter.

The Circuit

The lineup is a 6L6G regenerative oscillator driving an 809 amplifier. A fixed cathode coil is used to make the oscillator regenerative, and ample output is obtained to drive the final on both 40 and 20 meters, using a 7-Mc. crystal in the oscillator. It is only necessary to plug in the proper plate coil and tune the circuit — no adjustment of the cathode circuit is required. A Mazda No. 46 lamp is connected in series with the crystal as an indication of the crystal current, and the lamp shows no color when the oscillator plate circuit is properly tuned and loaded.

The 809 amplifier is capacity-coupled to the oscillator and plate-neutralized. It will be seen from the wiring diagram that a split-stator condenser is not used, but the center-tap of the plate tank coil has been adjusted so that no resetting of the neutralizing condenser is necessary when

* Milagros 66 E, Vibora, Havana, Cuba.

changing bands. It isn't much trouble to find the right spot, and saves considerable time in tuning after changing bands. While a split-stator condenser would simplify neutralization, it would also cost more. The antenna coil is mounted on a stand-off insulator near one end of the plate coil, and the coupling is varied by swinging the coil about this point. A double-pole, double-throw switch changes the antenna feeder tuning from series to parallel, so that the proper system can be selected without delay.

The transmitter (except for the power supply) is built on a wooden chassis 17 inches long, 12 inches wide and 4 inches deep. All parts are mounted under the chassis except the coils, crystal and antenna switch. The oscillator cathode coil is the only coil mounted beneath the chassis.

The keying system is a combination of oscillator-cathode and amplifier grid-block which gives clean keying and allows break-in operation. If preferred, the oscillator-cathode and amplifier center-tap can be keyed, but our personal preference is for the system described above and shown in the wiring diagram.

Tuning

When first adjusting the oscillator, the plate voltage should be reduced to about 300 volts. After the proper resonance point has been found and logged, the plate voltage can be raised to 375 or 400, always remembering first to set the condenser to the proper point when changing bands

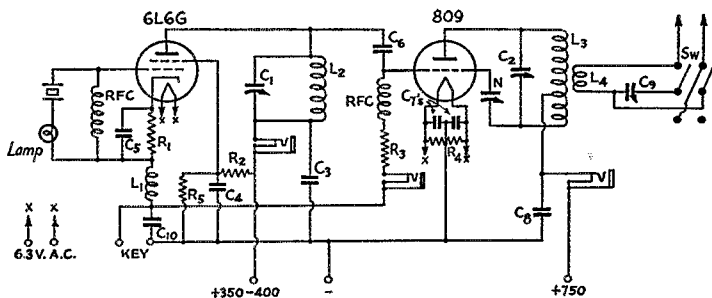

Fig. 1 — Wiring diagram and parts list.

- C₁ — 150- μ fd. variable (National TMS 150).
 C₂ — 100- μ fd. variable (National TMC 100).
 C₃, C₄, C₇, C₁₀ — 0.002- μ fd. mica, 1000-volt.
 C₅ — 40- μ fd. mica.
 C₆ — 50- μ fd. mica.
 C₈ — 0.002- μ fd. mica, 2000-volt.
 C₉ — 325- μ fd. variable, receiving type (Hammarlund MC325M).
 N — 18- μ fd. double-spaced neutralizing (National STN).
 R₁ — 500 ohms, 10-watt, wirewound (I.R.C.).
 R₂ — 20,000 ohms, 10-watt (I.R.C.).
 R₃ — 3000 ohms, 10-watt (I.R.C.).
 R₄ — 70-ohm center-tapped.
 R₅ — 50,000 ohms, 3-watt (I.R.C.).
 RFC — 2.5-mh., 125-ma. r.f. choke.
 L₁ — 10 turns No. 20 d.c.c., 1" diam., 1 $\frac{1}{2}$ " long.
 L₂ — 7 Mc.: 12 turns No. 14 enam., 1 $\frac{1}{2}$ " diam., 1 $\frac{3}{4}$ " long.
 14 Mc.: 6 turns No. 14 enam., 1 $\frac{1}{2}$ " diam., $\frac{7}{8}$ " long.
 L₃ — 7 Mc.: 16 turns $\frac{1}{4}$ " copper tubing, 2 $\frac{1}{2}$ " diam., 7" long, tapped 10 turns from plate end.
 14 Mc.: 8 turns $\frac{1}{4}$ " tubing, 2 $\frac{1}{2}$ " diam., 4 $\frac{1}{4}$ " long, tapped 5 turns from plate end.
 L₄ — 7 turns No. 14 enam., spaced wire diameter, 2" diam. Coil is self-supporting type, mounted on small bakelite strip.
 Lamp — Mazda No. 46.

or crystals. The plate voltage can be removed from the amplifier by inserting a piece of bakelite shaft in the plate meter jack, and the amplifier can then be neutralized in the usual way, preferably using the flicker of the grid current for the indication of neutralization. (The amplifier is

neutralized when, with plate voltage off, the grid current remains constant when the plate condenser C₂ is rotated through the resonance point.) Neutralizing should be done with the antenna coil swung well away from the amplifier tank coil. Plate voltage can then be applied to the final amplifier and, upon tuning to resonance, the

plate current should drop down to 10 or 15 ma. The antenna, when properly tuned, should load the amplifier to about 100 ma. The grid current on the 809 should run between 25 and 35 ma. on 7 Mc. and slightly less on 14 Mc.; if it runs much higher the oscillator plate voltage should be reduced, and if it is less the oscillator circuit and components should be checked. The normal oscillator current runs around 35 or 40 ma. on 40 meters and 50 ma. on 14 Mc.

Any well-filtered power pack delivering 750 volts at 200 ma. can be used with the transmitter. The plate voltage for the oscillator can be obtained by dropping the 750 volts to the required lower value through a 6000-ohm, 50-watt resistor. In our particular case we use a tap on the 25,000-ohm, 200-watt bleeder resistor to obtain the 375 volts for the oscillator. The filament supply requires 6.3 volts at 4 amperes.

If the amplifier is to be modulated for 'phone work, the plate voltage should be reduced to 600 and the antenna coupling adjusted so that the plate current is about 85 ma. The "economy Class B modulator"¹ is used here for 14-Mc. 'phone work, although any modulator capable of delivering 25 watts of audio would do.

All continents were worked on c.w. in three months and many Europeans on 'phone.

¹ Grammer, "Greater Economy in Class-B Modulator Design," *QST*, 1935.

A bottom view of the chassis shows that the tuning condensers are all mounted below the sub-panel. The heavy cable running around the tank tuning condenser is the meter-plug lead which goes to the plug at the rear. The use of insulated shafts running from the condensers to the dials is in compliance with the A.R.R.L. Safety Code.

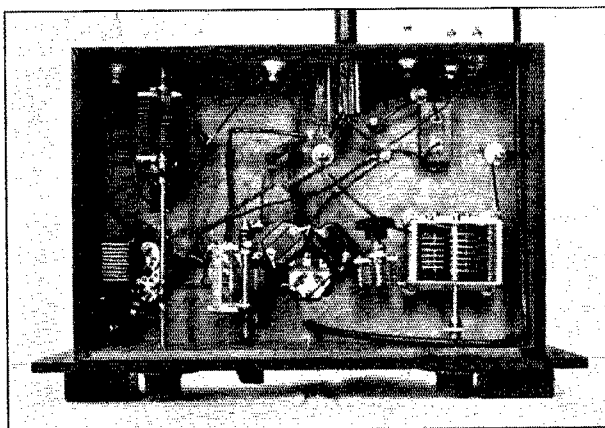

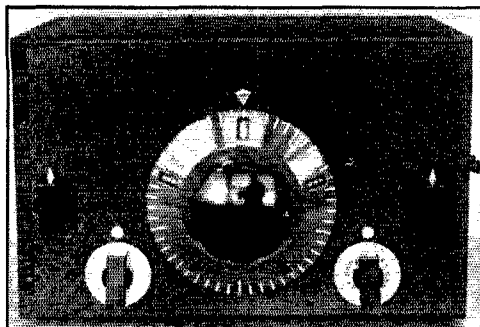

An Acorn Regenerative Unit for 14, 28, and 56 Mc.

BY DANA A. GRIFFIN,* W2AOE

WHEN the subject of preselection is discussed in amateur circles, usually the least important attribute of a preselector is given first-rank importance. The questions and argument almost always revolve around the gain obtainable from the units under discussion. This point is of minor importance, in many cases, to those interested in extreme DX reception. If this fact can be brought home to the gang, this article will have served a useful purpose.

Let us first look into the subject of receivers in general, and consider the ideal receiver for DX reception. Such a receiver would have variable selectivity ranging from high fidelity to 50-cycle band pass. It would have an infinite amount of gain on all bands, and no inherent noise developed in its several circuits. With such a receiver we could, in the absence of external noise, hear with perfect clarity any signal that excited our receiving antenna — but, alas, in the nature of things no one will ever own such a set. We can only look at this ideal as a goal never to be reached, but one which we will constantly approach as the art develops.

We do not have to go back very far in history to the day when the only superhets available were minus preselection. When it became apparent that to minimize image response preselection was required, communications receivers were brought out with an r.f. stage of preselection built in, and the first "preselectors," as separate units to be added to existing receivers, were born. They provided, and still do provide for receivers without preselection, reduction or elimination of trouble with images plus a very desirable increase in gain. The sensitivity of the older receivers without preselection is not high according to modern standards. A sensitivity of 20 microvolts or less is common in sets without an r.f. amplifier, whereas that of a modern communications receiver of the better class is better than one

* Communication Measurements Laboratory, 136 Liberty St., New York City.

Preselection Pointers

Peak performance is assured by panel controls on all critical circuit elements. The knobs at the right and left vary the coupling to the antenna and the coupling to the receiver. The small dials are for antenna-circuit trimming and gain control.

microvolt. It is easy to see that the gain of the preselector unit is important when it is added to a receiver without preselection, since it brings the receiver up to the level of its more modern or costlier competitor insofar as overall gain is concerned.

At frequencies below 14 Mc., say 7 Mc. for example, the modern receiver has all the gain that can be used, and its image ratio does not require improvement. However, even the best receivers do not perform as well on 28 or 14 Mc. as they do on the lower frequencies, because of decreasing tube efficiency and increasing circuit losses as the frequency is raised. As the frequency goes up the selectivity of r.f. circuits goes down, so that the image ratio falls off rapidly on 10 meters.

Signal-Noise Ratio

The overall gain of the better class of receivers drops off slightly at 14 Mc. and somewhat more on 28 Mc., and the signal-to-noise ratio becomes worse. Let's look into this much talked about phrase "signal-to-noise ratio." There are several methods of measuring such ratios, and the one employed by the writer is not the same as that used in broadcast practice. However, hams are interested in c.w. reception as the ultimate in DX work, and the method used is also of merit in the consideration of 'phone where we are interested in understanding a conversation and not in high-fidelity broadcasting. If all tests on

Some things to keep in mind when your thoughts turn toward eliminating those annoying images at the higher frequencies. The moral: A preselector may help out in image reduction, but it may not otherwise constitute an improvement of the receiver unless it's well designed in other respects.

various receivers are made in the same fashion a fair test is assured.

With the antenna input terminals shorted, we turn up the gain fully and measure the noise output voltage of the receiver with a rectifier-type meter, and secure for example a reading of 20 volts. Then a signal input of one microvolt is introduced. The total voltage output may then be 100 volts, giving a ratio of 5:1. If this ratio falls much below 2:1, it is difficult to read the signal on c.w. and nearly impossible on 'phone. Now for the most important point. Suppose we find a receiver with a noise output of only 10 volts, and ascertain that with an input of one microvolt the output rises to 50 volts. The ratio is still 5:1, and the signal is just as *readable* as it was in the first case. By adding a stage of *audio* amplification, which in itself is quiet, we can readily increase the output to 100 volts with one microvolt input. But when the signal is removed, the set noise will be up to 20 volts and all we have added is *volume*. Now what happens if we add another stage of preselection? Unless the r.f. amplifier which is added is *better* than the one in the receiver, and unless it is perfectly in tune, the signal-to-noise ratio will become worse. It is quite true that the S3 or S4 signals can be boosted to an S5-plus level, but this can be done by an audio stage as well. But what happens to the S1 signal depends solely on the effectiveness of the added r.f. stage or stages. The signal may be made to stand out above the noise, or it may be completely masked by the increase in background level. Just as the signal-to-noise ratio may be improved by cutting down the i.f. band width so will it be improved if the circuits of the added r.f. stage have high *Q* and consequently good selectivity. Perfect tuning of all circuits to the incoming signal is also essential, as the noise generated in the preselector keeps going right along into the receiver, even though the signal is not doing the same at maximum level. Preselectors that are out of line can be positive DX eliminators, due to this fact.

Of course the preselector will have some gain, but the modern receiver is so sensitive that this is of secondary importance. Amazing records are made right along with standard receivers that prove this, but on occasion we all wish for that "little extra something" to bring 'em in a little better. It really is not more gain, and one of the best tests is to tune in a variety of steady signals that cannot be

read easily. Broadcast stations on the b.c.l. receiver with the antenna off will do. It is rather easy to see, after experimenting with signals of different levels, that in the case of most of the weak ones if the noises could be subtracted, or even partially reduced, the signal would be readable. What is most needed for better DX is an increase in the signal-to-noise ratio, not an increase in gain or output—the latter can be quickly and cheaply obtained by using an extra audio amplifier.

Considering these points it becomes apparent that the design of a preselector which will improve the DX-getting ability of one of the better modern receivers is no easy task. Both the overall gain and image ratio can be readily increased, but the signal-to-noise ratio, which is the measure of the DX capability of the receiver, can be improved only if the greatest care is taken. Common sense indicates that the "hotter" the set the better the preselector must be to effect a real improvement.

With these things in mind a design was undertaken that gave considerable justification to the "theorizing." The unit shown, employing one acorn tube, has on test doubled the signal-to-noise ratio (measured as described above) of some of the better-class commercial receivers. It will multiply the image ratio approximately 100 times on 28 and 56 Mc., and the gain below 30 Mc. is better than 30 db, falling off only slightly at 56 Mc. This gain is nice to have if the "front end" of the receiver is noisy, since the receiver gain can be reduced slightly and the preselector gain raised with a decided improvement in signal-to-noise ratio.

The circuit is obviously a standard arrange-

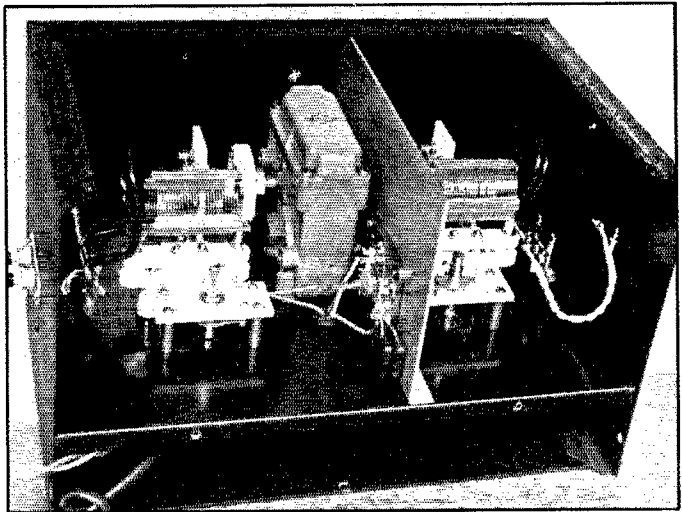

An inside view, showing the antenna circuit at the right and plate circuit at the left.

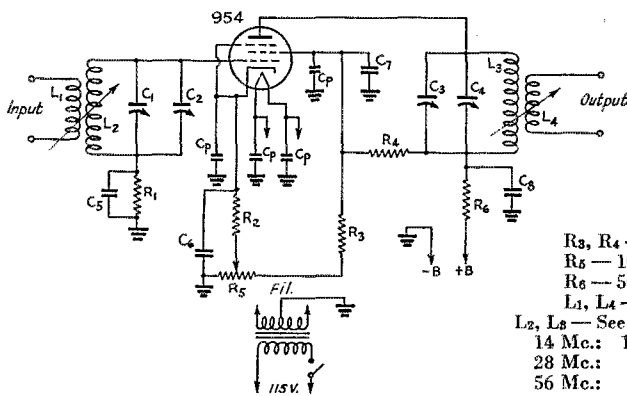

Fig. 1 — Circuit diagram of the acorn preselector.

C_1, C_2, C_3, C_4 — 2-plate midge vari-ables (National UM-15 with all but two plates removed).

C_5, C_7, C_8 — 0.001- μ fd. mica.

C_6 — 0.25- μ fd. paper.

C_p — By-pass capacities in National XMA socket.

R_1 — 1 megohm, $\frac{1}{2}$ -watt.

R_2 — 1000 ohms, $\frac{1}{2}$ -watt.

R_3, R_4 — 0.1 megohm, 1-watt.

R_5 — 10,000-ohm potentiometer.

R_6 — 5000 ohms, $\frac{1}{2}$ -watt.

L_1, L_4 — 2 turns as described in text.

L_2, L_3 — See text.

14 Mc.: 18 turns, $1\frac{1}{4}$ " diameter, $1\frac{1}{4}$ " long.

28 Mc.: 8 turns, $1\frac{1}{4}$ " diameter, 1" long.

56 Mc.: 4 turns, $1\frac{1}{4}$ " diameter, $\frac{3}{4}$ " long.

ment, using the familiar tuned-grid tuned-plate amplifier connection. But the desired regeneration is not secured by introducing a sizable amount of feed-back and then crippling the tube as an amplifier in order to get it to stop oscillating. On the contrary, the stage is made into the best possible amplifier by using good parts carefully laid out. Then with the top rated plate and screen voltages applied and the two circuits perfectly aligned, the tube will just oscillate at the rated minimum bias voltage. This occurs despite the use of a specially-designed socket and careful shielding. The feed back is due to the high circuit efficiency and the high tube conductance and takes place through the small effective grid-plate capacity. The fact that the stage is first of all a good amplifier accounts for the high signal-to-noise ratio.

Constructional Data

So much for results; now for a little constructional data for those who might be interested in taking a fling at building a similar unit. First off, referring to the photograph, the two pointer knobs control the variable links, the one on the left being the antenna input control. The one on the right controls the input to the receiver. To dispel any horror that may be accumulating at the thought of five controls on one little tube, it might be said that these two can be set for any band and generally be left alone unless the antenna is changed. However, it might be well to warn those that expect a lot from the flip of the dial that this unit is not for them. It will only deliver for those interested in the last word in DX, and who have a reasonable amount of patience. To get back to controls, the PW drive controls the tuning condensers, C_1 - C_3 . C_2 , the antenna trimmer, is controlled by the small dial to the left of the PW drive. The other panel control is the regeneration and amplifier gain control wrapped up in one; namely, the variable cathode-bias resistor R_5 . The plate trimmer, C_4 , is located inside the cabinet on the plate side of the shield and

is adjusted once when the coils are changed.

Referring to the circuit layout, we see on the left-hand side of the shield the grid circuit components. Directly back of the tuning condenser is the antenna trimmer, which is mounted upside down. The shaft goes down below the chassis, and is "bent around a corner" to the panel by means of a flexible coupling. The combination C_4R_1 is included to protect the tube in case of high r.f. input from a transmitter; the grid cathode circuit becomes a diode, cutting off the plate current. However, the "diode" also draws electrons, and large r.f. inputs should be avoided, to increase tube life. The XMA socket with its built-in by-pass condensers is mounted on the plate side of the baffle shield together with the two plate-tuning condensers, the plate coil, and the output link. C_8 is also mounted directly at the cold end of the plate coil and returns to the socket ground. And last, condenser C_7 is mounted right at the socket. The two trimmer condensers (C_2, C_4) are spaced above the chassis by $\frac{3}{4}$ -inch spacers. All of the other parts mount below the chassis.

Aside from the usual warning as to short leads, little else is necessary in the way of constructional data except that concerning the coils. Inasmuch as the tuning and trimming condensers are very small, and since the tube capacities are very low, unusually large coils are employed. The National AR16-40 coils are used for 20 meters with all but 18 turns cut off. The AR16-20's are used on 10 meters with 8 turns and the AR16-10's on 5 meters with 4 turns. As these coils are $1\frac{1}{4}$ inches in diameter, the amount of L in the circuit can readily be appreciated. The coils which are supplied with the end links should be used (these links can be removed), and all of the turns that are cut off should be removed from the same end. Care should be taken to remove the turns from one end of one coil and the opposite end of the other coil for every band. Then the variable links will couple in properly and the coils will be interchangeable. The band spread is 200 degrees on 14 Mc. and 350 degrees on 28 and 56 Mc. The

variable links are mounted in a rather unusual but effective fashion. A double terminal strip is soldered on the end of a brass shaft and this shaft is brought out to the panel through a panel bushing. A take-up collar is provided back of the panel bushing. The coils are then made by covering the wire to be used with spaghetti and forming to the proper shape. They are soldered to the terminal strip together with two flexible leads which connect to the terminal strips brought out at the rear.

When the unit is completed it is an easy matter to put it into operation. The filament transformer is first connected to the line and the filament lighting checked. Then a voltage of 200 or so is applied to the plate feed wire. With C_4 set at a position somewhere near the minimum value, antenna trimmer C_2 should be rotated, or rocked, as the tuning dial is tuned. A marked increase in noise or a "bump" will be heard when the preselector is tuned to the same frequency as the receiver. The "bump" indicates that the tube is oscillating and the bias should be increased. When oscillation occurs it indicates that the grid and plate circuits are aligned, and by stopping the oscillation and retrimming slightly the maximum result will be obtained. Of course the preselector can oscillate and still not be in resonance with the receiver, but that can easily be corrected by "rocking" the preselector tuning until maximum output is obtained. A change in the antenna coupling will necessitate a slight retouching of the antenna trimmer. Once it is aligned, the setting of C_4 should be noted for each band so it can be returned to without fussing every time the coils are changed. A few hours of handling will enable any competent operator to get more benefit than pages of printed matter.

A final word as to the actual operation: A number of DX fans in the second district have already proved that the little black box does really help in pulling in the rare ones.

Oklahoma State Convention

(West Gulf Division)

Tulsa, Okla., June 3rd and 4th

AGAIN the Tulsa Amateur Radio Club is sponsoring an Oklahoma State Convention to be held at the Hotel Tulsa, Tulsa, Okla., on June 3rd and 4th. This convention has the full approval of Director Green and the A.R.R.L. executive committee. The committee in charge is preparing a program to do justice to this affair. The committee, therefore, extends a cordial invitation to amateurs in this as well as in surrounding states to attend this convention. Registration fee, \$2.50. Write to Oren B. Gambill, W5EGQ, 2514 North Garrison Avenue, Tulsa, Okla., for further information.

John C. Stadler, VE2AP

JOHAN C. STADLER, VE2AP, one of Canada's most outstanding amateurs, was killed in an airplane crash in northern Quebec on March



5th. Capt. Hervé St. Martin, VE2NI, and Oscar Therrien, pilot-mechanic, also met death when their airplane cracked up during a forced landing near Lac a La Croix.

The trio was returning from a week-end holiday flight to St. Felicien, not far from Quebec's northeastern mining district of Chibougamau. There a party of amateurs including Alex Lariviere, VE2AB, and Paul Tellier, VE2KO, had combined radio experiments with a week-end outing at an isolated sportsman's camp. Lariviere and Tellier were flown back earlier by co-pilot Therrien.

As the tragedy was reconstructed by rescue pilots, the four-seater Waco had apparently hit a tree while a forced landing was being made on a small ice-covered lake. A score of men with dogsleds, toboggans, skis and snowshoes ploughed their way through scrub, bush and timber from Lac les Huardes to the little unnamed lake to bring out the bodies.

Funeral services were held on Monday, March 13th.

At the age of 32 John C. Stadler had already achieved distinction in the world of radio, both amateur and professional. The son of a noted mining engineer, he attended Mount St. Louis College and McGill University, graduating from the latter as an electrical engineer in 1930. Thereafter he was associated with the Quebec Electrical Commission, remaining with that agency until

(Continued on page 114)

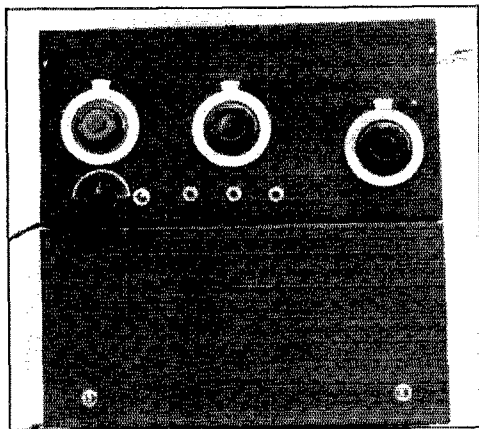

The two-tube emergency transmitter includes its own power supply, and may be used as the regular station exciter unit. The complete panel space is only 14 by 14 inches.

THE greatest need for self-contained and self-powered equipment occurs in time of emergency, and the transmitter to be described has its design predicated on emergency use. The design and construction of such equipment calls for a somewhat different approach than that of the regular station equipment and, after a few weeks of drawing and re-drawing layouts, a design was obtained which satisfied all of the following requirements which I had imposed:

1. Very rugged construction.
2. Light-weight and compact.
3. Components capable of 48 hours continuous use without any danger of failure.
4. Complete flexibility, including electron-coupled and Tri-tet oscillator, band change and, of prime importance, "break-in" with a T9x note.
5. Total a.c. load, including receiver, not to exceed 300 watts.

Ruggedness in construction is an absolute necessity. The two units of the transmitter are built on metal chassis with tempered "presd-wood" panels and housed in hinged-lid steel cabinets, securely held together by two latches on either side. Brass handles make it easy to trans-

* 304 Wood St., Pittsburgh, Pa.

Building Reliability into the Portable Rig

A Complete Two-Tube Emergency Transmitter

BY W. K. THOMAS,* W8QAN

port. Lock washers are used under every nut, and coils are *not* self-supporting but are all wound and cemented on substantial forms.

Isolantite buttons or rubber grommets and spaghetti tubing are used to insulate all wires passing through the chassis. The two units are tied together electrically by a five-wire plug-in connector cable.

The steel cabinets are each 7 inches high, 7½ inches deep and 14 inches wide, housing 7 by 13 by 2 inches chassis. The combined weight of the two sections is 57 pounds.

All parts were selected for minimum size and weight, yet they are sufficiently heavy electrically to be completely reliable and not overloaded. The total a.c. load with 50 watts input to the final amplifier is 202 watts, leaving a margin of 100 watts for the receiver and illumination from a 300-watt gasoline-engine-driven unit.

Portable-emergency equipment is no longer a weird assembly of extra parts from the station junk-box, but rather a well-designed complete transmitter that can be used in the station as an exciter unit or removed for portable work at a moment's notice. Here's an example of the new order in emergency gear, built by an Emergency Coordinator, with the accent on dependability.

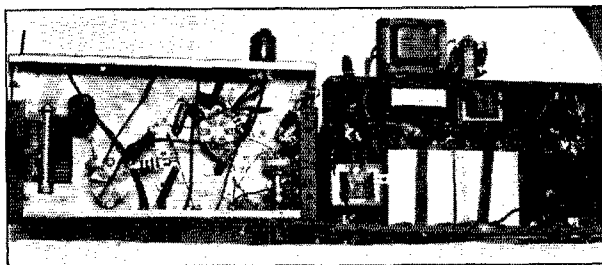

The bottom view shows how the chassis is cut away to take the final tank condenser rotor plates. Some of the fixed mica condensers (C₁, C₂ and C₆) do not lie flat but are mounted at right angles to the chassis.

A plan view of the two units shows the compactness of the transmitter. The large resistor in the r.f. unit is part of the final power-supply bleeder (R_5) and the smaller resistors are R_3 and the other half of R_5 . Note the shield between the oscillator-plate tank condenser and the crystals and grid-condenser. The bias supply extends out past the back of the power supply chassis.

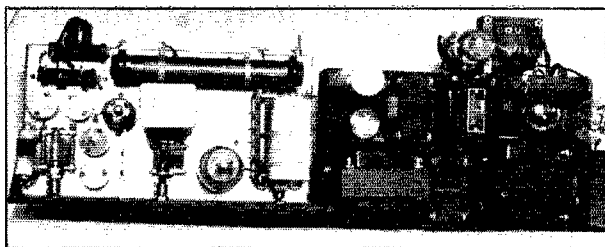

The 89 Oscillator

Tri-tet operation of the oscillator was dictated because, while the transmitter was designed primarily for 80- and 40-meter use, it was considered desirable to have higher-frequency output available and to complete the versatility of the oscil-

lator, it should also be capable of working as an e.c.o. A few minutes with the "Lightning Calculator" showed that a properly designed grid inductance for 160-meter e.c.o. operation was just about right for use as an 80-meter Tri-tet cathode coil, providing the fixed shunt capacity of 500 $\mu\text{f.d.}$ could be cut out of the circuit. Likewise the

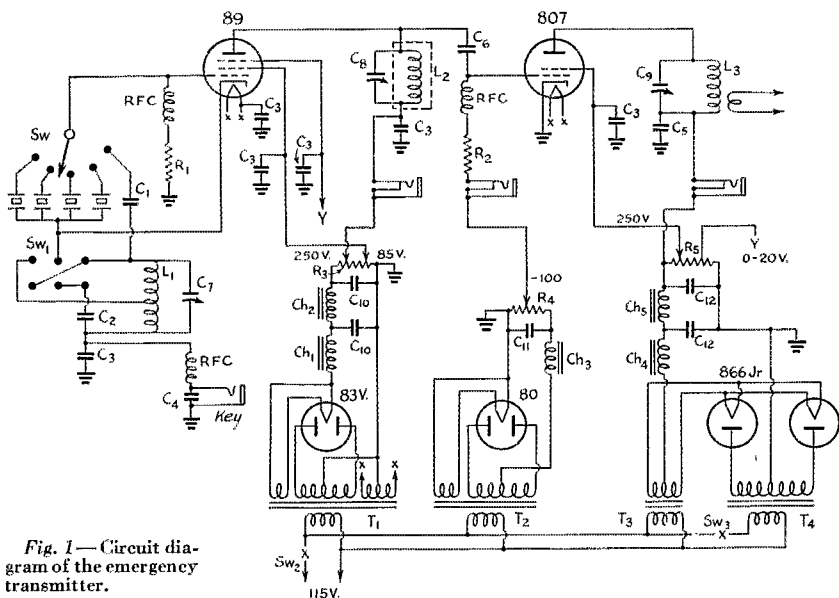

Fig. 1—Circuit diagram of the emergency transmitter.

- C_1 — 0.00025- $\mu\text{f.d.}$ mica.
- C_2 — 0.0005- $\mu\text{f.d.}$ mica.
- C_3 — 0.01- $\mu\text{f.d.}$, 600-volt, tubular.
- C_4 — 0.2- $\mu\text{f.d.}$ (keying filter), tubular.
- C_5 — 0.002- $\mu\text{f.d.}$ mica high voltage.
- C_6 — 0.0001- $\mu\text{f.d.}$ mica.
- C_7 — 0.0002- $\mu\text{f.d.}$ midget variable (National STH200).
- C_8 — 0.0001- $\mu\text{f.d.}$ midget variable (Hammarlund MC100M).
- C_9 — 140- $\mu\text{f.d.}$ variable (Cardwell MT70GD with stators in parallel).
- C_{10} — 8-8 $\mu\text{f.d.}$ (PEB6808).
- C_{11} — 8- $\mu\text{f.d.}$, 450-v. paper.
- C_{12} — 4- $\mu\text{f.d.}$ (small size, metal cased).
- R_1 — 50,000 ohms, 2-watt (I.R.C.).
- R_2 — 10,000 ohms, 2-watt (I.R.C.).
- R_3 — 25,000 ohms, 25-watt (I.R.C.).
- R_4 — 15,000 ohms, 50-watt (I.R.C.).

- R_5 — 20,000 ohms, 160-watt (Ohmite) and 10,000 ohms, 25-watt (I.R.C.).
- RFC — 2.5 mh. (National R100).
- T_1 — 375-375 v., 150 ma. (Thordarson T13R15).
- T_2 — 325-325 v., 40 ma.
- T_3 — 2.5 v. at 5.25 amp. (Thordarson T16F08).
- T_4 — 830-830 v. at 200 ma. (Thordarson T16P00).
- Ch_1 — 5 to 20 henrys, 100 ma. (Thordarson 350 EL).
- Ch_2 — 12 henrys, 100 ma. (Thordarson 360 EL).
- Ch_3 — 12 henrys, 50 ma.
- Ch_4 — 5 to 20 henrys, 200 ma. (Thordarson T16C20).
- Ch_5 — 12 henrys, 130 ma. (Thordarson T17C00B).
- SW — 5-point switch (Yaxley 3215 J).

- SW_1 — D.p.d.t. toggle.
- SW_2, SW_3 — S.p.s.t. toggle.
- L_1 — 160 meters E.C.: 29 turns No. 24 d.c.c., $\frac{3}{4}$ " diameter, tapped 10th turn.
- 80 meters E.C.: 12 turns No. 22 d.c.c., $\frac{3}{4}$ " diameter, tapped 4th turn.
- L_2 — 80 meters: 44 turns No. 20 d.c.c., $1\frac{1}{4}$ " diameter, spaced to length of 2".
- 40 meters: 27 turns, same as L_2 , spaced to length 1".
- L_3 — 80 meters: 22 turns No. 16 d.c.c., $1\frac{1}{2}$ " long, close-wound, XR13 form.
- 40 meters: 17 turns No. 14 d.c.c., $2\frac{1}{4}$ " long, spaced wire diameter.
- Y — Oscillator suppressor-voltage tap, to be adjusted for best e.c.o. stability and output.

80-meter grid coil could be used as the 40-meter cathode coil. A simple switching system was devised, using a d.p.d.t. toggle switch, and the oscillator can be changed from 160-meter e.c.o. to 80-meter Tri-tet (or 80-meter e.c.o. to 40-meter Tri-tet) and back by a flip of the switch.

The cathode coils are wound on National GS3 insulators with silk-covered wire, heavily doped, and there is practically no chance for any variation in characteristics. The coils are fitted with plugs, and plug into through-panel jack-fitted insulators. The plate coil, L_2 , is housed in a National PB-10 plug-in base and shield.

The crystal switch selects any one of four crystal frequencies, for Tri-tet operation and output on either 3.5, 7 or 14 Mc., and in the fifth position allows e.c.o. operation and output on 3.5 and 7 Mc. The small toggle switch must also be thrown when switching from Tri-tet to e.c.o.

807 Final

In order to save space in the 807 amplifier stage, it is necessary to mount the tank condenser with the rotor plates swinging under the chassis through a rectangular hole. This also permits very short leads to the tank-coil base which is mounted directly on the condenser. The tank coil is plug-in, using the National XR13 assembly. The coils are wound with cotton- or silk-covered wire, heavily doped. Leads from the fixed link, for coupling to the antenna unit, or to another amplifier when the unit is used as an exciter, are brought out to two feed-through insulators on the side of the cabinet.

There isn't enough room for meters on the panel, so meter-jacks are mounted on the front presdwood panel through holes in the metal chassis large enough to clear the jacks. The key-jack is mounted directly on the side of the chassis, and a corresponding hole extends through the cabinet at the bottom left-hand rear side.

Power Supplies

Separate power supplies are included for oscillator and amplifier, in the interests of chirpless keying and a T9 note. Since only the oscillator is keyed (keying both oscillator and amplifier in their cathode circuits gave a signal that didn't come up to standard), the amplifier must be biased to cut-off. A small bias supply is included, and it is necessary to mount the bias-supply transformer and rectifier on the rear lip of the chassis and extend them outside the cabinet in a separate screw-on shield box.

A toggle switch on the right-hand side of the panel controls all filaments, the bias supply and the oscillator supply, and another toggle switch on the left-hand side controls the amplifier plate supply. The latter switch was included so that the oscillator could be tuned without putting the transmitter on the air.

All ground connections in both units are made

directly to the chassis, and bolts extend out at the rear of both chassis for connecting the two chassis together, since the five-point connector cable accommodates only the 6.3-volt heater leads, oscillator-plate and amplifier-plate and bias connections.

Performance

The tuning and adjustment of the transmitter is of course similar to that of other rigs of the same general type¹ and need not be repeated here.

The transmitter has been operated with from 20 to 60 watts input, and the performance has more than justified the care in design and construction. The rig might well be the permanent station exciter unit, operated from the desk, and ready to go into emergency action at a moment's notice without the trouble of loosening mounting screws and binding posts, pulling up power leads and disconnecting other odd wires. It is a useful adjunct to any emergency-conscious station.

¹ Grammer, "Operating Notes on the Transmitting Type Beam Power Tube," *QST*, December, 1936.

Dakota Division Convention

**Minneapolis, Minn., May 12th,
13th, 14th**

THE Mid-American and Dakota Division A.R.R.L. Convention will be held at the West Hotel, Minneapolis, Minn., May 12th, 13th and 14th. As in previous years, a prize for the ham coming from the greatest distance will be awarded. A liberal and varied assortment of prizes will be distributed at the banquet.

An innovation will be presented at the convention in the form of a movie film made up of ham stations and their operators in action. It is believed the film will serve to bring together those hams who have engaged in numerous QSO's without ever having met. In addition to this, a rogues' gallery of ham photos will be set up as a further effort in this direction. Anyone wishing to send in photos or film for showing at the convention may be assured of its safe return after its showing. Write to the committee for particulars. Transcriptions of prominent 'phone stations will be played.

Speakers of well-known ability have been arranged for, and it is also planned to hold a trade show in connection with the convention. The convention is expected to surpass all previous attempts to show everyone a good time. Bring the XYL and the YL, take in the "Rathskeller," the banquet and the time of a lifetime at this year's convention.

More information may be obtained from A. Emerson, 5336 Elliot Avenue, Minneapolis, Minn.

Velocity Modulation of Electron Beams

A New U.H.F. Development

THE problems of operation at wavelengths of the order of centimeters now seem likely to be solved by the development of tubes working on a new principle — modulation of velocity of the electron stream as contrasted to modulation of the conductance of the plate-cathode space. The limitations on performance of ordinary tubes imposed by transit-time effects at the ultra-high frequencies bid fair to be overcome by tubes operating on this principle.¹ Stated briefly — and very approximately — the grid in such a tube changes the *velocity* of the electrons passing from cathode to plate in accordance with input-signal potential variations but, because of its special structure, has practically no effect on the *number* of electrons so passing. The changes in velocity can be converted into a conventional current change at the plate by several different methods, involving different types of tube structure and different modes of operation.

Experimental tubes constructed in this way show an input impedance of the order of 50,000 ohms at wavelengths as short as 5 centimeters. They can be used as oscillators, amplifiers and detectors; the operating frequency is to a considerable extent a function of the tube dimensions, but a frequency range of about 5 to 1 is obtainable in a given tube by varying the electrode voltages. No commercial tubes are available as yet, the development still being in the laboratory stage.

The velocity variation principle is also inherent in the "Klystron," a new electronic device which recently had a great deal of publicity in the newspapers of the country. Technical data have not been released on this development as yet, although some general information has been made available. We are indebted to W2OQ for the following summary:

Rhumbatrons and Electrons

A dynamic group of researchers at Stanford University — brothers Russell H. and Sigurd F. Varian, research associates, Assoc. Prof. William W. Hansen, and Prof. David L. Webster, head of the physics department — have developed a new type ultra-high frequency generator and receiver working on principles strikingly different from those of the ordinary vacuum tube.

The discovery is known as a Klystron, or Rhumbatron. It was first described before the

January colloquium of M.I.T.'s department of Electrical Engineering by Dr. Webster. It was announced to the public from Palo Alto on January 29th, and to readers of the M.I.T. Technology Review in the February issue, as well as in the Journal of Applied Physics.

In the Klystron, a beam of electrons representing a constant current is sent through two resonant metal containers known as Rhumbatrons. In the first is an oscillating electric field, parallel to the stream and of such strength as to change the speed of the electrons by appreciable fractions of their initial speed, accelerating some and slowing others. After passing this Rhumbatron, the electrons with increased speeds begin to overtake those with decreased speed which are ahead of them. This motion groups the electrons into bunches separated by relatively empty spaces. A considerable fraction of the energy of these groups can then be converted into power at high frequency by passage of the stream through the second Rhumbatron, within which is an oscillating electric field so changing synchronously as to take energy away from the electrons in the bunches.

If the first Rhumbatron (which is called the buncher) is driven by an external source of power, such as an antenna receiving radiation, and the electrons are strong enough to give the second Rhumbatron (which is called the catcher) more power than the antenna gives to the buncher, the Klystron is acting as an amplifier.

If the buncher is driven by power received through a coupling loop or otherwise from the catcher, the Klystron is acting as an oscillator.

And finally, if the buncher is driven by power from both of these sources at once, the Klystron is acting as a regenerative amplifier.

Advantages of the Klystron principle are threefold. It produces strong waves; they are at stable frequencies; and they have strong amplification at the receiving end. The present working minimum wavelength employed by airlines in radio work is about one meter, but the Klystron produces waves one-tenth that length. Such waves, when emitted from a reflector one meter in diameter, would radiate within a narrow angle of only six degrees. The Klystron inventors believe wavelengths considerably less than 10 centimeters can be reached, thereby still further narrowing the angle of radiation.

— *Newbold Wheelock, W2OQ/WLNS*

¹ W. C. Hahn and G. F. Metcalf, "Velocity-Modulated Tubes," *Proc. I.R.E.*, February, 1939.

A Compact and Economical 500-Watt All-Band Transmitter

Practical Application of Inductive Neutralization

The compact, economical 500-watt transmitter pictured here requires only one coil and crystal change for any band. The transmitter should have a front panel and the condensers should have insulated shafts, if the transmitter is to comply with the A.R.R.L. Safety Code.

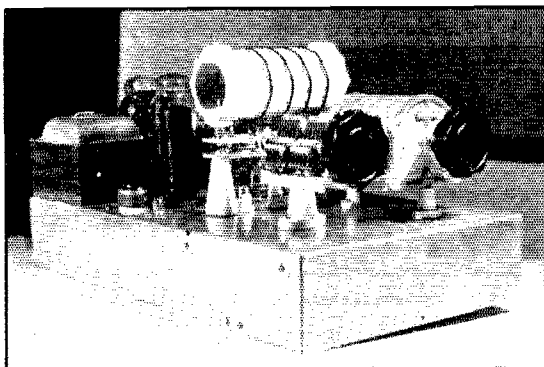

BY "CHUCK" JONES,* W6GNR

The Oscillator

ONE of the goals of all technically-minded amateurs is to simplify the transmitter as much as possible for a given power output and performance. Not only does it reduce the cost of the transmitter but it simplifies operation as well. The transmitter to be described is believed to be almost the ultimate in simplicity and economy. Designed for both c.w. and 'phone,¹ it delivers 400 watts on all bands from 160 to 10 meters, using a 6L6 oscillator and HK254 inductively-neutralized amplifier.

* Route 9, Fresno, Calif.

¹ The output of any two-tube combination should be carefully checked for frequency modulation when used on 'phone, particularly on 14 and 28 Mc. There is a much greater possibility for frequency modulation in the transmitter described than there would be if a buffer stage were included between the oscillator and the modulated amplifier. — EDITOR.

A straight 6L6 crystal oscillator circuit is used, working on the fundamental crystal frequency with no regeneration.² With 675 volts on the plate, more than 30 watts (20 watts at 500 volts) is obtained on all bands, and this is more than enough to drive the final amplifier at 500 watts input. By grounding the tube shield to the cathode, keeping the screen voltage down to 250 volts, and not using a grid-leak bias resistor, the r.f. crystal current stays well below the recommended value. Six hundred and seventy-five to 500 volts on the plate seems to give the best ratio of watts output to crystal current without exceeding the crystal-current ratings.

² The use of a small value of cathode by-pass condenser in combination with a wire-wound resistor will ordinarily result in some feed-back. In this case, however, the author substituted a carbon resistor for a wire-wound one with no apparent difference in performance. — EDITOR.

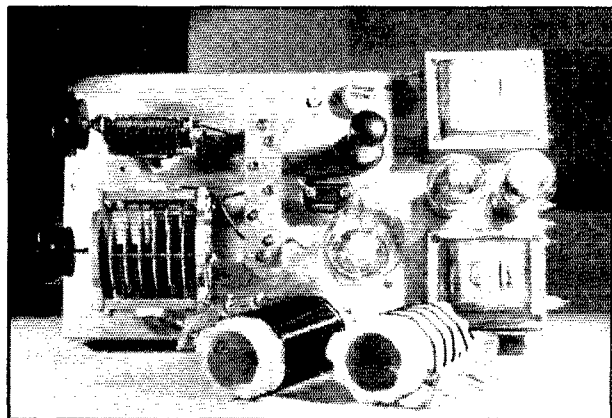

◆
The plan view of the 500-watt transmitter shows the convenient arrangement of parts which allows short r.f. leads to be used. The small mica coupling condenser, between the 6L6 and HK254, is mounted on a porcelain stand-off insulator to prevent short-circuiting to the chassis.
◆

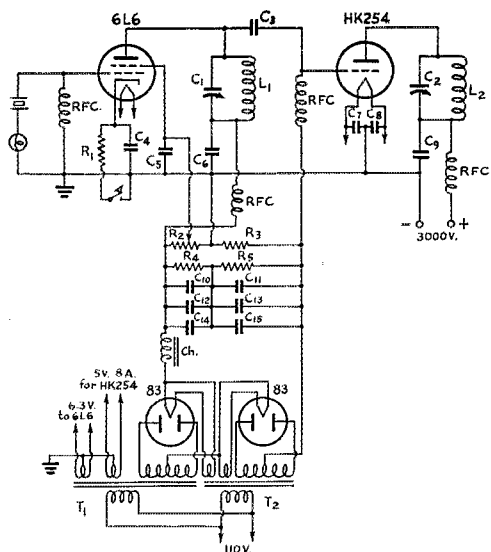

Fig. 1 — Circuit diagram of the 500-watt transmitter.

- C₁ — 100- μ fd. variable, double-spaced receiving type.
- C₂ — 50- μ fd. variable, 6000-volt spacing.
- C₃ — 250- to 1000- μ fd., 5000-volt mica.
- C₄ — 150- μ fd., 1000-volt mica.
- C₅, C₆ — 0.006- μ fd. mica.
- C₇, C₈ — 0.002- μ fd. mica.
- C₉ — 0.002- μ fd., 5000-volt mica.
- C₁₀ to C₁₅ — 8- μ fd. dual electrolytic condensers (have been changed to 4- μ fd., 1000-volt since photographs were taken).
- R₁ — 400-ohm wire-wound, 10-watt.
- R₂ — 12,000-ohm adjustable wire-wound, 50-watt.
- R₃ — 2000-ohm wire-wound, 50-watt.
- R₄, R₅ — 0.5 megohm, 1-watt carbon.
- Ch — Two 30-henry, 85-ma. chokes connected in parallel.
- T₁, T₂ — Heavy-duty receiver transformers, 100-volt, 150-ma.

One might think that 675 volts is too much on the plate of a receiving tube, but it was found that, even though it has a bakelite base, the 6L6 compares favorably with many of the beam tubes designed especially for transmitting purposes. The 6L6 was therefore selected as being the most

From a safety standpoint this medium-powered rig might well be improved upon without adding financial burden or physical dimensions to any great extent. From a practical operating standpoint the use of inductive neutralization stands out as being a worthwhile feature when it comes to flexibility — only one coil to change in the whole rig when changing bands.

economical, and one gave no trouble during a test trial of 236 hours of continuous operation on the 10-meter band. Because the oscillator plate tank is always heavily loaded, no trouble is had with arcing at the base of the tube. Several makes of good tubes and crystals have been tried with no apparent difference in performance.

A dial lamp is used in series with the crystal to indicate crystal current. The crystal does not heat appreciably so long as the lamp brilliance does not exceed the normal value.

The HK254 Amplifier

The amplifier is simplified by the use of inductive neutralization,³ a single-section tank condenser, and capacity coupling to the oscillator. With the inductive neutralization used, no neutralizing condenser or link is required, and the tank coil does not need to be tapped. The oscillator and amplifier coils are mounted on the same plug-in base, with the oscillator coil mounted inside the amplifier coil to give the proper coupling and phasing for neutralization. If the coils are wound in opposite directions, the plate leads will be the two outside ones. In this installation, the oscillator coil was made small and mounted inside the amplifier coil for ease of adjustment, but it could have been made the same diameter and wound adjacent to the amplifier coil. Coil winding data are given in the table.

The final amplifier is biased nearly to cut-off by

³ Craft and Collins, "Inductive Neutralization of R.F. Amplifiers," *QST*, July, 1936.

Filter condensers and chokes for the oscillator-plate grid-bias power supply are mounted under the chassis, on the left-hand side. The HK254 socket is dropped down below the level of the chassis so that short grid and plate leads are obtained.

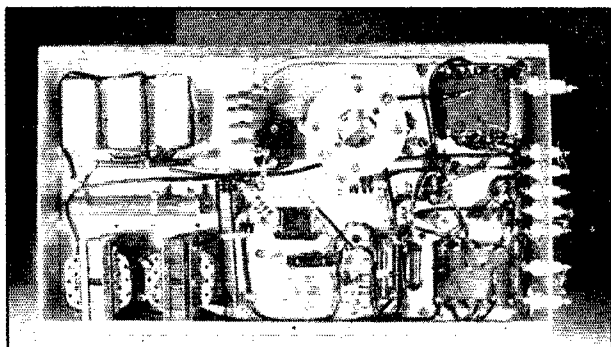

COIL TABLE

Frequency	L ₁	L ₂
1.7 Mc.	65 turns No. 18, close-wound on 1¾"-diam. form.	55 turns No. 12, close-wound on 3½"-diam. form.
3.5 Mc.	24 turns No. 18, close-wound on 1½"-diam. form.	33 turns No. 12, close-wound on 2½"-diam. form.
7 Mc.	17 turns No. 16, close-wound on 1½"-diam. form.	20 turns No. 12 space-wound to occupy 3½" length on 2½" diam. form.
14 Mc.	8 turns No. 14 spaced to 1½" length, 1½" diam.	8 turns No. 10 spaced to 3½" length, wound on 2½"-diam. form.
28 Mc.	4 turns spaced to 1" length, 1¼" diam.	4 turns No. 10 spaced to 2½" length, wound on 2½"-diam. form.

All coils wound with enameled wire.

part of the power supply that feeds the oscillator, and only a small amount of plate current is drawn when the key is up. The transmitter is keyed in the oscillator cathode circuit.

Construction

The transmitter is built on a metal chassis which mounts the oscillator and amplifier, the filament transformers and the amplifier-bias and oscillator-plate power supply. The HK254 socket is mounted below the chassis, thus lowering the tube and shortening the grid and plate leads. Reference to the photographs will show the relative position of the various components. The plate high voltage comes in at the back through a porcelain feed-through insulator and is brought to the r.f. choke through well-insulated wire. Ignition or any other high-tension cable can be used.

Although not shown in the photographs, it is extremely advisable to insulate the condenser shafts and add a front panel to the transmitter, to reduce the chances of the operator accidentally touching the tank condensers, since both of them are at their respective plate potentials above ground.

Tuning and Neutralizing

Neutralizing is a simple process that need be done only once for each coil combination. Plate voltage is applied to the oscillator and the circuit is tuned for maximum output, as indicated by the amplifier grid current. When the amplifier tank circuit is tuned to resonance the grid current will change, and the coupling between the oscillator and amplifier coils is adjusted until swinging the amplifier tank condenser through resonance causes no change in grid current. The point of neutralization is rather broad, and no

difficulty should be experienced in finding the proper adjustment. A neon bulb touched to the plate end of the amplifier tank can be used for the rough adjustment of neutralization, after which the final touching-up is done with the grid-current flicker as the indicator.

The screen voltage of the 6L6 is adjusted to approximately 250 volts by sliding the tap along the adjustable resistor R₂. The bias supply should furnish enough voltage to cut off the HK254 plate current when the key is up, and additional operating bias will be obtained under operation by the drop of the rectified grid current through resistor R₃.

If the oscillator does not key easily, and occasionally refuses to start, the cathode resistor should be varied until clean keying is obtained. A value of 400 ohms was found to be optimum in this particular case.

Performance

As an experiment, the amplifier was run at 1 kw. input on 14-Mc. c.w., with 4100 volts on the plate of the HK254, and the performance was satisfactory in every respect. However, the amplifier is normally run at the manufacturer's rating of 3000 volts at 170 ma., and this 500-watt working will give the maximum power output to tube life ratio. The final amplifier grid current runs about 40 ma., and the 6L6 plate current ranges between 70 and 95 ma.

A single-wire-fed antenna may be tapped on the amplifier tank coil (through a 0.001-μfd. high-voltage blocking condenser to remove the d.c. voltage from the antenna), or a link may be used to couple to an antenna circuit tuning unit.

New England Division Convention

Springfield, Mass., May 20th and 21st

THE Springfield Radio Association is again going to sponsor the 1939 convention which is to be held at the Hotel Charles, Springfield, Mass., May 20th and 21st. It is a pleasure for the association to assume this responsibility, and extends a most cordial invitation to the radio amateurs of New England to attend this affair to renew old friendships and make new ones. The committee will have a program to suit everyone's taste; contests a-plenty, meetings of all kinds, good entertainment, and the ladies will not be forgotten. If you want more information write to "Ike" Creaser, W1BSJ, Chairman, 115 Shattuck Street, Springfield, Mass. Registration fee: \$3.00 for the gents and \$2.00 for the ladies, for two days of fun.

Input Resistance of R. F. Receiving Tubes

Effect on Circuit Gain and Selectivity at High Frequencies

BY GEORGE GRAMMER,* WIDF

ALTHOUGH there have been occasional references in *QST* articles to the loading effect of vacuum tubes on tuned circuits at the higher frequencies, it has not been possible to be very specific because quantitative data on the tubes now most frequently used have been lacking. Some recently-released information,¹ however, throws new light on the subject, and permits us to take a further step and estimate the comparative performance of various r.f. tubes with respect to their effect on receiver selectivity and gain.

The input resistance of a tube is found to consist of two components, one present with the tube

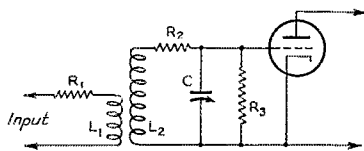

Fig. 1 — The various resistances which affect the Q of the tuned circuit. R_1 , the resistance of the driving source, antenna or plate circuit of the preceding tube; R_2 , the inherent resistance of the tank coil; R_3 , the input resistance of the amplifier tube.

either cold (i.e., taking no cathode current) or hot, the other present only when cathode current is flowing. The first can be called the "cold" resistance, the second the "hot" resistance. It is more convenient to discuss them as conductances rather than resistances, since the two components are in parallel, and furthermore are paralleled with the tuned-circuit impedance. The total input conductance, then, is the sum of the cold and hot conductances.²

Input Conductance Ingredients

The cold conductance is represented chiefly by the dielectric loss in the glass or other insulating supports for the tube elements and lead wires and, as might be expected, is practically the same for all comparable types of r.f. receiving tubes. This conductance is directly proportional to the frequency, and can conveniently be expressed in micromhos per megacycle.

* Technical Editor.

¹ Application Note No. 101, "Input Loading of Receiving Tubes at Radio Frequencies," RCA Manufacturing Company, Harrison, N. J.

² For the non-technical, conductance is the reciprocal of resistance, and is numerically equal to $1/R$. The unit is called the "mho." Conductances in parallel are simply added to find the total, and the sum can be converted back into resistance by dividing it into 1.

The hot input conductance depends upon the type of tube and the electrode voltages, and has a dual origin. One component is the result of electron transit time and the other of cathode lead inductance. The latter appears to be a degenerative effect which, it is well known, reduces both gain and selectivity and can therefore be considered to be equivalent to introduction of resistance. Electron transit time is not easy to explain in simple terms, but for the present purpose it is sufficient to say that electrons moving in the interelement space induce a varying charge on the grid, causing a current to flow in the grid. At low frequencies this current leads the alternating grid voltage by exactly 90 degrees, but at high frequencies the current leads by something less than 90 degrees because the frequency of grid voltage alternation becomes appreciable with respect to the speed at which the charge is propagated. This lag represents an energy loss and is equivalent to introducing resistance in the grid circuit. Both transit time and cathode lead inductance give rise to conductances which are proportional to the square of the frequency, and the two therefore can be grouped together as one.

Conductance Values

For all ordinary r.f. tubes except the 954, the cold conductance is 0.3 micromhos per megacycle; in the 954, dielectric losses are negligible in the frequency range considered (up to 100 megacycles) and the cold input conductance of this tube can be ignored. The hot conductance at normal electrode voltages for several of the popular r.f. pentodes is as follows:

6J7, 6K7, 6SJ7, 6SK7—0.05 micromhos per Mc ² .			
1851, 1852—0.13	"	"	"
1853—0.065	"	"	"
954—0.005	"	"	"

The grid-cathode resistance of a tube operating without grid current is so high that it need not be considered at frequencies up to and including the 3.5-Mc. band. As we go higher, however, the "input resistance" of the tube drops rapidly, and with ordinary tube types cannot be neglected at 14 Mc. and up. Here's some dope on what various types of tubes do to the gain and selectivity of tuned circuits at high frequencies.

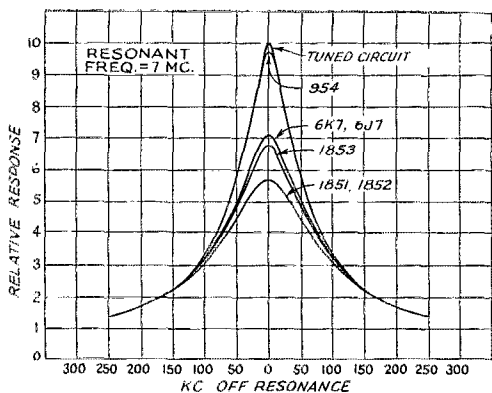

Fig. 2 — Effect of tube input resistance on gain and selectivity of a typical circuit operating at 7 Mc. Response at resonance is proportional to the heights of the peaks of the curves.

Thus it is evident that the hot input conductance of the 954 is only one-tenth that of the ordinary receiving pentode, or conversely that its hot input resistance is ten times as high, for the same frequency. The net ratio is somewhat better since, as mentioned above, the cold conductance of the 954 is negligible while it may be appreciable with the other tubes. Observe also that the 1851-52 types are nearly three times as bad as the 6J7-K7 types.

In converter tubes, the loading effect depends upon the arrangement of grids. The 6L7, which has its signal grid next to the cathode, behaves like an ordinary pentode and with normal operating conditions its hot conductance is 0.15 micromhos per Mc². It is therefore the poorest of the tubes discussed in this respect, and for this reason should not be used without regeneration as the first tube in a receiver. The behavior is different with converter tubes in which a screen is interposed between the signal grid and cathode. While the cold conductance is the same with these tubes as the others, the cathode-lead inductance component of the hot conductance is negligible, and the conductance resulting from transit-time effects turns out to be negative. The hot conductance values, in micromhos per Mc², for representative tubes are: 6A7, -0.05; 6K8, -0.08; 6SA7, -0.03. A negative conductance means that energy is being supplied to the circuit by the tube; in other words, regeneration. With these tubes, gain and selectivity are likely to increase as the frequency is raised; if the Q of the tuned circuit is high enough so that the parallel circuit impedance exceeds the value of the tube's negative input resistance the circuit will oscillate. This is not uncommon at frequencies of the order of 15 megacycles and higher, especially with the 6K8, and it is interesting to note that no amount of shielding or by-passing will stop the oscillation. The only method of getting stable operation is

by increasing the losses in the circuit, which can be done by introducing resistance in one form or another.

Circuit Loading

The explanations given above are admittedly sketchy, but serve to give some background for the practical application of the data. Good design principles dictate the use of an r.f. amplifier as the first tube in a high-frequency receiver — except possibly where economy is an important consideration — and since the tube ordinarily is used without regeneration the input resistance is an important factor in the performance of the receiver. Calculations based on the above data yield the following information about the input resistances of some of the tubes now in use:

Frequency	Input Resistance, Ohms			
	954	6K7, 6J7	1853	1851, 1852
7 Mc.	4,080,000	220,000	189,000	118,000
14 Mc.	1,020,000	71,400	59,000	33,700
28 Mc.	255,000	21,000	16,900	9,050
56 Mc.	63,700	5,850	4,530	2,300

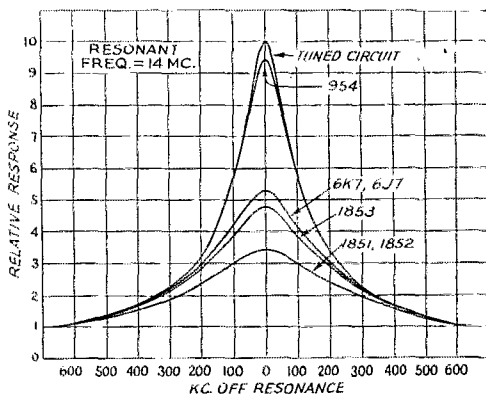

Fig. 3 — Effect of input loading at 14 Mc. on a representative tuned circuit.

From the input loading standpoint, the 954 is tremendously superior to any of the ordinary receiving tubes, although in actual practice the difference becomes marked only at 14 Mc. and higher. At 7 Mc., all of the tubes show an input resistance considerably higher than the parallel impedance of a reasonably good tuned circuit. At 14 Mc., a good tuned circuit, not coupled to an antenna, will have an impedance of the order of 60,000 ohms, using representative values of L and C. From the table above, it is evident that the input resistance of a 6K7 is of the same order, and that that of the 1851 is well below the circuit impedance. The picture becomes increasingly unfavorable at 28 Mc., while at 56 Mc. any tube except the acorn is a fairly good short for a tuned circuit.

The input circuit can be represented by Fig. 1, in which R₁ represents the resistance of the antenna or the plate resistance of the preceding

tube, R_2 the inherent resistance of the tuned circuit itself, and R_3 the input resistance of the tube. The Q of the circuit L_2C alone is determined by R_2 , which is chiefly resistance in the coil. At 7 and 14 Mc., it is not difficult to construct coils having a Q of 200;³ this figure also will be the tuned circuit Q . The effective Q of the circuit including the tube will be lower because of the presence of R_3 , the extent of the reduction depending upon the ratio of R_3 to the parallel impedance of the circuit alone. There will be a further reduction in Q when the circuit including L_1 is coupled to L_2C ; if optimum coupling is used, the Q will be reduced to just one-half its previous value. As a result, the effective Q of the total circuit may be quite low compared to that of L_2C alone.

The reduction in circuit gain and selectivity with various types of tubes at different amateur frequencies is shown graphically in Figs. 2, 3 and 4. These curves are based on the input resistances tabulated above. It is of course necessary to make some assumptions in drawing such curves; in this case, it was assumed that the coil Q was 200 on 7 and 14 Mc. and 150 on 28 Mc., the L/C ratios chosen were representative of ordinary practice, and the further assumption was made that optimum coupling existed between L_2C and the driving circuit. The shapes of the curves would be modified somewhat by using different coil Q values, different L/C ratios, or different values of coupling. In general, higher coil Q 's or higher L/C ratios would tend to increase the height of the curve for the circuit without tube loading as compared to the heights with the tubes connected, and *vice versa*. Tighter coupling would make the curves broader, while looser coupling would sharpen them to some extent. On the whole, the conditions chosen appear to be fairly representative, since the curves check quite well with measurements on standard receivers when one type of tube is substituted for another. Inci-

³ Pollack, "Factors Influencing the 'Q' of R.F. Coils in Amateur-Band Receivers," *QST*, February, 1939.

dentally, all three figures have been plotted to a relative scale, which should not be interpreted to mean that the absolute heights of the curves are the same on the three bands. Actually, the response decreases as the frequency is raised. The curves marked "tuned circuit" include the effect of coupling to the driver circuit, but assume no loading by the input circuit of the tube.

In a superhet receiver the selectivity in the r.f. stages usually is well below that of the i.f. amplifier, so that the shape of the r.f. response curve near the signal frequency is not of great consequence. The r.f. selectivity is the determining factor in image response, however. It is characteristic of all tuned circuits that at frequencies considerably removed from resonance, which is the image case on all bands below 28 Mc. when a conventional 455-kc. i.f. is used, the response is independent of the Q of the circuit. In other words, a good image ratio can be secured only by building up the desired signal, since the response to the image will be about the same in any case. The ratios of the peaks of any two curves in Figs. 2 and 3, therefore, indicate the relative increase or decrease in image ratio, although the curves do not give the numerical values of the ratios themselves. For instance, the image ratio for the single stage of Fig. 2 is reduced by the factor 5.7/7.1 when an 1851 is substituted for a 6K7, while the image ratio with the 6K7 is only 71 per cent of its value without any tube loading on the circuit. Image ratios are usually adequate on 7 Mc. with ordinary tubes, however, so that tube loading is not serious.

At 14 Mc. the image frequency represents a smaller deviation, in percentage, from the signal frequency, and the effect of loading becomes marked. In receivers using a single 6K7 r.f. stage ahead of the mixer, an overall signal-image ratio of about 50 is average, and it is no more than adequate. Substituting a 954 for the 6K7 would improve the image ratio by a factor of 1.8, approximately, bringing it up to 90, but substituting an 1851 would reduce it by 0.65, cutting the ratio down to about 30. Thus at this frequency the choice of an r.f. tube is highly important from the image standpoint.

The curves of Fig. 4 show that if image response at 28 Mc. is the foremost consideration, then a 455-kc. i.f. is distinctly out of place regardless of the type of tube used. The image frequency is much too close to the signal frequency for effective preselection even if the tube resistance were infinite. However, the practicalities of the situation often are such that a conventional i.f. has to be used, in which case some improvement can be effected by choosing the most suitable tube. The 954 is obviously better than the ordinary varieties. The 6K7 will give a ratio of between 2 and 3, while the 1851 shows hardly any discrimination between the signal and image.

(Continued on page 90)

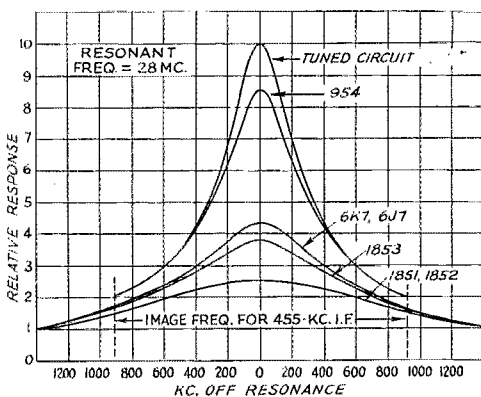

Fig. 4 — Effect of input loading at 28 Mc.

A Simple 5-, 10- and 20-Meter Converter for Home or Car

With BCL Receivers Commonplace in Cars a Converter Is the Answer for H.F. Reception in Mobile Work

BY WELLS CHAPIN,* W9DUD

THE urge to check my 20-meter signals on a receiver outside the shack suggested the use of my auto radio as the i.f. amplifier fed by a specially-built converter. And why not incorporate the 5- and 10-meter bands in the converter, to triple the usefulness of the gadget? The result was a 5-, 10- and 20-meter converter for 'phone or c.w. that was really "hot," capable of a.c. or d.c. operation, and adding the 5-meter band to superhets not normally intended for it. The final results were very gratifying, and I now have an excellent shortwave receiver in my car and the 5-meter band on my NC101X.

The converter uses a 37 oscillator tube and a 36 mixer simply because they have less elements to jar loose and use 6.3-volt heaters. An i.f. frequency of 1500 kc. gives satisfactory image-free reception and makes an r.f. stage unnecessary. Volume is controlled on the receiver used as the i.f. amplifier. There is nothing unusual about the circuit except possibly the oscillator circuit which is a split-coil Hartley and requires that both rotor and stator of the condenser be insulated from ground. The oscillator tuning condenser is isolated by mounting it on a piece of bakelite —

the mixer condenser has the rotor grounded and is mounted directly on the panel. The antenna coil is mounted permanently and the other coils are plug-in, self-supporting and mounted on pin tips which plug into pin-tip jacks. On 5 meters, the 10-meter oscillator coil is left in, and the second harmonic gives the beat. Special attention is given to short leads. A toggle switch between one side of the heaters and ground is closed for d.c. operation in the car (be sure polarity is correct) and left open when the converter is used with the a.c. supply of the home receiver.

The converter is built into a 6 × 6 × 6-inch steel cabinet. The apparatus is all mounted on the front end of the box and no sub-base is needed. The can is grounded, and all ground connections run to a common point on the cabinet. The most important point in construction is that

A converter is the logical answer to automobile short-wave reception. Here's a simple one that does the trick nicely, and also adds the 5-meter band to your regular receiver.

* 1432 Blackstone Street, St. Louis, Mo.

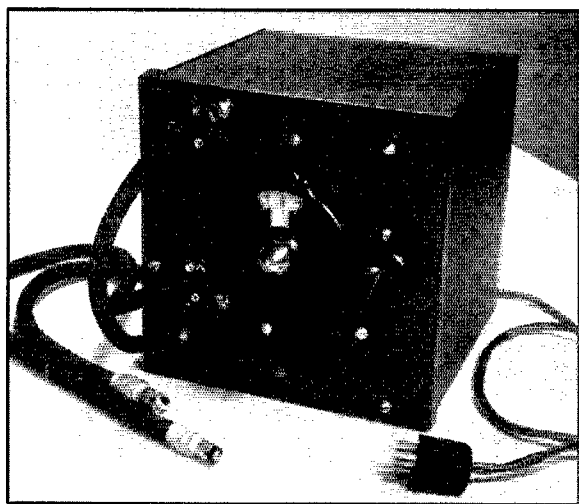

◆
The two-tube auto-radio converter is built in a 6-inch cube box and fits under the glove compartment of the car. Shielded leads connect to the auto radio and the car antenna, and a power cable plugs into the front of the car radio. The large dial is the oscillator tuning control; the small knob tunes the mixer stage.
◆

All components are fastened to the front panel of the cabinet. The plug-in inductances, wound with small diameter and heavy wire, are mounted on pin tips and are self-supporting. In spite of its simplicity, the converter turns in a good performance, even on the 56-Mc. band.

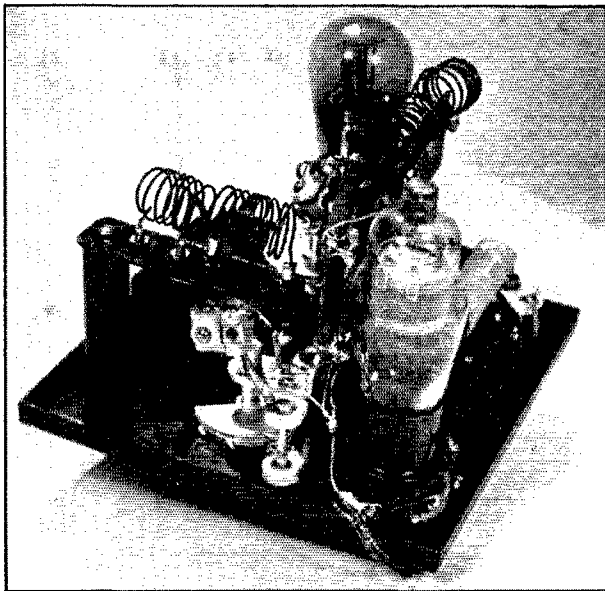
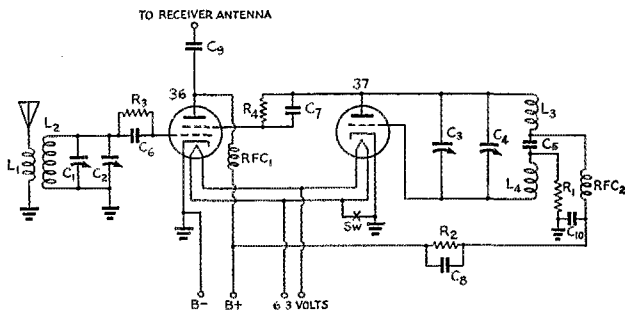

Fig. 1 — Circuit diagram of the converter.

- C₁ — 35- μ fd. variable.
- C₂, C₄ — 3-30- μ fd. isolantite padding condensers.
- C₃ — 20- μ fd. variable.
- C₅, C₆, — 0.0001- μ fd. mica.
- C₇, C₉ — 0.00005- μ fd. mica.
- C₈ — 1- μ fd. paper.
- C₁₀ — 0.002- μ fd. mica.
- R₁ — 25,000 ohms, 1-watt carbon.
- R₂ — 20,000 ohms, 1-watt carbon.
- R₃ — 500,000 ohms, 1-watt carbon.
- R₄ — 250,000 ohms, 1-watt carbon.
- RFC₁ — 85-mh. radio-frequency choke.
- RFC₂ — 2.5-mh. radio-frequency choke.
- SW — S.p.s.t. toggle switch.



everything be mounted rigidly, since the converter experiences considerable jolting on some trips. A four-prong plug connects to the auto radio to bring power to the converter, and a small Jones plug installed on the front of the car radio makes a convenient outlet. The power leads must be shielded, of course. Regular auto antenna connectors facilitate changing from the regular auto radio to converter-short-wave combination.

There is nothing particularly complicated in getting power from the car radio to drive the converter. If possible, get at the negative B lead as it comes from the filter. Reference to the wiring diagram of the car radio will help in establishing this point. The only difficulty I ran into in the power supply was some vibrator r.f. noise in the 10-meter band, and this was cured by inserting a 2.5-mh. choke in the positive B lead inside the auto radio. The power supply leads must be run out through shielded cable.

When using the car radio as the i.f. amplifier, c.w. reception can be obtained by tuning the car radio to the frequency of a local broadcast station

and connecting a foot of wire to the auto radio antenna terminal. The b.c. station then acts as the b.f.o.

The converter works well on five to six feet of vertical auto antenna. The type of auto antenna that follows the contour of the car doesn't seem to be much good for short waves, but a vertical or other type of antenna that gets away from the body of the car works nicely. Regular auto-radioshielded antenna lead-in wire was used for the connections.

Naturally, the converter has to be mounted so that it can be readily removed from the car. In my case I have two bolts in the top of the can that I push up inside of the glove compartment

COIL TABLE

	5 Meters	10 Meters	20 Meters
L ₁	7 t. No. 16 enam. $\frac{3}{8}$ " diameter	7 t. No. 16 enam. $\frac{3}{8}$ " diam.	7 t. No. 16 enam. $\frac{3}{8}$ " diameter
L ₂	4 $\frac{1}{2}$ t. No. 16 enam. $\frac{3}{8}$ " diam.	9 t. No. 16 enam. $\frac{3}{8}$ " diam.	18 t. No. 18 enam. $\frac{3}{8}$ " diam.
L ₃	Same as 10 meters	9 t. No. 16 enam. $\frac{3}{8}$ " diam.	18 t. No. 18 enam. $\frac{3}{8}$ " diam.
L ₄	Same as 10 meters	9 t. No. 16 enam. $\frac{3}{8}$ " diam.	18 t. No. 18 enam. $\frac{3}{8}$ " diam.

and fasten with two wing nuts. Then I take the antenna from the auto radio and hook it onto the antenna connector on the converter. The converter output is then hooked to the antenna connector on the auto radio and the power plug to the front of the set is put in place. This makes for a very simple installation that does not injure or affect the normal operation of the auto radio.

The converter works just as well on a.c., but only 150 volts should be used on the plate supply. A higher voltage will result in too much signal from the oscillator tube and unstable operation.

I have used this converter on a NC101X using an i.f. frequency of about 1700 kc., on a Motorola 75 and an RCA receiver. It will make any superhet a good short-wave receiver, and although I have never tried it in front of a t.r.f. I see no reason why it would not work just as well. This set could be adapted to other bands by using the right coil and condenser combination. This simple converter has proved so satisfactory in my case that I'm all for "bigger and better converters."

An Old-Timer Builds a Broadcast Receiver

LIVES there an old-timer to whom the name A. L. Groves does not bring back happy memories of the days when you could recognize a station instantly by its spark, and when transatlantic DX was something that only happened above 10,000 meters? We thought not! So let's get into a quiet corner for a moment, away from the young squirts with their continual hashing over of commonplace ends-of-the-earth QSO's, and find out where this chap who made Brooke, Virginia, famous has been all these years.

Fellows, he's still going strong, still building receivers, and still in the same old town! We were pleased no end to hear from him the other day, in a letter which included some photos and dope on his latest creation — the all push-button b.c. receiver shown herewith. Carrying to a logical end the push-button tuning idea, the "Groves Selectabutton Receiver" uses ten 8-button units to handle a total of 72 channels. There is no con-



Official A.R.R.L. joint convention of the Pacific and Southwestern Divisions, San Francisco, Sept. 2-4, 1939. Start Saving Your Money.

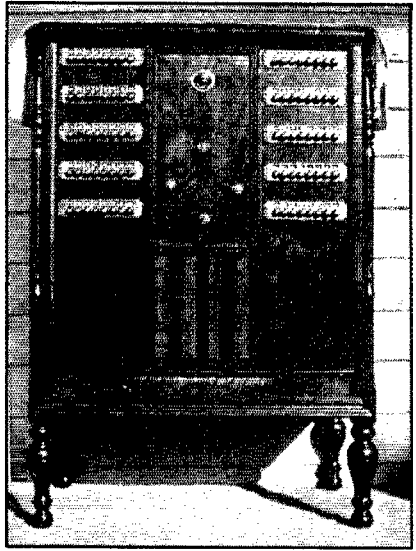

ventional ganged variable tuning condenser. By judicious use of low-drift compression-type trimmers and tubular air trimmers, drift has been reduced to negligible proportions without running into excessive cost. A contributing factor to the stability of the set is the location of the push-button units and trimmers, which are placed so that the heat from the power supply does not reach them. We wish that we could devote a bit more space to a description of the set, but the demands of our primary field preclude the possibility.

It seems particularly fitting that on the eve of the issue of *QST* marking the 25th anniversary of the League we should hear, for the first time in many years, from one of the gang whose early writings contributed much of interest and practical value to the game. Who coined that phrase, "It's in the blood"?

Strays

DIRECTOR NOBLE, WIBVR, SELECTED CHIEF RADIO AIDE

The Chief Signal Officer of the Army, Maj. Gen. Joseph O. Mauborgne, has announced that for the year 1939, Percy Noble, WIBVR, has been selected as Chief Radio Aide of the A.A.R.S. Percy Noble has been active in the 1st Corps Area A.R.R.S. since it was founded in 1925. WIBVR has held many posts in the 1st CA set-up and in the last few years has acted as the Control Station, and Percy has been the 1st CA Radio Aide. Always to be counted on for reliability and resourcefulness, it is fitting that this appointment has been conferred upon Noble, who, among other activities, spends his spare time directing the affairs of the New England Division, A.R.R.L.

"Safety" Becomes a Watchword

BY CLINTON B. DESOTO*

THE A.R.R.L. safety campaign has become a safety crusade! Hams all over the country are falling in line — learning safety habits, rebuilding their stations, practicing resuscitatory measures.

Scores of clubs are organizing first-aid classes and originating safety programs amongst their memberships. "Our club is organizing a class in first aid because we think it is as important as being able to build and operate apparatus." — *W2COQ, Raritan Valley Radio Club*. "We are going to set aside a certain period of each meeting to practice the proper methods." — *VE3APL, Intercity Amateur Radio Ass'n*. "The Hamfesters Radio Club has decided to start a campaign along this line." — *W9ZHR*. "We have been given actual demonstrations of the proper methods. . . . We have found these talks, together with the information set forth in your past few issues, not only interesting but extremely vital for a 'longer and more pleasant QSO!'" — *W9BFY, Fox River Radio League*. "Our Southtown Amateur Radio Association has worked out a plan for giving demonstrations . . . before the various radio clubs of Chicago." — *W9RT*. "This club has recently become more safety-conscious as the result of the program being carried out in *QST*." — *Central Jersey Radiophone Club*. "We got in touch with a local physician and made arrangements for him to give a lecture on the proper methods of artificial respiration." — *The 73 Club*. "In 1936 this club as a group took the first-aid instruction as given by the Red Cross. . . . In 1938 the club members then took the advanced course. . . . This club feels that no amateur radio organization can call itself fully equipped for any emergency operation unless each member has the knowledge and the ability to administer first aid." — *W4AWO, Lake Worth Radio Club*. "Our speakers have been requested to stress *safety* in their discussions . . . a plan was finally adopted which called for a contest of the question and answer type . . . for all licensed hams in the county. . . . Newspaper and radio broadcast publicity by the local papers and radio stations is also organized and arranged for. . . . It is hoped that . . . other radio clubs may join in promoting a campaign of similar nature in their respective communities." — *W9OUB, Milwaukee Radio Amateurs' Club*.

This is but a small sample of the activity that is going on. Is it worthwhile? Well, in the words of *W2COQ*, "If every ham were made to know the correct method of artificial respiration, and

if some day it saved a life, it would be a job well done." That has already happened; the safety campaign *has* saved a life — see the Correspondence section of this issue of *QST*.

Practical demonstrations and training courses are not hard to arrange. Valuable coöperation can be obtained from the local chapter of the American Red Cross, which supplies complete courses under an accredited Red Cross first-aid instructor free of charge (except for the cost of the textbooks). The regular course requires 20 hours of work, and there is an advanced course comprising 10 additional hours. Upon completion of either course an identification card is issued good for three years.

If such a project seems too elaborate, at least the club can arrange for an evening of practical demonstration and instruction. The Red Cross will not aid except by providing the formal course, but such demonstrations are usually gladly given by local utilities, physicians, etc.

The importance of personal instruction and supervised practice in artificial respiration cannot be overemphasized. A neophyte might read an article on tuning a transmitter and be able to tune one perfectly the first time, but the chances are against it. It's far better to be sure you know what you're doing. Here:

"When I was still a Boy Scout my scoutmaster chose me to be the 'victim' in a resuscitation, demonstration by an 'authority' on the subject who was around to show the boys the right way. To be helpful I completely relaxed so the operator could 'breathe' for me as though I was 'out.' In



The York Road Radio Club of Philadelphia practices artificial respiration under Director Martin's appreciative eye.

* Assistant Secretary, A.R.R.L.

approximately five minutes I could not hold out any longer and I had already turned blue in the face, as someone remarked about it. The procedure was rudely interrupted by my gasping for more air than I had been provided. . . . Please, gentlemen, for a test, try suddenly stopping breathing, crumple to the floor, relax, have a friend across the room 'realize' the situation and come to your 'rescue.' Remember to let him do all your breathing. From the time of the 'shock,' note the time required to completely satisfy your air requirements, and then the time it takes to get you to a point of 'dizzy headache' through over-breathing. . . ."

Since we first started investigating this subject we have found apparently wide differences of opinion as to the precise technique to be employed in artificial respiration. It seems to us that much of this emphasis on details is misplaced. After all, there is no one single way to hold a key to ensure a good fist, nor is there even one universally-approved method of holding a golf club. The answer is that results are the important thing — and the way to make sure that results are being achieved is by actually trying it yourself.

The February article on "Resuscitation from Electrical Shock" aroused a large volume of comment, some of it critical in tone. In accordance with the policy of presenting all sides of questions, significant criticisms are here excerpted:

" . . . The story the pictures on pages 16 and 17 tell is *outrageous*. . . . Foot-rapping is relegated to police departments for the purpose of arousing slumbering transients. . . . The pulmotor is a heartless mechanical device that has squeezed the remaining breath of life out of many a victim due to improper use (and where has it ever been used properly?). . . ." — *W9HPJ*.

" . . . The given directions are not of the Schafer method of resuscitation unless they have been badly misprinted. To begin, time should not be wasted, but if first aid is to be applied indoors it is no waste of time to open the windows. The patient should be placed in position *between* the first few pressures, not before. The head should not rest on the arm as shown in the photos in *QST*; it should rest on the hand with the fingertips directly under the mouth (3). Kneel, straddling not the patient's thighs but the knee on the side toward which the face is turned, the rescuer's knee being even with that of the victim (4). The best way to locate the floating ribs on which pressure must be applied is to place the hands just below the shoulder blades, four inches apart, with the palms turned forward and the thumbs outward, and scrape the edges of the hands back toward the pelvis until they stop (5). Keep the arms straight! This is stressed in the article but not in the photographs. Don't slide when the body is moved downward and forward, and don't

bend the arms. It is permissible to have the shoulders over the heel of the hand at the end of the forward swing, and perhaps a good idea, but don't continue to swing forward. During the period of pressure, the body should fall back to such an extent that pressure is exerted forward as well as downward. Compressing the lungs toward the chest will not expel the 'bad air' unless the diaphragm is also compressed toward the throat. If the latter is stressed by the rescuer, the former will take care of itself (6). *Snap* the hands off in an outward direction, allowing the lungs to fill with air, by which I mean release the pressure immediately and in a hurry at the end of the pressure period. Otherwise the action of the diaphragm will not be so effective. Returning to an upright position after each application of pressure is not vitally important, but serves to relax the muscles of the back. One who must continue for four hours at the rate of twelve to fifteen respirations per minute will make a total of 2880 to 3600 respirations, and that same number of short relaxations will be found very valuable. Above all, do not allow the patient to walk or otherwise exert himself. Heart collapse or pneumonia often follows a case of suffocation and, after such an experience, a person requires medical attention. . . ." — *W6PGH*.

Another correspondent says: "(1) . . . Full weight is *never* required. Sixty pounds is a figure well set as a maximum. One very large electrical manufacturing firm sets the pressure at the low figure of 15 pounds. The danger of injury by excessive pressure is great. Why save a child from death by asphyxia if you are going to cause internal injuries severe enough to result in death later? . . . (2) In paragraph 8 you say that the sound of air being expelled will be clearly audible. I'm afraid that if anyone learned the method from this article and failed to hear the sound of air being expelled they would feel they were doing it improperly, and either waste time or give up entirely. You *do not* hear the air being expelled or, for that matter, being drawn in. Possibly in the case of a drowning there may be a gurgle occasionally from water in the air passages, but usually there is no sound. That misconception creeps in because of the fact that during practice quite often the 'patient' fights the pressure, with the result that sound is produced."

The treatment of burns also precipitated some pertinent discussion. First of all, several correspondents pointed out the two unfortunate typographical errors near the end of the next-to-last paragraph. There should have been no comma between "cotton" and "gauze." Cotton gauze was meant, of course — not absorbent cotton. Then the word "tightly" should be "lightly"; do not exert pressure on the burn.

J. P. Mestrezat of Five Finger Light Station, Juneau, Alaska, writes: ". . . I suggest that

(Continued on page 90)

Copying Bee Results

PARTICIPATION in the Fifth A.R.R.L. Copying Bee (December, 1938) surpassed the four preceding "Bees," with 289 operators submitting entries. The Copying Bee is one receiving competition where code ability receives a *real* work-out. Consisting as it does of tricky combinations of letters and numerals, plain language, misspelled words, etc., the text offers no opportunity for guesswork. You either get it or you don't! And at 25 w.p.m. it isn't child's play!

The Winners

Mario de la Torre, CM2OP
Lawrence L. Weintraub, W2ECL
R. A. Schlegel, W2ICX
J. H. Nicholson, W3EEN
Martin L. Croft, W8APQ
William Sabo, W8BCV

Each of these operators made 100% copy in the 1938 Copying Bee, and will receive a bronze medallion award as a token of his achievement. Congratulations! CM2OP and W2ICX made perfect copy of two different Bee transmissions, CM2OP from W2AYN and W9UZ, W2ICX from W2KEZ and W9UZ; W2ECL made his copy from W2AYN, W3EEN from W1AW, W8APQ from W1AW, and W8BCV from W2AYN.

Eleven transmissions from seven stations using "automatic" equipment were made during the evening of December 9th. All transmissions were at approximately 25 words per minute and consisted of 60 words or groups (punctuation marks each counting as one word). Each word or group copied correctly counted $1\frac{2}{3}$ points towards a possible score of 100. One-half credit was allowed for copying correctly "one side" of the parenthesis, which was included in the text. Transmissions were at 8:15, 9:15, 10:15 and 11:15 p.m., CST, different texts, carefully prepared to be equally difficult, being used at each hour. Stations conducting the "Bee" were W1AW, W2AYN, W2KEZ, W6AM, W6CIS, W9BAZ and W9UZ. Sincere thanks are extended to the operators of these stations for their cooperation in assuring the success of the activity.

To give an idea of the nature of the transmissions, the text transmitted at 11:15 p.m., CST, by W1AW, W6AM and W6CIS follows:

HE WHO LAUGHS LAST LAUGH BEST HEARD AND TIME WAITS FOR NO MAN PROTOZOAN ROTATING SYNCHRONOUS ELECTRONIC STREAM 76. HAM OPERATING OFFERS J1WM THRILLS QRF AND CQ IS THE GENERAL CALR 34362 OVERCOME SPARK TRANSMITTERS P8CN H2LD AR3PK LOOK BEFORE YOU, LEAP ANNUR A PERCEPTIBLE HUM REGULATOR! THESE (GILA) RICHMOND VIRGINIA HOW ARE YOUR NERVES UNLAX

You can see now why we said, "COPY WHAT YOU HEAR" and "DO NOT RECOPY!"

Corrected copies are being returned to all contestants except the winners, together with

copies of the texts transmitted by the various stations so that each operator may see where he slipped up.

Final Ratings

50.9% of all contestants made their best copy from W1AW (Two transmissions, four frequencies), 12.4% made best copy from W9BAZ (One transmission, one frequency), 8.6% from W6AM (Three transmissions, three frequencies), 8% from W6CIS (Two transmissions, two frequencies), 8% from W9UZ (One transmission, one frequency), 5.2% from W2AYN (One transmission, one frequency), 2.4% from W2KEZ (One transmission, one frequency), and 4.5% did not indicate from which station copy was made.

Participating operators are here listed according to accuracy of copy, ratings of 80% or higher being indicated:

100%: CM2OP W2ECL W2ICX W3EEN W8APQ W8BCV. 98%: W2AJL W2ALB W2JKY W5BMI W5DWW W6BMC W6KFC W7FCQ W9FA W9FQ W9RLB W9ZQG. 97%: W1LLX W2GGE W2GGW W2HHG W3CMV W3GBK W3HQW W4BYI W4CED W4COV W4DVO W4EMF W4JN W6CUZ W8BEN W8BKM W8DOD W8FYF W8MCL W8NAU W8QUQ W8QZK W9JWI W9NFL W9V8J. 95%: W1AMQ W1GBD W2GFF W2KJY W3GHW W4APU W4BUD W4EQE W4EZX W8FUW W9DYV W9VKF J. Sokolsky. 93%: VE2CD VE5AHQ W1AMH W1JVA W1KXP W2AYN W2HQQ W2HSZ W2KMZ W3EPH W4EX W5ENI W6DVD W8BMA W8JQE W8QLE W9GY W9QDX W9RMM W9ZMG. 92%: K4EXL W1DOV W1JSD W2AWU W2DIJ W2LR W3ADE W3BWT W3FPQ W6ODQ W8JTT. 91%: W3E8WJ W9AHR. 90%: K4E8WJ W2ETT W2KKU W3AKB W5BID W6JQX W8ITK W8PSM W9NGS. 89%: W6LUJ. 88%: VE3IA W1IP W2FJH W2KMS W3FPQ W3GRF W3GYY W6PBV W8QAN W8SS W9AZT W9BQP W9MFF. 87%: VE4BU W1KIE W1LPI W2JIN W3DGM W3GKN W6IOX W6OAF W8RHE W9QUY J. Russell Thorburn. 86%: W9VDA. 85%: W1KGH W1KJF W2DYF W2LDF W5G8B W6IMI W8ARO W8EU W8RFF W8SCK W9NST W9YPO. 84%: W4BRT. 83%: W1BDV W1GAE W1KCB W2CJI W2GTA W3GXI W9BWN W9DOP W9TSQ W9VVZ W9ZRM E. W. Nyberg. 82%: VE2CR W1ASG W1CTI W5FYQ W5GLD W5GWO W6BQO W6KXS W8FTW W8LEY W8PCW W8QGD W9DOU W9TBI. 81%: W4EPT W6MXN. 80%: W1DJG W1FOI W1IDU W1KKS W2JHB W3AYS W8CR W8NHO W8QQB W8R8B John Wiegatz. Below 80%, in order: W2KKR-W4EPV K6FAZ-W1BKG-W3FWB-W8BNO-W6OQH-W7WY-W8QXW-W9ICQ-W9SSX-W9UEG-W9VNN W1MY W2APT-W2ELK-W2HUG-W2PF-W3FQS-W3HFV W3ZI-W8LYZ-W8NIX-W9FWW-W9ZRP W9FKM W1JXP-W5GKJ-W7EBQ-W8AFE-W9ZQL W2LQO-W3GYQ-W9GGQ-W9ONK VE3AJX-W1BJY-W3BET-W3DQU-W3H8V-W6PMU W3FEG VE3DH-W1JQQ-W1KAA-W1KPB-W1LGE-W2AOJ W2KOH-W5KC-W6FJK-W8CDT-W9THS W2GXX-W9NOD W1LHQ-W2COG-W6AFH-W8RKM-W9OUD-W9UUE-W9JVV-W9ZFC W3EEW W1KFN VE4ABR-W6GBN-W6PMV W4FGB VE1KL-W1BPN-W2HBO-W3RR-W4AHP-W8AQE-W9VFM VE4KI-W1LDV-W6PUH W3DXX-W9VFZ K6LKN W5FRK-W6PFK W9KKG VE4AFG-W1DLN-W2HUM W6DVB H. J. Clinton W6IED-W8RSD W6PGH W1KVB-W9N8K W2JK-W3GCU W6DKF-W8DM W5HLH W6NEC-W7LD W7GDB-W9DCT VE5AFG-W9YTV Robert Spencer W8MYT WILDG W2JZI W8OMZ R. R. Pooley VE5OF.

— E. L. B. and J. A. M.

Wave-Shape Plots for Checking Amplifier Distortion

A Simple Method of Determining Whether Distortion Exceeds Acceptable Limits

HARMONIC distortion is something which cannot wholly be avoided in an audio amplifier, but it must be kept within tolerable limits if the quality of reproduction is to be good. It is of considerable interest, therefore, to know the order of distortion present in an amplifier, but its measurement requires rather expensive equipment. On the other hand, for amateur work it is less important to know the exact amount and type of distortion generated than it is to know whether it lies above or below limits which represent "good," "fair," or "poor" performance.

If one has an oscilloscope with a linear sweep the order of distortion can be found quite readily with the help of the accompanying plots. These drawings, which were prepared by John L. Stiles, W8PLN, give typical cases of the types of harmonic distortion ordinarily encountered in audio equipment. The second-harmonic cases are characteristic of single-ended stages using triode tubes, while the third-harmonic drawings are rep-

resentative of push-pull amplifiers or Class-B modulators. The sixth case, marked "7% second plus 5% third" is typical of a single-ended pentode amplifier working at rated output.

To utilize the drawings it is necessary to have a rather pure single-frequency signal for reference. This signal can be compared with the sine-wave curve to make sure that it meets the specifications. If no audio-frequency generator is available, the power-line wave-shape usually will be pretty close to a pure sine wave, and in case there is an appreciable discrepancy the harmonics can be filtered out by connecting a fairly good-sized condenser across the source. With the power line as the signal source, a step-down transformer should be used both for insulation and to reduce the voltage to a suitable value. The wave-shape of the source should be checked directly against the oscilloscope, of course, and should not be fed through the speech amplifier until after the purity of the wave has been established.

It is generally more convenient to use a higher frequency than 50 or 60 cycles, since a good many speech amplifiers will not respond well to such low frequencies — nor is it necessary that they should, since speech seldom contains any components below 100 cycles. The simple sine-wave oscillator shown in the Handbook¹ will serve nicely for this purpose. It costs very little to make and is a handy gadget for testing purposes.

The two sets of figures shown are suitable for use with 3-inch and 2-inch tubes respectively. They are about as large as is practicable without running too close to the circumference of the cathode-ray tube screen. To use them, lay a sheet of transparent paper or celluloid over the drawing and carefully trace the plots, using as fine a line as possible. The tracing can then be held or fastened to the screen of the tube with the plot appropriately centered. With the signal applied to the oscilloscope, the horizontal and vertical controls should be manipulated until the screen pattern coincides as closely as possible with the tracing. It is not necessary to pay any particular attention to the dotted base-line, since this may or may not correspond to the horizontal sweep line on the screen when there is no vertical input.

The figures show a characteristic difference in form between waves containing even and odd harmonics. When even harmonics are present the

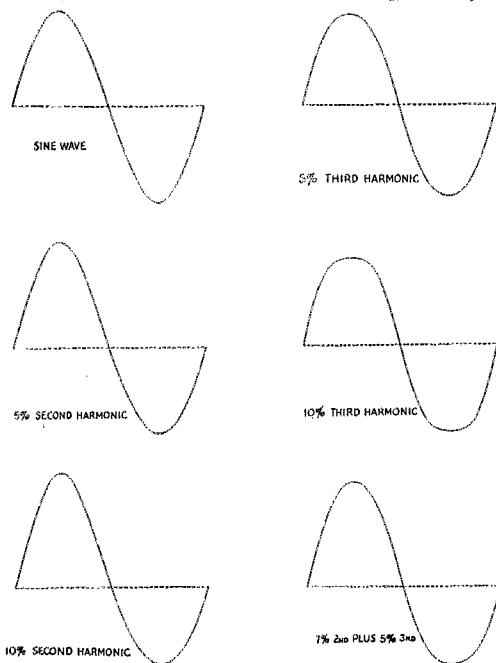

Wave-shape plots for use with a 2-inch oscilloscope tube.

¹ "Instruments and Measurements" chapter.

lower half-cycle is not the same shape as the upper; in this case one half-cycle is more peaked while the second is broadened. With odd-harmonic distortion, however, the two half-cycles are identical, both being flattened at the peaks. The general rule that the wave is symmetrical in shape with odd-harmonic distortion and asymmetrical with even-harmonic distortion is true in all cases, although the actual shapes shown here are applicable only in the special case of distortion generated by the ordinary tube amplifier. A shift in the phase of the harmonic with respect to the fundamental will change the wave-shape considerably, even though the relative amplitudes are the same. When both even and odd harmonics are present, the resultant wave-shape is naturally a combination of the two effects,

and the type of distortion is not easily recognizable.

By trying various of the plots against the pattern on the screen it should be possible to determine quite readily whether the distortion is excessive. If the output wave is not quite a sine wave but fails between the sine and 5 per cent second-harmonic curves, then the distortion is certainly less than 5 per cent, which is good. Distortion between 5 per cent and 10 per cent is tolerable enough, but if it exceeds 10 per cent it would be advisable to look into the speech amplifier. In general, attempt to make the lines coincide as far as possible starting from the center, letting the peaks indicate the order of distortion.

— G. G.

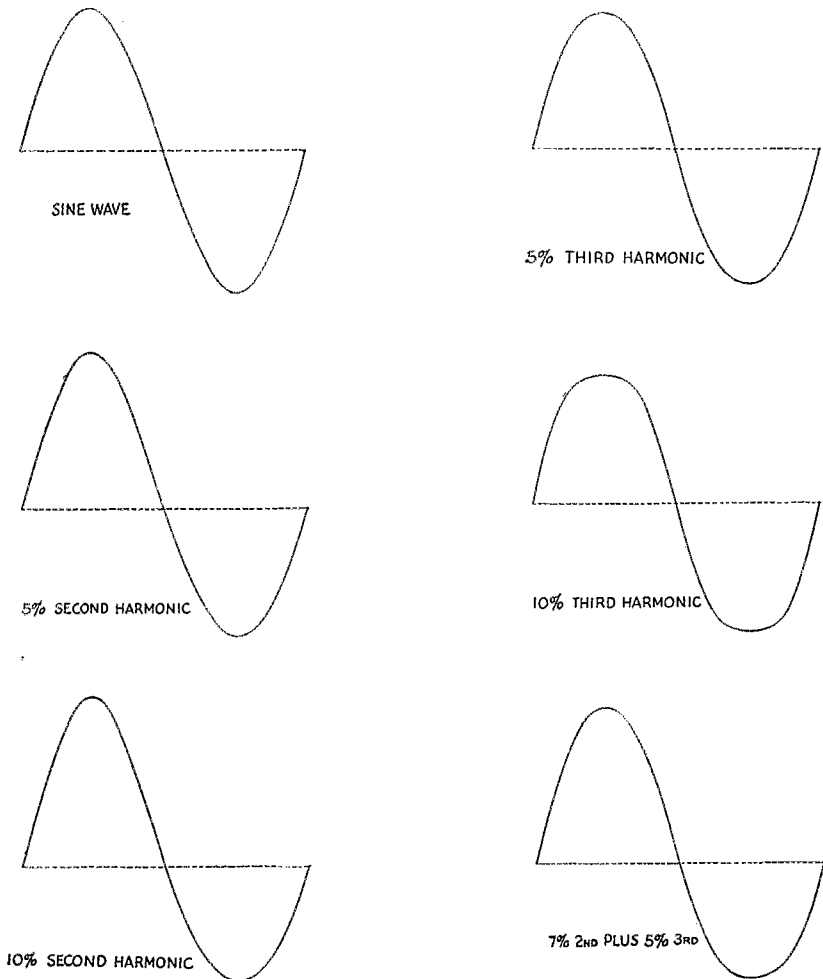

Wave-shape plots for use with a 3-inch oscilloscope tube.



NAVAL COMMUNICATION RESERVE NOTES

THIRTEENTH NAVAL DISTRICT, NAVAL COMMUNICATION RESERVE

THE Naval Communication Reserve, as organized in the 13th Naval District, is composed of seven Sections and nineteen Units covering the five states of Washington, Oregon, Idaho, Montana and Wyoming and also the Territory of Alaska. Section One embraces Western Washington, Section Two the state of Oregon, Section Three the state of Idaho, Section Four the state of Montana, Section Five the state of Wyoming, Section Six, Alaska, and Section Seven, Eastern Washington. Units are located in the principal cities in these states. The administration of the organization is conducted from offices at 453 Federal Office Building in Seattle, Washington, under the command of Lieutenant George V. Wiltse, C-V(S), USNR.

The personnel in this District is composed of men interested in amateur radio and communication in its various phases as well as those whose civilian occupation involves electrical engineering and communication work.

Drills are held every Wednesday night, with alternate nights being devoted to Armory and Radio instruction. The Armory drill period is devoted to instruction in Naval Customs and Regulations, military drill, and communication procedure. The radio drill on the following Wednesday consists of putting things learned in classroom instruction into actual practice on the District Radio circuit. The radio circuit utilizes the regular naval frequencies of 2576 kc. for District-Section operation, 2772 kc. for Section-Unit operation and 2884 kc. for Unit-Individual operation. All operation is strictly in accordance

with regular navy requirements including maintenance of frequency within prescribed tolerance. Trophies are awarded each year to the highest scoring Section, Unit and Individual within the District. Scoring is based on the accuracy with which Naval Procedure and operating is adhered to as well as drill attendance.

From the standpoint of officers in charge of Units and Sections the matter of effectively using all of the short time allotted to drills is important because each man attending must feel that he has learned something from every drill or his interest will certainly wane. Incidentally, once a smooth working routine is developed which adequately takes care of the training of new men, and assigns due responsibilities to the men in higher ratings, and keeps both groups busy, the Commander sees his work reduced by a surprising amount. A further surprise is in store for him when he sees the enthusiastic reaction which such a program produces in his men; attendance and activity will increase and more and more inquiries will be noted from interested prospects for membership. Much progress toward a satisfactory solution of this problem has been made by Unit One, Section One, Thirteenth Naval District, Seattle, Washington, under direction of Ensign Robert B. Wright, C-V(S), USNR, which meets in the quarters room, 203 Canadian National Dock.

Unit quarters are about 16 feet by 60 feet in overall dimensions and are peculiarly shaped to conform to the angle which the dock makes with the harbor line. Unfortunately for radio operations, a marine radio station which frequently uses i.c.w. is located about 300 feet away. Otherwise the quarters are quite satisfactory. The floor

plan is self-explanatory, except that it might be explained that the 2 feet by 4 feet railing is provided for the purpose of isolating the actual radio operations from confusion which develops on occasions when visitors or new applicants are present.

Operations are conducted and all traffic handled as though the Units were battle-ships. Due to the proximity of Section Headquarters, Unit One is considered the flagship with the Section Com-

(Continued on page 98)

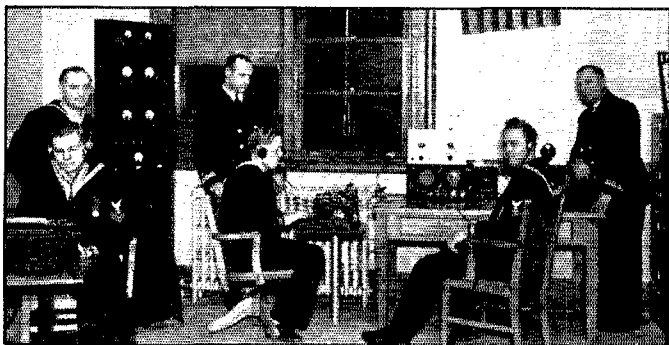

Emergency Drill at Section IV Hq., Butte, Mont.

How to Lay Out a Metal Chassis

Time-Saving Tips on Locating Mounting Holes

BY DON H. MIX,* WITS

DURING the past few years, amateurs in general have turned pretty solidly to the standard rack-and-panel type of construction in transmitters, particularly those for frequencies below 56 Mc. Although there are those who decry the lack of individuality in appearance, nevertheless others are justified in the feeling that individuality is desirable only when it can be attained without sacrifice in practical utility.

The most attractive feature of rack-type construction is its versatility which permits expansion or contraction of the size of the transmitter or alterations in individual units without the necessity for complete rebuilding each time to preserve a presentable appearance. Standardization has made it possible for manufacturers to bring out, at reasonable prices through quantity production, parts and fittings difficult for most amateurs to fashion for themselves. Rack-and-panel construction will not increase the cost of construction more than a few per cent above that of the simplest form of breadboard construction, even though the result does "look expensive." The largest standard chassis may be purchased for about \$1.50 and even a breadboard job should have a panel for the sake of safety.

QST gave early recognition to these advantages and, for the last few years, the trend has been generally followed in constructional articles with favorable acceptance. In connection with this type of construction, we are frequently asked why we do not publish scale drawings with dimensions of panels and chassis of units described in articles. The question is a logical one and, we think, we have a logical answer. Although *QST* prides itself in the quality of its photographic reproductions which clearly show the general arrangement of parts, it is true that drawings would be a valuable time-saver for the constructor

providing, however, that he used parts identical to those in the original model. The answer to the question is simply that we do not wish to dictate the choice of parts when there is no reason why the constructor may not make his own choice or use something on hand which will be equally suitable although not of the same physical dimensions. In a case where the accurate placement of parts is essential to proper operation, this is mentioned in the article, otherwise accuracy in placement greater than that which may be attained by careful study of the photographs is unnecessary.

A great deal of time may be saved and many mistakes avoided if a definite method of procedure is worked out and followed in laying out the chassis and panel and in performing the necessary operations. While the individual undoubtedly can work out a system to suit himself after he has done a certain amount of construction, a description of one of the successful methods followed in *QST*'s workshop undoubtedly will help those who haven't had preliminary experience.

Assuming that we have a chassis and panel of appropriate dimensions, we should first decide where the chassis is to be fastened to the panel. Normally the lower edges of the chassis and panel will come flush and may be lined up on a flat surface. Sometimes, however, it is necessary to drop the lower edge of the panel below the lower edge of the chassis because of apparatus projecting below the chassis. If this is the case, the position of the chassis should be determined and a line drawn across the panel, parallel with its lower edge, indicating the top surface of the chassis. The panel should now be clamped to the chassis and the mounting holes drilled through both. The panel should then be removed.

The next step is to cover the top of the chassis with a piece of heavy wrapping paper, allowing the edges of the paper to overlap all edges of the chassis so that the edges of the paper may be bent down and fastened to the edges of the chassis with adhesive tape. In doing this, the paper should be drawn fairly tight. The parts which are to be on top of the chassis are now collected and placed in position as nearly as may be determined from a study of the photographs. It is advisable, whenever possible, to mount all parts on the chassis itself, so that construction will not be complicated by parts mounted on both panel and chassis. If small variable condensers or volume controls are to be mounted underneath on

* Assistant Technical Editor.

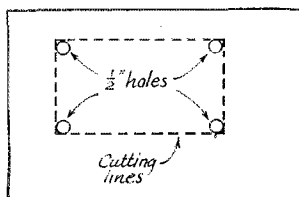

Fig. 1—Square or rectangular holes may be cut in the chassis with a hacksaw after drilling one-half-inch holes inside each corner for starting and turning.

This article explains why *QST* doesn't publish scale drawings and tells how anyone with a few tools can make a painless job of chassis construction. It describes methods used in *QST*'s own workshop.

the front edge of the chassis, this should be borne in mind when laying out the parts on top to avoid any possible conflict between them. Condensers and other units which have shafts which will be extended to controls on the panel should be placed in position first, especially if the panel layout is arranged so that the controls fall symmetrically about a vertical line through the center of the panel. In this case, measurements should be made from each side of the chassis so that the shaft lines on either side of center will be spaced equally from each edge. In this connection, watch out for certain types of condensers whose shafts do not line up with the mounting holes; the placing of the shafts is the important thing, of course. Measurements should be made with an adjustable scale with a sliding rule calibrated in 32nds of an inch.

Quite frequently, the mounting holes may be marked on the paper using the condenser or other part as a pattern. In other cases the holes are inaccessible so that it will be necessary to make measurements in spotting the mounting points. In addition to the mounting holes, lines indicating accurately the position of the shafts should be drawn with the square, extending them to the front edge of the chassis. Any baffle shields or partitions should now be made up and located and the paper marked with lines to indicate their positions. Panel brackets should be fitted to the chassis, pressing the panel against the front edge of the chassis to make the brackets come flush.

Other parts may now be placed on the chassis and moved about until a satisfactory arrangement has been found. Don't forget that the centers of tube sockets as well as the mounting holes must be marked. Be sure to have the tube in the socket and the shield, if used, in place when locating sockets. To insure a good fit with flush- or sub-mounting sockets, it is sometimes helpful to cut the central clearing hole first, then place the socket in the hole and mark the mounting-screw holes. When using sub-mounting wafer sockets, it should be borne in mind that the holes have to be only large enough to provide reasonable clearance around the tube pins, unless the chassis is of unusually thick material or unless the socket is spaced below the chassis; in either case the hole must be large enough to pass the tube base.

If transformers with flexible leads out the bottom will require a hole $\frac{3}{8}$ inch or so in diameter in the approximate center of the space the

transformer is to occupy. Some transformers are fitted with lugs instead of flexible leads. The clearance holes for these may be spotted by measurement or by pressing the transformer firmly down on a piece of paper so that impressions are left which may be transferred to the paper covering the chassis. Occasionally transmitter plug-in coils will be mounted on a row of jack-top stand-off insulators. To insure proper spacing and alignment, the coils should be inserted while spotting the mounting holes for the stand-offs.

Holes for leads which must pass through the chassis should not be forgotten. The placement of these may be determined from a study of the circuit diagram; high accuracy isn't necessary, of course. Rough outline of the various parts at points where they contact the chassis should be marked on the paper before the parts are removed.

If there are parts which must be mounted underneath the chassis (excluding those parts which will not require mounting holes), they should now be assembled and placed on top of the chassis. They may be moved about until an arrangement is found which will avoid interference with the parts mounted on top and the points may be marked.

The chassis is now ready for marking of the hole centers. This should be done with a rather heavy hammer and a center punch with a hardened point. It will help materially to block up the interior of the chassis with short lengths of board to support the center of the chassis. The centers are punched right through the paper, of course. Before the paper is removed, the panel should be fastened on and the lines indicating the shaft extensions transferred to the back of the panel.

In drilling the chassis, it is usually advisable to start large holes with a drill fairly small in size yet with sufficient strength to permit decent pressure. This applies particularly to the use of a hand drill since larger drills may show a tendency to "walk" away from the center-punch mark. Keep the drill at right angles to the surface of the chassis. The small holes may be enlarged, when

(Continued on page 94)

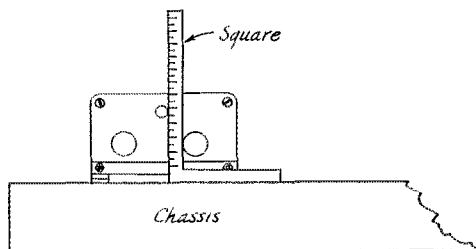

Fig. 2 — How the square is used to measure heights of condenser shafts above the surface of the chassis. If a combination square is used, the end of the scale should be set flush with the face of the head.

HOW WOULD YOU DO IT?



PROTECTION AGAINST DAMAGE BY LIGHTNING

REFERRING back to page 61 of *QST* for February, we find that Problem No. 25 deals with practical systems providing protection to the ham station and adjacent property against damage by lightning. We haven't much of an idea as to how many amateur installations are struck by lightning in the course of a year, but if the number is small, it is probably due to good luck more than anything else since protection is one of the last things the average ham considers. It is a rather absurd situation since a few simple precautions will render the installation impervious to almost anything except a direct stroke on the antenna and will also reduce the probability of even this.

The usual radio antenna will not survive a direct stroke. The current in some cases may be as high as 200,000 amperes which usually results in melting of the antenna wire and the creation of some other path to ground. Fortunately, however, direct strokes are comparatively rare except in unusually exposed locations. Indirect strokes are more frequent and are capable of doing serious damage unless precautions are taken. If an antenna is connected to a good ground, the danger of a stroke in the immediate vicinity of the antenna is considerably reduced. The charge between a cloud and the antenna is drawn off as rapidly as it is developed and only when the charge develops more rapidly than it can be discharged through the resistance of the antenna and ground system will there be great danger of a direct stroke.

Several methods of antenna grounding were suggested by the contestants. The use of a grounding switch is obvious, but is not automatic and the operator often forgets or neglects to close the switch upon closing the station down. A direct ground connection will also take care of snow-static discharges which are often bothersome in northern latitudes. An arrangement which permits permanent grounding of the antenna system is shown in Fig. 3. The feeders are connected directly to ground through r.f. chokes. Balanced antenna systems fed at the center should not require the r.f. chokes unless series tuning is necessary; the center point of the antenna tank coil or coupling coil may be grounded directly. In the case of an unbalanced

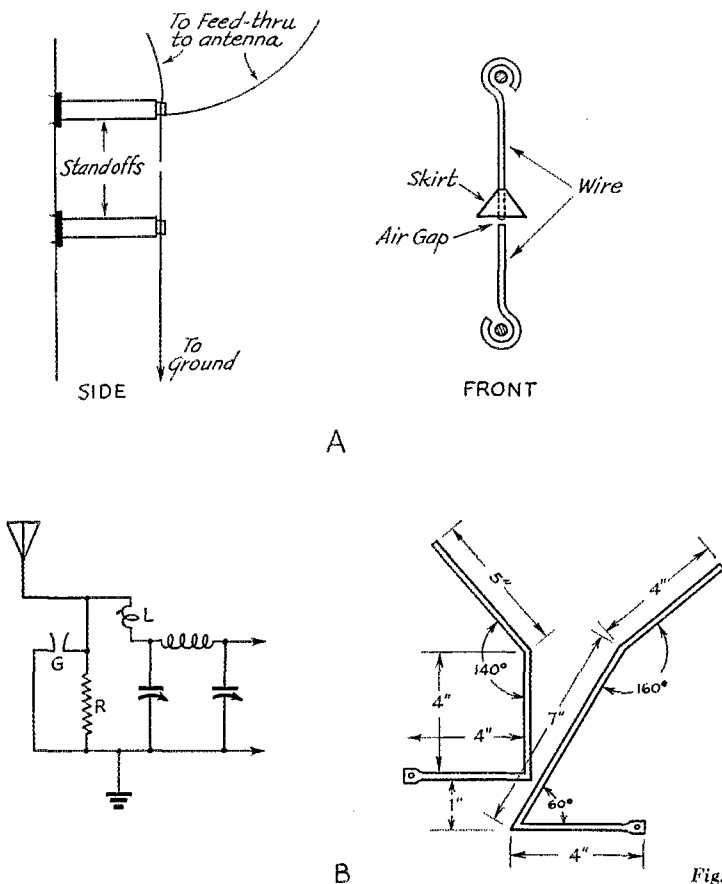

Fig. 1

system such as the Zepp system, however, it is probable that the r.f. choke at the center of the coil will be required in most cases, since a voltage node seldom occurs at the center of the feeder system unless the antenna is carefully cut for and used at one frequency.

To take care of rapidly rising charges which might not be dissipated sufficiently fast through the chokes, ground gaps are provided for each feeder wire. These gaps should be made as small as possible without breaking down under normal operation of the transmitter. In connecting to the gaps, the feeders should be bent at a rather sharp angle. Such a bend, or a turn or two of heavy conductor between the gap and the antenna tuning equipment, will provide an impedance for a steep wave-front surge, thus encouraging a discharge through the gap rather than through the transmitter. Once the gap breaks down, its resistance becomes very low.

Several gap designs are shown in Figs. 1 and 2.

The one at Fig. 2A is suggested by W1ALJ. The gap is made from three pieces of copper tubing, bent as shown and mounted on stand-off insulators. The side of the building upon which the gap is mounted is protected against possible danger of fire, when the gap operates, by an asbestos-board mounting. (Insulation of the ground wire is not required by fire underwriters. — Ed.)

An enclosed gap is suggested by Robert Murray of Long Island City. It is shown in Fig. 2B and consists of a pair of gaps mounted in a steel outlet box. The box is mounted on a section of galvanized iron pipe driven well into the ground or bonded to a good ground. The contacts between the pipe and box and between the lower electrodes of the gap and the box should be as firm and of as low resistance as possible. The upper gap electrodes are mounted on feed-through insulators to provide good transmission-line insulation. The electrodes may be made from one-quarter-inch diameter rod.

A very simple type of electrode and mounting is shown in Fig. 1A. This is suggested by W8OSL. Rubber cones, cut from an old inner tube and

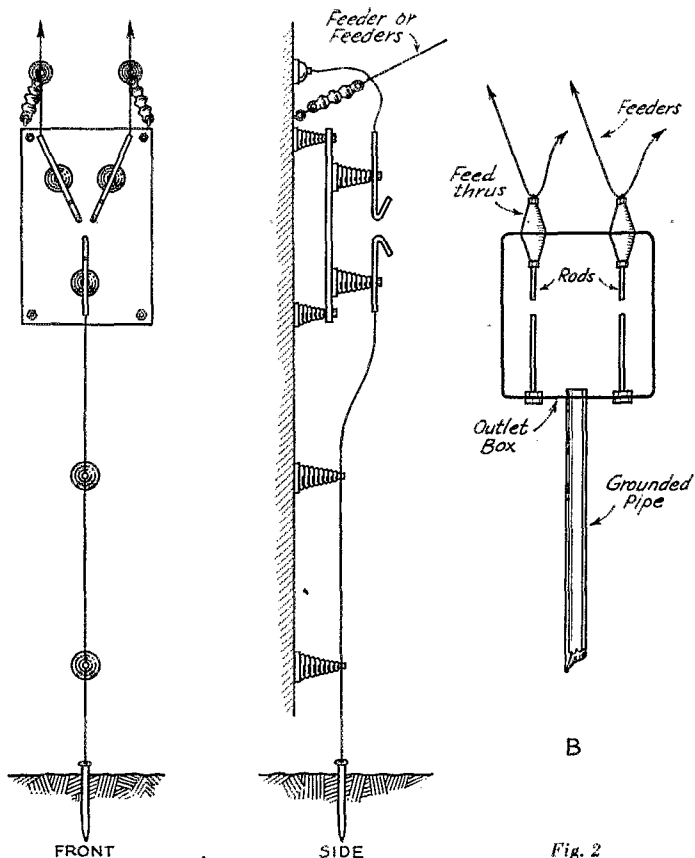

Fig. 2

slipped over the upper electrodes, protect the gap against short-circuit by snow or rain. In this case, the electrodes are made of pieces of heavy wire.

W4AAQ recommends the arrangement shown in Fig. 1B for Marconi-type antennas frequently used in 160-meter work.

"L is a two-turn coil of copper tubing or heavy wire, self-supporting, four inches in diameter. This coil has sufficient inductance to offer a high impedance to the steep wave-front of lightning surges and causes them to take the path of least resistance through the gap to ground. The resistance R is of the order of 200,000 ohms, 100 watts and is effective in draining small static charges to ground before they have an opportunity to build up a potential sufficient to break down the gap." (Unless a noninductive resistance is obtainable, an r.f. choke should be connected above the resistor. — Ed.)

Although a pi-section filter is shown in the diagram, the system may be used with other forms of coupling.

The construction of the gap is shown in the detail drawing. It may be made from one-quarter-inch copper tubing or No. 2 or No. 4 wire.

PROBLEM NO. 28

Our Hero needs a new receiver and is deliberating the question of whether he should build or purchase one. He feels that he could build one which would suit him better in several respects than any he could buy but the problem of band changing has him stopped temporarily. If he is going to be forced to use plug-in coils, he feels that he would prefer the manufactured job. He doesn't care particularly for coil switching by means of tap switches because of the difficulty involved in getting proper circuit isolation with short leads. Coils supported by the switch often have a tendency to vibrate resulting in poor frequency stability.

Our Hero would like some practical ideas on the construction of a coil-shifting arrangement. The system should be as mechanically simple as possible so that it would be a reasonable job for the average man like himself to duplicate without the expert skill of a master mechanic. The system should be capable of application to a superhet with a stage of preselection and should provide for adequate circuit isolation and low losses. The receiver must cover four or five bands with provision for band spread.

Grounds and Ground Wires

In considering protective measures against lightning, it might be well to review the subject of grounds and ground wires. Any protective system is only as good as its ground connection. The National Board of Fire Underwriters recommends the use of a connection to a water-pipe system wherever such is available at not too great a distance from the antenna lead-in point. Other permissible grounds are grounded steel frames of buildings or other grounded metal work in the building.

Where water pipe or other suitable ground connection is not available, an artificial ground may be made with driven pipes, buried plates, etc. If the soil is dry, several rods or pipes spaced

three or four feet should be used. These should be driven as deep as practicable into the ground and connected together below the surface of the ground. A coil of wire, or metal plate submerged in a well, makes a good ground connection. If the well is some distance from the lead-in point, connection should be made to a driven-pipe ground immediately under the lead-in point before continuing to the well ground. In very dry locations, it would be advisable to create an area of permanent moisture around the ground rods or pipes by frequent application of salt water.

The ground wire need not be insulated from the building, but it should be protected against possible mechanical injury. It is permissible to run the wire to ground inside the building if this will shorten the path to ground. The lightning arrester may also be mounted inside if suitably protected to prevent fire when the gap operates. In most installations, it will probably be most convenient to locate the gap on the outside of the building and run its grounding wire down on the outside to a suitable opening to a water-pipe connection while running the ground to the antenna coupling system on the inside of the building. The ground wire to the gap should be at least as large as the transmission-line wires combined and in no case less than No. 14 wire.

Prizes

First Prize: Robert Murray, Long Island City, N. Y.

Second Prize: Julius Wenglare, WSOSL, South Heights, Pa.

We wish also to thank the following for their contributions: W2ESO, 2JRU, 2LPC, 5EQP, 6EWC, 7BIA, 8AMS, SOMM, SSMH, 9LKV, 9QVA, 9QWI, 9SCH, 9UUU, VE2BM, Gordon Crayford, Arthur Kraker and Dan Reed.

Problem-Contest Rules

Rules under which the contest is conducted are as follows:
1. Solutions must be mailed to reach West Hartford before the 5th of the publication month following that of the issue in which the problem has appeared. (For instance, solutions of problem given in the May issue must arrive at *QST* before June 5th.) They must be addressed to the Problem Contest Editor, *QST*, West Hartford, Conn.

2. Manuscripts must not be longer than 1000 words, written in ink or typewritten, with double spacing, on one side of the sheet. Diagrams must be neat and legible.

3. All solutions submitted become the property of *QST*, available for publication in the magazine.

4. The editors of *QST* will serve as judges. Their decision will be final.

Prizes of \$5 worth of A.R.R.L. station supplies or publications will be given to the author of the solution considered best each month, \$2.50 worth of supplies to the author of the solution adjudged second best. The winners are requested to specify the supplies or publications preferred.

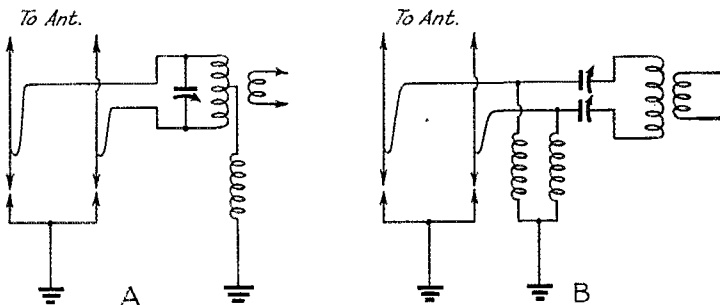

Fig. 3

Volume Compression Simplified

A Speech Amplifier-Compressor with Novel Features

BY W. C. LAMB, JR.,* W60GC

THE present interest in methods of raising the average percentage of modulation, as well as limiting the peak output of audio equipment, has led the author to present a speech amplifier based upon the practical considerations that prevail in amateur 'phone work.

As a result of previous work with low-level audio equipment which was used in strong a.c. and r.f. fields, a design which eliminated transformers and chokes, especially in the low-level stages, was evolved. The entire unit, consisting of power supply, speech amplifier, and compressor, was built on a single $8 \times 12 \times 2\frac{1}{2}$ chassis. A little thought devoted to placement of parts, keeping the audio and power transformers at opposite ends of the chassis, and making the input stage leads as short as possible, was more than compensated for by the excellent results obtained.

The first two stages are both pentode-connected. The new 6SK7 and 6SJ7 tubes have ideal characteristics for this purpose, first by providing the necessary gain to drive, from a crystal mike, a

6C5 as an impedance transformer, and second, in the fact that all connections are brought out to the base pins, making for short leads and neat construction.

The 6C5, operating as a cathode follower,¹ provides low-impedance (500-ohm) output. This allows the speech unit to be placed on the operating table where its gain and compression controls are convenient, and keeps the low-level audio equipment out of the strong a.c. and r.f. fields of the transmitter. A line of any desirable length couples the speech amplifier-compressor to the driver stage of the modulator unit.

The heart of this little speech amplifier is the compressor. Its simplicity is only exceeded by the excellent results obtained. A 6H6 is used as a

¹ The term "cathode follower" is applied to a tube with the load in its cathode circuit when the load resistance appears in the following stage. Note that the d.c. cathode circuit must be completed through the line. Ordinarily the cathode follower is used as a step-down impedance transformer, forming a convenient method of working from a very high to a very low impedance, where actual transformers would not be satisfactory. — EBRON.

* 3351 Perlita Ave., Los Angeles, Cal.

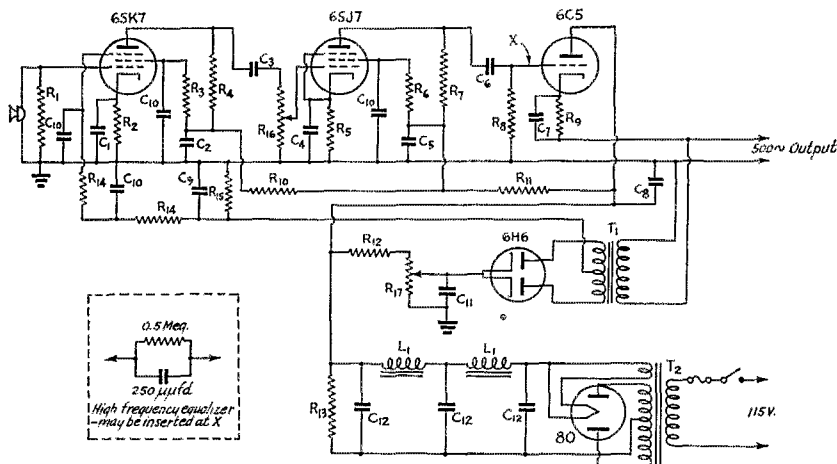

Fig. 1 — Circuit of the speech amplifier-compressor.

- C₁, C₄, C₇ — 25- μ fd., 25-volt electrolytic.
- C₂, C₅ — 4- μ fd., 450-volt electrolytic.
- C₃, C₆ — 0.05- μ fd. paper.
- C₈ — 0.5- μ fd. paper.
- C₉, C₁₀, C₁₁ — 0.1- μ fd. paper.
- C₁₂ — 8- μ fd., 450-volt electrolytic.
- R₁, R₈ — 0.5 megohm.
- R₂, R₅ — 1250 ohms.

- R₃, R₆ — 2 megohms.
- R₄, R₇ — 0.25 megohm.
- R₉ — 1000 ohms.
- R₁₀, R₁₁ — 25,000 ohms.
- R₁₂ — 0.1 megohm.
- R₁₃ — 25,000 ohms, 10-watt.
- R₁₄, R₁₅ — 0.25 megohm.
- R₁₆ — 0.5-megohm potentiometer (gain control).

- R₁₇ — 25,000-ohm potentiometer (compression control).
- T₁ — Interstage audio transformer, single plate to push-pull grids.
- T₂ — Power transformer, 600 volts c.t., 5-v. and 6.3-v. filament windings.
- L₁ — Filter chokes, 15 henrys, 85 ma.

This glimpse inside the amplifier-compressor built by the author shows the simplicity of the arrangement. The unit is for use on the operating table, has 500-ohm output for working into a remote pair of 2A3 drivers. There is ample gain for a crystal microphone.

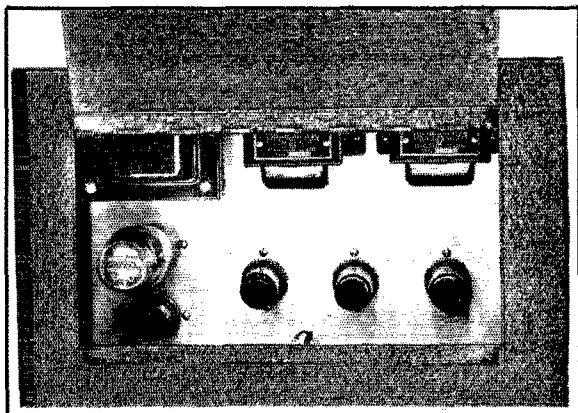

full-wave audio rectifier, its plates being fed by the secondary of an ordinary plate-to-push-pull-grid audio transformer; the plate winding or primary being connected across the output of the speech unit. A positive bias on the cathode of the 6H6, controlled from the front panel by potentiometer R_{17} , determines the point at which compression starts. A simple resistance-capacity filter removes the audio component, and a varying d.c. voltage is impressed on the suppressor grid of the input tube of the amplifier. The manual compressor control on the front panel controls the positive delay voltage on the 6H6. With a variation from zero voltage to 30 volts positive on the 6H6 cathode, any desired range of compression may be obtained. With the control bias of the 6H6 at 30 volts positive there is little or no compression, and upon reducing this bias to zero compression starts immediately at any signal input to the amplifier; thus by using intermediate bias values compression may be made to start at any desired input level.

The simple RC filter network in the d.c. line to the 6SK7 suppressor is sufficient to prevent audio feed-back and still does not introduce appreciable lag, insofar as limiting peaks that would cause overmodulation and splatter is concerned.

Using the constants as shown in Fig. 1, a few words as to the practicability of the unit are in

This is just about as simple a scheme for adding volume compression to a speech amplifier as any we've heard about. If you already have a speech amplifier and don't want to build a new one, the compressor circuit alone can be adapted readily to it, the only proviso being that the input stage should use a pentode. Why not give your average modulation a boost and at the same time reduce the possibility of overmodulation?

order. The unit is now installed as a speech amplifier-compressor to drive a pair of 2A3 triodes which, in turn, drive a pair of RK52 zero-bias tubes to maximum rated output, 250 watts average audio power. All reports received to date have been very complimentary as to quality and high average level of signal.

The resistor and condenser in the dashed enclosure in Fig. 1 constitute a simple equalizer for raising the gain at the higher audio frequencies, which is, of course, desirable for amateur 'phone work. The equalizer may be inserted in series with the grid of the 6C5, as indicated by

(Continued on page 98)



DIXIE JONES' OWL JUICE

THIS here Squinch Owl is figgerin' on startin' a movement to take up a collection of ten cents per each from all the school younguns in the Country to git together some munny to start a lobby to see can we git a law passed to make these guys that think up the size of building lots to not be so dern stingy and make 'em big enuf so's a ham can git up a 80 meter antenny on 'em, and while I'm at it I might as well make 'em plant a tree at both ends to hang same on. It's a doggone sin and a shame that perfectly good hams that vote right, go to chirch reglar, take a bath ever Saturday, eat with thair fork, pay thair dets, tote back stuff they borry, and always willin' to mind the baby on thair wife's night out, and they hafto go threw life as 40-meter jaspers and are denied the boon of asso-shiatin' with us gentlemens on 80.

— W4IR of the Dixie "Squinch Owl"

★ I. A. R. U. NEWS ★

Devoted to the interests and activities of the

INTERNATIONAL AMATEUR RADIO UNION

Headquarters Society: THE AMERICAN RADIO RELAY LEAGUE, West Hartford, Conn.

MEMBER SOCIETIES

American Radio Relay League
Asociatia Amatorilor Romani de Unde
Scurte
Associazione Radiotecnica Italiana
Canadian Section A. R. R. L.
Československá Amatérská Vysílací
Deutscher Amateur Sende-und-Empfangs
Dienst
Festil Raadio Amatoride Ühing
Experimental Radio Society of Egypt
Experimenterende Danske Radioamatorer
Federation des Emetteurs Belges
Irish Radio Transmitters Society

日本アマチュア無線聯盟 Japan
Liga Colombiana de Radio Amadores
Liga Mexicana de Radio Experimentadores
Magyar Rövidhullámú Amatőrök Országos
Egyesülete
Nederlandsche Vereeniging voor Interna-
tionaal Radioamateurisme
Nederlandsch-Indische Vereeniging Voor
Internationaal Radioamateurisme
Newfoundland Amateur Radio Association
New Zealand Association of Radio Trans-
mitters
Norsk Radio Relæ Liga

Polski Zwiasek Krotkofalowcow
Radio Club de Cuba
Radio Club Venezolano
Radio Society of Great Britain
Rede dos Emissores Portugueses
Reseau des Emetteurs Français
Reseau Luxembourgeois des Ama-
teurs d'Ondes Courtes
South African Radio Relay League
Suomen Radioamatööriyhdistys r.y.
Sveriges Sändareamatorer
Unión de Radioemisores Españoles
Union Schweiz Kurzwellen Amateure
Wireless Institute of Australia

MEXICO

We are indebted to Mr. Milton Leventhal of Los Angeles for the following sketch of amateur radio club groups in Mexico.

THE focal point of radio interest in Mexico is found in the capital of that country, Mexico City. A flourishing metropolis of over a million inhabitants, in Mexico City can be found the largest congregation of the radio faithful, and it is here that the national radio organization, the Liga Mexicana de Radio Experimentadores, maintains its principal offices and academy of instruction. This organization has done much to raise the standards of radio transmission in Mexico; and although it has been in existence only 7 years, in its ranks can be found fully 85 per cent of the radio experimenters of that country as well as the majority of radio engineers engaged in commercial transmission.

Mexican hamdom is drawn from all walks of



C.R.E.S. booth at the recent Hermosillo commercial exposition.

life, for within its scope one will find lawyers, doctors, engineers, diplomats, miners, ranchers, laborers, businessmen—in fact, it might be called one of the most cosmopolitan groups of individuals engaged in a common enterprise. Roughly speaking, there are approximately 1,500 radio experimenters in Mexico, of whom about 300 are active amateurs. Although almost every amateur belongs to the LMRE, still in the various centers of population south of the Rio Grande there are individual amateur clubs where the word of the radio gospel is carried on in that immediate vicinity.

The first of these regional organizations, the Club de Radio Experimentadores de Veracruz, is one of the oldest local clubs of that country, and at the present time has on its roster 34 active members, all of whom live in or near the city proper. In addition to the regular meetings held periodically in the club's offices, daily classes are given by XE1AG and XE1DG for those who wish to improve their knowledge of theory and practice in radio communication. Besides maintaining contact on the 5-meter band between Veracruz and the islands in the Gulf of Mexico close to that city, the members of the CREV form the central link of the Ruta del Golfo, the name given to the chain of Mexican amateurs along the Atlantic seaboard whose self-imposed task it is to retransmit the meteorological bulletins emanating from the government stations along the coast. This service is as unique as it is helpful to the mariners of that vicinity, and definitely has proven to the Mexican people as a whole that the amateur can be of service in normal times as well as in emergencies. Such has been the activity of the CREV that Veracruz has been designated as the site for the 1939 national amateur convention, during which the amateurs of that vicinity will

Board of Directors of the LMRE

Seated — left to right: XE1BN, XE1DC, XE1K, XE1N, XE1HR, Lic. de la Barrera.

Standing — left to right: Ing. Huber, XE2AI, XE1A-XE2N, XE1FD, Col. Garza Bazan, XE1R, XE1BM, XE1AG.



act as hosts to the crowds of radio experimenters who make their annual pilgrimage from all parts of Mexico to the city chosen for the occasion.

On the Pacific slope located in the picturesque city of Guadalajara is found the Club de Radio Experimentadores del Occidente, more readily known throughout Mexico as the CREO. This local club has a membership of about 25 enthusiasts, and is the most active in the central western portion of the country. With the exception of Monterrey in the second district, Guadalajara is the only point outside of Mexico City in which are situated radio parts distributing houses devoted to supplying the needs of the amateur, and with the aid of this atmosphere of commercial activity the CREO has assumed a rôle of importance in the development of radio interest in that section of the country.

In Morelia, capital of the state of Michoacan, is located the Club Michoacano de Radio Experimentadores, an enthusiastic group of 20 amateurs, who devote all their spare time to the study and experimentation of radio transmission. This club maintains a complete transmitting station which is used to aid in the relaying of meteorological bulletins emanating from the government observatories; and also to provide an opportunity for the amateur of modest means, who cannot himself afford an entire station, to get on the air with a completely-equipped transmitter of moderate power. In addition to the transmitter, the CMRE has set aside one of its clubrooms as a workshop in which the members may solve their technical problems, and also maintains a radio library for the general use of the clubmen.

In the city of Guanajuato, capital of the state of the same name, is located the smallest of the regional clubs of the first district. The Club de Radio Experimentadores Guanajuatenses has on its rolls only 15 active members, among them the only YL of that city (Senorita Lucy Jimenez, XE1GW), but the enthusiasm of this small group is characteristic of amateurs in any part of Mexico. The work of this club is that of instructing the embryo amateur in the rudiments of transmission, and likewise of maintaining in their environs consistent interest in radiocommunication.

One of the most ideal of the regional radio organizations in Mexico is the Club de Radio Experimentadores Potosinos, located in San Luis Potosi, capital of the state of the same name. Composed of a compact group of amateurs, the CREP is an enterprising organization which devotes its entire time to the study and practice of radio transmission, with emphasis on the instruction of future hams in the art of manipulating the key and microphone. The CREP maintains a modern radio library composed of technical manuals in English and Spanish, as well as a low-powered transmitter for the benefit of its members; and in the home of its president, Jose E. Leon, XE2GI, an experimental workshop has been established for the use of amateurs in that city.

One of the most active and progressive local clubs south of our border is located in the city of Monterrey, which is quite frequently referred to as the Pittsburgh of Mexico. In this thriving industrial community radio is always at high pitch, as is evidenced by the fact that two radio supply houses are located in that city, and radio amateur transmission in Monterrey takes its place on a par with that in any other part of the world. The Club de Radio Experimentadores de Monterrey is an organization of long standing, and has to its credit more than 30 active members. In addition to maintaining a library and experimental aids for its members, the CREM takes an active interest in the civic life of the city; and in the recent industrial exposition and fair held in Monterrey, took special pains to demonstrate to the local citizenry the advances which have taken place in modern radio.

The most popular amateur organization located in the Pacific Northwest is the Club de Radio Experimentadores de Sonora, with headquarters in Hermosillo, the capital of the state of Sonora. Although this club has been in existence only two years, its roster includes 31 active members; but unlike the other regional clubs in Mexico, the members of the CRES are not located in one city but are distributed throughout the state of Sonora and also in Sinaloa and the territory

(Continued on page 106)



HINTS AND KINKS FOR THE EXPERIMENTER

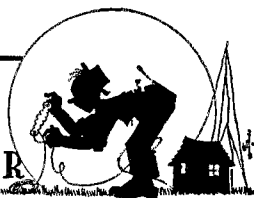

SURE-FIRE INTERLOCK

IN CONNECTION with precautions which may be taken to reduce danger of injury while working around the transmitter, the use of an enclosed cabinet with door interlocks is often suggested. The interlock system usually consists

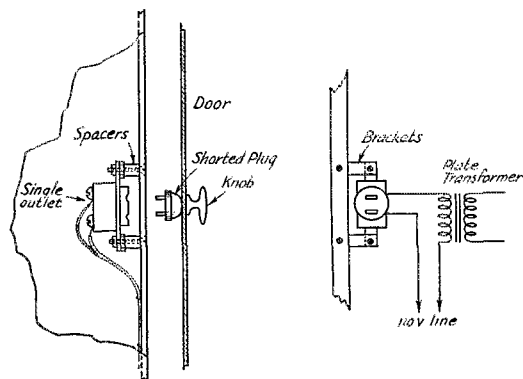

Fig. 1

of a spring switch mounted against the door in such a way that it springs open whenever the door is opened. The switch contacts are usually connected in series with the primary winding of the high-voltage plate transformer or in a relay circuit controlling the transformer primary circuit. While these switches are nearly fool-proof there is always the possibility that either switch or relay will stick without opening the circuit.

I have been using for some time a very simple and inexpensive interlock arrangement which seems to be entirely fool-proof. The idea is shown in Fig. 1. An ordinary 110-volt outlet, mounted on a metal-strip bracket, is fastened inside the cabinet. A 110-volt plug is fastened to the door by means of a machine screw which may also be used to fasten the doorknob in place.

The outlet is connected in series with one side of the 110-volt line and the high-voltage transformer primary and the two prongs of the plug on the door are connected together. Care should be taken that the nut holding the plug in place does not ground the plug contacts to the door or knob.

It is difficult to conceive of any means by which this system could fail because the circuit is broken manually when the door is opened and

no dependence is placed upon springs. The plug and outlet also serve as a door catch.

— Milton Mir, W1PL

IMPROVED OSCILLATOR SCREEN-GRID KEYING

THE diagram of Fig. 2 shows an improvement on the screen-grid oscillator keying circuit which I described in October *QST* as a solution to Problem 20 in the 'How Would You Do It?' contest.

Some hams who tried the original circuit may have had difficulty in completely stopping oscillation when the key was opened, since the screen grid of the oscillator tube was necessarily at a slightly positive voltage and since a lightly loaded oscillator may oscillate even with zero voltage on the screen. Another difficulty with the original circuit was that, as the emission of the keying tube filament became reduced through use, the screen voltage would not be reduced sufficiently to prevent oscillation when the key was opened, or else the oscillation was maintained for a short time after the key was opened, causing tails on the signals.

By using a heater type of tube or a separate filament supply for the keying tube, it is possible to place a negative voltage on the screen of the oscillator tube when the key is open so that oscillations are completely stopped. The negative bias on the oscillator-tube screen can be regulated in accordance with requirements by moving

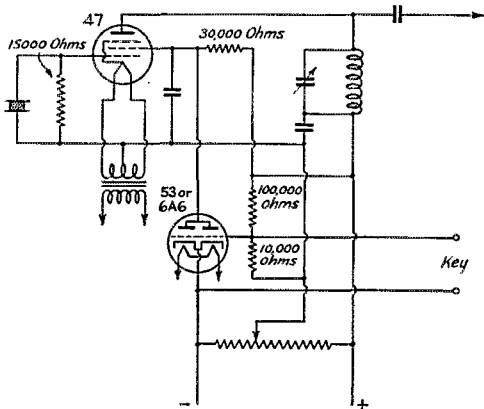

Fig. 2

the taps on the voltage divider. A negative voltage of about 25 volts at the cathode of the 53 will provide about the right voltage at the screen of the 47 when 300 volts are used on the plate. Too little negative bias will result in tails on the signals, while too much bias will prevent the oscillator from starting readily. The key may be connected to a more negative point on the voltage divider than the cathode of the keying tube if desired. This will completely cut off the plate current of the 53 when the key is closed and provide a little more screen voltage on the oscillator. With some keying tubes this may be desirable but it does not appear to be necessary with the 53, since the zero-bias plate current is quite small for this tube. A separate bias supply may also be used to furnish the negative bias if desired.

With this circuit, the keying characteristics may be varied within considerable limits by regulating the negative voltage applied to the keying tube cathode. If several crystals having considerable variation in activity are to be used, it may be necessary to have a means of readily varying the bias on the keying tube. This can be done by using a high resistance rheostat, either as part of the voltage divider, or as a shunt across a portion of it. Another way is to have two or three adjustable taps on the voltage divider. A switch can then be used to select the proper voltage for each crystal.

— Sam E. Spittle, W9QOA

THREE-WAY SWITCH FOR CONTROL

HERE at W6PGL, I have found a time-saving kink for turning the transmitter on and the receiver off at the same time. I use a three-way switch from which the connecting bar on the back has been removed as shown in Fig. 3. One set of terminals is connected in series with the high-voltage plate transformer; the other set goes across the receiver stand-by switch which should

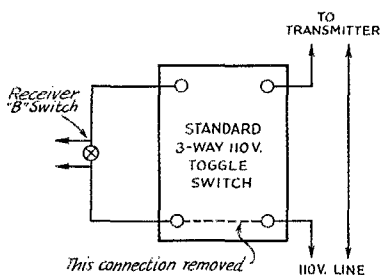

Fig. 3

be left in the "off" position. A switch of this type is obtainable at any electrical supply store.

— Dick A. Mack, W6PGL

AUTOMATIC STOP FOR BAND-SET CONDENSERS IN SUPERHETS

IN ANY receiver using electrical band-spread, with the padding condensers controlled from the front of the panel, the padders have to be set very accurately at a predetermined capacity for each band. The low-cost superhet described in *QST* for October 1938 is one of this type. The sketch of Fig. 4 shows an attachment for the oscillator-padder knob which has neatly solved

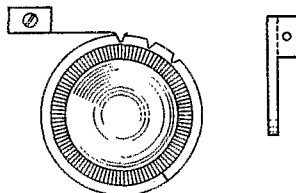

Fig. 4

the band-setting problems at W3HQP. For these padders, the usual small dial or pointer, knob and scale has its limitations. An error of a small fraction of a degree in resetting it by eye may throw the band-spread dial calibration off by several kilocycles — enough so that at sked time it's necessary to hunt back and forth across the dial until the station wanted comes in.

The automatic stop, shown in the sketch, makes it possible to set the padder right on the nose for any band. A flat spring was made from a piece of spring-bronze weather-stripping (approximately 24 gauge) about $\frac{3}{4}$ inch by $1\frac{1}{2}$ inch. The small hump at its left-hand tip bears against the rim of the knob. For each setting of the band-set knob, a notch is filed in the rim. At the right setting, the spring clicks into place in the notch and there you are! The notches need be only $\frac{1}{32}$ -inch deep or less and there seems to be no advantage in using a knob of larger diameter unless the notches have to be very close together.

The stop may be useful in many other pieces of gear, in-transmitters for example, to speed up the process of retuning for different bands. If the appearance is important, the notched knob and its spring might be located in back of the panel, out of sight on an extension of the condenser shaft, and the control of the condenser effected by another knob on the front of the panel.

— Lawrence Fleming, W3HQP

INEXPENSIVE TUBING SEAL FOR COAXIAL LINES

AFTER reading the article on coaxial lines by W2BZR in *QST*, I decided to build one. However, when it came to the end seals, I had a headache in trying to remove the center conductor from the spark plugs as described. When the third plug broke, I decided to try my hand at construct-

ing seals, since I did not want to pay \$2.50 each for commercial units. The sketch of Fig. 5 shows a seal built at a total cost of 51 cents. The parts needed include one National stand-off insulator (type GS-2, $\frac{1}{2}$ inch by $2\frac{1}{8}$ inches) at 21 cents and one $\frac{1}{2}$ -inch brass male adapter for $\frac{1}{2}$ -inch copper tubing, obtainable at any plumbers' supply store for around 30 cents. In the sketch, A is the male part of the adapter, B is the locking nut and C is an exploded view of the completed seal. The only work required is that of cutting off the beveled section of the male part flush with the end of the threads as indicated at A, filing the end square and drilling a half-inch socket $\frac{3}{8}$ -inch deep in the end.

To assemble the seal, plug this socket with a half-inch dowel and sweat the other end onto the $\frac{3}{8}$ -inch tubing; the dowel will prevent any solder from coming through. Do this at both ends of the line and run the inner conductor through the tubing after removing the dowel, allowing the wire to run about a foot past the end bead. Remove the metal ends from the stand-off and

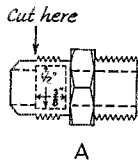

A

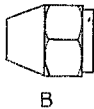

B

Fig. 5

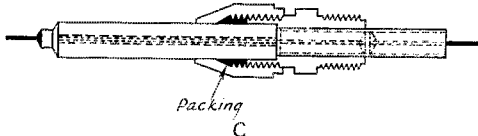

Packing

C

slip the stand-off over the wire into the socket, slide the coupling nut over the stand-off and pack the nut with about four turns of $\frac{1}{8}$ -inch graphite pump packing. Turn the nut up tight and, on the end where the wire comes through, lightly pack some string into the threaded space, pushing it in about $\frac{1}{4}$ inch. Slip the metal end over the wire and sweat, allowing some solder to run down into the threads in the stand-off. This will keep the cap solid. Do the same at the other end and you have a line that is air- and water-tight.

— Jack Burton, W2BRW

DRIP WIRES FOR ANTENNA FEEDERS

WHEN antenna feeders approach the window at a fairly low angle, rain has a tendency to follow the wires to the lead-through insulators

before dripping off. Unless the joints are water-proofed, the rain may even penetrate the feed-through. In winter this results in a pile of ice on

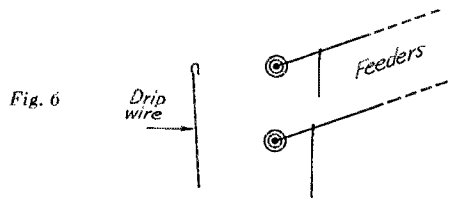

Fig. 6

the window sill and around the lead-through insulators. The feeders of my station enter the top of the window through insulators at such an angle that the wires carry a lot of water to the window where it drips down onto the window sill and splashes badly against the glass.

To remedy this, I made drip wires as shown in Fig. 6. They consist of short pieces of copper wire pinched on the feeders a short distance out from the window. These wires drip off all the water that runs in on the feeders, eliminating the nuisance of water dripping on the window sill as well as ice formation in the winter.

— Robert E. Foltz, W9GBT

“The Least of These My Brethren”

(Continued from page 22)

found as I expected that it was he that needed retuning and not the rig. He proved to be a grand young man. He was thoroughly competent, and in a short time had completely regained all his composure and confidence. I shall never forget the gratitude he showed me and the pleasant talk we had before I left the ship.

About a week later, as I was sitting at home reading the evening paper, I was startled to come upon a headline reading: “Portland man one of the ‘Mayport’ survivors.” My eyes ran hastily through the text. It seems that she had run into a tropical storm somewhere down in the Caribbean and foundered. A few were saved, including a seaman who had shipped on at Portland, but the boy — he had perished. I sat staring at the paper. All the circumstances came to mind. I do not believe any one thing in my life gave me more satisfaction than knowing I had been kind to that young man, just beginning what he hoped would be a career in radio. I never obtained his name, and through all these years he has remained in my mind as the “unknown radioman.”

As time goes on, we recall the incidents of years ago. They become object lessons, and paramount among these is the duty we all owe the beginner. “Inasmuch as ye have done it unto one of the least of these my brethren, ye have done it unto me.”



CORRESPONDENCE FROM MEMBERS

The Publishers of *QST* assume no responsibility for statements made herein by correspondents.

A.R.R.L.'S SAFETY CAMPAIGN SAVES A LIFE!

Rosemont Farm, Franklin, Pa.

Editor, *QST*:

It might interest you to know that the recent *QST* articles on safety have been very carefully studied around this place, especially since Saturday night. You see, the article on artificial respiration saved the life of one ham here in Franklin on Saturday night.

We have in town two hams, father and son, who jointly own a big, powerful transmitter. Around midnight Saturday the son was making a few minor changes in the 242A buffer power supply, when it became necessary to get in behind the rig, a rack and panel job, mounted about a foot out from the wall. Accordingly, he opened the relay in the power supply, removing the primary voltage from all the plate transformers, and crawled in behind the rig. His roll of hook-up wire, draped across the top of the front panel for convenience, became dislodged and fell — landing across the terminals of the filter condenser in the final power supply, and across him, too. His elbow was against the rack. A blinding flash — the most awful scream you ever heard — and there was the kid draped across the couch on the other side of the room! *The bleeder on the final power supply had opened; and the condenser was charged to full plate voltage — 3500 volts!*

His father, also a ham, was luckily right there. He dispatched his brother for a doctor, a pulmotor and an ambulance. Meanwhile, he acted according to the article in *QST* and began artificial respiration immediately. His son was stretched out on the floor, a pitiful sight: blue, tongue hanging out, bleeding from mouth and nose, totally unconscious and not breathing. The OM had never had experience with artificial respiration, never seen it performed; but — he had read *QST*'s article very carefully. So with a prayer in his heart he set to work — starting within 20 seconds after the shock occurred. After 25 or 30 minutes he was successful in getting a gasp or so from his boy. Normal respiration soon followed. Doctor, fire-chief with pulmotor, and ambulance then arrived. The boy was put to bed, suffering from shock and burns. The doctor said that *only the prompt application of artificial respiration by the OM was responsible for saving the boy's life*. If he had hesitated — or

neglected — death would have been certain. Only quick thought and action saved the boy.

The OM wants me to thank you people of *QST* for those safety articles, particularly the one on artificial respiration. His only son is alive to-day only because of your article.

The whole point of my letter is that I think it might well be pointed out in *QST* that artificial respiration is easy to learn — a father 57 years old saved his son from death, his first attempt at the thing, learned solely by the *QST* article.

I was down myself to see the boy yesterday. He is little the worse for his close brush with the Dark Angel. He himself wants me to remind others, through *QST*, that although he took all usual precautions — shutting off all the power transformers and exercising due care not to get against any parts which might possibly be "live" — yet it was the *unexpected*, the *unusual*, the *unpredictable* that occurred. Who could have known the bleeder had opened? (It had checked OK recently.) Who could have known that wire would fall in just such a way as to lodge across the condenser and the boy?

I know at least eight transmitters which were attacked yesterday for a safety rebuilding campaign. They were those of the eight members of the Fort Venango Mike & Key Club, of Franklin, Pa. No more accidents here. . . . The Fort Venango Mike & Key Club proposes to lose none of its members — safety is our program — *now* — before we forget.

Names have been withheld by request, as well as calls. The facts, however, can be verified by Dr. J. Irwin Zerbe, Franklin, Pa., attending physician.

So from the boy and his dad, as well as the F.V.M. & K. Club, our heart-felt thanks for those articles — more of 'em, *please*.

— Charles C. Miller, W8JSU

DIRECTOR ELIGIBILITY

100 E. Ohio St., Chicago

Editor, *QST*:

For some reason which I am unable to fathom, Mr. Fred Young, the present Dakota Division Director, seems unable to understand my stand on the matter of Director eligibility. . . .

(Continued on page 84)



OPERATING NEWS



F. E. HANDY, WIBDI, Communications Mgr.

E. L. BATTEY, WIUE, Asst. Communications Mgr.

The Copying Bee produced six perfect copies. . . . Hats off to the winners. They did a great job. The *operator* is the top factor in any communications equation, and the *real amateur* above all things knows his code. It takes keen ears to win this event. The ability to put accurate copy on paper is cultivated only by practice. These six men (account elsewhere in this issue) have demonstrated the highest ability in competition with hundreds of other amateurs. Congratulations to them.

We know, of course, that many another operator took part who didn't send in his copy, but who enjoyed the fun of trying just the same. All who entered the lists by sending copies have received their corrected papers. A word to those with newly acquired licenses: Aim to take part in the annual (December) A.R.R.L. Bees. Plan to devote a little of your time regularly to study of good operating practice—and to copying practice itself. Determine to make yourself an A-1 Operator in every respect, not to be "just another" ham, but to be above average in proficiency and personal skill. Every one of you has the makings of a top notcher. Find some traffic or press that is going just-a-little-faster than you can get "solid," and keep after it. You will find it fun, and you will learn a lot.

The Field Day dates are June 17-18, 1939, announcement scheduled for next month. See you there!

56 Mc.: Since the new regulations became effective in December, there has been a marked drop in use of the 56-60-Mc. band. Summer is coming, however, and we see about us already signs of activity picking up. It has been a minor dip in the occupancy curve while rebuilding to meet the newly required stability for transmitters on this band. Many of the bootleggers were squeezed out by the change in requirements. Their wabulated signals, made unduly conspicuous, are more easily turned in to get rid of the interlopers in our bands.

Those who like 56-Mc. work will remember the unusual DX available at this time last year. Most of it went to the crystal-controlled stations, we remember. This year we're *all* in the high-stability classification by means of crystals or long-lines arrangements. Read announcement of plans for week-end tests every-week-end-in-May elsewhere in this issue. There will be lots doing on 56 Mc. this summer. Get in the swim.

DX Jottings: "Stations replying to a test

or CQ call should give their own call signs at least once every five or six times they give the call of the station they are trying for. In the 'Phone Section one station repeated *calling G6BW* 34 times consecutively before giving his own call." "The majority of the W-VE stations made their calls far too long." — ZLICK. This is wholly a matter of experience and common sense, of course. We couldn't begin to tell you about all the letters we got complaining of poor notes, and rotten or selfish e.c.o. technique. Both these classes of letters topped previous records. A W9 writes to deplore the evil days and the new low in sportsmanship, adding, "Certain ones have been touted highly . . . but despite their fame . . . most of us fellows have discussed it . . . over the air . . . and are wise to them." These comments on *operating points* speak for themselves more eloquently than anything we could write. Use short calls. Break in. Read our low down on operating with e.c.o.'s (page 66, April *QST*) and follow the points of good e.c.o. practice there summarized—if you are getting started with one of these handy gadgets.

The frequency observance was superior to that recorded for recent years, and all individuals who helped to make it so are to be commended. There will, of course, be some disqualifications this time. A.R.R.L. policy is just as firm as in the past in preventing the development of frictions with other services that might prejudice the interest of all amateurs. But this year was much better. A fellow who poked his signal beyond a band edge for even a moment was conspicuous. The certainty that such a fellow will "get his" becomes greater each year.

—F. E. H.

BRIEFS

W1JIS is making a list of radio amateurs whose ages are fifty years or more. So far the following are included: H17G 67, W5ERV 67, W7UE 66, W2IKZ 65, W6CEH 65, W6BXB 64, W6IHH 64, W8BTO 63, W1JIS 62, W6KDX 61, W1AUK 59, W3EQ 57, W6DZE 56, W1WY 53, VE4AIX, W6MZF, W6QPL, W9NWN 52, W1HXV, W1SS, W6PMB 51, W1DJ, W1JPM, W6BWI, W7ABK 50.

— . . . —

Flash! W1AW operator joins the benedicts! George Hart (W3AMR), second operator of the League's headquarters station, and Miss Louise Stebbins of Coudersport, Pa., were married on March 19th. We knew there must be some good explanation for those recurrent trips to Pennsylvania! The whole gang will join us in extending very best wishes to Mr. and Mrs. "Geo."

PRIZES FOR BEST ARTICLE

The article by Mr. Dan Ward, Jr., W9SKU* wins the C.D. article contest prize this month. Each month we print the most interesting and valuable article received marked "for the C.D. contest." Contributions may be on any phase of amateur operating or communication activity (DX, 'phone, traffic, rag-chewing, clubs, fraternalism, etc.) which adds constructively to amateur organization work. Prize winners may select a 1938 bound *Handbook*, *QST*, Binder and League Emblem, six logs, eight pads radiogram blanks, DX Map and three pads or any other combination of A.R.R.L. supplies of equivalent value. Try your luck. Send your contribution to-day!

A Safe Safety Program

BY DAN WARD, JR., W9SKU*

IN LINE with the Safety program recently initiated by the League, and inspired by the present "safety-awareness" of all intelligent amateurs due to the untimely death by electrocution of several prominent amateurs over a short period of time, the Hamfester's Radio Club of Chicago, Ill., has inaugurated a safety program.

At the last club meeting in February the safety committee in cooperation with the program committee presented W9RT and two aides in a demonstration of the proper method to remove an electrically shocked person from the danger area without harm to the would-be rescuer, proper "carries" for the same purpose, and the Schafer method of artificial respiration. The demonstrators were all well qualified, having completed Red Cross First Aid courses and having had further experience in the National Guard and the employ of public utilities. The demonstration was well presented and appreciated.

Several members were heard to remark that, "Although the subject-matter is nothing new to me, the demonstration was interesting and well worth while."

I had been thinking the same thing and wishing that my wife, who is also a member of the club, had been free to attend the meeting. The further thought occurred to me that I should have arranged for the young lady who takes care of our youngster to be present. These thoughts and the remarks quoted above exposed, I believe, what may develop into the weak link of the safety program, viz., ignorance of the proper first-aid knowledge by the persons logically expected to be present and in a position to save an amateur's life in case of a possible accident — and remember, the 110-volt line or a receiver power pack may be lethal!

The obvious remedy is to:

GET YOUR PARENTS, WIVES, SWEETHEARTS, BROTHERS, SISTERS, FRIENDS, CHILDREN, GRANDPARENTS, GRANDCHILDREN, and EMPLOYEES to WITNESS the SAFETY DEMONSTRATIONS and STUDY the LESSONS TAUGHT.

This idea has been presented to the president of the Hamfesters and met with his endorsement. Accordingly, a program is being proposed that the Hamfesters, in the near future, hold an "open house" safety demonstration with all amateurs and especially their non-radio friends and relatives invited. A study is being made of problems incident to getting the potential rescuers to attend and profit from the demonstration, and to realize that they may be called upon to apply the principles learned.

One complication arising from this latter problem is that of stressing the importance of the fullest safety measures, both preventive and curative, without causing the powers that be in each household to clamp down the lid upon the "lid."

* 7240 S. Wentworth Ave., Chicago, Ill.

It appears that the idea of reaching the potential rescuers with our safety program deserves as much thought and effort as those parts of the program dealing with safeguarding apparatus and awakening safety consciousness in its operators.

BRIEFS

The Grand Lodge of New York, F. & A.M. is desirous of ascertaining the number of radio amateurs who are also members of the Masonic fraternity, particularly in the State of New York. If you have information along this line, drop a postal to Thomas C. O'Donnell, Sec'y, Board of General Activities, F. & A.M., 71 West 23rd St., New York City.

W8OKS suggests a "Sked Nite" for the benefit of stations wishing to arrange schedules for traffic handling or other purposes. On "Sked Nite" hams would call "CQ Sked" and open the way for schedule arrangements to be made. W8OKS suggests a call something as follows: CQ CQ CQ SKED DE W8OKS W8OKS W8OKS PITTSBURGH PA K. Any station hearing this call and desiring schedule with Pittsburgh could bear down on W8OKS. Any interest in this idea?

The New Bedford (Mass.) Amateur Radio Association participated in the third annual Hobby Show, conducted at the New Bedford Y.M.C.A., operating transmitters under the club's call, W1IXF, on 1.75, 3.5, 7, 14 and 56 Mcs. Ninety-seven messages were originated in the four days of the show. Due to existing conditions, messages were relayed to local stations. Operators at W1IXF were W1IWJ, W1KHV, W1KVU, W1CKI, W1GJB and W1KSO. W1JKT, W1LAZ and W1HPH acted as relay stations. Also assisting at IXF were W1HSR and W1FXB. In addition to the main transmitters various individual pieces of gear were on display. About 2000 people viewed the exhibit during the period of the show, February 22-25. Contacts were made with all districts except W6 and W7.

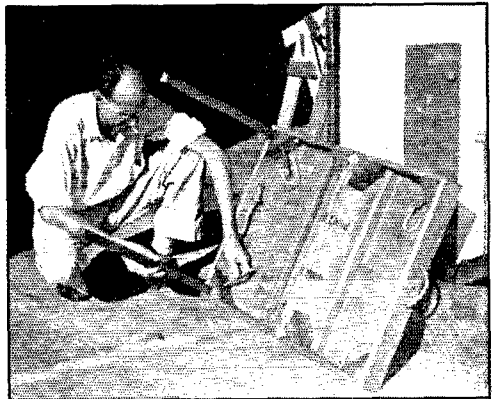

James W. Exline, Secretary of the Lake Worth Amateur Radio Club, demonstrates the combined equipment carrying case and portable operating table developed for emergency work. It's a practical, yet strong case for carrying emergency gear. You can make one. Use strong wood screws, not nails. Stout strap hinges and rope handles complete the job. Note how the pins are put in place in setting up the table.

"Jim" is one of the regular brass pounders at W4AWO. On his shift at WOE his sharp ears caught the first call from the *Esso Baytown*. He got the first word of the location of the ill-fated *Cavalier*, and was in radio touch with the whole situation, until the rescue had been completed.

Michigan Ice Storm

ORGANIZED amateur radio performed smoothly and efficiently following the disruption by an ice storm of normal communication facilities of several cities in Southern Michigan on March 12th and 13th. The Michigan C.W. Net on 3663 kc. (comprising the A.R.R.L. QMN Net and A.A.R.S. Net) and the Michigan Emergency 'Phone Net on 3930 kc. worked together effectively and admirably handled the situation.

The 3663-kc. Net started operations about 9:00 A.M. March 12th with W8DVC and W8CSG on watch. W8FTW (A.A.R.S. S.N.C.S.) acted as control until 11:30 A.M., when W8DPE (Michigan S.C.M.) took over until about 8:00 P.M. In the meantime the emergency station of the Detroit Amateur Radio Association (W8NLG) was taken out for a test, manned by W8GP, W8AKN (Emergency Coordinator), W8QGD (R.M., A.A.R.S.) and W8FTW. W8NLG worked into the net, receiving various reports on conditions. At 9:00 P.M. an order was issued by S.C.M. W8DPE for the emergency station (W8NLG) to proceed to the emergency zone, which was centered at Adrian. That city was without communication to any part of Michigan. W8NLG started out manned by W8QGD, W8QQK, W8GP and W8QZH, picking up W8CSG at Clinton and proceeding to Adrian. W8FTW relieved W8DPE as N.C.S. from 9:00 to 11:30 P.M., during which time W8DYH/8 at WCK (Detroit Police) came on with reports from the Michigan State Police. W8JUQ established communication with WRDS (State Police) and reports were then received from him. W8DYH and W8FTW arranged a continuous watch for the 3663-kc. frequency, as follows: W8AKN from 11:30 to 1:00 A.M., W8CEU from 1:00 to 3:00 A.M., W8IHR from 3:00 to 5:00 A.M. and W8DYH from 5:00 to 7:00 A.M. About midnight W8CLL took his receiver to W8CEU and three receivers there then made it possible to monitor WRDS (2630 kc.), W8DNY, Jackson (3930 kc.) and the 3663-kc. Net. W8DYH, with assistance from W8DK, made contact with W8DNY and requested him to keep a close watch on 3663 kc. W8CEU (with W8CLL and W8CEU operating) handled most of the net control work from midnight on, due to the excellent facilities for receiving.

W8EGI of Adrian arrived back in town from Indiana (where he was doing line work for the Consumers Power Co.) about 12:30 A.M. and instead of using the emergency station the W8NLG gang helped him get his transmitter set up on 3.5 Mc. W8EGI then established contact with W8DNY, and traffic was handled for the power company. The power lines were not put up until about 3:00 P.M. on the 13th; telephone service was almost back to normal by that time. W8EGI was on 3663 kc. from 1:00 A.M. until 9:00 P.M. Monday and from 8:30 to 11:30 A.M. Tuesday. The bulk of the traffic was urgent dispatching and line material orders for the power company to and from Jackson, where W8DNY maintained land line contact with power company officials. Some traffic was also handled for Western Union, and two death messages from Pontiac to Adrian.

On 3.9-Mc. 'phone the Michigan Emergency Net (3930 kc.) was on the job, W8DNY, Jackson, and W8BQA, Hudson, handling most of the traffic. W8KZK, Hudson (1.75-Mc. 'phone) handled power company traffic at that point until W8BQA installed an emergency antenna, his regular wire having come down. W8BQA then took over on the net frequency, working with W8DNY. W8LKV, Jackson, also assisted in clearing the net frequency. W8LFA worked as second operator at W8DNY. W8MYG, Emergency Coordinator of Lincoln Park, Mich., contacted W8EJR, Saginaw, and helped locate four trains for the P.M. Railroad. W8NNF, Litchfield, worked with the 3930-kc. Net, handling traffic for his city. W8WF and W8DK helped in keeping W8DNY's frequency clear. At one time, due to skip, a message had to be routed out of the state to W9JHQ, Indiana, who relayed it back to Michigan.

The following stations all participated in the emergency work in some way: W8DVC CSG DPE AKN BRS CEU CLL FTW QGD QZH QKQ GP EGI WF DNY DK DYH IHR SCS JZD BQA NNF KZK LKV RON RYP EJR MYG PLC NQI and W9JHQ. We are indebted to W8DPE,

W8FTW, W8EGI and W8MYG for reports on amateur cooperation in this Michigan storm.

W1AW Operating Schedule

OPERATING-VISITING HOURS:

3:00 P.M.—3:00 A.M. E.D.S.T. daily, except Sat. and Sun.
Saturday — 8:30 P.M.—2:30 A.M. E.D.S.T.
Sunday — 7:00 P.M.—1:00 A.M. E.D.S.T.

OFFICIAL BROADCAST SCHEDULE (for sending addressed information to all radio amateurs):

Frequencies

C.W.: 1762.5–3800–7280–14,254 kcs. (simultaneously)

Starting Times (P.M.)		Speeds (W.P.M.)								
E.D.S.T.	C.D.S.T.	M.D.S.T.	P.D.S.T.	M	T	W	Th	F	Sat	Sun
8:30	7:30	6:30	5:30	20	15	25	15	20	—	20
Midnight	11:00	10:00	9:00	15	25	15	20	15	15	—

*PHONE: 1806, 3905.5, 14,235 kcs.

Each code transmission will be followed in turn by voice transmission on each of the above frequencies.

GENERAL OPERATION:

W1AW devotes the following periods of the 3 P.M.—3 A.M. E.D.S.T. operating day, except for days starting Saturday and Sunday, to GENERAL work with all amateurs in the following bands:

Band	Frequency	Time — Eastern Daylight
1.8 Mc.	1806–1762.5 kc. 'phone/c.w.	11:00–11:59 P.M.
3.5 Mc.	3800-kc. c.w.	1:30–2:00 A.M. ²
		8:00–8:30 P.M.
3.9 Mc.	3950.5-kc. 'phone	9:30–10:00 P.M.
		1:00–1:30 A.M. ²
7 Mc.	7152/7280-kc. c.w.	2:00–3:00 A.M. ²
		6:30–7:00 P.M.
14 Mc.	14,254-kc. c.w.	10:30–11:00 P.M.
		6:00–6:30 P.M.
14 Mc.	14,235-kc. 'phone	10:00–10:30 P.M.

On Saturdays W1AW is operated from 8:30 P.M. to 2:30 A.M. E.D.S.T., and on Sundays from 7:00 P.M. to 1:00 A.M. E.D.S.T. On these days operation will be devoted to the most profitable use of bands for general contacts and to participation in special week-end operating activities and contests. The station is not operated on legal national holidays.

Give W1AW a call for an accurate frequency measurement, to communicate with any department of A.R.R.L., to rag chew when time permits, or to pass a message to ham friends in other places or on other bands.

The Mid-Hudson Amateur Radio Club will provide radio communication to assist participants and officials in the annual Albany-to-New York Outboard Motorboat Regatta on Sunday, May 14th. The set-up will have two branches: (1) A portable transmitter and receiver will be installed on a cabin cruiser anchored about four miles north of Poughkeepsie. Each motorboat passing that point will be identified and the Poughkeepsie Yacht Club dock advised accordingly, so that the particular boat's refueling crew can be all set to take care of their man with the least possible delay. All boats refuel at Poughkeepsie. In 1938 the winner of the race, who won by less than one minute, attributed his success to his short stop for refueling, made possible by the radio hook-up. (2) An Albany-Poughkeepsie circuit is planned, with the cooperation of the Albany Amateur Radio Association. This will enable the Albany end to advise the exact starting time of each class of boats, along with any other pertinent information as the races proceed; 28, 3.5 and 1.75, both 'phone and c.w., will be used during the regatta.

W8DAQ, O.O. and E.C., was honored by the New Orleans Ass'n of Commerce for outstanding traffic work. Perhaps you noticed his total in the B.P.L., April QST!

¹ All schedules effective May 1.

² Daily except Sun. and Mon.

BRIEFS

Replying to a "CQ Urgent" call from W2IYH of Red Hook, N. Y., WIKAL found that IYH was trying to locate someone having a certain type blood for a transfusion to a man seriously ill. He immediately telephoned the Boston City Hospital and was given the name and 'phone number of a suitable individual. Arrangements completed, this individual was soon aboard a train headed for the hospital where the transfusion was to take place. This was all within about two hours of the call from W2IYH.

W1JOS relayed a message to a W6 in Los Angeles, who was operating 28-Mc. portable-mobile. Not only was the message delivered at once, but the W6 drove to the address and the receiving party acknowledged it personally over the mike. Service plus!

W8ADV is a letter carrier at Elmira, N. Y. When QSL's arrive with incomplete address they are handed to him for proper distribution, but even he cannot always locate the amateur. He suggests that all hams file their call letters and addresses at their local Post Offices to help correct this situation.

W9SCH, River Forest, Ill., will keep watch on 1.75-Mc. c.w. for low-power stations that desire reports. He is also interested in low-power test schedules (less than 5 watts) on this band. He says the c.w. boys are missing a bet by not using 1.75 Mc. more, especially those using low power.

Bob Feller, Cleveland Indians pitcher, talked to the Knights of the Kilocycles through W4QP on the morning of February 19th. He got a big kick out of his introduction to ham radio.

W9RCQ raised CE4AD in answer to the latter's "CQ USA" on 14-Mc. c.w. at 7:00 p.m., January 30th. 4AD had several messages from the Earthquake zone. W9RCQ pulled through the first message 100%. Due to varying signal strength and interference, he received only a fragmentary part of the second message's address. "University of California, Berkeley, Calif." He got the complete text but failed to get the necessary fills in the address, due to the complete fade-out of CE4AD. Forwarding what he had of the message to the registrar of the Univ. of Calif., W9RCQ later received word that delivery had successfully been made to one of two students from Chile, who, needless to say, was overjoyed to receive word from his family.

Hamfest Schedule

April 29th-30th, at Fort Wayne, Ind.: The Technical Amateur Radio Club of Indiana Technical College is sponsoring a week-end North Central Amateur Radio Convention, to be held April 29th and 30th at the college building, 221-225 East Washington Boulevard, Fort Wayne, Ind. Attendance is expected from Illinois, Michigan, Indiana, Kentucky and Ohio. An interesting line-up of speakers is being selected. All amateurs are invited. Registration starts at 10:00 a.m., Saturday, April 29th.

April 30th, at Birmingham, Ala.: The Birmingham Amateur Radio Club invites you to attend its hamfest to be held in Birmingham at the National Guard Armory on Sunday, April 30th. Admission is one dollar and includes a very special barbecue dinner, lots of prizes and fun for all. Several group meetings are scheduled as follows: N.C.R., in charge of Lt. (jg) Aaron Bush, U.S.N.R., W4FB; A.A.R.S., led by Lt. Robt. E. Lowrey, W4DQW, and Aubrey Robertson, W4RS; A.R.R.L. Communications Activities, under Jim Thompson, W4DGS, Alabama S.C.M.; DX Pow-Wow, discussion led by E. Conway Atkerson, W4ECL. For the hams who arrive in Birmingham Saturday night, there will be an informal smoker at the club house. Get in touch with E. W. Smith, W4ERW, R. 2, Box A-1, Birmingham, Ala., for any further information.

Brass Pounders' League

(February 16th-March 15th)

Call	Orig.	Del.	Rel.	Extra Del. Credit	Total
W4PL	18	85	2238	76	2417
W7EBQ	0	0	1596	0	1596
W3HDQ**	11	22	1166	22	1221
W3CIZ	14	70	894	68	1046
W5FDR	64	109	720	51	944
W9QIL	43	80	714	78	915
W8KWA**	11	88	666	83	848
W4IR	5	96	652	76	829
W3BWT	35	47	684	39	805
W6IOX	14	26	740	22	802
W8GZ	7	14	756	10	787
W3HDQ	9	23	718	28	783
W1LNU	73	56	652	0	781
W4BAQ	8	52	592	48	700
K7FJC**	99	70	446	62	677
W8JTT	7	16	645	9	677
W8ECP	24	104	478	45	651
W8KWA	9	53	484	50	596
W5CEZ	39	107	422	26	594
W6DAQ	25	42	163	163	533
W5MNI	21	75	420	67	583
W4PEI	9	19	526	16	570
W3EML	45	140	246	137	568
W6LMD	9	10	537	7	563
W5FRP	9	9	516	8	542
W8DNX**	3	33	430	5	531
W5EOE	19	108	392	8	527
W8HCS	29	30	360	100	519
W5BN	142	81	146	146	515
W6LUJ	88	188	52	186	514
W9OLD	19	9	476	3	507
W7WY	13	27	444	16	500

MORE-THAN-ONE-OPERATOR STATIONS

Call	Orig.	Del.	Rel.	Extra Del. Credit	Total
W5OW	15	27	1604	12	1858
K4HR	605	582	392	0	1579
W4DUG	626	0	0	0	626

These stations "make" the B.P.L. with total of 500 or over. One hundred deliveries+Ex. Del. Credits also rate B.P.L. standing. The following one-operator stations make the B.P.L. on deliveries. Deliveries count.

W2HMI, 216	W5DKR*, 138	W5GUK, 114
W8FTW**, 131	W9BDQ, 137	W2KHA, 111
W8FTW, 173	W2JZX, 133	W3GTS, 108
W2JHB, 166	W4AOB, 132	W2GVZ, 105
W8ZAE, 160	W1KH, 126	W6DH, 103
W9ZFC, 146	W1JCK**, 125	More-than-one-opr.
W5FXX, 141	W8QGD, 121	W1AW, 204

A.A.R.S.

MORE-THAN-ONE-OPERATOR STATIONS

Call	Orig.	Del.	Rel.	Extra Del. Credit	Total
WLM (W3CXL) 134	185	3255	100	3874	
WLN (W2SC) 34	666	101	68	869	

A total of 500 or more, or 100 deliveries Ex. D. Cr. will put you in line for a place in the B.P.L.

* All traffic handled on radiophone.

** January-February.

*** December.

May 7th, at Ypsilanti, Mich.: The annual Detroit Amateur Radio Association "Michigan Hamfest" will be held on Sunday, May 7th, at the Armory, Ypsilanti, Mich. Admission: 75¢. The D.A.R.A. Hamfest is always one of the largest and most enjoyed of ham get-togethers. Prizes — fun — informality. Don't miss it.

May 13th, at Baltimore, Md.: The Mike and Key Club will hold its Sixth Annual Tri-State Hamfest on Saturday, May 13th, at the Emerson Hotel, Baltimore, Maryland. The club secretary will furnish complete details. Address Raymond Rock, W3EKZ, 1621 E. 32nd Street, Baltimore.

May 13th, at Milwaukee, Wis.: The Sixteenth Annual QSO Party of the Milwaukee Radio Amateurs' Club, Inc., will be held on May 13th in the Elizabethan Room of the Milwaukee Athletic Club. An excellent dinner, high class entertainment and famous Milwaukee refreshments are offered. Tickets \$2.00 in advance, \$2.50 at the door. Further information and reservations from George A. Ruger, Secy., 2160A South 29th St., Milwaukee, Wis.

How's DX?

HOW:

LAST month we mentioned an off-color practice that has cropped up because of the mad rush for cards by a few misguided individuals. A number of letters have been received commending the action, and it will of course be continued. It's the sort of thing we have some control over at this end and can therefore do something about.

On the other hand, there's one thing that's entirely up to the DX fraternity because it's practically impossible for us to do anything here except tell you about it. We've mentioned it before, and we're going to harp on it until everyone's so tired of listening to it that he will get smart and fall in line. Yes, it's that old business of consideration for the underdog DX. The latest DX to have his position jeopardized by thoughtless W's is YS2LR who, by this time, should be well known to everyone. Believe it or not, in spite of what 2LR tells them over the air and what we've pointed out here, some fellows have sent their cards addressed simply "Amateur Radio YS2LR, Salvador City, Salvador," with the result that 2LR is on the spot, not only politically, but with his employer down there. A good operator, he was in the contest just to help the W's (he had nothing to gain, being the only active station in YS), he QSLs just as fast as he can, and in every way has been one swell gent, and yet a few thoughtless W's are going to take away his fun and possibly his job. How long do you suppose ham radio is going to mean anything to someone who has been ridden off the air by a bunch of thoughtless card-chasers who care nothing for anyone else so long as they get their pretty pasteboards?

It isn't difficult to be thoughtful, and it doesn't cost any more. If you can't find the address of the DX in the Call Book, look for the QSL Bureau of the country in the Call Book or the I.A.R.U. column of QST (May or October issue). If that fails, take a look through this neck of the woods and see if we've given an address. If we haven't (the odds are even), for sosh gakes drop us a line and ask if we have any dope on the address. *Don't send a card blindly to the country!*

We have the undercover addresses of HP1X, YV2CU, PJ1BV, I7AA, YS2LR, PZ1AB, HR4AF, and LZ11D, and are glad to QSP your card if you'll include postage. Further, send cards in plain envelopes, with no mention of radio anywhere, to I, YU, SV, CN1, EL, HR, and any you may be in doubt about.

To change the subject, we'd like to present the results of a lengthy investigation of phoney cards carried out by W3BHV, the accredited authority on the subject. Mr. Banker finds that they fall into four general classes, as follows:

"1. The 'Come Hither' type. A DX swashbuckler who never signs the same call twice. A specialist in the art of leading the lamb to the slaughter.

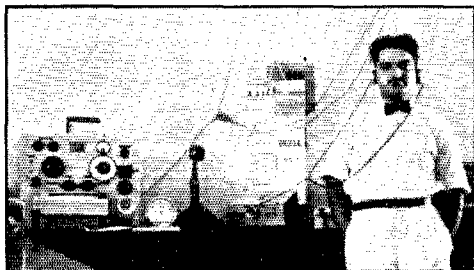

Eddie Behnan, YI2BA, at Basrah, Iraq. No dope on the transmitter, but the receiver you see is a Marconi RG-34. YI2BA has been taking a turn on 40 meters lately, usually from 22-02 GMT.

"2. The 'Rarity-Scarcity' type. Always pops up with a rare country call, and is subject to fits and convulsions while signing.

"3. The 'Bilge-Water' type. Snappily signs a phoney call in a flurry of key clicks and chirps. Consistently yaps of being a commercial or ex-commercial operator.

"4. The 'Linger Long' type. An international rag-chewer of no mean ability. Specializes in back-slapping and is saturated with friendship. Usually is totally ignorant of his own country's language. The uncanny resemblance to a 'W' fist is sometimes amazing!"

Thank you, sir. A worthy contribution to the science.

WHERE:

NO, FP8AA hasn't yet sent in that list he promised to. W4FVR, ex-W2AAL, says he was a ship anyway, and you know ships don't count in the DXCC, if that's what you were hoping And, by the way, YV2CU hasn't sent any lists since last October, so we can't give you credit if you worked him after that time, at least until we get another list. We'll let you know when we do That FG8AA (14,980 T7) that was on during the contest may be OK. W3ATR sent his card to Box 125, Point-au-Pitre, Guadeloupe, which is the address of their short-wave BC station, but it's too early to say whether it did any good W2BJ reports LZ11D (14,290 T8) worked. QSL via HB9CE, you know The address of TI2EC (14,350 T7) is Box 923, San José, Costa Rica, according to W4FIX GI6YM says FN1C (14,090) is quite loud over there on both 'phone and c.w., but we don't hear of many W's working him W8LCN worked I7AA (14,390 T7) during the contest and wonders if he got the real one. In any event, QSL only via the Italian Bureau W6AJD has his fingers crossed, hoping that VQ6NZ (14,390 T8), worked one evening during the tests, was legit By the way, you're only wasting your time sending your cards to HP1X (7110 T9x) care of HP1A. You might have gathered that from our comments in March, but we'll make it plainer now. However, HP1X is swell about QSL-ing, and we'll be glad to forward your card to him. He says that HP1Q is very likely a phoney That HZ1A (13,980 T7), worked by W6MVK and others, is doubtless a phoney. He's so loud in West Hartford he drowns out our pet power leak W9KXX and W9ZRP worked FD8YO (14,060), but he sounds almost too good to be true. Quite likely the Type 2 phoney The only person, and that includes the postmaster, that can get a card to PJ2DX (14,410 T7) for you is K4KD, so don't waste your time sending it anywhere else Maybe he's another Type 2 phoney and maybe not, but we'll put a big question mark after VT1A (14,410 T9), worked by W9AIW and claiming to be in Bhutan. He said he needed AIW's card for WAC, which may be the truth and then again may be just a new gag W8CMH got the QTH of XU3AA (14,075 T9) as Box 9, Chefwan, China W6JMR worked ZC6RL (14,095 T9) at 05 GT If you're looking for someone up in the north country, try VE5AID (14,300 T6). Your card can go to Tom Culbert, Nottingham Island, N.W.T., via N. B. McLean, Quebec, P. Q. Don't be in a hurry for the reply, though—the mail's delivered once a year, in August W6GPB gives us a good tip about Midway Island: K6OPJ/KD (7025). Joe worked him one Saturday night And speaking of the Pacific Islands, KC6BVL will soon be active on Wake Island on 10 and 20, and the address of KF6DHW (14,380 T9) is Charles Calley, Jr., c/o Dept. of Interior, Honolulu, T. H. . . . W2ESO says the address of HK4DF (14,000 T9) is Box 239, Medellin, Colombia YVAB9 is an expedition in Venezuela, in case you hear the call on 40 and pass it by for a phoney HO2U (14,360) is not a phoney in the U. S. with that screwy call. He uses it in his wanderings about the globe,

(Continued on page 72)



THERE have been many different schemes put forth for band switching in amateur transmitters. Most all of them in some manner or other call for inductance switching in at least some parts of the circuit. For low power final stages, exciters, buffers, etc., a practical, inexpensive, compact, and neat appearing arrangement has been suggested to us by W5AYL. It makes use of a standard Centralab Isolantite midget gang switch around which are mounted a set of our NATIONAL AR16 Victron supported air wound coils in somewhat of a turret fashion. In such a unit the handling capacity of both

the coils and the switch is just about the same and consequently make rather an ideal combination.

This brings up the point of suitable switches for final stages of high power amplifiers. After deciding that there just was no such thing as a really suitable commercially available switch for such purpose and that here was a swell opportunity for us to try and develop a new product that should have ready sale, we got talking to W6CUH a few days ago while on a brief visit to his lab at Burbank. Charlie told us of a very intriguing switch that he had just seen in the development laboratory at Heintz & Kaufman. A visit with Noel Eldred and Ralph Shermund at the South San Francisco home of the Gammatrons a few days later fully confirmed Charlie's story. — So, we just won't be in the switch business for a while — because it really will take quite a while, we think, before anybody can dope out a neater switch for this application! It has just the right spacing, quality of insulation, size of contacts, etc. for use in the plate tank circuits of full kilowatt rigs. The different sections can be ganged with any desired spacing between each other.

While in San Francisco we also had an advance look at the self tuning transmitter that the Eimac fellows designed and built for W6USA of the California World's Fair. By means of a number of small tuning motors such as now used in broadcast receivers all of the tuned circuits are automatically tuned to exact resonance at all times! — Change a crystal — the current goes up in all of the several stages due to the tuned circuits being slightly off resonance — the increase in plate current by means of relays starts the motors and they in turn rotate the variable condensers and inductive trimmers, etc., until "dip" is again reached!

There still seem to be a lot of people who jump at the conclusion that an 1851, etc. should make a good ten meter preselector and then wonder why the results are so sad. Inasmuch as we have already expressed our views on the matter pretty thoroughly in one of our recent Engineering News Letters, we will say no more about it here, other than to mention that a handy way of getting a connection to the B supply in most of our receivers, for Acorn tube preselector or other such use where the current drain is light, is to use the right one of the two "BSW" terminals to be found on the back of most of our receiver cabinets. These terminals are in parallel with the contacts of the front panel B switch and are primarily furnished for ease in connecting to a relay or "push-to-talk" switch for shutting down the receiver while transmitting. Thus one of the two terminals is directly connected to the high voltage side of the receiver plate supply at all times and the other terminal only while the front panel switch is in the "on" position.

The illustration this month doesn't quite tie-in with the paragraph above as it was originally made some time before this page was written. It indicates how an 1851 "Grid-Grip" can be made from an octal tube socket contact. — One socket equals eight Grid-grips!

Last month we announced in one of our several *QST* advertisements a number of new small parts including a dual binding post mounted on an R39 base. These new units are now being used as the Antenna and Ground terminals on most all of our receivers as well as for the RF link output of the NTE exciters.

JAMES MILLEN



Band Switching for Your Rig!

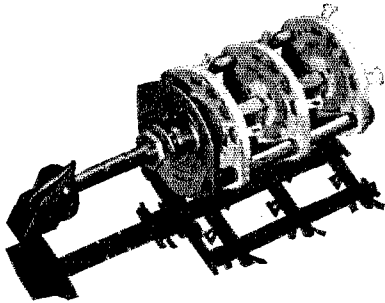

Now a reality with MALLORY-YAXLEY HamBand Switches

Now you can change bands with the turn of your wrist . . . as conveniently as you change bands on your communications receiver. Now you can enjoy the advantages that different amateur bands offer over certain distances during certain times of the day.

Mollory-Yaxley 100C HamBand Switches are rated for use in transmitter plate circuits using up to 1000 Volts DC with power up to 100 watts inclusive. Convenient terminal arrangements, wide spacing of current carrying parts, heavy silver-plating on contacts, and low-loss magnesium silicate ceramic insulation are features especially designed for high frequency applications.

Sketch at right shows how the 162C can be used to make a simple "Turret" assembly.

Many other applications are practical with these dependable HamBand Switches. Get technical data sheet from your distributor or send QSL Card to

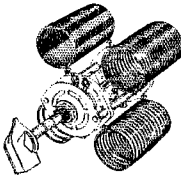

P. R. MALLORY & CO., Inc.
INDIANAPOLIS INDIANA

Cable Address—PELMALLO

Use

P. R. MALLORY & CO. Inc.

MALLORY

APPROVED RADIO
PRECISION PRODUCTS

Use

YAXLEY

APPROVED RADIO
PRECISION PRODUCTS

and writes to say that anyone working him can QSL via A.R.R.L. He operates from aboard a ship and sometimes ends up in some out-of-the-way places, so you might keep an ear out for him . . . Ex-AC2RT, who was second op at XU2AW until February, says XU4AW is quite legit, operating in Chungking, but his name cannot be disclosed, nor would the fellow welcome cards direct, things being what they are. But sending a card to the old Bureau address certainly shouldn't do any harm, and it might get to him . . . Speaking of China, Dr. Malcolm, ex-XU3MA and now XU8MA in Shanghai, gives us the answer to what has puzzled a lot of us — the apparent spurt of activity among the XU stations. He says that amateurs are quite active in and around Shanghai (and we presume other sections) because neither the Japanese nor Chinese seem to object to amateurs operating out there now . . . G60X in the Channel Islands says he has been off the air since 1936 and not to let the BL that's using his call fool you . . . W6MVK has it that ZC6EC has left Palestine, but a card will reach him via SU18G . . . Cards for HI7GW have been returned by HI7G, the QSL Bureau down there.

WHEN:

ASIANS on 40 are kinda interesting, and W6PCP has a nice list of ones active in the contest: J2IX (7100 T9), J2KO (7100 T9), J3FR (7140 T9), J2CL (7080 T9), J3CW (7120 T9), J3FC (7120 T9), J6EB (7085 T8), J8CA (7035 T9), J8CB (7180 T8), J8CH (7175 T9), J2KN (7120 T9), J9CA (7040 T6) and XU8AM (7125 T9). W6LIF adds that J6CD (7035) is on every morning at 6 A.M. PST looking for east coast and middle west stations . . . W2KIK adds to the 40-meter bit with TI6RR (7080), HR4AM (7090), FA3WR (7070), VO1B (7030) and YV4JC (7080); W5EHY has YV1AD (7180); and W3ATR contributes FA3RY (7120) at 03 GMT, HI3C (7070 T8), and G8OK (7270) at 23 GMT . . . W3HRS finds K6's and VK's good in the low-frequency half, as well as HH6CAS (7115 T8), QSL via HH4AS . . . HB9DI (7300 T6) rocks in at midnight every Saturday, according to W3BGD.

On 20, W2BHW managed to scare up a few new Asians for himself, including J8CH (14,315 T8), VS6AL (14,345 T8), XU8MI (14,360 T9) and XU7TH (14,390 T8) . . . W2BJ gets J3DG (14,400 T9), KA1SP (14,395 T8), PK1TT (14,300 T9) and XU8HM (14,400 T9); W2GVZ makes it 123 with GR4HT (14,415 T7) and EA9BA (13,985 T7), both around 5-6 p.m. EST . . . For Egypt, W8QCH suggests SU3HC (14,280 T9) and SU1AX (14,350 T9) . . . W1JEA worked some of the old reliables like J5CC (14,420 T8), CT3AB (14,360 T9), VQ3HJP (14,405 T9), VP4TO (14,345 T9) and ZD4AB (14,345 T9), and heard ST6KR (14,340 T9), VQ4RHL (14,340 T9), US1B (14,350 T8) and VQ2RR (14,410) . . . W8BWC has VS1AL at 14,380 while W2IOP puts him at 14,330.

WHAT:

W'e'd like to stick out the well-scarred neck again, and make a few suggestions to DX stations. First off, it's possible that a lot of them don't realize they can save plenty of postage by bundling all their cards for W's and VE's and shipping them *en masse* to A.R.R.L. HQ, for distribution through the QSL Manager system. We know of several DX stations who have cards but shudder at the thought of all the postage necessary to acknowledge the ones they've received. We don't blame them — in some cases it runs into a lot of chips — but we have a pretty smooth-running system here, just waiting to help out.

Then there is this e.c.o. problem, or hadn't you heard? In any event, it seems to us that if the DX stations would refuse to work a W station that calls on the DX's frequency or breaks up a QSO before it's over by calling on the frequency of the W QSO the DX, the pests would soon get wise to themselves and quit the practice. W2CMY tells us that XU4XA keeps a list of the offending W's and refuses to work them. We like the idea, as the first practical method of waking up some of the lads.

One more suggestion, to DX stations in a contest. Once you know the band is on to you, there is absolutely no necessity for a long CQ between each QSO. A short "QRZ?" will do the trick and work wonders with your score.

(Continued on page 74)

**SEE WHAT
THE RK 20A
OFFERS!**

**21 WATTS
UNDISTORTED PHONE OUTPUT**
with only **.36W MODULATING
POWER** and **1.5W DRIVING POWER**

EVER since RAYTHEON developed that suppressor modulated tube, Amateurs and Commercial stations have used them by the thousands. The RK20A has been especially popular among amateurs, who find it the perfect tube for an economical band-switched rig, with its low driving power, low modulating power and freedom from neutralization requirements.

It is just the ticket for a stable 10 meter rig, driven by a 6L6G, because of its high efficiency, stability and ease of operation at these high frequencies.

Requiring little modulating or driving power, you'll find an RK20A rig economical for undistorted phone transmission. Take a tip from the Airlines and Commercial Stations—use the RK20A!

**THESE MECHANICAL FEATURES
MEAN LONG LIFE!**

★ **MOLYBDENUM PLATE**—means a gas-free tube

★ **HEAVY THORIATED FILAMENT**—Greater Electron Emission

★ **THOROUGH SHIELDING**—No Neutralization Required

★ **DOUBLE ENDED FOUR PILLAR SUPPORT**—for the highest mechanical strength

★ **HARD GLASS ENVELOPE**—Takes high temperature without liberating gas

★ **ISOLANTITE BASE**—Greater Efficiency at Ultra High Frequency Operation

★ **SPRING MOUNTED FILAMENT**—Built to take jars and bumps

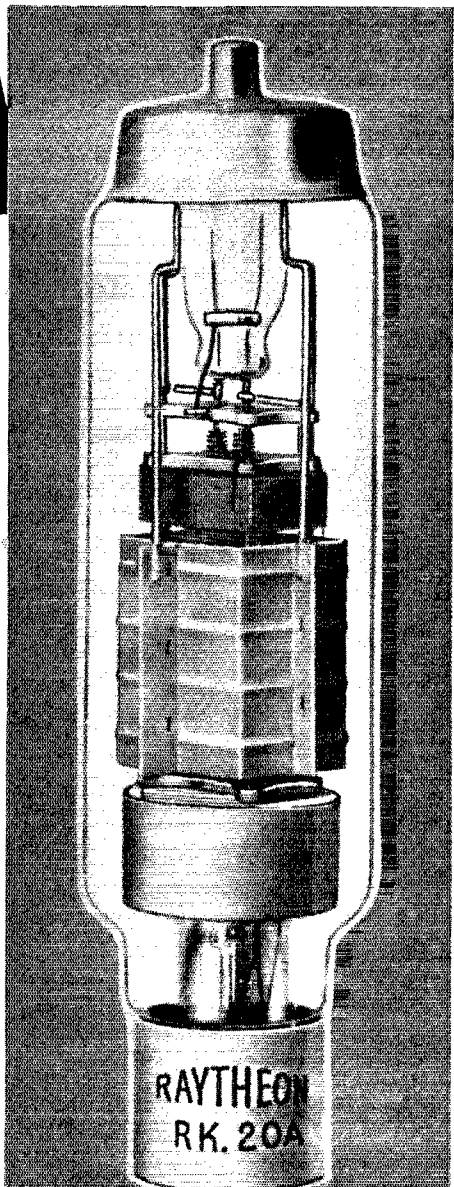

RK20A

Ep.....	1250 Volts
Esg.....	300 Volts
Ecg.....	100 Volts
Driving Power.....	1.5 Watts
Modulating Power...	.36 Watts
Carrier Power.....	21 Watts

AT ONLY \$15.00

**RAYTHEON
RK
TRANSMITTING TUBES**

NEWTON, MASS. • NEW YORK • CHICAGO • SAN FRANCISCO • ATLANTA •

"WORLD'S LARGEST EXCLUSIVE RADIO TUBE MANUFACTURERS"

STAND-OFFS

that

STAND OUT

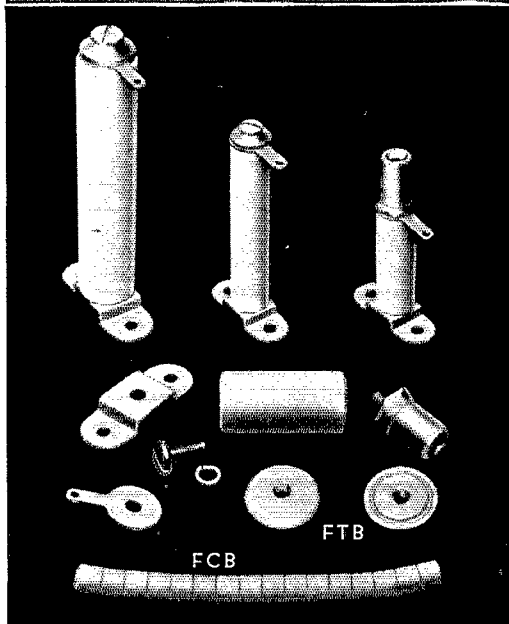

THESE NEW HUSKY stand-off insulators are made of pure glazed Insolantite. The use of Superior materials reduces chipping and breaking. Deep, full threaded holes insure greatest mechanical strength and practically eliminate slipping and thread wear-off. If you have been using inferior porcelain insulators, try these and note the difference. They will last longer and save you money. The hardware is also designed to give long service. The soldering lug is full size and of sufficient strength to serve for mounting parts. Available in a wide variety of sizes, with either plain or jack tips. "FTB" feed through bushings are used for insulating "live" leads that pass through metal chassis. The "FCB" flexible connector beads are ideal for insulating high potential plate leads. Ask your jobber to show you this new line of insulators.

Send for "39" Second Edition catalog containing further details.

HAMMARLUND MFG. CO., INC.
424-438 W. 33rd St., N. Y. C. Q-5-39

Please send me 1939 catalog



Name.....
Address.....
City.....State.....



HAMMARLUND

Canadian Office: 41 West Ave. No., Hamilton, Ont.

PHONE:

W1HKK has a nice list of worked stuff which includes J2MI (14,070, 14,110), J2CU (14,105), XU8RB (14,085), KA1PI (14,150), KA1FH (14,150), PK2AY (14,010), HA2C (14,280), CP1AA (14,300), and ZS1BV, ZS5BE, ZS6S, ZS2X, and ZS6AJ all on the low end of 20. FB8AH (14,350), VQ4ECJ (14,100) and XU8MC (14,260) were heard ZL1KN writes with a plea for more listening for DX by the 3.9-Mc. W gang. All W districts and VE4 and 5 come through "down under," and sometimes the signals reach SS in strength. The best time is between 12 midnight and 7 a.m., W time. Most active are ZL2BN (3965), ZL1KN (3930) and VK3WE (3660), although they might be found most anywhere, being allowed from 3.5 to 4.0 Mc. W8ND reports VP3CO (914,085) a new one in British Guiana. Old VP3AA now signs VP3LF W6LKG is happy about the whole thing, what with HK1AG (14,050), HK3CW (14,260), HK3CL (14,050), VK9VG (14,255), VK9DK (14,300), EI2Q (14,010) EI2D (14,100), TG9BA (14,260), HR2A (14,265), HC1FG (14,260), VP6YB (14,090), J8CI (14,080), YN11P (14,020) and LY1S (14,100) W6FZQ says J2KN (28,490) packs quite a wallop Other stuff on 'phone includes EA7BA (14,290), PK4KS (14,300) and GW3AX (14,030).

WHO:

You know, that was an amazing performance of W9HLF's, working AC4YN. Here was a whole country on the lookout for an Asian station definitely known to be active, and when Moore worked AC4YN on Jan. 6th, 7th and 9th, no one else in the country heard the Tibet station except a local in HLF's town, W9LLX. Several well-known DX stations, within 25 miles of HLF, hunted high and low for 4YN but couldn't find him, although he was S6 at W9HLF! It's incredible to think that the signal came down in only one spot in this country, but how else do you explain it? We've seen the card and letter from Fox, AC4YN, so the whole thing's on the up-and-up. You explain it — we quit On March 9th, W8CMH worked LU5AN, ZL3AX, ZS1CF, G6MC, VP4CF and VS6AG in 28 minutes, which tops all previous c.w. WAC records according to our musty files YI2BA says someone was bootlegging his call from Dec. 17th to Jan. 7th, when the genuine station was off the air W2CMY says CR4HT talks about his "14-year-old receiver," and wonders if 4HT isn't the old-timer that was on some ten years back W1KKO worked G4BL (yes, the G's are in the 4's now) the other day, and learned that 4BL is ex-VU2AU, in England for a spell VU7BR (14,340 T9) uses a 6L6 7-Mc. oscillator into a 6L6 doubler, and the antenna is a right-angle V with one 206-foot leg and one 99-foot one DX looking for Maine will find W1DFQ (14,260, 14,380) willing and able D4AFF needs Wyoming for that familiar reason, which is why ZL2LA wants New Hampshire, Vermont, Nevada and Wyoming G8IG doubles G2MI's offer, and will send two copies of the RSGB Handbook to his first QSL-ing QSO's with New Mexico and Arizona VK9EV will be glad to QSP cards to unlisted VK9's Don't worry about not receiving a card from VS7GJ. He'll be in England for about eight months and can only attend to the cards after his return to Ceylon W1WV says G3QF is in London now, and not on the Isle of Man as listed We have some cards on hand for PJ1AF, if he'll let us know where he is Leave it to W2GVZ to figure things out. Probably speaking from experience, he says, "A 'whirling dervish' is a guy who hears a new country call CQ when his beam is pointed wrong and the e.c.o. is set at the other end of the band!"

— W1JPE

W9ZVE, Oakes, N. Dak., was QSO W6NTM, portable-marine, 200 miles south of San Diego, Pacific Ocean. NTM's only means of communication was with portable 28-Mc. rig, 16 watts input, due to breakdown of big rig. W9ZVE took message for San Diego at 12:55 p.m., March 6th. At 1:08 p.m. the message was 'phoned to destination through W6MXX, El Cajon, Calif., 16 miles from San Diego. Nice speed!

W3HLX and W3HGC both live in Dundalk, Md. W5HLX and W5HGC also live in the same town, Pawhuske, Okla. All four work 14-Mc. c.w.



YOU WOULDN'T USE A FIRE HOSE TO WATER THE PLANT

Nor does it make sense to replace a small resistor with a LARGE one. In fact, most resistors in radio sets actually carry less than 1/4 watt load. It is changes resulting from high chassis temperature and humidity that actually cause breakdown . . . not overload. Replacements of the same material, but in larger sizes are no sure remedy.

Use CENTRALAB Ceramic Resistors and play safe. The type 710 is convenient to use because it is small in size and fully insulated. It rates at one-half watt, and will carry substantial overloads.

TYPE 710, rating 1/2 watt, size 1/8 x 5/8 inch. List price 60c for five.

TYPE 714, rating 1 watt, size 1/4 x 1 inch. List price \$1.00 for five.

See your jobber

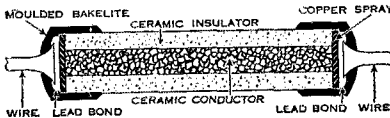

Center ceramic core, and ceramic jacket fired together to form a single shockproof unit. Pure copper covers resistor end for wire lead contact.

OLD MAN Centralab
says:

You'll have one gosh awful time getting anything but perfect performance with Centralab Volume Controls, Fixed Resistors, and Wave Change Switches.

Visit the
1939 National Radio Parts Trade Show
 June 14 to 17 a. Stevens Hotel, Chicago

Centralab

AXIAL LEAD RESISTORS

CENTRALAB · DIVISION OF GLOBE UNION INC., MILWAUKEE, WIS.

Active

An active crystal is easily excited; it snaps into oscillation rapidly, faithfully follows keying, and has a high Q. All B5 40-meter Crystals have a high relative activity because they are accurately cut, precision lapped, individually finished to rigorous performance standards, and mounted in a correctly designed holder.

Accurate

Each B5 40-meter Unit is calibrated by reference to a primary standard of frequency. The measured value is stamped on the holder name-plate and is guaranteed to be correct within .03% in any standard oscillator circuit. Precise calibration assures frequency accuracy—low drift insures frequency stability.

Dependable

Rigid manufacturing standards and careful inspections are applied during every processing operation. As a final check for perfect crystal quality and the ability to withstand adverse operating conditions, each crystal is subjected to an exacting overload test. Dependable performance is built into B5 40-meter Crystal Units.

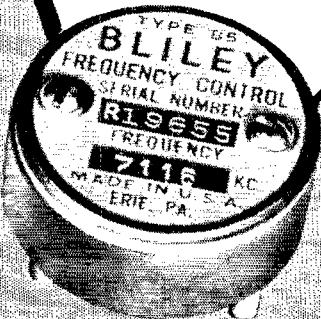

Price
40 Meters
± 5 Kc.
\$4.80

BLILEY

B5 40-METER CRYSTAL UNIT

MEMBERS, DX CENTURY CLUB

G6WY (No. 5).... 144	D4AFF (No. 99).... 109
W8CRA (No. 1).... 137	W2BYP (No. 102).... 109
W6GRL (No. 15).... 137	PA0XF (No. 43).... 108
W2GTZ (No. 12).... 135	W3EVT (No. 51).... 108
W2GT (No. 32).... 135	W8BKP (No. 65).... 108
WITW (No. 3).... 134	W3DDM (No. 72).... 108
WISZ (No. 7).... 133	W2DC (No. 79).... 108
W8DFH (No. 14).... 133	W9TB (No. 95).... 108
W6CXW (No. 4).... 132	W6HX (No. 21).... 107
G2ZQ (No. 6).... 132	G6CL (No. 24).... 107
W2GW (No. 11).... 130	W6FZL (No. 48).... 107
ON4AU (No. 40).... 129	W2AAL (No. 81).... 107
W8BTI (No. 56).... 129	W2ZA (No. 88).... 107
WITS (No. 9).... 127	W5KC (No. 92).... 107
W6KIP (No. 28).... 127	G5BJ (No. 93).... 107
W9ARL (No. 18).... 124	W9UM (No. 108).... 107
WILZ (No. 10).... 123	G2TR (No. 83).... 106
HB9J (No. 13).... 123	W1CH (No. 91).... 106
W8OSL (No. 23).... 122	W1DUK (No. 82).... 105
W3EMM (No. 58).... 122	VE2AX (No. 84).... 105
W1FH (No. 71).... 122	W4DRD (No. 94).... 105
W5BB (No. 37).... 121	W2OA (No. 73).... 104
W2BHW (No. 39).... 121	W3GAU (No. 96).... 104
W8DHC (No. 27).... 120	E1SF (No. 19).... 104
W1DF (No. 29).... 120	G5QY (No. 103).... 104
J5CC (No. 46).... 120	G6KP (No. 45).... 103
W8ADG (No. 63).... 119	W2CJM (No. 47).... 103
W1BUX (No. 2).... 118	W3AG (No. 107).... 103
W9KG (No. 16).... 118	W6FZY (No. 115).... 103
W8DWV (No. 17).... 118	G5BY (No. 118).... 103
W8OQF (No. 30).... 117	W4CBY (No. 20).... 102
W4BPD (No. 70).... 117	W1WV (No. 69).... 102
W2UK (No. 33).... 116	W8NJP (No. 90).... 102
W3EPV (No. 74).... 116	F8RR (No. 98).... 102
W8JMP (No. 22).... 115	G2DH (No. 101).... 102
W8LEC (No. 25).... 115	W1ADM (No. 110).... 102
W7AMX (No. 26).... 115	F8RJ (No. 8).... 101
W6ADP (No. 34).... 115	VK3KY (No. 57).... 101
W9PST (No. 35).... 115	ZL1HY (No. 59).... 101
W5VV (No. 38).... 115	W1ZB (No. 62).... 101
W9EF (No. 44).... 115	W4AJX (No. 75).... 101
W2HHF (No. 54).... 115	W6DOB (No. 76).... 101
W9ADN (No. 61).... 115	W2CBO (No. 86).... 101
W3EJV (No. 55).... 114	SUIWM (No. 89).... 101
W9TJ (No. 67).... 114	W1AXA (No. 104).... 101
W2CMY (No. 68).... 114	W1CC (No. 106).... 101
W3CHE (No. 87).... 113	SUI5G (No. 117).... 101
G6RH (No. 36).... 112	W1HX (No. 119).... 101
W9KA (No. 49).... 112	W3FRY (No. 85).... 100
W6GAL (No. 50).... 112	W8EUY (No. 97).... 100
W4CEN (No. 60).... 112	W2DSB (No. 100).... 100
G5RV (No. 64).... 111	G6NF (No. 105).... 100
W9FS (No. 77).... 111	W8KKG (No. 109).... 100
W2GVZ (No. 80).... 111	W2AER (No. 111).... 100
ON4UU (No. 31).... 110	VK2DG (No. 112).... 100
W9GDH (No. 41).... 110	W6KRI (No. 113).... 100
VK5WR (No. 49).... 110	W6TJ (No. 114).... 100
W2CYS (No. 52).... 110	W9UQT (No. 116).... 100
W3EDP (No. 53).... 110	W8AU (No. 120).... 100
W1JPE (No. 66).... 110	W3BES (No. 121).... 100
W4CYU (No. 78).... 109	W8OXO (No. 122).... 100
	W1FTR (No. 123).... 100

The following have submitted proof of contact with 75-or-more countries: D3BMP, HB9BG, PA0QF, VK3CX, W1BGY, W1GDY, W5CUJ, W9AJA 99; J2JJ, W1ZI 98; G5BD, G6GH, W1G0X, W1RY 97; G2MI, VE2EE, W8BOX 96; W1GNE, W8DOD 95; FB8AB, W3BEN, W6BAM, W6GHU, W8BSF 93; W2BMX, W3G6H, W3KT, W4CCH 92; G6MK, HB9X, W1BXC, W3ZX, W8AAJ, W8CJJ 91; G6YR, PA0QZ, W2IOP, W6FKZ, W6ITH, W8KTW, W9CWW 90; W2GRG 89; G2DZ, VK6SA, W3A00, W3JM, W5ASG 88; W3EMA, W2ALO, W4EQK, W9AEH 87; G6ZO, W3AIU, W3OP, W4MR, W4DMB, W8IQB, W9FLH 86; SP1AR, W4CFD, W8LAV, ZS2X 85; SM6WL, W3AGV, W8WBW, W9OVU 84; W1BET, W6GPB, W8BFG, W9BEZ, W9RBI 83; W8JAH, W8QDU 82; G6XL, VE2GA, W8DAE, W9RCQ 81; W3BVN, W3EPR, W3FLH, W6LDJ, W8AAT, W8DGP 80; LU7AZ, SP1LP, W3GHD, W6MVK, W6TT, W8JFC, W9MRW 79; W4TZ, W1EWD, W8FIN, W8MTY 78; W1ICA, W6AM, W6KUT, W9GMV 77; PA0JMW, W3AYS, W8BSB, W6DTB, W8LZK, ZE1JI 76; D3CSC, G8IG, W2BJ, W3CKT, W6GK, W9JDF 75. Radiotelephone: W4CYU 84; W2IXY 83; W6ITH 79.

INSIDE STORY

of the

HQ-120-X

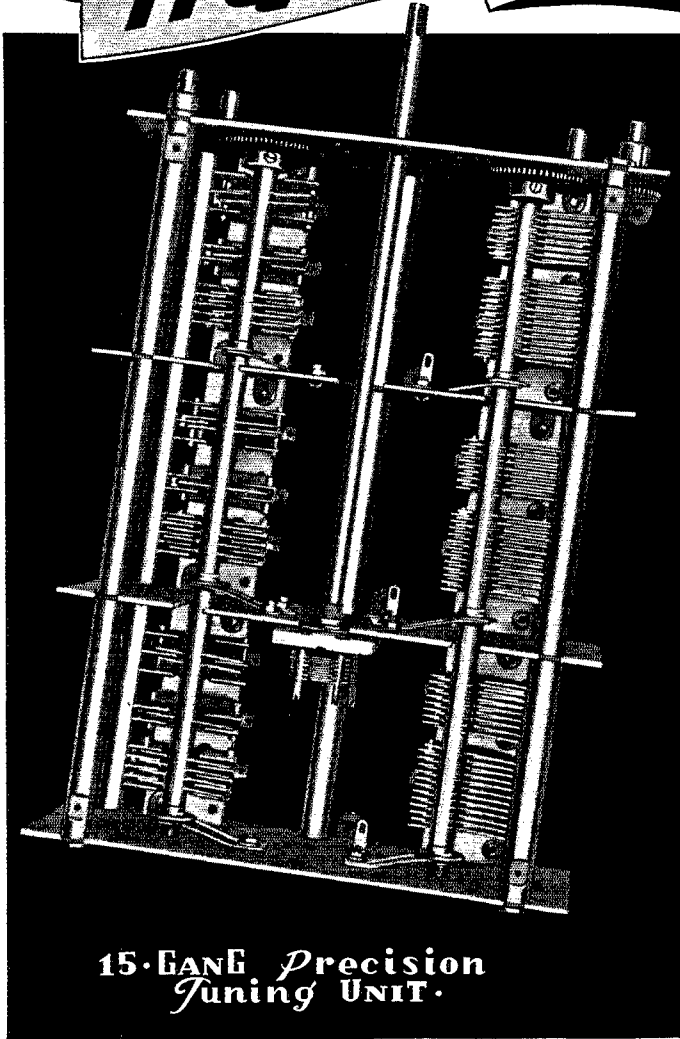

15-BAND Precision Tuning UNIT.

DESIGNING a receiver on paper is a relatively simple job. Making a mechanical reproduction, however, is quite another story. As an example, the I.F. amplifier in the "HQ-120-X" is sensitive to 1 kc. without the crystal and less than 100 cycles with the crystal in. This means that the tuning condenser must be no less than perfect for it must tune to one part in more than 300,000 at 30 mc. This calls for pure *rotational* motion. With the principle used in watch making as our guide, we installed a single polished steel ball bearing at each end of the condenser rotor to eliminate all signs of play. The plates of the condenser were kept small and widely spaced to maintain accuracy under all conditions. Its electrical stability is insured by six sets of dual inlaid silver-to-silver contacts. To maintain a favorable L/C ratio, the condenser has six main sections. To provide uniform band-spread there are nine sections in the band-spread portion. The use of precision gears permits 310° rotation of the dial for 180° rotation of the condenser, thus providing more comfortable tuning. It can be truly said that, "A receiver is no better than its condenser." Costly? . . . Yes. This condenser costs over 20 times as much as the usual remodeled broadcast unit. But it's worth the difference. Try an "HQ-120-X"!

Canadian Office: 41 West Ave. No., Hamilton, Ont.

Hammarlund Mfg. Co., Inc.
424 W. 33 St., New York City Q-5
Please send me 16-page booklet.

Name.....
Address.....
City..... State.....



HAMMARLUND

CAME THE DAWN



The one and only "HAMMETER"

3,000 volts self-contained (no external multipliers necessary)

A. C. volts: 0-15-150-750-3000; D. C. volts: 0-15-75-300-750-3000; D. C. milliamperes: 0-15-150-750; ohms: 0-3000 (center scale 30) and 0-300,000 (center scale 3,000)

Your net price **\$14.75**

The finest of panel instruments at lower prices

Simpson instruments are the only ones incorporating soft iron pole pieces and full bridge construction at these prices.

R. F. AMMETERS—Internal, thermo-couple radio frequency ammeters (1, 1½, 2, 2½, 3 or 5 Amps)
Your net price..... **\$4.59**

HIGH RANGE VOLTMETERS—D. C. plate voltmeters, complete with external resistors, (1,000 - 1,500 - 2,000 2,500 - 3,000 or 4,000 volts.)
Your net price..... **\$8.90**
(5,000 volt range \$12.00 net)

DECIBEL METERS—Rectifier type volume level indicator [-10 to +6 db (500 ohm line; 6 M. W.)]
Your net price..... **\$7.84**

OTHER OUTSTANDING VALUES ARE: D. C. plate milliammeters (all popular ranges from 0-5 to 0-1,000 milliamps), List \$6.35.
Net price to you..... **\$4.15**

A. C. filament voltmeters (0-10 or 0-15 V.) List price \$6.35.
Net price to you..... **\$4.15**

Illuminated dials for all popular ranges, including 6 V. lamp, 50c net additional.

SIMPSON ELECTRIC CO.

5210 Kinzie St., Chicago, Ill.

The daylight of known facts fell on every step of construction and trouble shooting when the new Simpson Hammer made its bow. Your needs designed this instrument. In its compact case — only 5¼ x 2½ x 1¾" — it holds the answer to all your problems of checking high voltage, checking steps in building, and running down trouble.

The same Simpson D'Arsonval movement that is used in the most elaborate Simpson Testers brings life-time accuracy to the Hammer. Test cables, tips, clips and case are heavily insulated and fully shock-proof. Voltage ranges (see listing opposite) have resistance of 1,000 ohms per volt.

The Hammer speaks quality — a glistening black insulated panel with gold lettering clear cut silver-etched scale — modern knife-edge pointer. See it . . . and you will be amazed at its modest price of \$14.75.

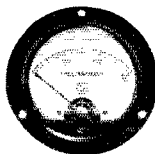

On April 8, 1938, W9RCQ was called on 7 Mc. by W9NNZ of Kirksville, Mo., who asked him to take a message from the *Kirksville Daily News* to the United Press in St. Louis. With all wires down, due to a severe sleet storm, Kirksville was without other communication. For the next two days W9RCQ (with the aid of W9EKY in St. Louis) and W9NNZ handled all of the press that appeared in the Kirksville newspaper.

International Network

A new network known as the International Network and consisting of Canadian and U. S. amateurs is in operation on 1.75-Mc. 'phone. Originated in December, 1938, by VE5AIA, VE5ADB and W7GNA, the net now includes stations in Washington (W7GWL N.C.S.), Oregon (W7GHM N.C.S., W7HGJ Asst. N.C.S.), Montana (W7BWH N.C.S.), Idaho (W7GPM N.C.S.), California (W6OTL N.C.S.), Alberta (VE4AO N.C.S.) and British Columbia (VE5AIA N.C.S.). W7GWL is the main control station. The International Network meets nightly at 8:30 p.m. PST on 1870 kc. An invitation to join is extended to all U. S. and Canadian amateurs who can report in on the net frequency at the regular time. The net is dedicated to the betterment of amateur radio and to cooperation in any emergencies where its members might serve. Included on the roster are VE4AO VE5AAC ADB AIA W6OTL NRO OUC W7GWL FCZ ECC SA GSS GSN GNA HIF HCO CJI FIF BJP HHC EKT GXI CR HCS BWG HBC GPI AZI BHP GUJ DCV GHM HGJ FJY AEN FLX BWH GPM and GWI.

56 and 112 Mcs.

W2AMJ makes some interesting observations regarding conditions noted on 56 Mc.: "The Northern Lights were going to town on the night of February 24th. I got on 56 Mc. at about 8:20 p.m. I sent a CQ on i.c.w. and was rewarded with a call from W8VO in Akron, Ohio, also on i.c.w. His carrier was S9 but had the most peculiar sound to it, with or without modulation. He told me that the band had been open out there for about an hour. He worked W2KLZ earlier in the evening. I swung over to 'phone, and he advised me that the 'phone was unintelligible. Then he shifted to 'phone, and boy, if you ever heard inverted speech you should have heard his. It sounded nothing like voice modulation. We continued the contact on i.c.w., S9 both ways. At no time was there any appreciable fading. The signal was just like it was around the corner, except for the peculiar combination of howl and roar that accompanied his carrier. We signed about 8:45, and a little after 9:00 W8VO dropped out of the picture just like somebody cut the wires with a pair of pliers. W1EYM called me then. I did not notice anything unusual on his signal, but he told me about the Northern Lights and for the past hour had noticed the characteristic rumble on quite a few 2nd District signals. We also found that practically all of the 28- and 14-Mc. harmonics had the same characteristics that W8VO's signal had. W8AGU, Penfield, N. Y., heard both W8VO and myself; he also noticed the strange condition, which he called exceptional QSB."

W1IJ, Madison, Conn., reports progress on 112 Mc. His first two-way contact on this band was on March 23d, the date he got his transmitter on the air. First QSO was in the afternoon with W1CPL, Devon, Conn., a distance of 22 miles. CPL was using a 53 oscillator with an indoor four element beam. A few minutes later W1IJ made contact with W2HNY, Riverhead, L. I., about 25 miles distant. This contact was the result of months of planning. HNY's signals were S7 and he reported W1IJ as S6. IJ uses a pair of HK24's with 18 watts input and a 56-Mc. Johnson Q antenna, 60 feet up; receiver is a National 1-10. W2HNY was running 20 watts to an RK34 coupled to a close-spaced beam located in his attic. Plenty of action is expected on 112 Mc. this summer in southern Connecticut and the New York vicinity. W1CPL reports working 14 stations in and around Bridgeport. The boys at Riverhead are showing interest with W2HNY on the air. W2ADW has a receiver going and a pair of HY615's for the transmitter. W1JZJ, W1KGL and W1KJF in the New Haven area have been worked by W1IJ. W1IJ reports most of the gang using grid rods, with W1KPN using M.O.P.A. Most 'antennas are simple close spaced beams.

Don't miss the 56-Mc. tests scheduled for each May weekend. Let us hear of your results in these tests, and of any 112-Mc. work you may be doing.

SIMPSON

INSTRUMENTS THAT STAY ACCURATE



HAVE YOU P. O.*?

SOMETIMES even your best meter won't tell you when your transmitter has P. O. trouble. That's the insidious thing about it.

Overheating, frequency instability, a rough note, or low efficiency are often signs of these baffling ultra-high frequency oscillations.

Some of the common trouble spots are:

(1) At the grid or plate, or both, of beam power tubes. (These superb tubes are particularly susceptible because of their high power sensitivity.)

(2) At the grids of your P. P. final amplifier.

(3) At both plates of type 83 mercury vapor rectifiers (where "hash" develops).

(4) At plate and grid terminals when power tubes (either R. F. or audio) are operated in parallel.

May we recommend an old remedy? Our "F" Type Metallized Resistors have long been used in this service, shunted across a small choke coil. Their excellent flat frequency characteristic is an important factor. The choke coil is conveniently made of 5 to 8 turns of No. 18 or No. 20 bare wire wound directly around the Isolantite body of the resistor and soldered at each end to the leads or end caps. Use care in soldering and you can make a neat little assembly. The resistor can be a type "F-1/2" (1/2 watt) for low-power tubes such as the 6L6 or type 83 rectifier, an "F-1" for tubes like the 807, 35T, 808, HK-154, etc., or the "F-2" resistor for larger tubes. The resistance value is not particularly critical — 25 to 200 or 300 ohms will be all right. It is important that this little suppressor be mounted as close as possible to the tube element. The accompanying snapshots show how the gadget can be soldered right on a grid or plate clip or a socket terminal.

You're welcome.—No, we only make the resistors.

*Parasitic
Oscillations

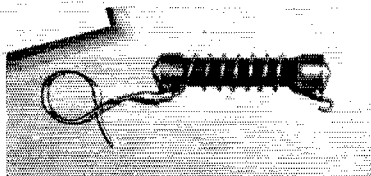

INTERNATIONAL RESISTANCE COMPANY • 401 NORTH BROAD STREET, PHILADELPHIA, PA.

ADVERTISEMENT



ENTER ASTATIC PICTURE CONTEST \$100.00 IN PRIZES for Best Photos Showing Astatic Crystal Products

A grand prize of \$50.00 and ten additional prizes of \$5.00 each will be given for the best photographs showing Astatic Crystal Microphones and Pickups in actual use. No expensive photos are required. Any size camera picture will do providing it is sharp and distinct. Use your own camera or have a friend make a snapshot of you and your Astatic equipment and installations.

CONTEST RULES

1. Any person, excepting an employee of Astatic Microphone Laboratory, Inc., is eligible to enter this contest.
2. All photographs must include operator or other individual and must show Astatic Microphones or Pickups in actual use or installations.
3. All photographs received will become the property of Astatic Microphone Laboratory, Inc.
4. Contestants must agree to the release of accepted photographs for advertising or trade purposes.
5. Photographs may be any size, large or small, providing they are clear and distinct.
6. Contest closes August 1 and awards will be made August 15.
7. All photographs must bear the name and address of the sender and station call letters, if any.
8. Entries must be mailed directly to Astatic Microphone Laboratory, Inc., Youngstown, Ohio.

The purpose of this contest is to enable Astatic Microphone Laboratory, Inc. to become better acquainted with its great family of Astatic enthusiasts in all parts of the world. We would enjoy having you take part. Read the rules carefully. The contest closes August 1, 1939, and awards will be made August 15, 1939.



Astatic Microphone Laboratory, Inc.

Youngstown, Ohio

Licensed Under Brush Development Co. Patents

Astatic Patents Pending

Line Up for O.R.S. Now

Invitation to all traffic men: you will find the latest plans of vital interest to you. We should be glad to have you an O.R.S. Regular bulletins cover the things you are interested in. O.R.S. are known to all hams as the most efficient reliable stations there are, with operators always ready for any communicating job, and upholding the traditions of amateur radio in every respect. The plans for the future give even more point to these features which you will want to support for the constructive aspects and good example to the inexperienced as well as for the direct benefits that accrue to you. Drop a postal to A.R.R.L. today for information on O.R.S. appointment.

Newly appointed "reliables" now included in the roster of O.R.S. are as follows:

W1JLL	W3AKR	W6PCP	W8BYM	W9TDS
W1HTO	W3HUM	W6ISG	W8RMH	W9NGS
W1HNE	W3BZX	W6EFC	W8OXO	W9QIW
W1KTB	W3CGU	W6OWV	W8UW	W9MCC
W1ZB/3	W3BRA	W6MYT	W8IXJ	W9JZY
W1LOC	W3ER	W6CZO	W8PWJ	W9YTV
W1LBY	W3HLV	W6GTM	W8RKZ	W9JID
W1KYQ	W3BZE	W6OQH	W8RVM	W9GFF
W1KKS	W3EEW	W7GCO	W8RIT	W9FCG
W1BDU	W3RR	W7GGM	W8SBV	W9QMD
W1LER	W3HDB	W7GZG	W8SFF	W9CQF
W1IGN	W3GHD	W7GLM	W8NAB	W9HDA/7
W1EFW	W4ERW	W7ABO	W8OFN	W9ZFC
W1AOK	W4CRG	W7HGC	W8RZF	W9OMC
W1KLR	W4RTH	W7EQM	W9GMD	W9UKD
W1HYF	W4PEI	W7AOU	W9DUA	W9PKW
W1GAN	W4EQP	W7CJR	W9DM	W9IGF
W1JNV	W4FDJ	W8EYY	W9DZ	VE1EV
W1AFA	W4EBZ	W8NDS	W9SDG	VE1KG
W1FTJ	W5AZB	W8KMS	W9NEP	VE1MK
W1ICS	W5GJW	W8FUW	W9YXH	VE1KS
W2LR	W5BKH	W8AIZ	W9CVH	VE1KQ
W2LHP	W5FRE	W8RQE	W9WJX	VE1LP
W2KMI	W5ZU	W8RFF	W9QLZ	VE2OL
W2KWG	W5GKJ	W8LCW	W9VRZ	VE3BB
W2SZ	W5GFH	W8QUN	W9ZFS	VE3SF
W2KUD	W5BAM	W8NUA	W9KAD	VE4CQ
W2LLU	W5EWZ	W8IIO	W9ZGS	VE5ID
W2HHY	W6PCB	W8CXT	W9TFA	VE5FG
W2ITX	W6NVC	W8RRS	W9FWW	CM2OP
W2LEL	W6LUJ	W8NA	W9FOC	

— * * * —

Join the O.P.S. Group

If you have a good 'phone, drop a line to your S.C.M. (address in each issue *QST*) for application blanks for Official Phone Station appointment. A.R.R.L. Headquarters will also be glad to send information regarding O.P.S. work to any amateur who inquires, including sample copies of bulletin material as long as extra copies last. Any radiophone operator interested in furthering good voice operating technique and improving conditions in the 'phone bands should sign up with the Official Phone Stations.

The following stations have received O.P.S. appointment since the last additions to the Official Phone Station roster appeared in *QST*:

W1JBJ	W2EOA	W5AVO	W8JM	W9YWE
W1FOI	W2HXQ	W5EQP	W8PBX	W9MBI
W1HYK	W3EKZ	W5AO	W8RJG	W9VUH
W1JGQ	W3EMA	W5EPB	W8PIK	W9SAU
W1GAN	W3GDG	W5FMO	W8RGA	W9JYX
W1COI	W3EUH	W5EVS	W8BRE	W9PUS
W1ICS	W4CRG	W6PCA	W8RAT	W9IGF
W2CET	W4EPV	W6IGO	W8SWF	W9UJV
W2ABS	W4BPD	W6EFC	W8CMF	VE3TM
W2LAG	W4FNC	W6MVK	W9VSX	VE3ABZ
W2KUD	W4COL	W6LMD	W9DDC	VE3ST
W2JDG	W4DPN	W6PER	W9TFA	VE4SB
W2HYJ	W4EGH	W6BWG	W9WTD	VE4SS
W2KUY	W5GST	W7FMY	W9JVR	VE4AA
W2JUX	W5HHT	W7EQM	W9MUR	K8MVV
W2GFD	W5JW	W8NA	W9DYI	W2JRE

20-Year Club Members

There are now 128 members of A.R.R.L.'s "20-Year Club." Membership in this group of old timers is open to any amateur who held a license (amateur operator or station)

Better Buy HARVEY

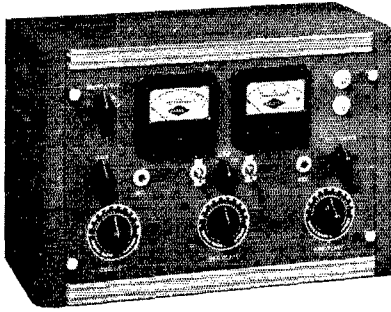

UHX-10 (at left) This portable, mobile transmitter retains all the outstanding features of its predecessor, *plus* improvements in construction and assembly. Coils for the various bands (5-200 meters) may be changed easily and quickly by lifting the hinged cover of the slate gray cabinet. All controls and meters are on the front panel. A special switch selects CW or PHONE emission. This unit can be operated from either an AC power pack or 6-volt dynamotor, both of which are stock items. Inexpensive to buy and operate, the UHX-10 has no equal in its power class.

100-T (at right) A unit outstanding for its small size in relation to its power rating. It has everything — appearance, 5 band operation, quick frequency shift, ease of tuning and low cost. All controls are located on the front panel including an on-off switch, excitation control and high-low voltage switch for tuning up purposes. The slate gray hinged cover cabinet is chrome trimmed and all control designations are engraved directly on the panels. This plate-modulated transmitter, an aristocrat in every sense of the word, will open your eyes to a new "high" in efficiency and dependability.

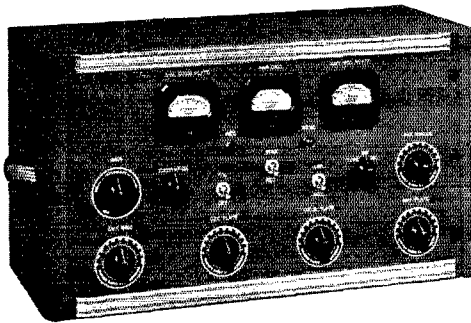
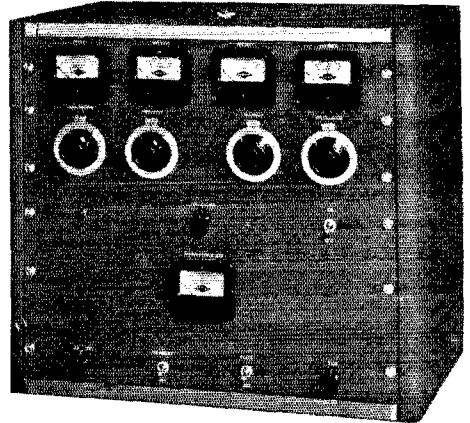

UHX-25 (at left) The combination of tubes, in this big brother of the UHX-10, permits the use of a crystal microphone which is important for clear, crisp speech. So versatile is this transmitter that it can be used as an exciter for higher RF and audio power when desired. Other features are: switch for series or parallel antenna tuning; speedy band changing through hinged cover cabinet; separate chassis for power supply; and last but certainly not least, its low cost, which makes it an outstanding value in the transmitting field.

Write for illustrated catalogue containing complete information on Harvey transmitters, including those shown above. Catalogues on Police and Marine equipment also available.

Export Office: 25 Warren Street, New York City

Cable: Simontrice

HARVEY RADIO LABORATORIES, INC.

25 Thorndike St., Cambridge, Mass.

**READY
Wound
XCITER
Tanks**

For
10 · 20 ·
40 · 80 ·
METERS

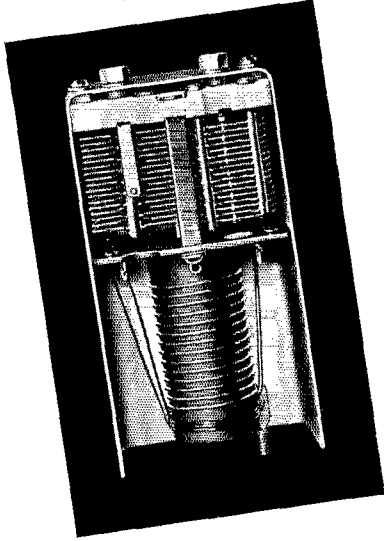

HAMMARLUND'S new ready-wound exciter tanks are designed for use in multi-stage band switching exciter units. These units represent the complete tuned circuit. The condensers are double spaced and mounted on Isolantite bases. The inductance is wound on a natural Bakelite form, grooved to prevent turns from shifting. A link winding is provided so that these units can be used in either link or capacitive coupled circuits. They are available for the 80, 40, 20, and 10 meter bands, completely assembled with long connecting leads ready for installation. These exciter tanks are used in the new HAMMARLUND "ED-4" and "EU-4" multiband exciter units which appeared on page 99 of the April QST.

Send for new 1939 catalog describing this and many other new Hammarlund transmitting components.

MAIL COUPON TODAY!

HAMMARLUND MFG. CO., INC.
424-438 W. 33rd St., N. Y. C. Q-5-39

Please send me 1939 catalog



Name.....
Address.....
City..... State.....



HAMMARLUND

Canadian Office: 41 West Ave. No., Hamilton, Ontario

20-or-more years ago and holds a ham call to-day. If you'd like some first-hand dope on conditions in the "old days," give one of these fellows a call: K4KD K6ONM W1AHY AJ AR BB BSJ CJA DMF EAO EH ES FA FJE FMP GDY GS HGX HXQ JFN NF WR W2AX BO BR BYW CJX DI DYT DZA EC ELN EMV GVV HCO HTU IMF IP IW IZ JF JRG PF W8ACX AVJ BO BZ CA CZO DRO EUY FLH GJ GLH GPA GQL HQW JL RR WS W4CBY DIN WD/5FSI W8AQD CVQ EOW ERJ NT W6AM AVC EA GM IT IX KMA KTQ LM MMB MSN NPD OCH OJY PKX VU W7AZX BG COH DVY EMT GCO W8APD CHU CMH CNX DOX FRY GYR KHM ND OXH QAN QKQ SQE ZS ZY W9AA AB CS CSZ CX DAX DGM DHM EL ESA FRC VFW VKF VS VV WIN WTE WZE YNQ VE8RB VE3UX VE5GA.

If you can qualify for the "20-Year Club," send us a brief chronology of your ham career, particularly the date you started in amateur radio, date of your first amateur license, calls you have held during the years and the call you hold to-day.

BRIEFS

When Mrs. Ralph W. Emerson of Cleveland, Ohio, collapsed with a sudden heart attack, Ralph, W8LYI, having no telephone and being uncertain of locating one, turned on his 56-Mc. rig and transmitted a call for help. W8IEF picked up the distress call and telephoned the Cleveland Police, who dispatched a physician in short order. W8IEF then called W8LYI to assure him that help was coming. Mrs. Emerson is one XYL who has nothing but praise for amateur radio!

During the recent hurricane emergency in Rhode Island the Navy and Army worked together for a common good. The R. I. National Guard called upon the local force of the U. S. Naval Communication Reserve to set up and maintain radio communication between the various isolated sections. Under the command of Lt. (jg) H. Young, N1CAB, and Ensign D. Wicks, N1IZO, using the personal equipment of N.C.R. members as well as Naval Reserve equipment, four stations were set up and a twenty-four-hour watch was maintained for one full week, at which time the emergency was declared at an end. One to two hundred official messages were handled daily, with efficiency and dispatch gratifying to both the National Guard and U.S.N.C.R. Those who took active part in this duty were: Miller, RM1c, N1AWG; Myers, RM1c, N1HEN; Corey, RM2c, N1GVH; Hayward, RM3c, N1KEM; Campbell, RM3c, N1KXA; and Bellisle, W1KKE. Personal letters from the Governor to each Reservist participating expressed the appreciation of the State for the fine work done.

"The American Mutual Emergency Net I started last spring is growing fast. At present our c.w. nets are practically nil as we haven't had time to push them. The 160 phones are getting hold. We have a District Control in each district including Canada and Puerto Rico. We are using A.R.R.L. procedure as the model of operating."

--- W1PI

The increasing importance of amateur radio in emergencies was pointed out by Mr. Merrill Bernard, Chief, River and Flood Division, U. S. Weather Bureau, in his article, "Defeating the Floods by Preparedness," which appeared in the November, 1938, issue of *American Forests*. In commenting on communication facilities, Mr. Bernard stated, "The radio amateur is rapidly becoming a bulwark against the failure of wire lines during flood emergencies."

O.B.S.

The following is a supplement to the list of A.R.R.L. Official Broadcasting Stations in October QST (page 71): W2KHA, W5HHV, WSDXB, W8GHP, W8NUA, W9GLI, W9MWU, W9TDS, VE3AMJ.

Station Activities on page 100

AN UNBEATABLE COMBINATION FOR 5 AND 10 METERS

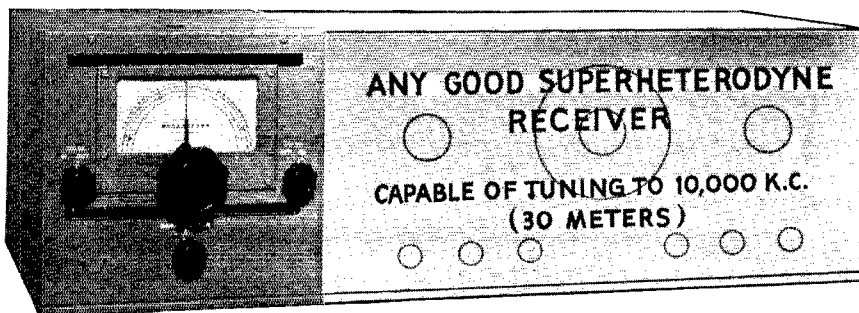

1. A two range band expander for 28 to 30 and 56 to 60 megacycle range.
2. A radio frequency gain at both 30 and 60 MC amounting to 18 decibels.
3. A signal to noise ratio of 10 db at 1 microvolt using a 30% modulated R.F. signal.
4. A self powered unit adaptable to any good superheterodyne receiver.
5. A change-over switch for antenna shifting built into the unit.

THE DM-36 by RME

HOW TO USE THE DM-36:

Set the tuning controls of your present receiver to 10,000 KC (30 meters). This setting should be made permanent after the receiver is at its operating temperature. The RF of your receiver is now acting as another IF tuned to 10 MC. The signal to image ratio is approximately 25,000 to 1.

Tuning in the ranges of 28 to 30 and 56 to 60 MC is done with the one Band Spread dial located on the DM-36. It is all very simple and easy.

And what a band spread for these two frequency ranges! Actually $6\frac{3}{4}$ inches of pointer travel with a remarkably accurate calibration.

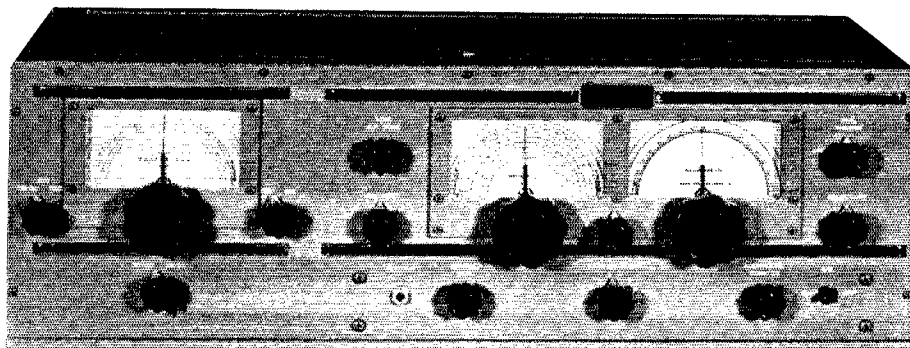

RADIO MFG. ENGINEERS, Inc., PEORIA, ILLINOIS
111 HARRISON STREET

A TELECAST FROM SYLVANIA

*Sylvania 1802-P1,
1802-P3, 1802-P4
cathode-ray pic-
ture tubes.*

Keeping abreast of the advance in television art, Sylvania now offers a choice of three screen colors in a high quality 5-inch picture tube. Type 1802-P1 has a green screen; type 1802-P3 a yellow screen; and type 1802-P4 a white screen. The 5-inch screen permits both a larger image and sharper definition, with no great increase in supply voltage.

Write to Hygrade Sylvania Corp., Emporium, Pa., for further technical data on these new tubes.

SYLVANIA

SET-TESTED RADIO TUBES

CORRESPONDENCE DEPT.

(Continued from page 65)

I am perfectly aware of my present technical ineligibility status. I was not a candidate in the last election. I have no intention of being a candidate again at any future election. I have no desire to serve again as Director of the Central Division or any other division. . . .

The changes which I proposed to suggest to the Board are not for my benefit but purely to avoid a recurrence of the thing which happened in several of the divisions at the last election. At that time a number of very good candidates were disqualified for technical reasons due to lapses of only a few days in their license renewals. The changes which I intend to advocate at the May Board meeting are for the future protection of these individuals and not for myself.

Apparently Mr. Young finds himself unable to comprehend the fact that there are individuals on the Board who are trying to act for the best interests of the League and for amateur radio. . . . Certainly his aspersions are most inconsistent in view of the fact that he is at present doing his best to influence the Board to pay the Directors a salary of a thousand dollars a year each! For the information of the members of the League in the Central Division, I intend to do my best to defeat any such project and will not accept any salary if it should be available.

— R. H. G. Mathews
Director, Central Division

ABOUT "INSIDE-OUT B.C.L.'S"

8 President Ave., Rutledge, Pa.

Editor, *QST*:

. . . I am sure that there are a number of men on the air who have no moral right to be there, but that is not the fault of anyone or anything except their own makeup. Some people are inclined to override all rules and regulations to gain their own selfish end. . . .

I feel that the manufacture and sale of well-engineered ham rigs is a good thing, be they transmitters or receivers. I don't think that factory built rigs hinder ham radio in its true spirit to any great degree. In fact, I believe they rather enhance the art. By that I mean a good many hams try to pattern their homemade rigs after factory-built jobs and some turn out some fine equipment. My own transmitter is homemade from the ground up and it is patterned after a well-known factory-built job.

Factory-built jobs never made a heel out of a man. If he is a born heel he will be one with a haywire 210 or a factory-built kilowatt.

A good many hams can't afford to buy their equipment so they will continue to build their own. And another thing: a good many of the old timers held in high esteem by the fraternity have installed factory-built rigs, so I don't think that just because a man uses a purchased rig he should be beyond the pale.

I have found that a great many men do not have the time or facilities to do their own work and therefore must resort to purchased rigs or hire some other ham to build the equipment for them.

Lastly, I think we should all read and digest F. E. Handy's article in the same issue and pay more attention to the things outlined therein rather than worrying about Joe Bush's factory-built Kw. A gentleman is born and cannot be made by legislation or homemade rigs.

— K. B. Crowell, W3AJ0

2 Chepstow Rd., Croydon, England

Editor, *QST*:

Re letter from Mr. G. S. Light, ex-VE3ABW, in February issue, never have I — in twelve years reading of *QST* — seen sentiments so well expressed and with which I so whole-heartedly agree.

His proposal that *QST* should ban advertisements of complete units is admirable but it does not go far enough. Make all contests open only to owners of amateur-made equipment; restrict the Century Club, the B.P.L. and all other "merit" lists to such amateurs. Then we should see who are the real enthusiasts for this great game of ours; those who have achieved their results by having the knowledge, skill, patience and determination to put something into it, as opposed to those who merely use only their wealth to buy success.

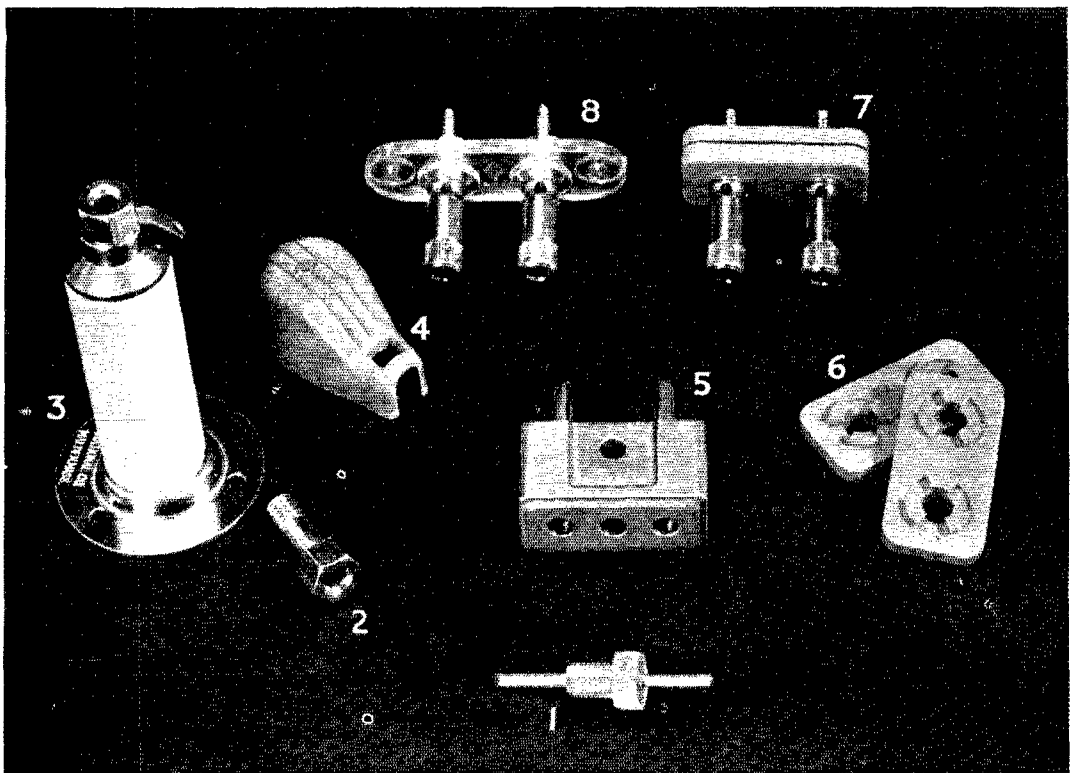

NEW SMALL PARTS

ONE The new Through Point Bushing, of injection-molded Victron, is ideal for a variety of uses, particularly as a bushing or as a standoff. It is supplied with a .093" conductor molded in, but this can be removed without damaging the material. Losses are very low. The price is only \$.45 Net per box of 12.

TWO The new National Jack, Type GSJ, screws into the top of GS-3, GS-4 and GS-4A Insulators as illustrated.

THREE It receives banana plugs of standard size, making it a convenient mount for plug-in coils, etc. Net Price, Type GSJ, Jack, \$.06 each.

FOUR The Type SPG Safety Plate Grip is of molded R-39 and is an important aid to safety when using 866's or other tubes having 9/16" diameter caps. The conductor opening is large enough to receive high tension (spark plug) cable, but an insulated bushing is supplied for smaller wire. Type SPG, Net Price \$.21 each.

FIVE This new insulated plug of molded R-39 mounts two banana plugs on 3/4" centers, and may be used with jacks or jack-top binding posts. Leads may be brought out through the top or through the side, and connections are made by

binding screws inclosed within the body of the plug. When used with Type FWE Jacks and Type FWC Insulators, all metal parts are safely guarded when plugged in. This assembly, complete with plug, two jacks and two insulators, is known as Type FWD (Net Price \$.96). Type FWF Plug only, Net Price \$.60 each.

SIX Type FWC Insulators are molded of R-39 and mount either FWA Binding Posts or FWE Jacks on 3/4" centers. Serrated bosses allow the thinnest panels to be gripped firmly, yet have ample shoulders. Maximum panel thickness with FWA Binding Posts is 1/4". Type FWC Insulators, without Jacks or Posts, \$.21 Net per pair. Type FWE Jacks for above, Net Price \$.09 each.

SEVEN The new FWA Binding Post accepts banana plugs at the top and wires through the hole. Its clamping action is unusually positive, for the husky screw top is shaped down to a small rounded end at the point where it clamps the wire. It is illustrated in assembly with FWC insulators. Type FWA, Net Price \$.15 each.

EIGHT A Victron terminal strip for high frequency use, originally designed for antenna connections on the One-Ten Receiver. Two Type FWA Binding Posts are used. Net Price, insulator only, Type FWB \$.06 Net.

NATIONAL COMPANY, INC., MALDEN, MASS.

TOPS in MULTI-TESTER VALUES



"PRECISION" Series 842L A.C.-D.C.-VOLT-OHM-DECIBEL-MILLIAMMETER-AMMETER Including an A.C.-D.C. 2500 Volt Range

- ★ Five A.C. and D.C. Voltage Ranges at 1000 ohms per volt: 0-10/50/250/1000 and 2500 volts.
- ★ Six D.C. Current Ranges: 0-1/10/50/250 MA and 0-1; 0-10 Amps.
- ★ Four Resistance Ranges: 0/400/100,000/1 Megohm and 10 Megohms.
- ★ Five Decibel Ranges from -10 to +63DB: 0DB+14DB; +28DB+40DB+48DB.
- ★ Five Output Ranges (Same as A.C. Ranges).
- ★ Large 4½ inch square meter.
- ★ Wire Wound Shunts and metallized multipliers, both of 1% accuracy.

Walnut finished hardwood case. Size 7 x 8 x 4. **\$21.95**
Net Price, less batteries and test leads.

"PRECISION" Series 870

**29 RANGES including
a 5000 VOLT A.C.-
D.C. RANGE**

- ★ D.C. VOLTAGE RANGES at 1000 ohms per volt: 0 to 6/30/300/600/1200 and 3000 V.
- ★ A.C. VOLTAGE RANGES at 500 ohms per volt: 0-12/60/600/1200 and 3000 volts.
- ★ D.C. CURRENT RANGES: 0-1-.2/12/120/600/1200 milliamperes.
- ★ RESISTANCE RANGES: 0-5000 ohms (20 ohms at center of scale) 0-500,000 ohms (powered by self contained 3 volt battery) 0-5 megohms (powered by external battery).
- ★ FIVE DECIBEL RANGES: -10 to +61DB.
- ★ OUTPUT METER INDICATIONS on Five A.C. voltage ranges.

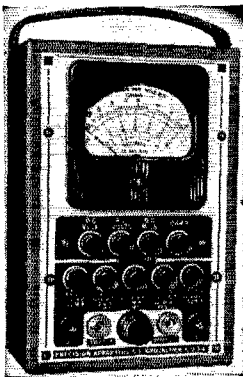

Large size 3 inch square meter. Compact walnut finished case. Size 7 x 4 x 3. Wire wound shunts and metallized multipliers, both 1%. Net Price, with 3 volt battery. **\$16.95**
SEE these two as well as any of 12 popular PRECISION Test Equipment models on display at all leading radio parts jobbers; or write direct for latest catalog.

**PRECISION
APPARATUS CO.**
821 EAST NEW YORK AVENUE
BROOKLYN, NEW YORK

Export Division: 458 Broadway, New York, N.Y., U.S.A. Cable Address: Morhanex

One plea often put forward by users of complete commercial units is that, "I haven't the time to make my own equipment." Yet these people find plenty of time to operate (more's the pity!) — let them divide their available time to making equipment and operating. (New and original idea to lessen QRM, patent applied for!) Just two examples. One British 'phone, user of commercial receiver, heard on 28 Mc.: "Only been on this band twelve weeks and have had over 400 W contacts so far — not too bad, what say OM?"; another, user of one of the most expensive commercial receivers and on 28-Mc. 'phone daily, heard saying, "Had 25 W contacts so far this afternoon, not bad for 'phone working, is it, OM?" I ask you!! (Ten million bored stiff sitting in front of ten million identical rigs. "Only 0,999,998 to go now!")

Is some one thinking "sour grapes"? Then read on. The ability to spend plenty of money on one's station must naturally contribute to success in amateur radio, and at the risk of being accused of "blowing my own trumpet," I frankly admit I have spent well over \$3000, but there is not and never has been a single complete commercial unit in my station, and I will back my results of fourteen years' continuous operation in contests, records, ultra-high-frequency research (and records), countries worked on both 'phone and c.w., etc., against those obtained by any user of complete commercial units in the amateur bands in any part of the world.

I await the tornado. (Tornado — a violent circulation of hot air.)

— Hilton L. O'Heffernan, G5BY

B.C.L. QRM MENACE

Clemson, S. C.

Editor, QST:

Interference on the broadcast band by 160- and 75-meter 'phones probably constitutes the greatest menace to amateur radio in the United States to-day. It is immaterial whether or not an amateur is actually interfering with the reception of a program. The mere fact that an amateur station can be heard on the band constitutes the menace. Time and time again broadcast listeners will complain about interference by amateurs on the broadcast band whether he is interfering or not. I venture to guess that at least 75 per cent of the complaints received by the F.C.C. regarding amateur interference is caused by either a 75- or 160-meter 'phone station. When the b.c.l.'s listen to the nonsense that is broadcast from some amateur 'phones, it is only natural that they should wonder why they could not have those frequencies for more broadcast stations.

In my opinion it is high time that we amateurs started to do something about this menace. The fact that the receiver is the cause of all the trouble and not the transmitters is no cause for lying down on the job. I have never yet seen an amateur admit that he was licked, and I don't believe that he will on this job. Amateur 'phones are gaining in numbers and I believe that the time for action has arrived. . . .

— J. E. Shipley, W4EPJ

WE DID NOT!

Capital University, Columbus, Ohio

Editor, QST:

While I am still smarting from my failure to raise XU1AW this morning I write this letter protesting a QST-sanctioned movement in favor of electron-coupled oscillators. I challenge the A.R.R.L.'s oft boasted claim of being the protecting God-father of amateur radio when that organization promotes a movement back to prehistoric conditions.

With due consideration of the benefits accruing to the selfish-minded amateur operator I hereby charge the movement toward electron coupled oscillators with the following crimes:

- (1) A piling of many stations on one frequency so that no one including the remote DX operator can enjoy a successful QSO because in their selfish anxiety the tyrannical DX hounds don't even let the RST report through before they start calling.
- (2) Needless and decidedly aggravating QRM as for each change of frequency the electron couplers test and sit on the key to squeeze out the last possible watt of power.
- (3) Increased danger of off-band frequency as the electron oscillators can easily slip outside the band.
- (4) Frequency instability and even unsportsmanlike notes.

“Put Your Signal Where You Want It When You Want It There!”

Mims News

3-Element Signal Squirters have:

- Increased power gain
- Lowered angle of radiation
- Sharper pattern
- Minimum rear signal on both transmission and reception
- Open wire non-resonant line
- Inductostub feed system
- Continuous rotation either direction
- Positive direction indicator — extra

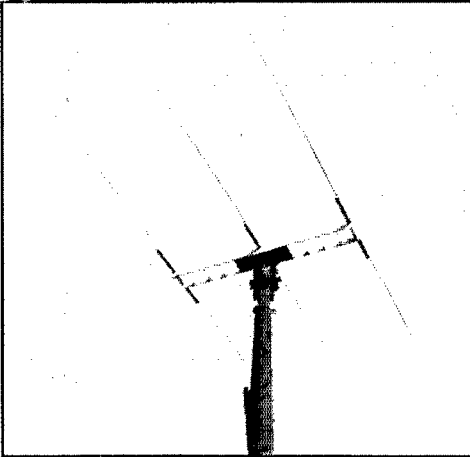

The De Luxe Rotator

The “Rolls-Royce” of Rotators. A unit so strong as to turn practically any form of array you might desire even far in the future. It’s in each of the de luxe array kits.

A few features — main shaft $2\frac{1}{8}$ ” diameter; ball bearings on both main shaft and worm gear; worm is precision ground, lapped and polished; much larger motors; delivered torque about five times that of the standard Rotator. Many more exclusive features.

KITS AND COMPONENTS

14MC De luxe 3 element kit	\$96.50
28MC De luxe 3 element kit	84.50
14MC De luxe 2 element kit	73.50
14MC Standard 2 element kit	59.50
28MC Standard 2 element kit	49.50
Standard Rotator	27.50
De luxe Rotator	59.00
4 $\frac{1}{4}$ wave 14MC elements	11.50
4 $\frac{1}{4}$ wave 28MC elements	5.75
Direction Indicator any band	24.50

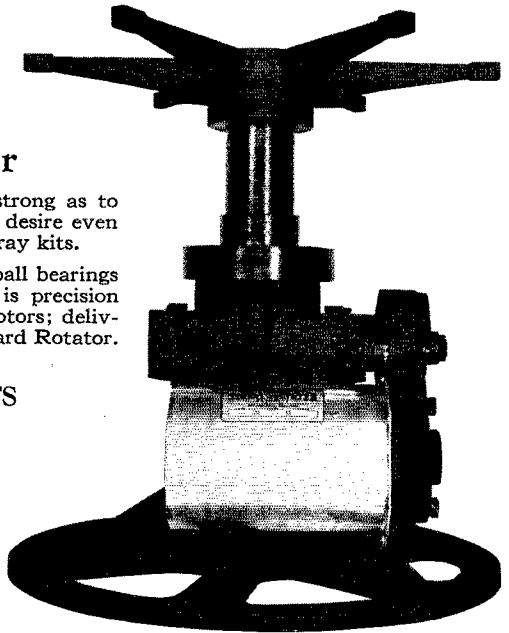

★ **WRITE RIGHT AWAY FOR FULL INFORMATION** ★

Yes — you can build a rotary beam yourself. The chances are you will do a good enough job to improve your signal rather noticeably.

Boiled down the story is this — the development of a single model of the Signal Squirters costs a very considerable sum of money. Even after the development is complete, we cannot produce one unit alone for fifty percent above the price we sell them to you.

More than that — when you decide to try something newly developed you will find a ready market for a used Signal Squirter. A Signal Squirter will cost you — when completed — far less than a compromise job — and you have one of the best there is. Hundreds of them on the air offer proof any minute of the day.

73, M. P. MIMS

MIMS RADIO CO.
SIGNAL SQUIRTER
PRODUCTS
TEXARKANA ARK. TEX.



TRANSMITTING TUBE SOCKETS

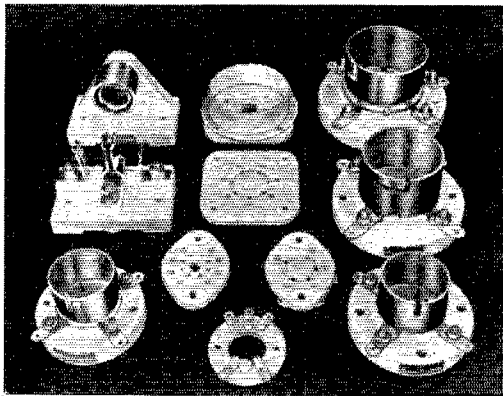

- ★ Johnson No. 211 "fifty watt" and No. 210 "UX" base have set a standard recognized throughout the world. Tens of thousands of them have gone into equipment designed for exacting users including the U. S. Government, large manufacturers and discriminating amateurs.
- ★ As each new development required special new sockets, E. F. Johnson kept pace with events and the line today includes any special transmitting type you may demand — and always of the same dependable high quality.
- ★ 4, 5, 6, 7 small, 7 large, octal and acorn wafer sockets are also available. Insulated with ultra-steatite, they are particularly well adapted for use where extremely low loss is imperative.
- ★ Many types offer choice of ultra-steatite or porcelain base. Also choice of phosphor bronze or beryllium copper contacts.

In spite of their recognized high quality, these sockets are no higher priced than ordinary sockets.

At your jobber's or write for Catalog 965J



E. F. JOHNSON CO.

WASECA, MINNESOTA

EXPORT: 33 WARREN ST., NEW YORK, N. Y.

MANUFACTURERS OF RADIO TRANSMITTING EQUIPMENT

On the basis of these charges I beg the A.R.R.L. to reconsider the encouragement of electron-coupled oscillators and to again exhort to crystal control to eliminate QRM and to provide for unselfish amateur activity.

— Armin H. Meyer, W8QXM

THE LIMIT

1310 Minnesota Ave., Chickasha, Okla.

Editor, QST:

. . . I don't mind the names the b.c.l.'s call us. I can stand that, but when the YL b.c.l.'s start mocking our FB hobby by wearing hats with feathers that look like a 75-meter vertical antenna without guy wires, it's the limit! . . .

— Bill Humphreys

WELL!

New Castle, Pa.

Editor, QST:

For a long time I have held my peace, but at last I feel that I can hold my peace no longer.

To-day — as most other days at the same time — I went on the twenty-meter 'phone band to work a little DX. As usual I tried to hold onto my temper and be calm, but this was too much. Every time I even heard the remotest DX signal, it was smashed by the same old c.w. QRM.

This little instance was cited just as basis of what I have to say.

Several times in the past I have received a subscription offer from you and this will give you a good reason for my constant refusal. You, as the self-acclaimed head of all the hams of America, have made very grossly lying claims as to the good that you were doing for hams of this and other countries. What I want to know is, what have you done?

In the past you have done nothing but hinder the hams in this country by the legislation that you have proposed. The twenty-meter band is not the only band in the spectrum that is a wreck by your surrendering our traditional rights to the commercial interests at the expense of the amateur. You have continually proposed only those measures which you claim will be of benefit but which will do nothing but hinder the pursuance of the art by those in America who want to become one of the great and respected body of those now in the game.

So much for your claims and "important" measures.

Another thing. Why is it that only those old conservatives are appointed to the post of any importance in the League? It seems that the spirit of progress is not in their blood. This is America and it is our rights that it is our sworn duty to protect. It is our rights that is being put in jeopardy by the money-grabbing tendencies of the so-called honest trustees in subservience to the large commercial interests. It is our rights that you say you are protecting both here and abroad. Are you? No, you are not. You are hindering us at every turn and cutting our throats when our backs are turned. Why was the twenty-meter band not divided into two equal parts instead of being left the mess it is? Why were the lids not given a chance on 5 meters with low power, instead of the strict regulations as are imposed now? Why were all our interests sacrificed at Cairo? Why is not more pressure put on the government, which is after all only the servant of the people? Surely with all the money poured into the League coffers by the hams of America, it is possible to at least stand on an equal footing with those other interests?

This is the big reason why I wish you would not bother me with any more subscription or membership offers as I am not interested. Whenever A.R.R.L. really does something for the hams let me know and I'll give every dollar I own in its support. If you can, publish this and see what the other boys think of my views on the subject.

— T. T. (The Beer Baron) Frazier, W8QEP

OLDEST HAM?

313 N. Main St., Hannibal, Mo.

Editor, QST:

I am 78 years old and have been an active operator for 21 years, am on 75-meter 'phone at present. I am claiming to be the oldest active operator in the United States and possibly the oldest in any country. Please publish my claim in your news department to see if there is anyone older in the ham game.

— Lawrence J. Ryan, W9CNS

EVERYTHING YOU NEED OR WANT
in a communications receiver!

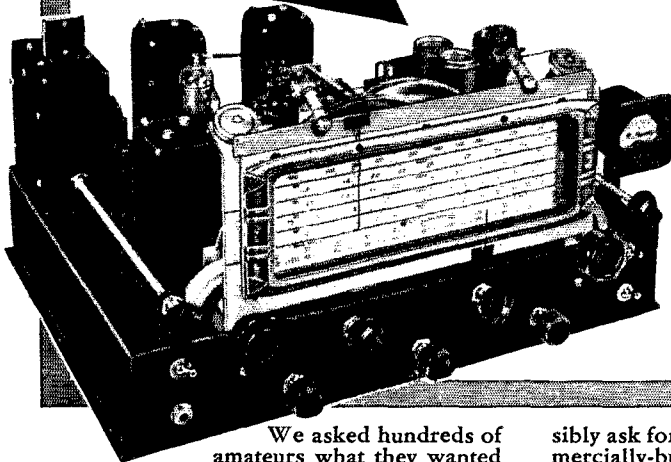

14-TUBE
TRAFFIC
MASTER

\$81⁹⁰ Everything except tubes and speaker

The TRAFFIC MASTER comes to you in COMPLETE KIT FORM—everything as illustrated except the tubes.

We asked hundreds of amateurs what they wanted in a communications receiver and then we designed the TRAFFIC MASTER to their specifications. Just look down the list of features, you'll find everything included you could pos-

sibly ask for—as complete a job as any “commercially-built” you’ve ever seen or operated. Ask your Parts Jobber about the TRAFFIC MASTER—or write Dept. Q-5, Mt. Carmel, Ill. for full information about this and 21 other Meissner Kits.

• 14 Octal-Base Tubes • 530 KC to 32.4 MC (9.25 to 565 Meters) • Better than 1 M.V. Sensitivity on all “Ham” Bands • 5-Band Pre-Aligned Tuning Unit • Electrical Band-Spread Condenser • Band Setting and Band Spreading Controls • Amateur Bands Located at Optimum Points on Various Ranges • Large Full-Vision Dial, with 9” Linear Scales • Separate Pointer on 0-100 Scale for Electrical Band-Spread • Flywheel Tuning on Both Main and Band-Spread Control • 3-Gang Precision Tuning Condenser—Ceramic Insulated • “Align-Aire” (Air-Tuned) Coils • Fully Shielded Switch Assembly • Mono-Unit Crystal-Filter Assembly with Phasing Control and Shorting

Switch for Panel Operation • Noise Silencer Circuit Built In • Beat Frequency Oscillator with Panel Pitch-Control for CW Sigs—Air-Tuned • “R” Indication Meter; Carrier Level Indicator Calibrated 1 to 9 for Signal-Strength Reports • Two Stages Ferracari (Iron Core) I. F. Amplification • “Align-Aire” (Air Tuned) I. F. Transformers • Full Automatic Volume Control, Maintains Constant Volume Level Under Severe Fading Conditions • Doublet Antenna Connections • Diode Second Detector • Manual Volume Control • Tone Control • Headphone Jack • Standby Switch • 6C8G Phase Inverter, Resistance-Coupled to Output Stage • Push-Pull 6V6 Output Class A • 8.5 Watts Undistorted Power Output.

NEW! 120 PAGE INSTRUCTION BOOK!

Easy to understand theory and technical data, graphs, charts, pictorial and schematic diagrams, alignment data, construction data and operating instructions for 21 new Meissner receiver kits. Also information on adapters and converters. At your Parts Jobber—or order direct, addressing Dept. Q-5. Price 50c.

Meissner

MT. CARMEL, ILLINOIS

“A FAMOUS NAME FOR TWO DECADES”

BUILD YOUR OWN FACSIMILE RADIO PRINTER

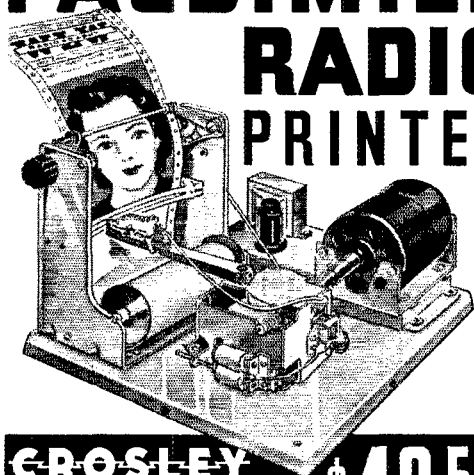

**CROSLY
READO KIT \$49.50**

GET IN ON THE
GROUND FLOOR
WITH RADIO'S
MOST PROMISING
DEVELOPMENT

Already daily broadcasting experiments from leading radio stations offer fascinating study and fun. This new art holds promise of a great future, and another chance to grow up in a field as prolific of personal profit and satisfaction as radio was 20 years ago. Time is not far distant when radio facsimile printers may constantly deliver into American homes an exciting stream of pictures of events as they happen together with visual reports, vital information and news. Already the progress provides much

BUILD AND AT-
TACH TO YOUR
OWN RECEIVER

of interest and for study in the early morning broadcasts of news and pictures with many stations operating on ultra high frequency during daylight hours. The Crosley "Reado" radio printer is a development of the Finch method and is being used in many spots throughout the country today. When you have built the printer it is easily attached to your own radio receiver.

We provide all the necessary parts carefully precision machined ready to build, packed in a special kit. Most Crosley dealers will display them. If none are convenient to you, write us.

THE CROSLY CORPORATION

READO DEPARTMENT POWEL CROSLY, Jr., Pres.
102 ARLINGTON STREET CINCINNATI, OHIO

Please send me literature about the Crosley READO, all facsimile broadcasting activities and list of stations now doing experimental broadcasting. Also, the name of my nearest Crosley dealer to carry the Reado Kit.

**USE
THIS
COUPON**

NAME.....

ADDRESS.....

Input Resistance of R. F. Receiving Tubes

(Continued from page 43)

All the curves are plotted for tubes operating at normal conditions which give maximum gain; that is, at normal plate and screen voltages and minimum recommended grid bias. If the negative grid bias is increased (for gain control, for example) the hot conductance also decreases at practically the same rate as the reduction in gain. The loading on the tuned circuit, therefore, decreases as the grid bias is increased, and the selectivity tends to become greater. The actual effect will depend upon the degree of coupling to the driver circuit since, assuming the coupling to be optimum under minimum grid-bias conditions, the circuits will be over-coupled if the loading is decreased. It is not ordinarily advisable to overbias the first tube in the receiver, however, since this has an adverse effect on the signal-noise ratio even though there may be some improvement in the front-end selectivity. Incidentally, the gain control tends to become less effective at the higher frequencies, since the voltage developed in the tuned circuit increases when the negative bias is increased; at low frequencies, where the loading effect is negligible, this does not occur to an appreciable extent.

In an actual receiver, the total image ratio is the product of the image ratios of the several individual circuits; a receiver having one r.f. stage, for instance has two tuned circuits, one each in the preslector and mixer stages. From the figures previously given, it is fairly easy to pick out tube combinations which should give the best and worst signal-image ratios. The best combination should be a 954 r.f. tube and 6K8 mixer, although it might be necessary to take some precautions to prevent the latter tube from oscillating. The worst combination would be an 1851 or 1852 r.f. tube and 6L7 mixer; at 28 Mc. such a combination would show hardly any audible discrimination against images, using a 455-kc. i.f. It should be borne in mind, however, that these statements apply only to circuit gain and image response; tube gain and signal-noise ratio are something else again, and the latter in particular is not a part of the present story. Nor have we considered the improvement in selectivity and gain which can be secured by the judicious use of regeneration. The final answer to the ideal receiver front end, if there is a final answer, can only be reached after a great many factors have been given due consideration; input loading, although exceedingly important, is only one of several.

"Safety" Becomes Watchword

(Continued from page 48)

sterile water be used when preparing wet dressings for burns. I believe that cotton, waste, vaseline, olive oil, castor oil, machine oil have no place in first aid for burns. Exception: first-degree burns, in which case the oils may be used

Two ceramic insulators

ALIKE IN APPEARANCE

...but in performance
there's a vast difference



You can't judge the quality of an insulator by its appearance. The older type ceramics are not capable of withstanding Ultra high frequencies such as found in R.F. circuits yet they look exactly like the newer types which are necessary for this purpose

When Eimac tubes first appeared on the market, their unusual design features were rather unique. The odd shaped, crystal-clear bulb, cylindrical elements, new non-sag filament support, wide spacing of grid and plate leads—all were "ear-marks" of the Eimac tube. But there were other features (not visible) which became apparent only when the tubes were put into service. Low inter-electrode capacities, increased electrical efficiency, complete freedom from tube failures caused by gas released internally and ability to withstand momentary overloads as much as 400% to 600% without damage—these are the hidden capabilities which are responsible for Eimac's vastly superior performance.

Eimac tubes are no longer unique in appearance because the purely physical details have been adopted by others (a fitting testimonial of superiority) but they are *still* unique in their most important feature—namely; **OUTSTANDING PERFORMANCE.**

Install Eimac tubes in your transmitter and step into rank with the world's leading radio engineers. See your dealer or write for complete data.

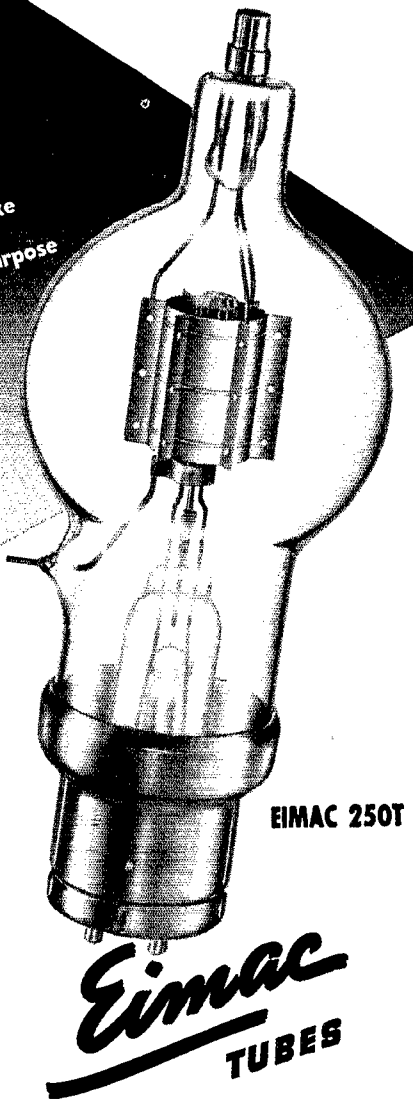

EIMAC 250T

Eimac
TUBES

EITEL-McCULLOUGH, INC.
SAN BRUNO, CALIFORNIA

Sheldon



35T

Now you can have Sheldon Quality in an improved 35T

EXCLUSIVE FEATURES

- Larger Plate Area
- More Rugged Construction
- Improved Type Filament Suspension
- Runs Cooler

The Sheldon 35T, is capable of producing enormous power. Because of its low inter-electrode capacities and excellent electrical characteristics, it is one of the most adaptable tubes available. The use of completely degassed TANTALUM plates and grids, sufficient insulation between elements and the absence of internal insulators and "getter" provide a wide safety margin as is the case in all Sheldon Tubes.

If you want perfect reports on your quality, if you want exceptionally long filament life plus complete freedom from failures caused by gas, if you want a transmitter that will "stay put" year after year, you most certainly want the SHELDON 35T. Consult your dealer or write direct.

Sheldon 35T	-	\$6.00	Net Price
Sheldon KY866	-	3.50	" "
Sheldon 866	-	1.50	" "
Sheldon 866A	-	2.50	" "

SHELDON ELECTRIC CO.

76-82 COIT STREET, IRVINGTON, N. J.
626 W. Jackson Blvd., Chicago, Ill.

Exporter: Technical Products International
135 Liberty St., N.Y.C., U.S.A. Cable Address: Tepei

without danger because the skin is not broken and they are easily removed. Your instruction not to wet the dry, charred burn I believe is wrong. Third-degree burns certainly should be treated with wet dressings and kept moist until the doctor arrives. . . . The objects of first aid for burns are to relieve pain, prevent infection and treat shock. . . . Use no iodine. . . ."

John H. Farrar, G2AYA, points out: ". . . Application of picric acid solution to large raw surfaces may result in poisoning through absorption, therefore in these circumstances it is advisable to avoid its use. A far superior treatment for all burns is the use of a 2½% solution of tannic acid, which is now the method generally adopted. The use of oily substances is to be deprecated, since the risk of bacterial infection is by no means small and may result in a dangerous septic condition. Usually, in the excitement of an accident, none of the usual remedies is available, and it is therefore wise to remember that a strong infusion of ordinary tea is a good substitute for tannic acid. This must, of course, be applied cold. You omitted to mention that the dressing is continued until the burnt surface has ceased to be moist and red and has become dry and brown. After this the burn can be left exposed to the air. . . ."

R. D. Huestis, VE2BU, quotes the reference to protecting the wound and states: "Such covering of the burn with a grease or oil will undoubtedly give immediate relief and is what used to be taught for first aid. However, if the burn is at all serious it is the last thing in the world that should be done. . . . The best treatment for burns is tannic acid, and tannic acid will not stay on any greasy surface. Even the ordinary grease of the skin sheds tannic acid like water off a duck's back. Any oil or grease, then, must be thoroughly scoured off with alcohol or ether before the tannic acid can be applied, and such scouring is a terribly painful process. . . . As an immediate remedy, until the tannic acid can be applied, the baking soda solution is always available and will not interfere with the later application of tannic acid. For minor burns a tannic acid jelly preparation called Tanjel is on the market put up in tubes like dental paste. . . . Tannic acid treatment for burns is only a recent development on this continent, I believe, brought out by the Ford laboratories in Detroit; although I understand the Chinese have used it for centuries. . . ."

Returning to the general rules, W6PGH also informs us that "circulation may be increased to a certain extent by brisk rubbing of the limbs with a Turkish towel, in which case rubbing should be toward the heart. This is often preferable to the use of blankets while respiration is being applied, but it of course cannot be done by the person applying resuscitation. In addition, when the victim is breathing but has not yet regained consciousness, aromatic spirits of ammonia may be held under the victim's nose at frequent intervals. One may clean the patient's mouth, stimulating reflexes by moving the tongue back and forth. . . ." *Keeping the victim warm is of the greatest importance.*

FIRST WITH ROUND XMITTING TYPES
FIRST WITH SPRACOL—the "SAFETY" OIL

Now **FIRST** with

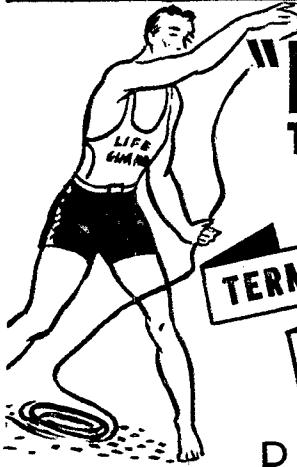

"LIFEGUARD" TERMINAL PROTECTION!

TERMINALS FULLY INSULATED

NO CHANCE FOR ACCIDENTAL CONTACT

PLAY SAFE on high voltages the practical way! Insist on Spragues . . . the only Transmitting Condensers equipped with the new "Lifeguard" Terminal Insulation Caps.

FREE! Lifeguard Protective Caps are now supplied at no extra cost with every Sprague Xmitting Condenser — or, you can buy them for your old condensers at 25c list for a pair. . . . In addition to this exclusive new feature, terminals are insulated from cans for at least twice the working voltage; condensers are placed in complete metal cans which can be automatically grounded through the mounting clamps; and all condensers are oil impregnated—oil filled with SPRACOL, the famous Sprague 500 degree F. flash protection oil (not oil impregnated and wax filled)! Oil Filled Condensers are essential for high voltage condensers.

REAL SAFETY PLUS REAL DEPENDABILITY

Sprague Xmitting Condensers are **UNCONDITIONALLY GUARANTEED** when used as specified. Typical are these Type OT (round) net prices: 2 mfd. 1,000 V. net \$1.65 — 2 mfd. 2,000 V. \$2.55 — 1 mfd. 3,000 V. \$4.50. Typical Type CR (rectangular) prices are: 2 mfd. 1,000 V. net \$2.40 — 2 mfd. 2,000 V. \$3.30 — 1 mfd. 3,000 V. \$7.20. Made in full lines of both round and rectangular types, also inverted screw can round condensers for Transmitters, High Gain Amplifiers, Television, etc. Write for catalog of Sprague Condensers for every need.

Use Spragues . . . and Note the Difference!

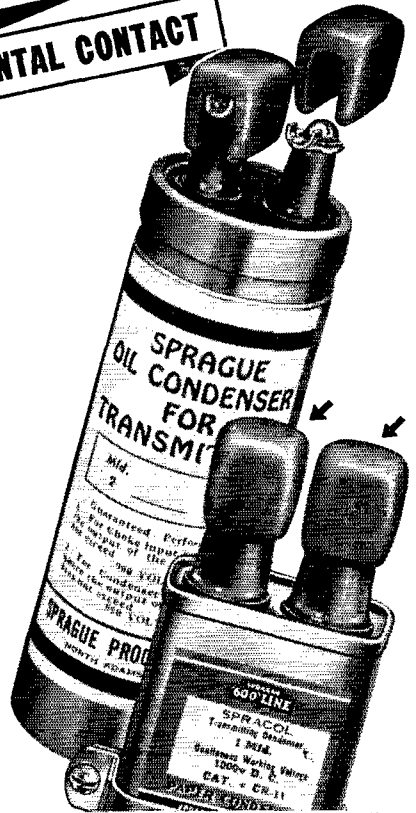

And Don't Forget . . .

THE SALES RECORD
 BREAKER OF ALL
 TIME . . .
 FAMOUS TC
 TUBULARS

"Not a Failure in a Million" is the slogan behind these famous tubulars—and it means what it says.



SPRAGUE TRANSMITTING CONDENSERS

SPRAGUE PRODUCTS CO., NORTH ADAMS, MASS.

it's Cardwell again!

in FRANK LESTER'S 5-10 Meter Converter Kit

When W-2AMJ developed this new H.F. Converter (as described in April *QST*), he chose highest quality parts.

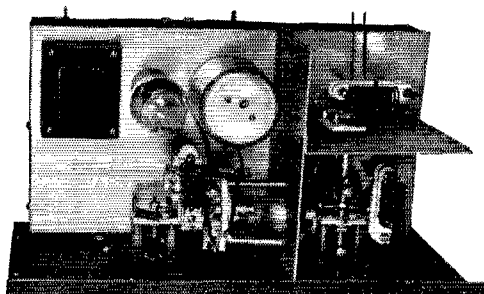

CARDWELL Trim-Air Condensers

were selected for the heart of the CONVERTER, because of their high maximum to minimum capacity, plus their essential superior electrical and mechanical performance at high frequencies.

CARDWELL is happy to be represented in this timely converter — just as happy as we are to know that practically every transmitter kit manufacturer, every commercial designer of radio transmitters and receivers, makes use of Cardwell Quality Components in their apparatus, in equipment which must measure up to highest standards of performance.

A perusal of past and current issues of the best Amateur Magazines and Handbooks will definitely indicate that CARDWELLS ARE FIRST CHOICE OF DISCRIMINATING AMATEURS AND PROFESSIONAL ENGINEERS.

AT YOUR DEALER NOW . . .

SEE the new U.H.F. dual, 50 mmf. per section, .070" gap, buffed plates; in same frame as NP-35-ND.

Type NT-50-GD

List Price.....\$6.00 Amateur Net.....\$3.60

IF YOU DON'T HAVE THE LATEST CARDWELL LITERATURE including data on the new 1 K.W., 500 watt and 250 watt MULTI-BAND CONDENSERS, send for our latest bulletin or see your nearest jobber.

**THE ALLEN D. CARDWELL
MANUFACTURING CORPORATION**
83 PROSPECT STREET, BROOKLYN, NEW YORK

There is a great deal more that might be printed about this subject. Most of it is without doubt better said by instructors and demonstrators addressing amateur groups. Our purpose at the outset was to present a simple and assimilable set of rules that would serve as guideposts to proper procedure in the event of electrical accident. That this purpose has been fulfilled seems evident from the practical results thus far achieved.

How to Lay Out Metal Chassis

(Continued from page 54)

necessary, by using two or three drills of increasing size and then reamed out with a reamer in a carpenter's brace. Very large holes, such as those required for sub-mounting sockets may be made with a circle-cutter clamped in a bit brace or by a socket-hole punch after the center hole has been drilled with the hand drill. A relatively new type of socket-hole cutter, known as the Greenlee punch, is now available. The hole is forced through the chassis by means of screw action with a wrench. It is noiseless and much easier to use than most other types. Large square holes are usually cut out with a hack-saw after drilling half-inch holes inside each corner for starting and turning (see Fig. 1), although a square or rectangular hammer punch is available by means of which square or rectangular holes may be knocked out in sections. If the socket mounting holes have not been spotted previously, the sockets may now be inserted and the mounting holes marked and drilled.

If volume controls or small variable condensers are to be mounted behind the front edge of the chassis, parts located on the chassis near the front edge should be fastened temporarily in place while positions for these controls or condensers are selected to avoid interference with parts projecting from the top. The shaft holes must be marked by measurement. Mounting holes for terminals in the rear or side may be marked at the same time. The parts on top should be removed before drilling. A small drill should be used for the first drilling of shaft and mounting holes which are to protrude through the panel. Before enlarging them to correct size, the panel should be marked for these holes by once more fastening it to the chassis and spotting the centers on the back of the panel by marking through from the inside of the chassis. The small holes will make accuracy easier. If panel brackets are used, the panel holes may be marked in a similar manner. Before again removing the panel, a sharp line should be drawn across the back of the panel along the top edge of the panel. This line is to be used as a guide in determining the correct height for shaft holes.

When all holes have been drilled in chassis and panel, the condensers or other parts with shafts extending through the panel may be mounted permanently; other parts should not be mounted until the height of each shaft above the surface of the chassis has been measured with the square.

WORLD WIDE



Taylor Tubes

SALES LEADERSHIP



T-21

A Taylor beam Amplifier Tube with six prong Alsimag Base 21 watt plate dissipation. Thousands in use within five months. A better tube for Auxiliary-Portable-Mobile "Rigs." **\$1.95**

In every country of the world the name Taylor Tubes has become the standard of value. Through daily use, thousands of Radio Amateurs and Engineers give ringing acclaim to the high performance of Taylor Tubes. It takes real Watt per Dollar value to earn the unquestioned loyalty of radio men everywhere. Over the counters of leading parts distributors everywhere the slogan of better tube value has become "MORE WATTS PER DOLLAR with TAYLOR TUBES." Join the army of Taylor boosters today and get a new thrill out of radio tube performance.



866

Real rectifier tube value sensation—new shielded Taylor 866. An 866A at the old 866 price. 10,000 peak inverse voltage rating. New safety plate-cap insulator **\$1.50** at _____

Half wave mercury vapor rectifier. Fills a real need for immediate power requirements. A pair will handle up to 1250 DC volts at 250 M.A., Alsimag base. Filament 2.5 Volts at 2.5 Amps. **\$1.50**

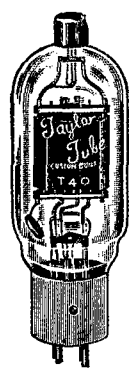

T-40
TZ-40

The most popular transmitting tube types ever introduced. T-40's mu is 25—TZ-40's mu is 62. 115 watt input. Less than five watts drive required in any service. Radio's new wonder tubes... **\$3.50**

The most popular tube in its class. Many improvements have been made on it. Ask to see one at your distributor. Over 10,000 in use today. Easier to drive—Easier to neutralize. 55 watts plate dissipation **\$6.00**

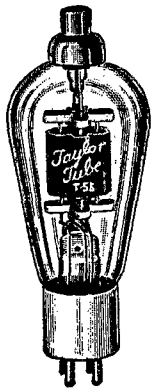

T-55

COMING NEXT MONTH . . . Watch for next month Taylor Tubes advertisement announcing the first of a new series of tubes; featuring a new "puncture-proof" U.H.F. design. Ask your distributor . . . see the announcement describing new Taylor TW (Thin Wall Carbon Anode) series in the June issue of this magazine.

"More Watts Per Dollar"

TAYLOR TUBES, INC., 2341 WABANSIA AVE., CHICAGO, ILLINOIS

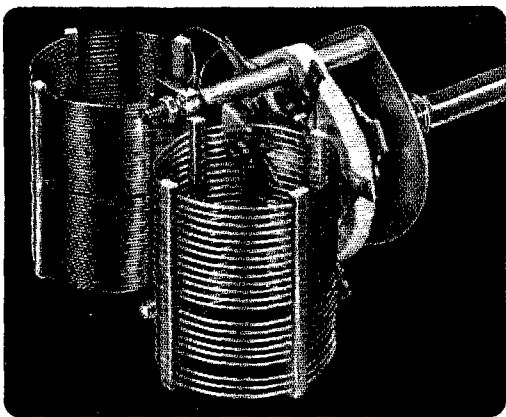

NOW! 5-BAND SWITCHING ... from Front of Panel!

The new B & W Type 2-A Band Switch is a revolutionary development in low-powered band changing, providing positive frequency selection of all five bands from the front of panel!

While the basic principle of the 5-Band Switch is simple, it remained for B & W to perfect a low priced band-switching unit combining the advantages of accurate individual coils with the convenience and speed of front-of-panel control.

P.S. . . . To the ham who suggests the best descriptive name for the new 5-Band Switch, B & W will present a set of THREE of these units, absolutely free! Nothing to buy, submit as many entries as you wish! Contest closes June 30, 1939. (All entries become property of B & W; none will be returned; all will be carefully judged by B & W's Advertising Dept., whose decision will be final.)

The Type 2-A Switch is ideal for use in low-powered capacity coupled transmitter stages, using popular tubes such as the 6L6, 802, 807, RK39, T21, etc. It is a marvel of compactness, requires space only 2 1/2" x 3" x 2" behind your panel! Its Amateur Net Price is only \$3.25. See them at your jobber's!

Ganged assemblies for single control switching of two or more stages are also available on special order. Write for quotations.

BARKER & WILLIAMSON
Radio Manufacturing Engineers • ARDMORE, PENNSYLVANIA

LEARN TO SEND AND RECEIVE **CODE**

Learn to send and receive code signals, like operators on ships at sea and at commercial and amateur land stations. Intercept distress signals, news flashes, bulletins, and dozens of other kinds of interesting radio communications.

MASTER TELEPLEX teaches you to receive code exactly the way the world's best operators do — by sound. A heavy waxed paper tape, running through a machine, operates an automatic key which sends messages to you, at any speed you desire. As you improve in speed, the machine sends faster, gradually preparing you for top-speed amateur and commercial signals. With the new All Electric MASTER TELEPLEX you learn to send by sending and the signals you send are repeated back to you, exactly as you sent them, thus enabling you to correct your own errors. We furnish a complete course, lend you the improved All Electric MASTER TELEPLEX and give you personal instruction with a MONEY BACK GUARANTEE. Send for new TELEPLEX FOLDER Q-5 today. IT'S FREE.

"HAM" SPECIAL
Standard Teleplex — a highly efficient code teacher using heavy specially prepared waxed paper tape, having two rows of perforations. Write for Free folder "Q.T.5"

TELEPLEX CO., 67-68 Park Place, N. Y.

In Canada, Write
Canadian Electronic Institute, Toronto, Ontario



This can usually be done readily with the square, setting the end edge of the rule flush with the head and standing the square on its face on the surface of the chassis (see Fig. 2). The various heights should be recorded and transferred to the back of the panel which has already been marked with vertical lines to indicate the horizontal displacements of the various shafts. It should be remembered that these heights must be measured above the line which has been drawn on the back of the panel indicating the level of the top of the chassis.

The remainder of the parts may now be mounted and the panel drilled for the shafts. If condensers are mounted sufficiently close to the panel so that no extension is required, a tight-fitting panel hole will not be necessary; the panel hole may be made large enough to compensate for any inaccuracies in spotting. When the condenser shafts must be extended, somewhat greater accuracy is required since the shaft extension must be provided with a fairly accurately fitting bearing in the panel. Metal panel bearings are available for this purpose and, if they are used, the hole may be made large enough to provide some leeway in lining the bearing up with the shaft. Any meter holes or holes for parts mounted on the panel above the level of the chassis may be spotted by measurement and cut before assembling the chassis and panel. Most dials are supplied with drilling templates which may be used in spotting mounting holes when these are used.

There is little which can be said about wiring. Most transmitter units and receivers are designed to keep most of the wiring below the chassis. The low-potential or power-supply wiring should be put in first, keeping it close to the chassis. The r.f. wiring should be done preferably with stiff wire well spaced from the chassis.

Silent Keys

It is with deep regret that we record the passing of these amateurs:

Dr. W. E. Chapman, W9CYB, Leland, Ill.
Edward F. Hallock, W2UB, Brooklyn, N. Y.

William Robbins Siegle, ex-2BQH, formerly of Marmaroneck, N. Y.

Charles B. Snyder, W9ASP, Fargo, N. D.
John C. Stadler, VE2AP, Westmount, Montreal, Que.

Capt. J. Hervé St. Martin, VE2NI, St. Felicien, Que.

Vernon W. Unroe, W8PGT, Mt. Vernon, Ohio

Walt J. Colpus, Jr., W8BRS
Secretary-Treasurer and a Co-Founder of the Chair Warmers Club, notable and ardent worker in promoting the advantage of amateur radio amongst the physically-handicapped.

"The RADIO SHACK



NEW!

Skyrider 23

THE NEW HALLICRAFTER SKYRIDER 23

Features Drift Compensation and Wide-Range Selectivity

- Complete coverage 34 to .54 MC (.8-556 meters)
- Band Spread positions for 10, 20, 40 and 80 meter bands
- Noise limiter
- S-Meter
- 8 Position band switch
- 11 Tubes
- Permeability-tuned crystal filter circuit

AMATEUR CASH PRICES

Skyrider 23 with crystal, less speaker	\$115.50
Skyrider 23 with crystal and speaker	127.50

EASY TIME PAYMENT PLAN

<i>Model</i>	<i>Down Payment</i>	<i>Per Mo. for 6 Mos.</i>	<i>Per Mo. for 12 Mos.</i>
S 23 with crystal, less speaker	\$23.00	\$16.25	\$8.28
S 23 with crystal, and speaker	25.40	17.95	9.15

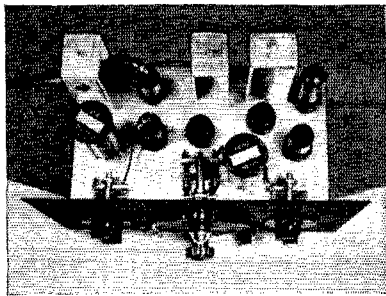

KIT OF PARTS FOR THE QST REGENERATIVE SINGLE-SIGNAL SUPER

This single-signal super, designed by George Grammer, was described in the October 1938 issue of QST. By popular request, we are supplying the complete kit with all parts as specified, (Hammarlund, National, Sickles, IRC resistors, Cornell-Dubilier condensers). Included are all the miscellaneous parts, punched chassis, and a crackle finished panel, 8-coil forms, and wire to wind them,

diagrams and instructions. Nothing else to buy except tubes and power supply.

Complete kit less tubes and power supply.

NET PRICE

Kit of 6 Raytheon tubes for above kit. **4.49**

Crackle finished, hinged top cabinet, supplied at \$1.95 extra.

A reprint of this article by permission of QST will be supplied on request.

Special Value!



X-Cut 40-Meter
UNMOUNTED
CRYSTALS

7000 KC to 7300 KC

We reserve the right to supply within 10 KC of your desired frequency, but due to our large stock, we can usually supply them within a few KC.

Special Low Price... **\$1.35**

Heavy Duty Transmitting RF Choke

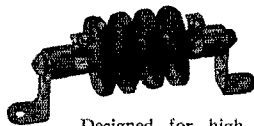

Designed for high efficiency from 28 mc. to 1700 KC. Wound on a ceramic form and equipped with mounting brackets which may be removed for end mounting. DC resistance, 6 ohms, current rating is 500 ma.

Special Net Price..... **49¢**

Browning 100-1000 KC Oscillator Standard

An adjustable oscillator standard to be used in circuits described in June '38, January '39, April '39 QST, and the '39 A.R.R.L. Handbook. Designed to be used with a 6SK7 oscillator tube. Provides a means for zero beating a 100 and 1000 KC oscillator with WWV.



Amateur
Net Price

\$3.45

MAIL
ORDERS
PROMPTLY FILLED

Write for **FREE**
72-page Catalog

**BUY ON
EASY TERMS**

46 BRATTLE ST. - BOSTON, MASS. - U.S.A.

Now...
**AUTOMATIC
 VOLTAGE
 REGULATION**
 ... too!

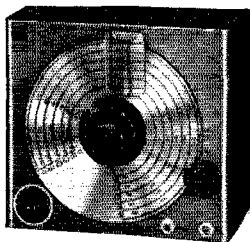

MANY hundreds of the new GUTHMAN U10 Frequency Meter-Monitors are today enabling their owners to comply with the law requiring regular transmitter frequency measurement, and to "pre-spot" new QSO's so they can be tuned in again during receiver warm-up periods without customary annoying fishing. To mention but two cases out of many, WCFL's W9FI uses a U10 to check its ultra high frequency transmitter, while W6USA at the Golden Gate Exposition uses a U10 to check frequency of its five transmitters.

But now the U10 is further improved by inclusion of socket for a VR90 automatic voltage regulator tube, which does a nice job of compensating for voltage changes when transmitter is keyed or modulated and both are on the same (usually heavily loaded) power line. This automatic voltage regulation provision is now included at no extra charge, and full data on how to incorporate it into U10's now in use can be had for a postcard giving serial number. (Address Dep't Q5). The same postcard will also bring free six individual large size calibration curves for all amateur bands from 5 thru 160 meters.

And thanks a lot for the FB response on the new GUTHMAN U17 Communication Receiver Kit... we've been flooded with inquiries and are glad to advise that U17's are now on display at all GUTHMAN jobbers.

EDWIN I. *Guthman* & CO., INC.
 400 S. PEORIA ST. CHICAGO, U. S. A.
 CABLE ADDRESS: GUTHCO-CHICAGO

RADIO

ENGINEERING, broadcasting, aviation and radio telegraphy and telephony, police radio, servicing, marine accounting taught thoroughly, Morse telegraphy and railway equivalent to three years of college radio work. School established 1874. All expenses low. Catalog free.
 DODGE'S INSTITUTE, Day Street, Valparaiso, Indiana

BUILD A LOW COST MONITOR

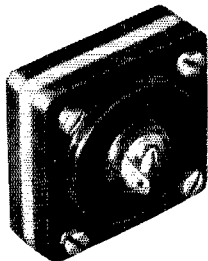

A dual-frequency crystal calibrator and your receiver makes an accurate inexpensive frequency monitor. January QST or Bulletin E-7 (free) gives constructional details.

**BLILEY
 SMC 100
 DUAL FREQUENCY CRYSTAL**

Naval Communication Reserve Notes

(Continued from page 52)

mander representing the Admiral and his organization and the Unit Commander the Captain and the ship's organization. A great deal of the regular routine business of both Section and Unit is handled over the two circuits in preference to handling it by written memorandum. The radiomen thus see useful traffic in messages which they can recognize as having a purpose as against abstract test messages which lack element or interest and which, furthermore, are too easy to make up to offer much practical training in this important phase of Naval Communication.

On board ship, the functions of the Flag and the ship organizations take place out of sight of the men in the radio room, those offices being located in other parts of the ship. Here, however, all these activities are within the plain view of the men and a good conception of Naval Communication as a whole as well as in its details is had by them. There is an atmosphere of reality about operations which is very desirable.

On Armory drill nights Naval Procedure is discussed and studied by use of the practice table fitted with a key for each chair, all keys are in parallel and operate the audio-frequency oscillator and loud speaker. Some time on these nights is devoted to military drill and seamanship.

Volume Compression

(Continued from page 59)

the "X," and its addition to the unit has proved quite beneficial.

The 6H6 and its associated transformer and RC filter are so easily adapted to other circuits that their addition to any existing speech amplifier is very simple, and is heartily recommended. Connecting the primary of the push-pull transformer across a high-level point in the audio system, rectifying the audio voltage developed across its secondary with the 6H6, and feeding this rectified voltage through the RC filter to the input stage of the speech equipment, is indeed a simple way to hold down the peaks and, at the same time, raise the average percentage of modulation.

Strays

RCA announces a new booklet on receiving tube characteristics (No. 1275-B) covering 191 different types, including glass, glass-octal, GT and metal types. A copy may be obtained from any local RCA distributor or, upon request, from Commercial Engineering Section, RCA Manufacturing Co., Inc., Harrison, N. J.

Weston recently announced a converter kit which extends the range of 20,000-ohms-per-volt analyzers to 5000 volts for television-receiver servicing. The kit includes a pair of specially insulated test prods. These test prods should go well in transmitter servicing.

THE "19" SERIES

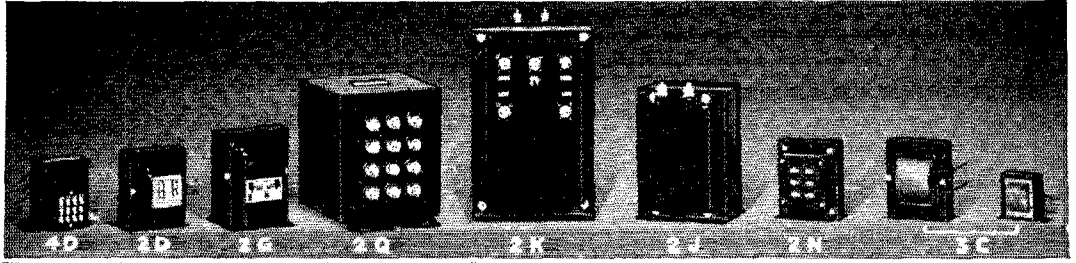

Illustration above shows mounting figures for "19" Series

PLATE SUPPLY TRANSFORMERS

Primary 115 Volts, 50-60 Cycles

Transformers rated in D.C. volts from two section filter Electrostatic shield between primary and secondary

Type No.	Sec. A.C. Load Volts	D.C. Volts	D.C. M.A.	Mtg. Fig.	Your Cost
T-19P55	660-0-660 550-0-550	500* 400	250	2 G	\$4.50
T-19P56	900-0-900 800-0-800	750 600	225	2 G	4.80
T-19P57	1075-0-1075 507-0-507	1000** 400	125 150	2 G	6.00
T-19P58	1200-0-1200 900-0-900	1000** 750	200 150	2 G	7.80
T-19P59	1500-0-1500 1250-0-1250	1250 1000	300	2 K	9.60
T-19P60	1875-0-1875 1500-0-1500	1500 1250	300	2 K	11.10
T-19P61	2125-0-2125 1875-0-1875	1750 1500	300	2 K	12.00
T-19P62	2420-0-2420 2125-0-2125	2000 1750	300	2 K	12.90
T-19P63	1500-0-1500 1265-0-1265	1250 1000	500	2 K	13.80
T-19P64	1875-0-1875 1500-0-1500	1500 1250	500	2 K	17.70
T-19P65	3000-0-3000 2420-0-2420	2500 2000	300	2 K	17.70
T-19P66	2125-0-2125 1875-0-1875	1750 1500	500	2 K	22.50
T-19P67	2450-0-2450 2125-0-2125	2000 1750	500	2 K	25.50
T-19P68	3000-0-3000 2450-0-2450	2500 2000	500	2 K	30.00

*This transformer has a bias tap at 30 V. **These transformers designed for double rectifiers and will deliver both secondary ratings simultaneously.

UNIVERSAL MODULATION TRANSFORMERS

Designed to match all normal ham requirements

Type No.	Cap. Watts	Secondary Series	M.A. Par.	Mtg. Fig.	Your Cost
T-19M14	30	75	150	2 N	\$4.20
T-19M15	60	125	250	2 N	6.00
T-19M16	100	175	350	2 N	9.00
T-19M17	250	225	350	2 Q	14.40

UNIVERSAL DRIVER TRANSFORMERS

Five usable ratios on each transformer

Type No.	Ratio Total Pri. to 1/2 Sec.	Mtg. Fig.	Your Cost
T-19D01	1:1, 1.2:1, 1.4:1, 1.6:1, 1.8:1	4 D	\$3.60
T-19D02	2:1, 2.2:1, 2.4:1, 2.6:1, 2.8:1	4 D	3.60
T-19D03	3:1, 3.2:1, 3.4:1, 3.6:1, 3.8:1	4 D	3.60
T-19D04	4:1, 4.5:1, 5:1, 5.5:1, 6:1	4 D	3.60
T-19D05	1:3.15, 1:2.75, 1:2.5, 1:2.25, Pri. 500 ohms	4 D	3.60

DESIGNED ESPECIALLY FOR HAMS

A series of transformers especially designed to cover all amateur requirements — Thordarson quality in the popular-price field.

* PLATE TRANSFORMERS

Two different secondary voltages obtained from each plate transformer.

* DRIVER TRANSFORMERS

All modulator requirements covered by five usable ratios on each driver transformer.

* MODULATION TRANSFORMERS

Universal modulation transformers match any class B plate to plate load to any class C load.

* FILAMENT TRANSFORMERS

Filament transformers of open type construction for convenience in under chassis mounting. Fig. 3 C

* CHOKES

Swinging and filter chokes in four D. C. current ranges. Figs. 2 D and 2 J

For complete information on the full series see your distributor or write factory for your free copy of the new Catalog No. 400.

THORDARSON ELECTRIC MFG. CO.

500 W. HURON ST., CHICAGO, ILL.

Demand "Power by Thordarson"

Station Activities



NEW ENGLAND DIVISION

CONNECTICUT — SCM, Frederick Ellis, Jr., W1CTI — AW leads the Section in traffic with B.P.L. total on deliveries. JYE handled traffic for YU. CTI announces the arrival of a baby daughter, March 10th. ITI reports his new portable station works fine; he is planning improvements in frequency measuring equipment. YU handled traffic for the Yale Engineering Exhibition. TD finally got his rig perking decently. KFN has P.P. 6L6X osc. into a 211D and gets close to ¼ kw. KNT expects to be on 1.75-Mc 'phone. GKM schedules VE2BU twice a week. DWP is on 7188 kc. mostly. On June 1st, at 8:30 p.m., the New Haven Amateur Radio Association, GB, will run a DX round-up, having GM6RG as principle speaker of the evening. GB has applied for membership in the New England Council of Radio Clubs. DDX, BYW, FMV, H8X and KQY were in the DX contest. LTZ is doing nice job with single 6L6. BHM heads the club list of countries worked. FWB has new Jr. op. KFN is revamping GB rig. APA took the day off, March 10th, to work some new countries in the DX contest; result — rotatable beam froze north-south, sentinal breaker burned up, main power switch burned out, 802 coil shorted, analyzer went haywire and the bias supply transformer shorted and burned out; in spite of all this he worked 28, 14 and 7 Mc. and scored 30,784 points. ACV was in Atlanta, Ga., when the contest began, but got home in time to work a few. IEV went after his Class A ticket. LSV is leaving for Florida in a super deluxe 40-foot trailer of his own design. Among the equipment included is a 600-1000-watt all-band transmitter, receiver, 1500-watt generator and eighteen 68-ampere ham storage batteries.

Traffic: W1AW 328 (WLMK 236) JYE 248 JXP 165 KKS 164 KV 139 CTI 118 ITI 101 YU 74 JQD 81 TD 43 ES 42 KFN 37 UE 31 KYQ 23 LUN 14 KNT-JFN 9 BDI 6 GKM 3.

MAINE — SCM, Winfield A. Ramsdell, W1FBJ — The Arrostook Valley Radio Club is off to a good start. Meetings are held Friday nights at 7:30 in the Armory at Fort Fairfield. The boys around Augusta are forming a net on 1.75 Mc., called the Kennebec Valley Net. LKP has new NC-44. EZR worked K4, YV4 and SP3 on 7 Mc. IFZ is new O.R.S. DPJ bought new receiver and made W.A.C. first night. APU has a total of 86 countries worked. BOK has 200 watts input on 28 Mc. LHA and LHD are attending Mass. Radio School. LVF is new ham in Presque Isle. LIP spent two weeks in Portland. PQ is trying a flea-power rig on 3.9-Mc. 'phone. TE moved into the new house. GMD is building e.c.c. KJJ made arrangements with some of his 14-Mc. friends to meet them while on a southern cruise. FDL has the old call back and is heard on 3.9 Mc. The "Four X" Club, which meets every day at noon on 3.9-Mc. 'phone, is going strong. BY1 is still DXing on 7 Mc. GXY is joining the P.T.N. and also will be E.C. for the Bath area. The club activity is gaining rapidly. Why not appoint a club activities manager in each club and have him report the doings to the S.C.M. every month? You may have noticed QST arriving earlier the past two months. This means that the report must be in exactly on time, so please get them started on the 16th. We need plenty more Emergency Coordinators in this Section. If you know of anyone who could be of help, pass the word along. Time to be getting the emergency equipment ready for the Field Day in June.

Traffic: W1KOU 811 GOJ 283 GVS 77 IST 69 IIE 57 FBJ 54 KMM 41 LMQ 38 GMD 33 HSE 32 KJJ 20 IBR 16 AFA 8 JUV 7 LDC 5 DHH 4.

EASTERN MASSACHUSETTS — SCM, Larry Mitchell, W1HIL — KH made B.P.L. on deliveries. AGX keeps 5 schedules daily. GAG is observing on 28 Mc. HWE keeps 3 schedules daily. This being my first report as S.C.M. I wish to thank everyone who voted for me, and hope I can be of service to all. Thanks, gang. Had letter from Sam, IWC; he is living at the Y.M.C.A. in Cedar Rapids, Ia. Drop him a line, gang. It seems to me a brief review of the Section would be in order at this time. We have 438 A.R.R.L. members in this Section. The Eastern Mass. Section Net operated on 3745 kc. At the present time there are eight or nine active members. Some of the 3745 crystals are available.

Write the S.C.M. if interested in joining this net. Official Observers: BMW, FZH, FL, GAG. Prospective O.O.'s: BHW, JGQ. 'Phone Activities Manager: HIL. O.P.S.: HIL, IAV, HKK, KPW, GAG, JGQ. Prospective O.P.S.: AAR, JDG, LMB. O.B.S.: ASI, HKK, JJJ, JSK. R.M.'s: JDG, JY. A.A.R.S.: IHI; N.C.R.: QW. O.R.S.: ASI, KH, EPE, DMF, KCT, JYJ, BDU, HWE, LLX, IGN, BAW, QW, HRE, LOC, AKS, IHI, EMG, AGX, JNF, LBY, JCK, JSM, KZT. Prospective O.R.S.: FWQ, WI. It is not the intention of the present S.C.M. to carry any deadwood. Unless at least two reports are received from all appointees during the next four months, on June 16th any who have not reported as above will be cancelled. We need more O.O.'s and O.P.S. and much more activity among stations in this Section. Let's get busy. LLX increased power to 600 watts. APE has all-band rig. WV sends nice list of DX worked on 14-Mc. c.w. and 28-Mc. 'phone; he worked VP9X for 11th country. AGX is very active on 56 Mc. Please get the reports in on time, gang. Mail them on the 16th. The S.C.M.'s address is 94 Howard St., Melrose. Reports from everyone are invited.

Traffic: W1KH 184 AGX 36 GAG 5 BDV 2 HWE 58 QW 8 JSM 134 JCK 135 (WLGV 42) EMG 157 KZT 100 AKS 389 LBY 65 EPE 326 LLX 11 HRE 170. (Jan.-Feb.): W1JCK 276 (WLGV 68) EPE 300.)

WESTERN MASSACHUSETTS — SCM, William J. Barrett, W1JAH — BIV is active in CMS A.A.R.S. BKG had his rig set up at Pittsfield Scout Show. Congratulations to our Director, BVR. Perce was appointed Chief Radio Aide of the Army Amateur Radio System, by Major Gen. Mauborgne, Chief Signal Officer of the Army; a fitting reward for a big job, well done. DUZ has nicely organized the 1.75-Mc. 'Phone Net in the West. Mass. A.A.R.S. JAH was named State Radio Aide and S.N.C. 2 for West Mass. A.A.R.S. LNH has been doing a nice job handling traffic. How about some more of you new comers trying traffic, the time tested means of building up your code speed and accuracy? GZL reports the Holycoke gang all prepared for the next flood. KRX is building separate power supplies for each stage in rig. JOF, new O.P.S., is installing 807 buffer. BNO is building new 100-watt exciter. COI managed to scrape up three new countries in DX test. LHY is adding ten final to his 6L6 osc. HNE is patient at Rutland State Sanitarium, Rutland, Mass. Don't forget to drop him an occasional message or card, fellows. LQZ, Emergency Station at State Armory, Adams, is now in operation. Please get your reports in mail on the 16th so I can get this report on time.

Traffic: W1BIV 277 IOT 243 (W1GN 115) BKG 224 EOB 86 BVR 80 (WLG 226) DUZ 70 JAH 63 LNH 50 GZL-BNL 17 KRX 2.

NEW HAMPSHIRE — SCM, Carl B. Evans, W1BFT — A special mobilization of N.H.E.N. (New Hampshire Emergency Net) was held in conjunction with the 2nd annual American Legion mobilization in N. H. on March 13th; 43 stations and over 55 operators assisted in handling reports from 57 posts of the Legion to headquarters in Concord. Nets were used into the Capital City as follows: 1840 kc. with EAW, 3840 kc. with HOV, 3735 kc. with AWU and 3600 kc. with DMD as receiving station. A special telephone was installed at Legion Hq. to receive the reports from the local stations. The Nashua Mike and Key Club participated by setting up radio stations at the City Hall and five other strategic points of the city using "2½ meter" transceivers and regular 3735-ke. channel. CMR set up portable at one of the Manchester posts, and LJB at the one in Suncook. The 3rd test mobilization of N.H.E.N. is scheduled for Sunday, May 7th, with net schedules as follows: 1840: 8-9 a.m.; 3600: 8:30-10 a.m.; 3735: 9-10 a.m.; 3920: 9-9:30 a.m. and 7200: 10-11 a.m. Let's have a big turnout in May. In case of possible flood emergency this spring, even if you have no traffic, check in on your nets regularly. There may be traffic for your locality. DMD will be on 3600 and 7200 kes. continuously if anything does break at any time. Let's be ready!! GEY is on 3.5 Mc. GHT, LLD and KHO are active on 110 Mc. EDN is on 2-Mc. 'phone from his home in Derry. AQW, new ham in Concord, was recently initiated into the M.V.A.R.A. On March 8th, the Coos Radio Club sponsored a supper followed by a lecture and demonstration of amateur and service equipment by ASQ and Walter Fickett from Portland. About 30 hams and servicemen attended. KPD needs Idaho and Arkansas to complete W.A.S. on 2-Mc. 'phone!! JCA has gone 3.9-Mc. 'phone with a home-made crystal mike made from a single

Brush ear-piece. LFO is working W6's on 14-Mc. 'phone with 4 watts input. IVU is moving to new QTH with more room for antennas. HUD is using an RK47 final. KLV is trying 28 Mc. LVG, new ham in Concord, is attending radio school in Boston. ATE is new ham in Manchester on 14-Mc. 'phone. BST has new 28-Mc. vertical antenna. IDY is winding an a.c. generator. BCP is on 14-Mc. 'phone. GMB has a pair of 100TH's in the final. ANP is rebuilding.

Traffic: W1KIN 219 GMM 167 BFT 84 ILN 75 1P 34 JDP 20 BAL 13 APK 8 DMD 4.

RHODE ISLAND — SCM, Clayton C. Gordon, WIHRC — The Providence Radio Association had its annual dinner on March 18th, with an attendance of about thirty. State Representative Ramsey of East Providence honored us with his presence and gave our Alternate Director, GTN, an opportunity to show him how badly the hams in Rhode Island need portable emergency power for emergency work. It is hoped that through the efforts of Rep. Ramsey the State will be persuaded to assist itself by assisting us to have some emergency power plants available at strategic points in the State before another major disaster hits us. LDL has T40 on the air. GTN has a 6C5-6L6 battery or a.c.-powered portable all assembled and neatly packed in three small and readily portable boxes with handles, and has demonstrated that it will work. It will soon be given a real test when the Fire Department of No. Scituate uses it, together with other ham-owned emergency equipment, in patrolling the forest fire area of that town over the weekends during the coming spring season. Active cooperation in this enterprise is being furnished by Corporal Sneed of the State Police Barracks at Scituate. ILO is back on 14 Mc. BTJ is on 14 Mc. with pair of 6L6's. HRC has started construction of a kw.

Traffic: W1UIN 781 INT 377 GTN 206 KWA 165 LAB 133 CPV 121 JDX 76 IEG 71 KYK 69 KLR 50 KIV 49 HCW-LQG 42 LDL 41 HRC 29 KKE 25 QR 24 KOG-KTH 15 DDY 9.

VERMONT — SCM, Clifton G. Parker, W1KJG — AVP visited CNX and APK. AMR changed QTH to Malletts Bay. KOO lacks 5 for W.A.S.

Traffic: W1FSV 430 QAN 21 KTB 115 KXY 104 KOO 17 AVP 12. W2JBL/1 59.

ATLANTIC DIVISION

EASTERN PENNSYLVANIA — SCM, John B. Morgan, W3QP — Ass't. SCM, W3AKB. R.M.'s: 3AKB, 3AQN, SASW, 3BRZ, 3BES, 3CHH, 3EML, 3FXZ, 3GHD, 3GUU and 3HDB report fine DX during contest. 3BES got his 100th QSL card for C.C. 3PRY, O.O., finally broke down and reported some traffic on schedule with an old navy shipmate, NY2AB. 3GHW worked 12 miles on "2 1/4 meters" with 10 watts. 3GJY is grooming his rig, to give 3BES a chase in O.R.S. parties. 3GLQ visited N.B.C.'s television department. 3GQU is giving 3.9-Mc. 'phone a whirl. 3GYK is sending code practice on "2 1/4 meters." 3GYY got a nice HF2 rock for his birthday. 3HQE joined the gang; he is inspector-in-charge of Mackay Radio's Philadelphia office; ex-W2CSO and ex-W2DBC. 3QP borrowed use of neighbors' trees to erect 3.8-, 7.1- and 14.35-Mc. half-wave wires, with single wire feed. 3RR met 3HEZ (Arlington, Va.) on the air and went to visit him. 8ASW is using an 845 (which he bought for 50¢) in his final, in place of the old '03A. 8FLA requests any O.P.S. of this Section who care to join up with the Third Corps Area Radiophone Net, on 3.9 Mc., to drop him a card. 8OML is working into E. Pa. Traffic Net on 3835 kc. 8PWJ is building a portable station. 8RKZ is working with A.A.R.S. PA-2 Net. 3QV reports considerable increase in 56-Mc. activity in Phila. area. 3EEW found a way to buy and erect a steel pole for 14 Mc. for only \$2!

Traffic: W3ADE 36 AKB 198 BES-CHH 3 EFH 103 AQN 105 EML 568 FRY 22 GDI 35 GHD 1 GHW 4 GJY 86 GKO 220 GUB 24 GYK 44 EEW 21 GYY 1 HCT 2 HDB 4 DXC 12 HQE 21 QP 298 QV 128 RR 9 8ASW 359 ATF 45 CDT 19 EKG 156 FLA 49 HKS 18 OML 19 RKZ 14.

MARYLAND-DELAWARE-DISTRICT OF COLUMBIA — SCM, Edgar L. Hudson, W3BAK — R.M.'s: 3CXL, 3CQS, Chief R.M.: 3BWT. BKZ is back on. EKZ worked 64 countries in c.w. DX contest. The Baltimore Mike and Key Club's annual hamfest will be held Sat., May 13th, at the Emerson Hotel. HQU moved to new QTH. GUW is moving from Washington to Kensington, Md. CDG has new exciter, using 6A6 and T21. GZK, HSB

and GKN are leaving for Boston to attend Harvard for a year of Post-graduate-Communication engineering. BND rejoined A.A.R.S. WB also joined A.A.R.S. ECP lost antenna in windstorm Mar. 13th. EYX has new HQ120 receiver. All stations sending in items for publication in QST are urged to mail them on the sixteenth of the month. The S.C.M. report must be completed and mailed on the twentieth. Please mark your calendar — NOW.

Traffic: W3CIZ 1046 BWT 805 ECP 651 GKN 19 GZK 11 FPG-CDG 9 AKR 6 HQU 2 CXL 403 (WLM 3674).

SOUTHERN NEW JERSEY — SCM, W. W. Filson, W3BBI — EWK is new O.R.S. BZX is heading the Section in traffic. The N.J. State Net (Army Amateur and regular amateur) will hold first annual outing, hamfest and get-together sometime in May, at Trenton, under leadership of ZI with able assistance of VE. CGU moved rig to the attic. DNU is new member of A-1 Op. Club. FML is proud papa of a Jr. op. FTU is active on 1.75-Mc. 'phone with new 275-watt rig. ASQ has new Mims Signal Squirter for 28 Mc. ATP is building new rig. The D.V.R.A. re-elected CCO pres.; other officers: GNU, vice-pres.; ZI, secy.; EUH, treas. AWH was host to Trenton Radio Society, Mar. 15th. HCL returned to 3.5 and 7 Mc. HDW had some interesting checker games on 7 Mc. HAV is back on 7 Mc., with 2A5 crystal osc. and '10 final. The Great Eastern States Outing and Hamfest, sponsored by D.V.R.A. each year, will be held at the Trenton Fair Grounds Sunday, August 13th, under Guidance of GNU, who is Chairman. ZI and AFH completed W.A.S.

Traffic: W3BZX 380 DNU 136 ZI 110 BYR 98 (WLNV 33) EFM 45 (WLNJ 14) EWK 36 BEI-GCU 22 AEJ 4.

WESTERN NEW YORK — SCM, Ed Preston, W8CSE — R.M.'s: 8BJO, 8DSS, 8FCG, 8JTT. P.A.M.'s: 8CGU, E.C.'s: 8GWY, 8RGA. Section O.R.S. net frequency: 3720 kc. From the Auburn Club's "BUG" comes the following information: New officers — NQU, pres.; RNG, secy.; BCN, vice-pres.; BWE, treas. DSU was appointed treasurer of the Field Day committee. AQX is working 7 and 14 Mc. BDV is on 1.8-Mc. 'phone. BFG is working his way up in DX Century Club. BLP worked plenty of stations in 1.75-Mc. W.A.S. contest. DSU's mast fell down. Ex-8LDA, now 2LWL, is on 14-Mc. 'phone from Brooklyn. NQC worked ZD4AB for 80th country. RNG got nine points in 1.75-Mc. W.A.S. contest. Thanks to NQC for the above dope. From DZC's excellent weekly column in the newspaper, we glean the following information on Elmira activity: JU returned to the air on 14 Mc. with 135 watts to an RK20. DZC is now W.A.S. HQY is considering a small rig on 28 Mc. SBV has T-55 final. AYD is trying hard to contact P.L. NOU took Class "B" exam. KIJ is planning on W.A.C. (Working All Contests) this year. MIUQ has new vertical self-supporting 14-Mc. antenna. RZF joined N.C.R. RTW has been experimenting on 56 Mc. Tests with EX in Oregon will be continued indefinitely. RRS is considering 1.8-Mc. 'phone operation. KDY is spending the winter in Calif. NNJ is all set for big DX on 28 Mc. JQE spent a lot of time putting his rig on 28 Mc. CGU works 3.9- and 14-Mc. 'phone. CO resumed activity on 7034 kc. with 300 watts to a '52. JTT, our star traffic man, had great luck in working HA9U and VP5SP on 3.5 Mc.! It is rumored that EUY has forsaken DX for 'phone. SMI, in Silver Creek, is latest addition to O.R.S. CMF is looking for a Genemotor for his portable rig. SWC is new Rochester ham. The Rochester Club enjoyed an illustrated talk on line noise, presented by the local Electric Lighting Co. EBS has been re-issued his old call MC. FNT is on 28 Mc. with new rig. NOL is still on 28 Mc. RJZ is getting his money's worth out of that new class "A" ticket on 3.9-Mc. 'phone. RKO has new rig with 25 watts on all bands. DFN has new receiver, NBR is on 1.8 Mc. with 6L6 rig. RGA is on 14-Mc. 'phone now instead of 28 Mc. NCM and PPR gave demonstration of two-way communication before the Rochester Hobby Council. Emergency Coordinator RVM is lining up the A.E.C. in St. Lawrence County. All amateurs in that part of the Section who have emergency equipment are urged to contact Ken at once. DHU has been busy with N.C.R. work. LGH is operating low power 'phone on 1.8-Mc. MVQ has new 50-ft. mast. QUN, active in O.R.S. net, finds time to play checkers with 2LQM. AXE is burning up the ether on 3.5 and 7 Mc. DNE is now located in Cortland. NXQ has one peach of a rotary beam. BJO keeps Trunk "G" operating. PCN is on Trunk "AP". With FCG, JTT, LJD, and CSE in the A.A.R.S. (This provides plenty of both incoming

(Continued on page 104)

NEW..PRICES ..CATALOG

Here's welcome News! The New Kenyon Catalog is just off the Press! Not only does it describe in detail the Kenyon Amateur "T" Line, but best of all, prices have been revised downward. Now you can buy the "best" at prices that you would expect to pay for Transformers produced under less scrupulously controlled production methods. Before you make a change or build a new rig, be sure to have a copy. It will save you dollars and cents!

If your Jobber cannot supply you with a Free copy, write us direct, mentioning his name



KENYON

TRANSFORMER CO., INC.

840 BARRY STREET - NEW YORK, N. Y.
Export Department: 25 Warren St., New York, N. Y.

MORE SIGNAL LESS NOISE!

Positively the last word in Preselection. Increases performance of ANY RADIO RECEIVER. Bandswitch, 5 to 185 Meters; High Gain 1852 tube; cal-

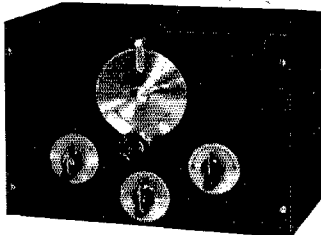

ibrated dial; vernier adjustment. Kit or wired form with Kenyon Filament Transformer. In stock at all good Ham supply houses, or write direct, giving us dealer's name. Free CATALOG upon request.

KEEP YOUR EYES OPEN

COMING NEXT MONTH — A real "hot" 5-tube frequency meter. High accuracy, unusual stability. Exceptionally wide band spread. Get your name in now to receive the first free bulletin off the Press!

BROWNING LABORATORIES
WINCHESTER, MASS.

Export Dept. 461-4th Av., New York, N. Y., U.S.A.

A.R.R.L. AFFILIATED CLUB HONOR ROLL

- All members of these are A.R.R.L. members*
- Baton Rouge Amateur Radio Club, Baton Rouge, La.
 - Birmingham Amateur Radio Club, Birmingham, Ala.
 - Bluefield Amateur Radio Club, Bluefield, W. Va.
 - Bridgeport Amateur Radio Association, Bridgeport, Conn.
 - Charlotte Amateur Radio Association, Charlotte, N. C.
 - Chester Radio Club, Chester, Pa.
 - Dells Region Radio Club, Portage, Wis.
 - Electric City Radio Club, Scranton, Pa.
 - Fellsway Radio Club, Medford, Mass.
 - Helix Amateur Radio Club, San Diego County, Calif.
 - Huron Radio Club, Huron, S. Dak.
 - Iowa-Illinois Amateur Radio Club, Burlington, Iowa
 - Kaw Valley Radio Club, Topeka, Kansas
 - Moncton Amateur Radio Club, Moncton, N. B., Canada
 - Mound City Radio Amateurs, St. Louis, Mo.
 - New Orleans Radio Club, New Orleans, La.
 - Norfolk County Radio Association, Norwood, Mass.
 - Northern Nassau Wireless Ass'n, Manhasset, L. I., N. Y.
 - O.B.P., Chapter No. 1, St. Louis, Mo.
 - Pendleton Amateur Radio Club, Pendleton, Ore.
 - Santa Clara County Amateur Radio Ass'n, San Jose, Calif.
 - Spokane Amateur Radio Association, Spokane, Wash.
 - The Northwest Amateur Radio Club, Des Plaines, Ill.
 - The Portland Sevens, Portland, Oregon
 - Trenton Radio Society, Trenton, N. J.
 - Valley Radio Club, Eugene, Oregon
 - Wausau Radio Operators' Club, Wausau, Wisc.
 - Yakima Amateur Radio Club, Yakima, Wash.
 - York Radio Club, Elmhurst, Ill.
 - York Road Radio Club, Glenside, Pa.

FIELD DAY, JUNE 17th-18th

This month finds many of the live-wire clubs making preparations for the 1939 A.R.R.L. Field Day, scheduled for June 17th-18th. The "F.D." is one of the biggest events of the year, especially for organized groups. Judging from the interest being shown, this year's activity is going to be too good to miss. Combining as it does the sport and good fellowship of an outing with the more serious aspect of emergency preparedness, we recommend the Field Day as a most worth-while activity. Don't miss! Complete details in June QST.

NEWARK SCORES AGAIN

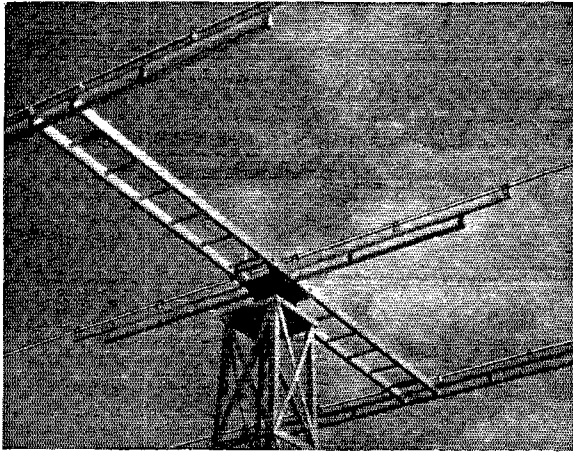

SIX NEW COMPLETE ROTARY BEAM ANTENNAE by BASSETT

Another scoop for Newark... Now for the first time six complete new Bassett Rotary Beam Antenna systems are available to the radio Amateur. These units, the result of many years of research, easily withstand wind and weather giving peak performance year after year. Complete systems contain big husky Rotomatic Drive unit... Structural Pieces... Tubing... Insulators... Necessary Hardware. Sixteen operating lead wire cable costs 15c per foot extra. State the length needed. Antenna systems shipped F.O.B., Niles, Mich.

COMPLETE TWO-, THREE- AND FOUR-ELEMENT SYSTEMS

2-Element 10 meter System plus Rotomatic . \$86.10	3-Element 20 meter System plus Rotomatic . \$107.15
2-Element 20 meter System plus Rotomatic . 95.25	4-Element 10 meter System plus Rotomatic . 105.00
3-Element 10 meter System plus Rotomatic . 94.15	4-Element 20 meter System plus Rotomatic . 121.00

BASSETT ROTOMATIC DRIVE

Husky built and designed to give years of trouble-free uninterrupted service. Bassett Rotomatic Drive fills your need for efficient year round use. Attractive control box simple to operate. Just point dial to the direction wished and Rotomatic does the rest. Positive automatic locking device holds antenna solidly until you change the dial position. Absolutely will not slip in the wind. Rotomatic Drive Complete less lead cable..... **\$69.50**

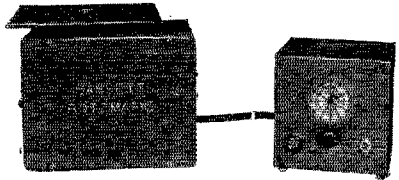

WRITE FOR SPECIAL NEWARK ANTENNA EASY PAY PLAN

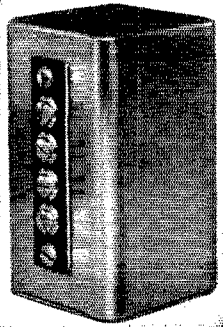

BASSETT RECEIVER COUPLER

This mighty pigmy does a beautiful job of giving you correct impedance match between a transmission line of less than seventy ohms into a receiver input of 300 to 500 ohms. Signal increase as much as 20 Db. Practical noise reduction.

BRC COUPLER ONLY **\$1.00**

FILTER CONDENSERS

DC Volt	mf.d.	Size	Wt.	Price
2000	2	4 7/8 x 3 1/4 x 1 1/4	1 1/4 lbs.	\$1.50
1250	3	3 1/4 x 3 1/4 x 1 1/4	1 1/4 lbs.	1.25
1500	3	5 x 3 1/4 x 1 1/4	1 1/4 lbs.	1.50
1500	4.4	5 x 3 1/4 x 1 1/4	1 1/4 lbs.	1.75
2000	8	5 x 3 1/8 x 3 1/4	2 1/4 lbs.	2.75

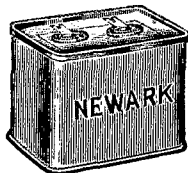

SEND
FOR
NEW
BIG
SPRING
FLYER
NOW
READY
FREE!!

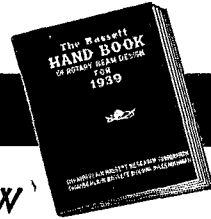

NEW BASSETT BEAM ANTENNA MANUAL

39 pages chock-full of real meaty dope on rotary beam antenna design, engineering and operation. The most up to date book of its kind on the market today. Only.....25c

YOUR CALL LETTERS IN GOLD.....10c

Two-inch high decal letters for shack or car window.

NEWARK

Electric Company

323 W. MADISON ST.
Dept. Q CHICAGO, ILL.

and outgoing traffic. OQU is O.B.S. in Wellsville. RKM has an RK12 final. FCG is heard on the O.R.S. Net, as regularly as one night comes after the other. PCW'8 has been heard frequently from Univ. of Cincinnati. SHC keeps his schedule with DSS. PLA has been treating the boys on 'phone to the sound of his melodious voice. SVQ and RMR are doing fine on 7 Mc. ADV is putting a large amount of effort into the organization of both traffic and emergency nets on 7 Mc. In order to make his nets thoroughly effective he must have members in every part of the Section. If you have a W8 call and live in New York State, you are urged to get in touch with him and advise him of your availability. The ability to provide emergency communication is the radio amateur's greatest asset today and every real amateur operator should acquaint himself with the necessary knowledge of procedure. Amateurs in Monroe County should contact their Emergency Coördinator RGA. St. Lawrence County amateurs will cooperate with RVM. ADV will be pleased to receive the support of any 7-Mc. station in the Section. The S.C.M. would like to appeal to all stations to mail their reports not later than the sixteenth of each month. The Central New York Radio Club of Syracuse will hold its annual hamfest on May 13th. The committee extends a cordial invitation to all.

Traffic: W8QUN 45 MVQ 17 DHU 28 RVM 9 RZF 8 CMF 3 JTT 677 CO 22 CGU 15 JQE 63 ADV 65 PLA 207 RKM 59 SHC 26 DSS 89 SBV 222 PCN 208 FCG 245 BJO 155 CSE 138.

WESTERN PENNSYLVANIA — SCM, Kendall Speer, Jr., W8OFO — Altoona Horseshoe Radio Club holds first annual banquet and installation of new officers, April 25, at the Y.W.C.A. Don't forget to plan to take in both days at the Atlantic Division Convention at the Fort Pitt Hotel, Pittsburgh, June 23-24. KWA, FUV and ZAE made the H.P.L. this month. WLMA/8YA ran nice traffic total of A.A.R.S. traffic in two nights. HUL uses a TZ40 final with 50-watts input on 7 Mc. EFA and FQL were commissioned Ensigns in the Naval Reserve. Congratulations. FUV says BQK added a 242-final with 250 watts. RQA is working DX on 7 and 14 Mc. SIL uses 6L6 oscillator. SHN, a Yeoman in the N.C.R., works 7188 kc. KXP is building 14-Mc. beam. OVT made his debut on 28 Mc. with P.P. HK-54's, 300 watts, modulated Class B with TZ40's. OEM has been working a nice line-up of DX on 7 Mc. AVY is tied up with new Pittsburgh Emergency Coördinator appointment. BOZ is most active amateur in vicinity of Warren. RBI has W.A.S., all VE's-K4, all verified on 1.75-Mc. 'phone. PJJ is changing oscillator to e.c.o. and crystal-one-dial control. SWT has new SX17. QEL tested his rig on 28 Mc., using pair of 250TH's. RAZ gets good results on 1.75-Mc. 'phone with 20-watts input. RAU is building 809's final with 801's modulating. The Greenburg Radio Club is staging a W.A.S. contest. KRY is active with 350 watts. 3EYK visited IYI. HWK took commercial examination. QVP is selling out. NWW is experimenting with all-band exciter. QDN and IVQ are making plans for summer 56-Mc. activity. APQ worked XU4XA using 25 watts to a 6L6G. RBD is working a nice group of stations with his 60-watt 'phone on 1830 kc. NTJ and PHC are back after hitchhiking to Florida.

Traffic: W8KWA 596 HUL 412 DNK 344 FUY 292 ZAE 253 KTS 181 MJK-NZR-OFO 168 LGD 145 GYW 140 DYY 118 QBK 100 LBO 93 QNJ 89 KTM 80 MOT 79 ZD 72 DDC 68 CMP 62 EBJ 61 NDE 59 KD 56 NQQ 55 OKS 54 RQA 48 EFA 33 QNW 31 KOB-QFM 30 QWI 28 KXP 23 LUG 22 NCE 20 IOH 14 FZG 10 OUT-QFR 9 IZS-MUD 8 KNB-ME-OTI 5 OEM-SHN-SIL 4 RAT 3 AVY 2 YA (WLMA 440).

HUDSON DIVISION

EASTERN NEW YORK — SCM, Robert E. Haight, W2LU — KWG, high traffic man, is active with A.A.R.S. and schedules 2CGG. LU is active on N.C.R. drills. HXQ plugs along with A.A.R.S. LSD is prospective O.R.S. KFB reports 1.75-Mc. 'phone activity. HTU increased power to 500 watts. LLU made low cost super (Oct. QST). GFD leaves E.N.Y. Section for Sidney, N. Y. E.N.Y. regrets to lose GFD and wishes him luck at new QTH. KQO is building a I-band exciter. KPI is trying to get rig perking on 14 Mc. DPM has new rig perking on 14 Mc. HVR is getting on 28-Mc. 'phone. EOA completed final with pair of RK63's. ACB is doing swell job getting E.C. under working condition for June Field Day. KUD was appointed

Asst. E.C. for 14 Mc. and CJP for 7 Mc. 9KHG reports 28Z will hold open house May 5-6-7 at R.P.I. Outlets on Trunk Lines are desired. 2KFB is Chief Opr at FTC (New Rochelle High School). All reports must be in the S.C.M.'s hands not later than 20th of every month. KXF made FB total in Jan. O.R.S. Party. Mid-Hudson A.R.C. news, via BJX: AEQ holds forth on 1.75-Mc. 'phone. CGT is on 14-Mc. e.w. and 28-Mc. 'phone. CVT is going to build up a small portable rig. HVS gets on 7 Mc. from time to time. CDM is still the local premier DX man. BJX is rebuilding his transmitter into a rack-and-panel job. AFI has an HF-100 perking in his rig. AGZ has been busy building the club's new portable rig. DAX rejoined the club.

Traffic: W2KWG 120 LU 76 HXQ 33 LSD 28 KFB 22 LEL 12 KXF 25.

NEW YORK CITY & LONG ISLAND — SCM, Ed. L. Baunach, W2AZV — KKW is out for O.R.S. After a long time on 14 Mc. FF has tried 3.5 Mc. B.C.L.'s chased IHT from 1.7 to 14 Mc. The storm of Mar. 14th blew ELK's feeders down and took KAM's zepp antenna with it. LXX was on from Riverhead during DX contest. DOG cast away his 1932 breadboard rig and has gone modern, all crystals on 1.75 Mc. HNY is being heard in Conn. on "2 1/4 meters." KPB is getting the bugs out of his new 450-watt 1.75-Mc. 'phone rig. LVN and LVP are new comers at Easthampton. CMI finds e.c.o. FB on 3.9-Mc. 'phone. LUD operates with about six-watts input. KJT took a trip to Cuba. HNR is using new HD203A. LZL is an ex-W3. IOI is on 28-Mc. 'phone only. KJY has 56 osc. and 59 amp. on 1.75-Mc. 'phone with one-watt input. During the DX contest KYO thought he would CQ Nev. to get his W.A.S.; 6QQL (Nev.) came back and that was the last of the DX contest for him. CXP is building new pre-selector. CRR is finally on the air. LPJ worked seven new countries in DX contest. A QSO with JQJ resulted in LGG's first message to an acquaintance of 17 years ago. AHC reports big plans under way for a hamfest at World's Fair on Memorial Day. PF is making plans for the A.A.R.S. to handle traffic for the World's Fair. ITX is acting N.C.S. for the S.N.Y. A.A.R.S. for OQ. EC says stations with any traffic for KA or K6 should call the A.-P. trunk line on 3630 kc. after 9:30 P.M. JWW calls the K4's on 28 Mc. AOY is president of Chelsea Radio Club at 432 W. 27th St., N.Y.C. Anyone interested in the club should get in touch with him. JVK is working on the A.M.E.N. on 7 Mc. KCV worked a pack of DX stations with his exciter unit running 35-watts input on 7208 kc. HBO and Tu-Boro R.C. defeated the Queens Radio Amateurs in a bowling match Mar. 14th. JZX is the N.C. disaster communication chairman of the Red Cross. LR, the E.C. for Suffolk County, is looking for more self-powered stations for 56-Mc. operation; all those interested should get in touch with him. LBI is assistant E.C. on 3.5 e.w. for Queens County. BGO, E.C. for Bronx County, is looking for more stations to register in A.E.C. JHB's single dial e.c. rig is drawing much attention. CHK is back in the A.A.R.S. on 3.9-Mc. 'phone. AZV's new antenna is working to perfection. The following stations can be heard on the Section net on 3710 kc. every night at 8:30: LR, GDF, ITX, LBI, AZM, DBQ and JHB.

Traffic: W2JHB 439 SC 287 (WLN 869) HMJ 257 JZX 231 LR 221 KI 155 ITX 142 AZV 100 PF 82 LBI 76 JBL 59 JVK 55 GDF 39 KYO 37 BGO 31 EC 30 LPJ 26 KAM 22 FF 21 CHK 17 JDG 17 KJY 16 AOY-KCV 15 LOQ 14 DOG 9 BYL 8 FLD 7 ESO-FIP 6 AHC-CIT 5 CENT-AZM 4 AA-BJO 3 LGG-EXR 2 EVA-HGO 1.

NORTHERN NEW JERSEY — SCM, Fred C. Read, W2GMN — An instructive and enjoyable feature of the March meeting of the QSP Club was a visit to the Signal School at Fort Monmouth, with HQL acting as host. GVZ has new signal squirter for 14 Mc. AMF has been building new 28-Mc. rig. JAS is making new beam antenna. CMZ is on 28-Mc. 'phone. ISF, LAO and LMN are new O.R.S. HXJ of Maplewood reported for first time. COG reports 1 for Raritan Valley Radio Club. Newly elected officers: Pres., FSN; vice-pres., AIN; secy., COG; treas., IAT; sgt-at-arms, KTX. The club meets 1st and 3rd Thurs. at New Brunswick Y.M.C.A. Mr. Topping and KAV of Bell Telephone Eng. Dept. have instructed all members in artificial respiration method. LJD moved to Highland Park from Red Bank. JSS took first place in the club code contest. FSN, LJD and JSS took part in annual club DX Contest. KTX, IBF, LFI and HJU find 1.8 Mc. FB for 'phone work. 3HXI is new station at East Millstone. The Original Tri-County Radio Association purchased a 100-ke. multivibrator for use of its mem-

bers. CQS and CAY have new 3-element rotary beams. CAY worked 21 states in 1.75-Mc. W.A.S. Party; he also worked G2DQ and G2PL on 1.75-Mc. c.w. in Trans-Atlantic Test, and has 26 countries on 3.5 Mc. KIP moved to this section from N.Y.C., L.I. KHA is new O.B.S. He transmits on Mon., Wed. and Fri. at 9:30 p.m. on 3572 kc. KNN enjoyed the DX Contest. Official Phone operators now get together for meetings about once a month. Some interesting activities are planned. If you are an O.P.S. or interested in being one, come out. March meeting was held at home of EKU in Scotch Plains. Bill Shannon reports for North Newark A.R.C. that many members participated in DX Contest. IGT, LCA, IWY, KON and KRS are getting portable gear ready for Field Day in June. IWY is working out well with 200 watts on 14 and 1.75 Mc. LCA's put up a rotary beam. IYQ is going places with an 803 and 250 watts on 7 Mc. IGW and KMK are rebuilding. IGT is working plenty of DX. DWA's shack is ragchewers' headquarters and half a dozen hams can be found there any night. LGY is working plenty of foreigners on 14 Mc. with 809.

Traffic: W2HWI 374 CGG 299 KHA 178 GVZ 159 (WLNI 11) KMI 113 HQL 93 (WLNR 45) HCO 27 LKH 6 IZV 3 LMN-HXJ 2.

ROANOKE DIVISION

NORTH CAROLINA SECTION — SCM, W. J. Wortman, W4CYB — I want to take this opportunity of pledging to you my best efforts as S.C.M. With the cooperation of each one we will be able to make North Carolina a still better Section. Your criticism and suggestions are always wanted, and will be welcomed at any time. DLX leads the State in traffic again this month. AH is reported to have used 4000 ft. of wire in new antennas for DX contest. BX and CLB are working on new rotaries. OG, NC, ACA and AHF worked the c.w. part of the DX contest. DGV is working c.w., while rebuilding modulator. BYA has new 28-Mc. beam, working out fine. ALT revamped his transmitter and now works 1.75 through 14 Mc. FSE, QA, TW, CRW, DEN, FOA, DPF, GW, TO and FVD are working 'phone in Asheville. FIX made W.A.C.; congratulations! We have been asked by several to thank the Asheville gang for the bulletin they have been publishing. BHR reports a new rotary taking shape. TJ in Concord has been working out FB with a rotary and AAU is trying to outwork him with more power and a "Q." BV returned to Statesville after spending the winter in Belmont, N. Y. BVD is working DX in Warren Plains. EYA has another 35T, and is breaking it in on c.w., while rebuilding his modulator. DGU has new Hammarlund HQ-120. We herewith thank the Fayetteville gang for the hamfest held there last month. Boy, did we have barbecue — if you didn't come you missed a good time. Please send in some dope for next month, gang. All the best and 73.

Traffic: W4DLX 153 BRT 23 ALT 10 FJS-BHR 7 DGU 5 DGV 2.

SOUTH CAROLINA — SCM, Ted Ferguson, W4BQE — BNN operates 28-Mc. 'phone. EHF and FHE are on 28- and 1.75-Mc. 'phone. EPJ's e.c.o. is working FB. FHE reports the c.w. DX contest FB with 9300 points. AUW made 26,600 points in the contest. CUR has new NC101X. FMZ has his O.R.S. DRE is rebuilding. CZA sticks to his C.W. CQU signed up with the A.A.R.S. for another two years. COL is operating portable, account of change in QTH. EZF is experimenting with "1 1/4 meters." FFO is operating 14-Mc. c.w. while rebuilding modulator. BRP and FSL are active in the nets. FFH is working on his emergency set-up at Charleston. CZN turns in nice report on the activity of the A.A.R.S. Net. CQG has two new 3-element beams, one on 14 Mc., and the other on 28 Mc. EXJ is active on 1.75-Mc. 'phone. EDQ took part in DX contest. FNC is controlling the 1.75-Mc. net. The fellows interested in forming a 3.9-Mc. 'phone net please get in touch with EPJ.

Traffic: W4CZN 182 CZA 84 DXF 62 FFH 40 BRF 31 CQU 24 FSL 18 FDN 15 EWB 17 EOZ 15 CUS-FNC-DGDF-EXJ-BNN 10 ECG-EHF 8 FMZ-DNQ 7 EPJ 6 FHE-EZF 5 FFO 1.

VIRGINIA — SCM, Charles M. Waff, Jr., W3UVA — R.M.'s: GTS, HDQ, P.A.M.'s: AIJ, GWQ, HOY is active on 4-Mc. 'phone. FQO added six countries in the DX Contest. GWQ is holding down 1895 kc. as ringleader of the Old Dominion Net. AIJ reports the following members of Virginia Phone Net: AIJ, FGJ, FHO, FCU, BTM, ELB, FTC, EPK, HOY, BIG, AHQ, BIW, OGB. AIJ worked two ZL's and two K6's on 4-Mc. 'phone. BZE worked 5GUZ in New

Mexico for 48th state. HDQ is new R.M. for Virginia Traffic Net. BFW is still rebuilding. DX Contest scores: CHE, 182,500; EMM, 175,000. CHE worked J8CA on 7 Mc. ELN is a good traffic outlet with numerous schedules. BIG is using TZ-40's in Class B. GTS reports A.A.R.S. in Virginia has six members: GTS (N.C.S.), EUG, ELN, BZE, HBH, and FIO. Gea's time is taken up with 4 1/4-month-old Jr. opr. FZG joined the benedicts last Nov. DFS is stationed on the U.S.S. *Chicago*. HBH is now at Woolwine and, with DNY, is operating WUSY, C.C.C. station. ELN is operated now by IINI, GDN, former opr. at ELN, will soon be K6OCL at Guam. FQO likes working CR7's. CA will be back on 3580 kc. GLV is building a 1 1/4-kw rig for "1 1/4 meters" and will run tests with RL. GDX worked VS7RA on 'phone for W.A.C. on 'phone. HXD and HWJ are new hams at Langley Field, both on 14 Mc. EVT added three new countries, making 130. APT is erecting a rhombic and an 8JK beam. EMX schedules HME on 1.75-Mc. 'phone daily. HXF ex-8KMH, at Hampton, is on 7 Mc. Welcome to Virginia, OM. UVA added ZD4AB, CE4AD and HH2MC for new countries.

Traffic: (Feb.-Mar.) W8HDG 783 GTS 206 ELN 186 HBH 24 BZE 15 HOY 9 AIJ 3 (Jan.-Feb.) HDQ 1221 ELN 184 GTS 137 BZE 21 HBH 20 EVT 8 HOY 4.

WEST VIRGINIA — SCM, C. S. Hoffmann, Jr. W8HD — OXO, the new Northern District R.M., received his 100th verification card, during the past month, and is the second in this Section to be a member of the DX Century Club! Congrats. "Tabel!" Emergency Coördinators' certificates endorsed for another year: CZ, Charleston District; BOK, Clarksburg and vicinity; MOL, Huntington District, New Coördinators: BWK, Ohio County; PNE, Logan District. GBF, and old timer is new O.R.S.! Mountaineer Amateur Radio Ass'n's Club Net on 3770 kc. has 19 members. The Club's safety program is in full swing. SUT moved to Fairmont. GEG schedules CLQ. KKG visited Wheeling. PSR moved to new location. MOL is putting up new antennas at new QTH. QFN's new loop is working FB. CFB is using '03A with 350-watts input. A nice letter was received from 3GCU, outlining developments on his Eastern Olw Net. O.R.S. interested will find it a worth-while project. OSO has been appointed the key station for this Section. CZ reports rapid progress being made for the Division Convention, to be held in Charleston during August. CDV, one of the Section's oldest O.R.S., got married! BOK reports going over to C.W.! The stork visited the S.C.M. March 20th, and left a YL. JKN has worked 57 countries.

Traffic: W8PSR 106 MOL 9 BOK 5.

ONTARIO DIVISION

ONTARIO — SCM, Fred H. B. Saxon, VE3SG — Ass't SCM — Dr. Donald R. Gunn, VE3EF — Interest in traffic handling is definitely on the increase. SF in particular is to be congratulated on his steady increase in traffic activities. Several new stations have joined the Ontario Nets, and we extend our welcome to VZ, ATR and AAY. The Maple Leaf and Beaver Nets (around 3762 kc.) will welcome newcomers to traffic ranks; if interested, drop a line to the Ass't S.C.M. ATR is new O.R.S. Ten members of the Royal Canadian Air Force Training Station at Trenton have formed a club and have been assigned the call AAY. Fort Francis has a new club; 56-Mc. work is one of chief activities at present. DX is running 90 watts to pair of '45's. The Intercity A.R.A. (London and St. Thomas) announces election of officers: NI, pres.; HI, vice-pres.; APL, secy.-treas. DD has Jr. op. Congrats! AXD received commercial ticket. GC, KC and HI continue active in London. NI and APL are rebuilding. Welcome to CB, who has been off for several years. Three active traffic stations in Hamilton: GZ, VZ and XR. KM lost antenna in big sleet storm. WO is back on. AFV rebuilt. AMI has new receiver. ALK gets out well on 14-Mc. 'phone. The West Side R.C. in Toronto reports APG new Secy. The club trophy, "The Foote," awarded for outstanding operating ability, goes to AGB. The club station is on the air every Mon. and Thurs. evening on 7-Mc. and 1.75-Mc. 'phone. HB is on at new QTH. VS has new superhet. AIB tried low power during DX contest with good results. AHV is getting out on 14-Mc. 'phone with new skywire. APO Q80'd Europe on 7 Mc. with 18 watts input. FB is on 14 Mc. running 250 watts to 100TH. AIP, AXG and AYO have been spending spare time on 56 Mc. AZI is new ham at Milford Bay in Muskoka. Welcome, OM. VL, ex-AHE, is on at Barrie. ADB has Jr. op. Congrats, OM. FG built new 250-watt rig for 14-Mc. 'phone and c.w. MB was visited by 2DU and visited UO.

★
A NATURAL
FOR AMATEURS

the new

BRUSH HEADPHONES

BJ Headphone — A brand new model featuring hermetically sealed headphones enclosed in rubber jackets permitting good ear seal. All rubber cord. List price \$12.00 per pair.

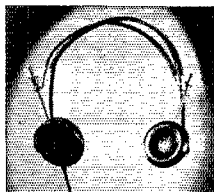

Model BJ

A-1 Headphone — Its high fidelity, wide range response and light weight make this instrument ideal for recording studios, speech correction and sound laboratories. Response is from 50 to 12,000 c.p.s. Complete with 5' cord, \$27.50 list.

Write for complete catalog

THE BRUSH DEVELOPMENT COMPANY
3320 Perkins Avenue Cleveland, Ohio



**ALWAYS
BE
CAREFUL**



★ ★ ★

(A) Kill all transmitter circuits completely before touching anything behind the panel.

(B) Never wear 'phones while working on the transmitter.

(C) Never pull test arcs from transmitter tank circuits.

(D) Don't shoot trouble in a transmitter when tired or sleepy.

(E) When working on the transmitter, avoid bodily contact with metal racks or frames, radiators, damp floors or other grounded objects.

(F) Keep one hand in your pocket.

(G) Develop your own safety technique. Take time to be careful.

★ ★ ★

Death Is Permanent!

I.A.R.U. News

(Continued from page 81)

of Lower California. The activities of the CRES are not confined strictly to radio transmission; however, due to the distance between the towns in which the amateurs live, this method of communication represents the only means of keeping the members informed of coming events. This club also devotes much time to educating the public as to the progress of amateur radio and its necessity in their civic life, and at the last commercial exposition held in Hermosillo the members of the CRES reserved a private booth in which were displayed the various types of equipment from the spark coil days to the modern crystal controlled transmitters.

The local organizations of the second district are too numerous to mention, but they are all identical in purpose and enthusiasm. In the state of Tamaulipas on the Gulf of Mexico the amateurs here form the northern terminus of the "Ruta del Golfo," of which we have spoken in a preceding paragraph, and whose headquarters are found in the cities of Ciudad Madero and Tampico. In the state of Coahuila two clubs are in ample evidence, one in Saltillo, the capital, and the other in Torreon, the famous railroad and agricultural center of that region. The states of Zacatecas, Durango, and Chihuahua as well as northern section of Lower California all have their contingent of radio enthusiasts, who have all banded together in local groups to further the interest of amateur transmission as well as to improve their own individual proficiency.

In spite of the large area which comprises the third district, there are comparatively few amateurs in these parts — very probably due to the nature of the terrain and the generally unfavorable climatic conditions. Oddly enough, however, the oldest and largest sectional organization in Mexico is represented by the only club in the

Are you **PLANNING**
or **WAITING** for a
better radio job?

- The difference between a future and "just a job" is **TECHNICAL TRAINING!**



E. H. Rietzke
CREI

Radio "pays off" on **ABILITY!** If you're not getting your share, just "look your job in the face" and see if you are making the most of it... or are qualified for a more important position. Radiomen like yourself can visualize the opportunities that lie ahead for trained engineers. The more complicated radio gets — the more improvements that are introduced — the more demand there will be for men with adequate, modern training.

SUCCESS IS NO ACCIDENT! The only difference between an \$1800 a year man and a \$4000 a year man is his ability gained through technical training. CREI can equip you to go ahead, as we are helping others. More than 275 stations employ CREI men — proof that our training in Practical Radio Engineering is recognized and approved by the industry. Write for details today.

- More money — better job —

Send for our free booklet!

CAPITOL RADIO
ENGINEERING INSTITUTE
Dept. Q-5

3224 16th St., N. W., Wash., D. C.



Thinking of Changes in Your RECEIVING EQUIPMENT?

INDEX

Receivers:

Antennas for.....	326
Antenna Tuning Units.....	138-139
Audio Limiter Circuits.....	137-138
Automatic Gain Control.....	124-125
Band Spreading.....	98-99, 144
Beat Oscillators.....	95-96, 117
Circuit Constants.....	98
Class-C Audio Amplifier.....	150

Construction:

1-Tube Regenerative Receiver.....	100-102
2-Tube Regenerative Receiver.....	102-106
4-Tube T.R.F. Autodyne.....	106-110
5-Tube Double-Regenerative Superhet.....	117-120
6-Tube Regenerative Single- Signal Super.....	121-124
8-Tube High-Performance Superhet.....	125-130
1-Tube Regenerative Pre-Selector.....	139-140
Electrical Noise Reduction.....	131-138
Frequency Converter Circuits.....	112-114
Heterotone Modulation.....	141-142
Input Circuits.....	111-112
Intermediate Frequency Amplifiers 95, 115-116,.....	120-121
Judging Receiver Performance.....	143-144
Limiting (Noise) Circuits.....	136-138
Noise Silencing.....	131-138
Oscillator Circuits.....	114-115
Portable.....	365-368
Power Supply.....	333-336
Pre-Selection.....	111-112
Protection from Transmitter.....	394
Quartz Crystal I.F. Filters.....	130-131
R.F. Amplifiers.....	106-107
Regenerative Detector Circuits.....	99-100
Regenerative I.F. Amplifiers.....	120-121
Second Detectors.....	95, 116-117
See-Saw Noise Silencer.....	136
Selectivity.....	96
Sensitivity.....	96-97, 143-144
Servicing Receivers.....	142-143
Shielding.....	99
Single-Signal Selectivity.....	120
Speaker Output Stage.....	106
Stability.....	96, 97, 114, 144
Superheterodyne Receivers, General.....	95, 110-111
Test Signal Generator.....	378-379
Tracking.....	114-115
Tuning Indicators.....	141
Tuning Systems.....	97-99
Ultra-High Frequency (see "Ultra-High Frequencies")	
Variable Selectivity.....	130-131

GET THE HANDBOOK

1939 Edition

tells the things which are needed for a comprehensive understanding of Amateur Radio. From the story of how Amateur Radio started through an outline of its wide scope of the present — from suggestions on how to learn the code through explanations of traffic handling procedure and good operating practices — from electrical and radio fundamentals through the design, construction, and operation of amateur equipment — this book covers the subject thoroughly. It includes the latest and the best information on everything in Amateur Radio.

American Radio Relay League, Inc.
West Hartford, Connecticut, U. S. A.

Gentlemen:

Please send THE RADIO AMATEUR'S HAND-

BOOK to

.....

.....

- Enclosed find \$1.00 continental U.S.A.
- Enclosed find \$1.25 elsewhere
- Send C.O.D.

(Spanish Edition — \$1.50)

CONVENIENT to EVERYWHERE

Here it is . . . HARVEY'S TRANSMITTER KIT for 15-Watt Crystal-Controlled FIVE-METER PHONE

A compact outfit for generating the stabilized signal required by the new regulations . . . designed and constructed by Glenn H. Pickett, W2IDV, and described fully in the March issue of QST, on page 48.

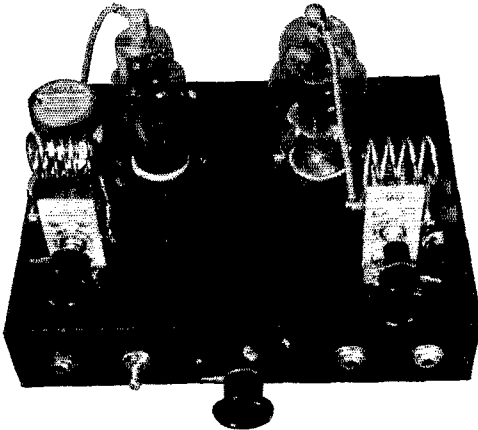

All units are supplied punched, drilled and mounted, ready for wiring. First grade parts from such leading manufacturers as National Company, I.R.C., United Transformer Corp., Cornell-Dubilier, etc.

MODULATOR, complete with tubes.....	\$19.85
RF UNIT, complete with tubes.....	18.70
POWER SUPPLY, complete with tube.....	14.40
BLILEY 10 METER CRYSTAL.....	5.75

See these units . . . as well as many others on display at our store . . . REMEMBER, we have a complete CAMERA DEPARTMENT and are ready to talk "trade-in."

W2KWY, W2LJA, W2BQL, W2IJL

OUR *Best* VALUE IS OUR RECORD OF LOYAL SERVICE

HARVEY

Radio Company of New York

103 WEST 43rd STREET • NEW YORK, N. Y.

CABLE ADDRESS: "HARADIO"

third district, the Club de Radio Experimentadores de Yucatan, the headquarters of which are located in the city of Merida, capital of the state of Yucatan, where once the civilization of the Mayas held sway. Members of the CREY operate the southern terminus of the "Ruta del Golfo," of inestimable value to the residents of the Yucatan peninsula due to the frequent cyclones which harass that area. As a whole, radio conditions are good even in this tropical country, and conversations between Yucatan and Cuba and Veracruz are just as common as QSO's between New York and Boston and Philadelphia.

For the amateur in the more remote regions of Mexico, it would indeed be difficult to keep abreast of the times if it were not for the continual efforts of the LMRE to assist him in every way. In addition to publishing the magazine *Onda Corta*, it operates the amateur station XE1CB, which has been granted by the federal government special permission for the transmission of radio news, courses in higher mathematics and electricity, technical aids for the experimenter, and general information of the type designed to foster the spirit of ham experimentation. Not content with this alone, the LMRE has established a modern academy for the radio instruction of those members who reside within the Federal District, maintains a modern thoroughly equipped library of volumes in all languages, and obtains for its members QSL cards at the lowest possible cost. The LMRE takes care of the necessary detail work in obtaining ham licenses for members who live away from Mexico City and who are unable to make personal applications, and likewise assists the amateur in every way possible whenever the latter inadvertently finds himself in difficulties with the federal commission. This consistent cooperation, which has increased steadily with the passing of the years, has created an "all for one and one for all" attitude which has left in its wake an extremely healthy atmosphere for those whose hobby is confined to the vicissitudes of radio communications.

★ NEW APPARATUS ★

New Exciter-Amplifier Kit

UNUSUAL physical design in the newest Hammarlund transmitter kit results in 150-watt transmitter in an extremely compact unit. This includes a band-switching fixed-tune exciter and a 150-watt beam-tetrode amplifier such as the RK-47 or 814 types. The exciter circuit is designed for 6L6's in each of the three capacity-coupled frequency-doubler stages as well as in the grid-plate oscillator.

Each stage is provided with a link, selected by one unit of a two-gang switch, for coupling to the final amplifier. The second unit of the switch opens the cathode circuits of all tubes not in use.

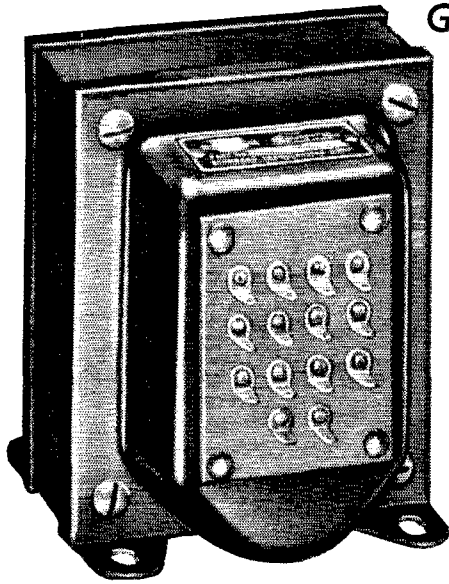

Greater Flexibility . . . Greater Value!

Announcing THE NEW POLY-PEDANCE

REG. U. S. PAT. OFFICE

TRANSFORMERS!

● To meet every need of the new tubes and new circuits, Stancor engineers have designed a clever new series of transformers . . . POLY-PEDANCE — two 15-watt and two 30-watt driver transformers, to match *all* present day driver circuit requirements. Six modulation transformers from 15 to 600 watts that will correctly match any modulator tubes to any R.F. load up to 21,000 ohms. And there are several other attractive units . . . all designed by Stancor's exacting Engineering Staff to give you new flexibility, new beauty and *NEW LOW PRICE!* Ask your distributor to show them or write for details.

STANDARD TRANSFORMER CORPORATION

1500 NORTH HALSTED STREET . . . CHICAGO

AMATEUR RADIO LICENSES

Day and Evening Classes in Code and Theory
HOME STUDY COURSES

*Reasonable, Efficient and Thorough, Hundreds of
Licensed Students Now on the Air*

American Radio Institute, 1123 Broadway, New York, N. Y.

Piezo-Electric Crystals Exclusively

- Quality crystals of all practical frequencies supplied SINCE 1925. Prices quoted upon receipt of your specifications.

Our Pledge: **QUALITY FIRST**

SCIENTIFIC RADIO SERVICE

"The Crystal Specialists Since 1925" University Park, Hyattsville, Md.

WE WELCOME YOU

To Our Shack . . . only two miles from
the New York **WORLD'S FAIR** Grounds

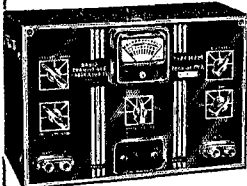

See our line of new, AP-
PROVED transmitters, etc.
Write for bulletins listing
complete specifications.

Type HFM Transmitter

- Six Bands 1715 — 60,000 K.C. on two crystals ● All Frequencies Crystal Controlled ● Instantly Changeable Mobile or Portable ● Final Tube Input 21 to 36 Watts.

Net to Amateurs. . . \$57.60

RADIO TRANSCEIVER LABS.

8627 115 Street Richmond Hill, New York City
Cable Address: "RATRALAB"



IN THE construction of transmitters from oscillator to final amplifier, metal fabrication plays an important part, both from the point of view of efficiency and appearance. Competition being what it is among hams, the time when "any-old-thing-will-do" is just a memory.

Today, chassis, cabinets, and panels, like those made by PAR-METAL, have reached such perfection in manufacture that you, as a progressive amateur, should investigate their wide application.

Finished in gray or black ripple, rounded corners, chrome trim, their living-room appearance has brought the boys "out of the basement."

Keep up with the times and send today for our new 1939 Catalog showing the many combinations possible with our products. It's well worth the trouble.

PAR-METAL PRODUCTS CORP.

3521-41st St., LONG ISLAND CITY, N. Y.

SOLAR
gives you **MORE** for your money

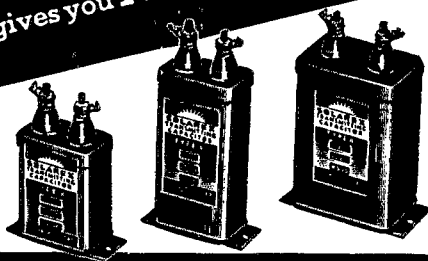

SOLAREX Oil Impregnated TRANSMITTING CAPACITORS

Catalog upon request

SOLAR MFG. CORP.,
599-601 BROADWAY, NEW YORK

Since the coupling between stages is not altered by the switching system, the tuning of each stage is not changed. Plug-in coils are used in the grid and plate circuits of the final amplifier. A second single-gang switch is provided for switching a milliammeter to the desired plate circuit.

The entire unit is assembled on a 4 by 4 by 17 inch chassis with the tubes and shielded tuned-circuit units of the exciter extending horizontally from the rear. All wiring is done inside the chassis. The beam-type final-amplifier tube with its associated grid and plate circuits is mounted on top of the chassis. The complete unit will mount on a standard rack panel only 10½ inches high. The controls extending to the panel are those for the band and meter switches and for the tuning controls for the output amplifier.

Individual parts, including ready-wound coils for the 28-, 14-, 7- and 3.5-Mc. bands, or a complete kit are obtainable.

New Electric-Razor Interference Filter

HAMS in general, and the DX gang in particular, will welcome the news that the J. W. Miller Co., 5917 South Main Street, Los Angeles, Calif., has at last brought out a really effective interference-eliminating filter for electric razors. Several tests have been made by the gang at headquarters and, in each case, the filter proved to be at least 90 per cent effective. It is made up in compact tubular form in a soft rubber enclosure, and is fitted with a plug at one end for a wall outlet and a receptacle at the other end for the razor-cord plug. It is reasonably priced at \$1.50 list.

New Safety Relay

WARD LEONARD has recently announced a new relay designed to guard against the danger from undischarged high-voltage filter condensers. The coil of the relay is connected in parallel with the 110-volt primary winding of the plate transformer so that the contacts open when the plate voltage is turned on. When the primary circuit is opened, the relay contacts close, short-circuiting the output of the filter through a heavy-duty 500-ohm resistance. The contacts are insulated for 2000 volts.

— D. H. M.

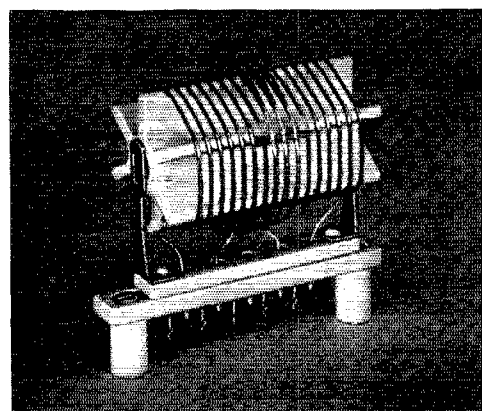

Coto

"PEE-WEE" INDUCTORS

ENUF SAID

LOOK 'EM OVER TODAY
THEY'RE GOING BIG

Mounting.....\$.36 Net
All Type Coils.....1.14 Net
Band Switch.....3.75 Net

RADIO



PRODUCTS

PROVIDENCE

RHODE ISLAND

STACO

Antenna

CHANGE-OVER RELAYS

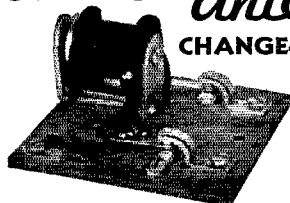

- Mycalex Insulation
- 4 Ampere Contacts
- Ball-Bearing Pivot
- Shorter R.F. Path
- No AC Chatter
- Floating Armature

Type ABA. XPLW Insulation, 110v. AC } \$3.00 net
Type ABD. XPLW Insulation, 6v. DC }
Type AMA. MYCALEX Insulation, 110v. AC } \$4.50 net
Type AMD. MYCALEX Insulation, 6v. DC }

See Your Jobber or Write for Details

STANDARD ELECTRICAL PRODUCTS COMPANY
316 Sibley Street St. Paul, Minnesota

• TELEGRAPHY—TELEVISION—TELEPHONY •

AVIATION
TRANS RADIO
PRESS
TELETYPE
TYPEWRITING

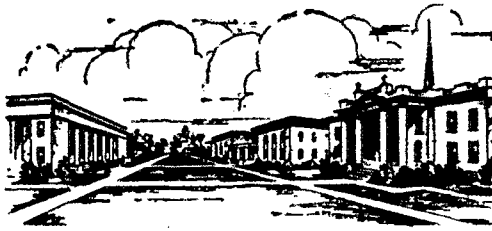

PRACTICAL
EXPERIENCE
STUDIO —
TRANSMITTER —
ANNOUNCING

The major technical training equipment owned by Port Arthur College and in operation on the college campus consists of the 500-Watt Commercial Broadcast Transmitter of Station KPAC, two-way Television Transmitter and Receiver, Latest Type RCA Marine and Airways transmitter installation complete, SOS Automatic Alarm, Marine Direction Finder, Trans-radio Press Receiving Equipment, and Laboratory complete where students assemble composite transmitters, amplifiers, audio amplifiers, R. F. amplifiers, etc.

Port Arthur College pioneered the teaching of Radio with classes in 1909, and for thirty years has maintained an active Employment Bureau for the placement of its graduates.

If interested in details about Radio Course, write for Bulletin R

PORT ARTHUR COLLEGE • **PORT ARTHUR** (World-Known Port), **TEXAS**

NOW! FOR LIMITED TIME ONLY

GENUINE **VIBROPLEX** LATEST MODEL
"LIGHTNING BUG"

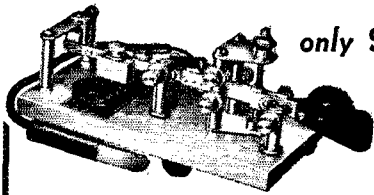

only **\$13.75**

Nickel-plated
\$2.00
Additional

Don't wait! Here's the opportunity to own this Great New, Easy-Action Vibroplex latest model at the lowest price in its history. Think of it! Only \$13.75 brings you this brand new Genuine Vibroplex that really eliminates tiring key work and makes sending easier and better for everyone. Write, telegraph or telephone your order today. This sensational low-price offer is limited and may be withdrawn without notice. Don't miss this chance to own "the BUG you've always wanted." **ACT NOW!** Money order or registered mail. Write for illustrated catalog.

THE VIBROPLEX CO., INC.
832 Broadway New York, N. Y.

JUNIOR
only **\$12.50**
Smaller and
more compact.
Complete in all
details

PRECISION CRYSTALS

Highest quality crystals carefully prepared for frequency stability and maximum output — rigidly tested to assure you of dependable operation. Be sure of your transmitter frequency — use

PRECISION CRYSTALS

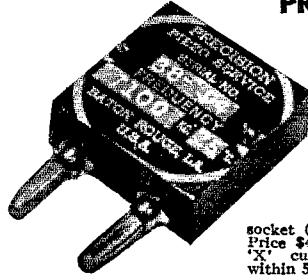

Low frequency drift unit supplied within 5 Kc. of your specified frequency in the 40, 80 or 160 meter bands calibrated to within .03%. Supplied in holder as illustrated to plug into G.R. type jacks or in round holder to plug into a tube socket (See Jan. issue Q37). Price \$4.00. Highest quality "X" cut crystals supplied within 5 Kc. of your specified frequency in the 40, 80 or 160 meter bands and calibrated to within .03% supplied mounted. Price \$3.50. Please state if holder as illustrated or round holder for tube socket is wanted.

Precision crystals for commercial requirements quoted on at your request. Now in our tenth year of business.

PRECISION PIEZO SERVICE

427 Asia Street

Baton Rouge, La.

A GOOD NAME GOES A LONG WAY

The Ken-Rad name has stood for many years for the finest and most technically advanced radio tubes. Ken-Rad Radio Tubes are dependable.



Ken-Rad Radio Tubes
KEN-RAD TUBE & LAMP CORPORATION - OWENSBORO, KY.
Manufacturers of all types of radio tubes and Ken-Rad Electric Lamp Bulbs

Below One Meter

(Continued from page 18)

oscillator the frequency may change slightly, and for that reason should be checked after the transmitter is supplying power to the antenna.

The Radiating Systems

One of the nice things about the work on 325 Mc. is the length — or rather the lack of length — of the transmitting antenna. The half-wave radiator is approximately 18 inches long. During the first part of the actual communication work we used the conventional half-wave vertical radiator fed from a pair of matched feeders. The background hiss in the receiver at W6ZA's location would drop about 80 per cent in volume when W6GPY's carrier was turned on, when GPY was using a half-wave radiator. A short while ago GPY finished building one of the Western Electric coaxial antennas recently described in *QST*.² The top of this antenna is located about 35 feet above ground and the coaxial line runs directly to the transmitter. The hiss in ZA's receiver now drops out entirely on GPY's carrier. Other indications also point to the fact that this antenna really works. The radiating end of the dipole antenna is shown in one of the photographs.

A three-element beam antenna is now in use at W6ZA's location and the results obtained indicate that this antenna is also very satisfactory. As in the case of the coaxial antenna, stronger signals were received as soon as the beam replaced the half-wave radiator. It is hardly neces-

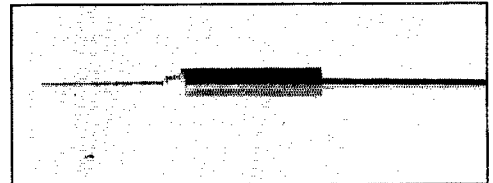

The coaxial antenna used at W6GPY. This type of antenna was described in a recent issue of *QST*.

sary to go into detail as to length of the elements of the antenna, spacing, and other variables except to say that the spacing of the feeders of the transmission line should not be greater than one inch, in order to reduce the possibility of radiation. At this particular installation, conventional feeder spreaders have been dispensed with, and stand-off insulators used in their place. It was deemed desirable to reduce the number of insulators to a minimum, and so rather long spans between insulators were used, with the wires pulled tight so that they will not touch when vibrating in a high wind. The total length between the antenna and transmitter at ZA's location is approximately 35 feet, and it is evident that the losses in a line this long are not excessively high.

We are also indebted to E. J. Dodge, W6NZG, C. S. Smith, Jr., W6LJG, and to D. L. Bigley, W6AEX, for their able help in making our tests.

² Long, "The Coaxial Vertical Radiator," *QST*, January, 1939.



COLUMBUS DISCOVERED AMERICA

Good ol' Columbus must have gotten a kick out of finding the other side —

Now's your chance to find TERMINAL's uptown store, since they've torn down the Sixth Avenue el! Without getting down on your hands and knees, just look east on 45th Street from Times Square — and you'll see TERMINAL's cheery sign beckoning to you!

We're in the clear now, way out front with everything in radio, at prices that defy competition!

And while you're at it, you'll discover TERMINAL's new complete Record Department!

TERMINAL Radio Corp.

68 West 45th St. • 80 Cortlandt St.
2 stores in NEW YORK CITY
Vanderbilt 6-5050 • Cable: TERMRADIO

HAVE YOU A LOG BOOK for Your Portable Operation?

The present log meets all requirements. You will find it better to have a separate log for your portable work.

35¢ Each, Three for \$1

THE AMERICAN RADIO RELAY LEAGUE
WEST HARTFORD, CONN.

*Want to make a
Good Investment?*

HINTS & KINKS

selling at 50c

Pays big dividends with its money saving ideas for the

WORKSHOP
RECEIVERS
TRANSMITTERS
PHONE UNITS
KEYING
MONITORS
METERS
POWER SUPPLIES
ANTENNAS
UHF

Invest 50c and save dollars

110 VOLTS AC Anytime, Anywhere! with **Katolight Plants**

Have special plant for operating radio receivers and transmitters. Close voltage regulation. Full 850 watts AC and 100 watts at 8 volts. Filtered and Shielded.

Amateur's price—JRA2, 350 watt \$66.00
Amateur's price—JRS5, 550 watt \$97.50

Other sizes up to 10,000 watts.
Both gasoline and Diesel.

KATOLIGHT, Mankato, Minn., U.S.A.



RADIO ENGINEERING



RCA Institutes offer an intensive course of high standard embracing all phases of Radio and Television, Practical training with modern equipment at New York and Chicago schools. Also specialized courses and Home Study Courses under "No obligation" plan.

Illustrated Catalog on request

RCA INSTITUTES, INC. Dept. ST-39

A Radio Corporation of America Service

75 Varick St., New York 1154 Merchandise Mart, Chicago

A Perfected AUTOMATIC SENDER

Patented
Postpaid **\$12.50**
in U. S. A.

Save your fist. Let the Automatic Sender raise your stations for you. Repeats calls or messages indefinitely. Length of messages practically unlimited. Sends from 2 to 70 words a minute. Motor driven. Entirely automatic. Built-in tape perforator. Absolute uniformity in spacing of characters.

\$13.50
West of
Denver

Speed up your receiving. Connect Automatic Sender with a buzzer or oscillator. Accustom yourself to receiving any speed you select up to 70 W.P.M. Makes excellent code teacher for novice. Complete with 6 rolls of tape and full instructions. No extra equipment needed. If your dealer can't supply, write us.

FULLY GUARANTEED

Gardiner-Levering Co. Haddon Heights
New Jersey, U. S. A.

NEW SHURE ROCKET DYNAMIC

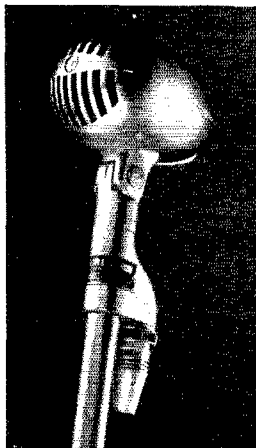

Moving-Conductor Type MICROPHONE

The smooth wide-range response of this new Shure "Rocket" sets a new quality standard for economically priced dynamic microphones. New construction employs the moving-conductor principle with associated acoustic network. Exceptionally rugged and immune to severe heat and humidity conditions. Handsomely streamlined; finished in satin chrome.

Model 50C-7 Ft. Dynamic. High impedance model, complete with 7 ft. cable. List Price... **\$26**

Both low and high impedance models with 25 ft. cable at \$27.50 list. *Shure Patents Pending*



(Continued from page 33)

the inception of the Canadian Broadcasting Commission.

He joined the C.B.C. when it was first formed, and his rise was rapid. In a short while he was made manager of the two Montreal stations of the system. Last July he received appointment as executive assistant to the assistant general manager of the corporation. This position he occupied at the time of his death.

John Stadler's amateur career was equally outstanding, and he had long been regarded as the leader of the VE2's. His station, VE2AP, was active and well known. He was founder and past-president of the Westmount Radio Club and past-president of the Montreal Amateur Radio Club. In 1937 he served the I.A.R.U. as co-delegate (with James J. Lamb) to the Bucarest C.C.I.R. Conference.

There he earned the praise of delegates from many nations, particularly those of the Dominion and the United States, for his energy, technical skill and tact. He has left the amateur body forever indebted to him for the successful representation of amateur interests at that conference.

Capt. Hervé St. Martin, in addition to his activity as VE2NI, was a northern aviator of considerable fame. After serving in the R.A.F. during the war, he pioneered in commercial air transport to the mining and hunting districts beyond the railroad lines. At his death at 42, he had carried the first air mail from Montreal to Toronto, served as aviation instructor and commercial pilot, and at the time of his death operated the St. Martin Air Transport Company with three ships and two pilots, of whom Therrien was one.

The tragic loss of these amateurs has been a great shock to all of Canadian amateur radio. VE2AP, in particular, was one of the best-known and most loved of all the amateurs in Canada, and had an important voice in the delineation of amateur policies there in recent years. He typified the highest type of amateur. His influence and judgment as well as his presence will be sadly missed.

OHMITE BAND-SWITCH

For Stations up to 1 K.W.

Here's instant, easy, flick-of-the-wrist band switching for rigs up to 1 K.W., with really low-loss efficiency. With these Ohmite Band-Change-Switches band changing may be provided in all stages of the transmitter and "ganged" for complete front-of-panel control. Ample size for heavy duty. Ohmite all-porcelain vitreous enamel construction insures long dependable service.

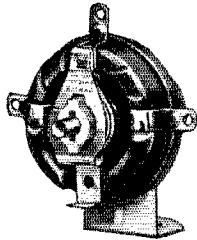

Ask Your Jobber or Write Today for Catalog 17.

OHMITE MANUFACTURING CO.
4864 Flournoy St., Chicago, Ill., U. S. A.

Be Right with OHMITE
RHEOSTATS • RESISTORS • TAP SWITCHES

Your Inquiries Invited

When you need amateur equipment it is to your advantage to write to me. You get personal attention; 6% terms financed by myself so you buy with less cost and more convenience; fair trade-in value for your equipment; ten day trial of all receivers; and my cooperation in every way to see that you are 100% satisfied. For any equipment, the latest information and technical help, write to W9ARA.

Compare My Terms with Others

Model and Receiver	Cash Price	Down 12 Monthly Payments	12 Monthly Payments
The new SX-23.....	\$115.50	\$23.10	\$8.16
RME-70.....	138.60	27.72	9.79
HQ-120X and NC101X....	129.00	25.80	9.11
NC100A.....	120.00	24.00	8.48
NC80X and NC81X.....	99.00	19.80	6.99
Bretling 49 and S16.....	99.00	19.80	6.99
Howard 438.....	49.95	9.99	3.53
NC-44 and S-20.....	49.50	9.90	3.49

Also HRO, Bretling 9, Howards, Sargents, all others

Similar terms on Hallicrafters, National, Harvey, RCA, RME, Temco transmitters and Thordarson, National, U.T.C., Utah, Kits.

Bob Henry

W9ARA

BUTLER

MISSOURI

CLARITY IS EXCEPTIONAL IN THE TIBBETTS

MONOBAR-CRYSTAL MICROPHONE

You are assured of crisp clear speech when you use this modern instrument. And there has been no sacrifice of output to attain this goal — in fact it is way up. Recent improvements have pushed the output to over .2 volt at four inches speaking distance — no need of speaking any closer. Order direct now, and save. Complete with base \$10.45 cash in U. S. A. Write for booklet. Terms if desired

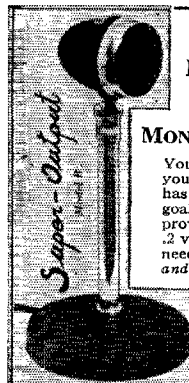

TIBBETTS' LABORATORIES
CAMDEN, MAINE

There's more fun in CW when you're CANDLER-TRAINED

Don't miss the real pleasure in CW because you can't take fast code! Write Candler—let him prove to you that fast code is easy to learn the Candler way! A few weeks of Candler training is equivalent to months of un-directed practice. You learn the proper fundamentals, mental coordination and sound consciousness, and in a short time you'll be reading code as easily as you read the printed page. Thousands upon thousands of operators, commercial and amateur alike, thank Candler for their code skill, operators like T. R. McElroy, World's Record Holder and other speed artists.



Anybody can learn code the Candler way! Whether you're a beginner or advanced student, write Candler today. Get the FREE "Book of Facts" that tells you how the Candler System operates! Double your fun on the air!

CANDLER SYSTEM CO.

Box 331, Dept. Q-5 — Asheville, No. Carolina, U. S. A.
British Address: Rm. 56, Craven House,
121 Kingsway, London, W.C.2

QSL Cards

Individual QSL Cards printed as you want them, at reasonable prices.

Samples gladly submitted on request.

HINDS & EDGARTON, INC., W 9 W R
19 South Wells Street, Chicago, Illinois Ex. W9APY

LEARN RADIO • TELEVISION

60-page catalog on request. Oldest, largest and best equipped in New England.

MASS. RADIO SCHOOL

18 Boylston Street Boston, Mass.

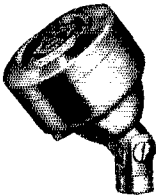

D6T DYNAMIC Microphone

A Sturdy, Multi-use, Quality Microphone, with Higher Output and advantageous Directivity Characteristics.

Output level -46, usable range 30-7000 cps.

D6T, High Imp., \$27.50 D6, Low Imp., \$25.00
including Cable

General catalogue describes other attractive models
Request copy

AMERICAN MICROPHONE CO., INC.
Los Angeles, California

The MOST for YOUR MONEY

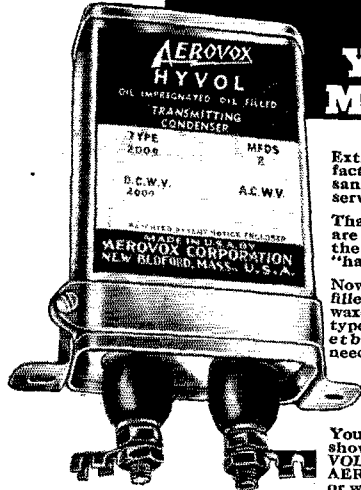

Extra-generous safety factor means thousands of hours of extra service.

That's why HVOLs are provably cheaper in the long run. Ask the "hams" who use them.

Now available in oil-filled (heavy-duty) and wax-filled (average duty) types to fit your pocketbook and service needs.

Ask . . .

Your local jobber to show you these HVOLs. Ask for latest AEROVOX catalog — or write us direct.

Oil-impregnated section; welded steel can; oil- or wax-filled; high-tension pillar terminals; adjustable mounting bracket. Both are same physical appearance and size — real quality at your price.



HERE IT IS . . . HAMS

A New A.C. and D.C.
Pocket Volt-Ohm-
Milliammeter

with Ranges to 5000 Volts
— Self-contained.

\$14.50
Net Price

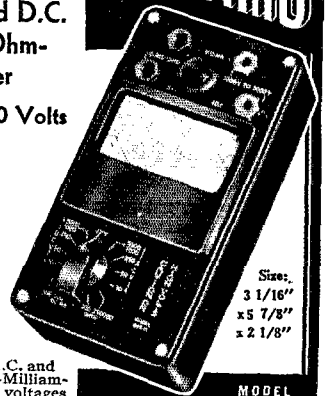

Size:
3 1/16"
x 5 7/8"
x 2 1/8"

MODEL
666-H

Will handle all
Amateur Requirements

Now a new Triplet A.C. and D.C. Pocket Volt-Ohm-Milliammeter that will handle voltages to 5000 volts without external multipliers. It will check the high voltages and circuits of transmitters and receivers — just the instrument for amateur use.

Ranges: AC-DC Voltage at 1000 Ohms per volt 0-10-50-250-1000-5000; D.C. Milliamperes 0-10-100-500; Resistance 0-300 shunt type 10 ohm reading at center scale; 0-250,000 series type, 3700 ohms at center scale.

Model 666 — uses same case as 666-H. . . Reads to 1000 volts at 1000 ohms per volt. . . Net Price. \$14.00

Write for Catalog!

THE TRIPLET ELECTRICAL INSTRUMENT CO.
Section 255 Harmon Ave., Bluffton, Ohio

Buy Your NEW EQUIPMENT from DELAWARE RADIO

	<i>Down payment and 12 monthly Net Cash payments only</i>	
NC-44 Complete	\$ 49.50	\$ 4.01
NC-80X or 81X Complete	99.00	8.08
NC101X Complete	129.00	10.55
NC100XA Complete	142.50	11.70
HRO. 4 coils and tubes	179.70	14.65
NC-510 Complete	150.00	12.23
Super Pro SP-110 Complete	243.00	19.81
HQ 120X	129.00	10.55
RME-69 Complete	152.88	12.47
RME-70 Complete	138.60	11.30
Sky Buddy S-19	29.50	...
Sky Champion S-20	49.50	4.04
Skyrider Marine S-22	64.50	5.26
Skyrider 5-10 S-21	69.50	5.67
Sky Challenger II S-18	77.00	6.28
Super Skyrider S-16	99.00	8.08
Skyrider SX-23 Complete with speaker	127.50	10.50
Super Skyrider S-17	125.50	10.24
Skyrider Diversity DD-I	300.00	24.47
Bretting 9 Complete	54.00	4.41
Bretting 49 Complete	99.00	8.08
Patterson PR-15 Complete	133.50	10.89
Howard 430 Complete	29.95	...
Howard 438 Complete	49.95	4.10
Howard 440 with tubes	66.50	5.43
Howard 450-A with tubes	87.70	7.14
Howard 450-A with tubes, crystal and speaker	105.45	8.60
Sargent Streamliner 39	33.90	...
Sargent 51-AK	157.00	13.00

Special terms on RCA, Temco, Harvey, Hallicrafters, Thordarson, Utah, Stancor Kits and Transmitters.

Time payments also available on parts orders over \$25.00 net.

SEND US ITEMIZED LIST OF YOUR NEEDS FOR QUOTATIONS

All Prices and Terms Subject to Change without Notice. All Material Shipped F. O. B. Wilmington or Manufacturer. No Time Payment Sales Outside U. S. A.

DELAWARE RADIO SALES COMPANY

WILLARD S. WILSON — W3DQ
405 Delaware Avenue
WILMINGTON, DELAWARE
Established 1920

★ A.R.R.L. QSL BUREAU ★

For the convenience of its members, the League maintains a QSL-card forwarding system which operates through volunteer "District QSL Managers" in each of the nine United States and five Canadian districts. In order to secure such foreign cards as may be received for you, send your district manager a standard No. 10 stamped envelope. If you have reason to expect a considerable number of cards, put on an extra stamp so that it has a total of six-cents postage. Your own name and address go in the customary place on the face, and your station call should be printed prominently in the upper left-hand corner.

- W1 — J. T. Steiger, W1BGY, 35 Call Street, Willimansett, Mass.
- W2 — H. W. Yahnel, W2SN, Lake Ave., Helmetta, N. J.
- W3 — Maurice Downs, W3WU, 1311 Sheridan St., N. W., Washington, D. C.
- W4 — G. W. Hoke, W4DYB, 328 Mell Ave., N. E., Atlanta, Ga.
- W5 — E. H. Treadaway, W5DKR, 2749 Myrtle St., New Orleans, La.
- W6 — Horace Greer, W6TI, 414 Fairmount Ave., Oakland, Calif.
- W7 — Frank E. Pratt, W7DXZ, 5023 So. Ferry St., Tacoma, Wash.
- W8 — F. W. Allen, W8GER, 324 Richmond Ave., Dayton, Ohio.
- W9 — Alva A. Smith, W9DMA, 238 East Main St., Caledonia, Minn.
- VE1 — L. J. Fader, VE1FQ, 125 Henry St., Halifax, N. S.
- VE2 — C. W. Skarstedt, VE2DR, 236 Elm Ave., Westmount, P. Q.
- VE3 — Bert Knowles, VE3QB, Lanark, Ont.
- VE4 — George Behrends, VE4RO, 186 Oakdean Blvd., St. James, Winnipeg, Manitoba.
- VE5 — H. R. Hough, VE5HR, 1785 First St., Victoria, B. C.
- K4 — F. McCown, K4RJ, Family Court 7, San-ture, Puerto Rico.
- K5 — Norman F. Miller, K5AF, 15th Air Base Squadron, Albrook Field, Canal Zone.
- K6 — James F. Pa, K6LBH, 1416D Lunalilo St., Honolulu, T. H.
- K7 — Jerry McKinley, K7GSC, Box 1533, Juneau, Alaska.
- KA — George L. Rickard, KA1GR, P. O. Box 849, Manila, P. I.

Strays

In connection with the danger which develops when the bleeder resistance burns out, Edward Huffman of Barberton, Ohio, suggests the use of two bleeder resistances in parallel, each of twice the resistance and half the wattage rating of the usual bleeder resistance.

Attend the National Radio Parts Trade Show

1939 **JUNE** 1939

WED.-THU	FRI	SATURDAY
14-15	16	17
JOBBER'S	SERVICEMEN	SPECIAL DAY for AMATEURS

Stevens Hotel, Chicago

2- or 3-ELEMENT ROTARY BEAM

IF YOU ARE BUILDING YOUR OWN

Use the New Type **GENERAL** ELEMENTS

Extreme Tapered — Double Plated — Smooth Surface

JT-10...\$1.62 **JT-20...\$2.99**

See Your Distributor

GENERAL ROTARY ANTENNA CO., Coral Gables, Florida

SICKLES COILS

SECURE A COPY OF OUR NO. 939
CATALOG FROM YOUR JOBBER

F. W. SICKLES COMPANY

300 Main Street

Springfield, Mass.

ONAN ELECTRIC PLANTS

Supply the "JUICE"
WHEN POWER LINES FAIL

OVER 40 MODELS — 350 TO 50,000 WATTS

COMPLETE — READY TO RUN
HUNDREDS OF ONAN ELECTRIC PLANTS serve Amateur and Commercial operators. When Power Lines fail and Communication is needed most, they supply Power for Lights and Radios — Save Property and even Lives.

Portable — Dependable — Economical
Thousands in use in all parts of the World. Highest Quality Materials — Modern Design. 110 and 220 Volt A.C. — 12, 32 and 110 Volt D.C. and Dual Voltage Generators. Manual, Self-Starting and Full Automatic Starting Types. Write for Details.

D. W. ONAN & SONS, 344 Royalston Av., Minneapolis, Minn.

CORNELL-DUBILIER

StarHit

OF THE MONTH

TYPE
86



FEATURES OF TYPE 86

- Patented Series Mica Stack — Eliminates corona losses.
- Horizontal Stack Construction — Wide separation of leads; maximum insulation.
- Soldered Foils — Affords high current rating.
- Mica Separators — Each section carefully insulated.
- India Ruby Mica Dielectric — Lower power factor; high Q.
- Vacuum Impregnated Assembly — Low loss; high insulation; no air voids.
- Special Low Loss Filler — Reduces stray losses.
- Short Heavy Brass Stud Terminals — Low resistance connection.
- Black Glazed Porcelain Dehydrated Case — Low R.F. losses.

For a complete listing of the entire CORNELL-DUBILIER line, send for Catalog No. 165A, FREE ON REQUEST.

MICA ● PAPER ● DYKANOL ● WET AND DRY ELECTROLYTICS



CORNELL-DUBILIER ELECTRIC CORPORATION

1011 Hamilton Blvd., So. Plainfield, N.J.

Cable Address: "CORDU"

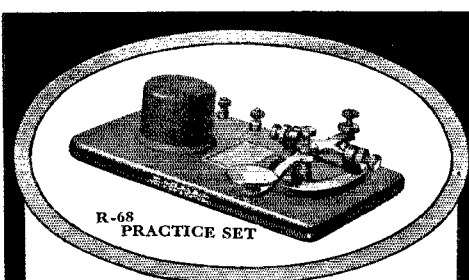

R-68
PRACTICE SET

WIRELESS PRACTICE SETS

Designed for those who want a well made instrument to learn the code. Set consists of a key and high frequency buzzer mounted on a mahogany finished wood base equipped with binding posts. The code is printed on a plate and fastened to the base between the key and buzzer. Buzzer is adjustable. List \$3.40.

SIGNAL's line of Wireless Keys, Telegraph Instruments and Wireless Practice Sets is complete. Send for bulletin.

SIGNAL ELECTRIC MFG. CO.

Menominee, Michigan U. S. A.

SIGNAL

MANUFACTURERS OF ELECTRICAL PRODUCTS

"IT CUTS DOWN CURRENT"

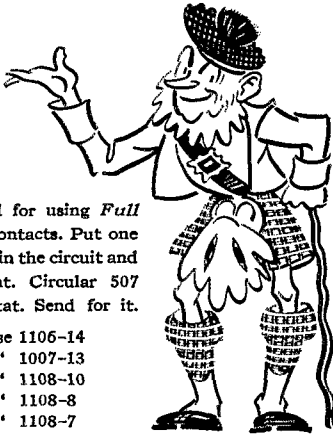
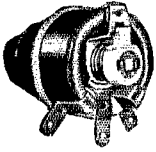

There is no need for using Full Power on local contacts. Put one of these rheostats in the circuit and cut down current. Circular 507 shows this rheostat. Send for it.

50 watt use	1106-14
100 " "	1007-13
250 " "	1108-10
400 " "	1108-8
500 " "	1108-7

|| WARD LEONARD || RADIO SPECIALTIES ||

WARD LEONARD ELECTRIC COMPANY

41 South St., Mount Vernon, N. Y.

Please send FREE Bulletin 507

Name

Street

City and State

Call Signal

EASY TO LEARN CODE

It is easy and pleasant work to learn the modern way — with an Instructograph Code Teacher. Ideal for the beginner or advanced student. ■ Many tapes available ranging from alphabet for beginners to typical messages on all subjects. Speed range 5 to 40 WPM. ■ Always ready, no QRM, beats having someone send to you.

FOR SALE OR RENT

STANDARD with 10 tapes and book of instructions \$20.25

JUNIOR with 5 tapes and book of instructions (not rented) \$12.00

RENTAL Standard with 10 tapes and book of instructions \$3.00 first month, \$2.25 each additional month. (De-post or references required.)

Write for details today

INSTRUCTOGRAPH COMPANY

Dept. Q-5, 912 Lakeside Place, Chicago, Illinois

Representatives for Canada:

Radio College of Canada, 863 Bay Street, Toronto

NEW

Valpey Type VO1 Crystal Oven

Constant temperature with exact frequency operation is now available without the purchase of a complete holder and oven.

Your present mounted crystal, if designed to plug into a tube socket and is not over 1 3/8" in diameter, and 1 3/8" high, including pins, will mount in this new crystal oven.

The oven plugs into a five prong tube socket and requires from 6 to 8 volts for operation.

Temperature is held constant to one degree centigrade. The oven is designed for use with Police, Airplane, or Amateur crystal units.

Net Price \$3.95

THE VALPEY CRYSTALS

Box 321

Holliston, Mass.

1939 Dog Fight

(Continued from page 15)

ple, there's W4BMR, sitting pretty as you please with 94,230 points, W8NJP with 93,104, W4CDG with 92,638, and W3EOZ with 90,000. Still more high 'phone scores include W8KML, 86,856; W4BPD, 85,000; W9ARA, 79,572; W4DRZ, 61,636; W1HKK, 60,250 (he made WAC S9-plus three times during the week's work); W9DKU, 58,275; W1ADM, 58,000; W6AM, 57,054; W3FQP, 55,000; W1DQ, 51,000; W4EQK, 50,775 *; W5ASG, 44,496; W2IUW, 44,070. (These, of course, aren't all the high 'phone scores — they've just started to come in.)

Only foreign score we have at present is CO2JJ, who ran up 65,043 points.

Post Mortem

Oh, sure, there was some out-of-band operation this year, but it was a lot less than the previous two years and has almost dropped out of the picture. The fellows that like to crowd the edges have found that frequency-measuring equipment is a nice thing to have, and they no longer depend on the other fellow's guess of what the edge is. There were a number of complaints of some of the unsporting tricks pulled by the variable-frequency gang, but it seems to us that, aside from the fact that the W loses face with his friends, it's largely up to the DX stations to curb this unnecessary evil. They can do it easily enough by refusing to work any W's that break into a QSO before it's finished and, once the word gets around, the practice should die a natural, if somewhat lingering, death. In case it doesn't, we'll set out some rat poison. —W1JPE

* W4AKA and W4EHX, operators.

Skyrotor... is the answer

Skyrotor will support and turn your present beam antenna or can be purchased with antenna kit for beams as large as 3-element 20-meter.

Includes split-phase motor, reversing switch, accurate direction indicator, and mercury-ring feed system.

Speed is 1 1/2 rpm in either direction. Continuous rotation.

Write for profusely illustrated catalog showing complete mechanical and electrical details.

Amateur parts stock available. Mail orders given careful attention. Bill Blake, W8PQF

RADIO PARTS, Inc.

7663 Grand River Avenue
Detroit, Michigan

Where to buy it

A directory of suppliers who carry in stock the products of these dependable manufacturers.



ALBANY, N. Y. Uncle Dave's Radio Shack 356 Broadway
 ATLANTA, GEORGIA Wholesale Radio Service Co., Inc. 265 Peachtree Street
 BOSTON, MASS. Radio Shack 46 Brattle Street
 BOSTON, MASS. Wholesale Radio Service Company, Inc. 110 Federal Street
 BRONX, N. Y. Wholesale Radio Service Company, Inc. 542 East Fordham Rd.
 BUTLER, MISSOURI Henry Radio Shop 211-215 N. Main Street
 CHICAGO, ILL. Allied Radio Corp. 833 W. Jackson Blvd.
 CHICAGO, ILL. Wholesale Radio Service Company, Inc. 901-911 W. Jackson Blvd.
 CINCINNATI, OHIO United Radio, Inc. 1103 Vine Street
 COLUMBUS, OHIO Bell Radio Parts Co. 203 N. Fourth St.
 DETROIT, MICH. Radio Specialties Co. 325 E. Jefferson Ave.
 DETROIT, MICHIGAN Radio Specialties Co. 11800 Woodward Ave.
 HARTFORD, CONNECTICUT Radio Inspection Service Company 227 Asylum Street
 HOUSTON, TEXAS R. C. Hall & L. F. Hall 4021 Huey Street
 JAMAICA, L. I. Wholesale Radio Service Company, Inc. 90-08 166th Street
 KANSAS CITY, MO. Burstein-Applebee Company 1012 McGee Street
 NEW ORLEANS, LA. Shuler Supply Company 902 Poydras Street
 NEW YORK, N. Y. Harrison Radio Co. 12 West Broadway
 NEW YORK, N. Y. Wholesale Radio Service Co., Inc. 100 Sixth Ave.
 NEWARK, N. J. Wholesale Radio Service Co., Inc. 219 Central Ave.
 OAKLAND, CAL. Offenbach's 2085 Broadway
 READING, PENN. George D. Barbey Company 404 Walnut St.
 SACRAMENTO, CAL. Offenbach's 1310 K Street
 SAN FRANCISCO, CAL. Offenbach's 1452 Market Street
 SPRINGFIELD, MASS. T. F. Cushing 349 Worthington St.
 WASHINGTON, D. C. Sun Radio & Service Supply Co. 938 F Street, N. W.

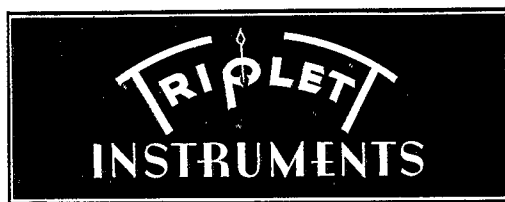

ALBANY, N. Y. Uncle Dave's Radio Shack 356 Broadway
 ATLANTA, GEORGIA Garvin Electric Company 69 Forsyth Street, N. W.
 ATLANTA, GEORGIA Wholesale Radio Service Company 265 Peachtree Street
 BOSTON, MASS. Radio Shack 46 Brattle Street
 BOSTON, MASS. Wholesale Radio Service Company, Inc. 110 Federal Street
 BRONX, N. Y. Wholesale Radio Service Company, Inc. 542 East Fordham Rd.
 BUTLER, MISSOURI Henry Radio Shop 211-215 N. Main Street
 CHICAGO, ILLINOIS Allied Radio Corp. 833 W. Jackson Blvd.
 CHICAGO, ILLINOIS Electric & Radio Supply Co., Inc. 25 North Franklin Street
 CHICAGO, ILL. Wholesale Radio Service Company, Inc. 901-911 W. Jackson Blvd.
 CINCINNATI, OHIO United Radio, Inc. 1103 Vine Street
 JAMAICA, L. I. Wholesale Radio Service Company, Inc. 90-08 166th Street
 LITTLE ROCK, ARKANSAS Beem Radio Company 409 W. 3rd St.
 MINNEAPOLIS, MINNESOTA Lew Bonn Company 1124-26 Harmon Place
 MONTREAL, CANADA Canadian Electrical Supply Co., Ltd. 285 Craig Street, West
 MUSKOGEE, OKLAHOMA Home Radio Mart 204 No. Twelfth Street
 NEW ORLEANS, LA. Shuler Supply Company 902 Poydras Street
 NEW YORK, N. Y. Wholesale Radio Service Company 100 Sixth Avenue
 NEWARK, N. J. Wholesale Radio Service Company 219 Central Ave.
 OAKLAND, CAL. Offenbach's 2085 Broadway
 READING, PENN. George D. Barbey Co. 404 Walnut Street
 SACRAMENTO, CAL. Offenbach's 1310 K Street
 SAN FRANCISCO, CAL. Offenbach's 1452 Market Street
 WASHINGTON, D. C. Sun Radio & Service Supply Co. 938 F Street, N. W.

Listings on this page do not necessarily imply endorsement by QST of the dealers or of other equipment sold by them.

NINTH ALL-SECTION SWEEPSTAKES CONTEST SCORES, 1938

(Scores are grouped by Divisions and Sections. . . . The operator of the station first-listed in each Section is winner for that Section. . . . Asterisks denote stations not entered in contest, reporting to assure that stations they worked get credit. . . . The number of sections and number of stations worked by each participant are given following the score. . . . Likewise the "power factor" used in computing points in each score is indicated by the letter A or B. . . . A indicates power up to and including 100 watts (multiplier of 1.25), B indicates over 100 watts (multiplier of 1), AB indicates operation in both power groups. . . . The total operating time to the nearest hour is given for each station and is the last figure following the score. . . . Example of listings: W3BES 84001-67-502-A-40, or, Final Score 84001, number of sections 67, number of stations 502, power factor of 1.25, total operating time 40 hours. . . .)

(See April QST, page 53, for preliminary write-up of S.S. results.)

ATLANTIC DIVISION

<i>E. Pennsylvania</i>		W3HFO	2469-25-40	A-11	
W3BES	84001-67-502	A-40	W3AKB	2340-18-52	A-10
W3ENX	70560-64-443	A-40	W3LAP	2003-23-47	B-15
W3CHH	69601-63-445	A-40	W3FWH	1815-22-33	A-10
W3OKC	60795-63-389	A-40	W3BUI	1512-21-36	B-1
W3FLY	56583-61-373	A-39	W3HGE	1418-14-41	A-12
W3ATR	56050-50-380	A-40	W3RHE	1293-10-27	A-9
W3FRY	55275-66-345	A-40	W3HTS	1275-17-30	A-6
W3GHM	49335-66-290	A-39	W3BNS	1260-18-35	A-10
W3EWE	46183-58-310	A-30	W3GHW	863-15-23	A-7
W3DGM	44219-48-360	A-40	W3DXT	860-15-35	A-10
W3GTY	40119-49-328	A-40	W3HXC	578-11-22	A-6
W3FLH	38690-53-292	A-40	W3GFC	540-8-28	A-9
W3EML	37500-48-314	A-40	W3CTT	513-10-21	A-5
W3EDC	36138-49-295	A-38	W3EPI	84-6-7	B-1
W3ADE	34808-63-221	A-39	W3DZX	52-4-7	B-1
W3KTT	34556-57-245	A-36	<i>Phone</i>		
W3BGD	34050-60-227	A-27	W3FFG	820-16-21	A-12
W3EFH	34031-45-305	A-40	W3DRQ	612-17-18	B-10
W3ALB	29228-54-218	A-26	W3BRZ	72-6-6	B-3
W2AOC	29150-53-220	A-33	<i>Md.-Del.-D.C.</i>		
W3GDI	25851-60-246	AB-37	W3DUK	78809-67-471	A-38
W3GHD	25294-57-179	A-31	W3EJU	51225-60-345	A-40
W3GET	22800-21-190	A-36	W3GUA	48669-65-301	A-37
W3GJY	22468-43-209	A-36	W3FPQ	43710-62-354	B-38
W3GYV	22310-46-194	A-38	W3BQT	34905-52-269	A-1
W3DMQ	20475-35-235	A-31	W3GYQ	32250-60-215	A-38
W3DGC	17550-39-180	A-32	W3EAX	29547-63-238	B-33*
W3EWR	17200-40-172	A-37	W3EHW	17135-46-151	A-16
W3FZX	16313-45-145	A-32	W3DRD	16800-44-141	A-35
W3GCF	14963-35-171	A-37	W3GMG	16640-52-160	A-29
W3AGV	11790-36-133	A-20	W3FSP	16538-45-147	A-31
W3FCQ	10560-44-120	B-24	W3XCL	14976-64-117	B-1*
W3CNP	10370-34-122	A-15	W3EJL	10664-43-125	B-1
W3GYY	8450-26-132	A-28	W3BDL	8621-37-118	B-22
W3GAG	8120-29-112	A-14	W3CDG	4882-31-63	A-14
W3CQQ	7712-32-122	B-23	W3HQU	4060-28-58	A-31
W3GKO	7508-26-116	A-15	W3AKR	3360-28-50	A-22
W3FYW	7388-30-100	A-38	W3HDV	3358-30-47	A-24
W3HLZ	7085-26-111	A-35	W3FNG	3220-29-47	A-8
W3GEG	7053-26-109	A-11	W3FNK	1601-21-31	A-10
W3GPG	6815-29-94	A-24	W3HZZ	1560-16-42	A-17
W3FDA	6660-36-74	A-17	W3HBE	1238-15-33	A-8
W3DPI	6138-25-103	A-29	W3HCC	1155-14-33	A-7
W3FXG	6018-29-83	A-16	W3HJP	918-18-26	A-11
W3C8N	5960-32-76	A-20	W3HOP	439-9-21	A-7
W3GQW	5850-30-79	A-20	W3GVE	312-6-26	B-9
W3OML	5785-26-89	A-13	W3HLQ	105-6-7	A-6
W3GFL	5583-29-78	A-23	W3DRR	88-5-7	A-6
W3HLL	5261-23-75	A-16	W3HUP	49-3-8	B-4
W3B8H	5110-28-75	B-6	<i>So. New Jersey</i>		
W3DVE	5095-26-102	A-10	W3GZH	43400-60-328	A-40
W3RRR	4790-28-85	B-25	W3FAX	43807-67-268	A-40
W3CVR	4440-30-74	B-20	W3GMY	37583-62-242	A-40
W3HRD	3888-24-55	B-20	W3AWH	21863-55-160	A-34
W3GIX	3623-23-63	A-8	W3BDL	18240-38-192	A-33
W8RZA	3025-22-57	A-1			

W3CBR	17159-37-187	A-39	W8OLI	4095-28-59	A-17
W3GHR	14705-44-135	A-31	W8DNX	3942-27-73	B-11
W3EGC	12480-42-136	A-36	W8OMR	3920-35-58	B-23
W3GHF	12600-35-144	A-34	W8FUW	3875-31-50	A-9
W3HGS	11378-41-114	A-36	W8RBH	3825-30-51	A-9
W3BPD	10122-42-132	B-1	W8RIT	3421-23-62	A-21
W3BEE	9720-37-139	AB-28	W8SMX	3355-22-61	A-22
W3HLY	9063-29-125	A-22	W8NCJ	2800-14-80	A-10
W3FBT	8239-39-85	A-28	W8GYR*	1971-27-37	B-10
W3DAS	7896-42-94	B-22	W8HKU	1736-17-41	A-14
W3ZT	5288-30-71	A-10	W8LOR	1606-22-37	B-14
W3DEA	4872-29-85	B-15	W8OST	1216-19-34	B-9
W3GSR	2400-24-41	A-9	W8QGU	770-14-22	A-9
W3HDK	2070-23-36	A-6	W8RUI	680-17-20	B-17
W3HAZ	1827-17-43	A-11	W8HWK	350-10-15	A-6
W3AEJ	1820-26-35	B-9	W8KXF*	10-2-2	A-1
W3GCU	115-18-27	A-8	<i>None</i>		
W3PDF*	699-13-43	A-9	W8KBJ	2550-30-43	B-18
W3HSL	513-10-22	A-6	W8ROA	1544-19-58	A-32
W3ACU	325-10-13	A-3	W8OCR	660-15-22	---
W3CXA	12-2-4	---	W8CRQ*	18-3-3	---
W3GEO*	8-2-2	---			

Hudson Division Eastern New York

W3FNR	280-7-20	B-3	W2EWD	32800-52-259	A-39
W3FNN	35-2-7	A-6	W2SZ	30420-60-255	B-40*
W3AXU	18-2-4	A-1	W2KXF	21178-43-197	A-34
W3AWH	5-1-2	A-1	W2HAN	17899-43-166	A-27
<i>Western New York</i>			W2KNR	16575-39-170	A-28
W8JTT	56605-68-334	A-30	W2JRG	13513-47-115	A-29
W8DOD	54019-67-325	A-37	W2GTW	9303-34-111	A-20
W8ADV	43028-62-347	B-40*	W2FGQ	9188-35-105	A-14
W8SEV	31493-57-221	A-40*	W2ISJ	9013-35-103	B-20
W8AQC	25145-47-214	A-38	W2AOF	8619-39-111	B-21
W8DZC	24900-60-208	B-35	W2KWI	8573-27-127	A-18
W8KAT	24750-55-180	A-25	W2LOR	1935-18-43	A-20
W8QKM	21313-50-171	A-35	W2HYR*	330-11-12	A-4
W8PFF	17280-54-128	A-32	W2BJQ	297-11-27	B-3
W8MKA	15600-48-311	A-19	W2LLU	81-5-6	A-2
W8ELP	15375-41-150	A-21*	W2JTT*	75-5-7	A-1
W8FYH	13694-35-157	B-29	W2BLU	23-3-3	A-1
W8QCH	10639-39-100	A-29	W2KPH	18-3-3	B-1
W8DHT	10331-29-143	A-24	<i>Phone</i>		
W8QUN	8219-25-133	A-29	W2FGQ	23-3-3	A-1
W8QXA	7896-42-95	B-22	<i>N. Y. C. & L. I.</i>		
W8QUC	7080-30-120	B-1	W2IOP	71998-62-482	A-37
W8QXB	6713-30-90	A-31	W2HMJ	65000-65-400	A-39
W8OQU	4804-21-96	A-4	W2APT	52910-65-407	B-34
W8CNH	4250-34-63	B-14	W2BWC	38570-56-281	A-40
W8QB	3400-34-40	A-23	W2AIS	35630-56-255	A-37
W8RRS	2389-21-46	A-14	W2IRV	32118-58-233	A-39
W8MNV	2340-26-37	A-13	W2KJY	30250-55-222	A-31
W8SEI	2100-16-53	A-17	W2KMS	28080-48-234	A-34
W8JQE	1084-17-26	A-8	W2CWE	2700-52-267	B-39
W8OQC	1040-16-26	A-10	W2KKR	25415-46-222	A-39
W8AOR	919-15-25	A-7	W2CQU	24510-57-215	B-38
W8RQB	629-17-18	B-10	W2HYA	22910-58-158	A-34
W8QHX	492-12-21	B-6	W2ION	22828-46-200	A-35
W8QCY	425-10-17	A-1	W2AHC	22680-63-180	B-33
W8HQY	324-12-14	B-4	W2KTR	22485-49-272	AB-20
W8CO	198-9-11	B-1	W2EGG	21436-46-233	B-37
W8EJY*	90-4-9	A-5	W2KKU	18755-44-172	A-28
W8BLH	75-4-8	A-3	W2HUG	18285-46-161	A-36
W8BHK*	50-5-5	---	W2DXL	16618-46-147	A-40
W8QZ*	32-4-4	B-5	W2HYA	16129-51-127	A-37
<i>W. Pennsylvania</i>			W2GTL	12060-36-134	A-30
W8I2S	26966-51-212	A-35	W2FCQ	11520-48-120	B-31
W8HSN	24735-51-197	A-36*	W2AOD	10412-38-138	B-32
W8YA*	19800-55-180	B-21*	W2LKE	10114-31-132	A-28
W8IYI	19610-53-186	B-38	W2PKW	8785-28-126	A-25
W8OIX	18900-40-189	A-33	W2LJF	8488-35-97	A-1
W8JSU	16215-47-138	A-32	W2GFP	8001-29-111	A-25
W8GON	14798-49-151	B-40	W2GXS	7875-35-100	A-22
W8QNG	13230-49-108	A-38	W2LFL	7440-30-125	B-25
W8JMP	12240-45-136	B-30	W2AJL	5813-30-78	A-16
W8SJP	10560-40-133	B-29	W2CRQ	5363-31-88	B-17
W8SVP	10140-48-87	A-36	W2LFD	4970-28-71	A-11
W8NUG	9975-42-95	A-24	W2FKM	4905-28-73	A-29
W8NTS	8629-39-89	A-16	W2HBO	4225-26-78	A-15
W8QCK	7790-41-79	A-30	W2JVK	3855-18-80	A-13
W8MJD	7070-28-10	A-25	W2KFC	3575-28-50	A-9
W8RAP	6843-33-89	A-30*	W2LBI	1803-14-52	A-21
W8ZU	5400-32-68	A-25	W2DUA	1625-13-50	A-15
W8RWJ	3285-28-76	A-32	W2KXB	1598-18-36	A-12

¹ Philadelphia Wireless Assn., Geo. A. Hooper opr. ² Lafayette College Radio Club, score of opr. Tom Ross; opr. Vincent Golden made 21 contacts. ³ Radio Society, Univ. of Md., three ops. ⁴ W3RBE, W3FQZ, W3BHW. ⁵ W3HNF (ex-31ML) opr. ⁶ Two ops. W8ADY 10368, W8KBS 1625. ⁷ Two ops. W8SSB, W8RZP. ⁸ W5EMW opr. ⁹ Two ops. W8H8N, W8EGU. ¹⁰ Two ops. R. P. Hunter, C. S. Snyder. ¹¹ Two ops. W8RAP, W8RVR. ¹² Two ops. W9UDA, W9ZHM. ¹³ Hamfesters Radio Club, W9MHD opr. ¹⁴ W9ZSB opr. ¹⁵ Purdue Univ., ten ops. W9TWC 2592, W7BRU, W9OZS, W9SDC, W9MEX, W8ALG, W2DNE, W9VFA, P. J. Freed, A. C. Weed. ¹⁶ Two ops. W8AYB, W9ZRG. ¹⁷ Two ops. W8OYL, W8KAY. ¹⁸ Two ops. W9USI, W9USH. ¹⁹ Two ops. Conrad E. & Reider Garbelsion. ²⁰ R. P. L. Radio Club, eight ops. W2INC, W2LFD, W2KEN, W2CFZ, W2EBA, W2PEP, W8RME, W9KHG. ²¹ Two ops. Alex & Steve Ekblad. ²² Kans. State College Radio Club, W9AHR, opr. ²³ W9COE, opr. ²⁴ Trinity College Radio Club, two ops. W1LLA, W1GKM. ²⁵ 30 pts. by second opr. W1DDP. ²⁶ Hqs. staff members, not eligible for awards. ²⁷ W1JTD opr. ²⁸ W1LQZ opr. ²⁹ Two ops. W1LLX, W1CBN. ³⁰ W2JJC opr. ³¹ Two ops. W7FFA, W7EHU. ³² Two ops. W6LVB 19014, W6LDJ 17433. ³³ Opr. W7MIF. ³⁴ N. C. State College Radio Club, W4ESQ opr. ³⁵ Clearwater Radio Club, two ops. W4AKA 13068, W4EFP 4600. ³⁶ Georgia Tech. Radio Club, nine ops. W4DXI 20406, W4EFT 50, W2KVV 198, W4AKJ 180, W4AJJ 32, W4FZB 8, W4BRD 18, W4BAM 32, E. M. Burnett 8. ³⁷ Three ops. W5DGM, W5GQC, W5GWB. ³⁸ Four ops. W5B8N, W5B8Z, W5BOY, J. W. Roby. ³⁹ Three ops. VE3LR, VE3AGB, VE3ATD. ⁴⁰ Three ops. VE3APO, VE3ATK, VE3VB. ⁴¹ Two ops., A. E. Howe 1926, J. K. Holland 694.

W2JEN 1575-18-35- A-12
 W2EC 1360-16-34- A-3
 W2ICO 1280-16-32- A-4
 W2LOQ 1125-14-36- A-31
 W2GUP 600-12-25- B-7
 W2JGF 480-12-16- A-2
 W2LPZ 263-7-15- A-8
 W2FNI 90-6-6- A-1
 W2FTT* 90-6-6- A-2
 W2QR* 80-4-10- - - -
 W2LNN 50-4-5- A-8
 W2KOH 30-3-4- A-8
 W2IN 10-2-2- A-1
 W2APZ* 3-2-2- - - -
 W2KDS 2-1-1- B- - -
 Phone
 W2CHK 1350-18-31- A-5
 W2JZX 168-8-11- B-3
 W2IOK 84-6-8- B-3
 W2JGD 3-1-1- - - -
 W2KZS 2-1-1- - - -

No. New Jersey

W2GSA 65100-62-420- A-39
 W2HTY 57010-62-368- A-29
 W2JKH 44840-59-304- A-40
 W2PY 30088-53-295- A-39
 W2JJE 36600-60-246- A-38
 W2HNT 32754-53-311- B-30
 W2CW 30278-53-231- A-40
 W2LAO 24875-47-210- A-37
 W2GSG 23800-59-160- A-35
 W2JSS 21744-49-178- A-41
 W2ZDA 21963-54-158- A-41
 W2ECO 13440-42-160- B-30
 W2JVD 13365-36-150- A-24
 W2JUU 12113-34-143- A-24
 W2JUC 10165-28-160- A-30
 W2JRU 9500-38-100- A-24
 W2DSV 6386-31-103- B-13
 W2DBY* 6336-36-88- B-13
 W2LKH 4133-29-59- A-12
 W2CFW 3835-26-59- A-24
 W2FDL 3510-24-60- A-25
 W2HHY 3504-24-76- B-11
 W2EWM 3420-24-57- A-4
 W2LFB 3308-21-63- A-4
 W2IB 3120-30-52- B-18
 W2JSE 2000-20-40- A-12
 W2HZE 1971-27-70- B-15
 W2GKE 1849-17-44- A-24
 W2BUC 1654-21-32- A-14
 W2ADS 1650-22-31- A-8
 W2JYJ 1496-22-35- B-22
 W2WC 1375-22-25- A-6
 W2CJX* 1215-18-27- A-1
 W2GNW 928-14-29- A-15
 W2GTA 538-10-22- A-34
 W2ASY 438-10-19- A-4
 W2HRN 350-10-14- A-4
 W2LMN 350-10-14- A-4
 W2LBG 263-7-15- A-12
 W2LJR 235-12-12- A-1
 W2JVP 168-8-11- B-4
 W2LND 75-5-6- A-1
 W2AER* 18-3-3- - - -
 W2HCO 8-2-2- - - -
 W2HMF* 2-1-1- - - -
 Phone
 W2JWJ 17820-54-168- B-35
 W2JUV* 688-16-22- B-5
 W2JV 416-13-16- B-6

New England Division

Connecticut
 W1KQY 46116-63-368- B-40
 W1BIB 2754-51-217- A-40
 W1DOV 27300-56-195- A-38
 W1HED 25724-39-220- B-38
 W1ACV 25373-51-190- A-40
 W1AMQ 20325-49-170- A-27
 W1GMB 18143-41-177- A-24
 W1JBI 17568-47-150- A-21
 W1JUD 10920-42-104- A-23
 W1CPL 10200-32-128- A-34
 W1JJR 8745-33-107- A-34
 W1IMP 8555-29-151- B-32
 W1GVK 7630-35-109- B-27
 W1EAO 6908-38-83- B-17
 W1BHM 6201-39-81- B-18
 W1HYP 5992-28-107- B-27
 W1KIO 5775-28-83- A-25
 W1KKS 5460-21-104- A-20
 W1FTI 5386-31-70- A-11
 W1KQD 3278-23-58- A-21
 W1JHM 3000-20-75- B-21
 W1JBK 2418-26-47- B-9
 W1CTI 1056-14-30- A-4
 W1LOU 893-14-26- A-14

W1JYW 358-14-26- A-9
 W1LAL 23-3-3- A-1
 W1LQK 23-3-3- A-8
 W1DWK 18-3-3- B-2
 W1LHJ 8-2-2- A-1
 W1TS 62531-69-363- A-40²⁵
 W1AW 60192-66-458- B-35²⁵⁻²⁶
 W1JPE 25110-62-162- A-19²⁵
 W1JFN 200-8-10- A-1²⁵
 W1BDT* 18-3-3- B-1²⁵
 Phone
 W1AW 171-9-10- B-1²⁵⁻²⁶
 Maine
 W1KFE 33480-65-300- B-38²⁷
 W1BFA 22313-53-212- B-36
 W1ASG 12390-42-150- B-34
 W1BJY 10413-39-134- B- -
 W1LHA 6418-34-77- A-31
 W1DDH 2185-23-49- B-16
 W1LMQ 1169-17-28- A-13
 W1FAP* 160-8-8- A-1
 W1KRK 2-1-1- - - -
 Phone
 W1ACK 6665-43-63- A-38

E. Massachusetts

W1RY 51188-63-327- A-38
 W1RVJ 28520-62-185- A-38
 W1ICA 25518-59-173- A-30
 W1IGN 23100-40-221- A-32
 W1IQH 18681-35-216- A-40
 W1IWE 17640-42-168- A-30
 W1JEA 16512-57-140- B-30
 W1ILD 14875-35-170- A-25
 W1BSG 14835-46-129- A-34
 W1JOX 14040-32-181- A-36
 W1KCK 13488-48-146- B-31
 W1JXU 8621-33-107- A-25
 W1LEA 8600-32-108- A-40
 W1JZN 7725-30-106- A-29
 W1JBY 7306-35-84- A-27
 W1JYB 7020-39-78- A-21
 W1JFX 6758-34-82- A-25
 W1KMS 6143-27-91- A-34
 W1BDU 5338-35-61- A-29
 W1DMG 4500-24-74- A-19
 W1LLX 4270-35-62- B-28
 W1KLY 4000-25-65- A-20
 W1KSO 3531-25-61- A-1
 W1IGA 3480-24-58- A-10
 W1LBY 3150-21-60- A-8
 W1JBO 2875-23-64- B-25
 W1EMG 2640-24-44- A-7
 W1BSM 2531-27-40- A-14
 W1ALB 2280-24-38- A-16
 W1KNU 2252-17-53- A-15
 W1KCO 2125-25-34- A-12
 W1KCV 2114-19-45- A-15
 W1ALG 2100-20-42- A-8
 W1IQO 1850-20-40- A-22
 W1HXE 1729-19-46- B-10
 W1LGC 1575-21-30- A-20
 W1WPG 1425-15-38- A-18
 W1LLA 1373-19-29- A-4
 W1IDU* 1080-18-25- A-6
 W1CTE 960-12-40- B-10
 W1KBO 956-15-26- A-20
 W1HY 344-11-13- A-5
 W1EPP 338-9-15- A-1
 W1IHZ* 325-10-13- A-1
 W1BYF 260-10-13- - - -
 W1GIZ 260-8-13- A-1
 W1LES 225-9-10- A-1
 W1LGG 225-6-15- A-5
 W1LBT 200-8-10- A-9
 W1LTO 175-7-10- A-5
 W1FKS 18-3-3- B-1
 W1BF 2-1-1- - - -

W. Massachusetts

W1EOB 45903-61-302- A-36
 W1FNY 20188-38-213- A-34
 W1AUN 18170-46-159- A-40
 W1KZS 13550-40-136- A-40
 W1KJO 12071-29-167- A-32
 W1BIV 11020-38-145- B-31
 W1KIK 10455-41-102- A-20
 W1FKI 7020-27-130- B-32
 W1HRY 6240-32-79- A-26
 W1BKQ 4170-24-70- A-13
 W1JXN 3120-26-50- A-10
 W1BDV 2380-17-56- A-17
 W1AJ 1748-23-38- B-8
 W1BPN 1523-21-29- A-8
 W1LHY 813-13-25- A-8
 W1LFB* 340-8-17- A-10
 W1KVN 230-8-12- A-5
 W1KIT 10-2-2- A-1

W1LX 2-1-1- - - -
 Phone
 W1BDV 10-2-2- A-4
 New Hampshire
 W1BFT 44545-59-302- A-38
 W1AWU 21738-37-235- A-32
 W1FTJ 15161-39-156- A-29
 W1HTO 12192-32-194- B-31
 W1KIN 10585-29-146- A-25
 W1P 4725-27-70- A-10
 W1FGC 3960-24-67- B-19
 W1GEY 3750-25-60- A-15
 W1EAL 3000-24-63- B-14
 W1JCA 1828-17-43- A-9
 W1KLD 1386-21-33- B-12
 W1DCH 900-15-24- A-5
 W1HGV 715-13-22- A-12
 W1HFO 688-11-25- A-5
 W1LIN 120-6-8- A-6
 W1GNZ 30-3-4- A-8
 W1GCS 32-4-4- - - -
 W1HXJ 15-2-3- A-3
 Phone
 W1IJB 4125-22-75- A-24
 W1IUV 2900-29-50- B-11
 W1KLD 3-1-1- A-1

Rhode Island

W1BBN 26779-61-221- B-39
 W1GBO 24544-52-236- B-30
 W1LAB 15962-46-175- B-34
 W1AOP 13475-49-140- B-38
 W1KRQ 13325-41-131- A-39
 W1CPV 13017-39-135- A-33
 W1KYK 12835-34-151- A-30
 W1KWA 12045-33-146- A-26
 W1LDL 6518-33-79- A-22
 W1KRF 2308-26-54- B- -
 W1KOG 562-15-30- A-1
 W1LCO 536-11-20- A-12

Vermont

W1KTB 13015-46-124- A-33
 W1KXY 8250-33-100- A-30
 W1KIE 3525-20-71- A-13
 W1JVS 1848-24-39- B- -
 W1KOO 1068-14-31- A-13
 W1KZJ 88-5-7- A-1

Roanoke Division

North Carolina
 W1DW 32671-59-222- A-31
 W1TO 14168-44-161- B-14
 W1CFE 13995-45-157- B-26
 W1FIC 12450-40-125- A-23
 W1ACA 5662-38-76- B-21
 W1FBD 3623-23-63- A-11
 W1BVD 3072-32-48- B- -
 W1AEL 1188-19-25- A-7
 W1ATC 480-12-16- A-4²⁵
 W1CRW 275-11-13- B- -
 W1FKY* 3-1-1- A- - -
 Phone
 W1CDG 10176-53-97- B-25
 W1TS 585-15-20- B-4
 W1DPF 23-3-3- A-2
 W1AAK* 1-1-1- - - -
South Carolina
 W1CZA 7387-32-99-AB-26
 W1ECC* 2-1-1- - - -
 Phone
 W1BQE 5719-43-67- B-21

Virginia

W1PMY 41856-64-328- B-34
 W1AAV 37121-57-262- A-40
 W1GKL 34257-57-304- B-33
 W1FBL 24745-49-254- B-34
 W1RQO 12012-52-116- B-34
 W1GKB 7028-45-92- A-21
 W1CYV 6055-35-87- B- -
 W1GWQ 5775-35-66- A-26
 W1GWP 5040-32-63- A-13
 W1EQQ 4459-29-65- A-20
 W1CFI 4125-33-52- A-19
 W1GJP 2880-24-48- A-16
 W13EJ 2400-30-40- B-7
 W1HLLW 1000-16-25- A-6
 W13FI 1320-22-31- B-11
 W13LLW 35-4-4- A-1

West Virginia

W1LCN 33280-64-261- B-36
 W1OXO 32025-60-217- A-34
 W1PSR 28304-59-193- A-35

W1JJA 26376-56-236- B-39
 W1PMA 21164-52-208- B-33
 W1RCN 16938-50-136- A-39
 W1BTV 14300-55-104- A-24
 W1NVT 8190-42-78- A-32
 W1MTP 6808-37-98- B-28
 W1BJM 2048-21-40- A-14
 W1RUO 1875-20-38- A-18
 W1BBH 1615-19-34- A-12
 W1P8N/8 1069-19-23- A-13
 W1MZT 1-1-1- - - -

Delta Division

Arkansas
 W1FJL 19845-49-164- A-37
 Phone
 W1FPD 72-6-7- - - -

Louisiana

W1SK 69680-67-416- A-38
 W1SWC 49181-65-305- A-40
 W1SDA 26040-56-233- B-36
 W1SFY 9130-38-100- A-18
 W1GLH 8190-36-93- A-27
 W1GBB 5231-30-72- A-26
 W1SDW 2944-32-46- B- -
 W1SEU 2801-27-42- A-18
 W1LLH 19-3-3- A-3
 Phone
 W1CXH 16110-45-180- B-33
 W1BQD 3864-28-70- B-23

Mississippi

W1SAV 32118-58-227- A-35
 W1GEA 25565-55-212- B-37
 W1FTT 713-15-20- A-15

Tennessee

W1PL 32760-63-260- B-35
 W1FCU 17238-51-172- B-28
 W1DDJ 1113-21-27- B-8
 W1PCF 715-13-22- A- -

Central Division

Ohio

W1FON 66430-65-514- B-40
 W1JBN 65423-66-399- A-39
 W1AAB 37188-66-291- B-39²⁵
 W1KVV 33408-64-261- B-29
 W1SLV 31248-58-217- A-38
 W1BOY 31080-56-222- A-33²⁵
 W1SOE 30181-61-246- AB-31
 W1AIR 29000-58-200- A-40
 W1PML 26600-56-190- A-28
 W1BMCQ 25665-58-179- A-34
 W1BAN 25520-58-221- B-31
 W1RGL 21810-56-200- B-36
 W1RZY 19270-47-161- A-37
 W1LCO 19080-53-146- A-26
 W1RNO 18050-42-173- A-36
 W1RRH 15225-42-145- A-28
 W1RDX 15015-39-158- A-35
 W1CED 13664-56-123- B-21
 W1SIE 13444-45-121- A-32
 W1LCW 12330-36-139- A-34
 W1QXM 11200-40-140- B- -
 W1BMY 10600-53-100- B-24
 W1DAE 10076-44-117- B-25
 W1RQK 9245-43-87- A-37
 W1BYM* 7750-50-62- A- -
 W1LAW 7290-33-96- A-17
 W1SAV 6825-39-70- A-12
 W1MQC 6150-50-62- B-10
 W1JHM 6006-33-91- B-6
 W1BBA 5735-37-66- A-17
 W1KZO 4410-28-63- A-17
 W1LQM 4354-27-65- A-27
 W1RBN 3548-26-53- A-19
 W1LAG 3150-24-55- A-12
 W1RFD 3115-29-45- A-10
 W1RPG 3069-28-52- B- -
 W1SD 2929-28-51- B- -
 W1RGR 2610-29-45- B-18
 W1SWE 2563-25-41- A-8
 W1SKE 2118-22-40- A-10
 W1SBE 1733-21-33- A-5
 W1SOT 1686-19-36- A-11
 W1SLOF 1650-22-30- A-6
 W1SPBX 1197-21-29- B-5
 W1SHFN 300-16-20- A-7
 W1SBI 672-16-21- B-8
 W1SPMS 600-12-20- A-5
 W1RET 484-11-23- - - -
 W1RRUR* 224-8-14- - - -
 W1SOM 150-8-8- A-3
 W1SAG 105-7-8- B-3
 W1SDWT 80-4-8- A- -
 W1SDBU 72-6-6- - - -
 W1SFT 12-2-3- - - -

BEST BY EVERY TEST THE NEW IMPROVED Premax Vertical Radiators

- NEW! High-Tensile Copper-Nickle Steel Tubing
- NEW! Positive Band Clamp—No Set-Screws
- NEW! Bright Cadmium Finish
- NEW! Low Price

20-Meter \$16⁹⁵

Complete with heavy duty Lapp Compression Insulator tested to 10,000 pounds.

Premax Verticals are fully telescoping and easily adjustable to any desired height—easy to handle—easy to mount—no guys required for any ordinary conditions.

10 Meter also Available at \$7.50

Write for NEW Premax Technical Booklet covering Verticals, Rotary Beams, Hi-Q Antennas—the complete authoritative manual on erection, feeding, adjustment.

The only complete line of Rotary and Vertical Beams and Elements.

Premax Products

Division of Chisholm-Ryder Co., Inc.
3919 HIGHLAND, NIAGARA FALLS, N. Y.



Twenty-Five Years Ago

(Continued from page 11)

which the amateur can reach distant points by wireless and without getting into difficulties with the United States Government. It is expected that messages will be received and transmitted by courtesy entirely and that no money will be involved in any way, the effort being to keep the plan strictly amateur in every sense."

In these modest terms was the forming of the A.R.R.L. reported to the wireless enthusiasts of the time. Occasional notes in subsequent issues recorded the progress of the organization; it was not until the end of the following year that *QST* made its appearance.

Browsing through the early radio magazines is a fascinating—and enlightening—pastime. For instance, in the May, 1914, issue of the same publication there is an article by E. E. Butcher (*How to Conduct a Radio Club*) describing, of all things, link coupling for both receiving and transmitting circuits. The claims for the system have a very familiar ring to them. As for adjustment, we quote: "It may seem at first thought that considerable increase of signals could be expected if the linking circuit"—note the name—"contained a greater number of turns about each coil, and he is apt to try it in this manner; if he does he will meet with defeat. The patents on this circuit state specifically that the 'link' should contain a few turns of inductance, very low resistance and zero capacity. These are the only conditions under which it will work properly and effect the purpose for which it was designed. Experiments with a greater number of turns are useless. In fact fair signals can be secured when the loop consists of a single turn of wire about coils A and B" (the tuned circuit coils). Applications to crystal and audion receivers and to a rotary-spark transmitter are illustrated. The patents mentioned, by the way, were issued in 1911.

So you think working Asians from New England is something comparatively new? Well, the May, 1914, *Wireless Age* records a QSO between the Marconi station at Boston (guaranteed range 300 miles) and the S.S. *Mongolia*, whose position at the time was 200 miles east of Nagasaki. The Boston operator was Harry Cheetham, still actively engaged in radio work in the vicinity. The experts of the day were consulted and unanimously pronounced it a freak. Said one authority, "If the station tried to get that distance again they could not do it. But still they might." Hi!

The thing that gave us a chuckle, though, was this extract: "It is a known fact that conditions on the Pacific Ocean are especially conducive to long-distance wireless transmission. Given distances may be covered with much less power than it is necessary to use on the Atlantic coast. The New England coast, however, is notoriously detrimental to the transmission of wireless telegraph signals, this condition being attributed to the underlying rocky soil." Easterners still have an abiding faith in that statement!

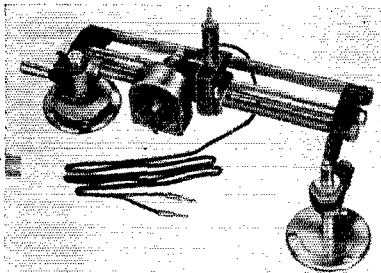

Build Your Own Recorder
With This New Sensational

REK-O-KUT RECORDING MECHANISM

Never before has the amateur been in a position to construct his own recorder at a cost well within his budget.

REK-O-KUT does the trick. It will operate with any good motor and turntable plus your own amplifier. Consists of a spindle and worm gear, driven at the center of the turntable, feed screw, cutting head mounting and cutting head. Operates with as little as 2 watts driving power from amplifier at either 78 or 33 1/4 R.P.M. Cutter impedance of 8 ohms matches secondary of output transformer.

NET TO AMATEURS..... \$29.55

See it at your local distributor or write to

REK-O-KUT CORPORATION

254 CANAL STREET NEW YORK, N. Y.
Export Division—458 Broadway—New York, U. S. A.
Cable address: Morhanex

HAM-ADS

(1) Advertising shall pertain to radio and shall be of nature of interest to radio amateurs or experimenters in their pursuit of the art.

(2) No display of any character will be accepted, nor can any special typographical arrangement, such as all or part capital letters be used which would tend to make one advertisement stand out from the others.

(3) The Ham-Ad rate is 15¢ per word, except as noted in paragraph (6) below.

(4) Remittance in full must accompany copy. No cash or contract discount or agency commission will be allowed.

(5) Closing date for Ham-Ads is the 25th of the second month preceding publication date.

(6) A special rate of 7¢ per word will apply to advertising which, in our judgment, is obviously non-commercial in nature and is placed and signed by a member of the American Radio Relay League. Thus, advertising of bona fide surplus equipment owned, used and for sale by an individual or apparatus offered for exchange or advertising inquiring for special equipment, if by a member of the American Radio Relay League takes the 7¢ rate. An attempt to deal in apparatus in quantity for profit, even if by an individual, is commercial and all advertising by him takes the 15¢ rate. Provisions of paragraphs (1), (2), (4) and (5) apply to all advertising in this column regardless of which rate may apply.

Having made no investigation of the advertisers in the classified columns, the publishers of *QST* are unable to vouch for their integrity or for the grade or character of the products advertised.

QUARTZ — direct importers from Brazil of best quality pure quartz suitable for making piezo-electric crystals. Diamond Drill Carbon Co., 719 World Bldg., New York City.

RADIO engineering, broadcasting, aviation and police radio, servicing, marine and Morse telegraphy taught thoroughly. All expenses low. Catalog free. Dodge's Institute, Byrd St., Valparaiso, Ind.

USED receivers. Bargains. Cash only. No trades. Price list 3¢. W3DQ, Wilmington, Del.

QSL'S, all colors, cartoons, snappy service. Write for free samples today. W1BEF, 16 Stockbridge Ave., Lowell, Mass.

CALLBOOKS — Spring edition now on sale containing complete up-to-date list of radio hams throughout entire world. Also world prefix map, press schedules and new time conversion chart. Single copies \$1.25. Canada and foreign \$1.35. Radio Amateur Call Book, 610 S. Dearborn, Chicago.

QSL'S. Cuts. Cartoons. Free samples. Theodore Porcher, 7708 Navahoe, Philadelphia, Pa.

IPS rubber circuit, QSY remotely, varies completely 160 to 10 meters. Approximately 30 watts output, \$19.90. Radio Apparatus Mfg., 1622 No. Clark, Chicago. W9IPS.

CRYSTALS, mounted, 80-160 \$1.25, V-cut 40 \$2.25. R9 Crystals, 338 Murray Ave., Arnold, Pa.

QSL'S. Free samples. Printer, Corwith, Iowa.

MACAUTO code machines: low monthly rental 50,000 words practice tapes. Write N. C. Ayers, 711 Boylston St., Boston, Mass.

QSL'S, SWL's. 100 — 3 color — 75¢. Lapco, 344 W. 39th, Indianapolis, Ind.

FREE catalog. Order direct or from dealers. 160-80 meter Y crystals, 75¢. Faberadio, Batavia, Ill.

DANGER high voltage signs, neat, impressive. Two for a dime. Coin only. Gallagher, 700 Franklin St., Elizabeth, N. J.

SELL W8MAH complete station. For description write W8AVK.

QSL'S as you want them. Radio Printer, Union, N. Y.

CRYSTALS — unconditionally guaranteed, X-out, 1750-2000; 3500-4000; = 20 kc., \$1.; = 5 kc., \$1.50; spot frequency, \$2.50. Three small, X-out, 80 meter blanks, including carborundum \$1.45. Holders, \$1. William Threm, W8FN, 3071 Moosewood St., Cincinnati, Ohio.

QSL'S. W8BZK, Newark, Ohio.

YOUR call, monogram, handle, spun in chain tieclip. Gold filled. On pearl brooch for ladies. One dollar. W9SZB.

BARGAINS: 6-8VDC DPDT relays, 10 amp contacts, \$1. postpaid in U. S. A. Tapped rheostats 1.5 — 4 — 6 — 10 ohms, 2½ amps with switch, 25¢ each. Dymac, W8RRL, 216 E. Genesee St., Buffalo, N. Y.

YOUR call in 2¼" aluminum letters mounted for studio use or license plate — \$1. each; \$1.50 ordered together. E. Bailey, W. Newton, Pa.

SELL: QST complete January 1928 through December 1938, \$15. Express prepaid. Good copies. W2BJR.

QSL cards. Samples. Meador, Box 241, Columbus, Miss.

ANY radio circuit diagram 25¢. Order mentioning manufacturer's name, model. Catalog free. Supreme Publications, 3727 W. 13th, Chicago.

BARGAIN 6A6 — 809 — 5Z3 transmitter, power supply, tubes, crystal, coils. Picture on request. \$30. W3DYL, 1923 W. Airdrie St., Philadelphia, Pa.

10-20 meter DeLux transmitter, input 120 watts code, 80 phone. Photographs, full information W2DTT, 20 Laurel Hill Terrace, N. Y. C.

SELL: Hallcrafters SX16, Super Sky rider with crystal, speaker; \$90. W1JRV.

RADIO equipment made to order. Klein & Fisher, Batavia, Ohio.

ATTENTION nearby hams. Must sell following panels and equipment: 19 x 14 with large dynamic speaker; 19 x 10½ with power supply and 15 watt amplifier; 19 x 10½ with 50 watt final amplifier. Have plenty chokes, transformers, condensers, transceivers, etc. Sell in one lot or separately. \$25. too much for this? Call BERgen 3-0852 between 6:30 and 7:00 p.m. W2EQS.

EXCHANGE boat, camera, enlarger, extra equipment for transmitter or parts. What have you? Write Fred Hill, Port Penn, Del.

SWAP 300 watt rig for good movie camera or sell — cash W7GTE.

QSL'S, QSL's. Finest stock, designs, printing. Samples? (Stamp.) W2DED, Holland, Mich.

HOWARD 450 with crystal and speaker, perfect condition, first \$75. WTHAM, Richey, Mont.

SELL or trade: Weston Model 30-H voltmeter relays, \$10. Want plate transformer and filter for 2000 volts, 500 mils, d.c. W4DBP.

FB7 complete, \$22.50; RCA-ACR-155, \$35.; RME-9D, \$59.; Howard 430, \$24.; Sky Champion, \$42.; PR10, \$29.; 101XA, \$122.; Peak preselector, \$7. Van Sickle Radio Supply Co., W9KJF, 34 W. Ohio, Indianapolis, Ind.

RADIO code course complete on three records. Dealer's net price, \$5. Balston, Poinsetta, Inc., Pitman, N. J.

NOISE silencer, RME69, \$100. Lieut. F. G. Wild, Coast Guard Air Station, Port Angeles, Wash.

DOUGLAS Universal modulation transformers are acclaimed by hams the world over as the best buy. You are protected with a Douglas guarantee. 50 watts audio, \$4.95 pair; 100 watts audio, \$7.75 pair. Postpaid in U. S. Write W9LXR, Rice Lake, Wis.

SELL: nearly new HF-300, \$14.50. W7DES, c/o KDFN, Casper, Wyo.

FOR sale: Collins 45A xmitter. 160-80 and 10 meters. RME-69 and speaker, rack style. \$350. cash takes all. QRA: 711 Sycamore, Oakland, Calif.

SELL: 200 watt all-band CW, phone transmitter — \$125. Want candid camera. W2GIZ.

FOR sale: 350 watt 110 volt a.c. light plant. First class condition. Henry Ray, Indianapolis, Miss.

SELL 150 watt push-to-talk rack and panel phone, Breting 9 and accessories. W9WPP, Auburn, Ind.

SALE: 440 Howard receiver with crystal less speaker, \$50. J. C. Fleming, 897 Barnett Pl., N.E., Atlanta, Ga.

WANTED: HRO. W6ELA, 1058 Pine, Redding, Calif.

CRYSTALS airmail 160A, 80X, 40X, \$1.95; 40AT, \$2.75. Complete line 100 kc. to 18 megacycles. Write C.O.D.'s accepted. Commercial crystals quoted. C-W Mfg. Co., 1170 Esperanza, Los Angeles.

DOES your RME-Hallcrafters-National-RCA-Hammarlund receiver require adjustments, alignment, repairs? We have modern laboratory facilities and guarantee work one year. Write: Associated Services, 9323 Rhodes Ave., Chicago.

CRYSTALS in holders: 40X, \$1.60; 160, 80A, \$1.25; any frequency. C.O.D.'s accepted. Pacilio Labs., 344 Fetterly, Los Angeles.

QSL'S. Finest at bargain prices. Maleco, 1805 St. Johns Place, Brooklyn, N. Y.

WANTED: sound recorder. W2ATQ.

SELL: Sky Challenger II practically new with crystal filter. Brush crystal phones and matching speaker and 8 meter. \$75. cash; or trade for Bell & Howell eight millimeter movie equipment. Albert Stuart, 1220 N St., N.W., Washington, D. C.

JONES oscillograph kits. Comply with F.C.C. regulations by incorporating this serviceable instrument in your station. Uses RCA 913 and type 80 rectifier. Develops trapezoidal pattern indicating percentage of modulation, driving power, bias, proper neutralization, etc. Kit price including tubes, \$12.95. Wired and tested, \$2.50 additional. Shipping weight, 3 lbs. Jones Radio Co., E. Norwegian & George Sts., Pottsville, Pa.

SELL: QST's Sept. '32 to '39. Best offer. W9TCC, Petersburg, Ill.

SIAMESE double decker works 10-20. Two beams, one price. Motorized rotary heads, Selsynchronous direction indicators, telescoping tapered aluminum beam elements, verticals, Baseett cable. Rotary Array Service, W8MLL.

CRYSTALS: write for quotations on amateur and commercial frequency crystals. Catalog. Ham Crystals, 1104 Lincoln Place, Brooklyn, New York.

SELL receiver and surplus. W2VG.

TELEPLEXES, Instructographs, omnigraphs, receivers bought, sold. Ryan's, Hannibal, Mo.

SELL: complete 200 watt transmitter, phone or CW. Photo and details on request. WIAPP, C. Alden Specht, Newton, Mass.

WANT: old spark equipment, transformers, quenched gaps, etc.; also old large power tubes such as 851, etc. W5KD, 215 N.W. 19th St., Oklahoma City.

SELL: all or part 250-500 watt transmitter, incompletely wired. 232 Alexander, Elmhurst, Ill.

TELEPLEX, five double tapes, oscillator, speaker, tube, batteries, complete in portable case. Sell — \$9. R. R. Ralston, 255 Pomeroy, Pittsfield, Mass.

FOR sale: SW5 complete, Sky Buddy, 1½ kw. 2200 transformer, thirty volt fifty amp. generator. Make offer. F. P. Onell, Salisbury, Conn.

SELL: National PB7X, 10 to 80 BS coils, National power, \$27.50. RME 5-10X like new, \$24.50 cash. W9FXZ.

QSL'S — samples. Brownie, W3CJI, 523 No. Tenth St., Allentown, Pa.

BARGAINS: Reconditioned guaranteed amateur receivers and transmitters shipped on ten day free trial. You save up to 80%. Practically all models cheap. For example: Super Pro, \$135; HEO, \$129.90; RME-69, \$89.; SX-16, \$79.; NC81X, \$69.; SX-10 Ultra-Skyrider, \$69.; S18 Sky Challenger, \$54.; Howard 450, \$49.; National One-Ten, \$29.; ACR-136's, \$29.; PB7's, \$19.; SW3's, \$12.50. Others. Terms. Try any receiver before buying. Write for full details. Bob Henry, Butler, Mo.

SELL: 181 copies QST December 1920-December 1935 inclusive. Excellent condition. Twenty dollars f.o.b. Dana, Edgewater Rd., Cliffside Park, N. J.

CRYSTALS: You can't judge the quality of a crystal by its appearance or price, but you can by performance. Throughout the entire process Eidson T9 crystals are precision cut, finished and calibrated accounting for their high performance and dependability. 40 and 80 meter bands, \$1.60 postpaid. Improved T9 ceramic holders, \$1. Satisfaction guaranteed. C.O.D.'s accepted. Sold by: Henry Radio Shop, Butler, Mo.; Hieronymus Radio, 88-34 209th St., Queens Village, N. Y.; Pembleton Labs., Ft. Wayne, Ind.; Frank Anzalone, 375 W. 46th St., N. Y. C.; Casa Edison, Havana, Cuba; Hamrad Wholesale, Kensington, London, Eng.; and Eidson's, Temple, Texas. Other territory available.

QSL'S — SW1's. Printed day order received. Samples. W5GG, Cleveland, Miss.

SELL: crystal Super-Pro, condition excellent, \$125. Robert Mautner, 2288 Mott, Far Rockaway, N. Y.

ROTARY beams. Television kits, Servicemen, write for Service Man list. Orders prepaid. Special discounts. Amateur headquarters. Write for Amateur list. Remember, I sell all lines of transmitting equipment. Write to Southern Ohio's only amateur owned amateur business. Jos. N. Davies, W8ANF, 2767 No. Bend Rd., Sta. A, Cincinnati, Ohio.

NOW. P.R. crystals mounted in new Aismag 35 holders — 40-80 meter PR-X, 160 meter PR-Z, \$3.; 40-80 meter PR-Z (low drift), \$3.50; 20 meter PR-20, \$4.50; unconditionally guaranteed. Immediate shipment. Wholesale Radio Labs., Council Bluffs, Iowa.

JOIN our radio exchange club. Get rid of those extra ham parts quickly at a fair price. Write today. Wholesale Radio Labs., W9GFQ, Council Bluffs, Iowa.

SELL: used SR80 velocity microphone, \$20.; RAI, \$8.; converter: 12 volt d.c. to 120 60 cycles a.c. 775 watts, remote control starting, \$80. W6HTN, 1671 Wash. Blvd., Ogden, Utah.

CREL products. A new line of high quality economical transmitting units. Send for catalog describing exciters, R.F. amplifiers, power supplies, Class B amplifiers. Start with foundation unit and add later. Nothing to become obsolete. Lifetime quality. Cincinnati Radio Engineering Labs., Box 2, Sta. A, Cincinnati, Ohio.

ALUMINUM in all commercial forms, sheet, angles, radio panels, bars, rods. Immediate delivery. Empire Aluminum Co., Sta. D, Box 97, N. Y.

WANTED: RCA Theremin. State condition and price desired. Philip Stout, 3809 Barrington Rd., Baltimore, Md.

QSL'S. 1939 designs. 48 hour service. Free samples to hams. W2FJE, 101 Hanson Place, Brooklyn, N. Y.

CUSTOM built transmitter 150 watts phone, 300 watts CW, Meissner signal shifter or xtal, 10 to 160 meters. Complete for \$190. W1KFC.

WANTED: Harvey UHX-10 transmitter — also superhet receiver. W9GLR, Mason City, Iowa.

NW complete all-band phone, CW transmitter rack and panel, \$85. Many bargains. Frampton Radio, Blackwell, Okla.

QSL'S — two colors. Samples. W9RUJ.



SPECIAL for MAY

BEED MILLIAMETERS

SQUARE BAKELITE CASE

3" DIAMETER

MOVING COIL MOVEMENT

0 to 5, 10, 25, 50, 100, 200, 250, 300, or 500 Ma.

\$2.39

NEW! PERFECT! GUARANTEED!

If you can't drop into our store, send us your order for prompt shipment of your meter.

STANCOR POWER TRANSFORMERS

Delivers 600 volts D.C. at 200 Ma. 6.3 V. —

2½ Amps. 6.3 V. — 4 Amps. 5 V. — 3 Amps. **\$2.95**

WASCO E — C Exciter Unit

Instant QSY over entire band with steady T9X signal. NO CHIRPING! Two 6L6s provide sufficient output to drive final. Complete kit with coils for one band. **\$14.45**

FREE INTERESTING CIRCULAR

XMITTING TUBES

Every standard make and type in stock. H & K — RCA — EIMAC — TAYLOR — HYTRON — RAYTHEON. All xmitting tubes shipped via express, carefully packed.

COMMUNICATIONS RECEIVERS

All well known, reliable models in stock — at lowest prices. NATIONAL — HAMMARLUND — HALL-CRAFTERS — HOWARD — RCA — etc.

SNAPPY MAIL SERVICE

Sun Radio is proud of its prompt mail order service. If you live too far from New York — or you can't conveniently drop in at our Big Store — Sun's efficient shipping department should be your headquarters! Our customers will be found in every corner of the Globe. Don't hesitate to send us your orders. You will be pleased with the quick, efficient handling of your inquiries as well. Whether it is a carbon resistor or a boatload of receivers — Sun Radio will ship it Today.

MILLER HIGH FIDELITY TUNER

BUILD YOUR OWN — Band width 10 Kc. or 20 Kc. Supplied in Complete Kit including all coils, tubes, resistors, transformers, punched chassis, etc., at Amateur Discounts. Write for free interesting circular listing parts, response curves and diagrams.

NEW! U.T.C. SPECIAL Plate Power Transformers

D.C. Voltage *	D.C. Current	Price
750 and 620	200 Ma.	\$3.82
825 and 600	300 Ma.	5.59
1275, 1050 and 825	300 Ma.	7.06

* Actual D.C. voltage output out of two section filter.

Filter and Swinging Chokes

6 Hy.	175 Ma.	95 ohms	\$1.62
5/25 Hy.	175 Ma.	95 ohms	1.62
15 Hy.	225 Ma.	120 ohms	2.06
5/25 Hy.	225 Ma.	120 ohms	2.06
15 Hy.	300 Ma.	90 ohms	2.94
5/25 Hy.	300 Ma.	90 ohms	2.94

KEEP UP TO DATE

Drop us a post card and your name will be placed on our mailing list for catalogs and interesting bulletins.

☆ EXPORT ORDERS SOLICITED

☆ MAIL ORDERS PROMPTLY FILLED



RADIO CO.

212 Fulton Street, Dept 11 New York

Cable Address SUNRADIO NEW YORK

Your Nearby Dealer Is Your Best Friend

Your nearby dealer is entitled to your patronage. He is equipped with a knowledge and understanding of amateur radio. He is your logical source of advice and counsel on what equipment you should buy. His stock is complete. He can supply your needs without delay. His prices are fair and consistent with the high quality of the goods he carries. He is responsible to you and interested in you.

One of these dealers is probably in your city—Patronize him!

<p>ATLANTA, GEORGIA Wholesale Radio Service Company, Inc. 265 Peachtree Street "The World's Largest Radio Supply House"</p>	<p>NEWARK, N. J. Wholesale Radio Service Company, Inc. 219 Central Avenue "The World's Largest Radio Supply House"</p>
<p>BALTIMORE, MARYLAND Radio Electric Service Co. 3 N. Howard St. Everything for the amateur</p>	<p>NEW HAVEN, CONNECTICUT Hatry & Young, Inc. 86 Meadow Street National, Taylor, Triplett, Radiotron, RME, Howard, etc.</p>
<p>BOSTON, MASS. Wholesale Radio Service Company, Inc. 110 Federal Street "The World's Largest Radio Supply House"</p>	<p>NEW YORK, N. Y. Wholesale Radio Service Company, Inc. 100 Sixth Avenue "The World's Largest Radio Supply House"</p>
<p>BRIDGEPORT, CONNECTICUT Hatry & Young, Inc. 177 Cannon Street Time Payments On All Types Of Equipment</p>	<p>NEW YORK, N. Y. Harrison Radio Company 12 West Broadway Harrison Has It! Phone WOrth 2-6276 for information or rush service</p>
<p>BRONX, NEW YORK Wholesale Radio Service Company, Inc. 542 East Fordham Road "The World's Largest Radio Supply House"</p>	<p>PHILADELPHIA, PENNSYLVANIA Eugene G. Wile 10 S. Tenth Street Complete Stock of Quality Merchandise</p>
<p>BUFFALO, NEW YORK Radio Equipment Corp. 326 Elm Street W8PMC and W8NEL — Ham, service and sound equipment</p>	<p>RICHMOND, VIRGINIA The Arnold Company Broad at Harrison St. W3EQQ — "The Virginia Ham Headquarters" — W3FBL</p>
<p>HARTFORD, CONNECTICUT Hatry & Young, Inc. 203 Ann Street Trade Your Old Communication Receiver</p>	<p>ROCHESTER, NEW YORK Radio Parts & Equipment Co. 244 Clinton Avenue, North Complete stock amateur-BCL parts. Standard discounts</p>
<p>JAMAICA, L. I., NEW YORK Wholesale Radio Service Company, Inc. 90-08 166th Street (Merrick Road) "The World's Largest Radio Supply House"</p>	<p>TORONTO, CANADA A & A Radio Service Supply 101 Queen Street, West Canada's Foremost Radio Supply House</p>
<p>MONTREAL, CANADA Canadian Elec. Supply Co., Ltd. 285 Craig St., W. Quality parts and equipment for discriminating buyers</p>	<p>WINNIPEG, CANADA Electrical Supplies, Ltd. 306-10 Ross Avenue Western Canadian Amateur Headquarters for Leading Lines</p>

YOU ARE PROTECTED
WHEN YOU BUY FROM

QST

ADVERTISERS

“Advertising for QST is accepted only from firms who, in the publisher’s opinion, are of established integrity and whose products secure the approval of the technical staff of the American Radio Relay League.”

Quoted from QST’s advertising rate card.

Every conceivable need of a radio amateur can be supplied by the advertisers in QST. And you will know the product has the approval of the League’s technical staff

Index to Advertisers

Aerovox Corp.....	115
American Microphone Company, Inc.....	113
American Radio Institute.....	109
Astatic Microphone Laboratory, Inc.....	80
Barker & Williamson.....	96
Biley Electric Company.....	76, 98
Browning Laboratories, Inc.....	102
Brush Development Company, The.....	106
Candler System Company.....	115
Capitol Radio Engineering Institute.....	106
Cardwell Manufacturing Corp., Allen D.....	94
Centralab.....	75
Collins Radio Company.....	Cov. 2
Cornell-Dubilier Electric Corp.....	117
Coto-Coil Company, Inc.....	110
Crosley Corp., The.....	90
Delaware Radio Sales Company.....	116
Dodge’s Institute.....	98
Eitel-McCullough, Inc.....	91
Gardiner-Levering Company.....	113
General Rotary Antenna Company.....	117
Guthman & Company, Edwin I.....	98
Hallicrafters, Inc., The.....	1, 2
Hammarlund Manufacturing Company, Inc.....	74, 77, 82
Harvey Radio Company.....	108
Harvey Radio Laboratories.....	81
Henry Radio Shop.....	114
Hinds & Edgerton.....	115
Hygrade Sylvania Corp.....	84
Instructograph Company.....	118
International Resistance Company.....	79
Johnson Company, E. F.....	88
Kato Engineering Company.....	113
Ken-Rad Tube & Lamp Corp.....	111
Kenyon Transformer Company, Inc.....	7, 102
Mallory & Company, Inc., F. R.....	72
Massachusetts Radior School.....	115
Meissner Manufacturing Company, Inc.....	89
Mims Radio Company.....	87
National Company, Inc.....	Cov. 3, 71, 85
Newark Electric Company.....	103
Ohmite Manufacturing Company.....	114
Onan & Sons, D. W.....	117
Par-Metal Products Corp.....	109
Port Arthur College.....	111
Precision Apparatus Company.....	86
Precision Piezo Service.....	111
Premax Products.....	122
RCA Institutes, Inc.....	113
RCA Manufacturing Company, Inc.....	Cov. 4, 4, 5
Radio Mfg. Engineers, Inc.....	83, 127
Radio Parts, Inc.....	118
Radio Parts Trade Show.....	117
Radio Shack, The.....	97
Radio Transceiver Laboratories.....	109
Raytheon Production Corp.....	73
Rek-O-Kut Corp.....	122
Scientific Radio Service.....	109
Sheldon Electric Company.....	92
Shure Brothers.....	113
Sickles Company, F. W.....	117
Signal Electric Manufacturing Company.....	117
Simpson Electric Company.....	78
Solar Manufacturing Corp.....	110
Sprague Products Company.....	93
Standard Electrical Products Company.....	110
Standard Transformer Corp.....	109
Sun Radio Company.....	124
Taylor Tubes, Inc.....	95
Teleplex Company.....	96
Terminal Radio Corp.....	112
Thordarson Electric Mfg. Company.....	99
Tibbets Laboratories.....	114
Triplett Elec. Instrument Company, Inc.....	115
United Transformer Corp.....	128
Valpey Crystals, The.....	118
Vibroplex Company, Inc., The.....	111
Ward Leonard Electric Company.....	118
Wholesale Radio Laboratories.....	108
Wilson, Willard S.....	116
Yaxley.....	72

RME

TIME WILL TELL

INSIDE FACTS

(THE FOURTH OF A SERIES)

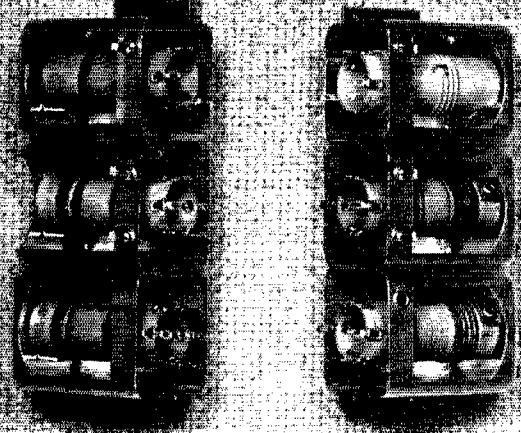
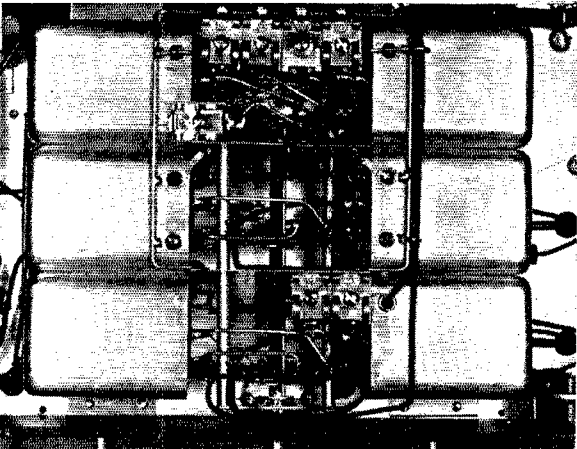

In the series of exposures, where RME has taken you behind the scenes and called attention to the extreme care utilized in the construction and assembly of RME equipment, you have been informed that it pays to invest in *extra value*. Check the history of the 69 during the past three years and you will have the answer to many questions.

Many little details, determined through test and experiment, make up the present radio frequency coil section. There is the matter of *bonded* aluminum shield cans to remove circuit noises completely; proper selection of coil forms and materials; the *pre-grooving* of forms for the higher frequency coils to insure proper placement of turns and definite stability; the selection of fine impregnation material for *permanency* in calibration. All coils are made and carefully supervised in the RME plant.

The complete shielding of individual coils has always been regarded as of major importance, especially in a communication receiver. Such shields should be large enough so as not to materially affect the inductance of the coils, yet be rigid and well placed.

The firm placement of coils is amply emphasized by the fact that wiring to the band change switch is through *buss wire* at *close range*. No method could be simpler and more practical than the one utilized in the RME receivers. And, it *really works!*

Your radio dealer has bulletins
and practical information

RADIO MFG. ENGINEERS
Inc.

111 Harrison Street
PEORIA, ILLINOIS

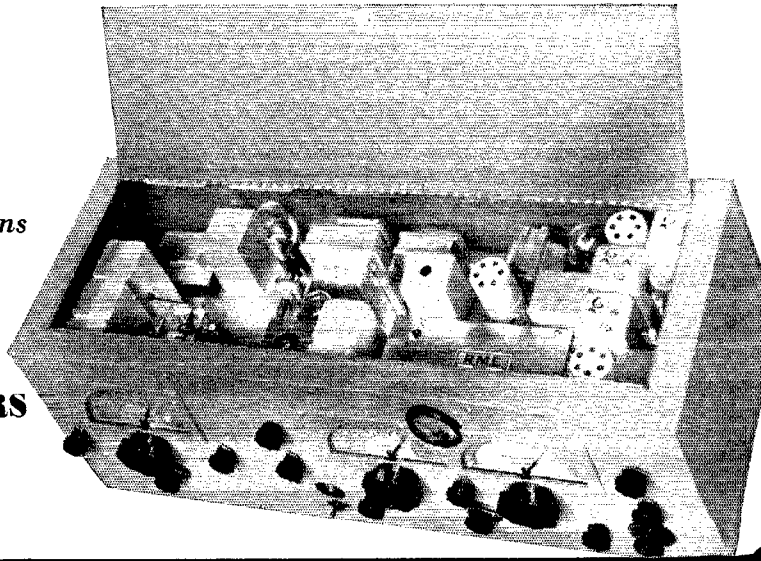

Diversity receivers are used where **DEPENDABILITY** of reception is of paramount importance.

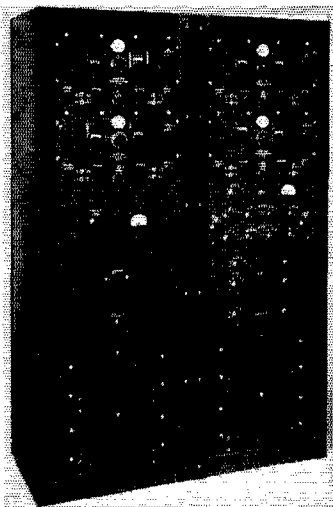

LINEAR STANDARD TRANSFORMERS

are used to provide utmost **DEPENDABILITY** in **SERVICE**



LINEAR STANDARD TRANSFORMERS →

Used with Hammarlund Super Pro receivers in Diversity Receiving Equipment.

- ★ Designed by UTC Engineering Division for a well known FAR EAST government division.
- ★ Designed to feed program to either or both of two (2) 600 ohm telephone lines to main studio.
- ★ By means of switching panel any combination of four Hammarlund receivers may be fed into the AF system.
- ★ Monitor Amplifier may be bridged across either telephone line to monitor output of system at receiving station.
- ★ Line voltage can be maintained at



← **VARITRAN CONTROL**



← **POWER SUPPLIES**

Designed for dependability in severe tropical climates.

proper level by means of UTC VARITRAN control panel.

- ★ All transformers designed for continuous duty under severe tropical conditions.
- ★ Overall frequency response of telephone line amplifiers and monitor plus or minus 1 DB from 30 to 17,000 cycles.
- ★ Line Amplifier noise level —55 DB below zero at .006 reference level.
- ★ Monitor Amplifier noise level —40 DB below zero. Distortion less than 2%.

UNITED TRANSFORMER CORP.

Write: **COMMUNICATIONS DIV. ★ 150 VARICK ST. ★ NEW YORK, N. Y.**
EXPORT DIVISION: 100 VARICK STREET NEW YORK, N. Y. CABLES: "ARLAB"

QST for May, 1939, EASTERN Edition

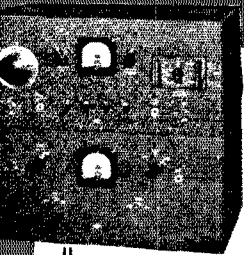

"FB" OPERATING

National Transmitter Equipment fits easily into convenient layouts. The NSM Modulator and NTX-30 Transmitter team up to make a compact and versatile outfit for phone or CW, with outstanding ease in changing frequency. Though a complete transmitter in itself, with 30 watts output, these units also make ideal drivers for high power output stages. The NC-101X Receiver matches the transmitting units in appearance, and with them forms the basis of an outstanding station.

NATIONAL COMPANY, INC., MALDEN, MASS.



W3BES

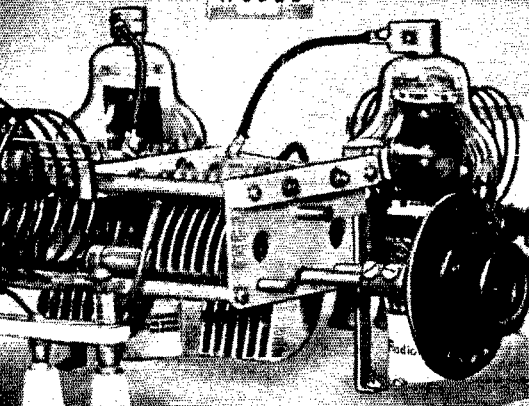

W3BES WINS 9th SWEEPSTAKE NATIONAL HIGH... ROLLS UP 84,000 POINTS USING PAIR OF RCA-809'S IN FINAL STAGE... at Total Cost of \$5 for the Two!



WIN, PLACE and SHOW with RCA's

Here is the W3BES Sweepstakes Record:

- 1936—has 3rd using RCA-852 with 1,000 watts.
- 1947—has 2nd using RCA-809's with 100 watts.
- 1938—1st place with the RCA-809's!

Proving

A RIG NEED NOT BE COSTLY

TO COME IN

A Winner!

Jerry Mathis of Philadelphia's well-known Frankford Radio Club *knows* tubes! He knows them as an amateur of long standing — as a prize winner in many important amateur events. Small wonder then, that, for his own 100-watt entry in the Ninth A.R.R.L. Sweepstakes, Jerry chose a pair of RCA 809's for the final amplifier stage and drove them with a third 809.

These tubes were almost two years old. He had bought the first three delivered to a Philadelphia RCA distributor and had used them hard ever since. They had brought him in second in the 1937 Sweepstakes. During the DX Contests, he blush-

ingly admits to having built them up temporarily to 500 watts input instead of their rated 150 watts input. Yet these battered old 809's continued to come through in their own big way.

During the 40 hours of the 1938 contest, Jerry's W3BES worked 502 stations, or an average of better than 12.5 per hour. To be exact, his total score was 84,001.25 points — a record that tells its own story of honest-to-goodness results from inexpensive equipment. Says Jerry: "An investment in RCA 809's will give you a final amplifier stage that can't be beat at anywhere near the price!"

RCA presents the Magic Key every Sunday, 2 to 3 P.M., E.S.T., on the NBC Blue Network

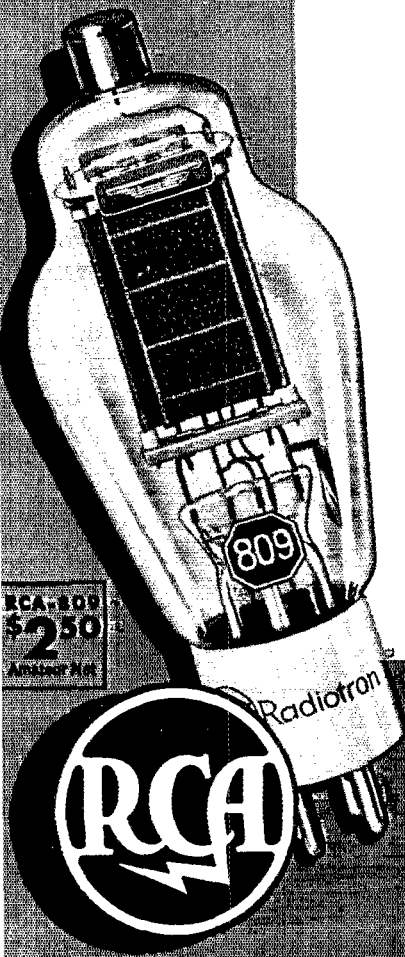

RCA-809
\$2.50
AMPLIFIER PIP



Radio Tubes

FIRST IN METAL, FOREMOST IN GLASS, FINEST IN PERFORMANCE

RCA MANUFACTURING CO., INC., CAMDEN, N. J.
A Service of The Radio Corporation of America