

June, 1939

25 cents

QST

devoted entirely to

amateur radio



In this issue:

A 2½-METER
PACK SET

SUCCESSFUL ANTENNAS
IN DX CONTEST

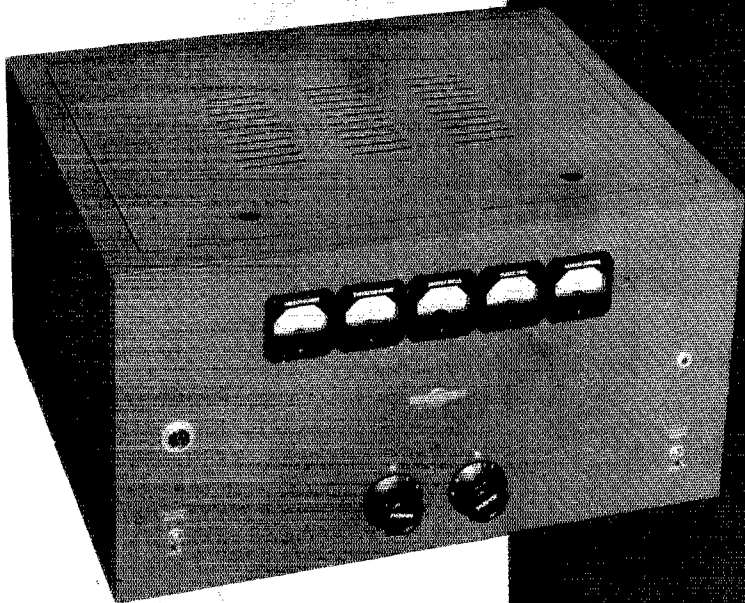

COLLINS

The 32RA is a self-contained transmitter of compact design for use when up to four frequencies must be instantly available. The transmitter is controlled entirely from the front of the panel where the arrangement is of such simplicity that non-technical persons are able to operate readily.

Mechanical structure is unique in that r-f, power supply, and modulator sections can be removed quickly and easily by loosening the mounting screws. Inspection and maintenance effort is thus reduced to a minimum.

Collins 32RA finds ready application as a stand-by transmitter for airlines, in emergency radio systems, interzone police networks and for many other varied uses.

SPECIFICATIONS

POWER OUTPUT: 50 watts telephone and 75 watts telegraph.

FREQUENCY RANGE: 1.5 mc to 15 mc.

FREQUENCY CHANGE METHOD: Panel control instantly selects any of four pre-determined frequencies.

TUBE COMPLEMENT: 6—6L6G, 1—6C5, 3—807, 1—80, 2—RK60.

FREQUENCY CONTROL: Direct crystal control.

RESIDUAL NOISE LEVEL: More than 50 db below 100% modulation.

CABINET DIMENSIONS: 12½" high, 22" wide and 18" deep.

NET WEIGHT: 120 pounds.

POWER SOURCE: 115 volts, 50/60 cycles, single phase or d-c power source.

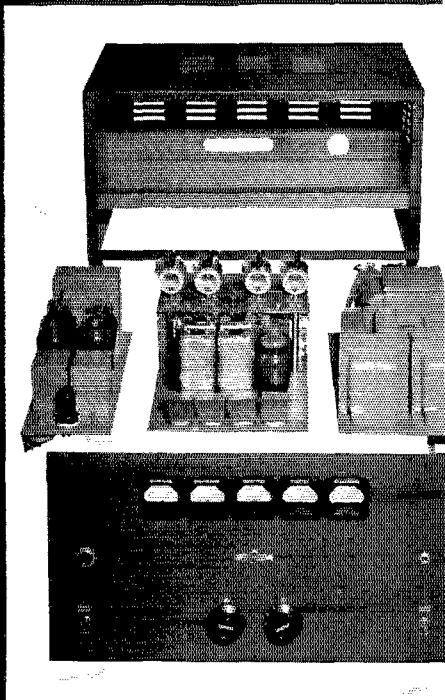

COLLINS RADIO COMPANY

CEDAR RAPIDS, IOWA

NEW YORK, N. Y., 11 WEST 42 ST.

OK ON SA HOLD UP ON IT NEW BOY JIM I RR THE HALLICRAFTERS
R BRINGING OUT A ROYAL. ITS OLD THE SKYRIDER DEFIANT IS
S METER BUILT IN NOISE LIMITER PRESELECTION ELECTRICAL BAND
SPREAD ES GET THIS ITS SUMING NEW FREQ METER TUNING 2 HELP
U KEEP UR EMT IN THE BAND IT COVERS EYTING DOW TO 7 MTRS
WITH PLENTY OF BAND SPREAD ON THE HAM BANDS WHERE U NEED IT
MOST ES THE WHOLE WREK INCLUDING TUBES ES KEAL BUT WITHOT
SPKR COSTS U LESS THAN 70 DOLLARS. WE CAN SEE IT AT THE
RADIO PARTS SHOW IN CHICAGO LETS B TR JUNE 14 TO 17 SPACE 827
19 FRANKLIS AVE. WHAT SA JIM? BUT AS I



the hallicrafters FREQUENCY STANDARD

Model HT-7 An Accurate Instrument for Checking Frequencies!

Used in conjunction with any good communications receiver, the Model HT-7 provides an accurate method for measuring frequencies. It may be used to set or check existing calibrations or to make initial calibrations. By following a simple procedure it is possible to check the frequency of any signal within close limits.

The HT-7 Frequency Standard consists of a stable crystal oscillator providing either 1000 kc or 100 kc output, together with a 10 kc multi-vibrator and a harmonic amplifier. By means of a switch on the front panel, harmonics of 1000 kc, 100 kc or 10 kc can be selected.

The frequency of the 100 kc crystal is ad-

justable over a narrow range, so that it is possible to set its frequency to zero beat with either WWV or domestic broadcast stations.

A tuned circuit, placed at the output of the harmonic amplifier, increases the level of the higher harmonics.

The HT-7 Frequency Standard performs a very important function in amateur radio operations—and is available at small cost for a precision instrument of its type.

See the Hallicrafters Model HT-7 Frequency Standard at the Chicago Radio Parts Show, Stevens Hotel, Space 827-29 Franklin Ave., June 14-17, or ask your Hallicrafters Distributor!

For Use in

- ★ *Checking Transmitter Frequency*
- ★ *Checking Receiver Calibrations*
- ★ *Calibrating Receivers*
- ★ *Bandsetting Receivers*
- ★ *Locating Signals for Skeds*
- ★ *Setting ECO Frequency*



Amateur's Net Price \$ **29.50** Complete

the hallicrafters inc.

2611 Indiana Avenue, Chicago, U. S. A.
Cable Address "HALLICRAFT" Chicago

"WORLD'S LARGEST BUILDERS OF AMATEUR COMMUNICATIONS EQUIPMENT"

JUNE 1939

VOLUME XXIII

NUMBER 6



STAFF

Editorial

KENNETH B. WARNER, W1ER
Editor and Business Manager

CLARK C. RODIMON, W1SE
Managing Editor

GEORGE GRAMMER, W1DF
Technical Editor

DONALD H. MIX, W1TS
BYRON GOODMAN, W1JPE
Assistant Technical Editors

VERNON CHAMBERS, W1JEQ
Technical Information Service

JAMES J. LAMB, W1AL
Consultant

Advertising

F. CHEYNEY BEEKLEY, W1GS
Advertising Manager

CHARLES BRUNELLE
Asst. Advertising Manager

Circulation

DAVID H. HOUGHTON
Circulation Manager

RALPH T. BEAUDIN, W1BAW
Asst. Circulation Manager



OFFICES

38 La Salle Road

West Hartford, Connecticut

Subscription rate in United States and Possessions and Canada, \$2.50 per year, postpaid; all other countries, \$3.00 per year, postpaid. Single copies, 25 cents. Foreign remittances should be by international postal or express money order or bank draft negotiable in the U. S. and for an equivalent amount in U. S. funds.

Entered as second-class matter May 29, 1919, at the post office at Hartford, Connecticut, under the Act of March 3, 1879. Acceptance for mailing at special rate of postage provided for in section 1103, Act of October 3, 1917, authorized September 9, 1922. Additional entry at Concord, N. H., authorized February 21, 1929, under the Act of February 28, 1925. Additional second-class entries to cover sectional editions authorized March 20, 1935.

Copyright 1939 by the American Radio Relay League, Inc. Title registered at United States Patent Office.

QST

devoted entirely to

AMATEUR RADIO

PUBLISHED, MONTHLY, AS ITS OFFICIAL ORGAN, BY THE AMERICAN RADIO RELAY LEAGUE, INC., AT WEST HARTFORD, CONN., U. S. A.; OFFICIAL ORGAN OF THE INTERNATIONAL AMATEUR RADIO UNION



CONTENTS

Editorial	9
Splatter	10
A Compact "Five and Ten" Converter for Mobile Use <i>Thomas P. Chapman, W1KK</i>	11
Fashions in Antennas <i>Byron Goodman, W1JPE</i>	14
What the League Is Doing	19
A QST-Size Super <i>W. Fraim Alexander, W3GFZ</i>	20
Amateur Radio at the Fairs	23
Dixie Jones' Owl Juice	24
Atlantic Division Convention	24
Silent Keys	24
A Stable and Inexpensive 56-Mc. Transmitter <i>Milton W. Mix, W1IPL</i>	25
A.R.R.L. Field Day	28
W2JHB Wins 1938 Maxim Memorial Award	29
Tri-County Takes a Holiday <i>Dana Griffin, W2AOE</i>	30
A 112-Mc. Pack Set <i>Vernon Chambers, W1JEQ</i>	32
The 1852 as a Mixer	37
"90 Plus" <i>Alan P. Buffington, W3EEW</i>	39
An Economical Tri-Tet Crystal Oscillator <i>G. W. Horton, W9IGF</i>	40
The Rig at W8XAI <i>John J. Long, W8ABX</i>	42
Army-Amateur Radio System Activities	43
Naval Communication Reserve Notes	44
Western Union to Collaborate with Amateurs	45
How Would You Do It?	46
I.A.R.U. News	48
Hints and Kinks for the Experimenter	50
Correspondence Department	53
Operating News	54
S. F. Transmissions	86
New Apparatus	92
Safety ABC's	94
Book Reviews	94
A.R.R.L. QSL Bureau	100
Hamads	107
QST's Index of Advertisers	110

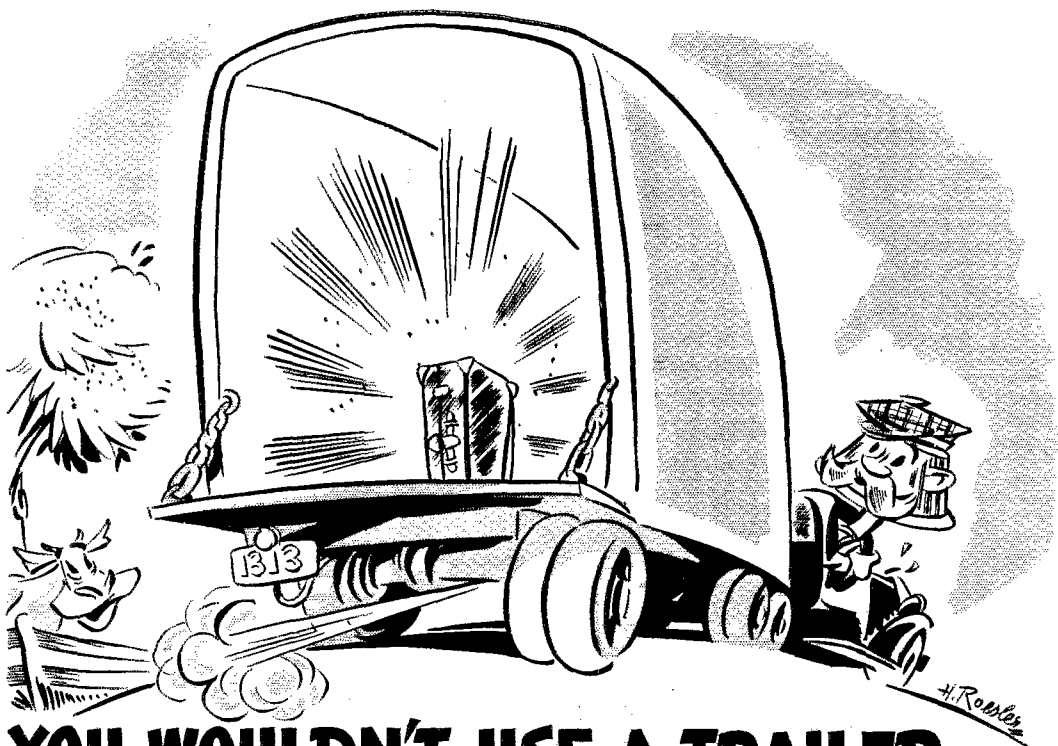

YOU WOULDN'T USE A TRAILER TRUCK TO TRANSPORT A TRUNK

Just doesn't make sense . . . just as little as it makes sense to use a large resistor when a small Centralab Axial Lead Resistor will do the trick. It isn't size that counts . . . for most resistors in radio sets actually carry less than $\frac{1}{4}$ watt load. High chassis temperatures and humidity cause breakdown . . . not moderate overload. That is why inserting a LARGE resistor is NOT the answer to a replacement problem.

Centralab Ceramic Resistors ARE the answer. Type 710 is conveniently small yet fully insulated. Modestly rated at $\frac{1}{2}$ watt, it will carry normal overloads.

Solid ceramic — humidity and temperature proof . . . priced so low you can well afford to keep a stock on hand.

TYPE 710, rating $\frac{1}{2}$ watt, size $\frac{1}{8}$ x $\frac{5}{8}$ inch. List price 60c for five.

TYPE 714, rating 1 watt, size $\frac{1}{4}$ x 1 inch. List price \$1.00 for five.

See your jobber

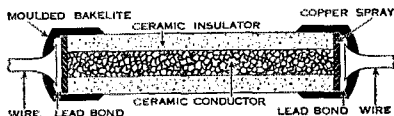

Center ceramic core, and ceramic jacket fired together to form a single shockproof unit. Pure copper covers resistor end for wire lead contact.

OLD MAN
Centralab

says:



Smooth and Centralab are synonymous — hundreds of "ads" say so . . . and millions of Resistors, Volume Controls, Switches, etc. give evidence that the ads tell the truth.



Centralab

AXIAL LEAD RESISTORS

CENTRALAB · DIVISION OF GLOBE UNION INC., MILWAUKEE, WIS.

Visit the

1939 National Radio Parts
Trade Show

June 14 to 17 at Stevens Hotel,
Chicago

AMERICA'S LARGEST AIRLINE

CHOOSES

Taylor Tubes

FOR [DEPENDABILITY—
BETTER PERFORMANCE—
LOWER OPERATING COST



Taylor Tubes is proud that the highly qualified Radio Engineering Staff of American Airlines has accepted the quality of its Tubes. Eighteen months ago, Taylor Tubes were first placed in operation in American Airline's 39 ground and 55 plane transmitters, which operate monthly over a one million two hundred thousand mile air network clearing an average of 225,000 messages and 35,000 scheduled contacts a month. Under these exhausting conditions, the service record of each Taylor Tube was closely watched. Today American Airlines and others are using Taylor Tubes wherever possible because they have proved themselves ideal for the exacting twenty-four hour a day service requirements of an airline. American Airlines alone in handling their tremendous traffic last year completed 99.64% of the better than three million contacts attempted, an evidence of efficient message handling of which American Airlines should be proud. It is easy to see that in Airline service any Tube failure cannot be countenanced. Get the same dependable "More Watts per Dollar" service enjoyed by Airline Radio Engineers, by insisting on Taylor Tubes . . .

Recommended and Sold by Leading Parts Distributors Everywhere.

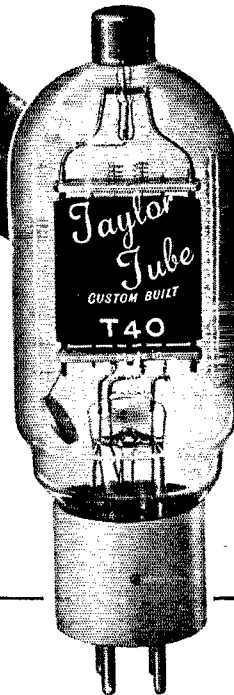

IMPORTANT INFORMATION on THIN WALL CARBON ANODE TUBES

Taylor Tubes will announce the new series of Thin Wall Carbon Anode tubes in the next issue of QST. These tubes will be available from dealer stocks on July First. An unusually heavy demand caused by large foreign orders delayed our production schedule one month.

Frank J. Hajek

"More Watts Per Dollar"

TAYLOR TUBES, INC., 2341 WABANSIA AVE., CHICAGO, ILLINOIS

Section Communications Managers of the A.R.R.L. Communications Department

All appointments in the League's field organization are made by the proper S.C.M., elected by members in each Section listed. Mail your S.C.M. (on the 16th of each month) a postal covering your radio activities for the previous 30 days. Tell him your DX, plans for experimenting, results in phone and traffic. He is interested, whether you are an A.R.R.L. member or get your QST at the newsstands; he wants a report from every active ham. If interested and qualified for O.R.S., O.P.S. or other appointments he can tell you about them, too.

		ATLANTIC DIVISION		
Eastern Pennsylvania	W3QP	John B. Morgan		Blue Bell
Maryland-Delaware-District of Columbia	W3BAK	Edgar L. Hudson		Laurel, Delaware
Southern New Jersey	W3BEI	W. W. Filson	247 E. Atlantic Ave.	Audubon
Western New York	W8CSE	Ed Preston	10 Lincoln Ave.	Tully
Western Pennsylvania	W8OFO	Kendall Speer, Jr.		Lowber
		CENTRAL DIVISION		
Illinois	W9RMN	Leslie M. Dickson	Edellyn Farms	Waukegan
Indiana	W9OG	Noble Burkhart	R. 4, Box 1	Indianapolis
Kentucky	W9ARU	Darrell A. Downard	116 N. Longworth Ave.	Louisville
Michigan	W8DPE	Harold C. Bird	R. F. D. 2	Pontiac
Ohio	W8AQ	E. H. Gibbs	405 Broad St.	Wadsworth
Wisconsin	W9UIT	Aldrich C. Kronos	3127-A West Madison St.	Milwaukee
		DAKOTA DIVISION		
North Dakota	W9RZA	Ernest Bloch	Box 202	Thompson
South Dakota	W9VOD	Dr. A. L. Russell		Philip
Northern Minnesota	W9ICU	Edwin L. Wicklund	R. F. D. 3	Kensington
Southern Minnesota	W9VYQ	Millard L. Bender	608 N. Huron Ave.	Spring Valley
		DELTA DIVISION		
Arkansas	W5ABI	H. E. Velte	4415 West 12th St.	Little Rock
Louisiana	W5DKR	Eugene H. Treadaway	2749 Myrtle St.	New Orleans
Mississippi	W5EWD	Jewell W. Cole	c/o City of McComb Water Dept.	McComb City
Tennessee	W4DWS	William Harold Walker	2503 Belmont Blvd.	Nashville
		HUDSON DIVISION		
Eastern New York	W2LU	Robert E. Haight	511 South Holmes St.	Scotia
N. Y. C. & Long Island	W2AZV	E. L. Baunach	102 Central Ave.	Massapequa, L. I.
Northern New Jersey	W2GMN	Fred C. Read	1014 North Ave.	Elizabeth
		MIDWEST DIVISION		
Iowa*	W9PJR	L. B. Vennard	P. O. Box 304	West Burlington
Kansas	W9UEG	Melvin D. Kirby		Arlington
Missouri	W9OUD	Miss Letha Allendorf	1015 W. 3rd St.	Joplin
Nebraska	W9DI	William J. Bamer		Tobias
		NEW ENGLAND DIVISION		
Connecticut	W1CTI	Frederick Ellis, Jr.	19 Merrill Rd.	Norwalk
Maine	W1FBJ	Winfield A. Ramsdell	1188 Washington Ave.	Portland
Eastern Massachusetts	W1HIL	Larry Mitchell	94 Howard St.	Melrose
Western Massachusetts	W1JAH	William J. Barrett	239 Columbia St.	Adams
New Hampshire	W1BET	Carl B. Evans	163 South Main St.	Concord
Rhode Island	W1HRC	Clayton C. Gordon	182 Washington Ave.	Providence
Vermont	W1KJG	Clifton G. Parker	Box 537	Morrisville
		NORTHWESTERN DIVISION		
Alaska	K7ENA	Leo E. Osterman	Customhouse	Wrangell
Idaho	W7EMT	Carl Eichelberger	Route 2	Kuna
Montana	W7FL	G. A. Woodhouse	Holter Dam	Wolf Creek
Oregon	W7DXF	Harold W. Johnston	205 North Grant St.	Pendleton
Washington	W7FCG	W. Beale	R. 4, School Ave.	Walla Walla
		PACIFIC DIVISION		
Hawaii	K6ETF	Francis F. Blatt	837 16th Ave.	Honolulu
Nevada	W6BIC	Edward W. Heim	509 Claremont St.	Reno
Santa Clara Valley	W6FBW	Elbert Amarantes	454 Washington St.	San Jose
East Bay	W6ITV	Harold J. Burchfield	2240 106th Ave.	Oakland
San Francisco	W6SG	Alan D. Whittaker, Jr.	79 Ellnor Ave.	Mill Valley
Sacramento Valley	W6GZY	J. L. C. Buckenham	2931 24th St.	Sacramento
Philippines	KA1GR	Georges L. Rickard	Box 849	Manila
San Joaquin Valley	W6KUT	Edwin A. Andress	2921 North Van Ness Blvd.	Presno
		ROANOKE DIVISION		
North Carolina	W4CYB	W. J. Wortman	P. O. Box 566	Morganton
South Carolina	W4BOE	Ted Ferguson	1213 College St.	Columbia
Virginia	W3DUV	Charles M. Waff, Jr.	2607 Stuart Ave.	Richmond
West Virginia	W8HD	C. S. Hoffmann, Jr.	47 Lynwood Ave.	Wheeling
		ROCKY MOUNTAIN DIVISION		
Colorado	W9EHC	Carl C. Drumeiler	1828 East Kiowa St.	Colorado Springs
Utah-Wyoming	W7CLG	Ernest E. Parshall	Salt Creek Electric Plant	Midwest, Wyoming
		SOUTHEASTERN DIVISION		
Alabama	W4DGS	James F. Thompson	1203 South Perry St.	Montgomery
Eastern Florida	W4DVO	L. A. Connolly	719 So. Willow Ave.	Tampa
Western Florida	W4AXP	Oscar Cederstrom	2000 St. & Bruce Ave.	De Funiak Springs
Georgia	W4AGI	Leland W. Smith	2010 Pennsylvania Ave.	Augusta
West Indies (Cuba-Isle-of-Pines-Porto Rico-Virgin Islands)	CM2OP	Mario de la Torre	Escobar 110 (Altos)	Habana, Cuba
		SOUTHWESTERN DIVISION		
Los Angeles	W6MQM	Ralph S. Click	1038 Milwaukee Ave.	Los Angeles
Arizona	W6KFC	Victor C. Clark	747 E. Polk St.	Phoenix
San Diego	W6JRM	Howard K. Breedlove	R. 2, Box 636	San Diego
		WEST GULF DIVISION		
Northern Texas	W5DXA	Lee Hughes	125 N. Main St.	Childress
Oklahoma	W5CEZ	Carter L. Simpson	2010 So. 4th St.	Ponca City
Southern Texas	W5BHO	Dave H. Calk	6726 Ave. Q	Houston
New Mexico	W5ENI	Dr. Hilton W. Gillett		Lovington
		MARITIME DIVISION		
Maritime	VE1DQ	A. M. Crowell	69 Dublin St.	Halifax, N. S.
		ONTARIO DIVISION		
Ontario	VE3EF	Dr. D. R. Gunn, (for VE3SG)	Ontario Hospital	New Toronto, Ont.
		QUEBEC DIVISION		
Quebec	VE2CO	Lindsay G. Morris	Apt. 6, 4510 Girouard Ave., N.D.G.	Montreal, P. Q.
		VALALTA DIVISION		
Alberta	VE4GE	C. S. Jamieson	581 W. Riverside Drive	Drumheller, Alta.
British Columbia	VE5HP	J. Hepburn, Jr.	335 Foul Bay Road	Victoria
		PRAIRIE DIVISION		
Manitoba*	VE4BG	A. J. R. Simpson	635 Garfield St.	Winnipeg
Saskatchewan	VE5Y	Arthur Chesworth	1071 4th Ave., N. W.	Moose Jaw

* Officials appointed to act until the membership of the Section choose permanent S.C.M.s by nomination and election.

NEW YORK *Goes* KENYON

READ WHAT THESE TWO LEADING HAM SUPPLIERS SAY ABOUT KENYON TRANSFORMERS



Above: Bill Harrison, W2AVA, who knows that customer satisfaction is of paramount importance.



Above: The home of Harrison Radio for 14 years. The mecca for many Hams in the N. Y. area.

Bill Harrison Says:

"It is my business to supply the finest quality merchandise available. I know how Kenyon Transformers are made. I know that they give satisfaction and what's more, I know they are PRICED RIGHT."

Sam Schwartz Says:

"We at Sun know that Kenyon Transformers have been selected by most every leading manufacturer in the amateur field, and what's good enough for them is good enough for us. Quality always tells!"

You Amateurs, who long have recognized the superiority of Kenyon Transformers, will welcome the news that "New York's Finest" now stock the complete Kenyon Line. A good product, like a good man, is hard to keep down. These stores deserve your patronage because they are endeavoring to give you only the finest merchandise available. For example, they recognize KENYON superiority as have so many manufacturers of amateur equipment such as the Hallicrafters, (See pg. 2, QST, May) Browning Laboratories, Harvey and Temco Transmitters, and many others too numerous to mention.

In the New York Area Kenyon Transformers are available at Leeds, Sun, and Harrison.



Right: the home of Sun Radio Company where Hams are served by W2JEH, W2DXC, and W2LFY. The welcome mat is always out.

Left: Sam Schwartz who has been selling "quality" to amateurs since 1922.



KENYON TRANSFORMER CO., Inc.

840 BARRY ST., NEW YORK, N. Y.

Export Department: 25 Warren St., New York, N. Y.



THE AMERICAN RADIO RELAY LEAGUE

Directors

<i>President</i>	
EUGENE C. WOODRUFF	W8CMP 234 W. Fairmount Ave., State College, Pa.
<i>Vice-President</i>	
GEORGE W. BAILEY	W1KH 74 Webster Road, Weston, Mass.
<i>Canadian General Manager</i>	
ALEX REID	VE2BE 169 Logan Ave., St. Lambert, P. Q.
<i>Atlantic Division</i>	
WALTER BRADLEY MARTIN	W3QV Box 612, Roslyn, Pa.
<i>Central Division</i>	
R. H. G. MATHEWS	ex-W9ZN 100 East Ohio St., Chicago
<i>Dakota Division</i>	
FRED W. YOUNG	W9MZN 107 Hanover St., Mankato, Minn.
<i>Delta Division</i>	
E. RAY ARLEDGE	W58I P.O. Box 286, Pine Bluff, Ark.
<i>Hudson Division</i>	
KENNETH T. HILL	W2AHC 115 Willow St., Douglaston, L. I., N. Y.
<i>Midwest Division</i>	
FLOYD E. NORWINE, JR.	W9EFC 120 South Fourth St., St. Louis, Mo.
<i>New England Division</i>	
PERCY C. NOBLE	W1BVR 37 Broad St., Westfield, Mass.
<i>Northwestern Division</i>	
RALPH J. GIBBONS	W7KY c/o United Air Lines, Portland, Ore.
<i>Pacific Division</i>	
J. L. McCARGAR	W6EY 66 Hamilton Pl., Oakland, Calif.
<i>Ranoke Division</i>	
H. L. CAVENESS	W4DW State College Station, Raleigh, N. C.
<i>Rocky Mountain Division</i>	
GLEN R. GLASSCOCK	W9FA 2164 So. Corona St., Denver
<i>Southeastern Division</i>	
BENNETT R. ADAMS, JR.	W4APU 1512 Grove Place, Homewood, Ala.
<i>Southwestern Division</i>	
CHARLES E. BLALACK	W6GG 1273 Main St., El Centro, Calif.
<i>West Gulf Division</i>	
WILLIAM A. GREEN	W5BKH 801 Ross St., Abilene, Texas

THE AMERICAN RADIO RELAY LEAGUE, INC., is a non-commercial association of radio amateurs, bonded for the promotion of interest in amateur radio communication and experimentation, for the relaying of messages by radio, for the advancement of the radio art and of the public welfare, for the representation of the radio amateur in legislative matters, and for the maintenance of fraternalism and a high standard of conduct.

It is an incorporated association without capital stock, chartered under the laws of Connecticut. Its affairs are governed by a Board of Directors, elected every two years by the general membership. The officers are elected or appointed by the Directors. The League is non-commercial and no one commercially engaged in the manufacture, sale or rental of radio apparatus is eligible to membership on its board.

"Of, by and for the amateur," it numbers within its ranks practically every worth-while amateur in the nation and has a history of glorious achievement as the standard-bearer in amateur affairs.

Inquiries regarding membership are solicited. A bona fide interest in amateur radio is the only essential qualification; ownership of a transmitting station and knowledge of the code are not prerequisite. Correspondence should be addressed to the Secretary.



HIRAM PERCY MAXIM, FIRST PRESIDENT

Officers

President	EUGENE C. WOODRUFF, W8CMP State College, Pa.
Vice-President	GEORGE W. BAILEY, W1KH Weston, Mass.
Secretary	KENNETH B. WARNER, W1EH West Hartford, Connecticut
Treasurer	ARTHUR A. HEBERT, W1ES West Hartford, Connecticut
Communications Mgr.	F. EDWARD HANDY, W1BDI West Hartford, Connecticut
General Counsel	PAUL M. SEGAL 1026 Woodward Building, Washington, D. C.

Address all general correspondence to the administrative headquarters at West Hartford, Connecticut.

"IT SEEMS TO US—"

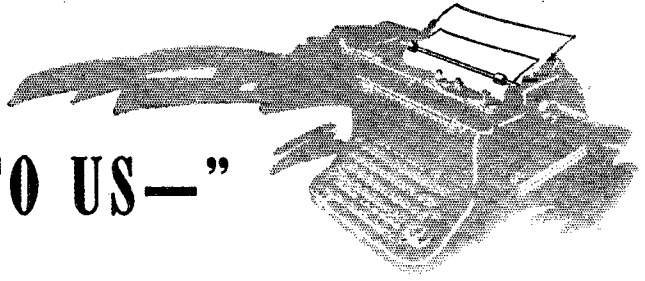

It is time that amateur radio and the broadcast-listening public and the Communications Commission and the BCL-receiver manufacturers of the country awoke to the fact that the 1939 crop of broadcast receivers is the most generally unsatisfactory that has been produced in many a year. With rare exceptions they represent a plunge back to the dark early days of the first a.c. superhets.

The situation is an alarming one from many standpoints but particularly from our own. The reason for it, although not the excuse, is to be found in the economic conditions of the times. It is hard to sell radio sets. Most of the receivers sold last year were table models; the average retail price was \$30. Judging from indicated current sales, the average this year will be still lower. You can't make much of a set for that. Competition is fierce, the advertising hullabaloo about new improvements tremendous. The public has been led to expect push-button tuning, remote control and heaven only knows what other marvels. As a result, the manufacturers have cut corners and neglected essentials in order to provide unnecessary trappings at a price. Down has gone the factor of safety in parts and, more important, down have gone audio quality and selectivity.

We don't think we go too far in asserting that the average reproduction on this year's sets is worse than those of five years ago. Of course those earlier sets cost more but an effort has been made to make the public believe that to-day's cheap sets outperform the old ones. It ain't necessarily so; in fact, as a general statement, the reverse is true. Many a prospective BCL purchaser finds that his old dog of a receiver still sounds better than the current models. The temporary economic pressure has led the manufacturers into too much corner-cutting and the public has begun to find it out. This isn't our omniscience at work — ask any dealer or read the trade papers.

The most serious respect in which this year's crop of receivers is inferior is in their inability to discriminate against the unwanted signals of other services. Preselection has been generally abandoned! The average cheap set of today has no tuned r.f. and even some of the

expensive models are completely devoid of preselection. To be able to save a dollar or so in production costs, the sets have been thrown open to interference from other services — services that work *on their own frequencies* in accordance with the highest standards of technique and that interfere through no fault of their own. Preselection doesn't add to adjacent-channel selectivity and the argument seems to be that if something has to be left out to get down the price, it ought to be the preselection rather than the gingerbread and gim-cracks; and we've even heard it seriously advanced that, since many of the public may never experience the interference conditions that preselection guards against, it is a shame for all the public to have to pay for building it into their sets.

The trouble, of course, is from images, that curse of the superheterodyne. The absence of preselection wouldn't be important on any other type of receiver. But the superhet, by its very nature, has an infinitude of responses, what with plus and minus beat frequencies, oscillator harmonics, cross-modulation and all the other variations of its very complex geometry. It simply manufactures trouble for itself. Its peculiar innards reach out and grab signals from other services hundreds of kilocycles away and announce that they are smack-bang on the frequency of the desired program. Preselection (plus good shielding) cures these things and that is why its use is essential. Then the superhet becomes man's best receiver for almost every service. But to build superhets in this crowded day without preselection is . . . well, it isn't criminal in the strict sense of the word but it ought to be, and it's certainly dumb. The set manufacturers themselves must be responsible for this omission of essential parts; their engineers undoubtedly tell them better.

Now this is an appalling situation. Here we have millions of sets going into circulation, represented as 1939's last gasp but actually vile and sleazy things. They are "modern" in that they're new but in every other respect most of them represent a serious retrogression in technique. They are going into service in the

homes of America, adjacent to 51,000 amateur transmitters and many hundreds of police, coastal and other stations. Serious interference is inevitable. The public may come to realize that "they wuz robbed," but they're stuck and they're going to holler anyway. We seem to have a difficult period on our hands.

It isn't our fault. We take this opportunity to point out publicly that when inadequately-designed receivers experience interference from transmitters on widely-removed bands, operating in full accord with good technique and comprehensive regulations, the receivers are not entitled to protection. Amateur regulations provide that if an amateur cannot so adjust his transmitter that it does not cause *general interference* on broadcast receiving apparatus of *modern design*, he must observe certain quiet hours. But we point out that the deliberate discarding of preselection makes these receivers of anything but modern design and therefore not warranting this discommoding of other services. We believe that the engineering department of the Federal Communications Commission is in full agreement with this point of view. There is nothing whatever that man can do to a transmitter to prevent it from interfering under these circumstances. There is little that can be done to the receiver. A wave-trap offers relief in an isolated instance but if wave-traps are to be added for every frequency used by every amateur station in the vicinity they will outbulk the receiver itself.

The manufacturers have only themselves to blame for this situation. For years back the A.R.R.L. has been in contact with the Radio Manufacturers Association on this subject. We have had a representative sitting on some of their committees. In mid-1937 the A.R.R.L. Board of Directors memorialized the R.M.A. on this very topic. The design engineers know that preselection is imperative for protection. It must be the production and sales branches that have stuck their necks out.

Where do *we* go from here? Well, the League will continue to take pains to show the Commission in Washington that the fault lies in the receivers and not in any sudden madness on the part of amateur transmitters; in short, that these receivers are not of modern design and therefore are not entitled to protection from interference. But there is much that the individual amateur must do for himself. You're going to have complaints from neighbors and you're going to be investigated by F.C.C. inspectors. Your neighbor is not going to take easily to the thought that his new 1939 receiver is fundamentally worthless. You're going to have to be tactful and diplomatic in explaining, and not too loud in standing up for your rights. You're going to have to remember that maybe you *are* interfering on sets of mod-

ern design and you must be prepared to do everything that can be done to improve your own transmitter and to make out a case for yourself with F.C.C. You might as well lay in a few wave-traps and have them ready. If you find your neighbor stuck with a set naked to interference, perhaps you can assist him in throwing it back where he got it and exchanging it for one with preselection; if he can't do that he might as well know the worst, but break the news gently. Be prepared, of course, for resistance from the dealer, who'll probably feel that he has to defend that set if it is the best he has to offer; get in your licks first. But try to work with the dealer, not against him. After all, the poor dealer has to eat, and the sets aren't his fault, either — he *wants* to sell a better set. Finally, we can perhaps all help by giving guidance to our friends in their purchase of new sets and in persuading our dealer friends to select lines that give the customer — as well as ourselves — a break.

But it's a burning shame nonetheless!

K. B. W.

★ SPLATTER ★

AFTER reading Griffin's latest yarn we wish more than ever we knew more about building kites. ★ ★ ★

Those who built Grammer's low-cost regenerative S.S. super, one of the most popular receivers to come down the pike, will be interested in reading of an improvement that may be incorporated. This is described on page 37.

★ ★ ★
"Saving Life," the American Red Cross poster showing the prone pressure method of artificial respiration, is available to any licensed amateur, free of charge, upon request to A.R.R.L. Hq. This poster shows, by picture and large-print text, how to carry out resuscitation from electrical shock. There should be one on every shack wall. Write for yours to-day.

★ ★ ★
In W5BKS' story on the peak-limiting amplifier (p. 36, April *QST*) we should have mentioned that credit for the development of the basic limiting circuit belongs to the Collins Radio Co., the circuit being incorporated in their 26C Limiting Amplifier. First detailed description was by Frank M. Davis, in December, 1938, *Electronics*. ★ ★ ★

The avalanche of Safety Slogans received makes it necessary for us to delay a month on announcing the winner of the \$25 prize.

(Continued on page 78)

Just about the size of a Brownie camera, this two-band converter can be tucked away in any convenient corner in the driver's compartment. It takes its power — and very little at that — from the car broadcast receiver, and does a mighty good job of picking up 5- and 10-meter 'phones. A flip of a switch brings in either ham signals or b.c. programs.

A Compact "Five and Ten" Converter for Mobile Use

Single-Tube Unit with Band Switching

BY THOMAS P. CHAPMAN,* WIKK

DX ON WHEELS from a box 3 by 4 by 5! Here is an inexpensive way of getting some real enjoyment out of ham radio during the sunny summer months and, incidentally, a solution for power failure during emergency. This article describes the construction of a single-tube converter, with band switching, for both 5- and 10-meter reception. The converter is really "hot" when working into a car receiver of average sensitivity. The size of the unit allows easy mounting on either dash or steering post, utilizing direct drive to the tuning condensers and eliminating the backlash so common to the flexible cable for remote control.

The circuit, shown in Fig. 1, uses a 6K8 triode-hexode converter tube in an arrangement which is not entirely conventional. A Colpitts type oscillator is used, having the advantage that it permits grounding the rotor of the tuning condenser, thus simplifying the insulation problem and eliminating hand capacity; furthermore, the oscillator coil need not be tapped, nor is an extra tickler coil required. The Hazeltine method of coupling the grid circuit to the antenna is used,

*20 State St., Bondsville, Mass.

the antenna coil (identical to the oscillator coil) being fed from the antenna at the low-impedance point, thus decreasing the possibility of trouble caused by antenna loading with the coupling coils commonly used. The gain in the converter is exceptionally good, and results chiefly from the use of a tuned antenna, which is a quarter-wave Marconi (length adjusted to the band in use) on the rear bumper of the car. It is coupled to the converter through a low impedance (36-ohm) cable.

An important feature of the circuit is the use of two midget neon bulbs in series as voltage regulators for the oscillator. Because the voltage drop across them is constant, variation in "B" voltage is negligible over a wide range of input-voltage change due to generator fluctuation. This eliminates frequency change in the oscillator. The neon bulbs are a standard G.E. item, type T-2, without resistor.

Construction

The box is a Bud No. 728 with the 4 by 5 sides removable. The tuning control is on one 3 by 4 side. The chassis, with band-switch, oscillator,

◆
This compact converter unit works on both 23 and 56 Mc. with any car broadcast receiver. The steering-column mounting, fastened to one side of the case, was salvaged from some commercial equipment, but a similar mounting could easily be constructed from metal strip.
◆

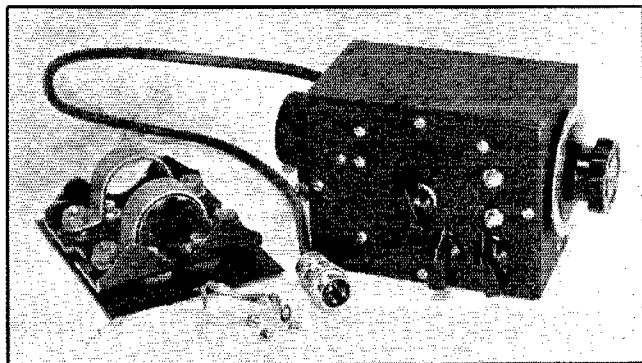

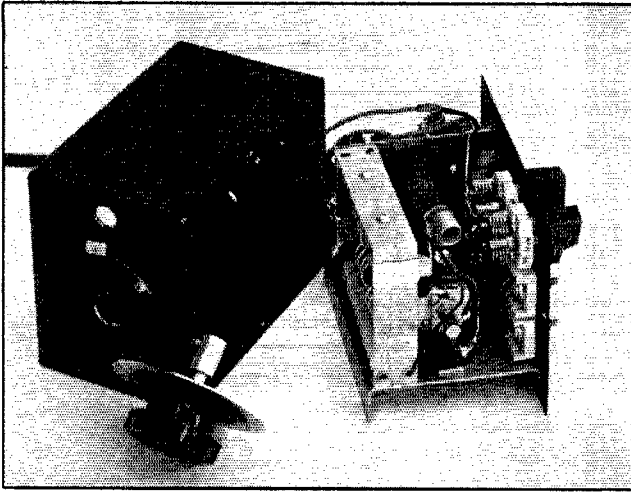

A look at the chassis from the tuning-control end. The tuning dial connects to the condensers through a rigid coupling. The two air trimmers at the upper right are on the oscillator coils; the mica-compression units below trim the antenna coils. The 6K8 tube mounts horizontally on the vertical plate toward the rear of the chassis.

and antenna trimmers, is mounted on one of the 4 by 5 sides. To the other side is attached the fixture used to mount the unit to the steering post or instrument panel. The other 3 by 4 side is utilized for the i.f. transformer, the power cable, the antenna input and output, and the double-pole double-throw switch for cutting out the converter to permit broadcast reception on the car radio.

The chassis is of $\frac{1}{16}$ -inch aluminum, $2\frac{1}{8}$ by 4 inches, with side lips bent as shown in the photographs. A $2\frac{3}{4}$ by 3-inch aluminum plate is mounted vertically an inch from one end; and an L-shaped bracket is fastened to the chassis and plate as shown in one view. This assembly is attached to the side panel so as to clear the box flanges, and as near the front as possible. This will provide room between the chassis and the rear of the box for all necessary wiring to the socket, power cable, neon tubes, and other parts. The i.f. transformer and antenna switch can be fitted in this space, with care in layout, if the constructor prefers not to construct small boxes to house them on the outside. The housings shown in the photograph are from a commercial car set and may not be readily obtainable.

Although there is not much room to spare, no difficulty should

be encountered in mounting the parts. The chassis was laid out to utilize the space to the greatest advantage by locating the parts to obtain the shortest connections. The tuning condensers, coils, socket and other parts are mounted to the sub-chassis, then this assembly is mounted to the side panel and is ready for wiring. Solid insulated wire (No. 20) is used for hooking up because it is more rigid than the stranded variety. Wiring from the oscillator and antenna trimmers, and from the band switch to the 5- and 10-meter coils, will pass under the tube, but because the wiring is done more easily with the tube out of the socket it is well to remember this and allow for extra length in the leads. Grounds in the oscillator section are made at the socket, when possible, and in the antenna section to a central point at the control-shaft end of

the ganged condenser.

The i.f. transformer could be solenoid-wound, but a 1500-kc. unit can be purchased for a nominal sum and will be considerably more compact. The combination of the iron-core permeability-tuned coil and silvered-mica condenser gives very good stability. The unit used here has one-hole mounting and is of such size that it mounts very neatly in the rear of the box.

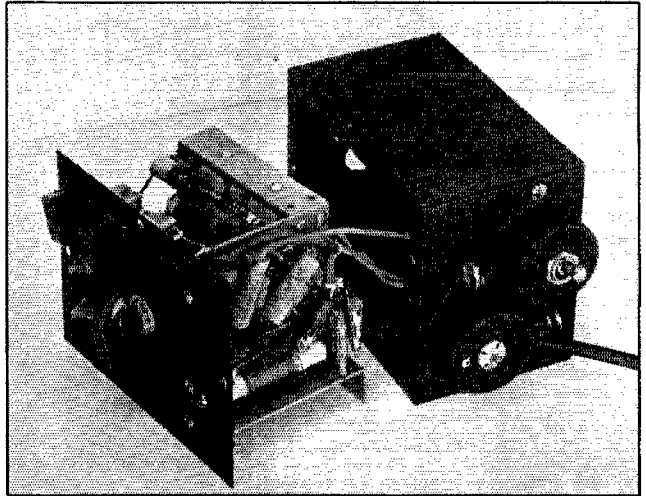

By-pass condensers, the r.f. choke, and the neon bulbs are mounted behind the plate holding the tube socket. The oscillator trimmer condensers and the band switch are controlled from the side panel. The cup-shaped enclosures on the end of the box contain the antenna switch and the i.f. output transformer.

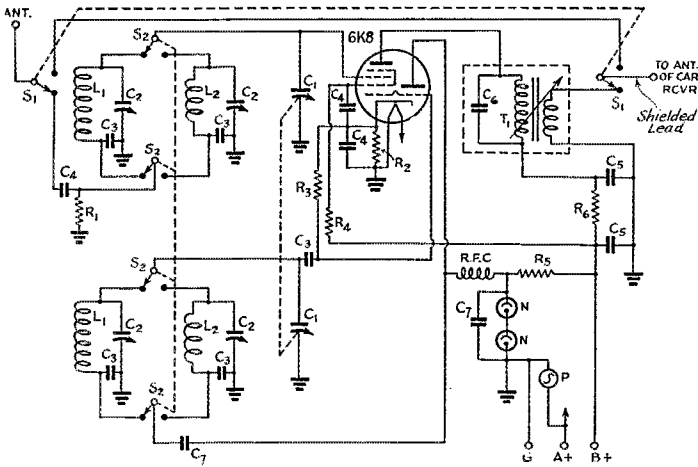

Fig. 1 — Circuit diagram of the 28-56-Mc. converter.

- | | |
|-------------------------------------------------------------------------------------------------------------------|---------------------------------------------------------------------------------------------------------|
| C ₁ — 5-15- μ fd. variable; ganged units (Sickles Type R trimmers). | R ₆ — 1000 ohms, $\frac{1}{2}$ -watt. |
| C ₂ — 30- μ fd. trimmers (air type for oscillator coils, mica compression type for antenna coils). | L ₁ — 10 turns No. 18 tinned copper, diameter $\frac{1}{2}$ inch, length $\frac{3}{4}$ inch. |
| C ₃ — 100- μ fd. midget mica. | L ₂ — 4 turns No. 18 tinned copper, diameter $\frac{1}{2}$ inch, length $\frac{3}{4}$ inch. |
| C ₄ — 0.01- μ fd. paper (small size). | T ₁ — 1500-ke. i.f. transformer with 15-turn output coil wound close to primary. |
| C ₅ — 0.1- μ fd. paper. | N — Midget neon lamps. |
| C ₆ — 30- μ fd. low-drift mica (in i.f. unit). | P — Pilot light. |
| C ₇ — 0.002- μ fd. midget mica. | RFC — 5-meter choke (Sickles). |
| R ₁ — 0.1 megohm, $\frac{1}{2}$ -watt. | S ₁ — D.p.d.t. toggle switch. |
| R ₂ — 300 ohms, $\frac{1}{2}$ -watt. | S ₂ — 4-pole double-throw wafer switch (Yaxley 3100). |
| R ₃ — 50,000 ohms, $\frac{1}{2}$ -watt. | |
| R ₄ — 30,000 ohms, $\frac{1}{2}$ -watt. | |
| R ₅ — 25,000 ohms, 1-watt. | |

Power for the unit is taken from the broadcast receiver. A three-prong shielded plug and socket (Amphenol) are used for the connection. The socket is mounted at any convenient location on the broadcast set and the "B" plus, "hot" filament and ground connected to it. On the diagram, the negative "A" is shown grounded, but in some cars the positive battery terminal is grounded; in such a case, the "A" polarities shown should be reversed, of course. A three-wire shielded cable carries the voltages to the converter. Connections for the antenna and for the converter to broadcast receiver antenna are made with bayonet-type fuse holders. Setting up the converter in the car for operation takes but a few minutes.

Alignment

Aligning the unit is very simple. Turn on the broadcast receiver and set the volume control at maximum. Now set the broadcast receiver dial at 1500 kc. and adjust the i.f. transformer on the converter to get the greatest noise. This alone may not bring the

noise up to a maximum and the antenna trimmer of the broadcast receiver should be adjusted to compensate for any loading caused by the converter. Most car sets use low-impedance antenna inputs, and the converter i.f. transformer was made with this in mind. After aligning the i.f. system, the converter r.f. is next. Set the band switch to ten meters and set the oscillator trimmer near maximum capacity. Now, with the tuning condenser at half capacity, adjust the antenna trimmer. This can be best adjusted by introducing a little noise either from an electric razor or buzzer at some little distance from the car. This same procedure is followed in adjusting the 5-meter range. This elementary tuning-up procedure will give a starting point and as soon as a few stations have been logged the final adjustments to oscillator and antenna trimmers can be made and the dial calibrated. The oscillator, incidentally, is operated on the low-frequency

side of the signal to get greatest stability. This unit has been used to work portable-mobile for a few months with several local and DX stations. No trouble has been experienced in operation except from ignition in other cars. The usual methods of taking out ignition QRM in this

(Continued on page 94)

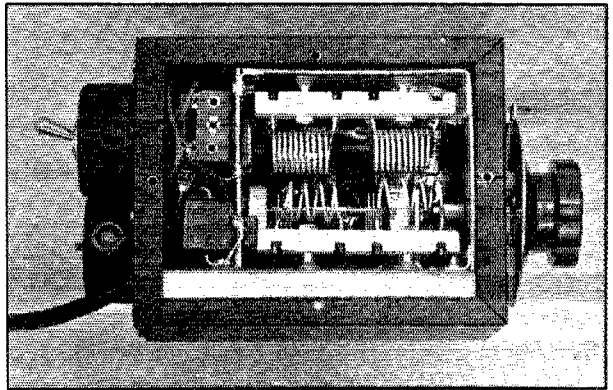

A glimpse inside the case from the mounting side. The two coil sets are mounted inside an L-shaped bracket. The tuning condensers are visible behind the coils.

Fashions in Antennas

*The Latest on What the DX Boys
Are Wearing*

BY BYRON GOODMAN,* WIJPE

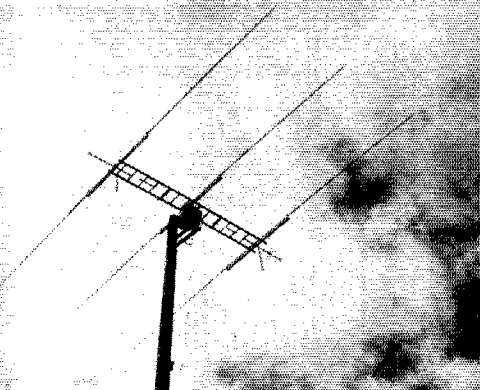

The rotary at W9TB is 54 feet above the ground. It is the conventional 3-element beam on 14 Mc., but the remote switching of matching stubs converts it into a 6-element array on 28 Mc.

THE good old days are over!

Right now, in 1939, is as good a time as any to face the facts. No longer can old Final Authority tell the boys at the club that a Hartley gets out better than a Colpitts and cinch his argument by producing cards from EG and SB, leaving nothing for discussion except where the gang will spend Field Day. Even little Johnny New-ham knows that the transmitter, once it has been tamed and house-broken, needs only to key well put out from 40 per cent to 75 per cent of its input, and work every time it's asked to. From that point on, the story depends on the operator and — yes, that's right — the antenna. Suspecting that the high-scorers in the 1939 DX Contest might be up on these things, since even at this late date results speak louder than anything except politicians and interfered-with BCL's, we asked around to see what was being used. Maybe there will be some conclusions to draw before we get through, and maybe not. Let's take a look.

W3CHE

FOUR different antennas are used at W3CHE. On 28 Mc., a half-wave vertical about 80 feet above the ground is fed with a 600-ohm line and a quarter-wave stub in the familiar "J"-type system. Frankly, Dan didn't like it much, and says there were times when he thought it was 80 feet *below* the ground!

Two beams are used on 14 Mc. One, for Europe, is a 6-element Sterba curtain,¹ the top of which is about 65 feet above ground. A quarter-wave matching section has been used with this antenna, but it was found that nearly as good a match is obtained without, and so the 600-ohm line ties into the curtain directly. The other 14-Mc. antenna, for Asia and South America, consists of three horizontal collinear half-wave elements mounted a half-wave above three similar half-wave elements, and all the elements are connected so as to be driven in phase. It is simply an extension of the familiar "lazy H". The top of

* Assistant Technical Editor.

¹ Wallace, "Making the Most of Directive Antennas," *QST*, November, 1937.

this antenna is about 70 feet above the ground, and the system is fed by 600-ohm line and quarter-wave section. This one is Dan's favorite antenna, and has helped him considerably during his skeds with XU2AW and his other Asian contacts.

The 40-meter wire is 240 feet long, center-fed by tuned feeders, and the height runs from 65 feet at the ends to 50 feet at the center. This one is also used for South Africa on 20 and on 10 every time the vertical conks out.

A plug-and-jack system for selecting the various antennas is supplemented by a relay system which allows instantaneous shift from one antenna to another. A switching system allows any antenna to be connected to the receiver, for comparison purposes on weak signals.

W3EMM

FIVE antennas are used at W3EMM. On 7 Mc., a V with 135-foot legs and an angle of 90 degrees hangs 65 feet in the air. It is fed with a tuned line and is link-coupled from its tuning unit.

Three 6-element Sterba curtains are used on 20, giving Africa-Australia, Asia-South America and European coverage. The curtains are from 55 to 60 feet high, and are fed in the same manner as that at W3CHE. All the feed lines are balanced to give the same loading on the transmitter, making it a simple matter to switch from one to the other at an instant's notice.

The 28-Mc. antenna is a two-element rotatable job 55 feet high, fed by a matched open line.

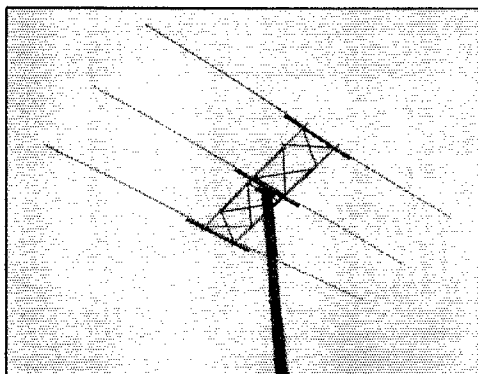

W2UK's rotary 14-Mc. beam is 60 feet above the ground. A 600-ohm line ties into the half-wave matching stub.

Comparing his antennas, W3EMM says, "I might say that with a rotary you can put it right on the nose and get very good complete coverage with it. On the other hand, you can get a better signal with a big fixed array in its favored direction. With relay selection like I have, almost instantaneous choice can be had of the direction to shoot. In receiving, it helps to be able to get a quicker check-up of the incoming signal."

W2UK

THE hurricane of last year took W2UK's old antennas down, so this year's Contest saw him with a 35-foot high, 6-element rotatable on 10, a 3-element 60-foot high rotatable on 20, and two 45-foot high extended doublets, mounted at right angles, on 7 Mc. Since Tommy gave his rotatables plenty of workout in the Contest, his comments are interesting.

"... To be worth while, a rotating unit must be strong enough to withstand severe storms, as it is a costly and difficult proposition to raise and lower a 3-element beam from a 60-foot pole. It takes two riggers with safety belts to do the job.

"The 10-meter beam was only a short distance from the operating room so I figured I could use ropes and pulleys to control it. Here was another mistake, as it was impossible for me to hold the ropes tight enough to prevent the beam from swinging around in the high winds. A 6-element beam is quite sharp, and swinging the beam a few degrees will materially affect its operation.

"Due to the lack of space, it was necessary to run the 7-Mc. extended doublets rather close to the rotary beams. It soon became apparent that these antennas were reacting on the beams, and at times it was necessary to lower the extended doublets before I could raise a difficult DX station. In erecting rotaries, it is undoubtedly important that they be in the clear and well away from other antennas and objects.

"I... lost much valuable time by not being able to rotate the beams quickly and accurately when it was necessary."

W6GRL

DR. CHARLES STUART has about the most extensive antenna system we've heard of outside of Rocky Point. The location of his station is a flat sandy stretch of beach about a half mile wide and 500 feet from the ocean. However, he is hemmed in on three sides by power lines which

Maybe you have a lot of room and haven't decided what antenna to try next. Or possibly you have practically no room at all and would like to gun up your signal. You'll find both ideas and consolation in this story of the antennas of the top-flight DX men.

give him a square of about 600 feet to work in. Field strength tests have shown that the location is not particularly favorable, hence the multiplicity of directive antennas.

All of the antennas are supported by 70-foot poles, and it takes 10 in all to handle the various systems. One fundamental system, which can be used on all bands, consists of five V beams evenly spaced radially from a central support. The five feeder wires are brought down to the shack in a cage arrangement, and the lengths have all been matched so that series tuning can be used on all bands. Any one of the five antennas can be selected by a single rotary switch.

On 7 Mc., supplementing the V's, W6GRL uses four horizontal collinear half-waves in phase for Europe and two collinear half-waves pointed east-west.

The 14-Mc. antennas include the V's, a 3 1/4-wave on a side rhombic for Europe, and three "lazy H" antennas, for Asia and South

America, Europe and New Zealand, and Australia and Africa.

The rhombic and V's are used on 28 Mc., and a rotatable "lazy H" is used to fill in the gaps.

Quarter-wave matching stubs and 600-ohm lines are used to feed the lazy H's, and the rhombic is fed with a 700-ohm line and terminated by a 750-ohm line of No. 25 nichrome wire. Split tank coils are used in the final amplifier and the antenna coil is placed between the two tank-coil sections. The antenna coil is split and a variable condenser connected between the two halves. Varying the condenser capacity varies the loading on the final amplifier.

W9TJ

FIVE V beams are used at W9TJ, supported by 42-foot poles. The 138-foot long wires run radially from the center support at an angle of 72° between adjacent wires. The tuned feeders come into the shack in a five-wire cage, with 6-inch separation between feed wires. The five feed-wires are brought to Pyrex bowls inside the

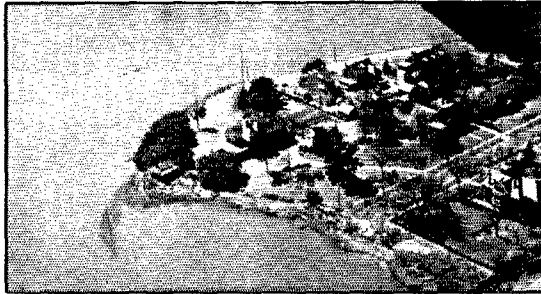

The high poles on the point and along the water's edge belong to the antenna system at W3EMM. W3EMM's is the house on the point.

shack, on which are mounted heavy-duty jacks. Two plugs on flexible leads enable any pair of feed wires to be selected. A pi-network matching system is used to couple to the transmitter. All wires have been trimmed accurately so that no retuning is necessary when changing from one combination to another.

W9TJ points out that, since the V beams are bidirectional, actually 10 different peak directions are available with the five beams. Located on level ground at what is considered a good location (you don't find many hams admitting that!), Atkins's experience with his V-beam system has been that DX is contacted over longer periods of time than with any other type of antenna tried.

W3PC

CLEM GIBERSON has a 400-foot-on-a-side rhombic aimed at Europe supplemented by a 14-Mc. lazy H oriented in a compromise direction to give Asian and South African coverage. The lazy H has reversible reflectors which gives uni-directional operation in either direction. Clem doesn't mention how the changeover is accomplished so we can't give that dope. A similar lazy H with reversible reflectors is used on 28 Mc., with a 3-element rotatable available to fill in the gaps. Relays controlled from the operating table permit selection of the proper antenna from the operating position.

W1SZ

THE original "haywire" rhombic at Roddy's is 144 feet on a leg, at an average height of about 40 feet. Oriented so that the maximum radiation is along a northeast-southwest line, the thing seems to have enough minor lobes to give pretty effective general coverage. However, a 500-foot long wire running north and south, 90 foot high at one end and 25 at the other, is used for Asian and South American contacts. Tuned feeders are used on both antennas.

W3BES

JERRY MATHIS uses a center-fed Hertz, 33 feet on each side, running north and south at a height of 40 to 45 feet. The 29-foot feeders permit parallel tuning on all bands. Except for a

This is where the feed lines come into the shack at W3CHE.

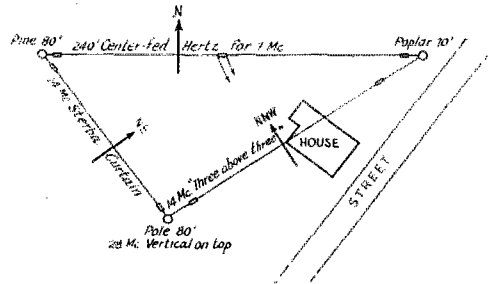

The antennas at W3CHE.

BCL antenna under one end and a 28-Mc. ham antenna 300 feet to the west, the antenna is fairly well in the clear. The maximum radiation is, of course, east and west on 7 and 14 Mc., and S9 reports are consistently obtained from Africa.

W4CEN

THE location of W4CEN is quiet and quite good for reception, but it is covered with tall trees that apparently absorb a lot of power. However, room has been found for three different antennas. A 14-Mc. Q-fed vertical half-wave is mounted above the tops of the trees at a height of 70 feet; a half-wave current-fed Hertz, sloping from 40 to 20 feet high, is used on 7 Mc., and a 3-wavelength 20-meter V beam is also available. No particular directivity is noticeable on the V on either transmitting or reception and, since it is better than the "Q" on reception, it is used only for receiving. On the other hand, the "Q" is superior on transmission on both 20 and 10 (with tuned feeders), which Tom suspects is due to the fact that it is the only wire he has been able to get above the trees.

W9TB

A FEW years ago W9TB hand-picked a location and thought he would have things all to himself. Now, however, they are building houses and roads around his shack, and each day he becomes more unhappy about the whole thing.

He has four poles 53 feet high. One pole has been extended to 78 feet, and a 7-Mc. vertical half-wave is hung from this. The vertical's effectiveness is rated as "fair." One of the other poles supports a 10- and 20-meter rotatable antenna. This is the usual 3-element 14-Mc. rotatable modified with additional stubs that can be switched in to convert it to a 6-element 28-Mc. beam (two collinear half-waves in phase, with parasitic directors and reflectors).

The 7-Mc. vertical is rigged up so that it may be used as two half-waves in phase on 20, for general listening, and a pair of vertical half-waves are used for the same purpose on 10 meters. All antennas are fed with 600-ohm lines which terminate at antenna-switching relays.



WITW

THE antennas at WITW are designed for 14-Mc. work, with the result that operation on the other bands is something of a compromise. A four-section flat-top (or "W8JK") beam, 33 feet high, is used for Asia and South America. Fed by a 600-ohm line and $\frac{3}{4}$ -wave matching stub, Jeff finds this antenna has a low and rather critical radiation angle. For Australia and Africa, a $4\frac{1}{2}$ -wavelength V beam is used, 33 feet high, fed by a 600-ohm line and $\frac{3}{4}$ -wave matching stub. For Europe, a $2\frac{1}{4}$ -wavelength per leg terminated rhombic, 33 feet high, is fed by a transmission line of No. 16 wire spaced 13 inches, and is the favorite antenna of the lot. Terminated or not, it outperforms all the others.

Since the Contest, WITW has added a centered half-wave vertical, with the bottom end 11 feet above the ground. This has been found quite useful on nearby Caribbean contacts and when unusual conditions affect DX signals.

W2DC

THREE antennas did the trick at W2DC. An 80-meter double Zepp, running north and south and 80 feet above the ground, did most of the heavy work, although a current-fed 14-Mc. half-wave, 50 feet high, was used for some of the 10- and 20-meter contacts that were not covered by the pattern of the larger antenna. An extended doublet 35 feet high was also available and used on some contacts, but the higher antennas were usually superior.

All antennas and feeders have been trimmed so that the tuning is practically the same. No antenna tuning unit is used; 400- μ fd. series variable condensers are placed in each side of the feed line and the feed line is then tapped directly on to the final tank inductance. High voltage mica condensers are replaced in the feeders to remove the high voltage from the variable condensers and the antenna.

W8BTI

HERE a 45-foot high $3\frac{1}{2}$ -wavelength Hertz is used on 28 Mc., Q-matched at the center to a 465-ohm line. A somewhat

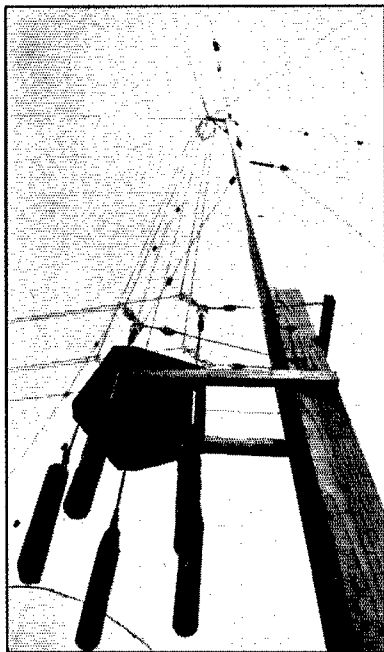

The center pole of the V-beam system at W9TJ. The counterweights and gadgets keep the feed lines aligned and in electrical balance at all times.

similar $3\frac{1}{2}$ -wavelength Q-fed Hertz is used on 14 Mc., and the feeders are tuned for 28-Mc. operation, where its radiation pattern fills in some of the gaps of the other 10-meter antenna. A 3-element rotatable beam, 33 feet high, is also used on 20. After trying and discarding as inefficient several feed systems for the rotatable antenna, Luhn now uses a quarter-wave of EO-1 cable as a Q-match between the antenna and a 600-ohm line.

On 7 Mc., a half-wave Hertz, fed with low-impedance line at the center, is used. The 14-Mc. Q-matched Hertz can be used with tuned feeders on 40 and is, in effect, an extended doublet.

W6OCH

WITH $2\frac{1}{2}$ acres of flat open country available for antennas, you would expect to see some nice antennas at W6OCH. You won't be disappointed, either. A terminated rhombic, 182 feet on a leg, is used for Europe on both 10 and 20. Three 14-Mc. 8-element Sterba curtains are available for South America and the Orient, South Africa and Netherland East Indies and Australia and Central Africa. On 10, one 8-element Sterba curtain is used for South America and the Orient, and another similar antenna can be swung to cover Australia and Africa or the West Indies. All antennas are supported by 55-foot poles.

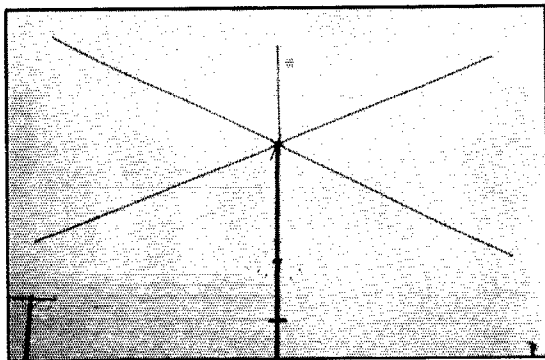

The ingenious 28-Mc. rotary at W6GRL is a "lazy H" fed by 600-ohm line and quarter-wave matching stub. The whole pole rotates, being set in a thrust bearing at the bottom and having another bearing at the juncture of the guy wires. Since the system is bi-directional, only 180° rotation is necessary, and the feed-line doesn't tangle.

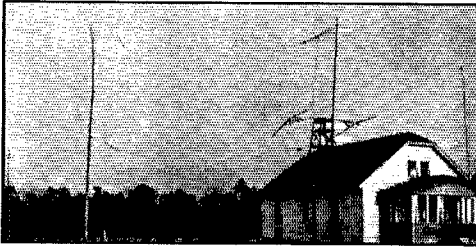

Some of the skywires at W3PC. The right-hand pole supports one end of the rhombic for Europe, the rotary 28-Mc. beam shows up on the roof, and the 14-Mc. "lazy H with reversible reflector" can be seen in the foreground.

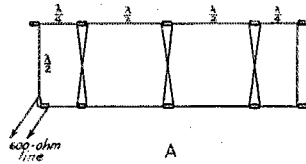

A

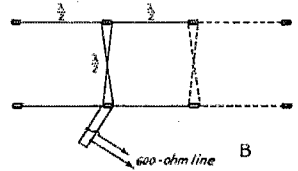

B

The 6-element Sterba curtain shown at A is the type used by W3CHE and W3EMM. Additional elements can be added for greater horizontal directivity.

The "lazy H" type of antenna is shown by the solid lines at B. Many stations add two additional elements, as shown by the dotted lines.

All of the systems are fed by 600-ohm lines which couple directly on to the final tank, and any antenna can be selected by suitable relays and switches.

W6ITH

SIX antennas are available at W6ITH, giving rather complete coverage. A 14-Mc. horizontal half-wave, matched-impedance fed, is broadside to South Africa and Java. Up in the air about 80 feet, it is a useful antenna on general contacts, and is used about 80 per cent of the time. A 14-Mc. lazy H, 80 feet in the air, is broadside to South America and India, and, because of the low angle of radiation, is very effective on DX contacts.

(Continued on page 72)

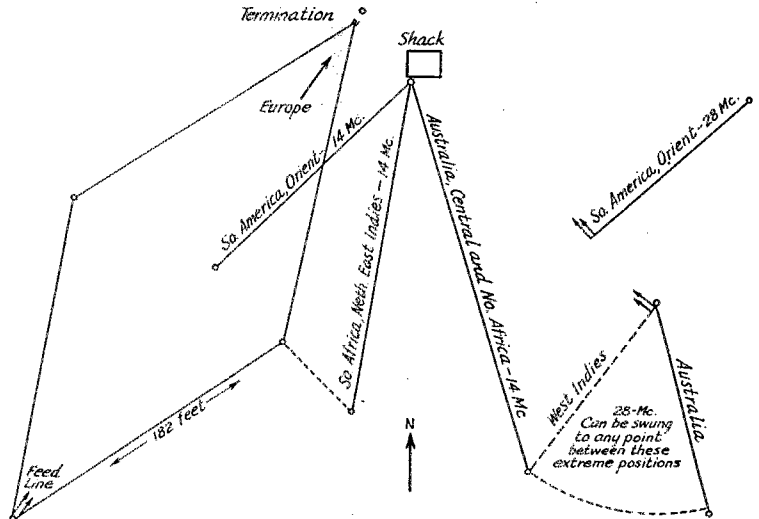

© The terminated rhombic for Europe at W6OCH is supplemented by five 8-element Sterba curtains for the other directions.



W6GRL really goes in for antennas. The nine tall poles that can be seen all help support the antennas, and there is one more pole that couldn't be squeezed into the picture. One pole is 105 feet high, and the rest are only a measly (by comparison) 70 feet.

★ WHAT THE LEAGUE IS DOING ★

1939 BOARD MEETS

SALUTING the West Coast, the A.R.R.L. Board of Directors, meeting west of Chicago for the first time in its history, held its 1939 annual meeting at San Francisco's Clift Hotel on Friday and Saturday, May 5th and 6th.

For two days the fourteen directors, Canadian General Manager and officers deliberated League affairs in the Clift's roof lounge, overlooking the colorful grounds of Treasure Island and the sweep of mighty Oakland Bay bridge. Then, work over, members of the Board spent Sunday inspecting Pan American Airways' base for Pacific flights and W6USA at Treasure Island, the amateur station of the Golden Gate International Exposition.

That night the Board was fêted by East Bay amateurs at dinner in the Leamington Hotel in Oakland. Again, on the following Tuesday, many directors were royally welcomed at another meeting called for their benefit in Los Angeles, en route home.

Confronted with fewer than ordinary international or regulatory problems in connection with amateur radio, the 1939 Board spent its time principally in examining and perfecting the interior structure of the League.

There were, of course, some questions relating to regulations and to amateur frequency bands. Since these have the widest possible amateur interest, we report them first.

An informative poll of all amateurs was ordered taken at once on the possible desirability of opening the 7200-7300 kc. region to Class B 'phone, providing authority can be obtained; full details of this will be given in the July issue of *QST*. The Board ordered that the F.C.C. be requested to permit the use of "duplex" operation above 112 Mc. A proposal that the 160-meter band be changed to 2200-2500 kc. was rejected.

Secretary Warner was directed to attend the forthcoming Interamerican regional conference to be held in Chile in 1940, accompanied by either General Counsel Segal or Assistant Secretary Budlong. A permanent Board committee on amateur frequency assignments was set up to advise and consult with the General Manager and General Counsel on preservation of amateur frequencies through education of Congress, F.C.C. and the public, and to institute such specific actions as may assist in maintaining our present status among other radio services. Three directors are to be named by the President to constitute this committee for the current year.

Affecting the Board itself, several amendments were made in the by-laws in an endeavor to strengthen the element of democratic representa-

tion. No longer will an ineligible director remain in office through failure of his members to name an eligible candidate for election. In such cases a new solicitation for nominations is to be made every two months until an eligible nominee is named. On the other hand, otherwise eligible nominees are no longer to be thrown out due to brief lapses in their licensed amateur status.

Alternate directors are given greater stature in the League picture by new provisions which turn over to them administration of the division in the event of death or permanent or temporary inability of a director to carry on official duties. A proposal to pay directors a salary of one thousand dollars per annum was rejected by a vote of fifteen to one. A proposal to deny the vice-president voting membership on the Board was also rejected, as was a move to submit this question to a membership poll. The Board likewise rejected a proposal to alter the present make-up of the League's Executive Committee.

The Board examined closely into Headquarters activities. Instructions were given the Secretary on salaries paid certain members of his staff, and a survey of League business management by a firm of qualified efficiency experts was ordered under the supervision of a committee consisting of Vice-President Bailey, Canadian General Manager Reid, and Directors Caveness and McCargar. *QST*'s advertising policy was scrutinized and put under further study. The General Manager was directed to obtain comparative bids from other printers for the printing of *QST*. Rejected were a proposed pension plan for Headquarters employees and a suggestion that compensation be offered for *QST* articles.

A committee was set up to study an elaborate proposed reorganization plan for the Royal Order of the Wouff Hong, along lodge chapter lines. This committee is to report its recommendations at the next meeting of the Board.

Memorial plaques were ordered erected in W1AW to the memory of the late Charles H. Stewart and Ross A. Hull.

Appropriations made by the Board during the course of its meeting included the following amounts: \$6500 to defray the costs of its present meeting, \$3625 for director administration during 1940, \$3200 for representation at the Chilean conference, and \$2500 for the efficiency survey.

The Board decided to hold its next year's meeting in Hartford, beginning May 31st.

(Editor's Note: In this telegraphic report from San Francisco it has only been possible to touch briefly on the highlights of the meeting. Complete minutes will be published in the July issue of *QST*).



Photos Courtesy W3CTT and W3QY

The six-tube superhet is no larger than a copy of *QST*.

THE construction of this receiver was inspired by participation in the 1938 Field Day Contest and the article¹ in *QST* describing a low-cost superhet. Our requirements are such that we don't like to operate without a crystal filter and, after a few rough pencil sketches, it was decided that a crystal filter might be incorporated in a compact receiver without much sacrifice in performance. It was a pleasant surprise to find that the small size of our receiver provides such short leads in the signal circuits that the performance is actually improved, and it works well right down to 60 Mc.

There is nothing new in the circuit — straightforward design has been followed throughout. The regenerative mixer is a 6J7, suppressor-grid coupled to a 6K7 electron-coupled high-frequency oscillator. The mixer is coupled through a 500-kc. crystal filter to a 6L7² i.f. amplifier feeding one-half of a 6C8 used as the second detector, with the other half of the 6C8 acting as the b.f.o. A 6C5 first audio is used to drive a 6F6 or 6C5 output tube. The over-all gain is more than adequate, and even on 10 meters signals have good strength with the i.f. backed down. Regeneration in the mixer contributes substantially to the image ratio.

The receiver is housed in a Bud No. 993 cabinet which measures 6 by 10 by 7 inches. By way of comparison, we might mention that a copy of *QST* measures 6½ by 9½ inches.

Construction

It is best to purchase as many of the parts as possible before starting actual construction. This will make it easier to form a mental picture of how the various components tie in with each

* 568 W. Clapier Street, Germantown, Philadelphia, Pa.
¹ Grammer, "A Three-Tube Superhet," *QST*, August, 1938.

² A 6L7 was used instead of the more conventional 6K7 because the 6L7 was found to have better volume control characteristics. — Editor.

A QST-Size Super

**Communication-Type Performance
in a Compact Receiver**

**BY W. FRAM ALEXANDER,*
W3GFZ**

other. The chassis is a custom-built job, 9¼ by 5¼ by 2½ inches.

It is suggested that the constructor make a full-scale drawing of the position of all parts which are mounted on the chassis. The plan makes a good template, and can be fastened to the chassis with tape while all the holes are located with a sharp center-punch. The front brace was removed from the cabinet because it is not needed for strength and gets in the way when changing coils. Speaker jack, the feed-through insulator used as the antenna post, the bias switch and the four-prong power-supply socket are all mounted along the rear edge of the chassis, and corresponding one-inch holes are cut in the cabinet to clear these various components. It is suggested that three or four small holes be drilled in the back wall of the cabinet, to aid the ventilation provided by the side louvres.

The various units mounted on the front of the chassis serve to hold the panel to the chassis. They should be located high enough so that the operator's fingers can clear between the knobs and the table. The top of the main tuning dial is ¼-inch below the top of the front panel. The controls on the front panel include the bandset condenser, the b.f.o. condenser and switch (one of the rotor plates is bent so as to short-circuit the condenser in the "off" position), the mixer tuning condenser, the mixer regeneration control and the i.f. gain control, as well as the crystal phasing and selectivity controls.

The high-frequency oscillator, except for the bandset condenser, is housed in a small compartment which provides shielding from the rest of the receiver. The bandset condenser is mounted on the under-side of the chassis, and the bandspread condenser is mounted securely on the panel. Both tube and coil sockets are mounted on the pillars that are supplied with the sockets for mounting above a chassis.

Most portable receivers sacrifice something in performance to gain in space economy, but not this one. Nothing fancy or tricky that can go wrong in the field — just space-saving application of the sound principles of regenerative mixing and a crystal filter.

◆

A top view of the receiver shows the arrangement of parts. The high-frequency oscillator is housed in a separate shield compartment. A "Goat" shield is used on the 6C8G second-detector-b.f.o. tube at the right rear of the set. Note that the mixer grid lead is brought out at the top of the coil.

◆

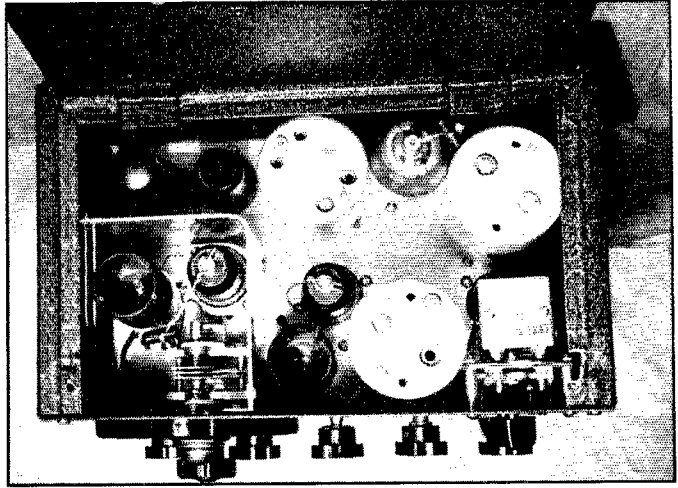

The other sockets in the set, including the mixer coil socket, are mounted on the chassis in the usual way. The mixer socket is arranged so that the plate terminal is right next to the i.f. transformer, which results in a plate lead that is quite short. The same principle is followed in the location of the i.f. amplifier tube socket. To insure stable operation, each stage has a single point on the chassis to which all ground leads for that stage are brought.

The Crystal Filter

The crystal filter unit, which is mounted at the right-hand side of the set, was made compact by mounting the phasing condenser, selectivity control and crystal one above the other. Both phasing- and selectivity-control condensers are insu-

lated from the panel by supporting them with the mounting pillars Cardwell makes for the purpose. The condenser shafts are brought out through rather large holes, to minimize the capacity to ground, but the knobs easily cover these holes and the appearance is not spoiled. The crystal socket was constructed by trimming a five-prong bakelite wafer socket so that only the plate and cathode holes remain, leaving a narrow strip of socket which includes the mounting holes. The crystal socket is also mounted on pillars, to insulate it from the panel. There isn't enough space for any type of crystal other than the flat-mounting kind, but the Bliley 500-ke. crystal used is normally furnished in the flat holder.

The i.f. tube is mounted under the crystal and just back of the two variable condensers. The in-

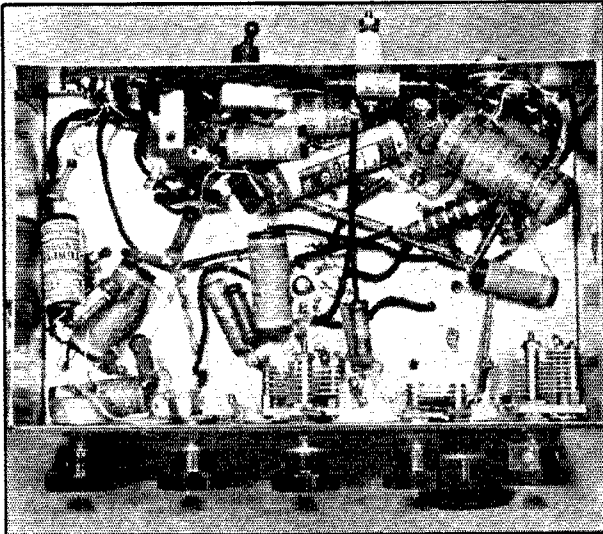

◆

A bottom view of the chassis. From right to left, the panel controls are h.f.-oscillator handset condenser, b.f.o. trimmer, mixer tuning condenser, mixer regeneration control and i.f. volume control. The switch at the rear of the chassis changes the bias on the audio output tube; the antenna connects to the feed-through insulator.

◆

COIL TABLE

Band	L_1	L_2	L_3	L_4	Bandspread Tap	Cathode Tap
3.5.....	7 turns No. 28	48 turns No. 22	6 turns No. 28	66 turns No. 22	66	18
7.0.....	6 turns No. 28	22 turns No. 22 spaced to 1" length	3 turns No. 28	14 turns No. 22 spaced to 1" length	10	5
14.....	5 turns No. 28	11 turns No. 22 spaced to 1" length	4 turns No. 28	7 1/4 turns spaced to 1 3/8" length	7 1/4	2 3/4
28.....	7 turns No. 28	6 3/4 turns No. 18 spaced to 1 1/8" length	10 turns No. 28	2 1/4 turns No. 22 spaced to 7/8"	2 1/4	3/4
56.....	5 turns No. 28	3 turns No. 22 spaced to 1" length	4 1/4 turns No. 28	1 3/4 turns No. 22 spaced to 7/8" length	1	3/4

All coils closewound with enameled wire on 1 1/4" diameter forms unless otherwise stated. One-eighth inch spacing between L_1 , L_2 , and L_3 . L_1 is wound at bottom of form, L_3 between L_1 and L_2 .

put transformer was modified by removing the regular tuning condenser and drilling two holes in the side of the can through which the secondary leads are run to the selectivity-control condenser. The second i.f. transformer, coupling the 6K7 i.f. amplifier to the 6C8 detector, was modified by drilling a hole in the side of the can for the grid lead to the 6C8. The smaller, iron-core transformers would probably fit into the design without revision, but the larger transformers used in this receiver were used because they were available.

Care must be taken with the b.f.o. assembly, because the antenna lead runs near it and picks up the harmonics. However, some leakage isn't too great a disadvantage, since the 500-kc. b.f.o. has harmonics that serve as convenient band-edge markers if they can be heard. The lead from the b.f.o. coil to the b.f.o. trimming condenser on the front panel is well shielded by running it through regular shielding braid.

There is ample space for the various by-pass condensers and resistors under the chassis, since

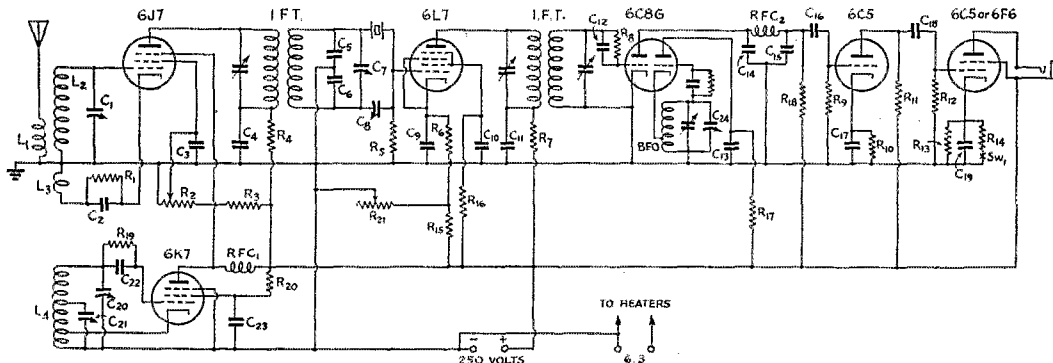

Fig. 1 — Wiring diagram of the six-tube superhet.

- | | | |
|-----------------------------------------------------------------------------------------------------------------------------------------------------------------------------------------------------------------------------------------------------------------------------------------------------------------------------------------------------------------------------------------------------------------------------------------------------------------------------------------------------------------------------------------------------------------------------------------------------------------------------------------------------------------------------------------------------------------------------------------------------------------------------------------------------------------------------------------------------------------------------------------------------------|-----------------------------------------------------------------------------------------------------------------------------------------------------------------------------------------------------------------------------------------------------------------------------------------------------------------------------------------------------------------------------------------------------------------------------------------------------------------------------------------------------------------------------------------------------------------------------------------------------------------------------------------------------------------------|-----------------------------------------------------------------------------------------------------------------------------------------------------------------------------------------------------------------------------------------------------------------------------------------------------------------------------------------------------------------------------------------------------------------------------------------------------------------------------------------------------------------------------------------------------------------------------------------------------------------------------------------------------------------------|
| <p>C_1 — 35-μfd. variable (Cardwell ZR-35-AS).</p> <p>C_2, C_4, C_{16}, C_{18}, C_{23} — 0.01-μfd., 600-volt paper.</p> <p>C_3, C_9, C_{10}, C_{11}, C_{13} — 0.1-μfd., 600-volt paper.</p> <p>C_5, C_6 — 50-μfd. postage-stamp mica.</p> <p>C_7 — 50-μfd. midget variable (Cardwell ZR-50-AS).</p> <p>C_8 — 15-μfd. midget variable (Cardwell ZR-15-AS).</p> <p>C_{12} — 250-μfd. postage-stamp mica.</p> <p>C_{14}, C_{15} — 0.001-μfd. midget mica.</p> <p>C_{17} — 5-μfd. low-voltage electrolytic.</p> | <p>C_{19} — 10-μfd. low-voltage electrolytic.</p> <p>C_{20} — 100-μfd. midget variable (Cardwell ZU-100-AS).</p> <p>C_{21} — 35-μfd. midget variable (Bud).</p> <p>C_{22} — 100-μfd. postage-stamp mica.</p> <p>C_{24} — 20-μfd. midget variable.</p> | <p>R_{10} — 2500 ohms, 1/2-watt.</p> <p>R_{11}, R_{13} — 250,000 ohms, 1/2-watt.</p> <p>R_{13} — 2500 ohms, 1-watt.</p> <p>R_{14} — 500 ohms, 5-watt, wire-wound.</p> <p>R_{16}, R_{17}, R_{19}, R_{20} — 50,000 ohms, 1/2-watt.</p> <p>R_{21} — 10,000-ohm volume control.</p> <p>I.F.T. — 500-kc. air-tuned i.f. transformers.</p> <p>B.F.O. — 500-kc. beat-frequency-oscillator assembly.</p> <p>Sw1 — S.p.s.t. toggle switch.</p> <p>RFC1 — 2.5-mh. r.f. choke (Coto-Coil).</p> <p>RFC2 — Broadcast type r.f. choke, 85 mh.</p> |
| <p>R_1 — 2000 ohms, 1/2-watt.</p> <p>R_2 — 75,000-ohm volume control.</p> <p>R_3, R_{15} — 50,000 ohms, 1-watt.</p> <p>R_4, R_7 — 1000 ohms, 1/2-watt.</p> <p>R_5, R_9, R_{12} — 500,000 ohms, 1/2-watt.</p> <p>R_6 — 200 ohms, 1/2-watt.</p> <p>R_8 — 1.5 megohm, 1/2-watt.</p> | <p>R_{10} — 2500 ohms, 1/2-watt.</p> <p>R_{11}, R_{13} — 250,000 ohms, 1/2-watt.</p> <p>R_{13} — 2500 ohms, 1-watt.</p> <p>R_{14} — 500 ohms, 5-watt, wire-wound.</p> <p>R_{16}, R_{17}, R_{19}, R_{20} — 50,000 ohms, 1/2-watt.</p> <p>R_{21} — 10,000-ohm volume control.</p> <p>I.F.T. — 500-kc. air-tuned i.f. transformers.</p> <p>B.F.O. — 500-kc. beat-frequency-oscillator assembly.</p> <p>Sw1 — S.p.s.t. toggle switch.</p> <p>RFC1 — 2.5-mh. r.f. choke (Coto-Coil).</p> <p>RFC2 — Broadcast type r.f. choke, 85 mh.</p> | <p>R_{10} — 2500 ohms, 1/2-watt.</p> <p>R_{11}, R_{13} — 250,000 ohms, 1/2-watt.</p> <p>R_{13} — 2500 ohms, 1-watt.</p> <p>R_{14} — 500 ohms, 5-watt, wire-wound.</p> <p>R_{16}, R_{17}, R_{19}, R_{20} — 50,000 ohms, 1/2-watt.</p> <p>R_{21} — 10,000-ohm volume control.</p> <p>I.F.T. — 500-kc. air-tuned i.f. transformers.</p> <p>B.F.O. — 500-kc. beat-frequency-oscillator assembly.</p> <p>Sw1 — S.p.s.t. toggle switch.</p> <p>RFC1 — 2.5-mh. r.f. choke (Coto-Coil).</p> <p>RFC2 — Broadcast type r.f. choke, 85 mh.</p> |

it was made deeper than usual. A few tie-strips scattered about and fastened to convenient screws make it a simple matter to mount the miscellaneous components rigidly.

Coils

The coils are wound on 1¼-inch diameter forms, and full details are given in the coil table. All coils are wound in the same direction. Each detector coil has its own grid lead and cap, to keep the grid lead as short as possible. The only coils that are likely to give trouble are the ones used on the 56-Mc. band, where the oscillator may refuse to work unless the coil makes good contact in the socket.

The cathode and antenna winding of the mixer coil should be adjusted on each band so that the mixer goes into oscillation when the screen potential is set at about 45 volts. If serious trouble is encountered with image signals on the 7- or 14-Mc. bands, loosening the antenna coupling will eliminate it. Images on the 28-Mc. band can best be combated by shifting the high-frequency oscillator from the high to low side of the signal frequency or vice versa, depending on what part of the band is used most.

The cable that supplies power to the receiver is made by bonding together two lengths of rubber-covered lamp cord, one for the plate supply and one for the heater supply. An old tube base is used to plug into the socket at the rear of the receiver, and a marker is placed around the B plus lead at the power supply end of the cable which leaves the other three leads readily identifiable.

Operation

The receiver is simple to line up. Since the crystal frequency is known, the b.f.o. can be set to the same frequency by checking its second harmonic on a broadcast receiver. The i.f. amplifier is then lined up at this frequency (with the crystal switched out of the circuit) by tuning the transformers until the noise is a maximum. The crystal is then switched in and the circuits realigned to peak exactly on the crystal frequency. Anyone not familiar with crystal filter operation is recommended to the *Handbook* for further information.

The switch, *Sw*₁, in the cathode circuit of the output tube, is used to vary the bias, depending on whether a pentode or small triode tube is used. It is also handy in portable operation, allowing over-biasing of the pentode (when used) and consequent reduction in battery drain. Actually the effect on audio volume of high bias on the pentode is only noticeable at high levels. The switch also serves to cut down drift, since it has been found that most of the heat in the set comes from the pentode, and increasing the bias decreases the input and the heating.

The receiver is not recommended for use on 160

meters because of the low capacity in the mixer tuning circuit. A 140- μ fd. condenser should be used if 160-meter operation is contemplated, although the 56-Mc. efficiency may then be impaired because of the impossibility of reaching as low a capacity as with the 35- μ fd. condenser.

If the receiver were to be used only for 'phone reception, the b.f.o. portion of the 6C8 could be used as the first audio amplifier, and that coupled with the elimination of the b.f.o. coil and condenser would add considerable space.

We have experienced only one disappointment with the receiver. It's a shame to have a receiver capable of pulling in as much DX as this one will and then not be able to afford a transmitter that will do it justice!

Amateur Radio at the Fairs

RADIO AMATEURS who visit either or both of the Fairs this year will want to see the very splendid Amateur Radio Exhibits which are in evidence.

At San Francisco, W6USA, which is making a big noise on the air with a "California kilowatt," is located in the International Exhibits Palace and is using six rigs, from 5 meters through 160 meters, 'phone and c.w. Powers of various transmitters range from 15 watts to 1 kw. W6USA is being run by a committee of representatives of the prominent clubs in the bay area; namely, W6GEA, Chairman, W6NYQ, W6NGV, W6SG, W6FBW, W6TI, W6HC, W6IBQ and, as technical adviser, W6AJF. Regular operators are John Woerner, W6ONQ and Robert Hansen, W6MPC.

At New York, there are really three Amateur Radio Exhibits. The operating station is W2USA in the Communications Building. This has been installed and is operated by the World's Fair Radio Club, a group of amateurs organized, with characteristic enthusiasm, by Arthur Lynch, W2DKJ. W2USA is only partially on the air, operating as W2DKJ on five and ten, as this is being written. A number of transmitters will be

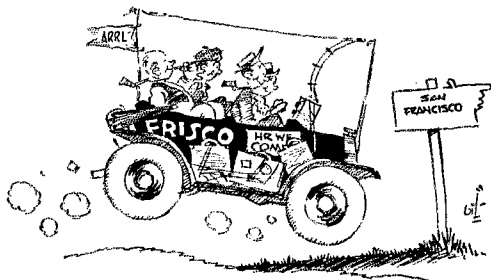

Official A.R.R.L. joint convention of the Pacific and Southwestern Divisions, San Francisco, Sept. 2-4, 1939. Start Saving Your Money.

used, however, permitting simultaneous operation on several bands. Poles on top of the Communications Building are already erected and the station will be going by the time this appears.

In the Health Building, the New York Institution for the Education of the Blind have an exhibit of amateur equipment made and operated by blind amateurs, illustrating the tremendous value of amateur radio as a hobby for those handicapped by blindness. Several blind amateurs will take tricks at W2USA, thus cooperating with that exhibit.

A particularly interesting exhibit at the New York Fair is the "Animated Diagram" of which a complete description will appear in the next issue of *QST*. Briefly, it is an immense circuit diagram of an amateur 'phone transmitter and receiver, over 40 feet long and 3 feet high. It is made entirely of small electric lights, 7000 of them of various colors, which are switched by an intricate, motor-driven, rotary switch containing 200 cams and contactors. Using the "border chaser" technique which is familiar in electric signs, the lights are made to simulate the flow of electricity through the various components of the transmitter and receiver — tubes, coils, condensers, etc. — making visible the electrical action which takes place in each part. On a counter below and in front of the Animated Diagram, are spread out the actual parts themselves, all hooked up and operating. This display was designed by the Headquarters Office of the League and built under our supervision through the kindness of the Westinghouse Electric and Manufacturing Company and the American Institute of Science. The wiring and constructional work was done by students of R.C.A. Institutes. It is a very conspicuous exhibit, close to the center of the ground floor of the Westinghouse Building at the Fair.

— F. C. B.



DIXIE JONES' OWL JUICE

WHEN the OW wants you to do sumpn and you want to do it, that's fun. When she wants you to do sumpn and you don't want to do it on account of you'd rather ham, that's OW QRM. This collum of Juice use to deplore the prevalence of OW QRM and moan about it no end and seek remedies to relieve the distress, like for instance an axe, maybe, or sumpn, but we done changed our tune. We now view with alarm the constant increase in the number of present and future OWs who are either gettin' ham calls of their own or are fiddlin' a lot with the OM's haywire. It's

liable to git so you can't git no chow when it's chow time on account of the OW is messin' with the mojulator and won't quit, or maybe she's hooked Africa or some dern place and junior is howling for some more square pants. OW QRM is kinda bad but vice versa is liable to be worse.

— *W4IR of the Dixie "Squinch Owl"*

Silent Keys

IT is with deep regret that we record the passing of these amateurs:

Carl M. Bonnivier, W1AEL, Quincy, Mass.

Byron O. Britt, W9JWR, Alliance, Nebr.

Jacques M. Dreyfus, W5AJY, San Angelo, Texas

George M. Kniess, ex-8DIC, Butler, Pa.

Fred R. Thomas, Jr., W8NRY, Pittsburgh, Pa.

Warren L. Ward, W9VQB, Auburn, Nebr.

Atlantic Division Convention

Pittsburgh, Pa., June 23rd-24th

THE Pittsburgh Area Radio Club Council is sponsoring the Atlantic Division Convention this year to be held at the Fort Pitt Hotel, Pittsburgh, Pa., June 23rd and 24th. A cordial invitation is extended to all radio amateurs in the division and surrounding states to attend this affair. The committee in charge is representative of all the clubs forming the Council and every effort has been made to prepare a program that will not be forgotten in a long time. Prominent speakers include a representative of the F.C.C., Mr. Webb of West Penn Power Co., Marshall Wilder of the National Union Radio Corp., W. A. Weiss of Hickok Instrument Co. There will be an artificial resuscitation demonstration by H. F. Webb, General Safety Director, American Water Works Electric Co. Honored guests will be A.R.R.L. President, Dr. E. C. Woodruff and Dr. Frank Conrad — father of radio broadcasting. Divisional Director Brad Martin will address the convention on timely topics.

In keeping with Pittsburgh Ham traditions, there will be many worthwhile prizes and plenty of side activities for the Y.L.'s and O.W.'s, including a fashion show.

Special sleeping accommodations may be obtained in the Fort Pitt Hotel: 4 beds (not cots) in one room, \$1.25 per person per night. The registration fee is \$2.75 per person.

More information from R. M. Francis, 3577 Elmhurst St., Pittsburgh, Pa., if you write him.

New regulations on 56 Mc. a hardship? Not when a practical rig can be built as simply and inexpensively as this one! We've heard it work, and there's no question about its ability to comply with the present stability requirements. The 4-watt carrier ought to be equivalent to several times that power on the old-fashioned modulated oscillator.

"Submarine" construction of the r.f. end features this inexpensive 56-Mc. transmitter. In this view, the r.f. output terminals are on the rear chassis edge; speech amplifier is at the extreme right.

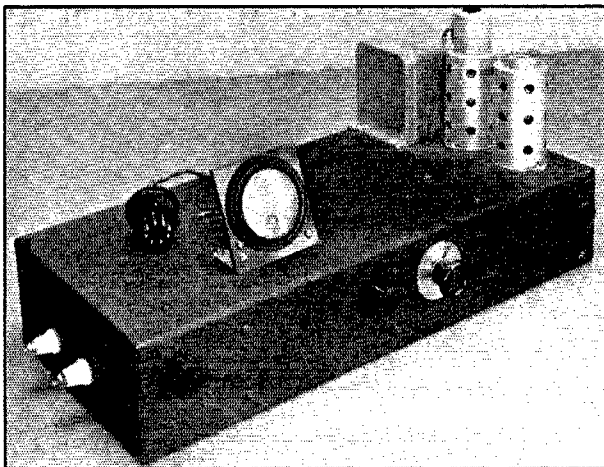

A Stable and Inexpensive 56-Mc. Transmitter

Suppressor-Modulated Outfit Using Receiving Tubes

BY MILTON W. MIX,* W1PL

THE inexpensive 56-Mc. transmitter to be described proved to be free from frequency modulation even though it has only two stages — one an e.c.o. — and the entire outfit, including the modulator, is run from one power supply. It is believed that the construction and characteristics of the Type 89 tube have much to do with the excellent results obtained. The arrangement of grid and plate leads of the tube makes for good isolation of circuits, which is quite necessary for this sort of transmitter. Also, 89's are easy to drive at 56 Mc., and the fact that their suppressors are brought-out offers an opportunity for low-cost modulation.

One 89 is used as an electron-coupled oscillator with its grid on 28 Mc. and plate circuit on 56 Mc., driving push-pull 89's as 56-Mc. amplifiers, as shown in Fig. 1. An experimental model was laid out breadboard fashion and the setup fired right off without showing any peculiarities. When the transmitter was rebuilt into a permanent assembly it still worked without any difficulty. Different makes of 89's were tried and all worked equally well. With the full plate voltage on the oscillator, more than enough output to drive two 89's at 56 Mc. was obtained, so the plate voltage was reduced by means of a dropping resistor, thereby reducing the frequency creep from heating. The use of a Class-A modulator permits the oscillator and modulator to be run from a common supply without any reaction.

* 283 Ridgewood Rd., West Hartford, Conn.

A check-up of the transmitter when finished showed that a 4-watt carrier was possible and that 100 per cent modulation could be used without any sign of frequency modulation. The plate tank could be tuned through resonance and the load could be put on and off the final without any perceptible frequency change. A change of 75 volts in the oscillator voltage shifted the frequency less than 1000 cycles at 28 Mc. When the set was first turned on it would creep about 2000 cycles (also measured at 28 Mc.) during the first two or three minutes and then settle down and hold a low beat on a superhet. After 15 minutes the creep was considerably less, even between long shut-down periods.

Chassis Layout

The r.f. part of the transmitter is built on the under side of a 7- by 17- by 3-inch chassis bent from 1/16-inch copper sheet. The tubes and other parts are mounted on partitions running crosswise, as shown in the photograph. Copper was used in preference to iron to reduce eddy-current loss in the chassis near the plate and grid coils. It is quite possible, however, that an iron chassis would be satisfactory if the mounting partitions were made of copper or aluminum. The bottom plate also should be non-ferrous. Another layout which probably would work well, if it is desired to build the set into a metal cabinet, is to mount the oscillator tube at right angles to the final amplifier tubes. This would necessitate

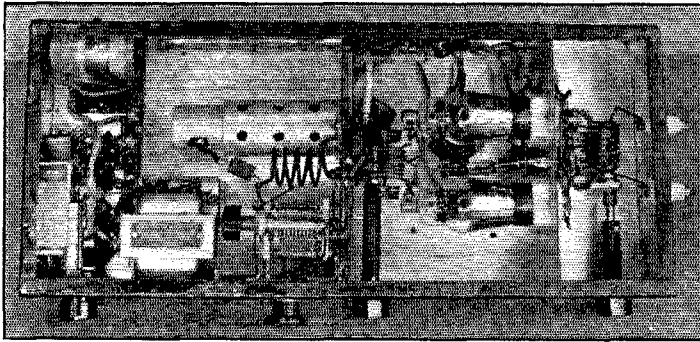

◆
 The electron-coupled oscillator and push-pull amplifier are mounted on separate partitions running across the chassis. The revamped audio transformer for coupling the modulator to the suppressor grids of the amplifier tubes is at the lower left.
 ◆

mounting the oscillator socket so that the plate lead would go directly through a bushing in the partition to the plate circuit of the oscillator.

It is best to use sockets and condensers with good insulation, since the coils are mounted directly on these units and no other insulation is used. R.f. chokes were omitted entirely and the 0.001- μ fd. blocking condensers were relied upon to keep r.f. from power supply circuits. Tests were made to determine if r.f. might be getting past the blocking condensers but everything ran cold, including the chassis. A ground on the latter made no difference.

Since the grid-plate shielding in the 89 is not complete enough to prevent oscillation, neutralizing is necessary. This was done by mounting light strips of copper around the outsides of the output tubes, cross-connecting the strips to the grids. The strips are $\frac{1}{8}$ inch wide and 1 inch long. They were first held in place with elastic bands around the narrow end of the tube and as close to the end of the plate as possible. This point is about the spot where the diameter of the envelope starts to increase. After the strips are in place, plate voltage is applied to the final and, without excitation, the strips are then peeled back until no sign of oscillation is observed when the plate tank condenser is tuned from one end of its scale to the other. The strips are then cemented and the rubber bands peeled off after the cement is set. If it is necessary to change a tube, the strip is peeled off the old tube and then its position readjusted to the new tube with an elastic band and later cemented.

The coils are all "air wound" and the turns cemented together, with the exception of the oscillator grid coil, which is wound of heavy enough wire to be entirely self-supporting. The oscillator plate coil is mounted directly on its condenser terminals, with the plate end of the coil so located that the spade connection on the tube socket can be soldered directly at this point. The grid coil of the amplifier is mounted on the grid clips of the output tubes. As the wiring diagram indicates, the oscillator plate coil is split and each half coupled to the ends of the amplifier grid coil.

The amplifier plate coil is mounted directly on its condenser, again so located that the ends connect directly to the spade connections on the sockets. The antenna coil is wound inside the plate coil and is supported by the output feed-through bushings at the right in the bottom view. All grounding connections on the oscillator are made to only one stud in the partition which supports this unit. This is also true of the amplifier. Taking time to arrange parts so this procedure can be followed is repaid by stable operation of the transmitter. In the case of the audio section grounds can be made to any convenient spot. The frame of the transmitter is not used to carry either filament or negative- "B" supply currents but is looked upon only as a shield for the r.f. circuits.

The oscillator grid circuit is high- C , with a 100- μ fd. variable across the entire coil and a 35- μ fd. condenser across part of it. By manipulation of the padding condenser, C_1 , and the band-spread tap on the oscillator coil, L_1 , the output frequency range on C_2 was made from 56.5 Mc. to 59.5 Mc. This makes for ease of setting frequency and prevents getting out of the band. Periodic checks showed the calibration to hold, and the oscillator is used at times as a frequency meter in the 56-Mc. band. The dial used has 100 divisions, and it is possible to reset to within 10 kc. after having shifted to another frequency.

Metering

The meter-switching method shown in Fig. 1 is simple and cheap. An octal tube base with all the pins present was used as the meter plug. The bakelite base was cut down to half its height and a bakelite cover was made for it. The cover is held in place by a 4-40 screw running down into a tapped hole in the centering pin of the tube base, and is also cemented to keep it from "walking." The octal base plugs into a wafer socket with notches filed so that the base can be inserted every 90 degrees. The meter is wired to a pair of adjacent pins in the tube base and remaining six pins are hooked together in pairs, as shown in Fig. 1. When the plug is inserted the meter is connected in the circuit to be measured and at the

same time all other circuits are closed. The currents measured are oscillator plate current, amplifier grid current, amplifier plate current, and total modulator and preamplifier plate currents.

Modulator

If a high-level carbon microphone is used two stages of 76's probably will give sufficient gain. Or, one pentode such as the 42 run at 180 volts should be enough with close talking to give complete modulation when using this type of mike. If a crystal mike is used it would be better to use the 76 instead of the 37, and this too probably would require close talking. With the 6C6 preamplifier and 37 modulator shown in Fig. 1 the gain is about three quarters on, using a low-level carbon mike.

The 1:1 suppressor modulation transformer can, if necessary, be made from an old interstage transformer as was done in this case. An old R-300 transformer was selected for the purpose

since there was no compound in the case to dig out and also because the secondary is the outside winding. The case and core were removed and, since the transformer ratio was 3:1, two-thirds of the secondary had to be taken off (if a 2:1 transformer is selected, half of the winding would be removed, and so on). A hacksaw was used to cut the winding down to about half its original thickness, and the rest was taken off with pointed scissors. The last three or four layers had to be unwound by hand before all mutilated layers were eliminated. Although the number of layers to be taken off was just guessed at, the transformer measured almost exactly 1:1.

Adjustment

In tuning up it will be helpful to short out the 2000-ohm resistor in the plate supply to the oscillator. Also, in preliminary tuning, the suppressors of the output tubes should be run at

(Continued on page 104)

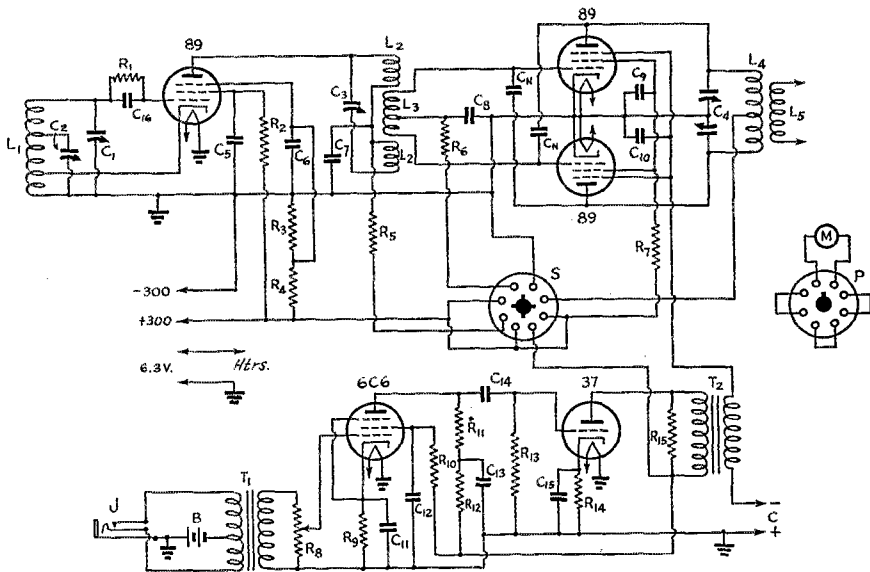

Fig. 1 — Circuit diagram of the low-cost 5-meter transmitter.

NOTE. — See text in connection with ground points and power wiring.

- C₁ — 100- μ fd. variable (National ST-100).
- C₂ — 35- μ fd. variable (National UM-35).
- C₃ — 25- μ fd. variable (Cardwell ZR-25-AS).
- C₄ — App. 12 μ fd. per section (National SEU-25, split).
- C₅—C₁₀, inc. — 0.001- μ fd. mica.
- C₁₁ — 10- μ fd., 25-volt electrolytic.
- C₁₂ — 0.1- μ fd., 400-volt paper.
- C₁₃ — 4- μ fd., 425-volt electrolytic.
- C₁₄ — 0.005- μ fd., 400-volt paper.
- C₁₅ — 10- μ fd., 25-volt electrolytic.
- C₁₆ — 100- μ fd. mica.
- C_N — See text.

- R₁ — 50,000 ohms, 1/2-watt.
- R₂ — 20,000 ohms, 1-watt.
- R₃ — 10,000 ohms, 1-watt.
- R₄ — 65,000 ohms, 2-watt.
- R₅ — 2000 ohms, 10-watt.
- R₆ — 5000 ohms, 1-watt.
- R₇ — 10,000 ohms, 2-watt.
- R₈ — 500,000-ohm potentiometer.
- R₉ — 1200 ohms, 1-watt.
- R₁₀ — 0.5 megohm, 1/2-watt.
- R₁₁ — 0.25 megohm, 1-watt.
- R₁₂ — 50,000 ohms, 1-watt.
- R₁₃ — 0.25 megohm, 1-watt.
- R₁₄ — 2000 ohms, 1-watt.
- R₁₅ — 10,000 ohms, 1/2-watt.
- L₁ — 5 turns No. 10, diameter 1 inch, length 1 1/2 inches; cathode tap 1/4 turn from

- ground, band-spread tap 3 turns from ground.
- L₂ — 3 turns No. 12 each section; each 3/4 inch diameter, 1/2 inch long.
- L₃ — 8 turns No. 14, diameter 5/8 inch, length 3/8 inch.
- L₄ — 8 turns No. 12, diameter 1 inch, length 1 1/4 inches.
- L₅ — 5 turns No. 12, diameter 1/2 inch, length 1 1/4 inches.
- J — Push-pull microphone jack.
- S — Octal wafer socket; see text.
- P — Octal plug (tube base); see text.
- T₁ — Double-button microphone-to-grid transformer.
- T₂ — 1:1 audio transformer (see text).
- B — Two 1 1/2-volt dry cells.

Seventh A.R.R.L. Field Day Contest

June 17th-18th Set for portable Emergency Rig Tests

A.R.R.L.'s Annual Field Day, dedicated to the testing in actual operation of sending and receiving equipment that will function self-powered for the occasion, is open to all W/VE amateurs.¹ The F.D. combines an outing with the opening of the season for outdoor radio activities. Operating time for the F.D. shown in logs must be between Saturday, June 17th (4 p.m. local time) and Sunday, June 18th (6 p.m. local time) for all points.

Only portable stations operated in the field (away from "home" address) are eligible to submit field-day scores. Competitors, individuals or groups, under *one call*, must be "in the same locality," "in one group, or building or field" constituting a single (FCC-notified¹) location. To have points count, all equipment at a F.D. station must be within 100 feet of some given spot. Mobile work does not count. It is a test of portables on an even footing. "Manufactured" contacts between stations of the same field group in the contest are *out*. Any or all amateur frequency bands may be used, voice or c.w. telegraph likewise. Advance entry is not required. The general call: (c.w.) CQ FD or (phone) CQ FIELD DAY. The object is for each field-portable to work as many other amateur stations as possible in the time allotted.

To be prepared for emergencies requires that equipment be at hand, and the operator know what to do when power goes off, how to work without commercial power, how to send a message (proper order of parts) and show receipt for same, how to tune up workable antennas in "new" locations, how to make the most of low power, and many other things.

F.D. Scoring: Each station worked counts *one point* toward the score (but one contact per station allowed). Working other stations in the field, portable-to-portable at *both ends* of a QSO will count *two points* instead of one only. An extra credit of 25 points (before multiplier) may be claimed for originating not more than one message addressed to A.R.R.L. Hq., reporting the number of operators, the location, conditions and power (informative data on situations always needed at Hq. in actual emergency, too!). These extra points will count *only* if the message copy is submitted showing complete handling data, and word count (CK) must be correct as well as preamble complete in the right order.

The multiplier: Score may be multiplied by 2 if *either* the receiver or transmitter is independent of mains or commercial power source, by 3 if *both* transmitter and receiver are supplied from an independent local source. The following additional score multiplier is determined by the power input to the final stage (plate voltage times plate current — E X I).

- (a) Up to and including 20 watts — multiply score by 3.
- (b) Over 20, and up to 60 watts — multiply score by 2.
- (c) Over 60 watts — multiply score by 1.

The log of operation, claimed score, and data on power, frequency band and time of each contact should be listed, with the claimed total and sent in promptly at the end of the tests. Be sure to note the source (s) of plate and filament power, along with the "watts input."

Clubs are all invited to encourage their members to build portables and to arrange special Field Day activities. Club contests for emergency set-building of members should be instituted, as well as planning for higher power centrally located amateur-emergency stations where possible. Every amateur is invited to take part, whether or not able to participate in club plans. Your portable transmitter can be a source of great pleasure for the whole summer season. Get it working now. Take a couple of hams with you. Test it in the Field Day. Ask for application forms for registering equipment and availability in A.R.R.L.'s Emergency Corps, if not already on record as a member of this organization.

Keep an operative portable at hand all the year. Use it at the mountains and seashore this summer. Design your station for "six-volt" tubes in exciter (and receivers, too) so they can be converted easily in emergency. Better yet, plan gas-driven units for ample power, but don't deny yourself the ability and pleasure to set up in any location when supplementary links to important agencies may be required. Surprisingly efficient and useful equipment may be operated from vibrator-type, genemotor and battery power supplies.

The December '38 QST index shows *fourteen* articles under "Transmitters — Portable and Low Power" that will help you build. Possible tube line-ups for portables were given in June and August '36 QSTs, pages 43 and 39. About a dozen articles in your 1937 QST file also give circuit information and data on self-power for emergency and portable transmitters. On receipt of a postal of inquiry we'll send a printed list of such QST references, with application form so you can register all station equipment in the A.E.C. We'll be looking for your report on the F.D. — F.E.H.

¹ To comply with F.C.C. regulations for portable station operation (Secs. 150.03, 152.09, 152.10, 152.45), licensees in the U. S. A. have only to observe the instructions of Sec. 152.12 as respects advance notification of the location in which the portable will be operated, to the Inspector-In-Charge of the district, and as regards proper station identification (DN 1-2, etc.). Only on the 28-Mc., 56-Mc. and higher frequency amateur bands is portable work permitted without such notification. In Canada except for the inclusion of authorization to portables in the regulations for these u.l.f. bands, it is only necessary to ask special permission of the Radio Division, Department of Transport, for the work a VE-amateur has in mind for frequencies below 23 Mc.

W2JHB Wins 1938 Maxim Memorial Trophy

OWEN J. DOWD, W2JHB, was declared the 1938 winner of the Maxim Memorial Trophy award, which goes annually to the young amateur under 21 who has made the most outstanding record for the year in amateur radio. The selection was made from nominations by various SCM's of the outstanding candidates in their sections.

The award consists of a bronze replica of the Wouff Hong given by Mrs. John G. Lee, daughter of Mr. Maxim, and the sum of one hundred dollars in cash contributed jointly by Mrs. Lee and Mr. Hiram Hamilton Maxim, his son.

Selection of the 1938 winner was based on strong recommendations by his SCM and other New York and New Jersey amateurs. His record is one of constant recognition and seizure of opportunity, that of an energetic, aggressive individual who realizes potentialities and makes the most of each one.

Owen Dowd was born in Fall River, Mass., on January 17, 1918. Ten years ago the Dowd family moved from Fall River to Brooklyn, where Owen completed grammar school and attended high school for two years. Thereafter he changed to a technical school, concentrating on radio and allied arts.

Five years ago his father died. During most of the time since then it has been his task to support the family, including his mother, a sister, now 16, and a brother, now 11. His first job was with Western Union, as a messenger boy. At Christmas

time he succeeded in selling over five hundred greeting messages and this performance so impressed his superiors that he was sent to WU's teletype school.

There Owen learned the art of teletyping which he has since practiced on behalf of several firms — Western Union, a brokerage house in Wall Street, and for the past year with the Union Pacific railroad.

His interest in radio goes back almost ten years. At first it was photography — still an occasional threat to schedules. But then he began building receivers, picking up defunct battery sets through the Y.M.C.A. and using the parts therefrom. Eventually he progressed to the transmitter stage.

W2JHB became an official entity in December, 1935. The first rig used a 2A5 driving 46's, and the first six months were spent trying to make it work. The set was re-built on an average of three times a week in an effort to get signals out of it, but not a single station could be raised. So a Type 42 crystal oscillator was eventually substituted, and with this he began his performance record.

The station became ORS during the first year. Flushed with his new appointment, Owen entered the October, 1936, ORS Party. The operators he worked had to slow down for him, then, but before long he began to burn it out like the rest. . . . The 3-tube t.r.f. and 42 xtal (later e.c.o.) became an "All-Star" and 6L6-6L6's at 75 watts. . . . He was given an 852 and had visions of going on high power with 600 volts for the plate, but so nervous was he on arriving home with the precious bottle that he dropped it! . . . In 1938 he used a Comet Pro and a 3-stage single-control e.c.o. rig ending in a 242A. . . . Probably the one amateur in the greater New York area with a 500-foot lot in his backyard, he has six antennas. There are 260-foot and 120-foot end-fed wires and two of 66 feet, plus another



Owen J. Dowd, W2JHB

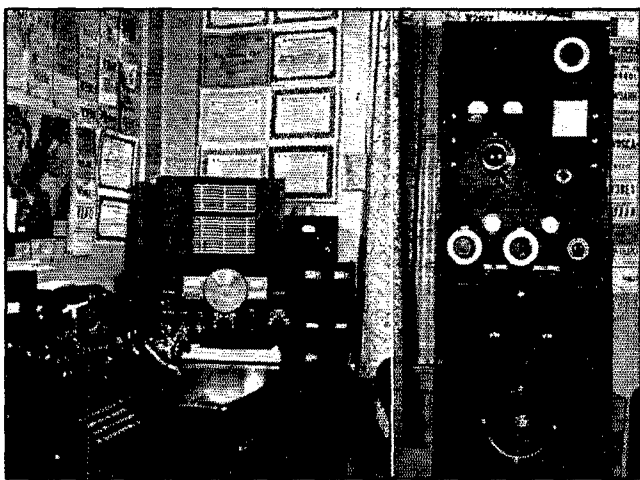

Left — Receiving position at W2JHB. Right — The transmitter.

(Continued on page 108)

Tri-County Takes a Holiday

or

Benjamin Franklin in Reverse

BY DANA GRIFFIN,* W2AOE

AT ONE of Tri-County's summer meetings, suggestions were asked for on a field day program. The writer suggested that an investigation of kite antennas for portable 5-meter outfits might prove interesting. According to a time-honored but insidious custom, well known in most radio clubs, the writer promptly won the "chairmanship" of a committee delegated to "shape up a program." The use of the word "chairman" to describe the duties involved may be subject to some debate, but this is the tale of a successful field day, not tribulation.

In preparing for the outing it was necessary for us to start from scratch and develop suitable kites for our antennas, and also to get together suitable portable outfits of the low power type. It was felt that the use of high power would introduce too many complications and might also tend to mask any advantages obtained by the use of kite antennas. In order to eliminate any gain by operation at high altitudes, it was decided to hold the outing at the seashore, operating from sea level. Since a breeze is generally to be found at the shore, this choice was double-barreled. We were almost let down — but more on that anon.

Investigation proved that the Eddy or "tail-less" kite shown in the photograph is the most satisfactory type for light and moderate wind velocities. The first kites made were 5 feet tall. The size was increased to 7 and finally to 8 feet with an improvement in weight carrying ability and, what is more important, increased stability. The kites, built with wooden frames and paper

*136 Liberty Street, New York City.



Grouped around station W2AOE at Sea Bright are W2HSC, W2CPU at the controls, W2JJV and W2JAB.

"covers," were designed by W2CPU and the writer so that they could be assembled or dismantled in about a minute. This makes transportation by car a simple matter, as they are too large to be carried ready for flight.

Long-wire antennas were used, coupled to a tuned tank which was grounded at one end to drain off the static accumulation. This tank was inductively-coupled to the various rigs that were used. It is surprising how much static can build up on a 500-foot wire on a bright sunny day, and a ground connection is almost a necessity. A variety of "strings" or antennas was employed. Plain No. 20 soft-drawn copper was used with the small kites, while wire taped to heavy string and even steel piano wire was tried with some success on the big ones.

The first tests were made using W2FKK's mobile rig, and the results on receiving were surprisingly good. Anyone that was audible on the regular car antenna jumped to S8 or 9 on the kite antenna and, what is more important, stations that put in S5 or 6 signals with the kite antenna were absolutely inaudible on the car antenna. Since many of these stations were less than 15 miles away over flat country, the improvement can be appreciated. Even though the 10-watt transmitter was never properly matched to the kite antenna during these tests, a decided increase in range was obtained with the flying skywire.

While these tests were going on, several fellows were getting portable rigs in readiness for the field day. The rig for the club station, W2JLJ, a receiver using a 6J5-6F6, was built by W2JJV. A similar rig was built by the writer, and W3EBC brought a crystal-controlled rig. W2HSC and W2JAB helped W2JJV in the field. W2CPU teamed up with the writer, and the DX hounds W3CGU and W3CRG assisted W3EBC.

The gang finally got under way at noon on September 25th, headed for the Atlantic Highlands. The Highlands rise abruptly almost from the sea shore to a height of 300 or 400 feet. A beautiful view of Sandy Hook and the lower New York Bay unfolds northward, and the Atlantic is directly east a mile or so. Oddly enough, there was a complete absence of wind on



W2CPU displays one of the five-foot Eddy kites. This one ended its career in the arms of Father Neptune.

top of this hill, and it looked as though the hurricane the week before had taken all the moving air with it. We decided to leave W2JLJ in command of the Heights and see what could be done with ordinary antennas at the other two stations spotted further south.

The writer and W2CPU located at Sea Bright, about five miles south of the Highlands. Here sufficient breeze was found at the water's edge to raise an 8-foot kite with about 300 feet of antenna. W2JLJ was contacted on schedule shortly after the station was set up and reported that the dead calm conditions still prevailed on the hill. Signal strengths were about S6 to 9 with fading apparently caused by the motion of the kite string. A number of New York and other stations to the north were heard by both stations with excellent signal strength. Both stations were able to contact W2KPX, operating portable marine about 15 miles off shore near Ambrose Lightship, with S8 to 9 reports all around. W2JLJ was using a wire draped over a branch on the hilltop during this time.

While this was going on, the W3EBC crew was running into difficulties further south below Long Branch. The first 5-foot kite behaved erratically and finally called it a day by making a magnificent dive into the ocean. A spare kite also gave some trouble and had to be nursed constantly. To add insult to injury, it was found next to impossible to get any "soup" into the antenna. Despite these troubles, contact was established with W2AOE.

Late in the afternoon W2JLJ was removed from its hilltop location and, after a get-together at W2AOE's location, it was decided to set up further north with a kite antenna. This was done, and a breeze was found on the beach four miles north, almost in the shadow of the hill on which dead calm prevailed. As soon as the station was

set up, contact was established with W2AOE with S7 to 9 signals in both directions.

The gang then decided to call it a day, except for those at W2AOE who wanted to see what could be heard when the band got lively at night. From 6 to 7 P.M. the big 8-foot kite hung over the water as if nailed to a wall. To the crew it seemed hardly possible that the kite could stay aloft, since there was no indication whatever of air motion on the ground. A considerable number of stations was heard up to 7 o'clock, when the kite finally fluttered down to earth due to a complete lack of "lift."

At the club meeting the next evening the consensus seemed to be that, although the outing was successful, we had learned just enough to make us want to know more. We obviously needed more stable kites. The fading encountered indicated a better type of antenna might be found. The combination of wire and string taped together had its disadvantages, and the radio gear could be improved. Accordingly, it was decided to continue the research to see if answers could be found to these questions. In closing, Tri-County heartily recommends this form of field day, combining as it does the best features of our hobby with plenty of fresh air and sunshine thrown in. The writer recommends, however, that would-be enthusiasts be careful, or they too may become "committee chairman."

Strays

That famed arm-chair athlete of the movies, Pete Smith, donned a pair of ham headphones awhile back, and the result is his latest movie short, "Radio Hams," being released in May by M-G-M. In it he describes the family life of the Mulligans, a likeable enough lot, but afflicted with a young ham son. Throughout the thread of the story there are woven dramatic true episodes from amateur radio's history. Call your local theatre manager and find out when this specialty is playing; if it isn't scheduled, make it a request! We think you'll enjoy it. Ham radio takes a lot of kidding by Pete Smith, but it gets a word in edgewise, too. For the first time in his more than 120 one-reelers, Pete's voice will not be solo. The Mulligan family, and in particular Jimmy Mulligan, is heard, too. And does Jimmy talk up ham radio!

— — — — —

Paul G. Watson, 27 Price St., West Chester, Pa., formerly 3BV, 4XX-4ZD, is looking for a prewar de Forest audion with the candelabra base and loose plate and grid leads, to complete a collection of early vacuum tubes for a museum exhibit.

A 112-Mc. Pack Set

Battery-Operated "Personal Portable" for Emergency and Field Use

BY VERNON CHAMBERS,* WIJEQ

THE recent revision of the amateur regulations will, naturally enough, cause many of the fellows to go "farther up" insofar as their u.h.f. operation is concerned. This will be especially true when portable or emergency equipment is under consideration, since weight and power-supply capacity are at a premium. The order of transmitter stability now required on 56 Mc. is not easily built into equipment whose dimensions are small enough to permit it to be "packed" on a hike. On the other hand, there are no regulatory restrictions on 112-Mc. operation; antennas and other station components for the band are small, and the range for the type of work under discussion is practically the same as on 56 Mc.

It was with these thoughts in mind that the outfit to be described was designed. It is a complete station — transmitter, receiver, power supply, antennas — light-weight, compact, and yet quite effective for its power. The whole works is housed in an aluminum case measuring $5\frac{5}{8}$ by $9\frac{5}{8}$ by $15\frac{1}{4}$ inches; these dimensions could be enlarged a bit to make assembly somewhat easier,

but the job of fitting the parts into the present-sized box was not especially difficult. The receiver is a separately-quenched superregenerative set with three tubes; the transmitter and modulator have one tube each. The power supply, of course, is from dry batteries.

The Receiver and Modulator

For compact assembly, it was deemed advisable to construct the receiver and modulator as a single unit, as shown in Figs. 1 and 2, although the diagrams, Figs. 3 and 4, show them separately. It must be admitted that the receiver tube line-up is rather unusual in view of the use of both 1.4- and 6.3-volt tubes. However, it is justified in that it combines good performance with battery economy. The detector is a Hytron HY-615 (a 6.3-volt tube), used because of its excellent behavior at the ultra-high frequencies. The other two tubes were chosen because of their low filament-power requirements. The first of these, a 1N5G, is the quench oscillator, and the second, a 1C5G, is the audio amplifier. The 1N5G is connected to operate as a triode, while the 1C5G is a pentode amplifier.

* A.R.R.L. Technical Information Service.

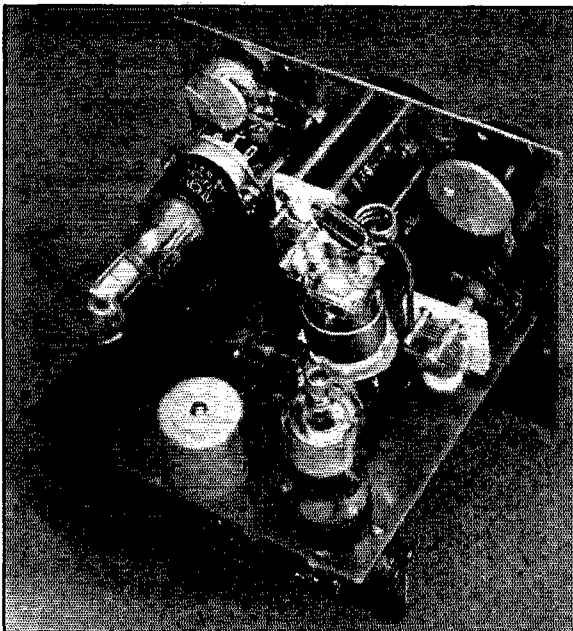

Fig. 1 — The receiver is built on one side of a T-shaped chassis. This view shows the r.f. section, at the right just behind the panel, the audio amplifier at the left, and the quench oscillator in the foreground.

Although the necessarily low power and restricted antenna equipment ordinarily limit the range to short distances, an ultra-high-frequency pack set will do surprisingly well, given the benefit of a good location such as can be found during the course of a cross-country hike. Besides the fun to be had working portable, a set of this type is a decidedly useful piece of equipment when emergencies occur and power can't be taken from any convenient outlet.

After looking over the characteristics of the various audio tubes available, the 6G6G was picked as the most suitable modulator tube. Its output is sufficient to modulate the transmitter, and the plate and filament currents are not so high as to be objectional in portable operation.

The two units are mounted on a "T"-shaped aluminum assembly, one section of which is the panel and the other the base. Many of the parts are mounted directly on the panel, which is $6\frac{5}{8}$ inches wide by $6\frac{1}{2}$ inches high. Fig. 5 shows the complete unit at the top left-hand side of the case. The meter for reading transmitter and modulator plate currents is at the bottom of the panel, with the microphone jack to the left and the modulator gain control at the right. All of the parts mounted above the meter belong to the receiver. The phone plug and audio gain control are to the right of the vernier tuning dial; antenna and regeneration controls are to the left, with the latter at the top.

The base, attached to the panel by a piece of right-angle strip, is $5\frac{7}{8}$ inches wide by $5\frac{3}{8}$ inches deep and is located $2\frac{3}{4}$ inches up from the bottom of the panel. The receiver parts mounted on this base are as follows: tuning condenser, coil and antenna coupling condenser, detector and quench tubes, quench-coil unit and audio transformer. The arrangement of parts should be clear from inspection of Fig. 1.

The detector circuit is arranged as compactly as possible—a desirable procedure from the standpoint of effective operation. The antenna condenser must be insulated from the chassis and panel, and is therefore mounted on insulating bushings and controlled through a flexible shaft coupling. Holes are drilled in the side of the quench-coil shield to permit the shortest possible leads to point above the base. The leads going below the chassis are brought through a hole drilled in the base just beneath the center of the shield can. The audio tube is mounted horizontally with its socket supported from the panel by $1\frac{1}{4}$ -inch pillars. The audio screen and filament by-pass condensers (the latter possibly can be omitted) are directly below the socket.

The modulator is mounted on the under side of the receiver base. Although this unit is quite compact it is not hard to assemble, since relatively few parts are required. Fig. 2 shows the layout of parts on the back of the panel and on the base. The quench tube socket is mounted below the base, along with condensers C_6 , C_9 , C_{11} , and resistor R_5 (Fig. 1). The microphone transformer is at the left just to the rear of the panel-mounted jack. L_1 , the modulation choke, is at the

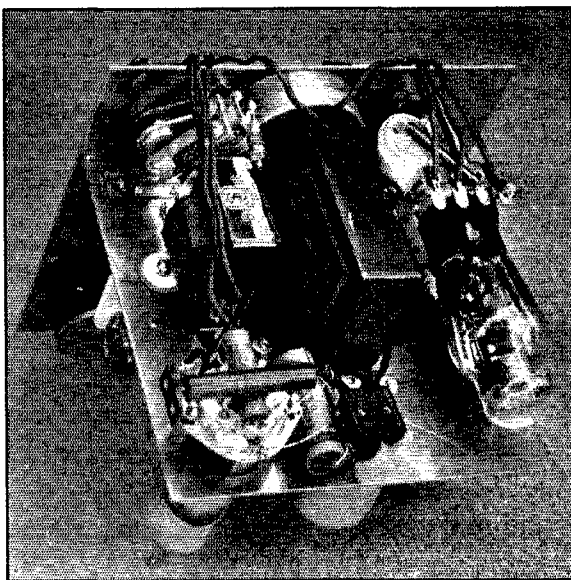

Fig. 2 — The modulator is on the opposite side of the partition from the receiver. A few receiver parts also are in this compartment, as described in the text.

center of the base and far enough back to clear the meter. At the right, supported in the same fashion as the audio tube of the receiver, is the 6G6G modulator tube. If the socket is at least $1\frac{1}{4}$ inches away from the panel, there will be sufficient room for the gain-control, R_2 , the cathode by-pass condenser, C_1 , and the bias resistor, R_1 . A four-lug connection strip mounted as shown in the photograph will provide terminals for the modulation choke and switch connections. The grounded mounting lug provides a short ground connection for C_1 , which is mounted vertically.

Originally, the speech input circuit was to consist of a double-button carbon microphone working into the center-tapped primary of the microphone transformer, but it was found that the Shure Model 15-A single-button microphone was more suitable for our purposes. The single-button microphone is fed into only half the primary winding, as shown in Fig. 4. A single-button transformer could be used instead, of course.

There are times when it is desirable to operate the set without the modulator running, as when the antenna and transmitter adjustments are being made, so the meter will read only the transmitter plate current. This is accomplished by breaking the 6G6G plate and screen leads with a double-pole single-throw switch, *Sw*.

The Transmitter and Case

While the transmitter is simple, its construction depends considerably on the case, so that the two have to be treated together.

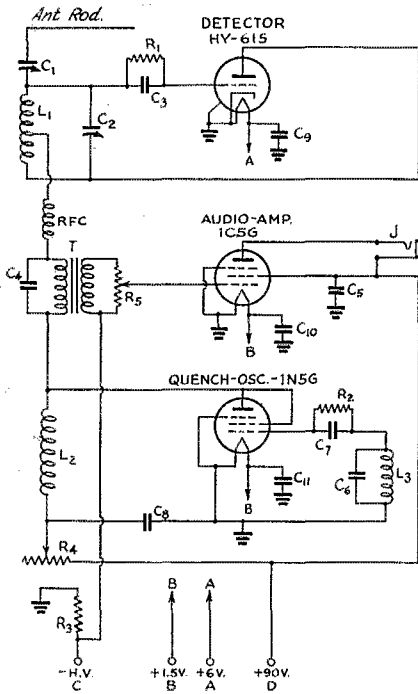

Fig. 3 — Circuit diagram of the receiving section.
 C₁ — 35- μ fd. variable (Hammarlund HF-35).
 C₂ — 15- μ fd. variable (National UM-15 with all but two plates removed).
 C₃ — 100- μ fd. midget mica.
 C₄ — 0.005- μ fd. midget mica.
 C₅, C₆ — 0.002- μ fd. midget mica.
 C₇ — 0.001- μ fd. midget mica.
 C₈ — 0.1- μ fd., 400-volt paper tubular.
 C₉, C₁₀, C₁₁ — 0.01- μ fd., 400-volt paper tubular.
 R₁ — 5 megohms, $\frac{1}{2}$ -watt.
 R₂ — 50,000 ohms, $\frac{1}{2}$ -watt.
 R₃ — 1000 ohms, $\frac{1}{2}$ -watt.
 R₄ — 0.1-megohm potentiometer.
 R₅ — 0.5-megohm potentiometer.
 RFC — 25 turns No. 20 d.s.c., diameter $\frac{1}{4}$ inch, close-wound.
 J — Open-circuit jack.
 T — Audio transformer, 3:1 ratio (Stancor A-53).
 L₁ — 3 turns No. 14 tinned wire, diameter $\frac{1}{2}$ inch, length $\frac{3}{8}$ inch.
 L₂, L₃ — Windings of National quench-oscillator unit.

Fig. 6 shows the circuit of the transmitter, a linear oscillator employing a type HY-615 tube. Physically, the resonant line is not as long as it could be at this frequency, but to keep the case size down it was decided to shorten the line and bring it to resonance by adding capacity at the tube end. This capacity not only makes up for the reduction in line length, but also provides a means for varying the transmitter frequency. Plate voltage, applied to the low potential end of the plate pipe, is isolated from the grid circuit by the small mica by-pass condenser C₁, which also brings the ends of the pipes to the same r.f. potential. R₁, the grid-leak resistor, is connected between the cold end of the grid pipe and ground. The cathode and one side of the filament are grounded, with the second filament lead going to the 6-volt side of the filament switch. The usual filament by-pass condenser was omitted since it had no particular effect. Coupling between the tank circuit and the antenna is through the midget variable condenser C₃. Holes are drilled along the center of the plate pipe so that the coupling condenser may be tapped in at the point which provides the best loading. The tap should be as far toward the cold end of the line as is consistent with good loading.

It will be noticed that the transmitter parts list specifies either a high value of grid leak, 50,000 ohms, or a low value, 900 ohms. Although either leak gives identical results when the antenna is properly coupled, there is a marked difference in

the operation under other conditions. With the 50,000-ohm resistor, the plate current will rise as the plate load is increased. However, when the low-resistance leak is used, it will be found that the no-load plate current is quite high and that the current decreases as the antenna is more tightly coupled to the circuit. With either method the plate current reading at full load will be 11 to 13 ma. We used the 900-ohm leak since tests indicated that the stability and output were better.

The case, dimensions of which were given previously, is divided into three compartments as shown in Fig. 7. The photograph shows the location of the transmitter and batteries. The inside dimensions of the three compartments are as follows: Receiver-modulator compartment, 6 $\frac{1}{2}$ by 6 $\frac{1}{2}$ inches; battery and switch compartment, 6 $\frac{1}{2}$ by 8 $\frac{1}{2}$ inches, transmitter section, 2 $\frac{3}{8}$ by 15 inches.

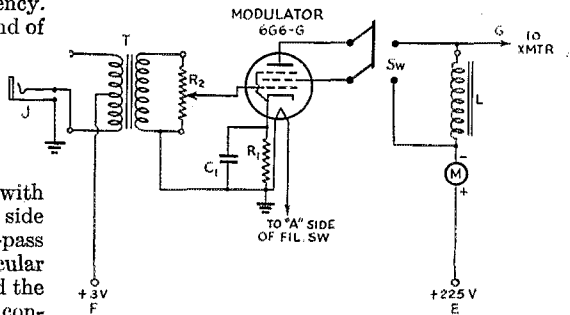

Fig. 4 — Modulator wiring diagram.
 C₁ — 25- μ fd., 25-volt electrolytic.
 R₁ — 600 ohms, 1-watt.
 R₂ — 0.5-megohm potentiometer.
 J — Open circuit jack.
 T — D.b. mike to single-grid transformer (Stancor A-4708).
 L — Filter choke used as modulation choke (Stancor C-1002) (30 henrys, 50 ma., 400 ohms d.c. resistance).
 Sw — D.p.d.t. toggle switch.
 M — 0-50 milliammeter (Triplett).

When the various walls, ends and sides of the case are being put together, quarter- and half-inch brass angle should be used freely. We found that more than enough rigidity could be secured by using the half-inch angle at the corners where the top and side pieces meet, and the quarter-inch strip at all other places where panels and walls had to be fastened. Of course, all the pieces of angle are drilled and tapped for $\frac{5}{32}$ machine screws.

Condenser C_2 consists of two $\frac{7}{8}$ -inch diameter copper disks. In making them, use a compass to draw the circles on the copper sheet so that a mark is left in the exact center of the circle. After the disks have been cut out, small holes are drilled in the center of each plate and at this point a brass machine screw, from which the head has been clipped, is soldered. Next, holes are drilled through the tube ends of the pipes, and tapped to take the condenser screws. The disks may then be mounted as shown in the photograph. A short extension of bakelite rod is threaded to the plate side of the condenser to project through the side of the case for tuning purposes.

After mounting the disks, the plate and grid lines are fastened together with two strips of victron. The best available insulation should be used here. These strips should be placed at the center and at the cold end of the line and should permit the pipes to be separated by one diameter. After the line is assembled it is mounted on the back wall of the case and placed so that it will slide into the transmitter compartment. The line is supported on isolantite insulators (National GS-2 without the metal parts) elevating it slightly above the tube socket, which may be mounted as shown in Fig. 7.

One more glance at Fig. 7 shows the few

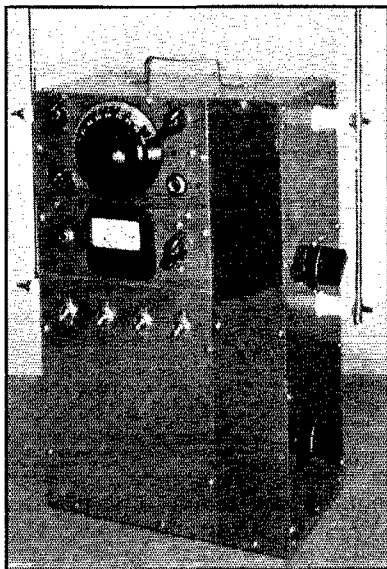

Fig. 5 — The complete pack set. The three divisions, receiver and modulator (upper left), battery compartment (lower left) and transmitter (right) are easily discernible in this photograph.

remaining parts mounted on the case walls. To the left of the resonant line is a pair of small feed-through insulators for the purpose of bringing the plate and filament leads into the transmitter proper. One of the insulators is above the battery partition and the other is below. The lower one is for the filament lead and is placed here so that the filament wire may run directly from the tube socket to the filament switch, and the upper one is placed so that the plate lead from the transmitter may go directly to the modulation choke. Both of the leads are shielded wire so that the shield may be grounded and thus prevent standing waves from appearing on the wires. The antenna coupling condenser is mounted on the left side-wall of the transmitter section and is placed far enough away from the front and side to bring it to the rear of the tank circuit when the case is completely assembled. A coupling is used so that a bakelite extension shaft may be brought outside the case for tuning.

Antennas

It was deemed advisable to use separate antennas for the receiver and transmitter, to eliminate the complications and possible inefficiency of a switching system. The antennas, telescope-type rods which may be adjusted to a half-wave length at 112 Mc., are mounted on feed-through insulators on the right and left sides of the case. Although two insulators are used for each antenna, only the one at the base makes connection between the antenna and the appropriate circuit; the top insulators are used simply as supports. The antenna rods are fastened to the insulators by clamps made from copper strip. Although a great many types of automobile antennas could be used for the purpose, the

Fig. 6 — The transmitter circuit.

- C_1 — 100- μ fd. midget mica.
- C_2 — See text.
- C_3 — 15- μ fd. variable (National UM-15).
- R — 900 or 50,000 ohms, 1-watt (see text).
- L — 12 $\frac{1}{2}$ -inch lengths (two) of $\frac{3}{8}$ o.d. hard-drawn copper tubing (see text).

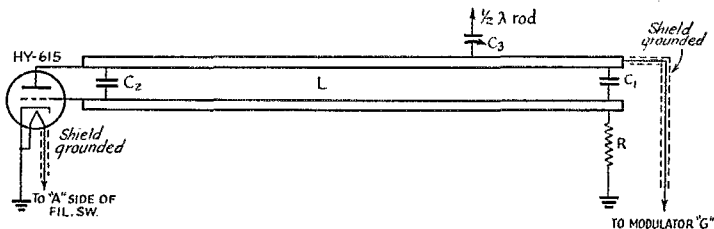

one shown¹ is inexpensive and will telescope to a very short length.

Power Supply

Fig. 8 shows that there are two filament supplies, one for the 6.3-volt tubes and another for 1.4-volt tubes. Naturally, the drain on the 6-volt supply is much higher than that on the 1.5-volt battery and therefore the latter is going to have the longer life. When the voltage of the 6-volt supply starts to drop off, the negative lead may be disconnected from ground and connected to the positive terminal of the 1.5-volt battery. If this is done, the useful life of both batteries will be the same.

Tuning and Adjustment

After completion of the pack assembly, it is wise first to try the receiver. This should be done with the antenna connected, since the behavior with and without the antenna will be quite different. First the antenna rod should be adjusted to a half wave at the frequency of operation. If operation is planned at the low-frequency end of the band, then the antenna should be approximately 4 feet long; to resonate at the high end it should be about 3 feet 9 inches long. These lengths should include the length of the lead-in between the antenna rod and the detector circuit; that is, the figures suggested are the total length from the grid circuit to the top of the rod. A great deal of care should be taken in the adjustment of the rods since the best results can be obtained only when the antenna is right in resonance.

¹ Type No. 82, Deluxe Manufacturing Co., 1408 Agnes Ave., Kansas City, Mo.

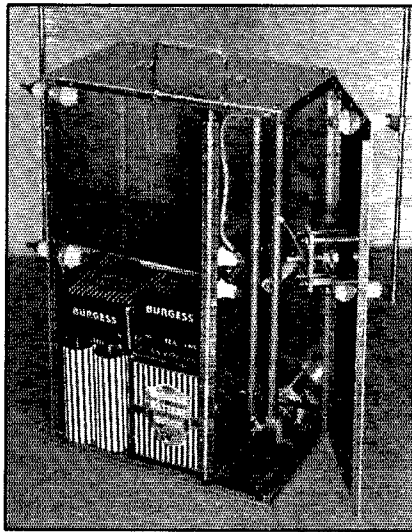

Fig. 7 — A view with the panel removed to show the transmitter and battery compartment. The antenna coupling condenser is mounted on the right-hand wall. The oscillator tube is mounted at the bottom of the resonant line.

With the antenna connected, the filament switch is closed and the filaments allowed to heat up for a second or two. The headphones are plugged in and the plate switch closed, after which the regeneration control is turned up until a hissing noise is heard, indicating that the circuit is superregenerating. The detector is most sensitive at the point where superregeneration is just starting.

As anyone who has had any experience with u.h.f. gear will admit, two similarly-constructed sets may quite frequently act altogether differently, because of stray capacities and inductances. In the event that the constructor of this particular receiver does run into bugs the following suggestions may be

of some help. Shifting the frequency of the quench oscillator often will improve the performance of the detector. This may be done by changing the capacity of C_6 . In circuits of this type it is possible that r.f. will leak through to the audio amplifier, with resulting unsatisfactory behavior. This effect can usually be eliminated by experimenting with the capacities of condensers C_4 and C_5 . Also, it is sometimes wise to add another condenser to the circuit, this to be placed directly between the plate prong of the 1C5G socket and ground. One should also experiment with the placement of the coil tap, as a slight shift of this tap will greatly affect the results.

Next, the transmitter should be tested for oscillation. The behavior of plate current will depend upon the value of grid leak used, as already described. In any event, after the antenna

(Continued on page 98)

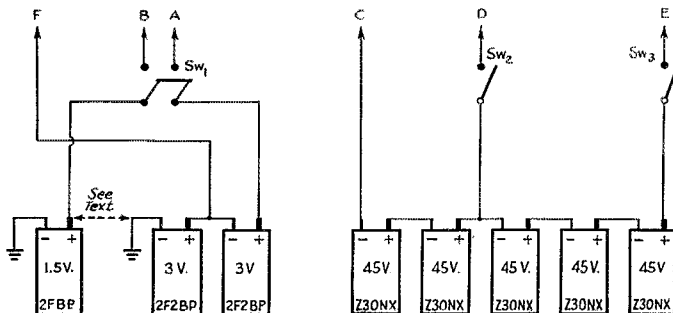

Fig. 8 — Battery connections. Sw₁ is a d.p.s.t. unit, Sw₂ and Sw₃ each s.p.s.t. Letters refer to similar designations on other diagrams.

The 1852 as a Mixer

Replacing the 6L7 in the Regenerative S.S. Receiver

THE high gain and low noise of the 1851-52 type tubes have been so offset by increased circuit loading that comparatively little use has been made of the tubes in communication receivers having i.f.'s of the order of 455 kc., because of the unfavorable effect on image ratio.¹ Neglecting input loading for the moment, however, there is another application in which the 1852 (and its electrical twin, the 1851) is an outstanding performer — that of a frequency converter, or mixer, in a superhet. In this service the tube will give a much higher order of gain and a better signal-to-noise ratio than any of the conventional mixer tubes.

Fig. 1, from a paper describing the characteristics of the tubes in *RCA Review*,² shows the conversion transconductance obtainable with various values of cathode resistor, using grid-circuit injection of oscillator voltage. Grid injection is recommended in preference to cathode injection, since the latter method involves an increase in the cathode-circuit inductance and hence an increase in input-loading effect. The second set of curves shows variation of cathode current for equivalent conditions. Observe that the transconductance values are higher than those of ordinary tubes such as the 6K7 (average around 1500) when the latter are used as *straight amplifiers*; in other words, the 1852 will give a great deal more gain as a mixer than the 6K7 as an amplifier at the same input frequency. In the average mixer tube, including both combination mixer-oscillators and special mixer types such as the 6L7, the conversion conductance is in the vicinity of 500 μ mhos, a fifth or less of the conductance obtainable with the 1852. While these differences in gain are striking, they would not be of too great practical interest were it not for the fact that the tube is less noisy and hence gives a marked improvement in signal-to-noise ratio as well as in gain.

The benefits of the 1852 as a mixer are most apparent in sets where the mixer is the first tube. This is particularly so when regeneration can be used to increase the signal-to-image ratio. Without regeneration, images probably will be worse than with conventional mixer tubes. But in receivers such as the regenerative S.S. outfit described not long ago in *QST*³ the overall performance can be stepped up considerably by

substituting the 1852 for the 6L7. Measurements have shown an improvement of at least 2:1 in the signal-to-noise ratio of this receiver with the 1852 installed; in fact, the ratio is as good as that obtainable with any of the better-class receivers having an r.f. amplifier as the first tube. The additional gain is only too apparent, and often is embarrassing rather than helpful in view of the limited gain control facilities of the set — particularly with the i.f. amplifier regenerating to give the single-signal effect.

The circuit changes necessary to install the 1852 in the regenerative S.S. receiver are shown in Fig. 2. Comparison of this diagram with those previously given (the parts designations correspond) will show that only minor changes are necessary. C_5 is now connected between the oscillator plate and the mixer grid instead of between the oscillator grid and 6L7 injection grid as in the original circuit. The screen dropping resistor, R_8 , is changed to 100,000 ohms. An additional bypass condenser, C , is installed between the 1852 cathode and ground; a midget unit is used for this purpose so that the r.f. ground connection will be as short as possible. The suppressor grid of the 1852 is grounded rather than connected to cathode; there is negligible difference in gain between the two connections, but the image ratio is slightly better with the suppressor grounded.

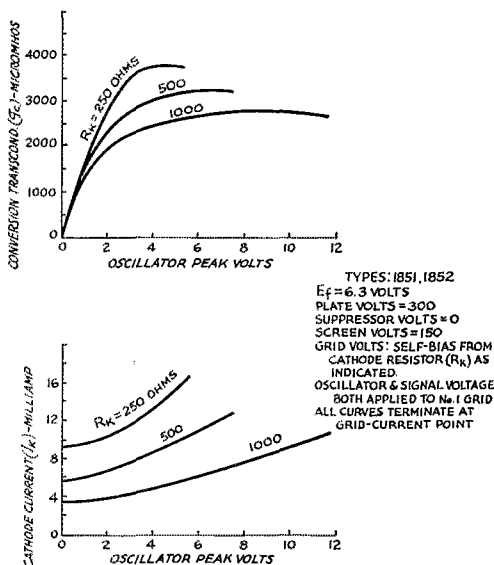

Fig. 1 — Characteristics of the 1852 as a frequency converter.

¹ "Input Resistance of R.F. Receiving Tubes," *QST*, May, 1939.

² A. P. Kauzmann, "New Television Amplifier Receiving Tubes," *RCA Review*, January, 1939.

³ "A Low-Cost Single-Signal Receiver," *QST*, October, 1938. Also *The Radio Amateur's Handbook*, 1939 Edition.

Since the input capacity of the 1852 is higher than that of the 6L7, it was found necessary to remove one turn from L_1 at 28 and 14 Mc. to bring the band well on the scale of C_1 . The oscillator coils should need no changing, although the band-set condenser may need to be shifted slightly from its position with the 6L7. Also, with the revised circuit the oscillator loading is considerably lighter, with the result that on the higher-frequency bands the oscillator may "squeg." This can be cured by moving L_5 farther away from L_4 . It has been found desirable to work the oscillator on the low-frequency side of the signal at 28 Mc.; the mixer regeneration control seems smoother this way, and on the whole, images are less troublesome.

Oscillator-Mixer Coupling

There have to be a few flies in the ointment. For one thing, the oscillator voltage is somewhat critical if maximum gain is desired, which means that there is an optimum value of C_5 on each band. If the oscillator voltage at the mixer grid is too low, the gain will drop off badly. Unfortunately, the oscillator-mixer coupling, for a given setting of C_5 , decreases as the frequency is lowered, and at the same time the selectivity of the mixer input circuit increases; the net result is that it becomes difficult to inject sufficient oscillator voltage in the mixer grid circuit at the lower frequencies. At 1.75 Mc., for example, C_5 should be set at full capacity (30 $\mu\text{mf.}$) for adequate oscillator voltage transfer; with the con-

denser at minimum the receiver is almost inoperative. On the other hand, on 28 Mc. the adjusting screw on C_5 should be out just as far as it will go. However, satisfactory overall operation can be secured on all bands except 1.75 Mc. with C_5 at minimum, although the gain on weak signals at 3.5 Mc. under these conditions is about one-fourth its value at optimum oscillator-mixer coupling. The signal-to-noise ratio remains unchanged, fortunately, so that there is no loss in effective sensitivity. On strong signals the comparative reduction in gain is considerably greater, so that in practice the weak oscillator voltage gives an a.v.c. effect on 3.5 Mc. At 7 and 14 Mc. the reduction in gain with C_5 at minimum instead of the optimum setting is inconsequential. Thus a single coupling condenser is perfectly practical as a compromise for all bands except 1.75 Mc.

The coupling problem can be overcome by using a separate condenser at C_5 on each band, mounting it in the oscillator coil form. This will require the use of 6-prong coil forms instead of the 5-prong units previously specified. The small trimmer should be connected between the oscillator plate pin and the sixth pin, and should be mounted so that it is readily adjustable. The correct setting can be found quickly by applying a weak signal to the receiver input and adjusting the coupling until maximum output is secured with R_2 near the minimum-resistance position. The mixer preferably should be non-regenerative when this is done; unsolder the mixer plate and i.f. transformer leads from the coil socket and temporarily connect them together so that the tickler, L_3 , is completely out of the circuit. The normal connections may be restored after the optimum coupling capacity is found.

With the grid coil previously specified for 1.75 Mc. the 1852 has a tendency to oscillate at i.f., probably because of the high grid-circuit impedance resulting from the high L/C ratio in L_1C_1 . A satisfactory cure is to reduce the L/C ratio by installing a 50- $\mu\text{mf.}$ trimmer (a good mica unit is OK) in the coil form and taking 25 turns off L_1 . The trimmer is connected across L_1 , and is adjusted so that C_1 just covers the band over its whole scale.

Regeneration

The high transconductance of the 1852 makes regeneration something of a problem. We found it impossible to get satisfactory control of oscillation with any tickler coil wound on the same form with L_1 . The expedient of winding a small-diameter coil and mounting it inside the form so that the coupling could be varied was finally adopted. These coils are all wound to $\frac{5}{8}$ -inch diameter, of No. 18 d.c.c. wire, and consist of one turn on 28 Mc., 2 turns on 14 and 7 Mc., and three turns on 3.5 and 1.75 Mc. The No. 18 wire is stiff enough to make the coil self-supporting by its own leads

(Continued on page 102)

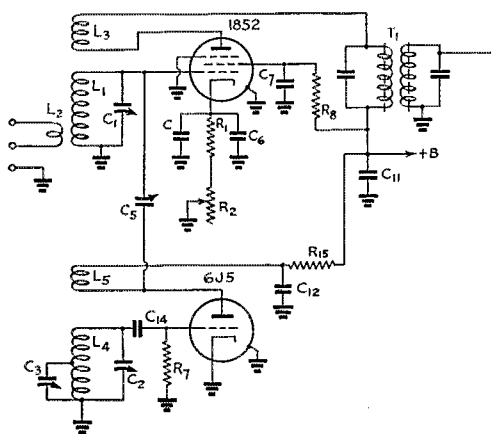

Fig. 2 — 1852 mixer in the six-tube regenerative s.s. receiver.

- C — 0.002- $\mu\text{mf.}$ midget mica.
 C_5 — 3-30- $\mu\text{mf.}$ trimmer (National M-30).
 C_6, C_7 — 0.1- $\mu\text{mf.}$ paper. R_2 — 1000-ohm variable.
 C_{11} — 0.2- $\mu\text{mf.}$ paper. R_7 — 0.15 megohm.
 C_{12} — 0.005- $\mu\text{mf.}$ mica. R_8 — 0.1 megohm, 1-watt.
 C_{14} — 100- $\mu\text{mf.}$ mica. R_{15} — 15,000 ohms, 1-watt.
 R_1 — 300 ohms. T_1 — I.f. transformer.
 Tuned circuits — Same as in original receiver with modifications described in text.

"90 Plus"

A Story for DXers

BY ALAN P. BUFFINGTON,* W3EEW

THE cold winter wind sang as it whizzed by the corner of Abner's house, and somewhere in the bleak night a dog howled. It was clearly a night for DX, and Abner glowed with anxiety as he sat in his shack waiting for the receiver to settle down. Blurs of high-pitched whining commercials approached with growing intensity and again grew inaudible as they passed by the 90 mark on his dial; 90 — where QRM ended and DX began — where Grand Island inspectors strained their ears for the cycle clippers staging their nightly combat.

At long last the detector grew tired of its roaming career, and slowly but surely the high end of 20 approached, heralded by a motley crew of burps frantically seeking a happy hunting ground just in the clear.

Abner opened up his ears another notch and began the search. Surely he would be rewarded. Had he not spent nearly three weeks of painstaking effort, and had he not wished that he might have some valid reason for making out a QSL card? At least his total reward so far had not been overwhelming — two SWL cards stating that he was S9 plus almost two miles away, and would he Pse QSL???

Glancing once more at his beloved 6L6G, which was serving yeoman duty as crystal oscillator, doubler, and power amplifier, with plate current appropriate to the occasion, he pressed the key gingerly. A disconcertingly loud crash greeted his efforts, the receiver doing its utmost to welcome this sudden surge of signal strength after being accustomed to feeble yoops and tweets emanating from distant lands. "Dagnabit!!" muttered ye opr. under his breath, to avoid being cited by the FCC for contempt of court.

The receiver slowly gathered itself together and, with as much dignity as it could muster, began its proper function of ferreting out DX signals. Elaborate precautions having been taken to prevent any more such outbursts in the future, the key was again depressed. A fuzzy shadow on the meter dial resolved itself into a small blur and then unhesitatingly decided on 130 mls as the proper current for a self-respecting oscillator to draw. Blithely whistling to himself, Abner adjusted the plate knob very precisely, decided that great things were about to happen.

The receiver was again restored to its normal function, and a satisfying babble of toots notified him that things were once more going full blast.

Realizing that there were about seven too many signals in his headphones, Abner screwed up his forehead and began concentrating in earnest. At last one deliberate signal penetrated his gray matter sufficiently to inform him that a certain W6 clunk clunk (any resemblance to any W6 living or dead purely accidental, of course) was firmly notifying the assembled multitude that he was testing — just testing. After wavering for two minutes between the merits of NST and TEEEEET, he abruptly silenced his emitter for reasons unknown. (Probably blew a fuse. — Ed.)

Hesitating for an instant to enjoy the good fortune which had befallen him and his fellow sufferers, Abner again widened his ears out to full fidelity and started looking once more for that well-known phenomenon which inhabits 14,405 kc. — called DX by more familiar operators.

Abner wasn't sure, but it sounded somewhat like a St. Bernard with a hoarse throat barking down a rainspout, or perhaps a foghorn calling for its mate. At any rate, he had suspicions that this might be the much-talked-of DX, and these suspicions were confirmed a second later when, upon cessation of the grumblings and hissings going on under his haircut, a mighty bedlam burst forth far up in the spectrum consisting of 25 DX-minded men all operating on 14,399.7 kc. by authority of the Federal Communications Commission. This startling sign of activity, which made the roar of a few moments ago sound like a mere whisper, could mean nothing but that the assorted buzzings and bellowing going on up on 14,405 kc. had been caused by a DX STATION!

"Eureka!" shouted ye opr., momentarily forgetting that it was yet to be discovered who was causing said noises. Thumbing with an experienced thumb through his ancient Callbook (no charge for plug) to the DX section, he prepared to baffle the world by actually deciphering this creature's strange moanings.

One by one the signals calling the creature

(Continued on page 80)

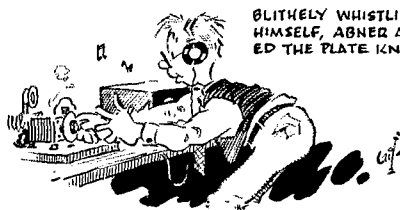

*7509 Boyer St., Philadelphia, Pa.

An Economical Tri-Tet Crystal Oscillator

A Complete C.W. Rig for the Price of a Crystal

BY G. W. HORTON,* W9IGF

SPEAKING of crystal oscillators from a standpoint of compactness, economy and watts per dollar, the one described here should prove interesting to the amateur who likes to build his own equipment. It is dedicated to the chap on a limited budget who is just getting started, seeking something that can be used for a transmitter for the time being and later combined with whatever larger rig he may decide to build.

The original idea was presented by W2GCV,¹ using a type 25L6 crystal oscillator. These tubes are well adapted to very compact equipment — since relatively low plate voltage and current are required the line voltage is rectified directly and no transformer is necessary. It was decided to use a Tri-tet circuit in this particular rig since this provides for fundamental as well as harmonic operation.

Perhaps the most difficult decision, on the part of the author, was that of selecting a suitable chassis upon which to mount the parts neatly and compactly without undue crowding. The lid from a discarded Majestic B-eliminator solved the problem admirably by providing a substan-

tial foundation as well as ample space for mounting all of the equipment.

A piece of "presdwood," $5\frac{3}{4}$ by $5\frac{1}{2}$ inches, is used for the panel, with the upper portion cut to follow the contour of the top of the meter. This adds to the appearance of the rig when used alone or when associated with breadboard construction, and also makes the coils more accessible from the front of the panel.

The tuning condensers are mounted on opposite sides and at one end of the chassis by brackets which also serve as panel supports. The panel is held in place by passing the condenser mounting hubs through both bracket and panel, with the dial plate acting as a washer for the nut.

A closed circuit jack, to take the keying leads, is mounted $1\frac{3}{4}$ inches from the bottom of the panel, on the center line, and this leaves just enough room between the jack and the chassis for mounting the power-supply switch.

Four $1\frac{1}{4}$ -inch holes are cut in the chassis to accommodate the sockets for the coils and tubes. The filter condensers, provided they are the metal can type, must first be mounted on a bakelite strip, as they are connected in series with the outsides above ground potential. However, if they are the cardboard-case type, this precaution is unnecessary, and they may be mounted across the space to be occupied by the bakelite strip. Assuming the filter condensers to be of the metal can type, after first mounting them on the bakelite strip or base it in turn is mounted $\frac{1}{2}$ inch above the chassis by means of $\frac{1}{2}$ -inch spacers placed on each of the supporting bolts at either corner of the strip. It might be well to mention a further precaution regarding the filter condensers. Preferably they should be of the paper type, as considerable a.c. appears across the two condensers at the input, and in no case should the "wet electrolytic" type be used at this point.

The filter choke is mounted along the right side of the chassis, and the crystal holder mounting together with the grid leak and r.f. choke occupy the left side. If the crystal is more accessible from the right-hand side of the rig, the respective filter choke and crystal holder mounting may be reversed. In either case the sockets for the tubes and coils should be mounted so that short direct leads can be made to each component part. This will contribute to the over-all efficiency, and is just as essential as if the rig were on a much larger scale, if best results are to be obtained.

Parallel feed is used in the plate circuit, in or-

* 2118 North Park Ave., Grand Island, Neb.

¹ Experimenter's Section, QST, June, 1937.

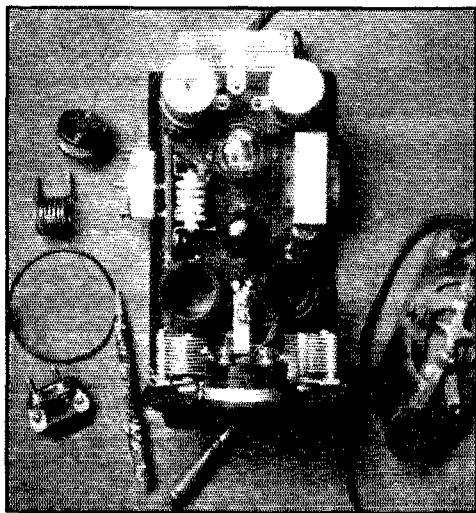

The top of an old "B-eliminator" is used as the chassis for this Tri-tet oscillator. (The dimensions are $5\frac{1}{2}$ by $9\frac{1}{2}$ inches.) No plate transformer is required, since a 25L6 and 25Z5 are used.

der to maintain voltage on the plate while changing coils. This insures against excessive screen current and consequent tube damage if a coil is left out of the plate circuit, as is invariably the case when series feed is used with no dropping resistor in the screen supply. The necessity for the r.f. chokes to carry out their function cannot be overemphasized, and therefore "haywire" chokes, or chokes of doubtful quality, are almost certain to give trouble.

For Tri-tet operation on a harmonic of the crystal frequency, the cathode coils should be designed so that when the cathode circuit is tuned to resonance the condenser setting is near maximum capacity.² It is then detuned toward low capacity for maximum output consistent with a low value of crystal current, assuming resonance in the plate circuit.

For pentode operation, on the fundamental frequency, an ordinary five-prong tube base with a jumper replacing the winding on the cathode coil is placed in the cathode socket and the plate circuit tuned to the crystal frequency. The usual method of bending one of the plates on the cathode tuning condenser, to short out the coil in one position, while somewhat simpler, would result in the loss of cathode bias, since the condenser frame is grounded.

Coil winding data given in any of the past several issues of the *Handbook* for tube base coil-forms will prove satisfactory in most cases and therefore is omitted.

² Lamb, "Survey of Pentode and Beam Power Tubes as Crystal Oscillators," *QST*, April, 1937.

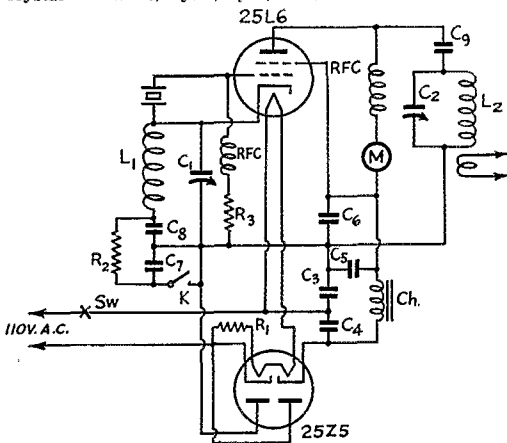

Fig. 1 — Complete circuit diagram.

- C₁, C₂ — 35- μ fd. midjet variable (Hammarlund Star).
- C₃, C₄, C₅ — 8- μ fd., 250-volt.
- C₆, C₇, C₈ — 0.05- μ fd. by-pass, paper.
- C₉ — 50- μ fd. mica.
- R₁ — 200-ohm line cord resistor.
- R₂ — 150 ohms, 2-watt carbon.
- R₃ — 25,000 ohms, 1-watt carbon.
- Ch — 85-ma. broadcast choke.
- RFC — 2.5-mh. r.f. choke (National).
- M — 0-100-ma. milliammeter.
- K — Key.

Here's a low-powered c.w. transmitter with some nice design features. Complete with tubes, the cost is less than \$5.00, and its small size makes it readily adaptable to portable work.

Considering the low plate voltage (in the neighborhood of 160 volts), the 25L6 compares favorably as a crystal oscillator with tubes of the 47, 6L6 and 802 type. The fundamental output is more than sufficient to drive a 10 or 801 buffer or doubler stage, while tubes with low driving power requirements such as the 807 can be pushed to full output from the second, third or higher harmonics.³

A short time after the rig was completed here at W9IGF it was decided to see how it would perform on the air, and during a single session on the 40-meter band from 1:00 A.M. to 4:30 A.M. I received an S6 report from W8NRO, Braddock, Pa., and S7 from W6BBM, Oakland, Calif.

³ Ferrill, "One Crystal — Two Tubes — Five Bands," *QST*, March, 1939.

Strays

W1XAL TO BROADCAST TELEVISION INSTRUCTION

An eight-week course in "Practical Television" has been announced by W1XAL as an addition to its "World University of the Air" curriculum. The course will be broadcast each Monday evening at 8 P.M., E.S.T., on 6.04 and 11.73 Mc., with transcribed repeats at 11:30 P.M., E.S.T., and again each Friday afternoon at 4 P.M.

Dr. C. Davis Belcher, popular conductor of an annual radio instruction course broadcast over the station, will employ the same general technique in his television lectures as he does in teaching radio. Speaking extemporaneously, he will refer to master drawings of which each student is supposed to have a copy. A 40-page booklet of diagrams is supplied by the World Wide Broadcasting Foundation of Boston at a price of one dollar, which covers the cost of preparation and mailing. This booklet can be obtained by addressing the station, W1XAL, at the University Club, Boston, Mass., U.S.A.

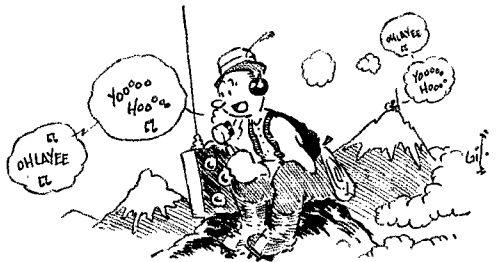

The Rig at W8XAI

Notes on an Interesting U.H.F. Transmitter

BY JOHN J. LONG,* W8ABX

DURING the past three years, considerable experimenting has been done with the transmitter at W8XAI. Most of the development work has been done by Alfred Balling, old W8ALY of 10-meter fame. With his complete knowledge of conditions as they have existed since 1928, he has been able to make very definite improvements in equipment to operate on these frequencies, under the rigid conditions imposed by operating 18 hours a day.

Many circuits have been tried and practically every tube and component designed for high-frequency work has been put through its paces. As a result, the present layout will operate for

*Stromberg-Carlson Telephone Mfg. Co., Rochester, N. Y.

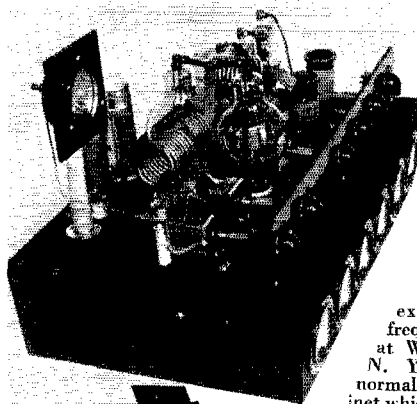

Two views of the experimental high-frequency transmitter at W8XAI, Rochester, N. Y. The chassis is normally housed in a cabinet which also contains the modulation equipment and power supplies.

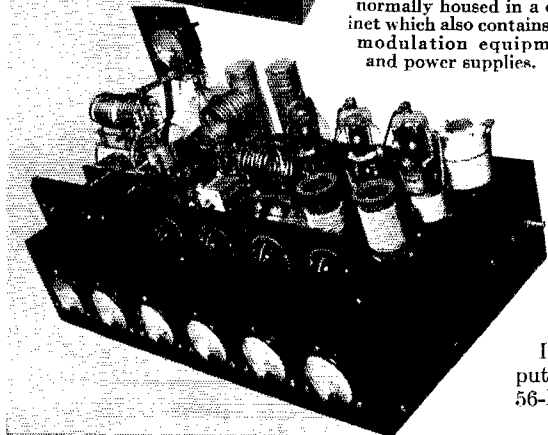

When engineers who are also old-time hams get together to build an experimental u.h.f. broadcast transmitter they are likely to combine engineering reliability with amateur ingenuity in the result. That's why this is not a constructional article — we thought you might like a few ideas instead of "how many turns."

long periods of time without changing output, frequency, or quality. It has been in operation over 6000 hours without any failures and looks as though it will be good for much more service.

Most of the circuit is quite conventional. An RK25 Tri-tet oscillator with a temperature-controlled crystal is used, doubling in the plate circuit. This is followed by two RK39 doubler stages, capacity-coupled. The second doubler stage is link-coupled to the grid circuit of the final amplifier. The final amplifier uses a somewhat unorthodox, although not new, system of neutralization. Two 100TH's are connected in the conventional push-push doubler circuit but one side of one filament is switched open. As a result, the grid-plate capacity of the tube that is not in use acts as the neutralizing condenser for the active tube and, in the event of tube failure, the good tube can be switched into the circuit and the poor one switched out, and the time lost will only be that necessary for the filament to warm up. By plugging-in a smaller coil in the plate circuit, and switching on both filaments, the final amplifier will act as a push-push doubler for operation on the harmonic frequency.

The audio-frequency system delivers 100 watts of audio and is flat to 10,000 cycles. Push-pull is used throughout, since it was found that this minimized trouble from stray r.f. pick-up. A 1000-volt power supply is used for the final amplifier and modulator, and a 500-volt supply furnishes power for the oscillator and doubler stages.

The complete r.f. unit is mounted on a steel chassis base which was first copper-plated and then crackle-lacquer finished. No shielding was used, and everything was left in the open, to allow better ventilation. The entire transmitter is housed in a steel cabinet. The r.f. chassis slides out on a track, for easy servicing. The controls are hidden behind doors on the front of the cabinet, but the meters can be seen readily through a glass panel.

In time of emergency, the transmitter can be put into operation on either the amateur 28- or 56-Mc. band.



ARMY-AMATEUR RADIO SYSTEM ACTIVITIES

DURING the past operating season there were several activities of national interest in addition to the regular A.A.R.S. drills. These activities were planned as a diversion from the regular routine. Numerous contests, etc., were conducted in each Corps Area but we will mention here only those activities which affected the A.A.R.S. as a whole.

On September 12, 1938, the season was officially launched with a "free-for-all" QSO party. 616 stations participated in spite of poor reception due to heavy static and weak signals on the low frequencies. High individual was W6CVL with 104 contacts.

The broadcast of October 27th requested all members having emergency equipment available to originate a message to WLM stating whether their equipment belonged to Class "A" or Class "B." Class "A" stations were designated as being available at a moment's notice and capable of operation independent of the regular power mains. Class "B" stations could be operated by bringing in any type of emergency power supply such as batteries or gasoline generators, such equipment to be available within a reasonable distance of the station. A total of 110 Class "A" and 46 Class "B" stations replied to this broadcast.

On November 11th the annual Armistice Day competition was held, with 966 members copying the greeting to all A.A.R.S. members from the Chief Signal Officer. This contest was won by the Ninth Corps Area.

Immediately following the weekly broadcast on November 14th, an imaginary emergency was declared to exist in Wisconsin, Florida, Missouri, Texas and Washington. State net control stations were instructed to mobilize their nets as quickly as possible and report to WLM stating the number of stations participating and the average time required for stations to contact the state net control station. Results were very gratifying, with 90 per cent of the Florida membership participating to win the competition.

Florida c.w. net had 33 stations active with average time of 20 minutes.

Missouri c.w. net had 6 stations active with average time of 3 minutes.

Texas c.w. net had 18 stations active with average time of 1 minute.

Washington c.w. net had 27 stations active with average time 4½ minutes.

Wisconsin c.w. net had 10 stations active with average time ½ minute.

Wisconsin 'phone net had 11 stations active with average time 20 minutes.

On December 5th a message was sent out on two unknown frequencies. As soon as the message was intercepted, stations were instructed to report into the corps area net reporting the frequency and signal strength of the unknown station. Upon receipt of three such reports the CANCS (Corps Area Net Control Station) was to report the results and time required to get the three station reports. In each corps area the time was a matter of only a few minutes.

The Annual Speed Contest was one of the highlights of the season. A Mac-Key bug, donated by Terminal Radio, New York City, was awarded to W5FDR, who copied 65 words per minute. A close second was W2BCX, who copied a solid minute at 60 words per minute. A total of 517 members submitted copies in addition to a large number of non-members who participated.

On February 27th an imaginary emergency was declared to exist in the states of Pennsylvania, Illinois and Utah. The results were very satisfactory, with 33 stations reporting in Pennsylvania, 70 in Illinois and 7 in Utah.

On April 10th WLM tested with emergency station WANC at Jamestown, N. Y. WANC is owned, operated and maintained by the Jamestown (N. Y.) American Legion. The station, along with many other emergency supplies, is completely self-contained in a large trailer and ready to be put into operation at a moment's notice. The signals were very satisfactory on both 2760-ke. 'phone and 3190 c.w. during the entire test at 9:30 P.M. E.S.T.

At the time of this writing, the two final activities have not yet taken place. On April 29th-30th, a (QSO) contest is being held between stations using auxiliary power only. This is the first contest of its kind for the A.A.R.S. and will be similar to the A.R.R.L. Annual Field Day. Extra credit is given to stations operating portable to encourage the maximum use of portable emergency equipment.

The final activity of the season is the Birthday QSO Party on May 29th. All A.A.R.S. stations are invited to participate and birth dates are to be exchanged between stations for verification of contact and also to provide additional interest in

(Continued on page 30)



NAVAL COMMUNICATION RESERVE NOTES

THE NINTH NAVAL DISTRICT N.C.R.

THE Naval Communication Reserve of the Ninth Naval District waddled in its first swaddling clothes in 1926. Madison, Wisconsin, was the birthplace of the first stations where 9UZ and 9EK-9XH started activity on the air. 9UZ is now W9UZ manned now and then. 9EK-9XH, of the C. F. Burgess Laboratories, was manned by P. D. Zurian who was the first radioman to be enrolled in Madison. When some of the first contacts were made on the air, the call, NRRL, still fresh in the minds of radio amateurs, was pressed into service as a means of attraction. There was no intelligent list of the number of men in the Reserve nor was there any way of knowing how many amateurs were interested.

To provide radio drills, it was necessary to start station activity but that couldn't be done until recruits were enrolled. There was no end of confusion when it came to answering questions about enrollment. Some amateurs had a notion it meant leaving home and going off on a tour of sea duty; some expected it meant monthly pay checks and others had visions of foreign ports and sweethearts. The whole problem seemed to be one of trial and error. Could we enroll radiomen? If so, how many and in what length of time? Could we train them and how could that be done? Who would pay for all of this and when? Would these radio amateurs make good operators for the Navy in an emergency? Would such training be compulsory? If so, how often would training be required? Would uniforms be furnished and who would pay for them? Those were but few of the many questions that popped up every day.

Finally, a complete tabulation of the questions was prepared. A monthly publication was mailed to those who had enrolled and to those who showed some interest. Month-by-month, the answers (some of them were vague and evasive) were set forth as best it could be done with the information obtained from Washington via Great Lakes. Recruiting started in earnest. At every amateur convention, a recruiting party was the order of the day. Hundreds and hundreds of amateurs were invited to "join" the NCR. Recruiting parties, especially those in Milwaukee, commenced to produce results and the rolls at Great Lakes swelled rapidly. Amateurs came to conventions with the sole purpose of getting into the NCR. Some of them did not meet all of the necessary requirements. The records at one time

contained the names of approximately 1500 officers and men.

Another vexing problem loomed. What could be done to hold the interest of these men? To maintain their activity, something of interest had to be provided. There was yet a vagueness about it all. NAJ (Great Lakes) couldn't possibly undertake radio instruction. A radio transmitter was set up in Chicago (Lincoln Park) by Mathews (Central Division Director) and radio drills were started. This became a greater task than could be handled by one station and a few men. Eventually, a transmitter was built at Great Lakes and installed in the then new Naval Reserve Armory at Chicago. This became NDS and radio drills were conducted on frequencies within the amateur bands. This, of course, was discouraging because immediate identification of a station was impracticable with stations using the W prefix. Came the N prefix after years of struggling.

When Lieutenant Commander Lee, U.S.N.R., moved in and took a desk in the Office of Director of Naval Communications, at Washington, out of the chaos came the splendid order of things we have in the NCR to-day.

Great Lakes is the home of the Ninth Naval District where NAJ again will take to the air after a silence of several years. NDS is the Master Control Station (with a modern installation) at the Naval Reserve Armory in Chicago. The alternates are NPD, Sioux City, Iowa; NEG, Cincinnati, Ohio and NID, at Akron, Ohio. Ten Sections comprise the Ninth, each section having a control and alternate control stations. Up to ten units are included in each section and each unit has its control and alternate stations.

During the Ohio Valley Flood, of 1937, the Ninth gave a commendable account of activities during that emergency as well as several others.

Regular summer training cruises on the Great Lakes, of periods of two weeks (with pay and travel allowances), are provided each year in accordance with funds available. Officers and men are extended this opportunity based upon their activity for the year.

Matters of personnel, policy, training, material and education are supervised by the staff officers who meet regularly each month for that purpose. The rolls of the NCR now number (144) officers and (1290) men. There has been a general tightening up on the NCR and the requirements are just as stiff as those of the Navy. To get into the NCR to-day, you've got to be good.

Western Union to Collaborate With Amateurs

IN THE event of any communications emergency all radio amateurs are dedicated to serve the public interest. General and specific amateur service has been offered many officials and agencies in time of emergency. The Red Cross, different individual railroads and utilities, U. S. weather forecasters, and public officials all have been helped. Regional amateur networks are maintained for some of these agencies looking strictly to emergency possibilities. Another important agency served at different times, and which we hope to serve again in the future, is the Western Union Telegraph Company.

The prompt handling of urgent emergency messages relating to the public welfare via the fastest reliable route, is the aim of the League's Emergency Corps. One of the most important uses of radio is to inform supply sources outside an emergency area of the extent of damage, giving information necessary to start work of restoration in motion. To aid in restoring a fully adequate telephone and telegraph service is one of the things importantly in the public interest — and to handle specifically addressed information aiding in "rerouting and restoration" as well as keep the hook cleared of priority official traffic is most desirable. Speaking of priority, this always will be determined for each dispatch filed, on the principle of the greatest good to the greatest number, and in view of the public interest involved.

As one of the agencies we may have occasion to assist in communications emergencies, the League was recently contacted by a representative of the General Office of the Western Union Telegraph Company. It was a pleasure to explain A.R.R.L. organization in full, and offer this important agency the same consideration and plan that is maintained within the amateur ranks to function for the public in emergencies. As amateurs know, the League Emergency Coördinator in a given community heads up a local amateur service planning committee for that community; he keeps a record of all available active Emergency Corps amateurs, and their equipment, their frequencies and telephone numbers. The aim of the emergency corps is to register the equipment and voluntary willingness of every licensed amateur to help in emergencies in accordance with advance plans and policies. So we were pleased to give W.U. a list of Emergency Coördinators, so in any pinch, the W.U. local managers will know who to call upon for coördinated information on the active amateur stations, radio schedules, points in radio nets, local emergency-powered outlet, and so on, so necessary emergency traffic might be filed.

Our only regret was that we did not have *more* communities with the amateur service represented by a committee of amateurs headed up by an Emergency Coördinator — and that our Corps also is some distance from its goal of 100 per cent participation of all licensed amateurs. Discussing the desirability of complete coverage, and the difficulties we have encountered in extending our field organization (even with our Form 7 application-registration blanks made available through scores of officials, and on request to individuals), we met a sympathetic response. To make a long story short, this article is to tell you that Western Union feels our organization plan so desirable that we are assured of friendly assistance of the local managers in extending the A.R.R.L. Emergency Corps, wherever possible.

All radio clubs have been asked to recommend qualified local men to A.R.R.L. Section Managers for Coördinator posts. A.R.R.L. would like to see five to ten times as many community E.C.'s on the job as at present. Newly recruited Corps members will in some instances be considered by SCMs for the Coördinator appointment for a locality.

Join the Emergency Corps Today

A.R.R.L. earnestly urges *every amateur* not already registered to send a card or message to A.R.R.L. for a Form 7, get one from any League official, or ask at the nearest Western Union office. It is *important* to the amateur service to be able to tell the F.C.C. and the Red Cross that *many* of us are in the organized Emergency Corps. It isn't necessary to be a League member to belong. By whatever route, get lined up with the A.R.R.L. Emergency Corps to-day!

Western Union has agreed to take a part with others in expanding the corps, by promoting reasonably among unaffiliated operators the idea of registering their facilities as a preliminary to receiving the A.R.R.L. card that identifies them with the League's Emergency Corps. For that purpose, the W.U. offices will have the familiar Form 7 registry blanks, available to all licensed radio amateurs, to align them with the Corps. These blanks will be routed by the company to A.R.R.L. As soon as recorded, and the applicant informed, the blanks go to SCMs (and local

(Continued on page 98)



HOW WOULD YOU DO IT?



KINKS TO REDUCE HAZARD IN NEUTRALIZING

IN THE articles on safety which have appeared in recent issues of *QST*,¹ the point of removing all voltages before working on the transmitter has been stressed. Although it is possible to neutralize an amplifier by removing all voltages, making an adjustment of the neutralizing condenser, applying excitation, checking grid current while tuning the plate tank circuit through resonance and repeating the process until stationary grid current is obtained, this method is rather laborious and additional check by the neon-bulb method is often desirable. Neon-bulb tests with plate voltage applied are often helpful in determining the presence and nature of parasitic oscillations.

In following the usual practice of holding the neon bulb against the tank coil with one hand while adjusting the neutralizing condenser with a screwdriver held in the other, the hazard is not so great from the tank circuit itself, since the plate voltage is removed from the amplifier being neutralized, but there is always the danger of the hands coming in contact with live circuits of the exciter or its power supply. It was the purpose of Problem No. 26 (see *QST* for March) to bring out some ideas which would make it possible for the operator to make the necessary adjustments with less danger of shock.

Robert Murray suggests the insulated flexible screwdriver, illustrated in Fig. 1, for adjusting neutralizing condensers from a safe distance, after a screwdriver slot has been cut in the end of the shaft of the neutralizing condenser. A length of brass rod is filed to a screwdriver edge at one end and the other end is soldered to a length of coil spring. The other end of the spring is fastened to a length of hard rubber or bakelite rod fitted with a standard knob as the handle. A piece of rubber tubing, cemented over the screwdriver tip and the spring, serves as a locator guide. The screw-

¹ Grammer, "Safety Technique in Transmitter Operation and Construction," *QST*, March, 1939.

Grammer, "Safety Devices for Amateur Transmitters," *QST*, April, 1939.

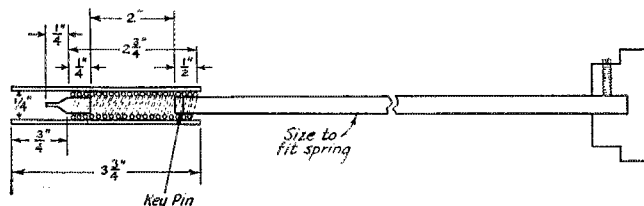

PROBLEM NO. 29

This month Our Hero is turning his attention to injecting some individuality into his QSL card. He wants to try his hand at photographic methods of QSL-card production and wants some suggestions on the best way to go about it. His camera is one of the small inexpensive variety producing a negative somewhat less than half the size of a standard QSL card. His cards must be made by the contact-print method, since he does not wish to bother with projected enlargements. Perhaps the best method does not involve the use of a camera, although expert drawings should not be required, or perhaps the camera may be used in conjunction with other means of producing prints on photographic paper. In any case, the process should require but one exposure of the paper to produce the card. The solution should include some suggestions for setting up the material to be photographed. How would you do it?

driver may be bent at any angle so that it may be used regardless of whether the neutralizing-condenser shaft is running vertically or horizontally.

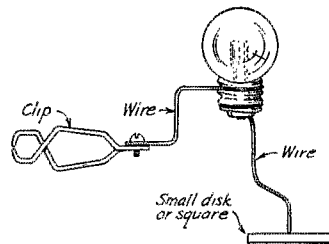

Fig. 2 — The danger of holding a neon bulb in the hand when neutralizing can be avoided by clipping it on one end of the tank coil. The small plate makes up for the usual hand capacity.

Fig. 1 — Home-made insulated flexible screwdriver for adjusting neutralizing condensers at a safe distance.

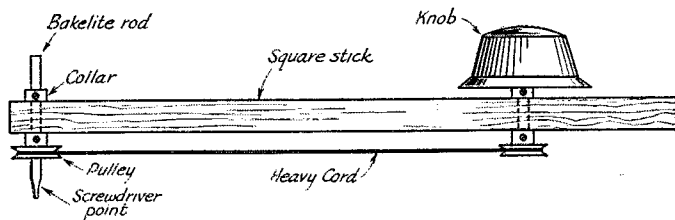

Fig. 3—Another gadget for adjusting neutralizing condensers with safety.

Mr. Murray suggests mounting the neon bulb on a battery clip by means of a few turns of heavy wire wound about the shell of the base, so that it may be clipped on the end of the tank coil or plate terminal of the tube, making it unnecessary to hold the neon bulb in the hand. This may work successfully if the neon bulb is near the chassis but, in some cases, it may be necessary to attach a small metal plate to the central terminal of the bulb. This plate should be connected by means of a length of rather heavy wire which may be bent so that the metal plate is near, but not touching, the chassis. This will provide enough capacity to ignite the bulb even when the adjustment is near the point of neutralization.

Another remote-control screwdriver idea is shown in Fig. 3. It consists of a light stick of wood, or other insulating material, with a pulley mounted on a shaft at each end. The two pulleys are connected with a heavy cord belt. The shaft at one end is ground down to a screwdriver edge and the other shaft is fitted with a knob. The pulleys may be of the type found in toy constructional outfits. The gadget will work with horizontal or vertical shafts and will keep the hands well out of danger.

Dr. R. J. Kasper suggests the arrangement shown in Fig. 4. The screwdriver is the type which

has a neon bulb built into the handle and used frequently in testing automobile ignition systems. The shank is cut off short and ground to an edge and a length of insulating rod is fitted into a hole drilled in the end of the handle. To use this idea, the shaft of the neutralizing condenser must always be connected toward the plate circuit of the tube.

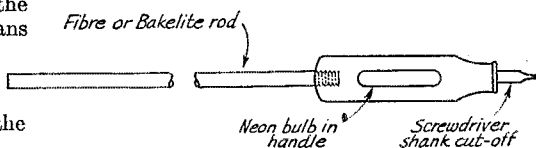

Fig. 4—Combination insulated screwdriver with neon-bulb indicator in the handle.

W4AYE suggests the use of parallel feed in both plate and grid circuits to remove d.c. voltages from the neutralizing condenser. The neutralizing condenser is connected to the side of the voltage-blocking condenser opposite that to which the grid is connected. The same idea may be applied to capacity-coupled systems, providing parallel feed is used in the preceding stage. The blocking condensers may have any capacity from about 100 μfd . upward.

Prize Winners

First Prize—Robert Murray, Long Island City, N. Y.

Second Prize—Dr. R. J. Kasper, Wahoo, Nebr.

We wish also to thank the following for their contributions: W1GBY, 2LOM, 2LWG, 7BIA, SPUY, ex-9IES, P. Hultquist and A. Sorgi.

Problem-Contest Rules

Rules under which the contest is conducted are as follows:

1. Solutions must be mailed to reach West Hartford before the 5th of the publication month following that of the issue in which the problem has appeared. (For instance, solutions of problem given in the June issue must arrive at *QST* before July 5th.) They must be addressed to the Problem Contest Editor, *QST*, West Hartford, Conn.

2. Manuscripts must not be longer than 1000 words, written in ink or typewritten, with double spacing, on one side of the sheet. Diagrams must be neat and legible.

3. All solutions submitted become the property of *QST*, available for publication in the magazine.

4. The editors of *QST* will serve as judges. Their decision will be final.

Prizes of \$5 worth of A.R.R.L. station supplies or publications will be given to the author of the solution considered best each month. \$2.50 worth of supplies to the author of the solution adjudged second best. The winners are requested to specify the supplies or publications preferred.

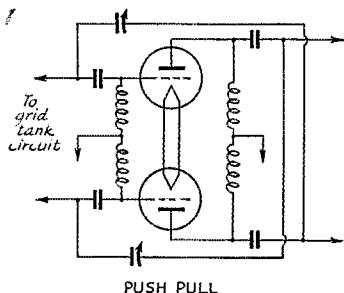
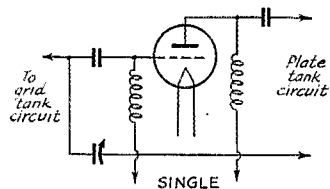

Fig. 5—In certain cases, it is feasible to remove d.c. voltages from the neutralizing condensers by using parallel feed in both grid and plate circuits.

★ I. A. R. U. NEWS ★

Devoted to the interests and activities of the

INTERNATIONAL AMATEUR RADIO UNION

Headquarters Society: THE AMERICAN RADIO RELAY LEAGUE, West Hartford, Conn.

MEMBER SOCIETIES

American Radio Relay League
Asociația Amatorilor Romani de Unde
Scurte
Associazione Radiotecnica Italiana
Canadian Section A.R.R.L.
Československá Amatérská Vysílač
Deutscher Amateur Sende-und-Empfangs
Dienst
Esti Raadio Amatooride Ühing
Experimental Radio Society of Egypt
Experimenterende Danske Radioamatorer
Fédération des Emetteurs Belges
Irish Radio Transmitters Society

日本アマチュア無線聯盟 Japan
Liga Colombiana de Radio Aficionados
Liga Mexicana de Radio Experimentadores
Magyar Rövírdhullámú Amatőrök Országos
Egyesülete
Nederlandsche Vereniging voor Interna-
tionaal Radioamateurisme
Nederlandsch-Indische Vereniging Voor
Internationaal Radioamateurisme
Newfoundland Amateur Radio Association
New Zealand Association of Radio Trans-
mitters
Norsk Radio Relæ Liga

Polski Związek Krotkofalowców
Radio Club de Cuba
Radio Club Venezolano
Radio Society of Great Britain
Rede dos Emissores Portugueses
Reseau des Emetteurs Français
Reseau Luxembourgeois des Ama-
teurs d'Ondes Courtes
South African Radio Relay League
Suomen Radioamatööriilitto r.y.
Sveriges Sandareamatorer
Unión de Radioemisores Españoles
Union Schweiz Kurzwellen Amateure
Wireless Institute of Australia

7-Mc. BROADCASTING

IT is welcome news to learn that, as a result of the efforts of the *Reseau des Emetteurs Français* and the A.R.R.L., the operation of "Paris Mondial," first and loudest 7-Mc. broadcasting station, was suspended as of April 1st. It is not clear from our French affiliate's letter whether the cessation of broadcasting in amateur bands is permanent, or merely until September 1st, but we are inclined to believe it is the former. Officials of the R.E.F. were handling the matter with the French government almost as soon as transmissions began. The A.R.R.L. cooperated by exerting pressure through the U.S. Department of State — and of course U. S. amateurs provided plenty of QRM on 7280 kc.! The R.E.F. are to be congratulated on the success of their actions.

We also have the following word from the *Wireless Institute of Australia*:

"Although we have fought very hard here to retain full use of the 7-Mc. band, the Dept. has advised that, while they do not expect to make use of the 7200-7300-kc. band for some time, it has been necessary for them to register two frequencies, namely, 7250 and 7280 kc. at Berne. They explain that although they are very sympathetic towards us, it is necessary for them to make these two registrations now; otherwise when these matters come up for review again and if no frequencies have been registered for VK, they may find it difficult to do so then. However, it is pleasing to note that, as far as we know now, we will only lose 50 kc. I can assure you that we are doing our utmost to prevent any further encroachment upon our territory after Sept."

W.B.E. AND B.E.R.T.A. AWARDS

THE *Radio Society of Great Britain* announces it has decided to allow any licensed radio

amateur in the world to qualify for the "Worked the British Empire" (W.B.E.) certificates, and "British Empire Radio Transmission Award" (B.E.R.T.A.). We quote below the rules governing the issuance of the certificates:

W.B.E.

1. W.B.E. Certificates will be awarded by the Radio Society of Great Britain, to any fully licensed radio amateur who has satisfied the Council of that body that he or she has effected two-way communication, on amateur frequencies, with at least one British Empire amateur station located in each of the five recognized Continental areas as defined by the International Amateur Radio Union (North and South America shall count as one Continental area).

2. W.B.E. Certificates will be issued free of charge to members of the Radio Society of Great Britain.

3. In the case of non-members of the Radio Society of Great Britain, each certificate will be issued on payment of 2/6, or an equivalent amount in other currency.

4. Separate W.B.E. Certificates will be issued for:

- Two-way Telegraphy working on any band except 28 Mc.
- Two-way Telephony working on any band except 28 Mc.
- Two-way Telegraphy working on 28 Mc.
- Two-way Telephony working on 28 Mc.

5. In forwarding a claim the applicant shall give a guarantee in writing that his or her licensed power was not exceeded in effecting the contacts upon which the claim is based.

6. A minimum readability report of 3 shall be recorded on each card submitted.

7. Applications shall be forwarded by registered post to the Secretary-Editor, Radio Society of Great Britain, 53 Victoria Street, London, S. W. 1, and each such application shall be accompanied by documentary proof in the form of cards or letters showing that two-way working has taken place.

8. In the case of claims for Telephony awards the cards or letters shall show clearly that two-way telephony communication took place.

9. Contacts with British Mobile stations (excluding ships) located in the British Empire will be considered as British Empire contacts, providing the exact location of the station at the time of contact is clearly given in the evidence submitted.

10. British Mandated Territories, and Protectorates, shall be considered, for the purpose of these Awards, as forming part of the British Empire.

11. Contacts with Iraq made prior to January 1, 1936, and with Egypt made prior to August 1, 1937, shall be considered as British Empire contacts for the purpose of these awards.

12. Persons to whom W.B.E. certificates have been issued are permitted to use the letters "W.B.E. (C.H.)" on personal correspondence. The letters (C.H.) signify Certificate Holder.

B.E.R.T.A.

1. The B.E.R.T.A. will be awarded by the Radio Society of Great Britain, to any fully licensed radio amateur who has satisfied the Council of that body, that he or she has effected two-way communication, on amateur frequencies, with at least 25 of the British Dominion Districts given in Appendix I, and with at least 15 of the British Colonial areas given in Appendix II.

2. Applications shall be forwarded by registered post to the Secretary-Editor, Radio Society of Great Britain, 53 Victoria Street, London, S. W. 1, and each such application shall be accompanied by documentary proof in the form of cards or letters showing that two-way working has taken place. Evidence of two-way contacts made during the Annual B.E.R.U. Contests may be submitted, providing full details are given and that the contact or contacts were made not more than two years prior to the date of the application.

3. Rules 2, 3, 5, 6, 9, 10, 11 and 12 of the W.B.E. award also apply here, substituting "B.E.R.T.A." where "W.B.E." appears.

Appendix I

For the purposes of the British Empire Radio Transmission Award, the British Dominion Radio Districts are regarded as:

Australia: VK 2, 3, 4, 5, 6 and 7
 British Isles: G, GI, GM, GW and EI
 Canada: VE 1, 2, 3, 4 and 5

Newfoundland: VO

India: VU

New Zealand: ZL 1, 2, 3 and 4

South Africa: ZS (or ZT or ZU) 1, 2, 4, 5 and 6

To qualify for the Award, contacts must be confirmed with 25 out of the 27 Radio Districts listed above.

— . . . —

Appendix II

For the purposes of the British Empire Radio Transmission Award, the British Colonial Areas are regarded as:

<i>Africa</i>	
Anglo-Egyptian Sudan	ST
Ascension Island	ZD8
Cameroons (Brit. Man.)	ZD2
Chagos Arch.	VQ8
Gambia	ZD3
Gold Coast (Ashanti)	ZD4
Kenya	VQ4
Mauritius	VQ8
Nigeria	ZD2
Nyasaland	ZD6
Rhodesia, Northern	VQ2
Rhodesia, Southern	ZE
St. Helena	ZD7
Seychelles, incl. Amirantes	VQ9
Sierre Leone	ZD1
Somaland, British	VQ6
Southwest Africa	ZS3
Swaziland	
Tanganyika Territory	VQ3
Togoland (Brit. Man.)	ZD4
Tristan de Cunha	ZD9
Uganda	VQ5
Zanzibar, incl. Pemba	VQ1
<i>Asia</i>	
Aden, incl. Perim	
Bahrain Islands	V88
Burma	XZ
Ceylon	V87
Cyprus	ZC4
Federated Malay States	V82
Hadramaut	
Hong Kong	V86
Maldiv Islands	V89
Non-Federated Malay States	V83
Palestine	ZC6
Straits Settlements	V81
Transjordan	ZC1
<i>Europe</i>	
Gibraltar	ZB2
Malta	ZB1
<i>North America</i>	
Bahama Islands	VP7
Barbados	VP6
Bermuda Islands	VP9
Cayman Islands	VP5
Honduras, British	VP1
Jamaica	VP8
Leeward Islands	VP2
Turks and Caicos Islands	VP5
Windward Islands	VP2
<i>Oceania</i>	
British North Borneo	V84
Brunei, incl. Labuan Island	V85
Christmas Island (off Java)	ZC3
Cocos (Keeling) Island	ZC2
Cook Islands	ZK1
Ellice Island	VR1

(Continued on page 90)



HINTS AND KINKS FOR THE EXPERIMENTER

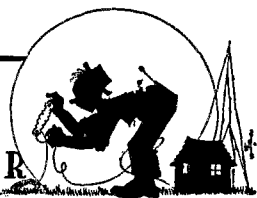

POLARITY OF SUPPLY LINE IN REGARD TO SAFETY

SEVERAL amateurs have written to us emphasizing the importance of proper polarization of the 110-volt a.c. supply line to the transmitter. The comments were directed particularly at devices which open only one side of the line such as the series short-circuiting plug described on page 43 of *QST* for April, where it is important that the device controlling the circuit be placed in the ungrounded side of the line. Otherwise, an accidental ground may serve to short-circuit the device, automatically turning on the high-voltage supply. To make certain that the switch or other device is always placed in the ungrounded side of the line, the use of polarized outlet plugs, which cannot be reversed, is suggested by many, while others provide a signal lamp connected with the series outlet as shown in Fig. 1. If the polarization is correct, the lamp will light when the short-circuiting plug is inserted but will not light if the polarization is incorrect. If the lamp does not light, the power plug should be reversed to make certain that the light has not burned out. The lamp serves as a warning light when power is on. W1KH suggests that the warning light and series outlet are obtainable as a dual unit in most

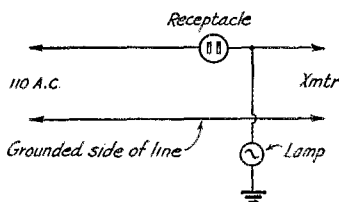

Fig. 1 — The series plug on page 43 of *QST* for April fitted with a lamp indicating when the series plug is in the ungrounded side of the line as it should be.

electrical supply houses. The ones he uses are manufactured by Pass and Seymour and are known as the Despard pattern.

Similar arrangements were suggested by VE2BT, W6LFL, R. Drain and J. H. Hawes.

SHIELD FOR EXPOSED HIGH-VOLTAGE CHASSIS TERMINALS

READ with interest your article on "Safety Technique" in March *QST*. One thing that made me think was your reference concern-

ing the danger inherent in the use of porcelain feed-through bushings as high-voltage chassis terminals.

The makers of Amphenol products have on the market a stamped metal shell which covers one of their standard plugs (Type C-CAB). This shell is

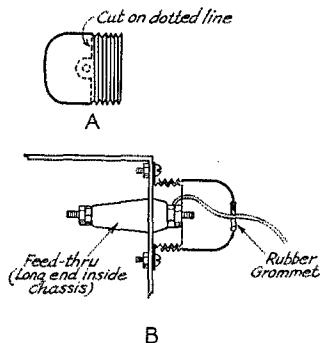

Fig. 2 — Shield for exposed high-voltage chassis terminal made from Amphenol cable-connector shell. Insulation on the wire should be adequate for the voltage employed.

threaded to fit a male shell of identical size. My idea is to cut one part of the shell as shown in Fig. 2 so that it may be fastened to the chassis over the feed-through insulator. The other section will then thread onto the first making a complete protective covering over the exposed terminal.

— George H. Goldstone, W8MGQ

NOTES ON SAFER CONSTRUCTION

Power-Supply Cable Plugs

ANYONE who has had the most casual acquaintance with power switchboards knows that there is one commandment: "Thou shalt keep all male plugs cold." We see frequent applications in multi-conductor power-supply cables where the male plugs are "live." This can be dangerous to the operator if the plug is pulled apart with the power on and can also cause damage to apparatus by accidental short-circuit when a "live" prong comes in contact with grounded metal. When power-supply and transmitter units are connected by a multi-conductor cable fitted with plug connectors, the female receptacles should be mounted on the power-

supply and on the transmitter end of the cable while the male plugs should be used on the transmitter chassis and the power-supply end of the cable.

Receiver "B" Switches

A receiver "B" switch should have good insulation and the place for it is in the positive side. Otherwise, the chassis of either the power supply or the receiver will be "hot" with the switch open, depending upon which is grounded.

Parallel Feed for Headphones

Parallel feed or output transformers should always be used in stages feeding headphones. Aside from the great advantage of safety, there are numerous other benefits which make it well worth the slight extra cost even in the most compact portable equipment. High plate currents which often damage headphones are diverted, switching between receiver or monitor is easier because one terminal is grounded, insulation is easier to carry out and two or more receivers can be connected simultaneously.

— Yardley Beers, W3AWH

VARIABLE VOLTAGE OUTPUT WITH UNIFORM REGULATION

IN EXPERIMENTAL work, it is often found desirable to vary the output voltage of a power pack without incurring the very poor voltage-regulation characteristics of a dropping resistor or voltage divider. While this can be accomplished by varying the capacity of a filter input condenser, this method is not particularly convenient and does not provide a continuous variation.

Fig. 3 shows a novel method of providing for a continuously variable output voltage with essentially uniform regulation as described in *Wireless World* by R. H. Tanner and P. H. Walker. The variable resistance in series with the filter input condenser will cause a variation in output

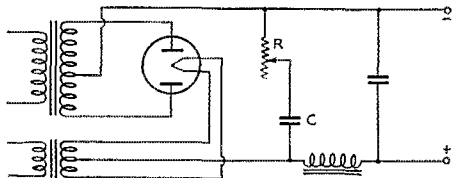

Fig. 3 — The use of a variable resistance in series with the filter input condenser provides variable output voltage with essentially uniform voltage regulation.

voltage between the extremes of the voltages obtained with condenser input as a maximum and with choke input as a minimum. This usually amounts to a change of 25 to 35 per cent with an

8- μ fd. condenser. The variable resistor should have a maximum resistance of about 2500 ohms and should be capable of carrying about 250 ma. at the lower-resistance settings. The idea is applicable chiefly to low-power applications where the supply delivers 500 volts or less.

THREE-WAY CRYSTAL SOCKET

HERE is a simple idea that may save the brothers much trouble finding out why their crystals do not oscillate only to discover that the

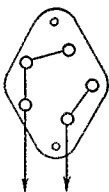

Fig. 4 — When the crystal socket is wired in this manner, correct connections will be made if the crystal is plugged in in any of the three possible ways.

crystal was plugged in the wrong way when using the regular two-point connection.

By wiring the conventional five-prong socket as shown in Fig. 4, the crystal will be connected in circuit regardless of the way in which the crystal is plugged into the socket.

— R. H. Fowler, W1ACV

STILL MORE ON NEON-BULB REGULATED POWER SUPPLIES

FROM time to time I have seen suggestions published in *QST* for improving the operation of the voltage regulator described in *The Radio Amateur's Handbook*. I have a suggestion for improving the operation of this type of regulator.

I live in an apartment which is about 30 feet above ground and, as a result, it is practically impossible for me to obtain a worth-while ground on my equipment. The transmitter is powered at 600 watts and, unless the antenna coupling is perfectly balanced, everything in the shack is "hot" with stray r.f. I discovered that when this stray r.f. was present, the voltage regulator would work very erratically. The regulation was found to be worse with the regulator than without it. The trouble proved to be caused by r.f. blocking the grid of the regulator tube. I found it necessary to shield the regulator tube, its grid lead, the neon bulb and to by-pass the neon bulb and the regulator grid lead to ground with small mica condensers. A capacity of about 500 μ fd. proved to be the best capacity since it did not alter the operation of the regulator and served to put the r.f. in the right place. With these few alterations, the regulator works perfectly, even though a neon bulb will light up brightly when touched to the chassis of the power supply when the transmitter is operating at certain frequencies.

— Owen J. Ford, W6KKG

CONVERTING THE SKY-CHAMPION RECEIVER FOR S.S. SELECTIVITY

CONVERTING the Hallicrafters Sky Champion for single-signal selectivity is a simple job and one which well repays the amateur who has one for the work involved. Intermediate-frequency regeneration is obtained by means of the introduction of a small capacity between the grid and plate of the 6K7 i.f. tube.

Electrically all that is required is to connect a short length of insulated wire to the grid cap of the 6K7 i.f. tube, pushing the other end a short distance through a hole in the top of the i.f. out-

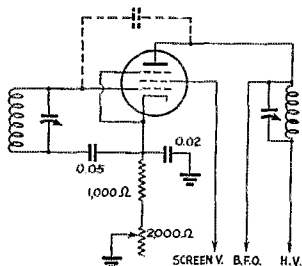

Fig. 5—Altered i.f. circuit of Sky-Champion for single-signal selectivity.

put-coil can and to insert a variable resistance between the cathode resistor of the same tube and ground, eliminating the connection between the cathode resistor and the r.f. gain control. Fig. 5 shows the circuit after alteration.

The variable resistor used here is one of 2000 ohms, midget size. It was found that changing the 300-ohm cathode resistor to one of 1000 ohms provided better control with the size variable resistance used, although the value is not critical. The variable resistor is mounted on the bottom of the chassis, near the front, between and below the b.f.o. switch and the tone-control switch so that its shaft protrudes through the bottom of the cabinet. An old bakelite variable-resistor case was trimmed down to make a thin dial which could be mounted under the cabinet with one edge just protruding from under the cabinet sufficiently to make it possible to handle easily from the front. Any other thin dial or knob might be used. It was necessary to place spacers between the cabinet and the mounting feet to raise the cabinet high enough to permit the placement of the control knob. In order to permit the removal of the regeneration connection between the grid and plate of the 6K7, a thin piece of wood was fastened to the wire from grid to can and left protruding through the ventilating openings in the rear of the cabinet. A small hole was drilled in one end of the

wood stick and the wire pushed through the hole. The end of the wire was then pushed into the hole in the transformer can and adjusted for proper feed-back, while the stick was adjusted so that its end rested on the can. The wire was then fastened to the stick with a drop of Duco cement. Thus, the regeneration connection can be made or disconnected from the rear without opening the cabinet.

After regeneration is obtained and the amount of feed-back adjusted so that control is smooth, it may be necessary to adjust the b.f.o. slightly. This is done with the i.f. tube oscillating and the b.f.o. operating. Merely tune the b.f.o. for the pitch of signal desired. For single-signal operation, the i.f. tube should not be oscillating but the control should be set just below the point of oscillation. Further backing off of the regeneration control decreases selectivity to make reasonably good 'phone reception possible.

— H. C. Yingling, WSRGI

ANOTHER INEXPENSIVE SEAL FOR COAXIAL CABLES

AN ITEM of interest to readers of *Hints and Kinks* may be a very satisfactory end seal for a $\frac{3}{8}$ -inch coaxial transmission line, shown in Fig. 6, which can be very simply made for about 24 cents. Purchase a $\frac{3}{8}$ -inch tube-to-tube compression connector for 15 cents, and a Meissner pillar insulator No. 27-1015 for 9 cents. This insulator is 2 inches long, $\frac{3}{8}$ -inch outside diameter and has a hole all the way through the center. It fits perfectly into the compression ring of the connector and, when the cap is screwed on, is clamped very solidly. The other end of the connector clamps the $\frac{3}{8}$ -inch tubing after the Cardwell beaded center conductor has been pulled through the compression connector and the insulator. It will be necessary, of course, to fill in around the wire with Glyptal or Duco cement after which a spot of solder will serve to anchor the No. 12 wire at the end of the insulator. No. 12 wire can be threaded with a die so that a 2-56 nut can be pulled down against the end of the insulator.

If some ceramic manufacturer made a $\frac{3}{8}$ -inch outside-diameter ceramic tube with a hole all the way through, threaded at one end for a 10-32 screw, this would make an ideal job.

— R. L. Morehouse, W2QA

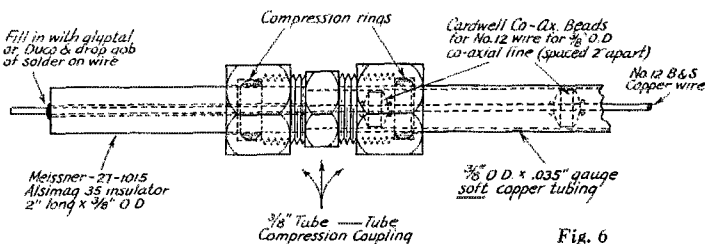

Fig. 6



CORRESPONDENCE FROM MEMBERS

The Publishers of *QST* assume no responsibility for statements made herein by correspondents.

7200-7300 B.C.

2119 Longwood Ave., Los Angeles, Calif.
Editor, *QST*:

Your editorial in April *QST* should be sufficient to shake us from our mental lethargy. If we don't do something about it pretty quick, there won't be any 40-meter band after the Rome convention.

Don't you remember — two or three years ago the League strongly urged that the boys "on forty" spread out and *occupy* the high-frequency part of our most valuable band. But they didn't. So at Cairo the European delegation simply "muscle-in" and took 7200 to 7300 kilocycles for themselves.

Now high-power broadcasting stations are blooming like flowers in the spring. Before long the band will be loaded with them.

So let's fight fire with some of our own. If 7200 to 7300 is to be a broadcast 'phone band, then let's ask the F.C.C. to designate this strip of territory for *amateur 'phone* as well?

Of course the writer expects to hear wails and cries from some of the c.w. men. But let's not be narrow about this. I've never before advocated "phone on forty," but it now looks like the only way to save the band. Some of the 40-meter DX boys may also be glad to see what "40-'phone" will do.

Also, perhaps the 40-meter 'phone men in "the other Americas" could be induced to operate in this territory, much to the approval of all c.w. men.

Let's not forget what the 160-meter 'phone men did. They *occupied* this band which had become dormant for men with keys. Had they not done so, you may be sure this band would now be full of commercials and gone from the amateur realm forever.

Maybe some of those young squirts were a bunch of lids who couldn't read code enough to keep pace with the traffic boys. But they saved the band — and the 'phone men can do the same for forty!

— Jay C. Boyd, W6PRM

2830 W. Wishart St., Philadelphia, Pa.
Editor, *QST*:

. . . The evening of February 15th stands out in my mind. We had some friends here at home and our BCL set was tuned to the French station on 11.72 Mc. He made an announcement that they were going to start broadcasting on 7280 kc. At the time it meant nothing, but two nights

later I turned on my own superhet and here was this strong signal, speaking English. My first thought was, "What's this — an image?" I have 1500-kc. i.f. stages and did not think it could be, but with a separate electron-coupled oscillator I have here I soon proved it was on 7280 kc. It then dawned on me — the announcement I had heard the previous two days. I sat down the next day and wrote them a letter. I was furious. Who would not be? . . .

— Albert Segen, W3BGD

Knox, Ind.

Editor, *QST*:

. . . Last night between the South American and Mexican 'phones and the two foreign broadcast stations, that was all there was to be heard. The Paris station operating on 7280 kc. was drowning out every station trying to use that frequency and slightly lower was another broadcast station of unknown identity that was causing almost as much trouble. Between the times of 10 and 10:30 P.M. there wasn't a single amateur code station to be heard in the upper 100 kc. of that band. . . .

— Jack C. Andrews, W9YWE

1802 79th St., Brooklyn, N. Y.

Editor, *QST*:

As I am writing this letter I have my cans on, listening to some European broadcast station on 7280 kc. It sure gripes me and what makes it worse nothing is done about it. Protests are of no use, it seems, so why don't you follow that editorial of August 1938 about blasting them off the air? Evidently that was just so much hooey because I listen or work on the high side of 7 Mc. and I'll be darned if I heard a single high-power amateur attempting to QRM those BC stations. The A.R.R.L. is sure going sour and it sure gripes a lot of us hams to see it run the way it is. I would like you to quit writing flowery editorials and put W1AW on top of those BC stations and get some O.R.S. on them, too. . . .

— Fred Hunley, W2JVK

605 West St., Wausau, Wis.

Editor, *QST*:

Nice goin' fella on that April "It Seems to Us" stuff. Now all we have to do to snow under those Martian hi-jackers is to round up all our CQ

(Continued on page 74)



OPERATING NEWS

F. E. HANDY, W1BDI, Communications Mgr.

E. L. BATTEY, W1UE, Asst. Communications Mgr.

Wanted: Better e.c.o.'s and better amateurs. We couple the two needs together, since the operating with a defective note, in many cases shows ability or good intentions or both lacking in the amateur operator behind that defective signal. So perhaps we need better amateurs *first*, as a means to getting better signals. W7GZN writes, "It is possible to get near-crystal notes from an e.c.o. If a high-frequency oscillator in a receiver can be d.c. and very stable, it can also be done for transmitter control. We need the quick frequency change technique, but how about a campaign for the better notes that are easily possible? Let's do something about this e.c.o. business." Let's!

Dozens of comments still arrive protesting selfish operating practice with e.c.o.'s. We hope they will drop off after the DX contest reports stop coming in. To complainants we say, "Don't tell us . . . tell the men that give you cause for complaint . . . and don't delay . . . use plain terms . . . and explain the particular respect in which improvement is needed, too, please." As we pointed out several months ago, your very real control over these improper and unsporting practices is to promptly give the operator at fault your frank unvarnished opinion of him for a poor note or selfish practice while the matter is current, explaining that to earn general high regard these matters must be promptly corrected.

As for the "campaign" that W7GZN calls for, it isn't necessary for us to conduct it. Sources close to the Federal Communications Commission disclose that an unusual number of green tickets (for bum notes) were issued in the last few months — and these citations *will be continued* in enforcement of the regulations. So the campaign is on. Let us also say that as long as we have good receivers there is no excuse for needing to be told. It is a good turn that is being done us when somebody tells us frankly what a poor signal we've got, though . . . many hams don't want to take the time.

If you know anyone who is "going e.c.o." please suggest to them, close study of the principles laid down on page 66 of April 1939 *QST*.

Tone reports discredited: Does someone ask how to answer green tickets? I'm afraid we cannot give you much help or encouragement! The best thing is to behave so as not to get them. They *have* been answered by telling how many pages of T9 reports are indicated in one's log

"just previous" to the defective transmission. There's always a technical reason, no doubt, but this is old-stuff in "excuses," and must give some of the F.C.C. officials a smile to think that an amateur can be that naive. The page of tone reports is really data on which little or no reliance at all should be placed, since these contain both personal error and at least a degree of flattery, as a rule. We're sorry to have to say this, but new amateurs have a right to know that, a large part of the time, tone reports are just part of a white lie, which is in turn part of the amateur formula for saying, "I'm so very pleased to meet ya" — "you look great to me." The chap looking for flowers started to spoil the honest tone reports years ago by expressing dissatisfaction or disbelief at anything less than ultimate. It is a matter of inertia and laziness in carefully examining a signal, combined with the human desire to flatter if necessary to avoid argument, that leads to dishonesty in reports. There is no intentional malice or desire to cut down on the value of the contact, although this invariably occurs. There are exceptions, of course, and some few fellows who give honest reports, as well as the seasoned operators who skip all reports unless called for! More power to those who follow exact standards of honesty in using the clear and useful R-S-T scales, and consulting the exact definitions as they give reports, so these do retain values in these instances of use. However, this is to caution to-day's amateur operator by putting him wise to the social custom. It is unsafe to put too great reliance in the average off-hand signal reports one receives.

A.R.R.L. Field Day Beckons Again. Until a sequence of F.D.'s demonstrated beyond any doubt what real operating with less than 20 watts could accomplish in a Field Day, higher power was thought a necessity. It must be inspiring to the uninitiated to get on for the first time in a F.D. and to hear the excellent signals from hundreds of installations, both far and near, using less than 20 watts in so many cases. The Field Day combines the idea of an outing with the testing of portable and self-powered apparatus. Operating and installation experience are important factors. That a high degree of skill has been developed is indicated to any listener who tunes the bands and evaluates what he hears in the course of a Field Day. Field Day time is here again. June 17th and 18th are the days. A warm

invitation is extended to all . . . even though so many have stated they merely await the hour that we are assured participation will be well nigh universal.

The Field Day touches upon our ability to render public service more directly than any other A.R.R.L. activity. It is aimed at that vital need of the amateur service to have insofar as possible in every amateur shack, a practical, inexpensive, emergency-powered transmitter, ready to go to hop over any barrier presented by curtailment of commercial wire facilities.

We like to imagine that there is no amateur who cannot put together a simple rig, from junk parts, that will function for emergency need. Better to build it now (for the F.D.) and be prepared, than to miss the fun and fellowship of the outing and be caught later unprepared, too! Many clubs have encouraged competitions for building simple personal self-powered transmitters. We hope these may continue successful.

This is not to deprecate the use of gasoline-driven, self-powered rigs for higher power. These are admirable wherever one can afford them, and we have such units at W1AW expressly for emergency. But this is to remark that to capitalize our geographical coverage (our strong point) we need to encourage the more universal availability of self-powered equipments. To mention the New England hurricane, for one example, many more cities might have been served and represented on the air by amateur stations in the days before commercial lines were restored, if the simplest equipment had been provided and used in more ham shacks. To double and treble the number of gas-driven equipments is desirable (always we want the most power we can get, of course). To approach a condition where every one of us licensed has a cheap, reliable, low-power crystal transmitter, with either batteries, vibrapack or genemotor for any need will be even nearer to utopia for the *fraternity*. The real service of radio is that that occurs before wires are back in service — getting word into a secondary area from which normal communication exists . . . and the 20-watter is more than good for that job. In fact, one 10-watter on the job, in the needed spot, is worth a hundred gas-powered rigs that due to weight, or cost or something, are somewhere else. General availability of some inexpensive gear is more valuable to our country and reputation than partial availability of the ultimate in equipment. *Have you got your self-powered equipment ready in your station?*

More than any other contest, the F.D. is designed to bring out the best in operators, in fraternalism. Preparedness of the operator, as well as the station, is the aim. Setting up and testing equipment in new surroundings, like relay traffic work, calls for skill, cooperation, and collaboration to the utmost. Planning and working with fellow amateurs in organized groups for Field

Days, instead of as isolated individuals, is as it should be for most profit and fun to all concerned. If you are not lucky enough to belong to an affiliated club, then get together with two or three ham friends and plan your "expedition" for the Field Day.

A.R.R.L.'s Field Day has come to be one of the major activities of the whole year. See the announcement elsewhere in this issue for the detailed rules. Here's luck and CU in the FD — 1939.

— F. E. H.

PRIZES FOR BEST ARTICLE

The article by Mr. R. L. Paige, W9NST* wins the C.D. article contest prize this month. Each month we print the most interesting and valuable article received marked "for the C.D. contest." Contributions may be on any phase of amateur operating or communication activity (DX, 'phone, traffic, rag-chewing, clubs, fraternalism, etc.) which adds constructively to amateur organization work. Prize winners may select a 1938 bound *Handbook*, *QST*, Binder and League Emblem, six logs, eight pads radiogram blanks, DX Map and three pads or any other combination of A.R.R.L. supplies of equivalent value. Try your luck. Send your contribution to-day!

Stop Thief

BY R. L. PAIGE, W9NST*

Lives there a ham with soul so dead,
Who never to himself has read,
The Golden Rule so all revealin',
'Twas penned to stop this awful stealin'.

ADMITTEDLY the pursuit of Ham radio is a hobby and I have unfortunately been led to believe that as such it is well utilized as a safety valve in the catch-as-catch-can struggle of the average man for existence, to prevent a lot of us from enjoying the confines of the rooms with padded walls.

Some years back the stage of our so-called hobby was reached where pieces of quartz were marketed in sufficient quantities to enable even the lowliest of our brethren to purchase same to control the frequency of their transmissions. This was heralded as a distinct advance over the more primeval method of letting your oscillator excite itself, sometimes with dire consequences. It is safe to say that since then literally thousands of these magic rocks have been purchased by hams all over the world. I myself woefully look now at my collection of eight carefully selected and highly prized frequency controllers and wonder why I was misled by the F.C.C. and the A.R.R.L. to say nothing of my sense of pride in the signal emitted by my station. For alas these crystals are almost worthless.

It is the DX contest period 1939 A.D. and I am just getting ready to enjoy the fruits of my new gear. Blissfully I call the first station heard. When I go back to listen I hear a veritable rats nest of signals, some calling the station I just called, others signing, and new ones arriving every minute. Some are getting there all of a sudden and obviously are switching to another crystal, others are coming on down the band with their notes getting worse as they get their e.c.o.'s farther removed from the place the rest of their transmitter

* 264 Ridgeland Avenue, Elmhurst, Ill.

is tuned to. Surely this is a nightmare. But it continues to happen, with the result that nobody can hear the DX station due to QRM right on his frequency from the fellows without receivers who apparently just continue to call him with the idea of getting a heard card from some S.W.L. in Bangkok. The noise finally subsides for a minute and the foreigner comes on calling someone he fished out of the mess. When he finishes about ten stations all go back to him saying OK, and sending contest numbers. Some signals sound like the quack of an anemic duck, while others take on the bold characteristics of a badly synchronized rotary gap.

The F.C.C. could be busy for a week making out the dreaded green tickets for most of the stations in this one orgy. When I hear this same thing being repeated at many spots on the band I wonder whether all regulations have suddenly been removed. I, who labor under the impression that they have just recently been more strictly drawn, am at a loss to understand this apparent disregard for our privilege of transmitting.

Finally I raise some fellow who takes the time to tune his receiver and after getting my number I go back to give him his. My transmission finished I listen for his reply and to my dismay he comes back to another station. I quickly look over the spot on my receiver where I had been transmitting and sure enough a minor riot is forming and the big parade is on again. This is another phase of the e.c.o. racket. Surely we should have a suitable diploma for the guy who can "steel" the most countries. Or perhaps we could put a bounty on the most rare of our foreign brethren so that the great body of W hams who, by their unfair tactics and racketeering practices, are fast joining the ranks of the untouchables, can really continue this art until they have completely eradicated all DX contacts from our bands. If I continue Ham radio I believe we should slip still farther to the rear and use spark transmitters, which would obviate the necessity of swishing an e.c.o. around, by covering the whole band at once!

Part of the solution to our problem, and I am sure thousands will agree that it is a problem, lies with our foreign brethren. If they would start to turn the dials on their receiver and refuse to work the inhabitants of these easily formed rat's nests on our bands we would be on our way to cleaner and better conditions on the air.

BRIEFS

A message on a 'phone net was apparently gaining momentum as it passed along — at first it was about a simulated emergency, then when it popped up again it was about a "stimulated" emergency. It's a pretty sick emergency that has to be *stimulated!*

W3ELN, a Marine at Quantico, Va., worked K6QDI, a Soldier, and K6NSD, a Sailor, Easter morning, April 9th.

The Rapid City (South Dakota) Radio Club found a downtown window display an effective method of dramatizing amateur radio's emergency work to the lay public. The club set up its emergency transmitter and receiver before a large map of the United States, with colored ribbons running from the key to each state contacted by the rig in the last field day. Printed cards in the window explained the set-up. The emergency battery bank, message blanks, handbooks, call book, QST's, QSL's, emergency tool kit and tubes were all on exhibition.

For some years W9ZCC, Brookings, So. Dakota, manager of A.R.R.L. Trunk Line "H," has had the job of observing the annual migration of ducks and geese. This year T.L. "H" and the South Dakota State Net helped keep tab for him, the first tip coming from W9BCX, Mound City, Mo. The Winnipeg Free Press featured the news, receiving its information from ZCC the day the vanguard of the flight reached Brookings.

Attention, Illinois Amateurs

Illinois radio clubs have a movement under way to attempt to get Illinois amateurs' call letters on automobile

license plates, similar to Michigan and Ohio. A petition, with as many signatures as possible of licensed amateurs, is a vital part of the plan. All Illinois amateurs interested in the matter are requested to immediately mail a postal card with the following wording, to W. L. Holst, W9MD, Vice-Chairman, Chicago Area Radio Club Council:

"Mr. Edward J. Hughes, Secretary of State: The undersigned licensed Radio Amateur operator respectfully asks that you consider our request for automobile license plates with our Government call letters, the same as now done in Michigan and Ohio, instead of the usual numbers now issued, as a means of identification of our hobby, which has been of very great value in saving life and property during past national emergencies." Be sure to sign your full name, call letters, complete address and date. Mail to W9MD without delay.

Operators Needed at Soaring Meet, Elmira, N. Y.

The Elmira Amateur Radio Association will sponsor communications for the Tenth Annual National Soaring Contest of the Soaring Society of America, to be held at Elmira, N. Y., June 19th through July 9th. Due to the long period of the meet and the extensive communications plans quite a staff of operators will be needed to man the various posts. The E.A.R.A. advises that several out-of-town operators are needed, the services of at least four additional men being definitely called for. Any amateur in a position to volunteer for this work would find the experience very much worth while and enjoyable. Sleeping accommodations will, of course, be provided for out-of-town operators. It is expected that a separate cabin will be made available for amateurs (aside from the official contest communication posts), to house participating operators and in which a station will be set up for general ham contacts. Here is a chance for a real "ham vacation." Drop a line at once to either of the following, if you can join the Elmira gang for the Soaring Meet: Mr. Hal Lawrence, Secy, Elmira A.R.A., 1302 Pratt St., Elmira, N. Y.; Mr. Elliott Hood, Care of Association of Commerce, Elmira, N. Y.

W2APT/9

W2APT will operate portable at the National Radio Parts Trade Show, Stevens Hotel, Chicago, June 14th-17th. The 17th will be "amateurs day." It is planned to handle traffic from show visitors and all amateurs are invited to participate in the operation of W2APT/9. In fact, volunteer operators are urgently needed. Gene Turney (W2APT) cautions all operators to be sure to bring their tickets. Operation will be on both 'phone and c.w.

W9DKB, operating 1863-kc. 'phone at Jetmore, Kansas, was heard in Hawaii by C. J. Fern, Jr., Kauai, on March 13th, 10:52 p.m. CST. Signals were reported R5S7. DKB was running 940 watts.

British 56-Mc. Tests

In July, David S. Mitchell and M. C. Crowley-Milling (partners of GW6AA) are spending 5 days with a 56-Mc. station on the summit of Snowdon, 3,560 feet above sea level. A petrol driven alternator power supply makes it possible for them to run a medium power c.c. transmitter. GW6AA would like to make schedules with any really serious DX station. C.W. will be used for all long-distance attempts, with a sensitive acorn tube superhet for reception. These tests take place from July 5th to 9th. July 9th is the date of the Radio Society of Great Britain's 56-Mc. National Field Day.

G5ZT is also interested in arranging 56-Mc. schedules with U. S. A. stations. He is operating daily on 14 and 28 Mc. and suggests that W stations first contact him on one of these bands, then proceed with 56-Mc. tests, listening for him on 56,020 kc. and continuing transmissions on 14 or 28 Mc. as the case may be for fifteen minutes. If G5ZT is unheard, he

will then listen for the W on 56 Mc. for a similar period, with two-way contact the ultimate goal.

The Providence (R. I.) Radio Association is cooperating with the Woonasquatucket Valley Firemen's League in a plan to use amateur radio to aid in directing firemen fighting forest fires in that district. In tests the plan has worked admirably. Fifty volunteer firemen with four pieces of apparatus were directed to a scene within half an hour after an alarm. Four mobile radio units aboard fire trucks were set up to maintain contact with the control room, located in the home of Lewis J. Boss, North Scituate. Among the amateurs cooperating are W1LDL, W1JXQ, W1KZN, W1GTN and W1JEZ.

Operating Pointers

FOR C.W. OPERATORS:

1. Listen on your frequency before you call or CQ. If your frequency is badly jammed, then your call is nothing but a waste of power. Wait until it clears up.
2. Stop the practise of sending faster than the other fellow can copy. Set your speed according to speed he uses when he either answers or calls.
3. Don't give another operator R5 unless you can copy him solid and his readability is 100 per cent. Give him his exact report, that is what he *wants*.
4. If the other fellow is sending too fast, ask him to slow down. Believe it or not, the majority of hams are real fellows and will slow down. If he doesn't then tell him 73 and look around for someone else. Slowing speed down to conditions is the mark of the GOOD operator.
5. When you get that new bug (applies to old bugs as well) adjust it so the dots will not be faster than on a straight key. Then, and only then, will a bug be of top value.
6. Don't repeat anything unless the other fellow is having trouble and asks for double sending. It is much better to space correctly or even double.

FOR 'PHONE OPERATORS:

1. Listen a few minutes on your own frequency and see whether or not you are going to get through. If you are jammed, then you are only causing further confusion. Why break up another fellow's QSO, and waste your power and time in addition?
2. Aim to increase your operating enjoyment by thoughtful, cooperative means, rather than by constantly increasing power in order to "blast through." Interference will always be with us and will never improve by the use of "brute force" methods. Make your transmissions to the point. Avoid repetitions. Consider the other fellow.
3. Keep your carrier clean, don't overmodulate. Give the boys a break with the use of a dummy, when making adjustments.
4. Don't call DX unless you can hear DX.
5. Be the same gentlemen to the man after you have worked him, that you try to be when you are working him.
6. Discontinue the use of verbal Q signals and signs. Build up respect for our hobby, instead of tearing it down by thoughtless operating. (The writer has heard many a Diddle De Dit-Dit Dit, but such practise does not incite respect.) Remember B.C.L.'s listen to the h.f. bands and they are likely to think hams are just a bunch of saps. If you have nothing more to say, sign off and let the other fellow talk a bit.

— Allan R. Muncey, W3ADI

Emergency Unit — Helix Amateur Radio Club

This trailer contains the complete, self-powered (gas engine) emergency station of the Helix Amateur Radio Club (San Diego County, Calif.). The 75-watt transmitter is designed for operation on five amateur bands, 1.75 through 28 Mc. The unit is kept in readiness at all times for emergency use, and is given practical work-outs by club members on outings, Field Days, etc. It will be on the job during A.R.R.L.'s '39 Field Day, June 17th-18th.

Brass Pounders' League

(March 16th-April 15th)

Call	Orig.	Del.	Rel.	Extra Del. Credit	Total
W4PL	16	49	1818	35	1918
W7EBQ	0	0	1616	0	1616
W6FWJ	352	603	150	458	1568
W5PDR	596	134	642	121	1493
W9QIL	37	118	342	106	1153
W5FBE	5	15	950	14	984
W6IOX	30	34	864	33	961
W1FSV	63	124	682	37	906
W9ZDZ*	1	7	885	5	898
W3CIZ	11	42	639	42	734
W8JTT	10	32	668	21	731
W1NTU	52	44	626	0	722
W9NFI	15	60	592	40	707
W6LUJ	53	303	30	300	686
W3BWT	30	58	534	45	667
W4IR	8	59	600	29	656
W5CEZ	27	101	502	25	655
W6DIR	39	137	319	123	618
W9ZDZ	7	7	586	3	603
W9OUD	18	14	557	10	599
W6LMD	7	11	524	8	550
W4BAQ	13	51	432	50	546
W5EOE	11	135	380	14	540
VE9SF	11	11	500	10	532
W5BAQ	176	41	156	156	529
W8DNX	5	38	444	38	525
W5BN	216	87	110	110	523
W2GVZ	60	170	116	166	512
W6LLW	20	49	426	10	505

MORE-THAN-ONE-OPERATOR STATIONS

Call	Orig.	Del.	Rel.	Extra Del. Credit	Total
W5OW	173	227	1248	119	1770
K4IHR	791	476	448	0	1715
W9BNT	22	112	440	30	604
W2HWI	21	21	456	19	517

*These stations "make" the B.P.L. with total of 500 or over. One hundred deliveries+Ex. Del. Credits also rate B.P.L. standing. The following one-operator stations make the B.P.L. on deliveries. Deliveries count.

W2JHB, 279	W5FOM, 128	W5DKR, 102
W2KI, 176	W5EY, 119	VE3EE, 102
W3UW, 174	W9VS, 119	W5GUK, 101
W9ESA*, 173	W3EDC, 115	W2LR, 100
W9ZGS, 172	W2JZX, 113	W8QGD, 100
W7APS, 156	W4AOB, 108	More-than-one-opr.
W9EDQ, 141	W6MQM, 108	W1AW, 203
W1KH, 132	W3ZFC, 106	W9NLG, 194
W1JCK, 130	W3GKO, 103	

A.A.R.S.

Call	Orig.	Del.	Rel.	Extra Del. Credit	Total
WLMA (W8YA)	21	8	580	0	609
WLHI (W8UW)	0	0	502	0	502
WLNB (W2DBQ)*	made the B.P.L. on 182 deliveries.				

MORE-THAN-ONE-OPERATOR STATIONS

Call	Orig.	Del.	Rel.	Extra Del. Credit	Total
WLM (W3CXL)	149	165	3634	103	4051

A total of 500 or more or 100 deliveries Ex. D. Cr. will put you in line for a place in the B.P.L.

* February-March.

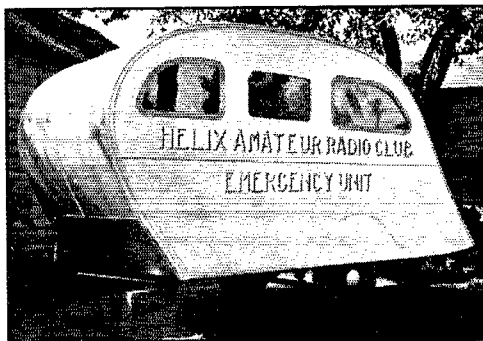



How's DX?



HOW:

A FEW months back, mention was made that some of the DXCC guys were going to be dropped because they had been caught altering cards submitted in evidence. Apparently this little item caused some of the lads to check up immediately on the list to see if they were the ones left off, or to see if they could find who the rodents were. When they finally determined that no one had been dropped, they wrote in and accused us of running a bluff. No bluff, my hearties — it just takes a little time to check on some of these things. You'll find a few missing right now. Go ahead and check up; we'll wait for you.

You found them, did you? Well, we could have saved you the trouble by naming them outright, but we've decided never to mention them again on this page. We don't go much for fellows that attach so much importance to their relative standing on the DXCC list that they cheat to beat out their fellow hams. In the immortal words of that sage of radio, WIQV: "After all, it's only a hobby."

Speaking of hobbies, and at the same time trying to get that bad taste out of your mouth, we'd like to tell you about PZ1AB. He's an ardent amateur if there ever was one, but he's pretty much on the spot down in PZ because ham radio is forbidden. He has to be mighty careful to escape detection and, to top it all, he's limited in the power that he can draw from the line because, for some reason or other, the power company limits him to 120 watts. His receiver draws about 100, so PZ1AB is always going to be rather low-powered. Anyhow, what we're driving at is that 1AB has a plenty tough time getting parts down there, and W4CCH has offered to build him a transmitter. A number of the fellows in Tarboro are donating small parts for the rig, and it would be a nice gesture if some of youse guys with spare parts kicking around sent them to W4CCH for use in the rig. Or you might tell CCH what you have and ask what he can use.

Oh, yes. When you work PZ1AB, on 7197 or 14,394 kc., don't send your card any place but here, for undercover forwarding. And don't get so anxious for a reply, like a certain C-Clubber did, that you send a radiogram to the PZ asking for a card. It's a swell way to tip off the government — they run the radio system!

WHERE:

W3PC pulled a honey out of the hat during the Contest: VQ6SS (14,300) on Socotra. No, gentle scoffers, he weren't no phoney — Clem has a card Hope



Gene Goss, XU8NR (left) and Harry Brown, XU8HB, and their rig at Shanghai, China. The rig on the right is a pair of HF100's running at 330 watts and modulated by a pair of ZB120's. The c.w. rig is in the corner behind the receiver and operating table, and ends up with a pair of 203A's running at 300-500 watts input. A "Sky Champion" receiver completes the station equipment.

A flat-top beam, aimed at W6, is used on 'phone, and a Zepp-fed Hertz is used for c.w.

is fading rapidly on ZM1AA. Both W5VV and W6KQK did a bit of up-checking, and found that, although ZM1AA had been on Samoa at the time he worked some of the boys, he can't be located, for QSL-digging purposes, at this time. The true owner of the call has never been on the air HSICK was a phoney A lot of the boys have been working KD6QH (14,385 T9) for Midway. Other stations there are 6MV and 6QSL W6BIP reports KF6PUL (28,550) on Baker coming through about 5 p.m. PST. . . . A new one on Papua is VK4BF (14,390), according to VK4RC W9TJ worked J8PG (14,250 T8) and J2JJ tells us about J8PX (14,370 T7), both in Kantoshu Territory. Around 1400 GT should be the best time J2JJ has a couple more that look good: ZC4X (14,405 T8) in Cyprus, QSL via R.S.G.B., and VR1AP (14,375 T9) W2GMY and cohorts scared up ZD7Z (14,415 T9) and are keeping their fingers crossed The address of HI2AC is Carlos Gomez y Garcia, 22 Calle Grande, Ciudad Trujillo, Dominican Republic W9TB gives the QTH of CR4MM (14,415 T7) as Mario Moutinho, Praia, Cape Verde Island VOIDL and VOIDD are phoney, according to VOIK, the QSL Manager up there That FM8AC that was on during the Contest was in Martinique but unlicensed, according to the card W3FRY received EK1AF (14,040 'phone) is Jose M. Sierra, British P. O. Box 50, Tangier (Z. L.) Africa, ex-CN1AF W5AVF heard a nice one, if OK: VR1MS (14,020 T8) When LZ1TD (14,410 and 14,280 T7) gets on, he can't work W's fast enough to please the W's. The W's, in their mad scramble, don't help much. QSL only via A.R.R.L. or HB9CE OX7MI, worked by W1JEA and a flock of others, says to QSL via A.R.R.L. That's peachy — only we don't have his address, and don't expect it to be in Greenland VU7BR (14,345 T9) is a good bet from 21-23 GT. He's at Bahrain, you know W9WCE got a new VK9: 9RM (14,270 T9), and K6OCL (14,260 T9) in Guam W1TS heard PK6XX (14,000 T9) having a go on c.w. one morning, for a change We'd like to hold out some hope on ZA2X (14,395 T7), worked by W2CHK, but legitimate ZA's are scarcer than DX men who tear up their cards when they get to 99 countries confirmed.

WHEN:

AT THIS point about the only DX on 3.5 Mc. is LU1EP (3505). W1TS worked him at 2 a.m. during the ORS Party, and W8OFN worked him on April 10th, moving up from 20 after a sked had been made. OFN also worked him on 40 and 10, to complete a 12-hour four-band.

On 40, W6PBV reports J2PJ (7065), HK2BL (7065), VP4TO (7165), KA1HQ (7130) and CM2RV (7100) W3ATR finds what little DX there is on 40 best around 6 or 11 p.m. It includes G's, CT1AZ (7255), OZ3G (7290), HB9DI (7300) and ON4GU (7210).

On 20, things haven't been any too hot since the Contest, although there's still plenty of stuff to fill up on. W9CDT got VQ3HJP (14,405), VP5AD (14,490), UK3AH (14,430), VP6MY (14,265) and VP4TR (14,410 T5) W1AFG says ST6KR (14,320) comes through well about 4 p.m. W8OUK kicks through with VQ4RHL (14,340

(Continued on page 60)

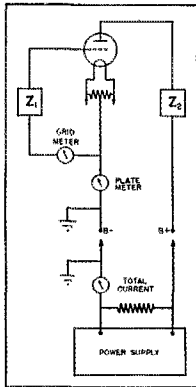

IN MARCH *QST*, George Grammer points out that all parts on the front panel of a transmitter should be at ground potential for safety — and adds (quite truthfully) that the rule is commonly disregarded. This applies to meters particularly. Even bakelite-cased meters are not safe for high voltages, and plugs and jacks are even more dangerous when used for meter switching in high voltage leads.

On this page is a basic circuit showing how meters can be kept at ground potential in transmitters. For simplicity, the plate circuit is represented by a block marked Z_2 , which might be a tuned circuit, a modulation transformer primary, or what have you. Similarly, the grid circuit is represented by Z_1 . Note that the plate meter reads only plate current (not plate and grid current), even though it is in the cathode circuit. This arrangement works even though more than one stage operates from a common power supply.

Also, it works equally well with the plug and jack system, of course. However, this brings up another point. Most jacks open the circuit momentarily while this plug is being inserted or withdrawn, and this is likely to cause trouble. For instance, stopping the exciter won't do the tubes in the final any good, even if it is for only a moment. Furthermore, in the circuit given above improper action of the plate current jack will cause most of the circuit to rise to $B+$ potential, including the grid current jack. These troubles can be avoided by wiring small shunts permanently in the circuit in place of the usual jacks, and connecting plain open circuit jacks across their terminals. In this case a millivoltmeter is used instead of a milliammeter for reading. In addition to keeping the circuit closed at all times this system has the great advantage of providing a wide choice of current ranges, depending on the shunt used. Since the shunts are always in the circuit, the proper range is selected automatically. Shunts are inexpensive, and are available from most dealers in ranges from 5 MA to 1000 MA.

This scheme is not new. In fact we described it on this page over four years ago. However, even if it is old, it is still a good idea. The National NTX-30 uses it successfully with slight modification.

We have to confess that George Grammer's crack about the rule being disregarded applies to us along with everyone else. Our 600-watt transmitter has meters in the high side of the power supply, and worse still it uses plugs and jacks. To be sure, the jacks are mounted in a guarded position back of the panel, and the cord is heavily insulated, and the meters are bakelite-cased. The odds are against getting a shock, but no odds are too high when your life is at stake. Our current production is being changed over to a safer arrangement, as outlined above. We hope that those who have transmitters will change them over likewise.

DANA BACON



NOW!

3 New MALLORY
*Vibrapacks!

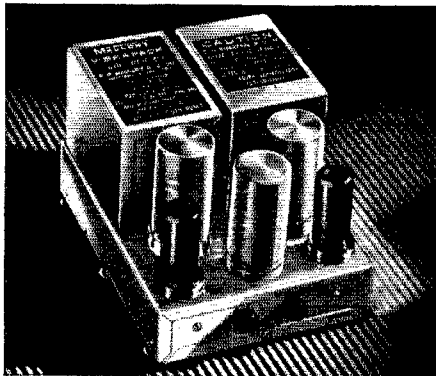

Three new Vibrapack units have just been added to the Mallory line of Vibrator power supplies, designed to supply B voltage to operate portable and mobile radio transmitters and receivers, public address systems, and scientific apparatus. The new units are:

VP-555 illustrated above. A dual Vibrapack with a rating of 300 volts at 200 ma. load, 6.3 volts input. This unit has widespread application in police two-way transmitters, public address equipment and amateur service. List price, \$37.50.

VP-557 . . . a 6.3 volt dual Vibrapack having an output of 400 volts 150 ma. This unit finds application in automobile public address systems and amateur and police transmitters. List price, \$37.50.

VP-558 . . . a 32 volt Vibrapack of the tube rectifier type similar to the VP-554, with a 300 volt 100 ma. nominal output. This unit is for radio receivers on farms, boats, and Pullman cars. List price, \$20.00.

Send for Free Booklet of Technical Data

An 8 page booklet containing complete descriptions of all Mallory Vibrapacks, with application suggestions, technical data and instructions, is available upon request.

Ask for *Vibrapack* booklet,
Form E-555-B

P. R. MALLORY & CO., Inc.
INDIANAPOLIS INDIANA

Cable Address—PELMALLO

TRADE MARK REG. U. S. PAT. OFF.

Use

P. R. MALLORY & CO. Inc.

MALLORY

APPROVED RADIO
PRECISION PRODUCTS

Use

YAXLEY

APPROVED RADIO
PRECISION PRODUCTS

T9), VQ4CHS (14,040 T8) and HP1A (14,055 T9) Latest at WJEA are U1AD (14,465 T9), SU1AX (14,350 T9) and CE3BF (14,420 T9), while at W3HZH it's OQ5AV (14,050 T6), VQ2MI (14,270 T9), ZD4AB (14,405 T8) and ZC6RL (7025 T8) Of interest at W9TJ are such things as XU8MI (14,375) U5YH (14,416) J8CA (14,395), U9MF (14,420), U9MN (14,310), U8IB (14,350), U8ID (14,350), VU2LK (14,365), PK4KO (14,350), ZC2MA (14,300) and KA1MN (14,380) In spite of the poor conditions, W2HHF managed to scare up ZELJN (14,360 T8), J2CN (14,290 T8), K8ILT/KB (14,320-70 T8), XU3LK (14,310), XU8DI (14,370), PK1TM (14,360) and VK9BW (14,360) At W5BB, stuff like CR4HT (14,410, 14,260 T7), VSIAL (14,330 T9) and TG5JG (14,040 'phone) keeps Tom happy W9CWW drops in with VS6AF (14,380 T9), ZB1E (14,380 T9) and HP1X (14,350 T9) W8JDB has XZ2JB (14,015 T9), VU2ED (14,050 T9), PK4KS (14,350), KA1ER (14,335 T9), CR7AF (14,265), FA3JY (14,110 T9), and FA8CR (14,350) VU2FX, VU2FO, KA1RP, and PK1TT can be found around 14,350, says W9YFV.

WHAT:

SORRY we can't comply with your requests for confirmation for the DXCC from the 1939 Contest logs, but you know one of the rules is that no can do until the results appear in *QST*. That will give you a check on whether or not the DX sent in a log.

We've made some reprints of the countries list that appeared in the January issue of *QST*, and you can have one by sending us a large self-addressed stamped envelope. Might be useful for keeping track of countries.

We have an announcement from Hungary saying that HAAQ2 will be on 7220 kc., among other frequencies, several times during the coming year, with experimental broadcasts. Further, HA1K will be on one of the amateur bands at the same time, QRX for reports on the reception of the Hungarian b.c. station in the 40-meter band. Boy, he's really asking for it! Of course, if you should just happen to hear him, and just happen to work him, isn't it going to break his heart when you tell him how poorly the b.c. station is being received on 7220? The scheduled time is 02-05 GT.

PHONE:

IN CASE you think '75 'phone can't be a DX proposition, G5BD tells us that ON4HS has worked all W districts and VE1-2-3 on that band. Plenty of W's are heard in Europe on 75, as early as 01 GT W8LT, the Ohio State Radio Club, was heard in South Africa on 75, when they were running only 100 watts input The Gatti Expedition, OQ5ZZ (14,320), is active now. W2GNQ and W2IXY were among the first to work them. Look for them around 5-7 p.m., EST Spain is back on the air if EA7BA (14,100), worked in Spanish by W2CHK, is any indication W2BIQ worked ZC6HS (14,240), who may or may not be legit VK4HN will be off for about a year, while he operates at PK6XX G5SO worked SU5BO (14,130) in Suez, VP3CO (14,050), TG9BA (14,285) and PK4JD (14,090).

That isn't much dope on 'phone, is it? The unfortunate answer is that it's all we received. The obvious conclusion, of course, is that the 'phone men don't know how to work DX. (Jeeves, reserve me a room at the hospital — I think something's going to happen to me!)

WHO:

DURING a sked with VK3XD, W8KZO QRP'd to one-fourth watt and was RST 349. QRO to a half watt gave him 469. He doesn't say what happened after that, but we imagine he went up to 50 watts and burned out the Aussie's receiver! W6KWA tells us that VU2FO skeds AC4YN (14,290) on Wednesdays and Saturdays at 1600 GT On the low-power side again, W8APQ worked five continents with a single 45, XU4XA for the 6th with a 6L6 running at 25 watts, and has a total of 66 countries VP1BA, who is QSL-ing all Contest contacts via the ARRL QSL Manager system, is an ex-W2, probably the only Yank to get a British license. He's had it for about nine years — with recent rulings there's no

1ST with BEAM POWER TUBES!
1ST in PERFORMANCE TODAY!

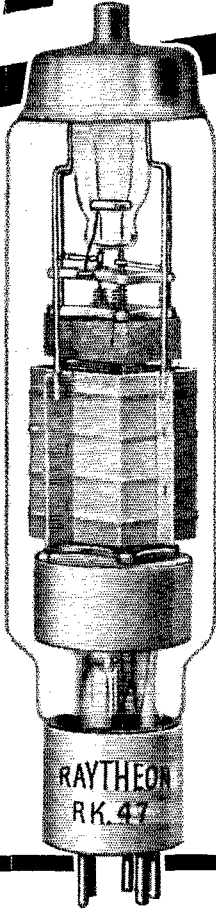

Raytheon first gave the Beam Power Tube to amateur radio. Today, countless Raytheon Beam Power Tubes are used by amateurs, by commercial and airline stations, proving again that RAYTHEON is not only first in development, but also first in quality, performance and dependability.

120 WATTS OUTPUT WITH LESS THAN ONE WATT DRIVING POWER

Band Switching is easy with an RK 47 as less than one watt driving power in Class C telegraphy will deliver 120 watts output. Low driving power, high overall efficiency, complete shielding requiring no neutralization, make the RK 47 ideal for a band switched rig.

Plate Modulation is not only possible but desirable. Because of the inherent characteristics of the beam principle, it is possible to modulate this class of tube without modulating the screen. Many amateurs are operating the RK 47 with 50 Watts of 100% modulated carrier with only 1.5 watts driving power and only 36 Watts modulating power.

The 10 Meter Band can be worked efficiently with the RK 47 as at this frequency this tube can be operated at full rating with high efficiency.

Long, Dependable Life is assured the RK 47. It is hand pumped to real hardness. The hard glass Nonex envelope, oversized 32½ watt filament, molybdenum plate with radiating fins are all factors that have made the RK 47 outstanding for long life.

RK 47

PROVED BY TEST IN THOUSANDS OF RIGS

EP	—	1250 VOLTS
ESG	—	300 VOLTS
ECG	—	70 VOLTS
DRIVING POWER	—	1.0 WATT
POWER OUTPUT	—	120 WATTS

YOUR COST ONLY \$17.50

RAYTHEON
RK

TRANSMITTING TUBES

NEWTON, MASS. • NEW YORK • CHICAGO • SAN FRANCISCO • ATLANTA •

"WORLD'S LARGEST EXCLUSIVE RADIO TUBE MANUFACTURERS"

it's Cardwell again!

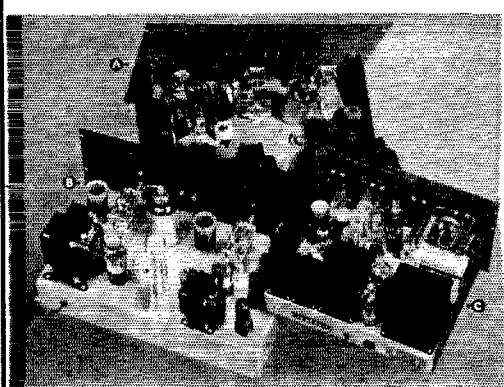

A

In the custom built all-band transmitter of *Barker & Williamson*, Cardwells are used thruout. Single Trim-airs in the Xtal and buffer stages and that prime favorite, the MT-100-GD for the final. The smart bracket arrangement permits all band coverage with the one condenser in the final, using standard B & W coils. Providing a tank circuit without leads, these brackets will be heard from again. The neutralizer for the Taylor T-40 is a *Cardwell ZS-7-SS*.

B

In that very popular *Stancor 20-P*, two *Cardwell* Dual Trim-airs are ingeniously made to supply proper capacity values for optimum "Q" for every amateur band from 5 to 160 meters inclusive. Lowest losses and minimum capacity values dictated the inevitable choice of Cardwells.

C

In the *100-T*, by *Harvey Radio Labs.*, a *Cardwell MT-50-GS* and an *XR-1000-PS* provide a highly efficient final tank condenser and antenna matching capacitor to handle without losses an output of 100 watts on phone.

These nationally known manufacturers invite your permission to send you complete information on the products illustrated.

"CARDWELLS for every purpose" are available at all amateur supply houses.

When in doubt, play safe with **CARDWELL**

**THE ALLEN D. CARDWELL
MANUFACTURING CORPORATION**
83 PROSPECT STREET, BROOKLYN, NEW YORK

chance for anyone else now YS2LR writes to say that the YS2LR who says to QSL via W4EVX is definitely a "phoney." (What's this, a new racket?) All cards that go direct to Salvador go dead at the Post Office and, although YS1FM is supposed to be the QSL forwarding point down there, the cards never reach him. Cards to YS2LR via ARRL or W5FIW get there OK, and a self-addressed envelope and IRC help a lot in getting a reply SM5YU, who is interested in flying and photography as well as radio, is in this country for the fairs and hopes to meet as many of the gang as possible W9HLE tells us that AC4YN is getting some new gear, including a new receiver and possibly a beam. He plans to be in Tibet for quite a spell, so we may still get a crack at him. W9VIP worked an AC4YN the other night, just as the band was going dead. The frequency was right, but "AC4YN" is quite a favorite among the misguided morons we call "phonies" HR4AF has some new cards and will QSL all contacts he made in the Contest. He does ask, however, that the gang be patient and not start sending open cards Speaking of cards, it would be well to have envelopes at your QSL Manager's about this time. A lot of the cards from the Contest will come through that way J2JJ tells us that J2MI didn't get to MX after all, but there will be some new ones on over there about the end of April, with decent power and a fair show of activity. We didn't know it before, but a station in MX must be on the air at least five days a month or he loses his license If you're sending a card to VQ3TOM, you might send him an extra ham-gear catalog if you have one kicking around We used to have a pretty good opinion of W6GHU, W6GAL and W6MHH, but when our undercover agents tell us that they've given up DX-ing for jitterbugging we have to revise our idea. (Jeeves, did you send that coupon to Arthur Murray yet?) W8JSU claims he called VP3NF (7305 T7) twice, sending with his right hand, with no luck. He then called him with his left hand and the guy bounced right back, giving Charlie his 103rd country. Now JSU thinks he has an unbeatable system for raising DX. Too late, son — that system's been in vogue for years!

— W1JPE

Third Eastern DX Round-Up

The New Haven Amateur Radio Association will sponsor the Third Eastern DX Round-Up on Thursday evening, June 1st. The Time: 8:30 P.M. The Place: Olive Branch Masonic Temple, 949 Whalley Ave., New Haven, Conn. The twenty-five cent admission charge covers prizes and refreshments. This affair is specifically "for DX hounds" — others would feel out of their element. Several interesting speakers are scheduled, including Bryan Groom, GM6RG; W. A. R. Brown, Engineer with N.B.C., New York; Nathaniel Bishop, W1EYM, and By Goodman, W1JPE, who hopes to find the answer to that ever-present question, "How's DX?". Many prominent DX operators will be on hand, if advance interest is any indication. Advance information can be obtained from John J. Morris, W1ATH, Secy. N.H.A.R.A., 74 Gorham Ave., Hamden, Conn.

CT DX Contest

Rede dos Emissores Portugeses, R.E.P., Portuguese I.A.R.U. Society, announces its Fourth International C.W. Competition, for contacts between CT amateurs and the rest of the world. The contest will take place on the weekends of June 3rd-4th, 10th-11th and 17th-18th, from 0000 to 2400 GT. Operation will be in the 28-, 14-, 7- and 3.5-Mc. bands. Only one QSO with each amateur, in each band, will count. Each CT will transmit a control group of six figures, the first three representing the RST report, the last three the serial number. A QSL card confirming each contact must be forwarded at the close of the contest to R.E.P., Rua Das Chagas No. 35, Lisboa, Portugal. Each card must show the complete number group received, band, and time and date of the contact. Closing date for receipt of entries is September 30th, 1939. Awards will be made in each country to the amateur making the greatest number of CT QSO's. Certificates will be issued to the leader in each country, each W and VE district counting as a country.

Spot Signals Scientifically

WITH the New

HOWARD 460

COMMUNICATION RECEIVER

with built-in

FREQUENCY MONITOR AND NOISE LIMITER!

Model 460 is a ten-tube Communication receiver with four bands covering 540 KC. to 43 megacycles with a new NOISE LIMITER and the precision frequency monitor by which 'ham frequencies are calibrated against popular broadcast stations! Crystal I.F. filter optional, electric band spread and beat frequency oscillator standard equipment. New single-end tubes, 25% more efficient! Plus all the worthwhile features of sets costing twice as much! Model 460 with separate matched dynamic speaker complete, \$79.95. Crystal filter extra, \$10.00. Pacific Coast and Export prices slightly higher. Models available on order for long wave and special voltages or frequencies.

HOWARD RADIO COMPANY

1735 W. Belmont Ave., Chicago, Ill.

Cable Address: Howardco

8-INCH
DYNAMIC
SPEAKER
TO MATCH

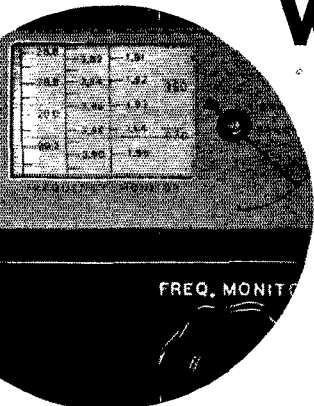

the NEW BUILT-IN MONITOR

Here's what it means to you:

1 You can accurately preset the dial on any 'ham frequency, or repeat the exact station positions on band-spread dial using electrical reference instead of the usual mechanical resetting.

2 You can accurately determine the frequency of any incoming signal enabling you to log stations by actual frequency!

3 You can accurately check your own transmitter frequency as required by FCC.

Use this coupon or a penny post-
for a free circuit diagram and
technical details.

Name _____
Address _____
City _____
State _____



The 1939 National Radio Parts Trade Show

HOTEL STEVENS
CHICAGO, ILLINOIS

June 14, 15, 16, 17

Hytron tubes for "amateur radio" were introduced at the time of the "Parts Show" in Chicago, June, 1938. Consequently, the coming June 1939 Show represents the first anniversary of the Hytronic Division.

New developments of our Laboratories will be announced and displayed. Some pleasant surprises can be expected. You are cordially invited to our exhibit, Booths No. 420 and No. 422 on Marconi Boulevard.

Our policy, which we define in the following paragraphs, will remain the same in the future as in the past.

Why Hytronic?

Recognizing the benefits that the industry at large and the Hytron Corporation have received in the past as a result of the laboratory experiments of the "Amateur," we are anxious indeed to make our contribution by supplying the experimenter with tubes, having in mind such experimentation must be accomplished with tubes and equipment reasonably priced so as to represent a modest expense, and within the limits of funds available.

To this policy, we pledge ourselves — such tubes we develop in the future will not include large, high-powered, expensive types, but instead will be limited to types with interesting possibilities for experimental work — with particular emphasis on a price low enough to encourage the experimentation from which we may later profit.

Thanks

HYTRONIC LABORATORIES
DIVISION OF HYTRON CORPORATION
76 Lafayette Street, Salem, Mass.

MEMBERS, DX CENTURY CLUB

G6WY (No. 5).... 144	PAOXE (No. 43).... 109
W8CRA (No. 1).... 139	W4CYU (No. 78).... 109
W6GRL (No. 15).... 137	W2BYP (No. 102).... 109
W2GTZ (No. 12).... 136	W6HXY (No. 21).... 108
W2GT (No. 32).... 136	W8BKP (No. 65).... 108
W1TW (No. 3).... 135	W3DDM (No. 72).... 108
W1SZ (No. 7).... 135	W9TB (No. 95).... 108
W8DFH (No. 14).... 133	W3GAU (No. 96).... 108
W6CKW (No. 4).... 132	W6FZL (No. 48).... 107
G2ZQ (No. 6).... 132	W2AAL (No. 81).... 107
W2GW (No. 11).... 130	W1DUK (No. 82).... 107
ON4AU (No. 40).... 130	W2ZA (No. 88).... 107
W6KIP (No. 28).... 129	G5BJ (No. 93).... 107
W8BTI (No. 56).... 129	G2DH (No. 101).... 107
W1TS (No. 9).... 127	W9UM (No. 108).... 107
G6RH (No. 36).... 127	W1HX (No. 119).... 107
W9ARL (No. 18).... 125	G2TR (No. 83).... 106
W2BHW (No. 39).... 124	VE2AX (No. 84).... 106
W1LZ (No. 10).... 123	W1CH (No. 91).... 106
H8J9 (No. 13).... 123	W2CJM (No. 47).... 105
W8DHC (No. 27).... 123	W4DRD (No. 94).... 105
W5BB (No. 37).... 129	G5QY (No. 103).... 105
W8OSL (No. 23).... 123	E1SF (No. 19).... 104
W3EMM (No. 58).... 122	W2OA (No. 73).... 104
W9TJ (No. 67).... 122	W2CBO (No. 86).... 104
W1FH (No. 71).... 122	W3AG (No. 107).... 104
W8LEC (No. 25).... 122	G6KP (No. 45).... 103
W1DF (No. 29).... 121	W1AXA (No. 104).... 103
W3CHE (No. 87).... 121	W6FZY (No. 115).... 103
W8OQF (No. 30).... 129	G5BY (No. 118).... 103
J5CC (No. 46).... 120	ZS2X (No. 124).... 103
W4BPD (No. 70).... 121	W4CBY (No. 20).... 102
W8DWV (No. 17).... 119	W1WV (No. 69).... 102
W8ADG (No. 63).... 119	W8NJP (No. 90).... 102
W2CMD (No. 68).... 119	F8RR (No. 98).... 102
W3EPV (No. 74).... 119	W1ADM (No. 110).... 102
W1BUX (No. 2).... 118	W2JT (No. 131).... 102
W9KG (No. 16).... 118	F8RJ (No. 8).... 101
W5VV (No. 38).... 118	VK3KX (No. 57).... 101
W2HHF (No. 54).... 118	W1ZB (No. 62).... 101
W2UK (No. 33).... 116	W4AJX (No. 75).... 101
W9PST (No. 35).... 116	W6DOB (No. 76).... 101
W3EYW (No. 55).... 116	SUIWM (No. 89).... 101
W9ADN (No. 61).... 116	W1CC (No. 106).... 101
W8JMP (No. 22).... 115	SUI5G (No. 117).... 101
W7AMX (No. 26).... 115	W3BES (No. 121).... 101
W6ADP (No. 34).... 115	W1FTR (No. 123).... 101
W9EF (No. 44).... 115	J2JJ (No. 125).... 101
W2CYS (No. 52).... 115	H89BG (No. 127).... 101
ZL1HY (No. 59).... 115	W8MTY (No. 129).... 101
W9GDH (No. 41).... 112	W8EUY (No. 97).... 100
W9KA (No. 49).... 112	W2DSB (No. 100).... 100
W6GAL (No. 50).... 112	G6NF (No. 105).... 100
W3WT (No. 51).... 112	W8KKG (No. 109).... 100
W4CEN (No. 60).... 112	W2AER (No. 111).... 100
W1JPE (No. 66).... 112	VK2DG (No. 112).... 100
W3FRY (No. 85).... 112	W6KRI (No. 113).... 100
D4AFF (No. 99).... 112	W6TJ (No. 114).... 100
G5RV (No. 64).... 111	W9UQT (No. 116).... 100
W9FS (No. 77).... 111	W8AU (No. 120).... 100
W2GVZ (No. 80).... 111	W8OXO (No. 122).... 100
W5KC (No. 92).... 111	G5B (No. 126).... 100
G6CL (No. 24).... 110	W1BGY (No. 128).... 100
ON4JU (No. 41).... 110	W8CUJ (No. 130).... 100
VK5WR (No. 49).... 110	G6MK (No. 132).... 100
W3EDP (No. 53).... 110	VEZEE (No. 133).... 100
W2DC (No. 79).... 110	

The following have submitted proof of contact with 75-or-more countries: D3BMP, PAOQF, VK3CX, W1GCK, W1GDY, W8QXT, W9AJA 99; G2MI, W1ZI, W3BEN 98; G6QH, W1RY, W8AHZ, W6GHU 97; W8BOX 96; W1GNE, W2GRG, W8DOD 95; W1BXC, W8AAJ 94; F8SAB, W3KTE, W6BAM, W8BSP 93; G6XL, H8GCE, W3BML, W3CEH, W4OCH, W5ASG 92; H89G, W2FV, W8CJL 91; G8YR, PAOQZ, W2IOP, W4EQK, W6PKZ, W8KTW, W9CWO 90; G2DZ, G6ZO, VK6SA, W3A00, W3JM, W8QDU 88; SP1AR, W2ALO, W3EMA, W9AEH 87; W3AUI, W3OP, W4DMB, W4MR, W8IQB, W8JAH, W8FEL, W9BEI 86; W4OED, W3LAV 85; SM6WL, W2CUQ, W3AGV, W85WV, W9OVU 84; W1SFT, W2AWE, W6GPE, W6TT, W8BFG, W9BEZ 83; G8IG, W1EWD, W3FLH 82; VE3GA, W6KUT, W8DAE, W9RCQ 81; W2BNX, W8BVN, W3EPR, W6LDD, W8MVK, W8AAT, W8DGP 80; LUTAZ, SP1EP, W3GHD, W8FJC, W9A8Y 79; W4TZ, W6AM, W8FJN 78; W1ICA, W9GMV 77; PAOJMW, W9PFS, ZELJ 76; D3CSC, W2BJ, W4EPV, W6GK, W9JDP 75. Radiotelephone: W4CYU 84; W2IXY 83.

O.B.S.

The following is a supplement to the list of A.R.R.L. Official Broadcasting Stations in October QST (page 71): W1KTB, W4CQG, W4PEI, W8CFB, W8FTW, W8CJM.

**310°
SPREAD**



HQ-120-X

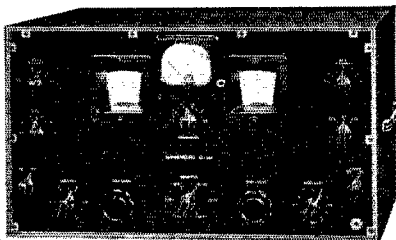

CALIBRATED

with Band

INCREASING

DIRECT CALIBRATED BANDSPREAD on the "HQ-120-X" is unquestionably the greatest operating convenience ever offered the radio amateur. The four main bands, 80, 40, 20, and 10, appear on the dial in megacycles and cover over 310 degrees. This wide spread and "wrist level" placement of the large tuning knob allow effortless tuning. When used with a reasonable amount of precaution, the bandspread dial is accurate to better than 1/10%. Therefore, it is no longer necessary to guess at the frequency of a received signal. In addition to the four calibrated scales (see illustration), the bandspread dial has a 0-200 arbitrary scale for calibration and logging in other parts of the tuning range. The main tuning dial is

also accurately calibrated in megacycles throughout the entire range of from 31 to .54 mc. (9.7-555 meters). Make a note of all the features you have always wanted in a receiver. Then, try an "HQ-120-X" and you will find them all there.

WRITE FOR BOOKLET

HAMMARLUND MFG. CO., INC.

Q-6-39

424-438 W. 33rd St., N. Y. C.

Please send 16-page booklet

Name.....

Address.....

City.....State.....

Canadian Office: 41 West Ave. No.,
Hamilton, Ont.



HAMMARLUND

Smooth Voltage Control

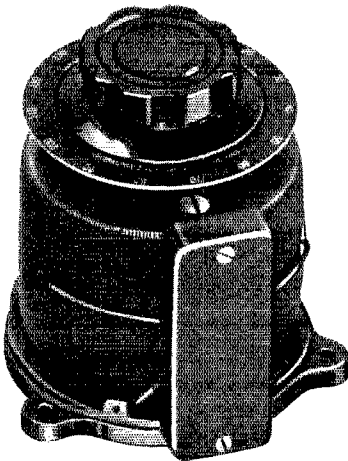

● VARIAC autotransformers are used extensively as voltage controls in amateur stations. Connected in the input side of high-voltage rectifiers, the VARIAC supplies *continuously adjustable* d-c output with a 320 degree rotation of the control knob. VARIACS are ideal for compensating, manually, for low line voltages. The Type 200-CU, illustrated, supplies output voltages in stepless increments to 135 volts when used on a 115-volt line.

VARIACS feature:

- Absolutely stepless control from zero
- High efficiency (consume very small no-load power)
- Output voltages higher than line, for keeping line voltage constant
- Calibrated dials
- Rugged construction
- Long life

The Type 200-CU VARIAC is intended for behind-the-panel mounting and will control 860 watts for continuous duty. Its price is only \$14.50.

- WRITE FOR BULLETIN 418 FOR DESCRIPTIONS OF FOURTEEN MODELS OF VARIACS

General Radio Company
Cambridge, Mass.

Bermuda Cruise — WCFT

WCFT, the Schooner-Yacht *Yankee*, sails from Gloucester, Mass., for Bermuda, on June 3rd, to return June 17th. It is desired to work as many amateurs as possible in order to test the coverage of a new transmitter, which runs 200 watts output, either c.w. or 1000 cycle i.c.w., on 3105, 4140, 5520, 5210, 8280, 11,040, 12,420, 16,560 and 22,080 kcs. Receiver is t.r.f., 35 kc. to 30 Mc. Operators will be Alan Eurich, W7HFZ, and Oakes Spalding, W1FTR. Adjacent frequencies will be used to work a given ham band, as follows: 16,560 or 12,420 for 14 Mc.; 8280 or 6210 for 7 Mc.; and 4140 or 3105 for 3.5 Mc. CQ calls will follow each QSO, with an indication of the band on which amateurs should answer, "Ans 40," etc.

It is suggested that 14-Mc. work be between 1000 and 1300 GT and again between 2100 and 0200 GT, 7-Mc. work between 2100 and 0900 GT, with 3.5 Mc. possibly included in that period. There are no *definite* schedules for general work, but particular emphasis will probably be placed on the periods mentioned. Amateurs are requested to watch for WCFT on the various frequencies listed.

Hams Afloat

Leaving the Boston Navy Yard, the U.S.S. *Chelan* sailed on the annual International Ice Patrol duty, March 9th. The Patrol usually lasts four months or more, depending upon ice and weather conditions. Among the selected radiomen this year are veteran Ellis Holden, W1GUI, Chief Radioman, making his fourth trip to the ice fields. W1CLM and W1DND are also among the operators. The *Chelan* will base at Halifax, Nova Scotia, until expiration of the ice season. . . . W4DGW is third operator aboard the Davies' Auxiliary Yacht *Sea Cloud*, WCEQ. This ship is 316 feet long overall, 2323 tons, the largest of its kind in the world. The main rig runs 500 watts output on all marine frequencies. WCEQ was scheduled to sail April 15th to the North Sea. . . . W4BYS enjoyed a trip to seven European ports as Sparks on the S.S. *Tulsa*. . . . W4CPL is operator on the S.S. *Bessemer*, running from Philadelphia to Houston. . . . W7CYU and W7AJU, S.S. *Memnon*, Astoria, Ore., to Naknek, Alaska, operate portable K7 at Naknek. . . .

June Hamfests

June 25th, at Round Lake, Wis.: The Fox River Valley Radio Clubs will hold their Seventh Annual Hamfest on Sunday, June 25th, at Round Lake, Wis. The grounds of this ideal hamfest site will be open early in the morning and a full program will start at 11:00 A.M. Registration is \$1.00 in advance, \$1.25 at the grounds, covering everything, eats, prize tickets, etc. Registration may be made with Robert G. Artman, W9KYY, 816 Bluff Ave., Sheboygan, Wis. Cash need not accompany registration as the \$1.00 rate may be paid at the grounds if reserved in advance.

June 25th, at U. S. Dam 53 Park, Ohio River: The Egyptian Amateur Radio Society will hold its Annual Hamfest and Fishry at U. S. Dam 53 Park on the Ohio River, June 25th. Everyone is invited and all welcome.

June 17-18, at Valparaiso Florida: Mr. and Mrs. Jimmie Long, W4KB-W4FAX, are holding one of their famous hamfests at Valparaiso on Field Day week-end, June 17th-18th. Everyone welcome. Bring your portable gear!

Swift Justice Meted Out to Call Bootlegger!

On the evening of January 25, 1939, an Oakland (Calif.) amateur contacted a 'phone station on the 160 meter band, using the call W6KBX. A previous inquiry at the R.I.'s office had revealed the fact that this call had not been issued. After some conversation talk turned to the call. When the licensed amateur stated that the call had not been issued, and wondered why the fellows were using it, there was a dead silence. Immediately, they had to go some place, and signed off. A short time later a friend called on our East Bay licensee friend. While they were typing, three shots were heard, bullets passing through the shack head-high. Fortunately the amateurs were sitting down or the shots might have been fatal. The matter was reported to the police. A call was made at the address given by the bootleggers, but no one was found there. The police watched the place all night. In the morning officers entered the place and found an

IT'S A NEW EIMAC TUBE

LOW CAPACITY

LOW VOLTAGE

LOW PRICE

\$9⁰⁰

75T

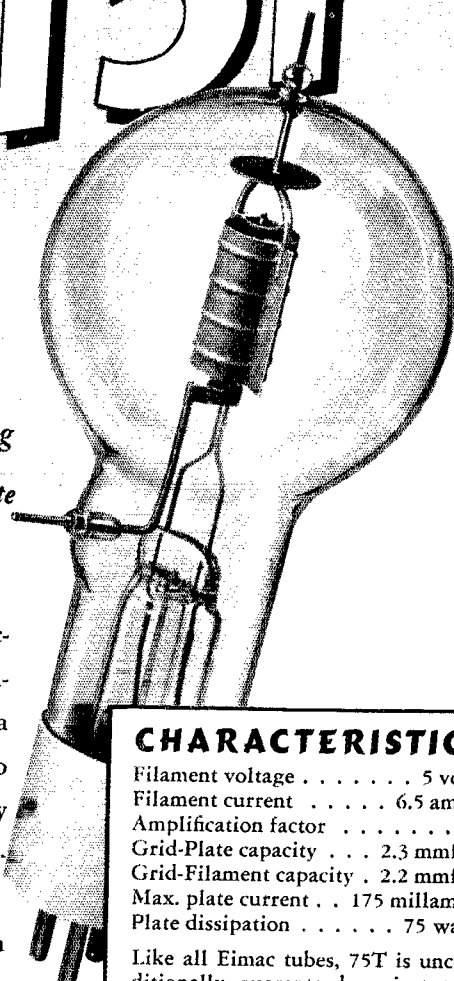

A pair of these Eimac 75T tubes operating on phone with only 1000 volts on the plate will put a full 1/4KW in the antenna.

Here, at last, is a low capacity, low voltage vacuum tube that is ideal for all amateur communication frequencies. It possesses all the stamina and super-performance capabilities common to Eimac tubes; tantalum plates and grids, extremely low inter-electrode capacity, easy to drive, absolute freedom from gas.

An extra rugged filament and grid accounts, in part, for its *ability to out-perform most other tubes of like ratings*. Note the sturdy construction of the plate, the addition of a heat shield over the elements, the husky grid with its simple support and the wide spacing between grid and plate leads. Go to your dealer's and see the new 75T.

CHARACTERISTICS

- Filament voltage 5 volts
- Filament current 6.5 amps.
- Amplification factor 11
- Grid-Plate capacity . . . 2.3 mmfds.
- Grid-Filament capacity . 2.2 mmfds.
- Max. plate current . . . 175 millamps.
- Plate dissipation 75 watts

Like all Eimac tubes, 75T is unconditionally guaranteed against tube failures which result from gas released internally — will stand momentary overloads of as much as 400% to 600% without damage.

Eimac
TUBES

EITEL-McCULLOUGH, INC., San Bruno, California

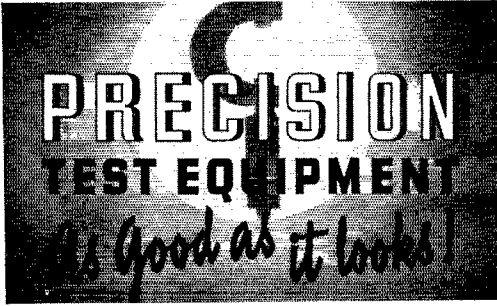

EXAMINE any one of our products INTERNALLY. . . . Ask your jobber to open one for you. . . . Note the craftsmanship and the infinite care in construction and wiring. . . . Not a single tested and advanced engineering refinement is omitted even though our prices remain surprisingly LOW . . .

3000 VOLTS A.C. and D.C. Available in the
New "PRECISION" Automatic
PUSH-BUTTON A.C.-D.C. MULTI-RANGE TESTER

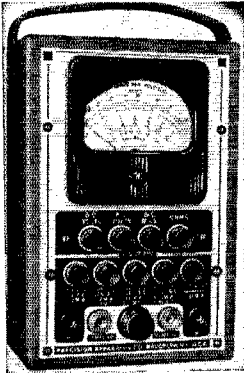

Series 870

- ★ **D.C. VOLTAGE RANGES** at 1000 ohms per volt: 0 to 6/30/300/600/1200 and 3000 V.
- ★ **A.C. VOLTAGE RANGES** at 500 ohms per volt: 0-12/60/600/1200 and 3000 volts.
- ★ **D.C. CURRENT RANGES:** 0-1, 2, 12/120/600/1200 milliamperes.
- ★ **RESISTANCE RANGES:** 0-5000 ohms (20 ohms at center of scale) 0-500,000 ohms (powered by self contained 3 volt battery) 0-5 megohms (powered by external battery).
- ★ **FIVE DECIBEL RANGES:** -10 to +64DB.
- ★ **OUTPUT METER INDICATIONS** on Five A.C. voltage ranges.

Large size 3 inch square meter. Compact walnut finished case. Size 7 x 4 x 3. Wire wound shunts and metallized multipliers, both 1%. Net Price, with 3 volt battery. . . . **\$16.95**

AVAILABLE AT LEADING DISTRIBUTORS

Following is a partial list

Akron, Ohio	OLSON BROS. RADIO SUPPLY
All branches	WHOLESALE RADIO SERVICE CO.
Boston, Mass.	RADIO SHACK INC.
Buffalo, N. Y.	RADIO EQUIPMENT COMPANY
Butler, Mo.	HENRY RADIO SHOP
Chicago, Ill.	CHICAGO RADIO APPARATUS CO., INC.
Columbia, S. C.	DIXIE RADIO SUPPLY CO.
Des Moines, Iowa	H. E. SORENSON COMPANY
Detroit, Mich.	FERGUSON RADIO SPECIALTIES
Detroit, Mich.	M. N. DUFFY & COMPANY
Houston, Texas	SPRAUS-FRANK CO.
Jamaica, N. Y.	PEELERS RADIO DISTRIBUTORS
Los Angeles, Calif.	RADIO SPECIALTIES COMPANY
New York, N. Y.	TERMINAL RADIO CORPORATION
Norfolk, Va.	RADIO SUPPLY COMPANY
Oakland, Calif.	E. C. WENGER CO.
Omaha, Neb.	H. C. NOLL COMPANY
Pittsburgh, Pa.	TYDINGS COMPANY
So. Bend, Ind.	RADIO DISTRIBUTING CO.
Tacoma, Wash.	A. T. STEWART COMPANY

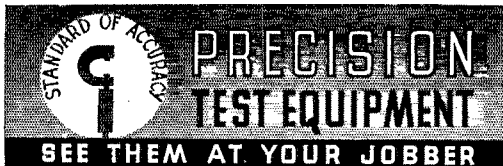

PRECISION APPARATUS CORP.
 647 Kent Ave., Brooklyn, N. Y.

Export Division: 458 Broadway, New York City, U.S.A.
 Cable Address: Morhanex

RME receiver but no transmitter, as it has been moved. The following day one of the bootleggers was picked up and questioned by the police. Although the police had a strong circumstantial case, nothing was admitted by the suspect. The gun could not be found.

The case was given quite a bit of publicity in the newspapers. The R.I.'s office took a hand in the case, for the bootlegging. Altogether the R.I. dug up 23 witnesses. A federal warrant was next issued for one of the suspects. Questioning him by the Federal authorities produced the name of the second man. A warrant was issued for him. A conviction was obtained in eight days, hanging up a new record for the Federal courts at San Francisco. One man (the owner of the apparatus) was given one-year probation and fined \$100, and the other man was given one year's probation. It is understood that these men are trying to get some licensed ham to house their equipment so they can use it when they want to. One is also taking code practice at a local trade school. As a result of what transpired bootlegging has dropped a lot around the East Bay Section, we are told!

Illegal Operations Prosecuted

On April 3, 1939, the F.C.C. suspended the amateur radio operator license of Kenneth A. Olson (W9YXO), Minneapolis, Minn., with Class "A" privileges, for a period of three months, because licensee transmitted false call signals and letters which had not been assigned by proper authority to the station he operated, and he operated his station with type A-2 emission in violation of Sections 152.32 and 152.42 of the Comm. Rules and Regulations Governing Amateur Radio Operators and stations.

The F.C.C. on April 18, 1939, released the following:

"In the first prosecution of its kind in the Federal Courts in Minnesota, Thomas Carpenter, St. Paul, Minn., pleaded guilty to an indictment charging the operation of an unlicensed radio station in violation of Sections 301 and 318 of the Communications Act of 1934, as amended. The court deferred imposition of a sentence and placed the dependent on probation for a period of two years. Inspectors of the F.C.C. have evidence indicating that there are other unlicensed radio stations operating in the St. Paul area and further prosecutions are expected to follow."

Other illegal operations curbed include the case of Walter Huber of La Mesa, Calif., who was convicted in Federal Court last January of maintaining and operating a 56-Mc. transmitter without a license; and the case of Harold J. Collins (W8CPK), Dayton, Ohio, whose operator license was suspended in February for six months, for taking the examination for operator's license under the name of Irel H. Snyder for the purpose of obtaining for Mr. Snyder an amateur operator license.

2 1/2 Meters

Interest in "2 1/2 meter" work is on the increase, particularly in the metropolitan areas. W9ZGD, Milwaukee, reports that 2 1/2 has more or less replaced 56 Mc. there for local rag chews. Active stations include W9SYT, W9MZZ, W9CCD, W9JTR, W9YYY, W9WTL and W9ZGD, with many others building equipment. Most receivers are 76's with separate quench oscillators; transmitters are mostly '45 oscillators. Best DX reported so far is 17 miles. In the New York City area the following members of the Queens Radio Amateurs are active: W2AOD, W2CWE, W2GGN, W2KCH, W2KXG, W2LGJ, W2LGS, W2LPI and W2LUX. W2CWE has worked W2AOD and W2IDL, and heard W2HIK and W2LOC. W2LGJ has worked W2KXG and W2AOD. The Q.R.A. held a 2 1/2-meter contest on four consecutive Sundays, starting April 23rd, with prizes for the highest scorers, in order to increase activity. Let's have some more reports on "2 1/2."

ELECTION NOTICES

To all A.R.R.L. Members residing in the Sections listed below: (The list gives the Sections, closing date for receipt of nominating petitions for Section Manager, the name of the present incumbent and the date of expiration of his term of office.) This notice supersedes previous notices.

In cases where no valid nominating petitions have been received from A.R.R.L. members residing in the different Sections in response to our previous notices, the closing dates for receipt of nominating petitions are set ahead to the dates given here-with. In the absence of nominating petitions from Members of a Section, the incumbent continues to hold his official position and carry on the work of the Section subject, of course, to the filing

HARVEY *2-way* POLICE RADIO



PF-25 Central Station Unit ■ For localities where 25 watts output will give satisfactory coverage this quality equipment is ideal. A compact, hinged-cover cabinet houses both transmitter and receiver. Locked transmitting controls prevent tampering and interlock switches add safety. Operates from the standard lighting circuit with low current consumption — no batteries or rotary machinery necessary. Built of standard quality parts so that replacement, when necessary, is easy and inexpensive.

PM-15 Mobile Transmitter ■ Due to its electrical and mechanical excellence this 15 watt unit insures trouble-free service under the roughest conditions. Designed for service, the entire transmitter is constructed as a unit on a heavy steel base, cushioned against road shock and mechanical vibration. This type of construction eliminates long cables and makes installation easier. Operation is completely controlled by a button on the handset which is mounted on the instrument panel of the car. Full transmitter output is obtained in less than half a second — no warm-up period necessary.

PM-10 Mobile Transmitter ■ This unit is identical to the PM-15 in construction and appearance but employs a less expensive hand microphone, different tube line-up, and delivers 10 watts output. The transmitter is ideal for departments interested in a dependa-

ble smooth running low cost installation. Both the PM-10 and the PM-15 have provisions for operating a safety horn direct from the audio section of the transmitter.

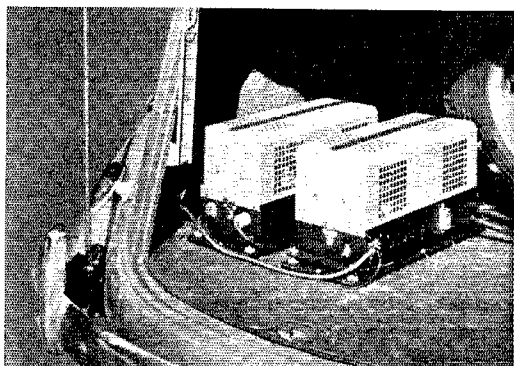

Receivers ■ All receivers used in Harvey Police installations are the last word in nine tube superheterodynes. A highly efficient noise silencer deadens the receiver during standby periods and the special noise balancer reduces interference to a minimum. The receiver is crystal controlled which maintains stability of performance over a wide temperature range.

FM-4 Frequency Meter ■ The Federal Communications Commission requires all Police Departments to provide for measurement of their station frequency by a means independent of the

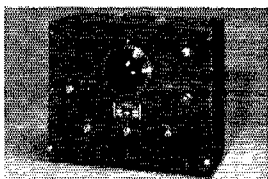

frequency control of the transmitter. The FM-4 meets the requirements of the F.C.C. and is a precision instrument, providing a frequency stability of .01 percent.

Safety Horn ■ Here is a new innovation in the Police Radio field introduced by Harvey — a safety horn operating from the mobile radio installation. By throwing a switch on the dash-board control box and talking into the microphone, the operator's voice is projected from the horn in sufficient volume to carry a city block even under severe noise conditions.

HARVEY RADIO LABORATORIES, INC.
26 THORNDIKE STREET
CAMBRIDGE, MASS.

Export: 25 Warren Street, New York City

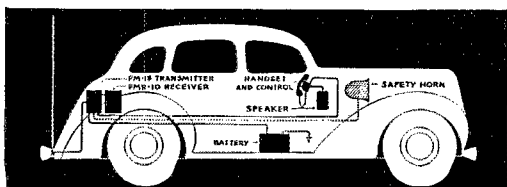

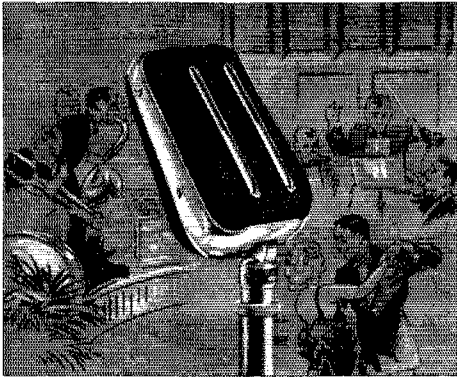

ASTATIC

Crystal Microphones Give Top Performance

One of our popular new models is the Multi-Unit Microphone here illustrated. Dual diaphragm construction. Maximum amplification with minimum feed back tendencies. Suitable frequency response for public address and general sound installations. Cannot be acoustically overloaded. Complete with interchangeable locking connector and 25-ft. rubber covered cable.

List Price, MU-2, \$29.50

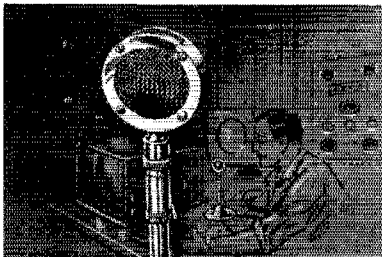

Veterans Okay D-104

Rendering efficient service for more than six years, Astatic Model D-104 has been proved and accepted by veteran amateurs the world over. Socket connector interchangeable with all Astatic stands and hand accessories.

List Price \$22.50

ASTATIC

ASTATIC MICROPHONE LABORATORY, INC.
YOUNGSTOWN, OHIO

Licensed Under Brush Development Co. Patents

of proper nominating petitions and the holding of an election by ballot or as may be necessary. Petitions must be in West Hartford on or before noon of the dates specified.

Due to resignations in the Iowa, Manitoba and Alaska Sections, nominating petitions are hereby solicited for the office of Section Communications Manager in these Sections, and the closing date for receipt of nominations at A. R. R. L. Headquarters is herewith specified as noon, Monday, July 3, 1939.

Section	Closing Date	Present SCM	Present Term of Office Ends
San Francisco	May 15, 1939	Alan D. Whittaker, Jr.	May 28, 1939
North Dakota	June 1, 1939	Ernest Bloch	June 14, 1939
No. Minnesota	June 1, 1939	Edwin L. Wicklund	June 15, 1939
Idaho	June 1, 1939	Carl Eichelberger	June 15, 1939
Sacramento Valley	June 1, 1939	J. L. C. Buckenham	June 15, 1939
Iowa	July 3, 1939	Clyde C. Richelieu (resigned)
Manitoba *	July 3, 1939	Alf. G. Sheffield (resigned)
Alaska	July 3, 1939	Leo E. Osterman (resigned)
Nevada	July 3, 1939	Edward W. Heim	June 14, 1937
Philippines	July 3, 1939	George L. Rickard	Oct. 15, 1938
No. New Jersey	July 3, 1939	Fred C. Read	Feb. 15, 1939
Indiana	July 3, 1939	Noble Burkhardt	Apr. 15, 1939
Md.-Del.-D. C.	July 3, 1939	Edgar L. Hudson	July 15, 1939
Eastern Penna.	Aug. 1, 1939	John B. Morgan	Aug. 11, 1939
Arizona	Aug. 1, 1939	Victor C. Clark	Aug. 13, 1939
Oklahoma	Aug. 15, 1939	Carter L. Simpson	Aug. 23, 1939
West Virginia	Aug. 15, 1939	C. S. Hoffmann, Jr.	Aug. 23, 1939
South Carolina	Aug. 15, 1939	Ted Ferguson	Aug. 25, 1939
Eastern N. Y.	Sept. 1, 1939	Robert E. Haight	Sept. 16, 1939

* In Canadian sections nominating petitions for Section Managers must be addressed to Canadian General Manager, Alex Reid, 169 King St. East, St. Lambert, Quebec. To be valid such petitions must be filed with him on or before the closing dates named.

1. You are hereby notified that an election for an A. R. R. L. Section Communications Manager for the next two-year term of office is about to be held in each of these Sections in accordance with the provisions of the By-Laws.

2. The elections will take place in the different Sections immediately after the closing date for receipt of nominating petitions as given opposite the different Sections. The Ballots mailed from Headquarters will list in alphabetical sequence the names of all eligible candidates nominated for the position by A. R. R. L. members residing in the Sections concerned. Ballots will be mailed to members as of the closing dates specified above, for receipt of nominating petitions.

3. Nominating petitions from the Sections named are hereby solicited. Five or more A. R. R. L. members residing in any Section have the privilege of nominating any member of the League as candidate for Section Manager. The following form for nomination is suggested:

(Place and date)

Communications Manager, A. R. R. L.

33 La Salle Road, West Hartford, Conn.

We, the undersigned members of the A. R. R. L. residing in the Section of the Division hereby nominate, as candidate for Section Communications Manager for this Section for the next two-year term of office.

(Five or more signatures of A. R. R. L. members are required.)
The candidates for nominating managers must be League members in good standing or the petition will be thrown out as invalid. Each candidate must have been a licensed amateur operator for at least two years and similarly, a member of the League for at least one continuous year, immediately prior to his nomination or the petition will likewise be invalidated. The complete name, address and station call of the candidate must be included. All such petitions must be filed at the headquarters office of the League in West Hartford, Conn., by noon of the closing date given for receipt of nominating petitions. There is no limit to the number of petitions that may be filed, but no members shall sign more than one.

4. Members are urged to take initiative immediately, filing petitions for the officials for each Section listed above. This is your opportunity to put the man of your choice in office to carry out the work of the organization in your Section.

— F. E. Handy, Communications Manager

ELECTION RESULTS

Valid petitions nominating a single candidate as Section Manager were filed in a number of sections as provided in our Constitution and By-Laws, electing the following officials, the term of office starting on the date given.

Arkansas	H. E. Velte, W5ABI	Feb. 15, 1939
Vermont	Clifton G. Parker, W1KJG	Feb. 15, 1939
San Joaquin Valley	Edwin A. Andrews, W6KUT	Feb. 15, 1939
North Carolina	W. J. Wortman, W4CYB	Mar. 18, 1939

In the Hawaii Section of the Pacific Division Mr. Francis T. Blatt, K6STP, and Mr. Henry S. Lau, K6CAS, were nominated. Mr. Blatt received 44 votes and Mr. Lau received 35 votes. Mr. Blatt's term of office began February 28, 1939.

Mississippi	Jewell W. Cole, W5EWD	Feb. 15, 1939
Manitoba	Alf. G. Sheffield, W4ASD	Apr. 3, 1939
Nebraska	William B. Bamer, W9D1	Apr. 14, 1939
Western Florida	Oscar Cederstrom, W4AXP	Apr. 15, 1939
Rhode Island	Clayton C. Gordon, W1HRC	Apr. 15, 1939
New Mexico	Dr. Hilton W. Gillett, W5ENT	Apr. 16, 1939
N. Y. C. & v. L.	Edward L. Baunach, W2AZV	Apr. 22, 1939

In the Eastern Massachusetts Section of the New England Division Mr. Larry Mitchell, W1HIL, and Mr. C. Leo Riley, Jr., W1LY were nominated. Mr. Mitchell received 67 votes and Mr. Riley received 71 votes. Mr. Mitchell's term of office began March 16, 1939.

Tru-Fidelity

THORDARSON

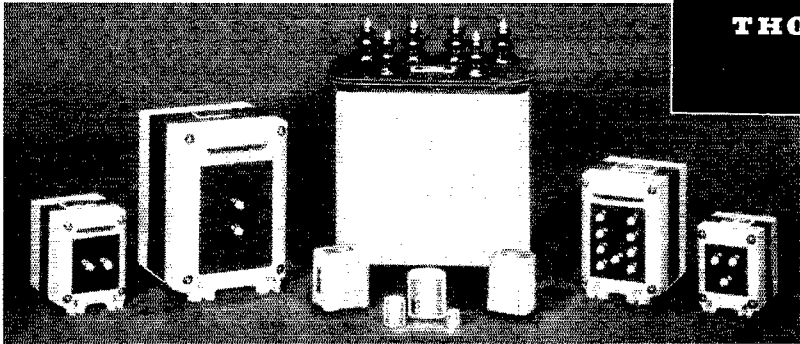

A NEW SERVICE FOR BROADCAST ENGINEERS

Thordarson components for broadcast applications are now available through Thordarson distributors located throughout the United States and practically all foreign countries. This means service at your finger tips.

For years Thordarson has supplied special transformers to discriminating engineers and labora-

tory technicians in broadcast stations, universities, industrial fields and the general radio industry. Standardization of broadcasting equipment and uniform power ratings now make it more practical to catalog representative designs. Others can be supplied to order from standard or special specifications. From microphone to loud speaker, Tru-Fidelity transformers are now available.

FEATURING

AUTOMATIC VOLTAGE CONTROL UNITS

A brand new development from Thordarson research laboratories. Insures a steady 115 volt output supply although line voltage supply or input varies from 90 to 130 volts and the load from 1/3 to full capacity.

CURRENT LIMITING FILAMENT TRANSFORMERS
Especially designed to limit starting current of transmitting tubes to a safe value.

AUTO TRANSFORMERS

500 V.A. to 4,000 V.A. capacity for line voltage correction.

PLATE TRANSFORMERS

Never before such universal power supplies. Twelve types cover 67 voltages and currents ranging from 300 to 11,000 volts for use in equipment up to 10,000 watts capacity.

THREE SERIES OF AUDIO TRANSFORMERS

"MAJOR"—"BANTAM"—"INCHER"

The result of months of painstaking research, careful engineering and designing, plus rigorous laboratory testing. All units have magnetic shielding provided by self-shielding or humpucking construction and cast or high permeability drawn, chrome cases. The various case styles and sizes are illustrated in the center foreground of the picture above. The smallest unit shown is 15/16" in diameter and 1 1/8" high. These are especially desirable for portable units and to meet conditions where space and weight are at a premium.

Many new features are incorporated in modulation transformers, reactors, etc. The entire series presents a uniform appearance.

*Complete listing of "Tru-Fidelity by Thordarson" in Catalog 500-D.
Get your free copy from the local Thordarson distributor or write to factory.*

THORDARSON ELECTRIC MFG. CO.

500 W. HURON ST., CHICAGO, ILL.

Demand "Power by Thordarson"

BOOTHS 117-119 AT CHICAGO PARTS SHOW

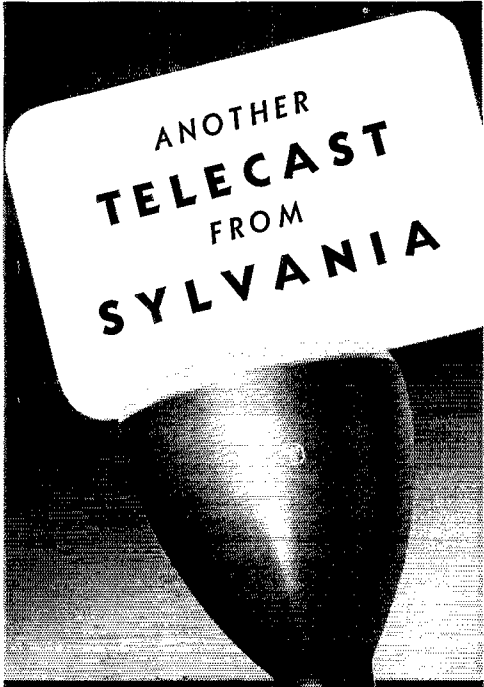

Announcing SYLVANIA

5-inch screen type 5AP1/1805-P1 and type 5AP4/1805-P4

Television news is breaking fast, and Sylvania is up-to-the-minute on every new development.

Here is a shorter, stubby 5-inch screen Cathode-Ray tube using electrostatic focusing and electrostatic deflection. And remember, the same fine quality that has always characterized Sylvania radio receiving tubes is a first consideration in the building of this and all other Sylvania Cathode-Ray tubes.

Write Hygrade Sylvania Corporation, Emporium, Pa., for technical data on this new tube.

SYLVANIA

SET-TESTED RADIO TUBES

Fashions in Antennas

(Continued from page 18)

A 135-foot-per-leg terminated rhombic, 25 feet high, is pointed at Manila and used on all bands. Another rhombic, 30 feet high, is 210 feet on a leg and aimed at London. Also terminated, this antenna permits working of European signals that are often not audible on any other antenna. Apparently the vertical angle is rather sharp, but when the angle is right the antenna is unbeatable. A horizontal 3/2-wavelength antenna, Q-matched



The shack (built over the garage) and some of the antenna masts at W6OCH.

to a 600-ohm line, is used on 28 Mc. for South American coverage. Although 80 feet high, the antenna doesn't perform any too well. The last antenna available is a 28-Mc. lazy H aimed at Hawaii, giving good coverage of VK, ZL and the United States.

Since all antennas are fed by 600-ohm lines, any one can be shifted to the final tank without affecting the tuning. A relay system, controlled from the operating table, allows remote selection of any system.

* * * * *

Where are those conclusions we promised? Maybe we'd better leave that until next time, because right now we're going home to put up a 6-element Sterba curtain—no, maybe we'd better try one of those lazy H's. On the other hand, if three of the neighbor's houses burned down, we could put up a rhombic. Hey, Don, lend me a match. . . .

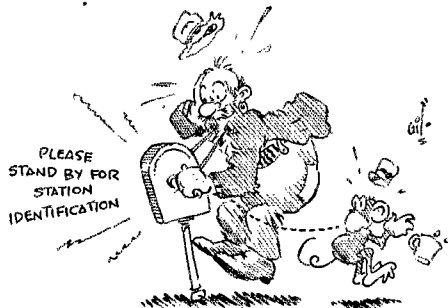

100 Watt ALL BAND Transmitter

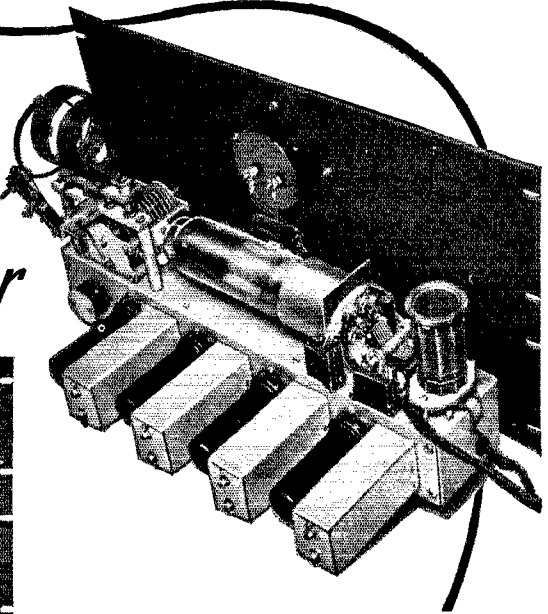
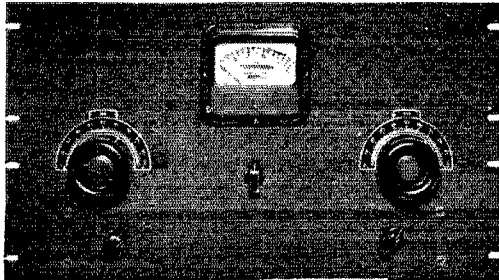

BUILT
*with
the*

ED-4
Foundation Unit

BUILD this modern band switching 100 watt, four band transmitter with the Hammarlund "ED-4" foundation unit. The entire transmitter is no larger than the average amateur receiver and can be placed conveniently on the operating desk. Operates on 80, 40, 20, and 10 meters with remarkable efficiency. The exciter unit has full band and meter switching to facilitate band changing and operation. There are four separate exciter stages; one for each of the four bands from 80 to 10 meters inclusive. The exciter stages employ ready-wound fixed tuned coil units which can be adjusted to any frequency within the amateur bands. All circuits in the exciter remain in perfect alignment when changing bands. There are only two tuning controls for the entire transmitter that require adjustment when changing bands or frequency. Four 6L6 beam tubes are used in the exciter, and an RK-47 or 814 is used in the amplifier. This final stage will accommodate

RK-20, RK-20A, 804, or any similar tube. Low power tubes such as, the RK-39 and 807 can also be used in cases where the unit is used as a driver and only 30 or 40 watts of excitation are necessary. Not only can the "ED-4" be used as a 100-watt transmitter, but it can be used to drive the Hammarlund "PA-500" power amplifier in a 1/2 kw. transmitter. Complete constructional details for this 100-watt transmitter can be obtained by mailing coupon today.

SEND FOR CONSTRUCTIONAL DETAILS!

HAMMARLUND MFG. CO., INC. Q-6-39
424-438 W. 33 St., N. Y. City

Please send "ED-4" Folder

Name.....

Address.....

City.....State.....

Canadian Office: 41 West Ave. No.
Hamilton, Ont.



HAMMARLUND

**DO MAJOR EXPERIMENTING
WITH THE NEW RADIO**

**FACSIMILE
PRINTING**



**BUILD IT
YOURSELF**

**CROSLLEY
READO KIT \$49.50**

Radio in its infancy did not promise as much as FACSIMILE RADIO PRINTING does today. Licensed under the Federal Communications Commission, leading broadcasting stations are broadcasting experimentally late every night on the broadcast bands and in some instances during the day on high frequencies. Now is the time to get in on the ground floor either for future profit or present pleasure. It is a new art already developed to a fascinating degree through daily experimental broadcasts of WOR, WLW and others. It bids fair to be the most important of all radio developments — a not too distant future should see radio facsimile printers in every home, unrolling a constant strip of pictures, news, vital statistics and reports in a steady stream. Grow with the art. Build your own facsimile printer with the Crosley Reado Kit.

BE FIRST IN THE FIELD
Radio Amateurs will soon be exchanging their pictures by radio.

TRADE PICTURES WITH OTHER HAMS

The READO radio printer's kit is complete with all parts precision machined. Full details of construction are furnished. If a Crosley dealer handling this kit is not convenient write

THE CROSLLEY CORPORATION
READO DEPARTMENT POWEL CROSLLEY, Jr., Pres.
110 ARLINGTON STREET CINCINNATI, OHIO

Please send me literature about the Crosley READO, all facsimile broadcasting activities and list of stations now doing experimental broadcasting. Also, the name of my nearest Crosley dealer to carry the Reado Kit.

**USE
THIS
COUPON**

Name _____
Address _____

Correspondence

(Continued from page 53)

CQ hounds (you know the kind: CQ 40 days and 40 notes, no sine), plant 'em all on the high end of 40 (they don't care where they operate, they only send, they never receive) and we kill a whole flock of birds with one QSY.

— Ira A. Williamson, W9RLB

Box 355, Garfield, Wash.

Editor, QST:

Concerning your last "It Seems to Us," I'm with you! I have a peanut roaster that gets S8 and S9 most any time, pushed by an e.c.o. Shall be stopping on 7280 and similar frequencies quite often. Maybe we could organize a nice ragchew net there. . . .

— Ted Patrick, W7FIV

Editor's Note. — QST acknowledges contributions on this subject from a multitude of other correspondents.

For a progress report, see the I.A.R.U. News department in this issue. It worked!

TWO IDEAS

47 Lynwood Ave., Wheeling, W. Va.

Editor, QST:

. . . First, the brothers of this great fraternity have probably read that, during 1939 and possibly extending into 1940, the government will issue special postage stamps commemorating Great Americans. Right there is where a "great idea" began to foment within me! Wouldn't it be a swell boost for our ham radio — and one justly earned — to have one of these new stamps of Hiram Percy Maxim?! And why shouldn't we? A great man; the practical founder of a hobby that has become one of the great industries of the world. Amateur radio was the founder of radio as we know it today. It's the only formally recognized and licensed hobby in the U. S. A. And look at our disaster work! Lots of reasons why our first president should be included as one of the Great Americans. If the idea were gone into tactfully, and firmly, no doubt it could be done. Perhaps W1AW could be the special post office of "first day cancellations"!

The second thing I wanted to put over is this: During my several years as SCM, one sad thing always happens after a disaster. Invariably, the stations doing the good work often don't report to their SCM. And if they do, the report is practically nothing specific — no times, dates, traffic totals, what traffic consisted of, and what was accomplished. Just "we did this, or that, and John Jones, W8XXX was also on, and did a mighty swell job." An SCM is always exasperated, and when his report is in print, these same fellows begin to open up, with a few more facts, stating "QST got the thing bungled." No wonder! In regard to this item, I believe that the A.R.R.L. should in time work out — with the assistance of ORS's/OPS's, RM's, PAM's, SCM's etc. — a definite form, that should be on hand at all times by SCM's and Emergency Coordinators, to be distributed to disaster participants, and to be filled out, and returned to the SCM, for the report. This, then to be returned to A.R.R.L. by the SCM, with the SCM's report. Then the full dope would get to Hartford, and no one would be to blame but the reporting stations. . . .

— C. S. Hoffman, Jr., W8HD

GIVE DEATH A HOLIDAY

Middle Haddam, Conn.

Editor, QST:

I am much interested in the Safety Campaign in QST for several serious reasons. First, I spent nearly 40 years in electrical construction; second, in meeting men who have been shocked and seriously hurt, hearing their tales; third, I have sons who are worth more to me, alive, with all their sass, independence and recklessness. I have a couple of stories which may make some of those careless hams sit up and squirm with terror.

One day while on the job the city inspector came along with a friend, on a tour of inspection. In the course of conversation, the friend said, "Some years ago I worked at the electric game, but gave it up when I got shocked almost to death. I got hung on a high line and when I came to I discovered something was wrong. A crowd was around me talking;

YOUR SUPPLIER HAS

THE *New* PARTS *Catalog*

ISSUED BY UTAH



UTAH SPEAKERS — TRANSFORMERS VIBRATORS and UTAH CARTER PARTS

Hams, dealers, servicemen, in fact everyone connected with receivers or transmitters can benefit by using the new Utah Radio parts catalog. It is packed with important information, from cover to cover.

Ask your supplier to show you his copy.

Use it as a reference book for securing dependable, economical Utah parts.

If your supplier does not have a copy write us direct.

Utah 5, 10, 20 METER KIT \$69⁷⁵ LESS CRYSTAL, METERS AND TUBES

— WITH A COMPLETE BAND-SWITCHING SYSTEM

● Engineered by Utah, it has real power on 5, 10 or 20 meters without resorting to plug-in coils or pruning of condenser capacities. Two separate class "C" Amplifier stages are used with a special low loss ceramic selector switch, which automatically selects the proper tube sequence.

Metering facilities for accurate adjustment, tone control, professionally styled chassis and cabinet, modern dial plates, etc., complete the unit. Furnished in platinum gray wrinkle. Write for schematic diagram and complete information.

Canadian Sales Office: 414 Bay Street, Toronto, Canada

CHECK THESE

Utah FEATURES

1. Complete Band-Switching of circuits "Not coils."
2. Dual independent amplifier stages.
3. Provision for two crystals.
4. 45 watts input C. W. or phone.
5. High gain speech amplifier — modulator.
6. Two complete power supplies with three filters.
7. Steatite insulation — air wound coils.

UTAH RADIO PRODUCTS CO.

CHICAGO, ILLINOIS

CABLE: UTARADIO, CHICAGO

Utah Radio Products Company
822 Orleans Street, Chicago, Illinois

- () My supplier _____ does not have the new Utah catalog. Please send me a copy.
() Send complete information about the Utah 5, 10, 20 meter kit.

Name.....

Address.....

City..... State.....

" . . . now, with the
Verti-Flex, practically
every call I make re-
sults in an answer!"

Theodore P. Lewenberg,
W1HZU
Brookline, Mass.

Here's Why

The Verti-Flex Transmitting-Receiving GIANT ANTENNA is a self-supporting vertical radiator, towering 34 feet into the air, requiring no guy wires or overhead insulators. Micrometer fit joints between sections giving perfect electrical connection and great mechanical strength. Construction allows sway without buckling but prevents rotary oscillation of pole. Light-weight—built of aluminum alloy. Strong ceramic insulator base—almost a foot in diameter. Extra large iron base mounting—either bracket or type illustrated. Verti-Flex GIANT ANTENNAS have withstood 45 m.p.h. gales without damage. Amateurs' special price, complete, \$21.95.

ASK YOUR PARTS JOBBER



VERTI-FLEX DIVISION
2138 N. Racine Ave., Chicago

a doctor was working my arms. They kept at me for four hours. I was conscious all the time, although there was no heart action, lung movement or any other sign of life. Some one said, 'Well, he's dead. He never will come out. Call the undertaker.' When I realized I was to be embalmed and I was alive. I got so frightened I moved an eye. Fortunately someone noticed it and back to work they went. In a little time they had my heart going and I was safe."

That experience is enough to shiver any man, regardless of how tough he might be. People have an idea the doctor knows all about it. Electric shock demands extreme care or someone gets buried alive. A Russian electrician told me that in Russia a shocked man was immediately put in a hole and sand poured around him, whereupon he was left for 24 hours, standing up, with just the head out. Very few were lost.

If it were impressed on the minds of the experimenters what they might suffer from electric shock, particularly to feel someone pumping out the blood from his heart, they might be interested. Also, it might interest those about to sit in the electric chair.

Now for the other story. It happened in a New Hampshire cotton mill, with a 7000-volt arc system, series lamp. A line-man was killed the year before my friend got his. He tried to trim the lamp, with a poor series switch, and he got pretty nearly the full 7000 volts. He was thrown from a 14-foot ladder, came to, and then he saw his body lying on the floor, with a crowd around him. He told me the worst of it was that Joe, who was killed the year before, seemed to appear and say, "Bill, I know just how you feel, but I can't help you a bit."

You won't accept the last story, as it is against all theology, which knows all about it, but death is not to be sneezed at. Neither is a quick death likely to prove such a boon as some of us would like to think. It has to be faced alone and no matter how much your parents want to help, they must stand by. At death the only busy man is the undertaker. Expensive twins: the ham and the undertaker. Some of your musical friends might write a musical comedy featuring it.

— R. Lowenhaupt

HE KNOWS WHAT A.R.R.L. HAS DONE

100 Brookline Ave., Boston, Mass.

Editor, *QST*:

I was first disgusted but then enjoyed a hearty chuckle at the wild ravings of one of your contributors in the issue of May, signing himself "Beer Baron Frazier."

When and if this man ever consumes as much beer as I have he'll learn that with a beer upset liver he should not attempt letter writing. I wouldn't severely censure the guy because he will be sufficiently punished when he sobers up and sees what he was stupid enough to put onto paper.

I've been actively interested in commercial and amateur radio ever since the days of 1920 when Bill Halligan and I useta run the Commonwealth Radio Association in Boston. Bill progressed to the point where he now provides us operators with excellent equipment. I was then — and probably always will be — just an operator.

But enough of an operator so that I know that but for the good offices of the A.R.R.L. gang I'd whack dots and dashes only on commercial frequencies. It grieves me that more of these operators, especially the newcomers, cannot realize that *there'd be no amateur radio but for the A.R.R.L.* If my word isn't good enough ask any real old time operator. We remember 1917! We *know* what A.R.R.L. has done for us!

— Ted McElroy, W1JYN

A MISSIVE FOR DIXIE JONES

5923 Pulaski Ave., Germantown, Philadelphia, Pa.

Editor, *QST*:

Please forward the following letter to Dixie Jones:

"Dear Dixie:

"Dad gum these yere DX boys which is aller time hoppin' flipperty flop round the twenty-meter band with ther e.e. rubber ossylaters. Jest about every time I find me a nice FDS or a juicy PK, dern um if one uv the neighborhood hounds dont up'n set rite toppuv um, half time callin' um afore he even signs. Waal, thats orrite, I gess, cause thats what these rubber ossylaters er made fer, but why dont sum-buddy tell these boys at ther s'posed to flipperty flop toppuv the boy the furniner's wurkin', steadyv blanketin' the furniner with long calls 'n' not even waitin' fer um to sign. An'

**GET STARTED
ON TELEVISION!**

*With the
Meissner*
**TELEVISION
KIT!**

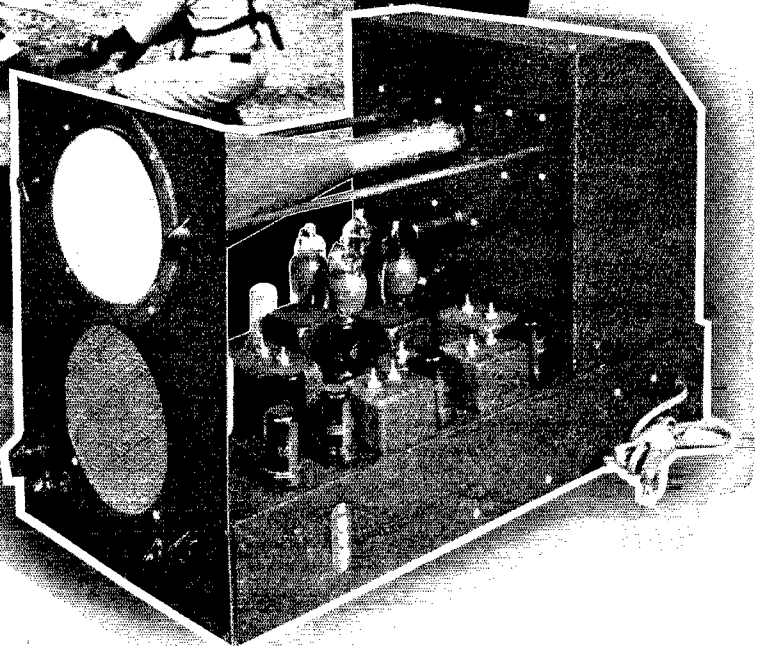

● For years, Meissner has worked with Television, just to be prepared when real Television arrived. It's here now, and Meissner is ready with a practical Television Kit, built with traditional Meissner quality and available at a moderate price, just the thing to get you started in this exciting new field of radio. See the Meissner Television Kit at your jobber's today or mail the coupon for complete information

- *Sound and Video—both in one unit!*
- *New SHOCK PROOF design.*
- *5-inch Tube.*
- *Walnut cabinet available at slight additional cost.*
- *Meissner quality throughout at a price you can afford to pay.*

See Your Jobber or Mail Coupon for Complete Details

Meissner
Dept. Q-6, Mt. Carmel, Ill.

MAIL COUPON NOW

MEISSNER MANUFACTURING CO.
Dept. Q-6 Mt. Carmel, Illinois
Please send me complete details on Meissner
Television Kit.

Name.....

Address.....

City.....State.....

"A FAMOUS NAME FOR TWO DECADES"

HERE'S THE ANSWER

● To the frequency checking problem—that every amateur can afford. Our new type 100 KX Secondary Crystal Standard sets a new high in performance, at a new low price. A circuit development that enables us to generate usable harmonics at 100 kc intervals, all the way to 60 mc in a single tube, is one outstanding feature. Better still, the remarkably low plate voltage requirements of the circuit, enable us to employ “transformerless” construction so that we can include the power supply in the tiny box which occupies only 16 square inches of space on the operating table. One of the new low drain dual purpose tubes type 70L7GT, (rectifier-beam power tube) takes care of the tube requirements in a single small envelope. The unique adjustable air gap holder in which the low drift 100 kilocycle bar is mounted, enables the operator to zero beat the standard against WWV or other marker stations. Last but not least, with the heat producing parts out in the open, and all other circuit elements enclosed, frequency stability within a few cycles over long periods is assured.



Providing frequency stability of the same order as that used by ARRL Official Observers, the 100 KX standard enables you to accomplish four things. First, to comply with the FCC ruling on frequency checking. Second, to observe and warn fellow amateurs against off frequency operation. Third, to insure the operation of your own station within the band. Fourth, it permits you to work as close to the band as it is safe for any amateur to do.

Setting a new standard of accuracy in the field of frequency measuring devices for amateurs, the 100 KX Standard also brings the cost of frequency checking within the reach of every amateur. Your Dealer has it for you at **\$15.00** net.

If we are wrong, send us his name and the amount above and we will ship prepaid anywhere in the USA.

Our custom built ADX pre-selector is ready. Described on page 30 of May QST. In operation (p. 14), some confirmation (p. 41), some information (p. 71). Designed for Ham DXers only—it sells at \$43.00 ready to go on 5, 10 and 20.

“Just ask the man who owns one”

COMMUNICATIONS MEASUREMENTS LABORATORY

Telephone Whitehall 4-7275

136 LIBERTY STREET NEW YORK

why dont sumbuddy tellum about short calls gettin' more cumbacks, an' tellum notta dipperty ther rigs toppuv ya er the furriner while ther still wurkin' ya, er sumpin' Dad gummum, it aint right!

“What er we gonna do with um, Dixie? The retty-snitich is too gud fer um. Let's burnum in condenser oil.

“I caint even get up a 73 I'm so durn mad.

“Yore DX-huntin' pal,

“GRANDPA SNAZZY”
— Ed Meehan, W3FPW

MAN BITES DOG

29 Bank St., North Adams, Mass.

Editor, QST:

While working a W8 on 160 'phone the other night, chewing over the BCL interference problem and commenting very thoroughly and disgustingly on the cheap BCL receivers that are giving so much trouble, I was not surprised to receive a telephone call.

Imagine my amazement, however, when a gentleman informed me that he had one of those cheap receivers he heard me talking about and if it was bothering me he would gladly stop receiving while I was on the air.

If you can beat that one, let me know! . . .

— H. R. Darling, W1FZI

HARMONICS ARE TABOO

219 E. Carroll St., Macomb, Ill.

Editor, QST:

Since when has an amateur 'phone band been created in the area 7000 to 8000 kc?

Almost any hour I am able to log from 10 to 15 so-called 80-meter 'phones, in the area above. I have always thought harmonics were taboo. It seems to us inviting real trouble from the airlines and government.

— R. Arrowsmith, W9ABS

Splatter

(Continued from page 10)

FEEDBACK

Fig. 1, p. 49, March QST

The grid return of the HY-61 should be connected to ground instead of directly to cathode.

— . . . —

Fig. 1, p. 58, May QST

The center-tap connection of T_2 secondary should be connected to the common ground.

— . . . —

Fig. 1, p. 25, May QST

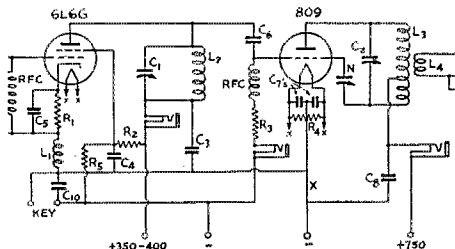

For oscillator-negative and amplifier grid-block keying, the wiring should be as shown in this corrected diagram. If only one power supply is available, connect the two negative terminals together and insert another C_{10} at “x,” for oscillator-negative and amplifier center-tap keying.

SPEER GRAPHITE ANODES

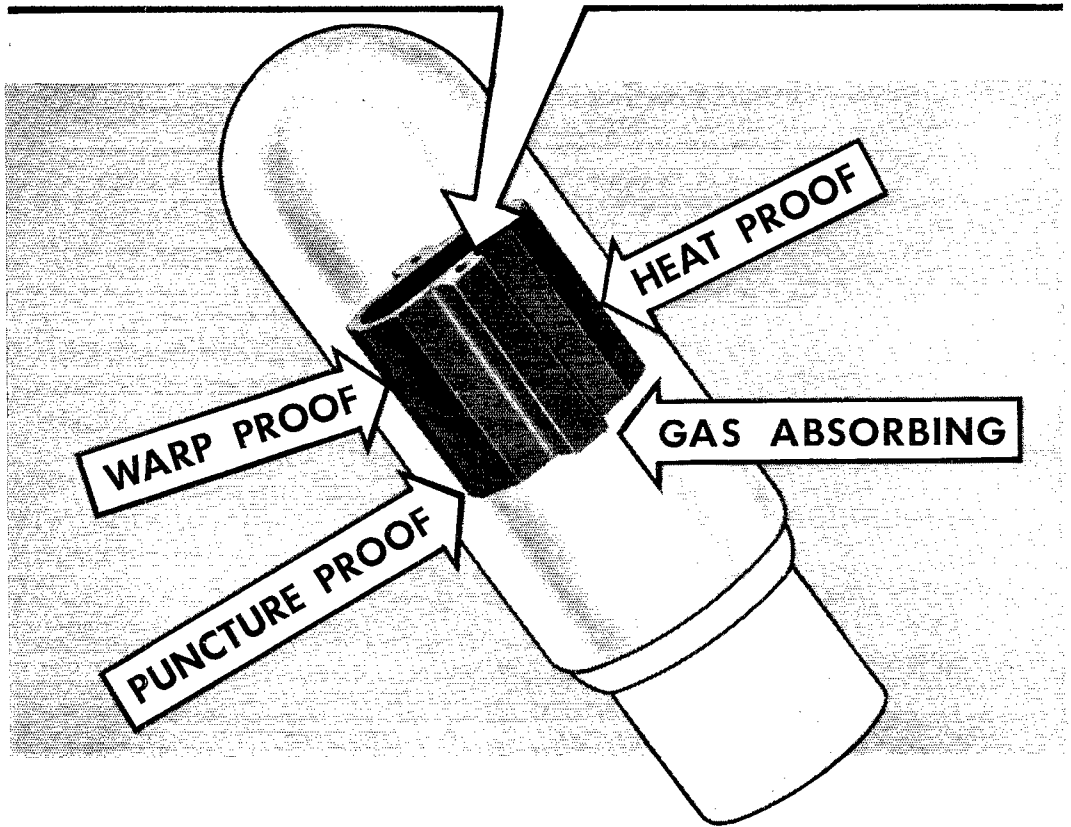

Why Be Satisfied With Less?

Why be satisfied with anything less than certainty that the anodes in your tubes cannot be damaged by overloading; will not warp, fuse, blow out or soften; emit no gas and absorb gases given off by other tube elements? Why be satisfied with less when you can have all these advantages with tubes having SPEER Graphite Anodes?

**No other anode materials in use
have all these characteristics.**

SPEER Graphite Anodes are sold only to tube manufacturers. Write for a list and Anode Booklet No. 80.



SPEER CARBON COMPANY

ST. MARYS, PA.

CHICAGO CLEVELAND DETROIT MILWAUKEE NEW YORK PITTSBURGH

9148

New . . .
**ANTENNA
 RELAYS**
 by
Guardian



**PRICES
 TAKE A
 POWER DIVE!**

Good news . . . startling news . . . so good you might even become skeptical. But it's true . . . Guardian answers the amateurs need with these low-priced A-100 Antenna Relays. Tested under actual operating conditions these new A-100 Antenna Relays by Guardian have proved themselves capable of handling any power up to a K.W. on any frequency up to and including 28 M.C. on A.F. or R.F. circuits. These A-100 Antenna Relays by Guardian give you more for less.

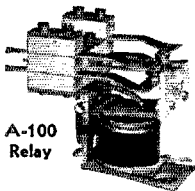

A-100
 Relay

Standard A-100 and A-100-C Antenna Relays AISiMag insulated Operate on 100 V. — 60 cycle A.C.

LIST PRICES:

- A-100 Double Pole Double Throw **\$5.95**
- A-100-C Single Pole Double Throw **\$3.30**
- R-100-G Triple-X Insulated **\$5.00**

Write for New Bulletin and Circuit Diagrams Now!

GUARDIAN



ELECTRIC

1626 W. WALNUT ST.

CHICAGO, ILL.

stopped — still no sign of life. The last W6 was now pressing out his call, forming a duet with W6 clunk clunk who had again resumed normal testing — just testing. With both feet the W6 pressed out his own call, causing the dots to be slightly heavy, and he, too, stopped and waited. Still 14,405 kc. remained as silent as the day after the SS Contest. Then suddenly crept into the ears of these 25 men, good and true (and also Abner's) a high-pitched buzzing like that of a mosquito with poor regulation. It was none other than our DX STATION coming back, having changed his frequency a wee bit. He was now operating on 14,413 kc. more or less on his own authority. Twenty-five dials at once took up the chase, and even Abner expertly swung his dial around to 90.378 to receive better the all-important words. A combination of snorts and back-firing sounding much like QRZ? greeted his ears, followed by the call, but try as he might (and you may be sure that he did try as he might), he could not quite make out the call.

Blissful silence once more heralded a new outburst; once more 25 men, good and true, pumped forth their pleas that he pass the time of day or night with them. Bursting upon his searching brain like an overripe tomato came the answer. Why not listen to these good operators and find out who they were calling? There was the solution! Then he could add his 6L6G to the competition! True — it was on 14,308 kc., but did not dear old QST bewail the fact that the band edges were too crowded, and might not this beloved soul from distant isle tune down into the band? Abner was going to steal a QSO out from underneath the noses of these pompous rulers of the ether — these DX hounds who sent in long lists of lies to the DX Notes Dept!

Feverishly Abner swished his dial back to 89.9999 where history was in the making. He turned up his concentrator to the last notch, and still there were ten stations on the same spot. Was success to elude him after all this?? NO!! (Not if I can help it. — АУТНОК.) (The author gives expression to his personal opinions which may be at variance with the editorial policies of this magazine. — Ed.) (I think so too. — W8CRA.)

“Zounds! This can't be!” moaned Abner, grinding his teeth down another ¼ inch. “What will the gang at the club say if I can't work at least one DX STATION?”

Fate was kind to our opr., however. One by two the pleadings ceased, and now he began to hear individual dots and dashes struggling through the QRM. Slowly the din subsided, and finally only two signals remained. One had a familiar sound — NST having once more made its appearance thanks to another fuse. (1¢ piece, this time.) “Must be W6 clunk clunk!\$%#!” thunk Abner. “I'll try the other one.”

No sooner said than done, and just in time too, for the famous DX man, renowned for his snappy operating, was almost finished. “IM4U de W9 zip zip ar k.” The tenseness was terrific — even

The RADIO SHACK

HAMMARLUND HQ-120

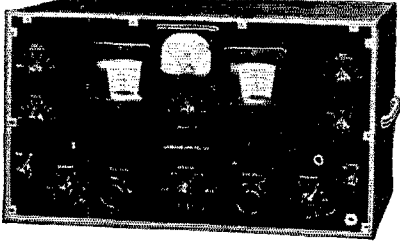

★ Variable crystal filter ★ Regulated power supply
★ Calibrated band spread.
Cash Price..... **\$129.00**
or \$24.00 down and \$9.47 per month
for twelve months.

HALLICRAFTER HT-6 TRANSMITTER

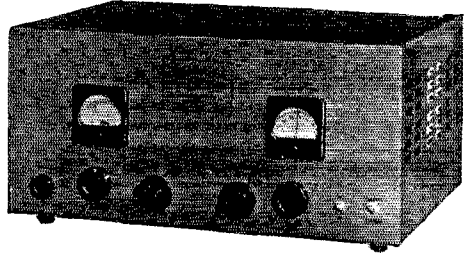

★ Output 25 watts ★ Coverage 1.7 to 60 mc. ★ Band-changing
switch ★ Phone or cw.
Cash Price less coils and crystal..... **\$99.00**
or \$19.80 down and \$7.22 per month for twelve
months.

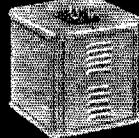
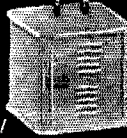
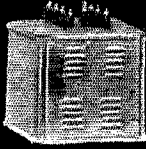

FILAMENT TRANSFORMER

No.	V. CT.	Cur.	Net
S-53	2.5	10 A	\$1.32
S-54	5	4 A	1.32
S-55	6.3	3 A	1.32
S-56	7.5	3 A	1.32
S-57	2.5	10 A	1.76
S-58	2.5	20 A	2.35
S-61	7.5	8 A	
	6.3		2.06
S-62	10	10 A	2.35

PLATE TRANSFORMERS

No.	DC Volts	M.A.	Net
S-44	470/430	300	\$5.59
S-45	750/620	200	3.82
S-46	825/600	300	5.89
S-47	1275/1050/825	300	7.06
S-48	1300/1075/850	500	11.47
S-49	1815/1540/1275	300	10.58
S-50	2625/2175	300	12.64

FILTER AND SWINGING CHOKES

No.	Ind.	Ma.	Net
S-29	10	175	\$1.62
S-30	5/25	175	1.62
S-31	20	225	2.06
S-32	5/25	225	2.06
S-33	20	300	2.94
S-34	5/25	300	2.94
S-35	20	400	3.82
S-36	5/25	400	3.82
S-37	20	550	5.29
S-38	5/25	550	5.29

UNIVERSAL MODULATION TRANSFORMER

No.	Audio Watts	Net
S-18	12	\$2.06
S-19	30	2.31
S-20	55	3.82
S-21	110	5.88
S-22	250	8.23

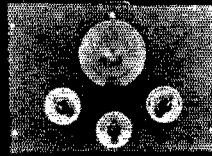
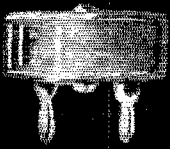

X-CUT 40-METER MOUNTED CRYSTAL

7000 to 7200 KC
Supplied within 10 KC of your
desired frequency.
SPECIAL NET PRICE **\$1.95**

HEAVY DUTY TRANSMITTING CHOKES

Inductance 2.1 mh. Current
rating 500 ma.
SPECIAL NET PRICE... **49c**

BROWNING PRESELECTOR

★ Calibrated dial, 62 mc. to 1.6
mc. Complete Pre-Selector less
1852 tube.
NET PRICE..... **\$16.50**
\$1.85 extra for 1852 tube

TRANSMITTING CONDENSER

2 mfd., 2,000 volt
SPECIAL
NET PRICE..... **\$1.49**

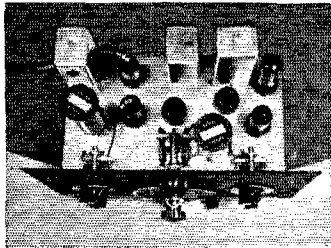

KIT OF PARTS FOR THE OST REGENERATIVE SINGLE-SIGNAL SUPER DESCRIBED IN OCTOBER '38 OST BY GEORGE GRAMMER

All parts as specified, and of nationally advertised manufacturers.
Complete kit less tubes and power supply. NET PRICE..... **\$19.56**
Kit of 6 Raytheon tubes for above kit. NET PRICE..... **\$4.49**
Crackle finish hinged top cabinet supplied at \$1.95 extra.

EXPORT DIVISION
9 Cornhill St., Boston, Mass., U. S. A.

MAIL
ORDERS
PROMPTLY FILLED

Write for FREE
72-page Catalog

BUY ON
EASY TERMS

46 BRATTLE ST. - BOSTON, MASS. - U.S.A.

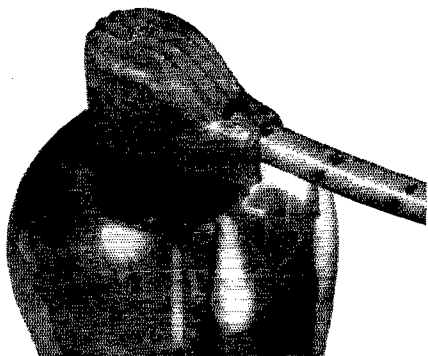

SAFETY PLATE GRIP

The Type SPG Safety Plate Grip is of molded R-39 and is an important aid to safety when using 866's or other tubes having 9/16" diameter caps. The conductor opening is large enough to receive high tension (spark plug) cable, but an insulated bushing is supplied for smaller wire. Its low loss construction makes it suitable for use with high voltage transmitting tubes, such as the 806. Type SPG, Net Price \$.21 each.

National Company, Inc., Malden, Mass.

IN THE construction of transmitters from oscillator to final amplifier, metal fabrication plays an important part, both from the point of view of efficiency and appearance. Competition being what it is among hams, the time when "any-old-thing-will-do" is just a memory.

Today, chassis, cabinets, and panels, like those made by PAR-METAL, have reached such perfection in manufacture that you, as a progressive amateur, should investigate their wide application.

Finished in gray or black ripple, rounded corners, chrome trim, their living-room appearance has brought the boys "out of the basement."

Keep up with the times and send today for our new 1939 Catalog showing the many combinations possible with our products. It's well worth the trouble.

PAR-METAL PRODUCTS CORP.

3521-41st St., LONG ISLAND CITY, N. Y.

Hollywood would have applauded. Would W9 zip zip be the lucky man? Would he proudly list IM4U in his voluminous report to QST??

With an expertness born of experience, Abner swung the sniggle sniffer up about 5 kc. beyond the last inhabited spot and eagerly awaited the fateful words. Seconds passed, and W9 zip zip fidgeted somewhere in W9 land. An exploratory burp was suddenly followed by a dawdidawdidawwwwww. Twenty-five men and Abner awaited his selection—who would it be?? Another dawdidawdidawwwwww rent the midnight air, followed closely by a third and fourth as afterthoughts. Then silence, broken only by a querulous W3 whose e.c.o. had momentarily gone on a vacation. A diathermy approached, and after tarrying for a brief stay to see that all was well, went on patrolling the band. Dreadful, unexplained silence again came in S9, like the high end of 10 meters. Had something gone wrong? Had the operator been attacked by cannibals or even BCL's?

The cycle clippers were uncertain as to what to do, and W6 clunk clunk nonchalantly began a leisurely CQ, but Abner, ever quick to meet such emergencies, dove for the key. Bravely ignoring the loud protests from the sniggle sniffer which was being forced to swallow bodily large chunks

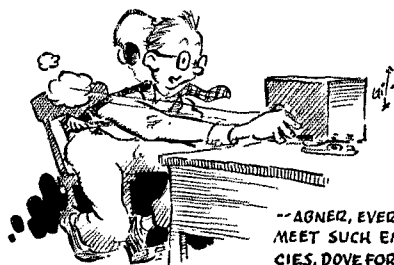

of r.f., he painfully spelled out the fateful call—IM4U IM4U IM4U. Not taking any chances on being passed over, our opr. called for a good five minutes just to make sure, signing frequently every minute. Taking particular care, and with great emphasis, he ground forth his own cherished call seven times, and as an afterthought tacked on a BK. Clicks and roars suddenly ceased, and ears returned to normal. The fateful hour was at hand. Would snappy operating and alertness be rewarded? Would his long perseverance and careful study of the subject bring its own compensation? Would the gods of radio at last see fit to present him with a DX contact from a far-off izzle? Would they?? (Just wait and see!)

A second, and then two or three more, passed into eternity. Had IM4U been gobbled alive by the BCL's, or more humanely cooked by the cannibals? But wait—a sound!! He is NOT lost! Something may happen yet!!!

Dawdidawdidawwwwww. Silence. A noise similar to clearing one's throat. More silence. Dawdidawdidawwwwww. "W"—Abner's heart runs up to 10 kc. per second. "W6 clunk clunk de IM4U. Sure glad u called CQ. Band dead hr. Ok QSL. 73 de IM4U. Diddledidawdidawwwwww."

THE AMATEUR'S BOOKSHELF

A balanced selection of good technical books, additional to the A.R.R.L. publications, should be on every amateur's bookshelf. We have arranged, for the convenience of our readers, to handle through the A.R.R.L. Book Department those works which we believe to be most useful. Make your selection from the following, add to it from time to time and acquire the habit of study for improvement. *Prices quoted include postage.* Please remit with order.

RADIO THEORY AND ENGINEERING

FUNDAMENTALS OF RADIO, *Second Edition*, by R. R. Ramsey. A modernized revision of the author's work which has been a favorite with amateurs and experimenters since 1929. 426 pages, 439 illustrations. 2nd Edition, 1935. \$3.50

RADIO ENGINEERING, by F. E. Terman. A comprehensive treatment covering all phases of radio communication. An all around book for students and engineers, 811 pp., 474 illustrations. 2nd Edition, 1937. \$5.50

ELEMENTS OF RADIO COMMUNICATION, by Prof. J. H. Mowcroft. This is the 2nd edition of this book by the author of the well-known "Principles." It is about half the size of the larger work, and the subject is treated in more elementary fashion. Simple algebra is sufficient. An excellent book for the "first-year" student. 279 pp., 170 illustrations, 1934. \$3.00

PRINCIPLES OF RADIO, by Keith Henney. This book is chock-full of meat for the experimenter. The subjects treated range from the fundamentals of electricity to the modern concepts of modulation and detection. 477 pp., 306 illustrations. 2nd Edition, 1934. \$3.50

COMMUNICATION ENGINEERING, by W. L. Everitt. A general text for both first year and advanced courses. Complete treatment of network theory, including mathematical analysis of radio circuits and tube operation. 727 pp., 411 illustrations. 2nd Edition, 1937. \$5.00

PRINCIPLES OF RADIO ENGINEERING, by R. S. Glasgow. Mathematical presentation of the fundamentals of radio communication and their application. A large portion of the book is devoted to the theory and use of the vacuum tube in communication systems. 520 pp., 6 x 9. 1936. \$4.00

FUNDAMENTALS OF VACUUM TUBES, by Austin V. Eastman. Treats the laws underlying operation of the principal types of tubes—high-vacuum, mercury-vapor, photo and special tubes—with engineering analysis of their more important applications. 438 pages, 6 x 9. 1937. \$4.00

FUNDAMENTALS OF RADIO, by F. E. Terman. An elementary version of the author's "Radio Engineering," with simplified treatment and intended for readers of limited mathematical ability. Suitable as a text for an introductory course in radio, and features problems for class-room work. 458 pages, 278 illustrations, 1938. \$3.75

ELECTRON OPTICS IN TELEVISION, by I. G. Natoff and D. W. Epslein. Covers the theory of electron optics and practical design problems in constructing cathode-ray tubes for television work. An introductory section outlines the principles of cathode-ray television. 299 pages, 197 illustrations, 1938. \$3.50

ELECTRICAL ENGINEERS' HANDBOOK, VOL. V, ELECTRIC COMMUNICATION AND ELECTRONICS, edited by H. Pender and K. McIlwain. A comprehensive handbook covering the field of communication, both wire and radio, and electronics. 1022 pages, 3rd edition, 1936. \$5.00

RADIO EXPERIMENTS AND MEASUREMENTS

MEASUREMENTS IN RADIO ENGINEERING, by F. E. Terman. A comprehensive engineering discussion of the measurement problems encountered in engineering practice, with emphasis on basic principles rather than on methods in detail. 400 pages, including an appendix of outlines for laboratory experiments and a comprehensive index. 210 illustrations, 1935. \$4.00

THE CATHODE-RAY TUBE AT WORK, by John F. Rider. Devoted to cathode-ray tube theory, sweep circuits, a.c. wave patterns and description of commercial oscilloscope units including actual photographs of screen patterns representing about every condition likely to be encountered in audio- and radio-frequency amplifiers, power supplies, complete receivers and transmitters. 322 pages, 444 illustrations. \$2.50

HIGH-FREQUENCY MEASUREMENTS, by August Hund. A thorough, modern book, especially useful in advanced laboratory work. Includes a chapter on piezo-electric determinations. 491 pp., 373 illustrations, 1933. \$5.00

EXPERIMENTAL RADIO ENGINEERING, by Prof. J. H. Mowcroft. An excellent laboratory text directed specifically to emphasizing the principles involved in the operation of radio apparatus and intended as a companion to the same author's "Principles." Following an introductory chapter on instruments and accessories. 51 choice experiments are outlined. 345 pp., 250 illustrations, 1935. \$3.50

EXPERIMENTAL RADIO, by Prof. R. R. Ramsey. Fourth Edition. A splendid book for the experimenter. This is a laboratory manual, describing 132 excellent experiments designed to bring out the principles of radio theory, instruments and measurements. 167 illustrations, 196 pp., 5 1/4 x 7. 1937. \$2.75

RADIO FREQUENCY ELECTRICAL MEASUREMENTS, by H. A. Brown. A laboratory course in r.f. measurements for communications students. Contains much practical information on methods of measurement. 384 pages, 177 illustrations, 1938. \$4.00

COMMERCIAL EQUIPMENT AND OPERATING

PRACTICAL RADIO COMMUNICATION, by A. R. Nilson and J. L. Hornung. A new modern treatment meeting the expanded scope of today's technical requirements in the various commercial fields. The first six chapters are devoted to principles, the remaining nine to latest practice in broadcasting, police system, aviation radio and marine communication. 754 pages, including an appendix of tabulated data and a complete topical index. 434 illustrations, 1935. \$5.00

THE RADIO MANUAL, by George E. Sterling. Another excellent practical handbook, especially valuable to the commercial and broadcast operator, and covering the principles, methods and apparatus of all phases of radio activity. Over 900 pp., 1938. \$6.00

RADIO TRAFFIC MANUAL AND OPERATING REGULATIONS, by Duncan and Drew. A book for students, amateurs or radio operators who contemplate entering the commercial field; it will enable you to learn quickly and easily all the government and commercial traffic rules and operating regulations. 181 pp. \$2.00

RADIO OPERATING QUESTIONS AND ANSWERS, by Nilson and Hornung. A companion volume to "Practical Radio Telegraphy" by the same authors. The latest Revised Edition is very complete, covering Commercial and Broadcasting, Amateur, Aeronautical and Police Radio, Beacons, Airways, Meteorology, and Teletype Operating. 389 pp. 5 1/4 x 8. 1935. \$2.50

HOW TO PASS RADIO LICENSE EXAMINATIONS, by Charles H. Drew. Question and answer material on various types of commercial operator examinations. The commercial equivalent of the A.R.R.L. License Manual. 201 pages, 73 illustrations, 1938. \$2.00

RADIO OPERATOR'S MANUAL, by the Radio Dept. G. E. Co. Primarily a manual to qualify an applicant for the radiotelephone classes of license (including police), but also provides material of general interest to users of commercial radio equipment. 181 pages, 56 illustrations, 1938. \$1.00

MISCELLANEOUS

THE RADIO AMATEUR CALL BOOK. Lists all U. S. and foreign amateur radio stations, s.w. commercials and broadcasters. \$1.25 (Foreign \$1.35)

MAKING A LIVING IN RADIO, by Zeh Bouck. 222 pages, 25 illustrations. A worth-while book for the radio amateur who is considering entering the Commercial Radio field in its many branches; explodes the bunk, points out the pitfalls. \$2.00

RADIO DATA CHARTS, by R. T. Beatty. A series of graphic charts for solving, without the use of mathematics, most of the problems involved in receiver design. 82 pp., 8 1/4 x 11. \$1.50

SERVICING RECEIVERS BY MEANS OF RESISTANCE MEASUREMENTS, by J. F. Rider. 203 pp., 94 illustrations. An excellent book for the service man and amateur constructor. \$1.00

SERVICING SUPERHETERODYNES, by John F. Rider. Theory and practice of superheterodynes, with adjustment and troubleshooting data. 278 pages, 94 illustrations. \$1.00

The following books published by the American Radio Relay League, *The Radio Amateur's Handbook*, *The License Manual*, *Hints & Kinks*, *How to Become a Radio Amateur*, *200 Meters and Down*, *Building an Amateur Radiotelephone Transmitter*, and of course *QST*, comprise the foundation of every Amateur library.

AMERICAN RADIO RELAY LEAGUE, INC., WEST HARTFORD, CONNECTICUT

Station Activities



ROANOKE DIVISION

NORTH CAROLINA — SCM, W. J. Wortman, W4CYB — We are very anxious to build up our emergency organization in this Section. Drop a card to the S.C.M. for full particulars. DOT and ATC were on exhibition at the State College Engineers Fair; DOT won a prize. FWT is ham at State, 9BWQ, ex-4CDD, visited his folks in Raleigh. BRT has a schedule with him. BNL is working with a self-powered, portable outfit. DW has been on 3.9-Mc. 'phone. In Chapel Hill, WE, the club station is on 3.5 Mc.; DWB seems to be the Chief Operator. FXU is new ham at Carolina. BHR uses two rigs, a 100TH and a pair of 807's P.P. DCQ returned to Winston-Salem from New Jersey; he is on 3.9-Mc. 'phone. DGY is chewing the rag. EYA is putting up a 14-Mc. rotary. AAK is going to 14 Mc. with a new "Q." BV has resettled in Statesville after sojourn in New York. DGU is working 14 and 3.9 Mc. The Asheville Club reporter says that GW schedules CO2LY. TO is still DX'ing. ECW is operating AHY at Duke Univ. EJ is increasing power. HS has started rebuilding. EFX is on 14-Mc. 'phone with an 807. KI has practically deserted 3.9 for 28 Mc. CRW gets out better with low power than with the big rig! FSO is on 3.5 Mc. with a 6L6. 5HS was recent visitor in Asheville. CO2LY will be in Asheville in June. 5FIY, ex-4DPI, expects to be at the big hamfest in July. A reminder — Look at the dates on your certificates and send them in to get your appointments renewed. Don't forget the big hamfest at Asheville July second. Let's "mow 'em down."

Traffic: W4DLX 64 BRT 17 BHR 7 MR 5 CYB 4 DGU 2 BV 1.

SOUTH CAROLINA — SCM, Ted Ferguson, W4BQE — EXJ keeps regular schedules with FOL. CQG works plenty DX with new beams. EPJ and the 3.9-Mc. 'phone Net are doing FB. BRF returned to Blakley, Ga.; enjoyed having you in this Section. OM. COL changed QTH to Greenwood. FFH reports that the fellows had nice time at Savannah hamfest. BNN has new 500-watt rig. EHF had nice trip to Ohio. DRE will have new rig on soon. **FELLOWS OF THE OFFICIAL GROUP: THIS IS THE LAST WARNING. ANY OFFICIAL STATION THAT FAILS TO REPORT FROM NOW ON WILL BE CANCELLED. LET'S HAVE THE REPORTS ON THE 16TH 73.**

Traffic: W4BRF 57 FFH 22 CQU 21 EPJ 10 CUS 8 BNN 7 DPN 6 EXJ 5.

VIRGINIA — SCM, Charles M. Waff, Jr., W3UVA — R.M.'s: GTS, HDQ — P.A.M.'s: AJJ, GWQ — GKL is on 1.75-Mc. 'phone. GWQ is completing a 30-watt portable 'phone-c.w. rig. FHF is interested in becoming an E.C. So is GSV. All interested in the Emergency Coordinator appointment write the SCM. GGI reports the Peninsular Amateur Radio Club building a 100-watt, 1.75-Mc. 'phone. AKN, IOZ and IQ being in charge. The club call is ESR. HDP will have 250 watts digging a hole after some DX on 14 Mc. GRV has a band switch for 28, 14, 7 and 3.5 Mc. and a V-beam antenna. EMA added CR4MM to bring his countries worked total to 100 even. BWA is using 300 watts on 1.75-Mc. 'phone. ELN uses 3800 and 7290 kc. HNV uses 3572 kc. BFW is 70 per cent rebuilt. HEZ schedules RR and 9SRE. EZH would like to organize a traffic net on 7 Mc. All interested write him. He already has connection with K5, K6, K7 and K4. HAE reports the young squirts of Norfolk organizing a new club there. Good luck! GTS is using 400 watts into a pair of 860's. AKN is holding down a bunch of FB schedules. HEZ wants to become O.R.S. GGI, HLC, GGP, EFO, HZU, EAI, HRC, HGK and HPH are members of the "Sewing Circle" Net. ENQ is working in Roanoke temporarily. HBF is putting up a three-element rotary beam. BSW is getting new receiver. APT is installing two 8JK beams at right angles. HTY, ex-9TTD is now at Richmond. APU uses 1925 kc. EZL expects to have a "2 1/4-meter" rig going soon from the Skyland Drive. If you plan on building a "2 1/4-meter" rig, write EZL. II reports the Tidewater Emergency Communications Net put on a full-dress rehearsal for the Polygon Club at Portsmouth and will repeat for Hampton Roads Engineers Club soon. II was N.C.S. at former. NT will be at latter. HAE operated

FQP's rig recently. HDP uses 7169 kc. UVA worked 6USA at the Calif. World's Fair. DBW, ex-2AYZ and ex-1FLD, is pounding brass for Eastern Air Lines at Washington. HDQ announces the debut of the VIRGINIA TRAFFIC NET with HDQ, HAE, DGB, EIN, KR, EUG, HBS and AKN as members. Write HDQ to join this important net. The largest hamfest in Virginia's history was held at Richmond April 2nd with 130 present. The next FLOATING CLUB meeting will be held in the vicinity of Norfolk the first of June.

Traffic: W3HDQ 346 ELN 232 GTS 186 AKN 34 HEZ 28 EZH 25 HAE 21 EZL-II 6 GKL 5 HOY-UVA 2 (Feb.-Mar. HAE 4).

WEST VIRGINIA — SCM, C. S. Hoffmann, Jr., W8HD — New O.B.S., CFB, will send the latest A.R.R.L. news daily at 7 P.M., 3535 kc.; 8 P.M., 3595 kc.; 9 P.M., 3700 kc.; using 350-watts input. QSL when you hear him. SES is new O.P.S. He handled 172 messages for Western Union during February flood; all concerned flood relief work, deaths, illness and transfer of money by flood victims. SES was assisted by LNR and LLI, all members of the new Dunbar Amateur Radio Club. SNO, a police officer, is organizing a 1.75-Mc. Net for police-hams. New Dunbar Club officers: LNR, pres.; Buddy Morris, vice-pres.; Howard Morris, treas.; SES, secy. It is 100 per cent A.R.R.L.-membership. OXO (RM), GBF, MKE and NEU have emergency rigs ready on 3770 and 3700 kc. in case of flood, etc. FB, OM's. Has the 3.5-Mc. gang been listening in on 3770 kc. recently? Grind your rock down there, and have some fun! MOP and WK are active on 3.5 Mc. SDU is on 56 Mc. New hams: THG, Wheeling; TBG, Charleston. LCN was heard by G2PL and a G-S.W.L. on 1.75 Mc. BTV on 3.5 Mc., with 90-watts input worked ON4AU, OZ3Q, ON4HC, VP55P, D4TFU, PA0SS, HA9U, K6CGK, VO6M, and heard all continents! JKN has worked 57 countries. SUW worked VK3QB and YV4AX on 7 Mc. PQQ worked: PJ1BV, F18AC, VQ2PL, CR7AY, YN3OG, VS6AO, VS2AE, J8CG, G8OK, VK9BW and a flock of 'J's and XU's.

Traffic: W8SES 172 BTW 58 OXO 31 MOL 11 PSR 9 SUW 3 BWK 2.

HUDSON DIVISION

EASTERN NEW YORK — SCM, Robert E. Haight, W2LU — KXF reports FB schedules on 3585 and 3742 kc. KWG's new rig is 175-watts input, 814 final. April storm brought down LU's mast after 3 years in the air. HCM is using P.P. T55's. HXQ is chairman of Reception and Entertainment Committee at World's Fair Club. On behalf of committee, HXQ wants to extend the clubs' welcome to all amateurs. EOA and HXQ rebroadcast club's weekly QST each Fri. night on 3950 and 41220 kc. LEL is organizing emergency net, with help of 8ADY, IPI and 1AJ on 7 Mc. LSD is active on 7 Mc. HVR reports for Westchester boys; "2 1/4-meter" activity is going strong with many of the boys. FQG is new pres. of Troy Radio Club; GTG, vice-pres.; HOA, treas.; Gene Connor, secy. KQO finished his all-band exciter. IUW got his call back and will open with 1.75-Mc. 'phone. KPI gets out nicely with 3 watts on 1.75-Mc. 'phone. 1LAS has things set for "2 1/4" with FBB, FAR, HVR, KSV, LQN, KRF and LEV are getting ready. Westchester Club is sponsoring "2 1/4-meter" transmitter hunt. EOA completed new kw. rig with pair of RK63's. EOA requests amateurs in Westchester County to get in touch with him to aid in emergency roundup. ACB and his E.C.-assts. are doing a fine job lining up for June Field Day. KUD told members of the Lion Club how amateur radio works. KFB is using FTG, New Rochelle High School rig, on 1.75-Mc. 'phone. LLU gets out well on 3580 kc. RJJ reports local boys enjoy Sunday a.m. round table QSO on 28-Mc. 'phone. AGZ did fine job building portable transmitter for Albany to N. Y. boat races. CDM is still knocking off DX on 14 Mc. AEQ is moving out in the wide open spaces for more antenna room. LQM visited the S.C.M.

Traffic: W2KNF 63 KWG 55 LU 25 HCM-HXQ 22 LEL 17 LSD 11 HVR 2 FQG 1.

NEW YORK CITY & LONG ISLAND — SCM, Ed. L. Baunach, W2AZV — AXZ is out for O.R.S., IYX for O.P.S. and ESO for O.O. appointment. KKW is now O.R.S. LEN, LID and LZG send first reports. EC reports that "A-P" trunk line will operate all summer on 7260 kc. ADW and HNY are forming a radio club in eastern Suffolk at the Town Hall, Riverhead. JUX is changing QTH. KJY almost reached the Silent Keys when he got across the H.V.1 JJJN is in the C.C.C. KD has a three-watt job on 1.75-Mc.

NEW ENGLAND DIVISION

CONNECTICUT — SCM, Frederick Ellis, Jr., W1CTI — Section Net on 3640 kc. daily except Sunday at 6:45 p.m. N.C.S.: Mon. and Tues., W1TS; Wed. and Fri., W1AMQ; Thurs. and Sat., W1VB. KKS reports two new hams in Manchester, LXH and LXX. LJU invites all Conn. stations on 1.75 Mc. to join the American Emergency Net. Call in Sunday mornings at 10 a.m., 1850 kc. KAT and ABX are control stations. TD plans 7- and 14-Mc. operation. BHM, E.C. for New Haven, reports a complete line-up in his city for emergency work. Amateurs will meet at GB in case of emergency. GM6RG will address the gang present at the June 1 DX round-up to be held by the New Haven Amateur Radio Association. B.A.R.A. held open house April 10. Clint De Soto and By Goodman were down from A.R.R.L. Headquarters. KQY reports progress on the emergency net for the New York, New Haven & Hartford Railroad. JTD reported in on the Nutmeg Net recently. Glad to hear you on 3640, Hal. DWP's 810 is working FB. LQK has 30 watts to P.P. RK49's on 7 and 14 Mc. GYT operates on "2 1/2 meters" and wishes to know of any other stations using that band. BCG has new rig on, 100-watts input to RK-20 final, e.c.o. or crystal. AVC sends results of his first month's work as O.O. Glad to see no Conn. stations are on his list. A 28-Mc. kw. rig is nearing completion at LW.

Traffic: W1AW 308 KKS 273 AMQ 170 KV 165 JXP 162 JMY 126 TS 109 CTI 91 JYE 85 ES 63 IJU 25 LUN 19 TD-HDI 18 BHM 14 KFN 11 KQY 9 EFW 7 JTD-DWP 4 LQK 2.

MAINE — SCM, Winfield A. Ramsdell, W1FBJ — The first annual Lincoln County Radio Club hamfest was a grand success. About 200 attended and all agreed it was the biggest and best held in this Section for many years. Activities started at 2 p.m. with very interesting talks by Walter Butterworth, GM; A. L. Budlong, JFN; Irving Vermilya, ZB; F. E. Handy, BDI; and others. Supper was served at 6 p.m., after which some very valuable prizes were drawn. Other hams from out of State were: BFT, S.C.M. of N.H. and XYL, FTJ; GMH, N.H.; and GYZ from Mass. Congratulations to the boys at Damariscotta for a swell time. We are looking forward to the next one. IIE announced himself as candidate for S.C.M. for next 2-year term. LYK is new Lewiston ham, LRP is new O.R.S. AUC is new O.P.S. LHI and LMQ applied for O.R.S. LSK is on 28-Mc. 'phone. ATA is moving to the eighth district. EZR worked his first ZL2 on 7 Mc. LWX is new Hallowell ham. DHH has 46 states. LMQ took part in VE/W contest. EWN has new beam for 28 Mc. Don't forget the Field Day in June and also that reports for May to June go to the new S.C.M.

Traffic: W1G03 301 KOU 269 IIE 117 GVS 90 KMM 85 FBJ 60 IBR 44 GMD 30 HSE 24 HSD 20 LMQ 18 DHH 7 LDC 4 LRP 2.

EASTERN MASSACHUSETTS — SCM, Larry Mitchell, W1HIL — AAR is new O.R.S. and O.P.S. Here are some new appointments to help bring this Section up to the top: JYJ, Ass't S.C.M. for C.W. and Chief R.M.; GAG, Ass't S.C.M. for 'Phone and P.A.M. JYJ also will serve as E.C. for Bristol County. HIL and XYL enjoyed Framingham Hamfest. Prospective O.P.S.: KCQ, LTP; O.P.S.: JCX. Eastern Mass. Radio Ass'n bought Harvey UHX-25 a.c. operated and UHX-10 d.c. operated rigs and two Howard a.c. or d.c. operated receivers with genemotors, for use as field station or main station in case of emergency. Other clubs can well follow their lead. KCQ reports Waltham Amateur Radio Association plans club station. 8NWP/1 at Harvard is mobile on 28 Mc. LEU, GFW, KOZ, FHW, LXR and APE are after DX. HYZ is building new rigs for LOK and LSW. DMM is old timer coming back on. ITC will have HK254's in final. AXA, AKY, FH and JCX have FB rotary beams. HKK scored over 60,000 points on 'phone in DX contest. 21NP/1 is at Harvard. ADM made good score in DX contest. 9TOO/1 operates at HKK. BLO is active on DX bands with Mims Signal Squirter. LOI and KVT are active on 7 Mc. in Newburyport. South Shore Radio Club has fine meetings first and third Fridays each month at Y.M.C.A. in Quincy. JGQ will have 300 watts. The A.A.R.S. is very active in this Section. The 1.75-Mc. 'phone section drills on 1985 kc. every Wed. at 11:00 p.m. and Sunday at 8:30 a.m. They want more members. The Radio Clubs south of Boston turned out well for the Fram-

(Continued on page 88)

'phone. JTX is installing relays and a safety device on his HK-54 Job. An HQ-120 is the latest receiver at LEN. KUY completely rebuilt. CJP has rebuilding bug. HGO uses his buffer as a final; if there is too much QRM he switches on the 500-watt final. JDG has new antenna relay. ELK is remodeling station. CHK's signal shifter works the berries. IXQ's frequency meter is completed and he will give any one a frequency check. BFA and LUD are working on "2 1/2-meter" rigs. GJ and HAC operate on 1.75-Mc. 'phone. JBL met IIQG in a restaurant. LGK finds QML and QJH CQ's very effective. AXZ schedules his cousin, 8MOP. IXZ has hopes of working some sixes and sevens with his pair of 48's, running 22-watts input from 110 volts d.c. ESO has a new full wave "Q" for 14 Mc. LYI and MAU are a block from ESO. IYX, on 28 Mc. since the first of the year, has worked 44 countries. LOQ spent some time on 14 Mc., using 6L6G's as parallel oscillator. KXP is on 14.332 kc. at 6 a.m., running 63 watts to an 809 with half wave EO-1 doublet on 14-Mc. band, with a B.C.L. antenna used as a reflector. World's Fair business keeps LR on the run. MAZ lives with LEB in Easthampton. ITX is WLNW in the A.A.R.S. Traffic men on 7 Mc., interested in joining A.A.R.S., should get in touch with DBQ, as a new 7-Mc. A.A.R.S. Net has been organized. AZM conducts the section emergency net on 3710 kc. every Wednesday at 8:30 p.m. All stations of the Section are invited to join. Write for information. PF and AZV are part of the communications control board for the World's Fair. Anyone desiring to operate at the fair, either 'phone or C.W., should get in touch with PF or AZV.

Traffic: W2ITX 406 (WLNW 10) JHB 359 KI 309 HMJ 278 JZX 181 LR 170 DBQ 109 (WLNW 152) BGO 98 AZV 90 (GDF 75) PF 71 EC 47 OQ 45 CHK 44 JVK 42 AZM 41 JBL 39 LBI 32 JDG 21 ESO 20 HKK 20 LOQ 16 LEP 11 AXZ 8 IRC 7 AHG-CET 6 AA-CIT 5 IYX-ADW-HSO 4 KAM-KYO-LGK 3 HGO-EXR 2 ELK-DOG-FLD 1 DXO (WLNQ 29) (Feb.-March DBQ 213 WLNW 277).

NORTHERN NEW JERSEY — SCM, Fred C. Read, W2GMN — HWI, Fort Monmouth, has a fine traffic score this month. CGG is regular member of N.N.J. Net. HCO, fully recovered from illness, is back in traffic. FWT, the Clifton Radio Club, is building 1.75-Mc. 'phone. BZJ, HCO and JMX are new Emergency Coordinators. LAO is working 3.5-Mc. traffic and 1.75-Mc. 'phone. CMZ, KWB and KPZ are on 28 Mc. HZY has new HK54 final. ITD received Class A and is on 14-Mc. 'phone. DVU is new O.P.S. in this Section, coming to us from N. Y. C. & L. I. The Metropolitan Amateur Radio Association is newly formed club in Hudson County. LYL is pres., KIE, vice-pres. JMX has Class A and is on 3.9- and 1.75-Mc. 'phone. KTR has been teaching code to would-be hams. The Official Phone Operators met April 28th at home of LAG in Elizabeth. ZM5YU was visitor at a recent meeting of Raritan Valley Radio Club. LJD installed new rotary beam for 14 Mc. LFI is introducing ham radio at Franklin High School, Highland Park. KNN has new "Skyrider" receiver. KM recently "went talkie." GRG rebuilt final and buffer. AWC has 14-Mc. beam. JV finished kilowatt for 28 Mc. AWC has three-element close-spaced antenna on 28 Mc. FB is devoting considerable time to television. AMF is another 28-Mc. bug. LSH is new comer to 1.75-Mc. 'phone. LXI is working out on 14 Mc. with a beam. JSF is pounding brass on 14 Mc. with pair of 6L6's P.P. KRA is going after the foreigners in earnest on 28 Mc. KUW put his heap into a neat rack. KTI is "building for safety." KON is building low-power portable 'phone equipment. About half the members of the North Newark Amateur Radio Club plan to take part in the A.R.R.L. Field Day, from location near Princeton, N. J. LGY is active on 14 Mc. KRA expects to have a 150-watt, 28-Mc. 'phone rig ready soon. JPI is running 400 watts to pair of 35T's on 28 Mc. EWL, who operated on 1.75 Mc. for years, has gone to 28-Mc. 'phone. IXD worked 1KTF in Stamford on 56 Mc. and got an 88. JUU worked the mid-west with 6 watts to an e.c.o. LNG is active on 7 and 14 Mc. The North Newark Club's annual outing will be held on June 11 of this year. LMQ, LVT and LBY have been getting plenty of fun from 1.75-Mc. 'phone. JLX put up a vertical rod 16 feet long for 56 and 28 Mc. Any operators interested in handling traffic at or from the amateur station at the World's Fair are urged to drop a line to the New York World's Fair Radio Club, Communications Committee, 136 Liberty St., New York City.

Traffic: W2HWI 517 GYZ 512 (WLNI 7) KMI 169 HQL 79 (WLNW 20) HZY 54 HHY 44 ISF 36 CMC 31

Proven
ACCURACY
and
DEPENDABILITY

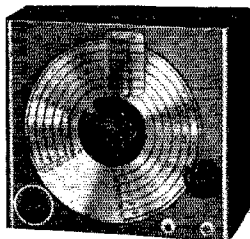

At the rate at which GUTHMAN U-10 Frequency Meter-Monitors have been going into the more progressive amateur stations, out-of-band operation should soon be something Grand Island won't have to worry about any more.

Since in amateur radio a bad product is soon discovered from its users, and a good one from its users, too, we'll let your own QSO's tell you how good the U-10 is. But we can't resist quoting a letter from W8PUN on frequency stability. Says W8PUN: "As to my opinion of the Frequency Meter would say that it is of excellent construction and appearance and also it is a first-class adjunct to any amateur station to fill the need of checking frequencies. As to its stability, I have just completed a 7 day test on drift and find that its drift over that period is not enough to be readable or to be heard by ear, with WWV as a standard. Its operation is simple and I believe it fills that vacant spot on so many operating tables."

Remember that the law says you *must* have frequency checking facilities, that the U-10 is proven good — and so you'd better get one and end your worries. And it's a great help to beat receiver warm-up drift by pre-spotting stations on the U-10 — which doesn't drift!

Edwin I. Guthman
EDWIN I. GUTHMAN & CO., INC.
400 S. PEORIA ST. CHICAGO, U. S. A.
CABLE ADDRESS: GUTHCO-CHICAGO

READ SEND CODE LIKE AN EXPERT!
Learn Quickly at Home, Get Real Speed

It's easy, fascinating, to become a good op with the NEW ALL ELECTRIC MASTER TELEPLEX CODE TEACHER to help you. Only instrument ever produced which records your sending in visible dots and dashes — then sends back to you at any speed you desire. Also sends practice work, recorded by an expert. That is why so many schools teaching code prefer Master Teleplex.

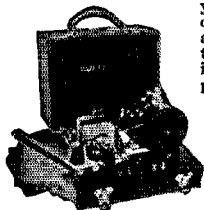

That is why thousands agree this method is surest, quickest — has taught more ops in the past few years than all other methods. We furnish Complete Course, lend you Master Teleplex, give you personal instruction with a MONEY-BACK GUARANTEE. Low cost. Send today for booklet Q-6; no obligation.

THE "HAM" SPECIAL Standard Teleplex — a highly efficient code teacher using heavy specially prepared waxed paper tape, having two rows of perforations. Write for Free folder QT-6.

We are the originators of this type instrument

TELEPLEX CO., 67-68 Park Place, N. Y.
In Canada, Write

Canadian Electronic Institute, Toronto, Ontario

★ **S. F. TRANSMISSIONS** ★

Date	Schedule	Station	Date	Schedule	Station
June 2	A	W6XX	July 7	A	W9XAN
June 9	A	W9XAN		B	W6XX
	B	W6XX	July 14	A	W9XAN
June 16	A	W9XAN		A	W6XX
	A	W6XX	July 21	BB	W6XX
June 23	BB	W6XX		A	W9XAN
	A	W9XAN	July 22	BX	W6XX
June 24	BX	W6XX	July 23	C	W6XX
June 25	C	W6XX	July 28	A	W6XX
June 30	A	W6XX			

STANDARD FREQUENCY SCHEDULES

Time (p.m.)	Sched. and Freq. (kc.)		Time (p.m.)	Sched. and Freq. (kc.)	
	A	B		BB	C
8:00	3500	7000	4:00	7000	14,000
8:08	3600	7100	4:08	7100	14,100
8:16	3700	7200	4:16	7200	14,200
8:24	3800	7300	4:24	7300	14,300
8:32	3900		4:32		14,400
8:40	4000				

Time (a.m.)	Sched. and Freq. (kc.)
	BX
6:00	7000
6:08	7100
6:16	7200
6:24	7300

The time specified in the schedules is local standard time at the transmitting station. W9XAN uses Central Standard Time, and W6XX, Pacific Standard Time.

TRANSMITTING PROCEDURE

The time allotted to each transmission is 8 minutes divided as follows:

- 2 minutes — QST QST QST de (station call letters).
 - 3 minutes — Characteristic letter of station followed by call letters and statement of frequency. The characteristic letter of W9XAN is "O"; and that of W6XX is "M."
 - 1 minute — Statement of frequency in kilocycles and announcement of next frequency.
 - 2 minutes — Time allowed to change to next frequency.
- W9XAN: Elgin Observatory, Elgin National Watch Company, Elgin, Ill., Frank D. Urie in charge.
W6XX: Don Lee Broadcasting System, Los Angeles, Calif., Frank M. Kennedy in charge.

WWV Schedules

Each Tuesday, Wednesday and Friday (except legal holidays), the National Bureau of Standards station, WWV, transmits with a power of 20 kw. on three carrier frequencies as follows: 10:30 to 11:30 A.M., E.S.T., on 5000 kc.; noon to 1:30 P.M., E.S.T., on 10,000 kc.; 2:00 to 3:30 P.M., E.S.T., on 20,000 kc. The Tuesday and Friday transmissions are unmodulated c.w. except for 1-second standard-time intervals consisting of short pulses with 1000-cycle modulation. On the Wednesday transmissions, the carrier is modulated 30% with a standard audio frequency of 1000 c.p.s. The standard musical pitch A = 440 c.p.s. is also transmitted from 4:00 P.M. to 2:00 A.M., E.S.T., daily except Saturdays and Sundays, on a carrier frequency of 5000 kc., power 1 kw., 100% modulation. The accuracy of the frequencies of the WWV transmissions is better than 1 part in 5,000,000.

The Radio Amateur's Handbook

The 1939 edition of the "Radio Amateur's Handbook" is a thorough revision of the standard manual of amateur communication. A tremendous quantity of new equipment was constructed exclusively for this Edition. The important transmitter chapter has been enlarged and has complete constructional data for units now described for the first time. It includes new diagrams with particular attention to determination of optimum L/C ratios and tank-condenser plate-spacings. Unit designs permit the construction of complete transmitters of any power up to the maximum allowed by amateur regulations. The radiotelephony section was rewritten with the thought of increasing its value to the practical amateur who wants to know more about the adjustment and operation of 'phone transmitters. Modulator data (particularly for the grid-bias and plate systems) will be found for each of the lay-outs featured in the transmitting chapter. Power supplies are of course fully covered so that you may pick the most suitable one. The antenna chapter has been expanded to give complete dope on all varieties from the simpler types to the more elaborate arrays. New treatment of feeder systems and the various antennas will make the operation of these more readily understood. Multi-band operation, antennas for restricted space, as well as complete information on rotary beams, is also to be found in this chapter. Other chapters have received equally thorough treatment. The fundamentals chapter has been simplified. The tube chapter has five pages of new tables to make this complete and up-to-date. New kinks will be found in the chapter on workshop practice. Four receivers have been added to the receiver section, including simple regenerative sets as well as superhets. As in the rest of the book, the emphasis is on proven circuits, with performance and economy foremost. Simple pre-selector and antenna-tuning units are described, together with material on tuning and signal-strength indicators. The transmitters to be found in the ultra-high-frequency chapters are of course designed to comply with the new regulations regarding stability; and the receivers to take advantage of this new set-up on 56 Mc. The still higher u.h.f. bands have not been forgotten, both receiving and transmitting gear having been built and described for the first time in this edition. Apparatus designed and constructed and actually used for the purpose, is included in the chapter on emergency and portable equipment. More effective laboratory equipment, practical for the amateur, is included in the instruments and measurements chapter. Of course the new amateur regulations are to be found in that ever useful source of information, the Appendix. With the extensive index, the reader can locate easily and quickly the information on the subject in which he is interested. Following the form of the previous Editions, putting in all information that is pertinent to the design, construction and operation of proven equipment, the 1939 "Handbook" is the most complete and comprehensive yet. Packed with practical information helpful to the old-timer and youngest beginner alike, concisely written in simple, understandable style, it is more than ever before the greatest dollar's worth in radio.

\$1 postpaid in Continental U.S.A. — \$1.25 postpaid elsewhere

Buckram bound edition, \$2.50

Spanish Edition, \$1.50

American Radio Relay League

West Hartford, Conn.

(Continued from page 86)

ingham Hamfest, which was a fine Hamfest as always. AAR has outfit on "2½." LBY has TZ40's about ready to go. AGX, AKS and HWE are active on 56-Mc. A.A.R.S. Net. HWE is laid up; card or letter or visit would cheer him up, gang. LLX is leaving first of June. Sorry to see you go, Dave. KH schedules VO3X daily at 6:45 A.M. WV worked VK9XX, New Guinea, for 113th country. BDU is looking for traffic on 7 Mc. VS has opened a photographic supply store in Medford Square ("Penguin Studios") and invites the gang to drop in and say hello.

Traffic: W1AKS 451 EPE 284 JY 266 JCK 255 (WLG 70) KH 206 JSM 162 AGX 110 HWE 102 EMG 90 KZT 85 AAR 73 LBY 43 LLX 31 LOC 17 WV 10 GAG-JDG 4 WI 3 BDU 2. (Feb.-Mar.: WLJY 379 AAR 42 FWQ 34 JGQ 1.)

WESTERN MASSACHUSETTS — SCM, William J. Barrett, W1JAH — BIV gave 1.75-Mc. c.w. a try after 14 years on the air. JAH visited GTN, BKJ, AJ and BVR. BKJ is building voltage stabilized power supply. AJ has returned to the air after recovering from severe electric burns suffered at work. DUZ has started construction on new 30- and 60- Mc. units, using HK-24's. LNH is active in A.A.R.S. GZL W.A.C.'d on 'phone two days running in 'phone DX Test. BVR and KRX attended Framingham Hamfest. RB has new HQ120X receiver. COI reports his HK-24's working fine on 28 Mc. KJK reports from Racine, via KLN. BNL is building 56- and 28-Mc. converter for auto radio. LSZ, new ham in South Barre, reports for first time. Welcome, Les. Remember, fellows, your reports must be mailed by the 16th of the month to get in QST.

Traffic: W1BIV 265 BVR 11 (WLG 137) JAH 136 (WLG 19) BKJ 89 AJ 82 DUZ 76 LNH 69 GZL 13 KRX 12 RB 6 BNL 4 KJK 3 (Feb.-Mar.: W1AJ 70.)

NEW HAMPSHIRE — SCM, Carl B. Evans, W1BFT-DMD — Special notice: The Sixth Annual New Hampshire State Convention and Hamfest will be held at the Hotel Carpenter in Manchester, some time in September. We have only 25 registered N.H. stations in the A.R.R.L. Emergency Corps. With 237 licensees in the Section, this seems a rather poor showing. Your S.C.M. has the necessary blanks; a card will bring them to you. We also need more Emergency Coordinators. Anyone interested in this work please get in touch with your S.C.M. The St. Paul's School Radio Club announces several members passed Class B exams. CME has returned from Florida. KIN has new shack built on top of a garage. The Nashua Mike and Key Club are working on an idea for a permanent clubhouse and have authorized the purchase of a 110-volt a.c. generator for emergency use. LLD was recently presented with a 28-Mc. crystal in appreciation of his services as secretary of the Triangle Club (Foreman's club at the Nashua Gummed and Coated Paper Co.). KLD won an 800 in club raffle. FGC has a 56-Mc. M.O.P.A. in his car. JDV is active on 28 Mc. GHT is chairman of the M. and K. Field Day committee. GEY is building a 61.6-'10 c.w. transmitter. AWU is experimenting with e.c.o. EAW has new 10Q antenna. APK purchased a 300-watt, gas-driven, 110-volt a.c. generator for emergency use. IVU is trying new beam. BFT, GMH and FTJ represented N.H. at the Damariscotta Hamfest in Maine.

Traffic: W1KIN 412 TA 146 GMM 135 BFT 123 IDY 88 CMR 78 JGI 44 KBU 27 KPQ 21 AWU 17 GHT 11 [P-EAL 6 HXJ 5 LIN 1.]

RHODE ISLAND — SCM, Clayton C. Gordon, W1HRC — Seen at the Framingham Hamfest — ETD, LDL, JXA, JEZ, GEF, DDY, Mr. & Mrs. BTJ, Mr. & Mrs. HRC, DTS, JP, KZN and four non-licensed members of P.R.A. KCS, GTN, INU, INT, FAH and KKE with portable 3.5-Mc. equipment are working with fire companies in forest fire control. This report is my first for my third consecutive two-year term as your S.C.M. I appreciate very much the confidence you have shown in re-electing me. I cannot say too much in praise of such leaders as GTN, JEZ and CPV in building up our O.R.S. activity and our E.C. membership. If the records for Rhode Island for the last two years show a steady increase in activity in A.R.R.L. doings, the praise belongs to such leaders as these and to the O.R.S. boys that have got into the doings and made strides forward in improving their technique, their traffic totals, and their standings in the contests. The one place where your S.C.M. could stand some real support is in preparing this column for QST. We want the world to know what R.I. is doing. Please mail us some news of your activities each month on the 16th. Let's go!

Traffic: W1INU 722 INT 223 GTN 180 LAB 169 IEG 109 KWA 102 CPV 79 KOG 67 JDX 65 LDL 85 KYK 51 LQG 44 KIV 36 KKE 35 KTH 29 QR 27.

VERMONT — SCM, Clifton C. Parker, W1KJG — FSV made B.P.L. and visited GAE, JVS and KXY. DPO at Pittsford Sanatorium is on the air. Green Mt. Radio Club is making extensive plans for June Field Day. IOY is new ham at Wolcott. BJP visited KZJ. AVP is blooming out with signal shifter. KUY is home from Conn. KOO and LII are on 56 Mc. with Army rigs.

Traffic: W1FSV 906 KTB 145 BJP 28 KOO 16 KJG 11 AVP 8.

ATLANTIC DIVISION

EASTERN PENNSYLVANIA — SCM, John B. Morgan, W3QP — Asst. SCM for Emergency Coördination W3AKB, R.M.'s: 3AKB, 3AQN, 8ASW. Best bunch of reports in a long while; 75 stations heard from, with 45 traffic reports. 3ADE wants schedules with any philatelist among the Section's O.R.S. 3AKB hammers away at the traffic trunks. 3AOC is hospitalized for several months. E. Pa. Traffic Net members wish him speedy recovery. 3DCGM is at sea, op-ing. Section's campers are dusting off their Field Day rigs. 3EFH has been acting control for Trunk Line C. 3FJU likes his new Guthman frequency meter. The contest bug has bitten 3FRY. 3FXZ is sporting a new HQ-120. 3GDI keeps them moving along. New O.R.S. 3GKO ran up nice total. 3GMK added 1.75-Mc. 'phone and 7 Mc. to his service facilities. 3GYV has a band-switched e.c.o. 3GYV visited 8TAH. 3HDB is gunning for Class A ticket. 3HFE has new 28-Mc. mobile rig. 3HRS is new O.R.S.; ex-3AQ/CT/ZN — after ten years the bug still bites. 3HSG's first 4 months operating netted 400 QSO's with 15-watter. 3HTF, a new ham, knocked off 39 states in short order. 3HTM with a 53 tube (he calls it a half-a-tube-rig) collected 4 countries in short order on 7 Mc. 3HVH needs Utah for W.A.S. 3HHI is Pres. of Yeaton Amateur Radio Assn. 3HYD uses 24A osc., 71A buffer and '10's with 20 watts final. 3HYU is trying to speed VS3OL with his 6L6 osc. on 14 Mc. 3HZK has 1.75-Mc. 'phone with e.c.o. 3RR visited 2JDC, and is interested in a 7-Mc. traffic net. 3UA is in good shape for Red Cross Demonstration Drill. 8ATF has a loop for receiving. 8PWJ revamped for break-in. 8RJK using T20 has 900 QSO's, 18 countries, 45 states in 16 months operating. 8RZJ joined the E. Pa. Net. 8SAA operates 4-Mc. 'phone; when it's low power rig it's 8NNW; when it's 7-Mc. code he uses 8OT1/8NEZ joined a 4-Mc. 'phone round-table, including an ON4. S.V.A.R.C. Hamfest is slated for July 9th at Selinsgrove. 8PTE and 8CJA sent fine reports of doings of local stations. 8TPE, 8MFD, 8FFN, 8CPL and 8CR occasionally try Morse. 8PUZ has moved into the Section with a Thordarson 100-watt code 'phone kit working well. New antenna at 3GJY. Who says "QRM"? 3DCS, BES, CLA HXA and HQE all within 200 ft. of each other! 3HVM moved to South Jersey. 8EKG increased power to a full kw. 3EEW did some good O.O. work in DX and W/VE contests.

Traffic: W3ADE 22 3AKB 139 3AOC 145 3AQN 142 3BES 4 3CHH 2 3DGM 4 3DXC 13 3EDC 244 3EFH 80 3EML 202 3FJU 6 3FRY 28 3GDI 44 3GHW 9 3GKO 280 3GMK 178 3GYK 107 3GYV 8 3HCT 21 3HDB 9 3HFE 12 3HRS 10 3HSG 3 3HYD-3IAY 2 3QP 129 3QV 41 3RR 2 3UA 18 3EEW 6 3GJY 53 3GUB 2 3HQE 25 3HVM 5 3ASW 481 8ATF 115 8FLA 36 8OML 16 8RHE 6 8RJK 1 8RKZ 8 8SGU 4 8SNZ 35 8SSP 5.

MARYLAND-DELAWARE-DISTRICT OF COLUMBIA — SCM, Edgar L. Hudson, W3BAK — 3CXL, 3CQS, R.M.'s. 3BWT, Chief R.M. HSB is running 115 watts to TZ-40. HQU built new e.c.o. and made it work satisfactorily on 7 and 14 Mc. CDQ is having some fun handling traffic with 8CMP. BKZ, on the air after long lay-off, has been assigned A.A.R.S. call WLQK. ECP has been assigned WLQM. HUM reports that T.L. "AP" will operate on 7260 kc., effective May 1st, for the summer. GZK has been getting ready to move to Boston. GYQ is experimenting with "2½ meters"; he would be interested in contacting other stations interested in A.A.R.S. activities, especially in lower Delaware. EUK has new 28-Mc. 'phone rig with 809's in final. CPG, portable in Calif., has been working FZH on 28-Mc. 'phone. CAB has resumed radio chess games with 8OKL in Pittsburgh on Tuesday nights. On April 4th, Mr. D. S. Burch, guest player at CAB won from Al Davies, guest player at 8OKL. On Apr. 11th, Dr. H. M. Clarkson at CAB played Mr. Davies at 8OKL and the game was to be

completed April 18th. 9EGC, a young attorney in the Department of Agriculture, has moved to Washington, D. C., and will apply for W3 call.

Traffic: W3CIZ 734 BWT 667 ECP 426 CXL 390 (WLM 4051) BKZ 181 GYQ 92 HUM 64 HUP 29 GZK 15 CDG 11 CAB 10 CJS 9 CDQ 6 HQU 6 HSB 5.

SOUTHERN NEW JERSEY — SCM, Walter Filson, W3BFI — BZX is holding up well as Trunk "B" outlet. GCU is moving rig to the attic. Ex-COT is the Father of a girl, Carol Ann. Congrats, Bob. A new ham in Trenton is IAZ on 7 Mc. ASQ is doing FB on 28 Mc., having only 3 states to go for W.A.S. ATF is rebuilding his lkw job for 14 Mc. CCO needs Nevada for 'phone W.A.S. and VK or ZL for 'phone W.A.C. AYC is building a Class B Linear amp. for his 28-Mc. 'phone. HHZ worked 12 new countries in DX contest on 'phone. CFS recently joined D.V.R.A. 56-Mc. activity in Trenton is picking up; several stations from N. Y. and Phila. areas are being heard regularly. ZI finally got his rig to work on 1.75-Mc. 'phone. GEV has a V beam on 28 Mc. GRW is rebuilding audio for 14-Mc. 'phone. The S.J.R.A. expects to participate in A.R.R.L. Field Day, and is conducting tests with portable low power equipment for demonstration.

Traffic: W3BZX 237 BYR 166 (WLVN 30) DNU 122 ZI 111 BEI 19 EWK 15 FBM 10 GMY 6 EUH 5 AEJ 4.

WESTERN NEW YORK — SCM, H. E. Preston, W3CSE — R.M.'s: 8BJO, 8DSS, 8FCG, 8JTT. P.A.M.: 8CGU, E.C.'s: 8GWY, 8RGA, 8RVM. Section O.R.S. net frequency: 3720 kc. The large number of applications being received for membership in the A.E.C. denotes a great interest in this very important phase of ham radio. Those who have not already joined, are urged to do so. Remember that the ability to render emergency communication service is amateur radio's greatest asset today. Much interest was shown in the DX contest in Auburn and nice contacts were made by AQS, BFG, CTJ, DME, DSU and ERZ. RNG worked his first foreign DX during the contest. BGN got the N.C.R. rig working in the Post Office. CTJ uses a cream separator to rotate his beam. NQC is rebuilding with hand-switching, push buttons, etc. DHU visited GWY, JJJ, GPT and JKQ. KYR and PCN joined A.A.R.S. The American Legion hopes to increase the power of its emergency station WANC/WSSHO from 15 to 60 watts on 'phone and from 60 to 300 watts on c.w. ABV and RME applied for O.R.S. MUQ has vertical antenna for 3.5 Mc. The 7-Mc. American Emergency Net with ADV as net control is going stronger every day. Drill periods are held each Thursday starting at 6:30 P.M., EST; frequencies between 7200 and 7250 kc. are used. To make the net of greatest value it is necessary to have a large number of members. Your cooperation will be deeply appreciated. Charles Tappan, brother of AVD, has nice new call, TDF. CJJ with cards from 91 countries is nearing DX Century Club membership. 4FPK on 14.298 and 14.074 kc. comes from Elmira and is looking for contacts near the old home town. LYF moved his rig into RZF's shack. KKE is on 1.8-Mc. 'phone. DLA is on with 300 watts after six year layoff. ACY is working PK's and KA's on 'phone. TCL is new Buffalo call. SFD, KVV and UY have a "flea power" net and would like more members. Listen for them Sundays at 1:30 P.M. NA is active on 1.75-Mc. 'phone. QUN is putting out nice signal with 75 watts to final. The Buffalo Club has new club rooms in Buffalo Museum of Science. Latest call on record is TEP, Rev. Oscar Anderson in Lowville. Rumors have it that GBY is working 7 Mc. BJO rebuilt and is putting in an 89 signal. KDY spent a few weeks in Calif. BAZ works 3.9-Mc. 'phone. QXS is an outstanding call on 1.8-Mc. 'phone. LYJ, CYT and NXQ had their station pictures in the rotovavure section of one of the Sunday papers. That mast of NXQ makes an imposing sight. CO has settled down on 7 Mc. PCW, 8 is operating 6L6 osc. from Univ. of Cincinnati. RTX keeps Caledonia on the air on 1.8- and 28-Mc. 'phone. BUO has been heard on 1.8 Mc. CTX has been favoring the higher frequencies. PLA gets in plenty of ragchewing on 1.8-Mc. 'phone and 3.5-, 7- and 14-Mc. c.w. RKM is trying to work a little DX between traffic schedules. QLT has Class "A" ticket. REI is fooling with 3.9-Mc. 'phone. SMH operates regularly in A.A.R.S. net. PCG is kept busy with A.A.R.S. affairs. JTT, our star traffic man, is also one of the leading men in A.A.R.S. NNJ sticks close to 3.9-Mc. 'phone. RVM is doing nice job in organizing St. Lawrence 1.75-Mc. 'phone emergency net; six low power portable stations are in operation and about eight more under construction. FB, Ken. Here's news — NA has been operating

on 7 Mc.!! RTW has been trying to contact Elmira from out of town. SWB has been sweating over a receiver. RRS gets better results from a Zepp than from twisted feeders. SWC is new traffic man in Rochester. ABN is showing signs of activity again. MCQ got 84-6 from Calif. using grid modulated '10's. Last minute note: At present PLA holds first place in W.N.Y. QSO Party with 34 contacts. It has been suggested that we have a Section picnic this Summer. Suggestions as to the place and date would be welcomed by the S.C.M. Proposals have been made that it be held at one of the State Parks, such as Watkins Glen for example. Each party bring their own basket lunch. No admission will be charged, no collection made. Just a get-together of all those interested. The object of holding it at a State Park is to furnish some sort of entertainment to the family, while the OM chews the rag with his pals. Please let me know whether or not you would be interested. Big plans are being made by the Elmira Amateur Radio Association for its share in the activity at the Tenth Annual Glider Soaring Contest, which will be held at Elmira from June 24th to July 9th. It is hoped that the call W8USA will be obtained and traffic will be an important consideration. The Elmira A.R.A. will hold a hamfest in the early part of June. Elmira has always presented an outstanding hamfest. Let's go.

Traffic: W84HC 55 RTX 54 QUN 23 HIO 4 CGU 22 DHU 9 NA 3 RVM 20 FCG 230 SBV 289 RKM 203 SWC 40 RZF 19 PCN 254 JTT 731 BJO 16 ADV 75 PLA 157 DSS 147 CSE 146.

WESTERN PENNSYLVANIA — SCM, Kendall Speer, Jr., W8OFO — The Altoona Horseshoe Radio Club celebrated its first anniversary on April 25th, with banquet and installation of new officers. The South Hill Brass Pounders held annual gabfest (indoors) at GJM. B.P.L. stations this month: DNX, FUW and WLM/8YA. MJK lacked five deliveries of making B.P.L. LTV has been released after three years absence. MJOJ, U.S.N.R. Armory station at Altoona, has been remodeled. MOT has been commissioned an Ensign in Naval Reserve. Congrats. PX says 22 out of 23 stations in U. S. Weather Bureau, Ohio River Region network, reported in for recent drill. Amateurs of Pittsburgh and vicinity mourn the death of W8NRJ, late transmitter engineer at KQV. He was active in A.T.A. activities and well known in the Pittsburgh area. KUN is active on 14 Mc. NCJ installed crystal switching using six crystals. AVY, Emergency Coördinator, contacted 36 stations on P.R.R. list in a test schedule. RAT has new grandson. AXD is being appointed Emergency Coördinator for McKean County. It's a daughter at SNC. Congrats. DGL went W.A.C. with his new rig and receiver. RBI worked W.A.S., all VE's and a K4 on 1.75-Mc. 'phone. QEL has new 1 kw. rig on 3.9-Mc. 'phone. FE has two new fifty foot masts. RUM is trying to make W.A.S. on 1.75-Mc. 'phone. NTJ made nice score in W/VE contest. RAU says RBM moved to 1.75-Mc. 'phone and is using only 8 watts. OEM needs only South America and Asia for W.A.C. A new arrival at KRY on Easter morning. Congrats. TFI, new amateur at Greensburg, worked New York and Mass. with only one-half watt. NQQ received S.W.L. cards from Roumania and worked VP7AS, both on 3610 kc. QAN is active again with 89-RK25-814-100TH's. 4ETX, ex-SJSY, visited Western Penna. friends during week of Apr. 23rd. PER visited RAU and RBM.

Traffic: W8-NX 525 NZR 338 FUW 322 NQQ 264 ZAE 251 OFO 165 LBO 164 MJK 159 RQA 148 QBK 144 KTM 135 LGD 125 QWY 102 DDC 97 AQN 85 KTS 83 MOT 83 NDE 81 DYY 71 PX 70 ZD 65 KD 58 GYB 50 OKS 49 QNJ 46 KXP 38 KUN 21 OTJ 20 MUD-SHN 16 EFA-QFM 13 SIL 12 NCJ-OJK 10 HBG-OUT-AVY-RAT 8 AXD-IZS 4 FZG 3 YA (WLMIA 609).

MARITIME DIVISION

MARITIME — SCM, A. Al. Crowell, VE1DQ — R. M.: VE1EY. MK, Halifax Club station, will undergo a bit of rebuilding. EY reports the Maritime Net closing for the summer. "Bill" thanks the gang for its cooperation this past season. LP was a visitor to Halifax. HJ and KG operated MK during W/VE contest. H.A.R.C. is planning well organized Field Day. Members expect to operate several self-powered stations. FO, Halifax Emergency Coördinator has listed all available independent sources of power. OQ handled 75 with 15 Sections in W/VE contest.



**build with
CONFIDENCE**

Aerovox Dandee—a genuine electrolytic of full rated voltage and capacity.

● Metal can protected by insulated non-slip paper jacket.

● Spun-over jacket ends eliminate danger of "shorts."

● Fully vented to eliminate dangerous gas pressures.

● 4 to 40 mfd. In 25, 50, 150, 250, 350 and 450 v. D.C. working.

● This tiny electrolytic costs only 50 cents list. But it could cost many dollars if it broke down and endangered tubes and associated components. That's why the AEROVOX guarantee backing all our products is so essential to you. Ask your jobber about it—and ask for latest catalog.



I. A. R. U. News

(Continued from page 49)

Fanning Island, incl. Christmas and Washington Islands	VR3
Fiji	VR2
Gilbert and Ocean Islands	VR1
Lord Howe Island	ZK1
New Guinea Territory	VK9
Niue	ZK2
Papua Territory	VK4
Pitcairn Island	VR6
Samoa, Western	ZM
Sarawak	VS4
Solomon Islands	VR4
Tonga (Friendly) Islands	VR5

South America

Falkland Islands	VP8
Guiana, British	VP3
Sandwich Group	VP8
South Georgia	VP8
Trinidad and Tobago	VP4

To qualify for the Award, contacts must be confirmed with 15 of the areas listed above.

GREECE

WE LEARN through the U. S. Department of Commerce that according to an official in the Greece Ministry of Communications, there is under consideration in that country the draft of a law authorizing the issuance of new licenses for amateurs under certain conditions. Among these requirements is one that the applicant be a member of a recognized amateur organization. It is stated it may be six months or more before the proposed law is put into effect. SV1NK corrects the note in our last issue, stating that there are a number of licensed amateurs in Greece, including SV1CA, SV1GR, SV1MP and himself.

— J. H.

A.A.R.S. Activities

(Continued from page 43)

the contest (particularly the YL's, one of whom was 88 years young according to her birth date in the last contest?).

During the summer months the A.A.R.S. remains about 50 per cent active with little else to do but handle traffic.

In addition to the above, each corps area has innumerable and varied activities which, all in all, provide considerable additional interest. Any active amateur who desires to engage in activities such as the above, and obtain training in procedure and traffic handling, should write the nearest Corps Area Signal Officer or to the address given at the end of this month's cryptogram.

The following cryptogram is presented for those interested in this work: SRQHR QSRAI AGAHH QSRUG UHQGI AHA AH DRQHA IHURS RARDS TIAUR DRSAI GHQUR AGUGT SDRQH HAAIG UQIAR RUGAH QSGAG QTISQ HDRSH DHRDG UURAT SRRUD GGATQ DRHQA IUGHA AGGDA QGTRD QHSRA HHAU DRUII AIQI UISHQ RDSHD HDRUG URIAR DHUHD UHDRR AAIQU QHRSD RLAAG RUAGG QGGDH GUATR USRHA AIGAU GRUG ARRAD RGSAT TSDRH QAIGU QIAA HHAAG RSUHH DIAAH RSQRG SDRQH RSARI ASRHA AIGUQ IHUAT HUHR DQGXX. Solutions should be sent to the following address for verification: Liaison Officer A.A.R.S., 3441 Munitions Building, Washington, D. C.

THE RADIO AMATEUR'S LICENSE MANUAL

Going after your first ham "ticket"? You need the manual for its instructions on where to apply, how to go about it in the right way—and, most important of all, for the nearly 200 typical license exam questions and answers.

Already licensed? The manual is still necessary for its dope on renewal and modification procedure, the Class A exam (with typical questions and answers), portable procedure, etc.

ALL the dope on every phase of amateur licensing procedure, and, of course, the complete text of the new regulations and pertinent extracts from the basic radio law.

25¢ postpaid

THE AMERICAN RADIO RELAY LEAGUE
West Hartford, Connecticut

JUNE 17th IS HAM DAY

at the Mighty 1939 Radio Parts Industry Show

"Come on let's go!"

1939 JUNE 1939		
ED-TUE	FRI	SATURDAY
14-15	16	17
JOBBERS	SERVICE MEN	SPECIAL DAY for AMATEURS

Show Hours:
Friday, June 16th, 2 p. m. to 11 p. m.
Saturday, June 17th, 2 p. m. to 10 p. m.

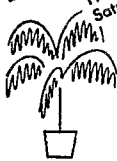

It's your Big Day at the 1939 Radio Parts Industry Show — Saturday, June 17th — a day specially planned for you and streamlined for action! See all that's new in Ham Gear, and other Radio Parts! Meet the industry in person — discuss the latest developments with factory men, engineers, and fellow-hams from all parts of the world.

And, of course, you're invited for Friday, June 16th, too. You won't want to miss the TELEVISION and FACSIMILE LECTURES and DEMONSTRATIONS featured on Friday and Saturday.

All Hams on Deck! Come On, Let's Go — don't let anything stop you!

HEAD FOR THE BIG SHOW AT THE STEVENS HOTEL, CHICAGO



National Radio Parts Trade Show

Sponsored by Radio Manufacturers Association and Sales Managers Club

*Executive Office — 53 West Jackson Boulevard, Chicago, Illinois

HARVEY'S

CONVENIENT to EVERYWHERE

Now that the New York WORLD'S FAIR is open and thousands of amateurs are coming to town . . . we would like to offer our

PERSONAL SERVICE

We've been in this radio field a long, long time . . . and have made many friendly contacts with amateurs not only in our own metropolitan area but throughout the nation and abroad. Unfortunately, we have not had the pleasure of meeting all of you "out-of-towners" . . . Let's get together when you come in.

- ★ SEE the new television receivers of RCA, Andrea, etc. . . . and parts, too . . .
- ★ SEE our complete line of both communication and broadcast receivers . . .
- ★ SEE our "ready-to-wire" kits . . .
- ★ SEE our extensive stock of parts from all the reputable manufacturers . . .
- ★ SEE our complete Camera Department. You'll want to take back pictures of the FAIR with you . . .
- ★ SEE our Electrical Accessories Department . . .

REMEMBER . . . we have a liberal "trade-in" allowance policy . . .

W2KWY, W2LJA, W2BQL, W2IJL

OUR *Best* VALUE IS OUR RECORD OF LOYAL SERVICE

HARVEY

Radio Company of New York

103 WEST 43rd STREET · NEW YORK, N. Y.

CABLE ADDRESS: "HARADIO"

★ NEW APPARATUS ★

New Sensitive Heavy-Duty Relay

SIGMA INSTRUMENTS, INC., Belmont, Mass., has brought out a new sensitive heavy-duty relay which is just the thing for voice-operated break-in systems and for crystal-oven temperature control-box circuits as well as other purposes. Any tube having an output capability of 50 milliwatts will operate the relay while the contacts will handle an inductive load of one-quarter kilowatt, making an intermediate relay unnecessary in many applications.

The type M relay may be obtained with winding resistances from 100 to 8000 ohms, the relay closing at currents ranging from 22.3 to 2.5 milliamperes respectively. The relay opens at approximately 50 per cent of the closing current. The action is independent of position.

The unit is enclosed and is provided with a five-prong base for plugging into a standard tube socket.

— D. H. M.

New Wave Trap

RCA's new wave-trap unit has a tuning range of 450 to 2100 kc. which, of course, includes the 1.8-Mc. amateur band. An exceptionally high-Q circuit is claimed which provides attenuation as high as 40:1 in the broadcast band. The unit is small in dimensions being assembled in a shielded can about the size of the usual i.f. transformer and a simple mounting makes it easy to install.

— D. H. M.

Strays

Several amateurs have written in about the proper ratio of the outside conductor to the inside conductor on both the coaxial transmission line and the outer conductor or lower quarter-wave section of the coaxial antenna, described in *QST* for January. The best ratio for highest Q and lowest loss is 3.6 to 1. This value is not very critical and a very high Q is obtained even with 2.7 to 1 or 4 to 1.

Another point is that the use of high-loss housewiring No. 14 wire is not recommended if better material is available.

If trouble is experienced in pulling this wire into the brass tubing, a wire with a good rubber insulation of smaller diameter is better from a loss standpoint and also from that of easier construction.

— John J. Long, Jr., W8ABX

New Heavy-Duty Vibrapacks

P. R. Mallory and Company announce that three new vibrapacks are now available. One has a rating of 300 volts, 200 ma.; the second, 400 volts, 150 ma., and the third, designed to operate from 32-volt supply, 300 volts, 100 ma.

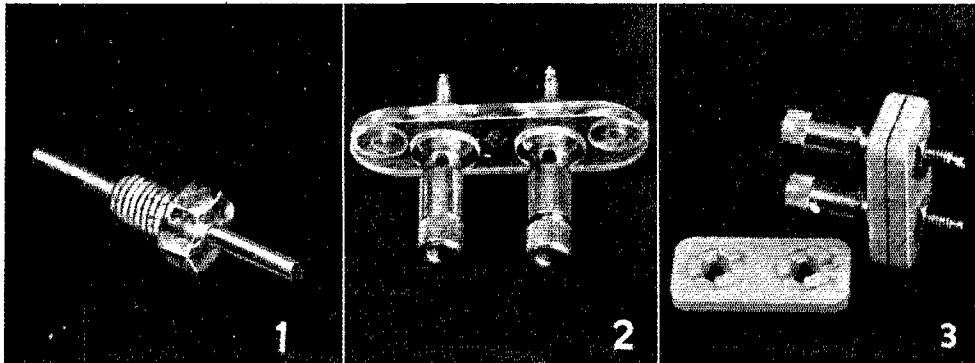

EASY TO INSTALL, EFFICIENT IN USE

ONE: The Through Point Bushing, of injection-molded Victron, is ideal for a variety of uses, particularly as a bushing or as a standoff. It is supplied with a .093" conductor molded in, but this can be removed without damaging the material. Losses are very low. The price is only \$.45 net per box of 12.

TWO: This terminal strip is of injection-molded Victron, and was originally designed for antenna connections on the ultra-high-frequency ONE-TEN receiver, where low losses are essential. The

binding posts accept banana plugs at the cap, and clamp wires firmly through the hole. Type FWB Terminal Strip, Net Price \$.06 each, without binding posts. Type FWA Binding Posts, Net Price \$.15 each.

THREE: Type FWC insulators may be used either with binding posts or jacks. The serrated bosses interlock so that they can be clamped on the thinnest panel. They are molded of R-39 for low losses. Type FWC Insulators, Net Price \$.21 per pair.

NATIONAL COMPANY, INC., MALDEN, MASS.



PERMEABILITY TUNING IS HERE

SEND FOR
Free Book!

Q CONTROL
TRADE-MARK

ALADDIN RADIO INDUSTRIES, INC.
466 WEST SUPERIOR STREET
DEPT. Q
CHICAGO, ILLINOIS

Licensed under
one or more of the
following Johnson
Laboratories, Inc.
patents:
1,940,228
1,978,600
1,982,689
1,982,690
2,018,626
2,051,012
2,113,603

Other patents issued
and pending.

• TELEGRAPHY—TELEVISION—TELEPHONY •

AVIATION

TRANSRADIO
PRESS

TELETYPE

TYPEWRITING



PRACTICAL
EXPERIENCE

STUDIO —
TRANSMITTER —
ANNOUNCING

The major technical training equipment owned by Port Arthur College and in operation on the college campus consists of the 500-Watt Commercial Broadcast Transmitter of Station KPAC; two-way Television Transmitter and Receiver; Latest Type RCA Marine and Airways transmitter installation complete; SOS Automatic Alarm; Marine Direction Finder; Trans-radio Press Receiving Equipment, and Laboratory complete where students assemble composite transmitters, amplifiers, audio amplifiers, R. F. amplifiers, etc.

Port Arthur College pioneered the teaching of Radio with classes in 1909, and for thirty years has maintained an active Employment Bureau for the placement of its graduates.

If interested in details about Radio Course, write for Bulletin R

PORT ARTHUR COLLEGE ■ **PORT ARTHUR (World-Known Port), TEXAS**

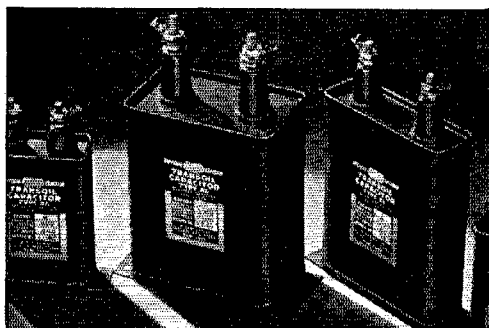

TRANSOIL

for transmitting

**HIGHEST QUALITY
OIL CAPACITORS**

Write for Catalog 2-X
listing complete lines

TRANSOIL—SOLAREX—TRANSMICA

SOLAR
MFG. CORP.



599 BROADWAY
NEW YORK CITY

PRACTICE ALONE

Can't give you a **GOOD FIST!**

Literally hundreds of operators have come to us in despair after weeks and months of conscientious practice without being able to develop their code speed beyond a few words a minute.

Then they started with Candler training and made almost uncanny progress. The reason is simple to understand. Candler teaches sound consciousness, and the correct fundamentals. The entire Candler course is built around scientific principles proved by over 20 years of application. Operators find themselves reading letters and then words with the same effortless ease that they read the printed word. They develop a smooth, rhythmic fist that is a joy to read.

Ask any skilled operator about Candler training. Write for the FREE "Book of Facts" and learn what Candler training can do for you by reading how it has helped others. Send for it today — there's no obligation attached!



CANDLER SYSTEM CO.

Dept. Q-6, Box 331, Asheville, No. Carolina
British Address: Room 56, Craven House,
Kingsway, London, W.C.2.



**ALWAYS
BE
CAREFUL**



★ ★ ★

(A) Kill all transmitter circuits completely before touching anything behind the panel.

(B) Never wear 'phones while working on the transmitter.

(C) Never pull test arcs from transmitter tank circuits.

(D) Don't shoot trouble in a transmitter when tired or sleepy.

(E) When working on the transmitter, avoid bodily contact with metal racks or frames, radiators, damp floors or other grounded objects.

(F) Keep one hand in your pocket.

(G) Develop your own safety technique. Take time to be careful.

★ ★ ★

Death Is Permanent!

★ BOOK REVIEWS ★

Principles and Practice of Radio Servicing, by H. J. Hicks; 305 pages, 211 illustrations. Published by McGraw-Hill Book Co., Inc., 330 West 42nd St., New York City. Price, \$3.00.

Written by the radio instructor of the Hadley Vocational School in St. Louis, this book represents a combination of the typical radio textbook dealing largely with abstractions and the practical dope of the serviceman's manuals. It is probably a better classroom text than a reference work, but anyone interested in radio — even amateurs whose only service work is on their own rigs — can read it with benefit. Some of the circuit diagrams, especially those dealing with test equipment, seem unnecessarily complicated and confused for a beginning student, but the text errs, if at all, on the side of overly-detailed treatment of elementary matters. From the discussion of unlike magnetic poles and their attraction for each other to the injunction to wear rubbers in wet weather, this is a most complete and instructive volume.

— C. B. D.

A Compact Converter

(Continued from page 15)

installation worked very well and should be equally effective in others. Good bonding of metal parts of the car is essential, and the radio wiring should be shielded. The single suppressor resistor generally used at the distributor probably will not be enough, and suppressors should be installed at each spark plug. A generator "whine" was eliminated by winding up a choke consisting of a few turns of heavy wire and connecting it in series with the hot lead at the generator with a $\frac{1}{4}$ - μ f. condenser between the far side of the choke and the frame. This was in addition to the usual condenser directly across the generator terminals. Nothing much can be done about interference from other cars in a simple installation such as this; in practice, however, this interference usually

COMPARE Crystal Performance

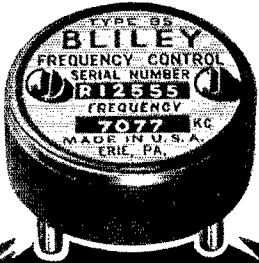

Place a B5 40-meter Crystal Unit in your transmitter and observe its performance. See how it snaps into oscillation instantly and maintains constant output. Set your monitor to zero beat and note the low frequency drift as the crystal warms up. Measure the frequency and check the accurate calibration stamped on the nameplate.

Dependable performance is built into B5 40-meter Crystal Units. You can get them from your Bliley Distributor for only \$4.80. Bliley Electric Co., Erie, Pa.

BLILEY B5 40-METER UNIT



ACME VOLTROL . . .

For regulating voltage or testing all electronic functions this new Acme Voltrol offers many advantages. Manually operated. Continuous duty. Complete stepless control from 0 to 130 volts. Panel mounting type illustrated especially adapted for radio work. \$12.00. Write for Free Bulletin.

THE ACME ELECTRIC & MANUFACTURING CO.
38 Water Street Cuba, N. Y.

EASY TO LEARN CODE

It is easy and pleasant work to learn the modern way — with an **Instructograph Code Teacher**. Ideal for the beginner or advanced student. ■ Many tapes available ranging from alphabet for beginners to typical messages on all subjects. Speed range 5 to 40 WPM. ■ Always ready, no QRM, beats having someone send to you.

FOR SALE OR RENT

STANDARD with 10 tapes and book of instructions \$20.25
JUNIOR with 5 tapes and book of instructions (not rented) \$12.00

RENTAL Standard with 10 tapes and book of instructions \$3.00 first month, \$2.25 each additional month. All rental payments may be applied on the purchase price should you decide to buy the equipment.

Write for details today

INSTRUCTOGRAPH COMPANY

Dept. Q, 912 Lakeside Place, Chicago, Illinois
Representatives for Canada:
Radio College of Canada, 863 Bay Street, Toronto



LEARN RADIO • TELEVISION

60-page catalog on request. Oldest, largest and best equipped in New England.

MASS. RADIO SCHOOL

18 Boylston Street Boston, Mass.

SKYROTOR

Our location in Detroit enables us to offer you the finest of materials and workmanship.

The **Beeline Skyrotor** has been especially designed throughout to give you years of accurate operation.

Skyrotor Features—The only universal, continuous rotation, mercury ring feed system. Special noise-free split phase induction motor. Micro-indicator, accurate to 1 degree.

Write for data sheet covering these and numerous other exclusive **Skyrotor** features.

The Beeline from Detroit

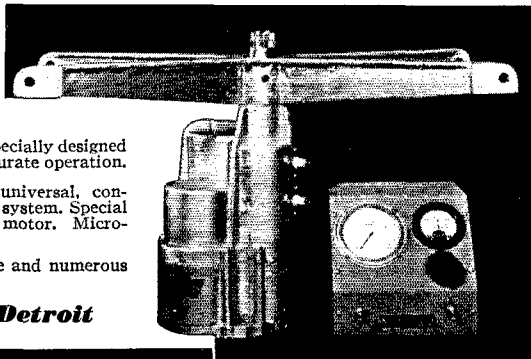

W8JK

We are pleased to announce that Dr. John D. Kraus, W8JK, is associated with us as consultant.

A complete W8JK "Flat-Top Beam" kit has been designed and is now ready for sale.

BEE
ENGINEERING
CO.

7665 Grand
River Avenue
Detroit, Mich.

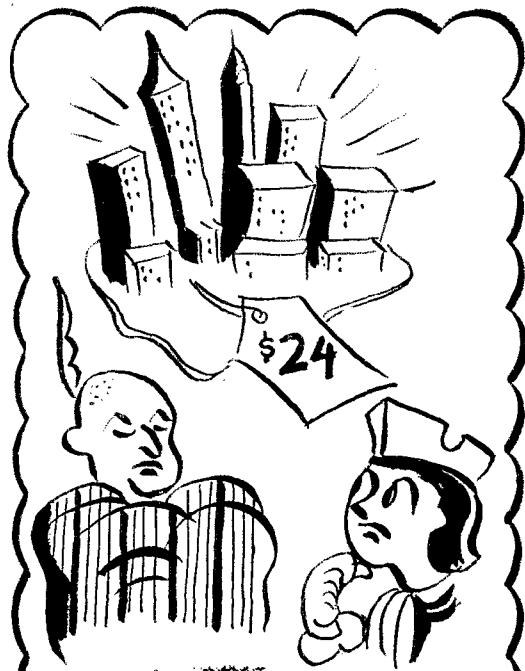

VALUE!

When you consider *only* the price of the quality equipment you purchase at Terminal, you may be sure it *cannot* be purchased elsewhere for less! Amateurs say, "Terminal values can't be beat!" They actually get more for their money than they expect!

TELEVISION at TERMINAL

TERMINAL leads again with Andrea and Meissner kits — complete line of television tubes, parts and accessories.

RCA Victor and Andrea television receiver on demonstration

TERMINAL Radio Corp.

68 West 45th St. • 80 Cortlandt St.
2 stores in NEW YORK CITY
Vanderbilt 6-5050 • Cable: TERMRADIO

is not serious on the open road since it lasts only for the short time during which a car is passing. It is a different story, of course, in heavy traffic.

If the receiving set-up is used in conjunction with a transmitter also getting its power from the car battery, it will be advisable to install a relay in the broadcast receiver to cut the hot "A" connection to the vibrator whenever the transmitter plate supply is switched on. A small back-contact relay can be installed without much difficulty in any convenient spot in the receiver. Its use will result in a saving of some 35 to 40 watts of battery power, which is something to think about if the outfit is used for considerable periods of time.

W.U. Collaborates

(Continued from page 46)

Coördinators where appointed) so complete organization information is available at three points in case of emergency.

This is an important recognition of the potential emergency value of amateur radio that we have now obtained from W.U. The direct and early contact in emergencies between Coördinators and wire services is valuable to insure the shortest possible interruptions to public communications. Please understand that this agency is *not* asking us to handle its ordinary message traffic, but that any traffic filed with amateurs from this agency will be of an *emergency* nature, probably including service reports or requests to commercial, traffic and plant headquarters concerning personnel and material. Next to traffic from Red Cross and relief authorities for the outside, such naturally takes a high degree of precedence.

The Western Union Telegraph Company also cordially invites individual amateurs or clubs to visit its offices, anywhere in the country by arrangement with the local manager. At A.R.R.L. we feel that amateurs who are to do emergency work cannot know too much about the principles of message handling, so we urge you to make the visit. Be sure to take along your *amateur license* — for Western Union is obliged to observe the requirements for absolute secrecy of communications under the Communications Act, just as we amateurs are — and you may need such credentials.

Another bit of news of interest to hams, in conclusion: Mr. J. D. Felsenheld (W3MI) of the public relations department of the Western Union company has designed an excellent chart for amateur radio stations — listing various codes — an official word list for radiophone operating, and telephoning messages — including useful Q Code foreign prefixes, etc. If you accept that invitation to visit your nearest Western Union Office, we suspect that you will not only see something interesting to all two-way communicating amateurs, but that you may be able to get one of these for the shack wall.

— F. E. H.

Now! A NEW BAND SWITCH FOR HIGH POWER

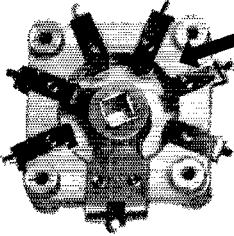

INDEX HEAD . \$3.00
 WAFER . . . \$3.00
**A new six point
 Band Switch for
 use with kw. rigs.**
 Max. Current 8 Amps.
 Max. Volts . . 4000
 SIZE: 3¼ x 3¼

**WRITE
 FOR DATA**

HEINTZ AND KAUFMAN
 SOUTH SAN FRANCISCO LTD. CALIFORNIA U.S.A.

★ ★ ★

We Repeat

the F.C.C. requires a record of all transmissions. Have you a separate log for your portable mobile work? You will find that a separate log will help you maintain the standards of your station in the field as you would at its base location.

35¢ each, 3 for \$1.00

★ ★ ★

**AMERICAN
 RADIO RELAY LEAGUE, INC.**
 WEST HARTFORD, CONN.

★ ★ ★

W3BES — W3CHE — W3EMM

BREAK CONTEST RECORDS USING B&W AIR INDUCTORS!

For a long time the LID who writes these ads has been telling hams that "AIR INDUCTORS give TOP PERFORMANCE under any conditions — anywhere!" Now, along come the winners of all three recent ham contests — record breakers, every one — to tell us that B&W's played a great part in rolling up their amazing scores!

Hats off to Jerry Mathis, W3BES, winner of the Sweepstakes National High . . . Dan Smith, W3CHE, new high-score champ in the CW Contest* . . . Fenton Priest, W3EMM, record-breaker in the 'Phone Contest* and many other top scorers — all swell ops — all boosters for B&W Coils and Assemblies.

TAKE A TIP FROM THE CHAMPIONS!

Variable link control with B&W Types HDVL (illustrated), TVL and BVL Coils provide precision adjustment of loading or excitation in any rig. Front-of-panel control insures the utmost in safety

— it eliminates the necessity of link adjustment with tools of any type. See the complete B&W line at your jobber's — do as the champions do — choose B&W's when you build or re-build!

**Unofficial scores*

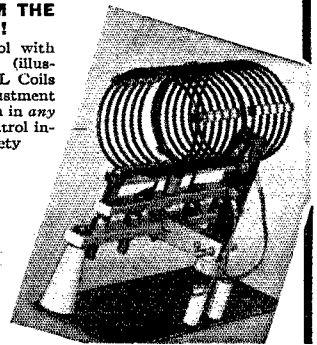

BARKER & WILLIAMSON
 Radio Manufacturing Engineers • ARDMORE, PENNSYLVANIA

You Can Measure

INDUCTANCE
CAPACITANCE
RESISTANCE



Faster! Easier!

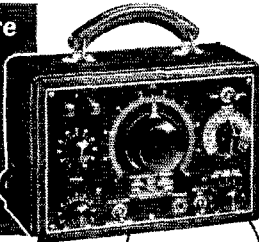

with this popular RCA
UNIVERSAL BRIDGE!

\$49.65
Net

This fine instrument will be useful in many ways in your laboratory. With it you can simply and speedily measure inductance, capacity and resistance over extremely wide ranges, as shown below. Easy to operate, this RCA Universal AC Bridge is well engineered, brings you excellent quality at a moderate price. See it at your RCA Test Equipment Distributor's.

Over 325 million RCA radio tubes have been purchased by radio users... in tubes as in radio sets, it pays to go RCA All the Way.

WIDE RANGE OF MEASUREMENTS!

The RCA Universal AC Bridge measures: Inductance... 10 microhenries to 10 henries—Capacity... 10 microfarads to 10 microfarads—Resistance... 1 ohm to 1 megohm—Accuracy... 5% over-all at full scale. Extremely portable, weighs only 5½ lbs... Stock No. 9600



Test Equipment

RCA Manufacturing Co., Inc., Camden, N. J.
A Service of Radio Corporation of America

Insure Your Future!

Start training now for a better job in
**PRACTICAL RADIO ENGINEERING
AND TELEVISION**

New opportunities for men with ability



E. H. Riestke
Pres. CREI

Radio, today, is progressing faster than any other industry. New developments—new equipment—and the new fields opened by facsimile transmission and television—have created exciting opportunities that should spur every ambitious man to take advantage of them. What are YOU going to do about it? The difference between an \$1800 job today and a \$4000 job tomorrow—is your qualification as an engineer. That means training now!

Train Yourself for the Job You Want

You can step ahead into a better job, just like the hundreds of other men we train each year. Don't say you never had the opportunity—for here it is! Radio wants you—and needs you—for those important new jobs. But, you must have training first. CREI courses in Practical Radio Engineering and Television can help you. Today's your chance to send for our important story.

Send for our free booklet!

CAPITOL RADIO
ENGINEERING INSTITUTE
Dept. Q-6

3224 16th St., N.W., Wash., D. C.



A 112-Mc. Pack Set

(Continued from page 38)

has been adjusted to the proper length, the circuit should be tuned to obtain a reading of 12 to 13 ma. at full load. These adjustments are made with the modulator switch in the "off" position. If the microphone is now plugged in and the modulator switch turned on the current, as read on the meter, should jump to approximately 30 to 35 ma. While speaking into the microphone the gain control should be slowly turned up until overmodulation starts, as indicated by a jump in plate current with voice excitation.

When the preliminary testing is finished, frequency checking is next in order. This may be done by tuning the receiver to the harmonic of a known crystal or signal-generator frequency. The band may be spread over any portion of the receiver dial by altering the spacing of the turns of L_1 . In our case the band lies between 30 and 90 on a 100-division dial. Next the transmitter is turned on and its output tuned to a frequency selected from the receiver calibration. The transmitter frequency is adjusted by means of condenser C_2 . This circuit will resonate at the high-frequency end of the band with the two condenser plates at nearly maximum separation.

An alternative method would be to use the Lecher wire system (see *A.R.R.L. Handbook*) for tuning the oscillator and then to tune the receiver to the transmitter frequency.

Although we must admit that this rig is not capable of furnishing communication over a distance of 100 miles, it is still a splendid unit to have around for emergencies, and can be used to advantage during periods of portable operation. We recall one especially cold afternoon last winter while carrying on some tests with a receiver in a cruising car when the author, standing in a very cold and bleak spot and feeling decidedly chilly, implored the chap at the receiving end to *please* come back and forget the tests for the time being. It turned out that the car was over two miles from the transmitter at the time of the QRR, and upon its return we were told that our signal was still very good at that distance—on a two-tube self-quenched receiver with only 45 volts on the plate! The story illustrates the point that in spite of the low power, simplicity and compactness of this pack set it isn't a toy and that, when called upon, it can really do a job.

Circulation Statement

PUBLISHER'S STATEMENT OF CIRCULATION AS GIVEN TO STANDARD RATE AND DATA SERVICE

This is to certify that the average circulation per issue of *QST* for the six months' period July 1st to and including December 31, 1938, was as follows:

Copies sold	42,332
Copies distributed free	414

Total

K. B. Warner, Business Manager

D. H. Houghton, Circulation Manager

Subscribed to and sworn before me on this 8th day of March, 1939.

Alice V. Scanlan, Notary Public

"Put Your Signal Where You Want It When You Want It There!"

Mims News

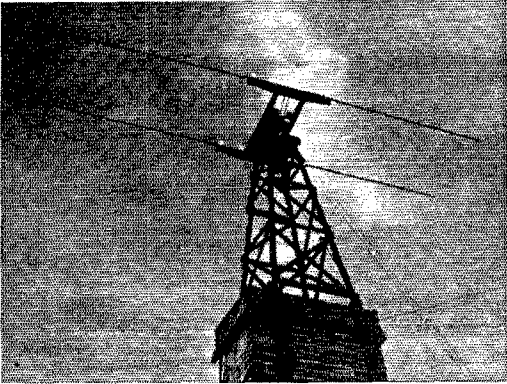

SS39-10 Signal Squirter at W3EMM

Good weather is here now — DON'T DELAY — send us your order at once — then you, too, can "Put Your Signal Where You Want It When You Want It There."

73,
M. P. Mims, W5BDB

Hats off to W3EMM

1st Place 1939 Phone DX Contest
3rd Place 1939 CW DX Contest

(Unofficial scores. See page 12, May 1939 issue of QST)

Congratulations to you, Fenton Priest — we are glad you could "PUT YOUR SIGNAL WHERE YOU WANTED IT, WHEN YOU WANTED IT THERE."

Many reports have already reached us, telling of the performance of the Signal Squirters in the recent contests. Analysis of the final results will show that the leaders in your section were prepared and properly equipped, as well as capable operators.

MIMS RADIO CO.
SIGNAL SQUIRTER
PRODUCTS
TEXARKANA, ARK. TEX.

Piezo-Electric Crystals Exclusively

- Quality crystals of all practical frequencies supplied SINCE 1925. Prices quoted upon receipt of your specifications.

Our Pledge: **QUALITY FIRST**

SCIENTIFIC RADIO SERVICE

"The Crystal Specialists Since 1925" University Park, Hyattsville, Md.

STACO Antenna CHANGE-OVER RELAYS

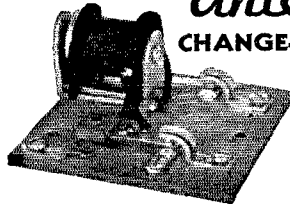

- Mycalex Insulation
- 4 Ampere Contacts
- Ball-Bearing Pivot
- Shorter R.F. Path
- No AC Chatter
- Floating Armature

Type ABA. XPLW Insulation, 110v, AC } \$3.00 net
Type ABD. XPLW Insulation, 6v, DC }
Type AMA. MYCALEX Insulation, 110v, AC } \$4.50 net
Type AMD. MYCALEX Insulation, 6v, DC }

See Your Jobber or Write for Details

STANDARD ELECTRICAL PRODUCTS COMPANY
316 Sibley Street St. Paul, Minnesota

RADIO COURSES

New Fall Classes Start in September

- RADIO OPERATING • BROADCASTING • CODE
- RADIO SERVICING • TELEVISION
- ELECTRONICS — 1 year day course; 2 years eve.

Day and Evening Classes — Booklet upon request

NEW YORK YMCA SCHOOLS

4 West 63rd Street, New York City

NEW PEE-WEE MOUNTING BY POPULAR DEMAND TO FIT A STANDARD 5-PRONG SOCKET

The Midget Inductor that asks no quarter — will handle 100 watts and more if necessary.

Add "S" to catalog type number to designate new mounting. Same price.....\$1.14 Net

RADIO



PRODUCTS

PROVIDENCE

RHODE ISLAND

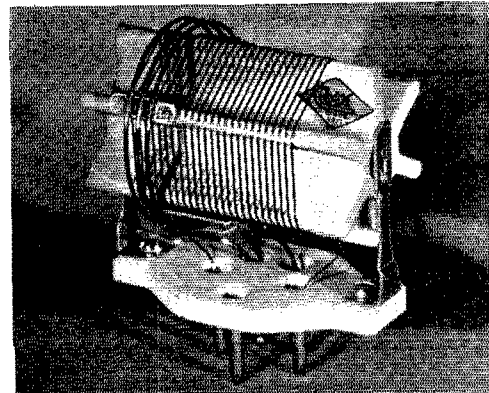



SPECIAL for JUNE

Thordarson Filter Chokes

12 Henry 250 Ma. **\$1.79**
110 Ohms

QUANTITY LIMITED!

If you can't drop in to our store, mail us your order for prompt shipment of your filter choke.

Television is Really Here!

Now you can build your own sight and sound Television Receiver — at low cost. The Meissner Television kit is entirely complete. There is no exception — everything is included — Chassis, panel, transformers, chokes, speaker, 5" Videotron Tube, 16 other tubes — in fact every part down to the last screw and nut — Design is shock-proof and incorporates every safety precaution. Complete Kit, your price **\$139.50**

Frequency Checker

Communication Measurements Labs —
Type 100-KX

Secondary Standard. Includes 100 Kc. low drift crystal. Provides usable harmonics every 100 Kc. to 60 Mc. Self contained power supply. Net price, including tube and crystal, Complete. **\$15.00**

NEW! UTC SPECIAL

Modulation Transformers

UNIVERSAL* — Will match any Modulator tubes to any R.F. load.

Audio Power	Special Price
12 Watts	\$2.06
30 Watts	2.79
55 Watts	3.82
110 Watts	5.88
250 Watts	8.23

* Impedance matching chart included with each transformer.

The famous Browning Preselector

Covers 1 to 185 Meters. With Electrical Bandsread. Uses 1 — 1852 Tube. Wired — model 5DXP — Complete (less tube) **\$16.17**
Complete Kit — model 5DXK — includes everything; nothing omitted (less tube) **\$13.23**

Write for free interesting Browning catalog, for complete description — or send in your check for prompt shipment of your Preselector.

KEEP UP TO DATE

Drop us a post card and your name will be placed on our mailing list for catalogs and interesting bulletins.

FREE BILEY FREQUENCY CHART

Write for your copy

Repeated by Request — One Month Only BEDE MILLIAMMETERS

3" Diameter. Square Bakelite Case. Moving Coil Movement. 0 to 5, 10, 25, 50, 100, 200, 250, 300 or 500 Ma. New! Perfect! Guaranteed! **\$2.39**

LOWEST PRICES

In addition to our monthly specials, Sun Radio carries one of the most complete stocks of standard Radio merchandise. If you buy by mail, you may order any item found in any current radio catalog, at the lowest prices. Should you have any doubt as to price, send us your list with a small deposit. Your order will be shipped immediately, and you will be charged the lowest price obtainable anywhere. All merchandise is carefully packed, and shipped by parcel post, express or fast freight, whichever is cheaper.

☆ EXPORT ORDERS SOLICITED
☆ MAIL ORDERS PROMPTLY FILLED



RADIO CO.

212 Fulton Street, Dept KT New York

Cable Address: SUNRADIO NEW YORK

★ A.R.R.L. QSL BUREAU ★

For the convenience of its members, the League maintains a QSL-card forwarding system which operates through volunteer "District QSL Managers" in each of the nine United States and five Canadian districts. In order to secure such foreign cards as may be received for you, send your district manager a standard No. 10 stamped envelope. If you have reason to expect a considerable number of cards, put on an extra stamp so that it has a total of six-cents postage. Your own name and address go in the customary place on the face, and your station call should be printed prominently in the upper left-hand corner.

- W1 — J. T. Steiger, W1BGY, 35 Call Street, Willimansett, Mass.
- W2 — H. W. Yahnel, W2SN, Lake Ave., Helmetta, N. J.
- W3 — Maurice Downs, W3WU, 1311 Sheridan St., N. W., Washington, D. C.
- W4 — G. W. Hoke, W4DYB, 328 Mell Ave., N. E., Atlanta, Ga.
- W5 — E. H. Treadaway, W5DKR, 2749 Myrtle St., New Orleans, La.
- W6 — Horace Greer, W6TI, 414 Fairmount Ave., Oakland, Calif.
- W7 — Frank E. Pratt, W7DXZ, 5023 So. Ferry St., Tacoma, Wash.
- W8 — F. W. Allen, W8GER, 324 Richmond Ave., Dayton, Ohio.
- W9 — Alva A. Smith, W9DMA, 238 East Main St., Caledonia, Minn.
- VE1 — L. J. Fader, VE1FQ, 125 Henry St., Halifax, N. S.
- VE2 — C. W. Skarstedt, VE2DR, 236 Elm Ave., Westmount, P. Q.
- VE3 — Bert Knowles, VE3QB, Lanark, Ont.
- VE4 — George Behrends, VE4RO, 186 Oakdean Blvd., St. James, Winnipeg, Manitoba.
- VE5 — H. R. Hough, VE5HR, 1785 First St., Victoria, B. C.
- K4 — F. McCown, K4RJ, Family Court 7, San-turce, Puerto Rico.
- K5 — Norman F. Miller, K5AF, 15th Air Base Squadron, Albrook Field, Canal Zone.
- K6 — James F. Pa, K6LBH, 1416D Lunalilo St., Honolulu, T. H.
- K7 — Jerry McKinley, K7GSC, Box 1533, Juneau, Alaska.
- KA — George L. Rickard, KA1GR, P. O. Box 849, Manila, P. I.

Strays

W6AM points out, after reading W5FDQ's story in April QST, page 22, that the problem of 1.65" spacers for a feed line is simple. Solution: Johnson No. 132 insulator between outside groove and one of the regular holes.

A GOOD NAME GOES A LONG WAY

Ken-Rad has the experience, the resources and the plant equipment to make dependable Ken-Rad Radio Tubes your best choice.



Ken-Rad Radio Tubes

KEN-RAD TUBE & LAMP CORPORATION - OWENSBORO, KY.

Manufacturers of all types of radio tubes and Ken-Rad Electric Lamp Bulbs

RADIO

ENGINEERING, broadcasting, aviation and radio telegraphy and telephony, Morse telegraphy and railway accounting taught thoroughly. 48 weeks' engineering course, equivalent to three years of college radio work. School established 1874. All expenses low. Catalog free. **DODGE'S INSTITUTE**, Day Street, Valparaiso, Indiana

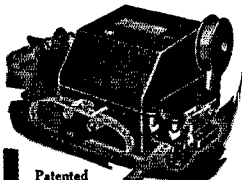

A Perfected AUTOMATIC SENDER

Patented Postpaid **\$12.50** in U. S. A.

Save your fist. Let the Automatic Sender raise your stations for you. Repeats calls or messages indefinitely. Length of messages practically unlimited. Sends from 2 to 70 words a minute. Motor driven. Entirely automatic. Built-in tape perforator. Absolute uniformity in spacing of characters.

\$13.50 West of Denver

Speed up your receiving. Connect Automatic Sender with a buzzer or oscillator. Accustom yourself to receiving any speed you select up to 70 W.P.M. Makes excellent code teacher for novice. Complete with 6 rolls of tape and full instructions. No extra equipment needed. If your dealer can't supply, write us.

FULLY GUARANTEED

Gardiner-Levering Co. Haddon Heights, New Jersey, U. S. A.

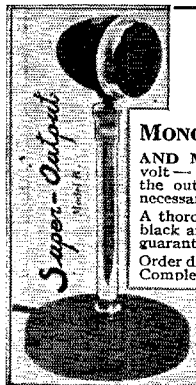

QUALITY PLUS IN THE TIBBETTS

MONOBAR-CRYSTAL MICROPHONE

AND MORE TOO — An output of over .2 volt — minus 39 db. This means about twice the output usually attained, less amplifier is necessary — Truly an important advancement. A thoroughly well-built microphone finished in black and chrome — one we stand back of and guarantee.

Order direct now, before there is a price advance. Complete with base, \$10.45 cash in U. S. A. Terms if desired.

Write for Booklet

TIBBETTS' LABORATORIES CAMDEN, MAINE

CORNELL-DUBILIER

Start Hit OF THE MONTH TYPE TLA

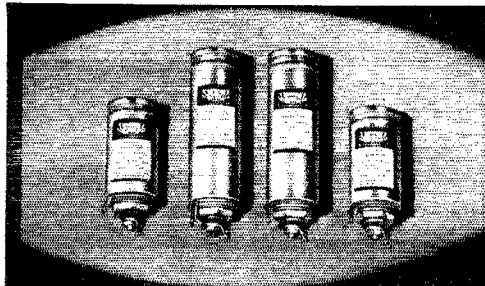

FEATURES OF TYPE TLA

Dykanol (Chlorinated Diphenyl) Impregnated and Filled — Long life; small size; non-inflammable; lower power-factor. ● Hi-Purity Aluminum Foil — Lower R. F. resistance; light weight. ● Hi-Purity Multi-Laminated Kraft Tissue — Higher voltage breakdown; minimum leakage; high I. R. ● Vacuum Dried and Impregnated — Lower equivalent series resistance; longer life. ● Hermetically Sealed — Not affected by moisture, time or temperature up to 200° F. ● Adequate Terminal Insulator — No leakage of current or Dykanol. ● Inverted and Vertical Mounting — Simple to install — mechanically strong. ● Approved by Fire Underwriters — Absolutely safe under all conditions.

For a complete listing of the entire Cornell-Dubilier line, send for Catalog No. 165A. FREE ON REQUEST.

MICA ● PAPER ● DYKANOL ● WET AND DRY ELECTROLYTICS



CORNELL-DUBILIER ELECTRIC CORPORATION

1013 Hamilton Boulevard, South Plainfield, New Jersey

Cable Address: "CORDU"

PRECISION CRYSTALS

Highest quality crystals carefully prepared for frequency stability and maximum output — rigidly tested to assure you of dependable operation. Be sure of your transmitter frequency — use **PRECISION CRYSTALS**.

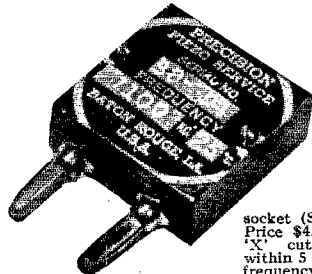

Low frequency drift units supplied within 5 Kc. of your specified frequency in the 40, 80 or 160 meter bands calibrated to within .03%. Supplied in holder as illustrated to plug into G.R. type jacks or in round holder to plug into a tube socket (See Jan. issue QST). Price \$4.00. Highest quality cut crystals supplied within 5 Kc. of your specified frequency in the 40, 80 or 160 meter bands and calibrated to within .03%. Supplied mounted. Price \$3.50. Please state if holder as illustrated or round holder for tube socket is wanted.

Precision crystals for commercial requirements quoted on at your request. Now in our tenth year of business.

PRECISION PIEZO SERVICE

427 Asia Street

Baton Rouge, La.

OHMITE DIVIDOHMS

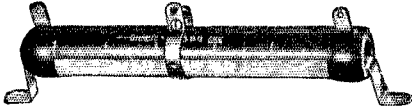

QUICKLY ADJUSTABLE TO EXACT RESISTANCES

You're ready for any wire-wound resistance requirement or a quick replacement — when you have Ohmite Adjustable Dividohm Resistors handy in your shack. You can quickly adjust the Dividohms to the exact resistance you want and put on one or more taps wherever needed. Patented percentage of resistance scale. 7 ratings from 10 to 200 watts. Resistances up to 100,000 ohms.

Ask Your Jobber or Write for Catalog 17

OHMITE MANUFACTURING CO.
4865 Flourney St., Chicago, Ill., U. S. A.

Be Right with **OHMITE**
RHEOSTATS • RESISTORS • TAP SWITCHES

Gross Transmitters for Dependability and Economy

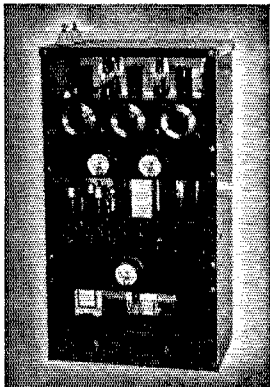

★ Write for free descriptive bulletin on our CB-150 and CB-250 Radiophone Transmitters

GROSS CB-55 RADIOPHONE TRANSMITTER

FB. for 30 MC. — Input: 95 watts. Uses: 2-T20 tubes in R.F. and 6L6's in modulator. Coils available for 30, 14, 7, 3.5, and 1.7 mc. Descriptive bulletin on request.

GROSS RADIO, Inc.

51 Vesey Street New York
Cable Address: GROSSINC

W2JHB Wins 1938 Maxim Memorial Trophy

(Continued from page 29)

66-foot matched impedance strand and a 14-Mc. Reinartz rotary.

Dowd's operating activities are considerable. Every day in the week during 1938 he maintained a regular operating shift from 6 to 9 P.M. This sort of work enabled him to pile up a traffic total of 5906 for the year. He held down posts on Trunk Line "C" and in the New York and Long Island Net. He made the BPL seven out of the twelve months. He worked 44 states and 3 foreign countries on 3.5 Mc. He participated in the Sweepstakes and the A.R.R.L. party. He performed as OO, OBS and AEC. He installed an amateur exhibit at the New York Stock Exchange Hobby Show that aroused much favorable comment. Coöperating with W2SN in the QSL Bureau, he sent out 800 notifications to Second District hams with cards on file (700 in 1937), moving some 10,000 cards. All in all, his time was well filled.

This did not prevent him from aiding a number of other would-be amateurs in obtaining their tickets, notably an invalid who had flunked out on the exam several times through nervousness before W2JHB took him in hand. Nor did it prevent him from keeping the girl friend happy, dancing at local niteries in winter, swimming at the beach in summer . . . or from the parties at W2IXQ's . . . or the periodic outings of the Flatbush gang or other social "musts."

That's a picture of the 1938 Hiram Percy Maxim Award winner. An up-and-coming, hard-working lad — one who's going to get places.

Again the thanks and appreciation of the entire ham fraternity to Mrs. Lee and Mr. Maxim for the inspiring goal of service and achievement they have set America's young amateurs.

— C.B.D.

The 1852 as a Mixer

(Continued from page 58)

from the pins in the coil form. The turns of the two- and three-turn coils are bound together with thread and then "doped" generously with Duco cement. In practice, the coupling is simply adjusted by bending the coil with respect to the grid winding until R_1 controls regeneration satisfactorily, the tickler then being left fixed. The tickler should be mounted near the bottom of the grid coil. Since the coupling between L_1 and L_3 can be readily adjusted to take care of different antenna systems, the trimmer condenser in series with L_2 in the original circuit has been eliminated.

The image ratio with the 1852 is not so good as with the 6L7, a state of affairs which was somewhat surprising in view of the input characteristics. For example, with the 6L7 mixer at critical regeneration, signal-to-image ratios of the order of 150:1 at 14 Mc. could be obtained, while the 1852 under similar conditions shows a ratio of about 75. With regeneration at an easily-handled

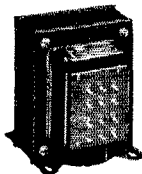

Poly-Pedance Unit

STANCOR

Has The VALUES

NEW 1939 CATALOG FREE—ASK YOUR JOBBERS

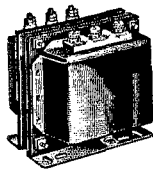

Plate Transformer

POLY-PEDANCE DRIVER TRANSFORMERS

Stancor Part No.	Cap. in Watts	Pri. M.A. per Side	RATIO Primary to Secondary	Net Price
A-4761	15	60	1.25:1, 1.4:1, 1.6:1, 1.8:1, 2:1, 2.2:1, 2.4:1	\$3.45
A-4762	15	60	2.6:1, 3:1, 3.2:1, 3.4:1, 4:1, 4.5:1, 5:1	3.30
A-4765	15	60	1:0.75, 1:0.85, 1:1, 1:1.25, 1:1.45, 1:1.75, 1:2, 1:2.25, 1:2.5, 1:2.75, 1:3, 1:5	3.30

POLY-PEDANCE MODULATION TRANSFORMERS

Stancor Part No.	Cap. in Watts	Pri. M.A. per Side	Secondary Series	M.A. Parallel	Net Price
A-3891	15	45	45	90	\$3.00
A-3892	30	80	80	160	3.90
A-3893	60	125	125	250	4.80
A-3894	125	200	150	300	6.30
A-3895	300	260	260	520	18.00
A-3896	600	350	350	700	37.50

PLATE TRANSFORMERS

Stancor Number	Primary 115V	Secondary Load Volts	A.C. Load Volts	D.C. Volts	D.C. M.A.	Net Cost
P-6152	1550-0	1550	1350-0	1250	300	\$9.60
P-5053	1660-0	1660	1390-0	1500	300	11.10
P-6156	2150-0	2150	1830-0	1750	300	12.00
P-6154	2430-0	2430	2000	1750	300	12.90
P-6155	2950-0	2950	2400	2500	300	17.70
P-3012	1250-0	1250	950-0	1000	400	11.40
P-6153	1550-0	1550	1350-0	1250	500	13.80
P-6159	2150-0	2150	1830-0	1750	500	22.50
*P-6163	3000-0	3000	2410-0	2000	500	30.00

*115-230V Pri.

THESE ARE BUT A FEW OF THE MANY OUTSTANDING STANCOR VALUES
SEE THE COMPLETE LINE AT YOUR JOBBERS. GET CATALOG FREE

STANDARD TRANSFORMER CORPORATION

1500 NORTH HALSTED STREET, CHICAGO

QSL Cards

Individual QSL Cards printed as you want them, at reasonable prices.

Samples gladly submitted on request.

HINDS & EDGARTON, INC., W 9 W R
19 South Wells Street, Chicago, Illinois Ex. W9APY

AMATEUR RADIO LICENSES

Day and Evening Classes in Code and Theory

HOME STUDY COURSES

Reasonable, Efficient and Thorough, Hundreds of Licensed Students Now on the Air

American Radio Institute, 1123 Broadway, New York, N. Y.

NEW VALPEY

Type VO 1

CRYSTAL OVEN

This new and improved crystal oven has been designed so that any crystal unit which mounts in a five prong tube socket can be plugged into it. The oven in turn plugs into the socket from which the crystal has been removed.

The oven operates on from 6 to 8 volts at .75 amperes and will hold the temperature constant to 1 degree centigrade. Heater voltage may be taken from the oscillator filament supply.

Descriptive folder available from your dealer or direct

THE VALPEY CRYSTALS

Box 321 HOLLISTON, MASS.

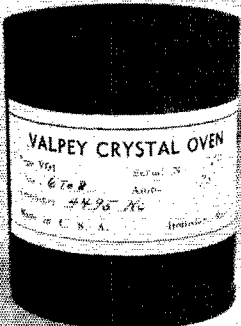

HERE IT IS...
HAMS

A New A.C. and D.C. Pocket Volt-Ohm-Milliammeter

with Ranges to 5000 Volts — Self-contained.

\$14.50

Net Price

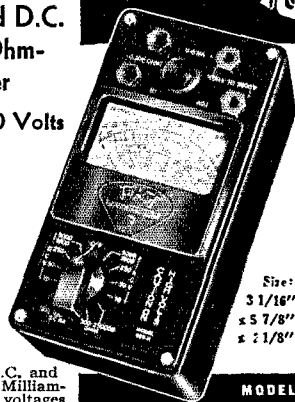

Size:
3 1/16"
x 5 7/8"
x 2 1/8"

MODEL
666-H

Will handle all
Amateur Requirements

Now, a new Triplet A.C. and D.C. Pocket Volt-Ohm-Milliammeter that will handle voltages to 5000 volts without external multipliers. It will check the high voltages and circuits of transmitters and receivers — just the instrument for amateur use.

Ranges: AC-DC Voltage at 1000 Ohms per volt 0-10-50-250-1000-5000; D.C. Milliamperes 0-10-100-500; Resistance 0-300 shunt type 10 ohm reading at center scale; 0-250,000 series type, 3700 ohms at center scale.

Model 666 — uses same case as 666-H... Reads to 1000 volts at 1000 ohms per volt... Net Price.....\$14.00

Write for Catalog!

THE TRIPLET ELECTRICAL INSTRUMENT CO.
Section 256 Harmon Ave., Bluffton, Ohio

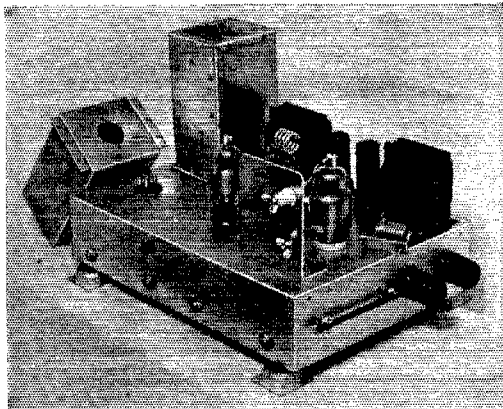

FIRST AGAIN with an Amateur version of a Police Car Transmitter priced to meet your pocket-book.

Type T-510, 12 watt, Crystal Controlled, PORTABLE MOBILE TRANSMITTER with 28 and 56 Mc. Band Switching.

Has been designed by Frank Jacobs, W2BSL-W2XHV. Compromise with quality has not been made, but the price has been kept low by dispensing with cabinet, panel and meters.

See our line of APPROVED transmitters at our permanent QTH, the nearest radio factory to the New York WORLD'S FAIR grounds.

RADIO TRANSCEIVER LABS.

8627 115 Street Richmond Hill, New York City
Cable Address: "Ratralab"

Type T-510 KIT \$21.80
Biley 28 Mc. crystal . . 5.75
Raytheon 6N7, 6N7, 6F8G, RK-56 tubes . . 6.00
Radiart Vipower 6 v./300 v. 100 m.a. . . 9.60
Wired and tested 6.25

Just Out!

Principles and Practice of RADIO SERVICING

By H. J. HICKS, Radio Instructor, Hadley Vocational School, 300 pages, illustrated, \$3.00

Shows how to install, test, and repair radio receivers, giving not only instructions in all the servicing procedures, but also plain treatment of the theory of electricity and radio needed for most effective approach to servicing problems. Written in excellent self-study style for servicemen who want to improve their skill and readers who want to learn this practical field from the ground up.

Includes chapters on

- selecting and using test equipment
- servicing public address systems
- getting and keeping service business

SEE BOOK ON APPROVAL — SEND THIS COUPON

McGraw-Hill Book Co., 330 W. 42nd St., N. Y. C.
Send me Hicks-Principles and Practice of Radio Servicing for 10 days' examination on approval. In 10 days I will send \$3.00 plus few cents postage or return book postpaid. (Postage paid on orders accompanied by remittance.)

Name
Address
City and State
Position
Company QST-6-39
(Books sent on approval in U. S. and Canada only)



value fairly well below the critical point, the 6L7 gave a ratio of 65 as against 40-50 for the 1852. The latter value can be considered satisfactory, since it compares with a ratio of 50 which is typical of commercial receivers having one r.f. stage. In nearly all respects, therefore, a receiver with an 1852 regenerative mixer gives comparable performance to that of a receiver using a 6K7 pre-selector stage, providing the regeneration is used effectively.

We have not attempted to explore completely the possibilities of other circuit arrangements than that given. Screen-grid injection was not nearly so successful as control-grid injection, giving a considerably poorer signal-to-noise ratio. It is possible, however, that a more exhaustive examination of different operating conditions might uncover equivalent performance, with the possibility that the oscillator coupling over a wide frequency range might prove to be less critical.

Suppressor injection was not given serious consideration for two reasons: First, in this tube as in other pentodes, a relatively-tremendous oscillator voltage swing is necessary for modulation of the plate current, along with a high operating value of negative bias on the suppressor (with 250 volts on the plate, 150 on the screen, and - 1 on the control grid, for instance, the suppressor voltage can be run from + 20 to - 30 without any material change in the plate current); second, the suppressor and control-grid pins are adjacent on the tube base, and it is practically impossible, especially at high frequencies, to modulate the suppressor without modulating the control grid at the same time; in fact, the unavoidable capacity between base pins, socket prongs and wiring is of the same order as that of the coupling condenser used in Fig. 1.

— G. G

A Stable and Inexpensive 56-Mc. Transmitter

(Continued from page 87)

ground potential. By varying the positions of the halves of the oscillator plate coil, L_2 , an optimum point can be found where there will be about 10 ma. of grid current to the final. When the short is taken off the 2000-ohm resistor the grid current will drop to about 6 ma., which is sufficient. The final is then loaded with an antenna, not a lamp, since the lamp load will not stay constant when later adjusting for modulation. The antenna coil turns may have to be varied from the number given, which is intended to match a 70-ohm line to a doublet. Loading can also be changed effectively by stretching the antenna coil to vary the turn spacing. The amplifier should be loaded as heavily as is consistent with good output. The plate current should rise from the no-load value of approximately 38 ma. to 75 ma., and the output with this adjustment is around 15 watts.

The adjustment for modulation can be made by increasing the suppressor bias until the plate current drops to half its full-load value, or 40

Where to buy it

A directory of suppliers who carry in stock the products of these dependable manufacturers.

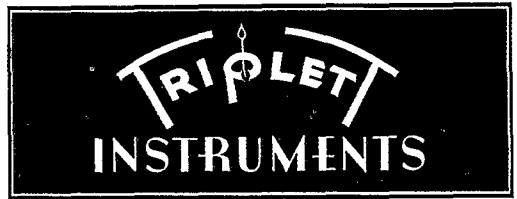

ALBANY, N. Y. Uncle Dave's Radio Shack 356 Broadway
 ATLANTA, GEORGIA 265 Peachtree Street
 Wholesale Radio Service Co., Inc.
 BOSTON, MASS. Radio Shack 46 Brattle Street
 BOSTON, MASS. 110 Federal Street
 Wholesale Radio Service Company, Inc.
 BRONX, N. Y. 542 East Fordham Rd.
 Wholesale Radio Service Company, Inc.
 BUTLER, MISSOURI 211-215 N. Main Street
 Henry Radio Shop
 CHICAGO, ILL. 833 W. Jackson Blvd.
 Allied Radio Corp.
 CHICAGO, ILL. 901-911 W. Jackson Blvd.
 Wholesale Radio Service Company, Inc.
 CINCINNATI, OHIO 1103 Vine Street
 United Radio, Inc.
 COLUMBUS, OHIO 203 N. Fourth St.
 Bell Radio Parts Co.
 DETROIT, MICH. 325 E. Jefferson Ave.
 Radio Specialties Co.
 DETROIT, MICHIGAN 11800 Woodward Ave.
 Radio Specialties Co.
 HARTFORD, CONNECTICUT 227 Asylum Street
 Radio Inspection Service Company
 HOUSTON, TEXAS 4021 Huey Street
 R. C. Hall & L. F. Hall
 JAMAICA, L. I. 90-08 166th Street
 Wholesale Radio Service Company, Inc.
 KANSAS CITY, MO. 1012 McGee Street
 Burstein-Applebee Company
 NEW ORLEANS, LA. 902 Poydras Street
 Shuler Supply Company
 NEW YORK, N. Y. Harrison Radio Co. 12 West Broadway
 NEW YORK, N. Y. 100 Sixth Ave.
 Wholesale Radio Service Co., Inc.
 NEWARK, N. J. 219 Central Ave.
 Wholesale Radio Service Co., Inc.
 OAKLAND, CAL. 2085 Broadway
 Offenbach's
 READING, PENN. 404 Walnut St.
 George D. Barbey Company
 SACRAMENTO, CAL. 1310 K Street
 Offenbach's
 SAN FRANCISCO, CAL. 1452 Market Street
 Offenbach's
 SPRINGFIELD, MASS. T. F. Cushing 349 Worthington St.
 WASHINGTON, D. C. 938 F Street, N. W.
 Sun Radio & Service Supply Co.

ALBANY, N. Y. Uncle Dave's Radio Shack 356 Broadway
 ATLANTA, GEORGIA 69 Forsyth Street, N. W.
 Garvin Electric Company
 ATLANTA, GEORGIA 265 Peachtree Street
 Wholesale Radio Service Company
 BOSTON, MASS. Radio Shack 46 Brattle Street
 BOSTON, MASS. 110 Federal Street
 Wholesale Radio Service Company, Inc.
 BRONX, N. Y. 542 East Fordham Rd.
 Wholesale Radio Service Company, Inc.
 BUTLER, MISSOURI 211-215 N. Main Street
 Henry Radio Shop
 CHICAGO, ILLINOIS 833 W. Jackson Blvd.
 Allied Radio Corp.
 CHICAGO, ILLINOIS 25 North Franklin Street
 Electric & Radio Supply Co., Inc.
 CHICAGO, ILL. 901-911 W. Jackson Blvd.
 Wholesale Radio Service Company, Inc.
 CINCINNATI, OHIO 1103 Vine Street
 United Radio, Inc.
 JAMAICA, L. I. 90-08 166th Street
 Wholesale Radio Service Company, Inc.
 LITTLE ROCK, ARKANSAS 409 W. 3rd St.
 Beam Radio Company
 MINNEAPOLIS, MINNESOTA 1124-26 Harmon Place
 Lew Bonn Company
 MONTREAL, CANADA 285 Craig Street, West
 Canadian Electrical Supply Co., Ltd.
 MUSKOGEE, OKLAHOMA 204 No. Twelfth Street
 Home Radio Mart
 NEW ORLEANS, LA. 902 Poydras Street
 Shuler Supply Company
 NEW YORK, N. Y. 100 Sixth Avenue
 Wholesale Radio Service Company
 NEWARK, N. J. 219 Central Ave.
 Wholesale Radio Service Company
 OAKLAND, CAL. 2085 Broadway
 Offenbach's
 READING, PENN. George D. Barbey Co. 404 Walnut Street
 SACRAMENTO, CAL. 1310 K Street
 Offenbach's
 SAN FRANCISCO, CAL. 1452 Market Street
 Offenbach's
 WASHINGTON, D. C. 938 F Street, N. W.
 Sun Radio & Service Supply Co.

Listings on this page do not necessarily imply endorsement by QST of the dealers or of other equipment sold by them.

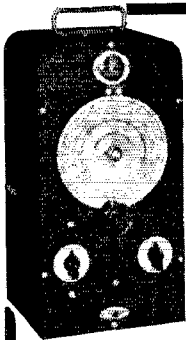

THE NEW BROWNING VISUAL FREQUENCY MONITOR

● Here is another brother to the famous Browning Preselctor. A real precision instrument which compares favorably to the \$400 models of frequency checking equipment. Exceptionally accurate and indispensable for logging DX stations and working close to the edge. Ideal when used with E.C. operation.

LOOK AT THESE FEATURES!

Visual as well as oral indication of zero beat. Quickly checked against WWV. Three oscillators covering Ham bands accurately checked against the built in 100-1000 KC oscillator. Extremely high stability. Band spread on all amateur bands. 5" calibrated vernier dial. Five tube circuit including electric eye. Dial can be read on 14 MC. to 2000 cycles. On 56 MC. to 20000 cycles. Only \$27.45 less tubes.

BROWNING 100-1000 KC STANDARD

Here is an adjustable oscillator standard used in circuits described in June, '38, January, '39, and April, '39 QST. Designed for use with 6SK7 oscillator. Provides means for zero beating at 100 and 1000 KC oscillator with WWV. Only \$3.45.

Send today for complete literature fully describing the newest additions to the famous Browning Family IT'S FREE.

BROWNING LABORATORIES
WINCHESTER, MASS.

Export Dept. 461-4th Av., New York, N. Y., U.S.A.

Your Inquiries Invited

When you need amateur equipment it is to your advantage to write to me. You get personal attention; 6% terms financed by myself so you buy with less cost and more convenience; fair trade-in value for your equipment; ten day trial of all receivers; and my cooperation in every way to see that you are 100% satisfied. For any equipment, the latest information and technical help, write to W9ARA.

Compare My Terms with Others

Model and Receiver	Cash Price	Down Payment	12 Monthly Payments
Howard 460.....	\$ 79.95	\$17.99	\$5.47
The new SX-23.....	115.50	23.10	8.16
RME-70.....	138.60	27.72	9.79
HQ-120X and NC101X....	129.00	25.80	9.11
NC100A.....	120.00	24.00	8.48
NC80X and NC81X.....	99.00	19.80	6.99
Bretting 49 and S16.....	99.00	19.80	6.99
NC-44 and S-20.....	49.50	9.90	3.49

Also HRO, Bretting 9, Howards, Sargents, all others

Similar terms on Hallicrafters, National, Harvey, RCA, RME, Temco transmitters and Thordarson, National, U.T.C., Utah, Kits.

Bob Henry

W9ARA

BUTLER

MISSOURI

ma., leaving the antenna coupling unchanged. The no-load value in this case is 22 ma. The bias required will be in the vicinity of 70 volts. With a conventional power supply the plate voltage will rise somewhat when the suppressor bias is increased, but the operating conditions will be quite satisfactory if the plate current is simply halved. When changing frequency the loading on the final should be kept as close as possible to the original adjusted value in order to have the suppressor bias be correct.

Using an oscilloscope to check modulation, positive peaks of well over 100 per cent modulation did not flatten out. The plate current fluctuated slightly when the peaks ran over 100 per cent and by watching the final amplifier plate current while talking into the microphone, the modulation could be maintained near the 100 per cent mark by allowing an occasional wiggle. Checking with the oscilloscope proved this to be an accurate method of preventing overmodulation. However, with different loading this was not always true, so it is best to make careful checks before using this method.

The suppressor bias was obtained from "B" batteries since the transmitter was to be used for portable work at times. This bias could, however, be taken from a "B" eliminator. The regulation does not have to be as good as in the case of other bias supplies, since at 100 per cent modulation the suppressors only just begin to draw current. An old "B" supply loaded with its bleeder resistance should work satisfactorily.

The transmitter should be mounted where it is protected from mechanical shocks, since vibration is the worst offender in upsetting the stability of the oscillator. Rapping the chassis gave a loud "pong" at the receiving end, but this was largely due to shock to the oscillator tube. It might be possible, in laying out the transmitter with this in mind, to eliminate a good proportion of this trouble.

Typical readings are: Oscillator plate current, 23 ma., amplifier grid current, 5 ma., and amplifier plate current, 40 ma. The audio end of the transmitter takes 11 ma. The total load on the 300-volt power supply is 105 ma. The discrepancy in these figures is accounted for by the absence of screen and bleeder currents in the individual readings.

BOOTH 830 AT THE
N.R.T. SHOW, CHICAGO

See the Latest Developments in Vertical Radiators and Beam Antennas

No matter what type of beam or array you plan, you can build it better with Premax Elements. Send for catalog and special prices.

PREMAX PRODUCTS
DIV. CHISHOLM-RYDER CO., INC.

3919 Highland Ave.

Niagara Falls, N. Y.

SEND FOR TECHNICAL
BULLETIN H-3

HAM-ADS

(1) Advertising shall pertain to radio and shall be of nature of interest to radio amateurs or experimenters in their pursuit of the art.

(2) No display of any character will be accepted, nor can any special typographical arrangement, such as all or part capital letters be used which would tend to make one advertisement stand out from the others.

(3) The Ham-Ad rate is 15¢ per word, except as noted in paragraph (6) below.

(4) Remittance in full must accompany copy. No cash or contract discount or agency commission will be allowed.

(5) Closing date for Ham-Ads is the 25th of the second month preceding publication date.

(6) A special rate of 7¢ per word will apply to advertising which, in our judgment, is obviously non-commercial in nature and is placed and signed by a member of the American Radio Relay League. Thus, advertising of bona fide surplus equipment owned, used and for sale by an individual or apparatus offered for exchange or advertising inquiring for special equipment, if by a member of the American Radio Relay League takes the 7¢ rate. An attempt to deal in apparatus in quantity for profit, even if by an individual, is commercial and all advertising by him takes the 15¢ rate. Provisions of paragraphs (1), (2), (4) and (5) apply to all advertising in this column regardless of which rate may apply.

Having made no investigation of the advertisers in the classified columns, the publishers of QST are unable to vouch for their integrity or for the grade or character of the products advertised.

QUARTZ — direct importers from Brazil of best quality pure quartz suitable for making piezo-electric crystals.

Diamond Drill Carbon Co., 719 World Bldg., New York City.

RADIO engineering, broadcasting, aviation and police radio, servicing, marine and Morse telegraphy taught thoroughly. All expenses low. Catalog free. Dodge's Institute, Byrd St., Valparaiso, Ind.

USED receivers. Bargains. Cash only. No trades. Price list 3¢. W3DQ, Wilmington, Del.

QSL's, all colors, cartoons, snappy service. Write for free samples today. W1BEF, 16 Stockbridge Ave., Lowell, Mass.

CALLBOOKS — Summer edition now on sale containing complete up-to-date list of radio hams throughout entire world. Also world prefix map, press schedules and new time conversion chart. Single copies \$1.25. Canada and foreign \$1.35. Radio Amateur Call Book, 610 S. Dearborn, Chicago.

QSL's, Cuts, Cartoons. Free samples. Theodore Porcher, 7708 Navaho, Philadelphia, Pa.

IPS rubber crystal. QSY remotely, varies completely 160 to 10 meters. Approximately 20 watts output, \$19.80. Radio Apparatus Mfg., 1522 N. Clark, Chicago, W9IPS.

MACAUTO code machines: low monthly rental 50,000 words practice tapes. Write N. C. Ayers, 711 Boylston St., Boston, Mass.

QSL's, SWL's. 100 — 3 color — 75¢. Lapco, 344 W. 39th, Indianapolis, Ind.

CRYSTALS — unconditionally guaranteed, X-cut, 1750-2000; 3500-4000; ± 20 kc., \$1.; ± 5 kc., \$1.50; spot frequency, \$2.50. Three small, X-cut, 80 meter blanks, including carborundum \$1.45. Holders, \$1. William Threm, W8FN, 3071 Moosewood St., Cincinnati, Ohio.

1000 watt G.E. transformers 1100-2200-4400 volts each side c.t. Guaranteed. \$13.50. Dawson, 5740 Woodrow, Detroit, Mich.

QSL's — two colors. Samples. W9RUJ.

ROTARY beams. Television kits. Servicemen, write for Service Man list. Orders prepaid. Special discounts. Amateur headquarters. Write for Amateur list. Remember, I sell all lines of transmitting equipment. Write to Southern Ohio's only amateur owned amateur business. Jos. N. Davies, W8ANT, 2767 No. Bend Rd., Sta. A, Cincinnati, Ohio.

CRYSTALS: write for quotations on amateur and commercial frequency crystals. Catalog, Ham Crystals, 1104 Lincoln Place, Brooklyn, New York.

CREL products. A new line of high quality economical transmitting units. Send for catalog describing exciters, R.F. amplifiers, power supplies, Class B amplifiers. Start with foundation unit and add later. Nothing to become obsolete. Lifetime quality. Cincinnati Radio Engineering Labs., Box 2, Sta. A, Cincinnati, Ohio.

FREE catalog. Order direct or from dealers. 160-80 meter Y crystals, 75¢. Faberadio, Batavia, Ill.

QSL's — samples. Brownie, W3CJI, 523 No. Tenth St., Allentown, Pa.

CRYSTALS, mounted, 80-160 \$1.25, V-cut 40 \$2.25. R9 Crystals, 388 Murray Ave., Arnold, Pa.

2 KW signal — 100 watts does it with new 4 element beam. Bassett's Handbook tells how. Quarter brings it and our bulletins. Hollow shaft rotor-head for your motor, \$17.50. Motorized, \$25. Selysynchronous indicator added (to any beam), \$9. Telescoping, tapered low-cost aluminol alloy elements. Bassett products. Rotary Array Service, W8MLL.

500 watt phone and CW transmitter complete, ready to operate. Make cash offer. W3EYT.

BRAND new, guaranteed, radio tubes — 25¢ each. Details — Box 37, Sta. P, Brooklyn, N. Y.

TOO many crystals. Swap or sell LD2's. W9NHF.

QSL's, **QSL's**, printed same day order received. Samples? W8DED, Holland, Mich.

SELL: SW-3, power supply, four sets bandspread coils. \$15. or trade. W6GTE.

WANT good used RME DB-20 for cash — state price. Magner, Malta, Mont.

SELL slightly used pair Taylor 203A's — \$10. W9ULJ.

FOR sale — Allstar 500 watt phone transmitter — complete — excellent condition — commercially built. Best offer. W9ZAV, 118 Bradford, Plattville, Wis.

REGULATED power supplies, complete, wired, \$10, each less tubes needed 6SJ7, 83, 2A3. Wendel Calkins, Lamberton, Minn.

QSL's — don't buy until you write Radio Printer, Union, N. Y.

SELL: Collins 4A xmtr, perfect condition, \$30. W. H. Kuhlmeier, 2198 Roanoke Rd., San Marino, Cal.

WANTED: good microscope — swap ham equipment. W2GYA.

QSL's. Most popular cards by Maleco, 1805 St. Johns Place, Brooklyn, N. Y.

HAMMARLUND Standard Pro complete, \$25.; Peak pre-selector, covers 10 meters, \$7.50. W9VGS, Hutchinson, Kansas.

SELL: DB-20 RME-69, matched speaker. New condition. Best offer. W1JPT.

QSL samples? Stamp. W8BZK, Newark, Ohio.

R.F. relays in kits. Assemble yourself and save half. Postal bringers details. W9WHE, 2910 38th St., Des Moines, Iowa.

CRYSTALS airmailed: June only. 40X, \$1.50; 20 meter mounted, \$3.95. Commercial crystals quoted. C-W Mfg., 1170 Esperanza, Los Angeles.

SACRIFICE pair Taylor T200's. Factory cartons, unopened. New sockets included. \$38. cash; or \$25. cash, balance equipment. Best offer takes. W8PWJ.

SELL 50 watt modulator, 6L6G output. Complete. See 1939 Handbook, Pages 236, 237, 238. \$30 cash or best offer. W8PWJ.

TELEPLEXES, Instructographs, omnigraphs, receivers bought, sold, traded. Ryan's, Hannibal, Mo.

SELL or swap: Eastman Duo-620 camera; leather carrying case; range finder. Want 2000 volt power supply or what have you? W9QOB.

FOR sale: complete 400 w. transmitter, also Sky Challenger receiver. For details write W9YBN.

CRYSTALS in plug-in heat dissipating holders, 160-80, \$1.25; (no Y cuts); 40X, \$1.60. C.O.D's accepted. Pacific Labs., 344 Fetterly, Los Angeles.

SACRIFICE: Marine 18-A, 802-802-803 final, tubes, composite antenna tuner. 160 watts CW, 50 watts fone. \$120. f.o.b. Mo. Reason: sickness. Dub Evely, KFYR, Bismarck, N. Dak.

EMERSON dynamos 6 volt input, 220 volt 40 ma., new, \$3. — reconditioned, \$2. National FB7, \$15., coils, \$2.50; SW3, SW5, \$7., coils, \$1; Hallierator SX11, \$59.; Sky-Buddy, \$16.; crystal Comet Pro, \$29. W9KDH, Walter Ashe Radio, 1100 Pine, St. Louis.

WANT auto radio, 807's, midjet variables; trade meters, AmerTran audios. W6QBK, 4849 Carpenter, No. Hollywood.

QSL's. Prices cut. June, July only. Stamp brings highest quality samples. Fritz, 455 Mason, Joliet, Ill.

CASH takes: commercial styled 1500-2500 volt, 300 ma. power supply-cabinet, UTC parts, two new 866A's, \$29. Ditto, chassis, 1200 volt, 250 ma., with new RK19, \$14.75. One each unused RK20, 804, \$9.75 each, new RK19, \$3.50. Coto-Coil 160 and 20 meters xmtr coils, \$1.50. B&W ditto, 160BX, 20BX, \$1.75 pair. Two new airplane luggage portable cases, 12" x 9", \$3.50 each. Transducer bullet mike, stand, \$11. R. Silver, 40 W. Schiller, Chicago.

BARGAINS: World's most complete stock of reconditioned guaranteed amateur receivers and transmitters all shipped on ten-day free trial. Practically all models at big savings. Save up to 60%. Terms, list free. Write, W9ARA, Butler, Mo.

SEVERAL types relays, \$1. Telephone mikes, other parts. List, stamp. R. White, 11030 Hermosa, Chicago.

TRANSFORMERS — power, filament, and special transformers designed, rebuilt, or rewound to your exact specifications. Let us solve your transformer problems and save you money. Satisfaction guaranteed. Liberal trade-in allowance on your old transformers! Let us quote on your requirements. Ham Transformer Service, 2060 Simon St., Philadelphia, Pa.

SELL: 15 dial omnigraph, good condition. Offer? W9LG, 201 Miami Club Drive, Mishawaka, Ind.

THERE is no substitute for dependable crystal control, Eidson T9 crystals assure this dependability with economy. Fracture resisting, high activity type: 40 and 80 meter bands or 7300-7500 Kc range. \$1.60 postpaid. A fully guaranteed product. Improved T9 ceramic holders, \$1. C.O.D.'s accepted. Fine commercial crystals on order, inquire. Sold by: Pemberton Labs., Ft. Wayne, Ind.; Hieronymus Radio, 88-84 209th, Queens Village N. Y.; Cleveland Radio Supply, 464 E. 117th, Cleveland, Ohio; Radio Doc, 721 S. Main, Los Angeles, Cal.; Frank Anzalone, 375 W. 46th, N. Y. C.; Henry Radio Shop, Butler, Mo.; Radio Atlas, Tampico, Mexico; Casa Edison, Havana, Cuba; Distribuidora Mexicana de Radios, Monterrey, Mexico; Hamrad Wholesale, Kensington, London, Eng.; or Eidson's, Temple, Texas.

HAMMARLUND Pro. 5 bands, 10-250 meters. Cost \$169. — sell \$35, plus shipping. McArdle, Rm. 815, 8 Bridge St., N. Y.

METER repair. Amateur, service, and commercial instruments. Braden Engineering Co., 1809 Fifth Ave., Dayton, Ohio.

INSTRUCTOGRAPH — senior model, with code tapes — practically new — \$12. W4FPP, 2063 Gilmore, Jacksonville, Fla.

QSL'S. W8OKP, Wilkinsburg, Pa.

DOUGLAS Universal modulation transformers offer unbeatable price, quality, guarantee, plus free delivery service. For details write: W9LXR, Rice Lake, Wis.

QSL'S. Free samples. Printer, Corwith, Iowa.

TRADE: RCA TMV122B three-inch oscillograph for Guthman frequency monitor. W7BL.

NC101X — used one month only. Must sell — \$100. W1EMH.

SICKLES COILS

SECURE A COPY OF OUR NO. 939
CATALOG FROM YOUR JOBBER

F. W. SICKLES COMPANY

300 Main Street

Springfield, Mass.

RADIO ENGINEERING



RCA Institutes offer an intensive course of high standard embracing all phases of Radio and Television. Practical training with modern equipment at New York and Chicago schools. Also specialized courses and Home Study Courses under "No obligation" plan.

Illustrated Catalog on request

RCA INSTITUTES, INC. Dept. ST-39

A Radio Corporation of America Service

75 Varick St., New York

1154 Merchandise Mart, Chicago

NOW! FOR LIMITED TIME ONLY

Genuine Improved
Latest Model

VIBROPLEX

LIGHTNING BUG

only \$13.75

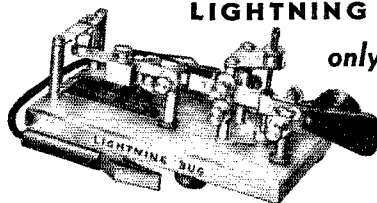

Heavy Black Base
Nickel-plated
\$2.00
Additional

Don't wait! Here's the opportunity to own this GREAT NEW EASY ACTION VIBROPLEX at the lowest price in its history. Think of it! Only \$13.75 brings you this brand new latest model LIGHTNING BUG that really eliminates tiring key work and makes sending easier and better for everyone. You'll like its many new features, its easier action that makes it so easy to use. Write, wire or telephone your order to-day. Money order or registered mail. This unusual low price offer is limited and may be withdrawn without notice. Don't miss this chance to own the bug WINNERS use. Send for latest catalog just off the press and new price list. Write NOW!

THE VIBROPLEX CO., INC.
832 Broadway, New York, N. Y.

JUNIOR
only \$12.50
Small, highly
efficient BUG.
Complete with
wedge and cord

*Special Prices and Terms
on Rotaries*

SIX NEW COMPLETE ROTARY BEAM ANTENNAE by BASSETT

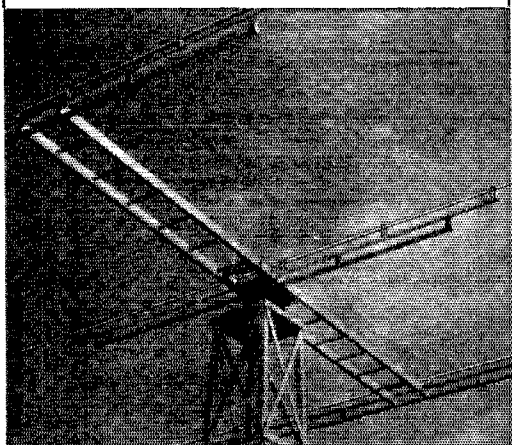

More good news from Delaware Radio . . . Our special payment plan on the six new Bassett Rotary Beam Antenna Systems is available to all U.S.A. amateurs . . . Remember, 100 watts into a Bassett Beam means more than 1000 watts into a poor antenna . . . Get your copy of the new Bassett Beam Handbook, 39 pages of valuable information for 25c postpaid . . . Place your order now to insure prompt delivery . . . Don't delay. Write us at once.

BASSETT BEAMS

COMPLETE WITH ROTOMATIC DRIVE

	10 meter	20 meter
2 Element	\$9.04	\$10.48
3 Element	10.35	11.79
4 Element	11.55	13.31

*Amounts shown are down payment and
nine monthly payments*

DELAWARE RADIO SALES CO.

405 Delaware Ave. Wilmington, Del.

WILLARD S. WILSON — W3DQ

Your Nearby Dealer Is Your Best Friend

Your nearby dealer is entitled to your patronage. He is equipped with a knowledge and understanding of amateur radio. He is your logical source of advice and counsel on what equipment you should buy. His stock is complete. He can supply your needs without delay. His prices are fair and consistent with the high quality of the goods he carries. He is responsible to you and interested in you.

One of these dealers is probably in your city—Patronize him!

ATLANTA, GEORGIA

Wholesale Radio Service Company, Inc.
265 Peachtree Street
"The World's Largest Radio Supply House"

NEWARK, N. J.

Wholesale Radio Service Company, Inc.
219 Central Avenue
"The World's Largest Radio Supply House"

BALTIMORE, MARYLAND

Radio Electric Service Co.
3 N. Howard St.
Everything for the amateur

NEW HAVEN, CONNECTICUT

Hatry & Young, Inc.
1172 Chapel Street
National, Taylor, Triplett, Radiotron, RME, Howard, etc.

BOSTON, MASS.

Wholesale Radio Service Company, Inc.
110 Federal Street
"The World's Largest Radio Supply House"

NEW YORK, N. Y.

Wholesale Radio Service Company, Inc.
100 Sixth Avenue
"The World's Largest Radio Supply House"

BRONX, NEW YORK

Wholesale Radio Service Company, Inc.
542 East Fordham Road
"The World's Largest Radio Supply House"

NEW YORK, N. Y.

Harrison Radio Company
12 West Broadway
Harrison Has It! Phone WOrth 2-6276 for information or rush service

BUFFALO, NEW YORK

Radio Equipment Corp.
326 Elm Street
W8PMC and W8NEL — Ham, service and sound equipment

PHILADELPHIA, PENNSYLVANIA

Eugene G. Wile
10 S. Tenth Street
Complete Stock of Quality Merchandise

BUFFALO, NEW YORK

Dymac Radio
1531 Main Street at Ferry
New Store — New Stock — New Equipment

RICHMOND, VIRGINIA

The Arnold Company
Broad at Harrison St.
W3EQQ — "The Virginia Ham Headquarters" — W3FBL

JAMAICA, L. I., NEW YORK

Wholesale Radio Service Company, Inc.
90-08 166th Street (Merrick Road)
"The World's Largest Radio Supply House"

TORONTO, CANADA

A & A Radio Service Supply
101 Queen Street, West
Canada's Foremost Radio Supply House

MONTREAL, CANADA

Canadian Elec. Supply Co., Ltd.
285 Craig St., W.
Quality parts and equipment for discriminating buyers

WINNIPEG, CANADA

Electrical Supplies, Ltd.
306-10 Ross Avenue
Western Canadian Amateur Headquarters for Leading Lines

YOU ARE PROTECTED
WHEN YOU BUY FROM

QST

ADVERTISERS

“Advertising for QST is accepted only from firms who, in the publisher’s opinion, are of established integrity and whose products secure the approval of the technical staff of the American Radio Relay League.”

Quoted from QST’s advertising rate card.

Every conceivable need of a radio amateur can be supplied by the advertisers in QST. And you will know the product has the approval of the League’s technical staff

Index to Advertisers

Acme Electric & Mfg. Company, The.....	95
Aerovox Corp.....	90
Aladdin Radio Industries, Inc.....	93
American Radio Institute.....	103
Astatic Microphone Laboratory, Inc.....	70
Barker & Williamson.....	97
Bee Engineering Company.....	95
Bliley Electric Company.....	95
Browning Laboratories, Inc.....	106
Candler System Company.....	94
Capitol Radio Engineering Institute.....	98
Cardwell Mfg. Corp., Allen D.....	62
Centralab.....	4
Collins Radio Company.....	Cov. 2
Communications Measurements Laboratory.....	78
Cornell-Dubilier Electric Corp.....	101
Coto-Coil Company, Inc.....	99
Crosley Corp., The.....	74
Delaware Radio Sales Company.....	108
Dodge’s Institute.....	101
Eitel-McCullough, Inc.....	67
Gardiner-Levering Company.....	101
General Radio Company.....	66
Gross Radio, Inc.....	102
Guardian Electric Mfg. Company.....	80
Guthman & Company, Edwin L.....	86
Hallcrafters, Inc., The.....	1, 2
Hammarlund Mfg. Company, Inc.....	65, 73
Harvey Radio Company.....	92
Harvey Radio Laboratories.....	69
Heintz & Kaufman, Ltd.....	97
Henry Radio Shop.....	106
Hinds & Edgarton.....	103
Howard Radio Company.....	63
Hygrade Sylvania Corp.....	72
Hytronic Laboratories.....	64
Instructograph Company.....	95
Ken-Rad Tube & Lamp Corp.....	101
Kenyon Transformer Company, Inc.....	7
Mallory & Company, Inc., P. R.....	60
Massachusetts Radio School.....	95
McGraw-Hill Book Company, Inc.....	104
Meissner Mfg. Company, Inc.....	77
Millen Mfg. Company, Inc., James.....	Insert
Mims Radio Company.....	99
National Company, Inc.....	Cov. 3, 59, 82, 93
New York YMCA Schools.....	99
Ohmite Mfg. Company.....	102
Par-Metal Products Corp.....	82
Port Arthur College.....	93
Precision Apparatus Corp.....	68
Precision Piezo Service.....	101
Premax Products.....	106
RCA Institutes, Inc.....	108
RCA Mfg. Company, Inc.....	Cov. 4, 98
Radio Mfg. Engineers, Inc.....	111
Radio Parts Trade Show.....	91
Radio Shack, The.....	81
Radio Transceiver Laboratories.....	104
Raytheon Production Corp.....	61
Scientific Radio Service.....	99
Shuler Supply Company.....	100
Sickles Company, F. W.....	108
Solar Mfg. Corp.....	94
Specr Carbon Company.....	99
Standard Electrical Products Company.....	99
Standard Transformer Corp.....	103
Sun Radio Company.....	100
Taylor Tubes, Inc.....	5
Teleplex Company.....	86
Terminal Radio Corp.....	96
Thordarson Electric Mfg. Company.....	71
Tibbatts’ Laboratories.....	101
Triplet Electrical Instrument Company, Inc.....	103
United Transformer Corp.....	112
Utah Radio Products Company.....	75
Valpey Crystals, The.....	103
Verti-Flex Division.....	76
Vibroplex Company, Inc., The.....	108
Wholesale Radio Laboratories.....	96
Wilson, Willard S.....	108
Yaxley.....	60

RME

TIME WILL TELL

INSIDE FACTS

(The Fifth of a Series)

In line with every detail of construction in an RME RECEIVER is the sturdiness of the chassis frame.

RME uses an aluminum casting for such a chassis base, *first*:

Because critical adjustments must be held when a receiver is set to operate crystal control, especially at the higher frequencies; and *second*:

Because nothing is more solid, rigid, and yet so light in weight as an aluminum casting for such a base.

Sure—our cost is higher, but *such a foundation* is more than worth the cost.

Radio Mfg. Engineers, Inc.

111 Harrison Street

Peoria, Illinois

Unprecedented VALUE

in this new series of transformers designed specifically for AMATEUR and PA Equipment.

All units are uniform in appearance and finished in rich GRAYCRINKLE ENAMEL. Designed exclusively for amateur service, these units represent Maximum Value at Low Cost . . .

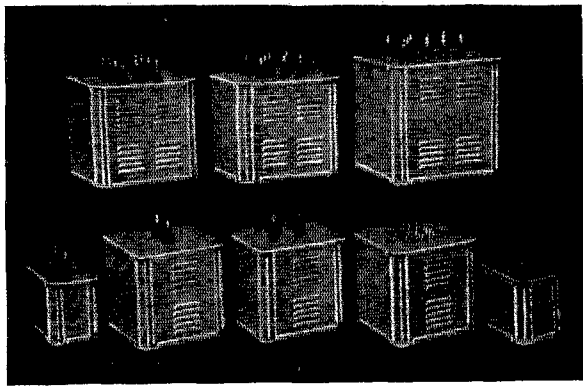
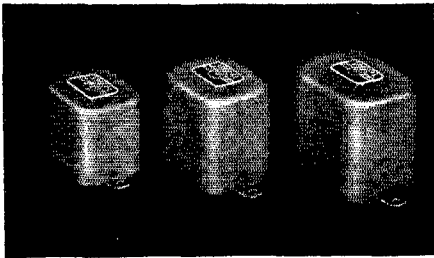

INPUT and UNIVERSAL DRIVER TRANSFORMERS

Type No.	Application	Ratio	Net Price
S-1	1 plate to 1 grid	334:1	\$1.35
S-2	1 plate to 2 grids	2:1	1.59
S-3	1 plate to 1 or 2 grids compact type	4:1 2:1 P.P.	1.29
S-4	1 plate to 2 grids wide range response	1:1	2.10
S-5	Single or double button mike or line to 1 grid hum-bucking type	16:1	1.80
S-6	Single or double button mike or line to 1 grid, compact type	16:1	1.20

Type No.	Primary	Typical Output Tubes	Net Price
S-8	All single tubes like: 6C5, 30, 49, 53, 79, 89, 6A6, 45, 46, 2A3	19, 30, 49, 79, 89, 2A3, 45, 46, 6L6, 42, 59	\$1.65
S-9	P. P. tubes like: 45, 59, 2A3, 6B5, 6L6	46, 4-46, 841, 210, 801, RK-18, 800, 203A, 838, 805, 50T, 830B	2.25
S-10	P. P. 56, 6C5, etc.	AB 45, 42, 2A3, 6L6	2.10

UNIVERSAL OUTPUTS to LINE and VOICE COIL

Type No.	Tubes and Pri. Ohms	Sec. Ohms	Power	Net Price
S-14	Single tubes: 2500 ohms for 2A3, 6A3, 6ASG, 6B4G, 6L6, 6V6, 25L6 4,000 ohms for 2A3, 6Fo triode, 12A5, 25A6, 43, 45, 50, 71A 7,000 ohms for 2A5, 6F6, 6K6, 70, 31, 34, 47 10,000 ohms for 6G6, 38, 41	2, 8, 15, 500	10 W	\$1.95
S-15	P. P. tubes: 4,000 ohms for 25L6, 6V6G 5,000 ohms for 2A3, 6A3, 6ASG, 6B4G, 45 18,000 ohms for 19, 71G, 30, 49, 89, 6Z7C, 6AC5G, 53, 6A6, 6N6, 6N7, 6B5	2, 8, 15, 500	12 W	2.10
S-16	3,000 ohms for 2A3, 6A3, 6ASG, 6B4G, AB 6,000-6,000 ohms for 2A5-6F6-42 triodes AB, 46, 59, 6L6 10,000 ohms for 6B5, 6V6, 2A5-6F6-42 pentodes AB	2, 8, 15, 500	30 W	2.85

UNIVERSAL OUTPUT TRANSFORMERS

Any modulator tubes to any RF load

Type No.	Audio Power	Net Price
S-18	12 watts	\$2.10
S-19	30 watts	2.85
S-20	55 watts	3.90
S-21	110 watts	6.00
S-22	250 watts	8.40

PLATE TRANSFORMERS

Primary 115 V. — 50, 60 Cycles

Type No.	High Voltage	D.C. Voltages*	Rectifier Fil.	Fil. No. 1	Fil. No. 2	Net Price
S-39	490-300-0-400-490 175 Ma.	400/310	5V.-3A.	2.5 V. C. T.-6A	6.3 V. C. T.-4A	\$3.30
S-40	525-425-0-425-525 250 Ma.	400/310	5V.-3A.	6.3 V. C. T.-3A	6.3 V. C. T.-3A	3.60
S-41	600-0-600 300 Ma.	475	5V.-3A.	7.5V. tapped 6.3V-3A	6.3 V. C. T. 2A	3.60

* Based on two section filter, choke input.

Type No.	High Voltage	D.C. Voltages*	D. C. Current	Net Price
S-45	900-750-0-750-900	750/620	200 Ma.	\$3.90
S-46	1000-750-0-750-1000	825/600	300 Ma.	5.70
S-47	1500-1250-1000-0-1000-1250-1500	1275/1050/825	300 Ma.	7.20

* Based on two section filter, choke input.

FILAMENT TRANSFORMERS

Primary Tapped 105, 115 Volts — 50/60 Cycles

Type No.	Secondary Volts	Secondary Current	Insulation	Net Price
S-53	2.5 V. C. T.	10 A.	1,500 V.	\$1.35
S-54	5 V. C. T.	4 A.	2,500 V.	1.35
S-55	6.3 V. C. T.	3 A.	1,500 V.	1.35
S-57	2.5 V. C. T.	10 A.	10,000 V.	1.80
S-59	5 to 5.25 V. C. T.	13 A.	5,000 V.	2.10
S-61	7.5 V. C. T. tapped 6.3 V. C. T.	8 A.	3,000 V.	2.10
S-62	10 V. C. T.	10 A.	3,000 V.	2.40

FILTER and SWINGING CHOKES

Type No.	Service	Inductance	Current	Resistance	Net Price
S-25	Filter	30 Hy.	30 Ma.	800 ohms	\$1.20
S-26	Filter	15 Hy.	60 Ma.	230 ohms	1.20
S-27	Filter	30 Hy.	75 Ma.	350 ohms	1.65
S-28	Filter	20 Hy.	100 Ma.	350 ohms	1.45
S-29	Filter	6 Hy.	175 Ma.	95 ohms	1.65
S-30	Swinging	5/25 Hy.	175 Ma.	95 ohms	1.65
S-31	Filter	15 Hy.	225 Ma.	120 ohms	2.10
S-32	Swinging	5/25 Hy.	225 Ma.	120 ohms	2.10
S-33	Filter	15 Hy.	300 Ma.	90 ohms	3.00
S-34	Swinging	5/25 Hy.	300 Ma.	90 ohms	3.00

UNITED TRANSFORMER CORP.

Write: COMMUNICATIONS DIV. ★ 150 VARICK ST. ★ NEW YORK, N. Y.
EXPORT DIVISION: 100 VARICK STREET NEW YORK, N. Y. CABLES: "ARLAB"

QST for June, 1939, EASTERN Edition



PERFORMANCE AT LOW COST

If you judge receivers on the basis of performance per dollar of cost, you will find the National NC-44 an outstanding value. This seven tube superhet covers from 550 KC to 30 MC in four ranges. The full vision dial is calibrated accurately in frequency. A straight-line-frequency main condenser is used in conjunction with a separate band spread condenser, and both have inertia-type tuning. The performance of the NC-44 is remarkably fine, even at ten meters.



NC - 44

\$49.50

NET, Complete
with speaker
and tubes

NATIONAL COMPANY, INC., MALDEN, MASS.

Rated for **DEPENDABILITY**

... PROVED IN THE MOST EXACTING APPLICATIONS IN THE WORLD

Time and again, amateurs report having used RCA Transmitting Tubes far above their ratings. "They're a whole lot better than you say they are", some of these fellows claim. Others ask: "Why don't you raise the ratings?"

It would, of course, be easy to raise plate dissipation ratings on RCA's and feature them as "bargains." But remember: What a tube will stand on some occasional sprint and what it will handle regularly over a period of time are often two entirely different things.

That is why RCA ratings are made with no thought of intermittent operation. They are based on hard, *constant* use in the world's most exacting applications.

By proving their superiority on man-sized jobs such as commercial broadcasting, police radio, aviation, etc., these tubes have likewise proved themselves to be the outstanding buys for any amateur application you care to name. They're rated for users who demand real value in terms of real dependability—who realize that wattage rating is important only insofar as it is backed up with assurance of long, trouble-free performance *under all conditions of use.*

A HIGH-QUALITY TRIODE for EVERY PURPOSE

Rely on RCA's any time—all the time. They will not let you down!

- RCA 806** 150 Watts* Enclosed anode and other outstanding design features assure maximum ratings at frequencies as high as 30 megacycles. Driving power approximately 15-20 watts. **\$22.00**
- RCA 810** 125 Watts* Two RCA 810's will take one kilowatt of power at a plate voltage of only 2,000 volts and a driving power of 25 watts. A real money saver! **\$13.50**
- RCA 808** 50 Watts* Economical to operate, long on performance under the most severe conditions. Driving power approximately 8-9.5 watts. **\$7.75**
- RCA 809** 25 Watts* First choice of amateurs who demand real results at little cost. Unexcelled for rigs up to 100 watts output. Driving power approx. 2.5 watts. **\$2.50**

**Plate dissipation as conservatively rated for use as r-f power amplifier and oscillator, Class C Telegraphy.*

Ask for RCA Technical Manual TT3. 25c at your jobber's. Visit the RCA Television Exhibits at the Golden Gate International Exposition and the New York World's Fair



Radio Tubes

FIRST IN METAL—FOREMOST IN GLASS—FINEST IN PERFORMANCE

RCA MANUFACTURING CO., INC., CAMDEN, N. J.
A Service of The Radio Corporation of America

JAMES MILLEN

Announces

that on May first 1939, he completely withdrew from the National Company, Inc., in order to establish a new company to be devoted primarily to the design and manufacture of new radio communication products including component parts, receivers, and transmitters. The new company is known as the James Millen Manufacturing Company, Inc., 6 Pleasant Street, Malden, Massachusetts.