



august, 1939

25 cents

QST

devoted entirely to

amateur radio

In this issue:

FREQUENCY MODULATION

TWO-BAND ROTARY BEAM

PORTABLE AND EMERGENCY EQUIPMENT

COLLINS

51K

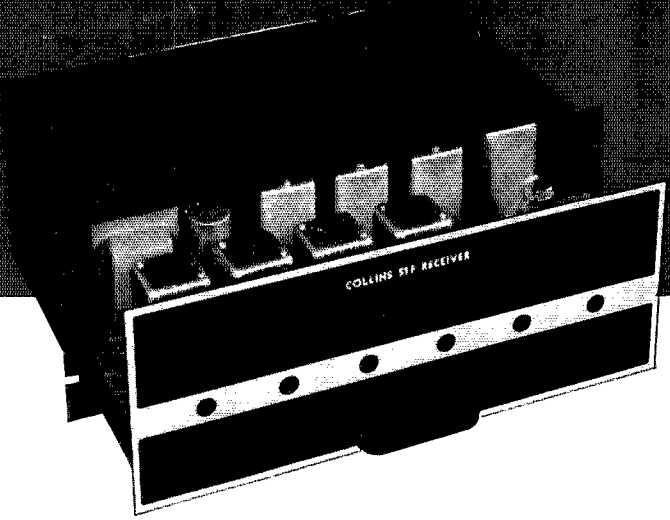

FREQUENCY RANGE: 1.5 mc to 20 mc.

CIRCUIT: Superheterodyne with 456 kc i.f.

FREQUENCY CHANGE: Interchangeable r-f units each having 2 to 1 tuning range.

FREQUENCY CONTROL: Either self controlled or crystal controlled high frequency oscillator can be supplied.

SELECTIVITY: Total band width 5 kc at 6 db down and 18 kc at 60 db down.

SENSITIVITY: 2 microvolts, 30% modulated at 400 c.p.s. for 50 milliwatts output and 6 db signal to noise ratio.

AUDIO FREQUENCY RESPONSE: Uniform within 6 db between 150 and 2500 c.p.s.

AUTOMATIC GAIN CONTROL: Audio output variation less than 10 db with signal input 10 microvolts to .5 volts.

IMAGE REJECTION: 75 db at 5000 kc.

POWER OUTPUT: 500 milliwatts into 500 or 8 ohm resistive load.

CW OSCILLATOR: Either self controlled or crystal controlled oscillator may be supplied for cw reception. Both oscillators are designed for low drift with respect to variation in line voltage and temperature.

AUDIO SQUELCH CIRCUIT: Either electronic or relay controlled circuits can be provided to disable the audio channel in the absence of received signal.

HUM: 50 db below rated output at any gain control setting.

POWER REQUIREMENTS: 115 volts 50/60 cycles a.c. with self contained rectifier.

MECHANICAL CONSTRUCTION: Drawer type designed for standard 19" relay rack mounting with 7" panel. Quick accessibility by plug-in connections between receiver chassis and cabinet. Each stage is assembled on an individual chassis with its particular terminal strip, thereby permitting a variety of circuit arrangements without excessive re-design cost.

SPECIAL FEATURES: A.V.C. circuits available at terminals for use with diversity reception. Test jack in i-f cathode circuit for convenience of alignment. Remote control facilities supplied on special order.

Collins receivers are built with our usual care of construction and are of the same high quality that has made Collins equipment world famous.

COLLINS RADIO COMPANY

CEDAR RAPIDS, IOWA

NEW YORK, N. Y.: 11 WEST 42 STREET

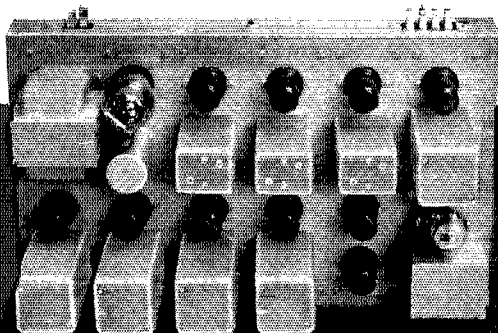

FIXED TUNE

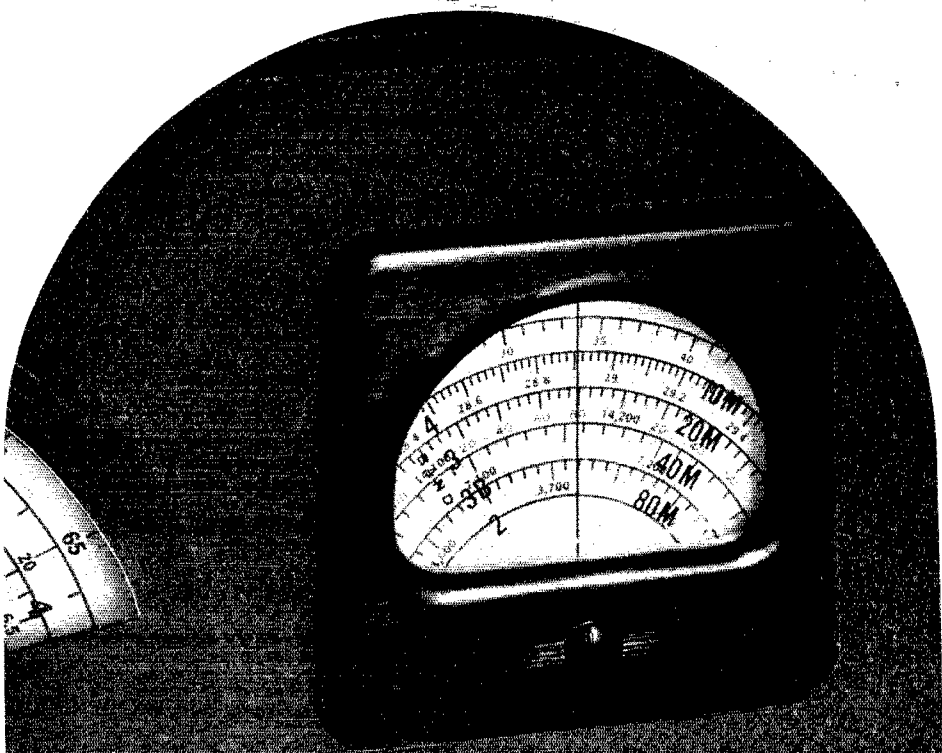

FREQUENCY METER TUNING!*

\$69.50

with crystal less speaker

Skyrider
DEFIANT

Frequency Meter Tuning (or any similar system) is available nowhere else at less than *twice* this price!

*Copyright the hallicrafters inc.

the hallicrafters inc.

CHICAGO, U. S. A.



W9WZE

Fourth Release!

... of the HT-6

When we announced our 25 watt rig we produced a reasonable quantity of them and went on to the development of other communications equipment. Orders made us produce another quantity immediately! Then another production! Then a fourth! And all in three months. Why? We know we did a very careful job in the design. We worked especially hard to make that attractive price of \$99.00 possible. We know it puts out a good signal. Possibly those are some of the reasons why there has been so much interest in the HT-6

the hallicrafters inc.
CHICAGO, U.S.A.

AUGUST 1939

VOLUME XXIII

NUMBER 8



STAFF

Editorial

KENNETH B. WARNEB, W1EH
Editor and Business Manager

CLARK C. RODIMON, W1SK
Managing Editor

GEORGE GRAMMER, W1DF
Technical Editor

DONALD H. MIX, W1TS
BYRON GOODMAN, W1JFR
Assistant Technical Editors

VERNON CHAMBERS, W1JEG
Technical Information Service

JAMES J. LAMB, W1AL
Consultant

Advertising

F. CHEYNEY BEEKLEY, W1GS
Advertising Manager

CHARLES BRUNELLE
Asst. Advertising Manager

Circulation

DAVID H. HOUGHTON
Circulation Manager

RALPH T. BEAUDIN, W1BAW
Asst. Circulation Manager



OFFICES

38 La Salle Road
West Hartford, Connecticut

Subscription rate in United States and Possessions and Canada, \$2.50 per year, postpaid; all other countries, \$3.00 per year, postpaid. Single copies, 25 cents. Foreign remittances should be by international postal or express money order or bank draft negotiable in the U. S. and for an equivalent amount in U. S. funds.

Entered as second-class matter May 29, 1919, at the post office at Hartford, Connecticut, under the Act of March 3, 1879. Acceptance for mailing at special rate of postage provided for in section 1103, Act of October 3, 1917, authorized September 9, 1922. Additional entry at Concord, N. H., authorized February 21, 1929, under the Act of February 28, 1925. Additional second-class entries to cover sectional editions authorized March 20, 1935.

Copyright 1939 by the American Radio Relay League, Inc. Title registered at United States Patent Office.

QST

devoted entirely to

AMATEUR RADIO

PUBLISHED MONTHLY, AS ITS OFFICIAL ORGAN, BY THE AMERICAN RADIO RELAY LEAGUE, INC., AT WEST HARTFORD, CONN., U. S. A.; OFFICIAL ORGAN OF THE INTERNATIONAL AMATEUR RADIO UNION



CONTENTS

It Seems to Us	9
Splatter	10
Frequency Modulation Fundamentals <i>Daniel E. Noble, W1CAS</i>	11
The Two-Band Three-Element Rotary <i>E. E. Schroeder, W9TB</i>	16
Low-Pass Filters for Time-Delay Circuits <i>James H. Owens, W3ASZ</i>	19
Rocky Mountain Division Convention	20
Naval Communication Reserve Notes	21
Portable-Emergency Transmitters <i>A Symposium by W9ACO, W9TMY, W8AVD, W8NCM and W6QQH</i>	22
What the League Is Doing	30
Pacific-Southwestern Division Convention	31
Dr. Arthur C. Kennelley	31
Polystyrene: Its Electrical and Mechanical Characteristics <i>Herbert S. Riddle, W1DSK</i>	32
"5 and 10" From Shack or Car . . . <i>S. Gordon Taylor, W2JCR</i>	34
Central Division Convention	38
Henry C. Benner, W6NVE	38
How Would You Do It? <i>Feeding Rotatable Antennas for Continuous Rotation</i>	39
Maritime Division Convention	41
West Gulf Division Convention	41
Wisconsin State Convention	41
Dixie Jones' Owl Juice	41
U.H.F. Activity at Summertime Peak	42
Entertaining Uncle Oscar <i>Eric Adams, VE3ALG</i>	46
1.75-Mc. WAS Party Results	47
I.A.R.U. News	48
New Tubes <i>Eimac 75T</i>	49
Hints and Kinks <i>Kinks for Portable Transmitters . . . Code Practice Machine . . . Cheap Relays for Keying and Other Purposes . . . Link Neutralizing for Low-Capacity Tubes . . .</i>	50
New Apparatus <i>New Type Wire-Wound Resistor . . . New Radio-Control Relay . . .</i>	52
Correspondence from Members	53
Operating News	54
Hamfest Schedule	56
DX Notes	58
A.R.R.L. Official Observers	62
DX Century Club	64
Standard Frequency Transmissions	70
A.R.R.L. QSL Bureau	76
Safety ABC's	78
Hamads	91
QST's Index to Advertisers	94

SUMMER TIME

During JULY and AUGUST

A. R. R. L.



M
E
M
B
E
R
S
H
I
P

W
I
T
H

12

I
S
S
U
E
S

O
F

Q
S
T

with either

No.

or

No.

or

No.

Any one of the three combination offers for \$3.00 (\$3.25 U. S. Possessions and Canada, \$3.75 elsewhere) when sent **DIRECT** to American Radio Relay League, West Hartford, Connecticut, U. S. A. Otherwise combination prices do not apply. This offer applies to new entries, renewals or extensions.

is Special Offer Time

3 COMBINATION OFFERS

The Radio Amateur's Handbook

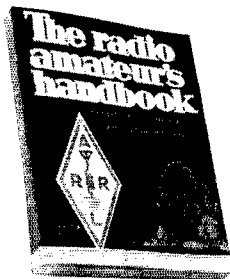

Three Log Books

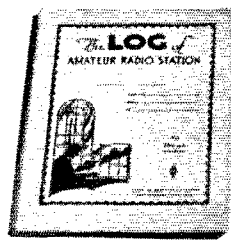
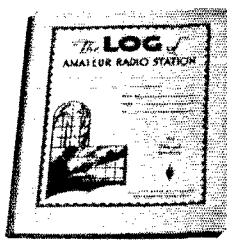

Four Pads Radiogram Forms

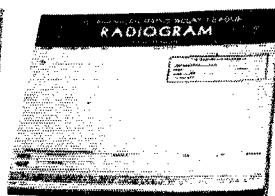
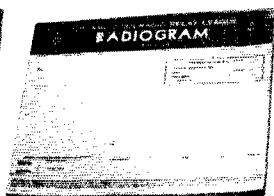
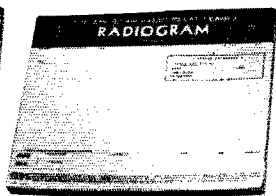
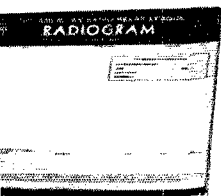

Please enter my membership-subscription for a period of one year. Begin QST with issue and send combination number.....to.....

Section Communications Managers of the A.R.R.L. Communications Department

All appointments in the League's field organization are made by the proper S.C.M., elected by members in each Section listed. Mail your S.C.M. (on the 16th of each month) a postal covering your radio activities for the previous 30 days. Tell him your DX, plans for experimenting, results in 'phone and traffic. He is interested, whether you are an A.R.R.L. member or get your QST at the newsstands; he wants a report from every active ham. If interested and qualified for O.R.S., O.P.S. or other appointments he can tell you about them, too.

ATLANTIC DIVISION				
Eastern Pennsylvania Maryland-Delaware-District of Columbia Southern New Jersey Western New York Western Pennsylvania	W3QP W3BAK W3CCO W8CSE W8OFO	John B. Morgan Edgar L. Hudson Lester H. Allen Ed Preston Kendall Speer, Jr.	Blue Bell Laurel, Delaware Trenton Tully Lowber	
CENTRAL DIVISION				
Illinois Indiana Kentucky Michigan Ohio Wisconsin	W9RMN W9VOG W9ARU W8DPE W8AO W9UIT	Leslie M. Dickson Noble Burkhardt Barrell A. Downard Harold C. Bird E. H. Gibbs Aldrich C. Krones	Edellyn Farms R. 4, Box 1 316 N. Longworth Ave. R.F.D. 2 405 Broad St. 3127-A West Madison St.	Waukegan Indianapolis Louisville Pontiac Wadsworth Milwaukee
DAKOTA DIVISION				
North Dakota South Dakota Northern Minnesota Southern Minnesota	W9WWL W9VOD W9ICZ W9VNO	Anton C. Theodos Dr. A. L. Russell Edwin L. Wicklund Millard L. Bender	c/o American Cafe R.F.D. 3 608 N. Huron Ave.	Minot Philip Kensington Spring Valley
DELTA DIVISION				
Arkansas Louisiana Mississippi Tennessee	WSABI W5DKR W5EWD W4DWS	H. E. Velte Eugene H. Treadaway Jewell W. Cole William Harold Walker	4415 West 12th St. 2749 Myrtle St. c/o City of McComb Water Dept. 2503 Belmont Blvd.	Little Rock New Orleans McComb City Nashville
HUDSON DIVISION				
Eastern New York N. Y. C. & Long Island Northern New Jersey	W2LU W2AZ W2GMN	Robert E. Haight E. L. Baunach Fred C. Read	511 South Holmes St. 102 Central Ave. 1014 North Ave.	Scotia Massapequa, L. I. Elizabeth
MIDWEST DIVISION				
Iowa* Kansas Missouri Nebraska	W9PJR W9ITEG W9OUD W9DI	L. B. Vennard Melvin D. Kirby Miss Letha Allendorf William J. Baner	P. O. Box 304 1015 W. 3rd St.	West Burlington Arlington Joplin Tobias
NEW ENGLAND DIVISION				
Connecticut Maine Eastern Massachusetts Western Massachusetts New Hampshire Rhode Island Vermont	W1CTI W1IIE W1HIL W1IAH W1BFT W1HRC W1KJG	Frederick Ellis, Jr. H. W. Castner Larry Mitchell William J. Barrett Carl B. Evans Clayton C. Gordon Clifton G. Parker	19 Merrill Rd. 147 Church 94 Howard St. 239 Columbia St. 163 South Main St. 192 Washington Ave. Box 537	Norwalk Damariscotta Melrose Adams Concord Providence Morrisville
NORTHWESTERN DIVISION				
Alaska Idaho Montana Oregon Washington	K7ENA W7EMT W7FL W7DXF W7FCG	Leo E. Osterman Carl Eichelberger G. A. Woodhouse Harold W. Johnston W. Beale	Customhouse Route 2 Holter Dam 205 North Grant St. R. 4, School Ave.	Wrangell Kuna Wolf Creek Pendleton Walla Walla
PACIFIC DIVISION				
Hawaii Nevada Santa Clara Valley East Bay San Francisco Sacramento Valley Philippines San Joaquin Valley	K6ETF W6BIC W6FBW W6TI W6CIS W6MDI KA1GR W6KUT	Francis T. Blatt Edward W. Heim Elbert Amarantes Horace R. Greer Kenneth E. Hughes Vincent N. Feldhausen George L. Rickard Edwin A. Andress	837 16th Ave. 509 Clarkmont St. 454 Washington St. 414 Fairmount Ave. 622-36th Ave. 113 South Quincy St. Box 849 2921 North Van Ness Blvd.	Honolulu Reno San Jose Oakland San Francisco McCloud Manila Fresno
ROANOKE DIVISION				
North Carolina South Carolina Virginia West Virginia	W4CYB W4HOE W3UVA W8HD	W. J. Wortman Ted Ferguson Charles M. Waff, Jr. C. S. Hoffmann, Jr.	P. O. Box 566 1213 College St. Box 1212 47 Lynwood Ave.	Morganton Columbia University Wheeling
ROCKY MOUNTAIN DIVISION				
Colorado Utah-Wyoming	W9EHC W7CLG	Carl C. Drumeller Ernest E. Parshall	1828 East Kiowa St. Salt Creek Electric Plant	Colorado Springs Midwest, Wyoming
SOUTHEASTERN DIVISION				
Alabama Eastern Florida Western Florida Georgia West Indies (Cuba-Isle-of-Pines- Porto Rico-Virgin Islands)	W4DGS W4DVO W4AXP W4AGI CM2OP	James F. Thompson L. A. Connolly Oscar Cederstrom Leland W. Smith Mario de la Torre	1203 South Perry St. 719 So. Willow Ave. Second St. & Bruce Ave. 2010 Pennsylvania Ave. Eseobar 110 (Altos)	Montgomery Tampa De Funiak Springs Augusta Habana, Cuba
SOUTHWESTERN DIVISION				
Los Angeles Arizona* San Diego	W6MQM W6OIF W6JRM	Ralph S. Click Cameron Allen Howard K. Breedlove	1038 Milwaukee Ave. 513 N. 3rd St. R. 2, Box 636	Los Angeles Phoenix San Diego
WEST GULF DIVISION				
Northern Texas Oklahoma Southern Texas New Mexico	W5DXA W5CEZ W5BHO W5ENI	Lee Hughes Carter L. Simpson Dave H. Calk Dr. Hilton W. Gillett	125 N. Main St. 2010 So. 4th St. 6726 Ave. Q	Childress Ponca City Houston Lovington
MARITIME DIVISION				
Maritime	VE1DQ	A. M. Crowell	69 Dublin St.	Halifax, N. S.
ONTARIO DIVISION				
Ontario	VE3EF	Dr. D. R. Gunn (for VE3SG)	Ontario Hospital	New Toronto, Ont.
QUEBEC DIVISION				
Quebec	VE2CO	Lindsay G. Morris	Apt. 6, 4510 Girouard Ave., N.D.G.	Montreal, P. Q.
VANALTA DIVISION				
Alberta British Columbia	VE4GE VE5HP	C. S. Jamieson J. Heppburn, Jr.	581 W. Riverside Drive 335 Foul Bay Road	Drumheller, Alta. Victoria
PRAIRIE DIVISION				
Manitoba* Saskatchewan	VE4BG VE4SY	A. J. R. Simpson Arthur Chesworth	635 Garfield St. 1071 4th Ave., N. W.	Winnipeg Moose Jaw

* Officials appointed to act until the membership of the Section choose permanent S.C.M.s by nomination and election.

KENYON

Marches On!

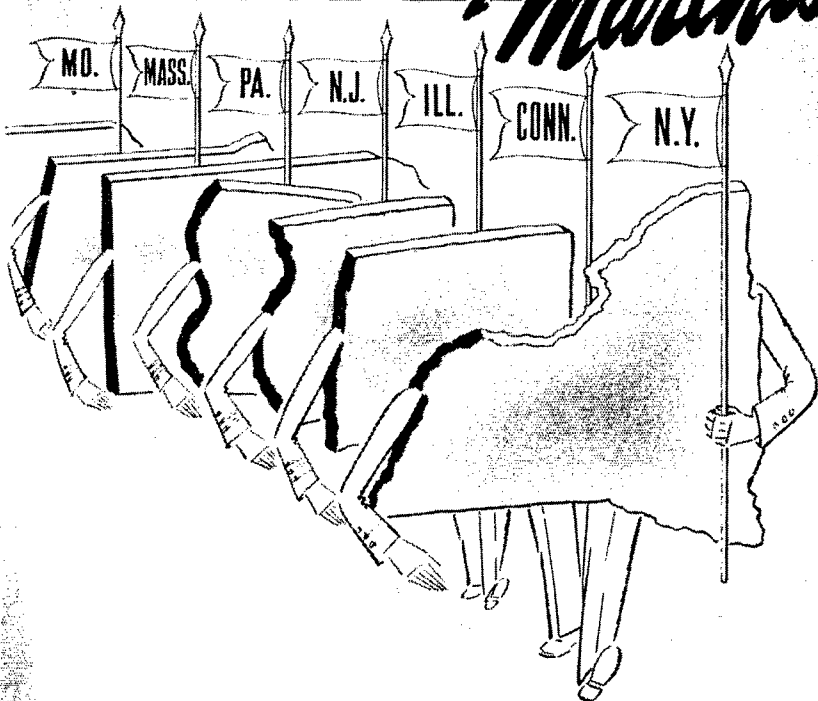

QUALITY TELLS ALWAYS! That alone is the secret of Kenyon's phenomenal rise to a place of preference with amateurs who strive for efficiency in their rigs. They take their cue from the leading manufacturers of amateur equipment such as Temco, Harvey, The Hallicrafters, Browning, Radio Engineering Laboratories, and many others. They know that if Kenyon Transformers are specified in this original equipment they must be good.

And, too, this is the reason why so many leading jobbers, who value the good will of the amateur, are "going Kenyon." For example, four of the country's leading Ham Suppliers — Montgomery Ward, Newark Electric, Allied Radio, and Burnstein-Applebee are among the latest to Swing to Kenyon. If your jobber has not yet stocked the Kenyon line, urge him to do so — for your sake and his!

DAYTON WARNER, W9IBC
of Allied Radio, Chicago, who knows that the best way to make satisfied customers is to sell QUALITY.

ELMO MELTON, W9AEQ
of Burnstein-Applebee, Kansas City, a smart merchandiser who rides the crest of Kenyon popularity in the West.

DAVE ELAM W9FPP
of Montgomery Ward, Chicago, who pays tribute to Kenyon by stocking Kenyon Transformers.

SAM PONCHER
of Newark Electric Co., Chicago, whose company recognizes Kenyon Leadership in quality

WATCH FOR MORE TO COME



KENYON TRANSFORMER CO., Inc.

840 BARRY ST., NEW YORK, N. Y.

Export Department: 25 Warren St., New York, N. Y.

THE AMERICAN RADIO RELAY LEAGUE

Directors

President
EUGENE C. WOODRUFF.....W8CMP
234 W. Fairmount Ave., State College, Pa.

Vice-President
GEORGE W. BAILEY.....WIKH
74 Webster Road, Weston, Mass.

Canadian General Manager
ALEX REID.....VE2BE
169 Logan Ave., St. Lambert, P. Q.

Atlantic Division
WALTER BRADLEY MARTIN.....W3QV
Box 612, Roslyn, Pa.

Central Division
R. H. G. MATHEWS.....ex-W9ZN
100 East Ohio St., Chicago

Dakota Division
FRED W. YOUNG.....W9MZN
107 Hanover St., Mankato, Minn.

Delta Division
E. RAY ARLEDGE.....W5SI
P.O. Box 286, Pine Bluff, Ark.

Hudson Division
KENNETH T. HILL.....W2AHC
115 Willow St., Douglaston, L. I., N. Y.

Midwest Division
FLOYD E. NORWINE, JR.....W9EFC
120 South Fourth St., St. Louis, Mo.

New England Division
PERCY C. NOBLE.....W1BVR
37 Broad St., Westfield, Mass.

Northwestern Division
RALPH J. GIBBONS.....W7KV
c/o United Air Lines, Portland, Ore.

Pacific Division
J. L. McCARGAR.....W6EY
66 Hamilton Pl., Oakland, Calif.

Raonoke Division
H. L. CAVENESS.....W4DW
State College Station, Raleigh, N. C.

Rocky Mountain Division
GLEN R. GLASSCOCK.....W9FA
2164 So. Corona St., Denver

Southeastern Division
BENNETT R. ADAMS, JR.....W4APU
1512 Grove Place, Homewood, Ala.

Southwestern Division
CHARLES E. BLALACK.....W6GG
1273 Main St., El Centro, Calif.

West Gulf Division
WILLIAM A. GREEN.....W5BKH
801 Ross St., Abilene, Texas

THE AMERICAN RADIO RELAY LEAGUE, INC., is a non-commercial association of radio amateurs, bonded for the promotion of interest in amateur radio communication and experimentation, for the relaying of messages by radio, for the advancement of the radio art and of the public welfare, for the representation of the radio amateur in legislative matters, and for the maintenance of fraternalism and a high standard of conduct.

It is an incorporated association without capital stock, chartered under the laws of Connecticut. Its affairs are governed by a Board of Directors, elected every two years by the general membership. The officers are elected or appointed by the Directors. The League is non-commercial and no one commercially engaged in the manufacture, sale or rental of radio apparatus is eligible to membership on its board.

"Of, by and for the amateur," it numbers within its ranks practically every worth-while amateur in the nation and has a history of glorious achievement as the standard-bearer in amateur affairs.

Inquiries regarding membership are solicited. A bona fide interest in amateur radio is the only essential qualification; ownership of a transmitting station and knowledge of the code are not prerequisite. Correspondence should be addressed to the Secretary.



HIRAM PERCY MAXIM, FIRST PRESIDENT

Officers

President.....EUGENE C. WOODRUFF, W8CMP
State College, Pa.

Vice-President.....GEORGE W. BAILEY, WIKH
Weston, Mass.

Secretary.....KENNETH B. WARNER, W1EH
West Hartford, Connecticut

Treasurer.....ARTHUR A. HEBERT, W1ES
West Hartford, Connecticut

Communications Mgr......F. EDWARD HANDY, W1BDI
West Hartford, Connecticut

General Counsel.....PAUL M. SEGAL
1026 Woodward Building, Washington, D. C.

Address all general correspondence to the administrative headquarters at West Hartford, Connecticut.

"IT SEEMS TO US—"

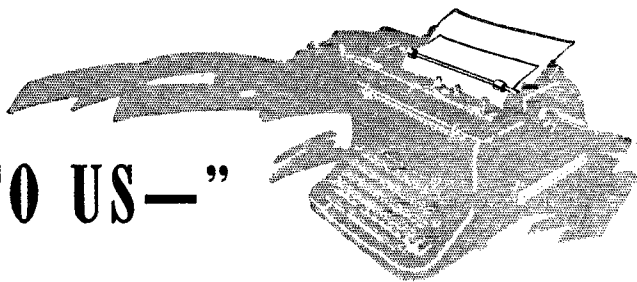

"... AND SUDDEN DEATH"

WE ARE obliged to record in this issue the death of another amateur by electrocution. That is to say, it is our unhappy duty to report that another ham has lost his life through carelessness. For that is what it was, carelessness and haywire.

Why is it, we wonder, that we pay so little attention to such grave fundamentals as the preservation of life? Has familiarity created so much contempt as this? No, we're probably all well-intentioned and we're more safety-conscious than ever before. It's inertia. We haven't got around to fixing up these things yet, or we "haven't time" to do a businesslike job of fencing in dangerous equipment. Believe us, we know exactly how it goes, because just the other evening we caught ourselves using an improvised pi-network antenna coupler with no blocking condensers in it. It was a haywire experiment, trying to make a balky antenna take power on a new frequency. There we stood twiddling the condenser knobs with the full plate voltage on the condensers, our life protected by a scant eighth inch of moulded bakelite. Now if we can write the blistering stuff we have on the question of safety and still be that forgetful ourselves, we know just how it goes!

Think about it, fellows. Inspect your rigs and go over your operating habits. Switch to safety!

MAYBE IT'S THE HEAT

THIS will probably result in many of our own inconsistencies being dug up and thrown in our teeth, but it seems to us that most radio literature, aside from that of amateurs and engineers, is altogether too careless in its use of basic radio terms.

There are several magazines on the American scene which make use of the words *radio* and *television* in their very titles. As if television wasn't radio, as if it were something you got over a wire or a light beam. The actual distinction, if one must be made, of course is between aural and visual broadcasting.

Then there's a very widely known American weekly which thinks it has been smart in hatching its own word, *telecast*, to refer to television.

One can only think that the editors of that weekly believe that the prefix *tele-* is the distinctive part of the word *television*. We have it on no less an authority than that of Mr. Nick Poopoloopolos, the genial host of our favorite lunchwagon, that *tele-* simply means "at a distance." We have decided to laugh at the implication that *telecast* means television any more than it does aural broadcasting.

But we reserve our best sourpuss manner for the expression *the radio* and for that most abominable plural, *radios*. "What a beautiful radio you have, my dear!" Radio set, radio receiver, or radio tuner, lady. "I heard it on the radio." You did not, dearie; you heard it broadcast, or you heard it *by* radio. "All kinds of radios repaired." Grrrrrrrr!

THE EDUCATION OF A B.C.L.

ONE of the F.C.C. radio inspectors has a stock reply for B.C.L.'s who tell him what wonderful broadcast receivers they have and how they will bring in positively everything. He says, "The mark of a good receiver isn't in what it will bring in, but in what it will leave out."

Which is a fundamental thought well worth passing on.

FREEDOM

WE WANT to voice a word of warning about an unwise practice which we see growing amongst us. We hear some stations — particularly 'phone stations — signing off with the statement that this is Red Cross station so-and-so, or American Legion station such-and-such. You know, and we know, that this does not mean that the station belongs to one of these outfits but that it is simply the station of an amateur who has pledged his emergency services to one particular organization and is rather proudly announcing that fact.

The thing that is wrong about it is that it implies that amateur stations are owned and operated by organizations that are not permitted to operate in our bands. The right to operate a ham station is a personal privilege, confined to individuals who have an interest in the *technique* of communications. If we carry this

practice to its extreme the air will be filled with statements that you are hearing Municipal Station ABC, Western Union station DEF, Water Works station GHI, and so on. Worthy as these organizations are of emergency service, they are not themselves entitled to possess amateur stations. *We* are the fellows who have the stations; we lend our *services* to them in time of need. It is *amateur radio* at work, and amateur radio for which we want the credit.

Any amateur ought to be proud to identify his station as an amateur station and we should be quick to resent even the implication that non-amateur stations are operating in our bands. And while we have no quarrel with the right of an amateur to pledge his emergency services to a particular organization if he wants to, we think we would be wiser to hold ourselves free to distribute our cooperation where it is actually most needed when the emergency comes. Participation in the A.R.R.L. Emergency Corps assures that, and in any local crisis there will always be adequate facilities assigned for each local organization that needs communication.

K. B. W.

★ **SPLATTER** ★

THE higher we delve into the u.h.f. spectrum the greater becomes the need for "low-loss" insulation. Of interest to all amateurs should be the story on polystyrene (pronounced, pollysty-rene) by W1DSK, of Monsanto Chemical Co. Many readers probably read the biography on Edgar M. Queeny, president of Monsanto, which appeared in January, '39 *Fortune*.

★ ★ ★

Dana Griffin's kite story in June *QST* brought forth several warnings from the gang. We neglected to point out that using wire for kite string can be most dangerous when the kite is flown anywhere near high-tension wires. It should have been stressed that this form of antenna should never be used unless the individual is miles away from any form of power wires. W9LBP of the Public Service Co., North Illinois, reports that several small boys in the Chicago area have been killed because they used wire string for kites.

★ ★ ★

W3EEW says that Gil's cartoons in "90 Plus," June, *QST*, were so realistic that he is sure Gil must have seen him somewhere!

★ ★ ★

A couple of boners in July *QST*:

W6AM's story as printed said that the *Con-*

tender was going to use 500 Mc. for a distress frequency!

In the group picture, page 30, we transposed Stewart Ayres, W6GEA, with Horace Greer, W6TI.

★ ★ ★

W1FTR and W7HFZ just returned from a cruise to Bermuda on the *Yankee*, WCFT. They report that it is apparent very few amateurs listen on the 36-meter marine band, for they had much difficulty in raising 7-Mc. hams from their 8240-kc. frequency. They point out that much interesting information and items of interest are sent on this band and are preparing a story for *QST*, giving us the dope on the stations sending this information.

★ ★ ★

Our Cover

This contraption has been gracing (?) the roof of A.R.R.L. Hq. all summer and has caused much conjecture among the local natives. It is merely a structure for holding antenna elements above the roof while the technical staff carries on experiments. The antenna element is fixed in position and the various elements are juggled back and forth from it by ropes.

This shot was taken while W1JPE was un-snarlring one of the lines after a heavy wind. W1JEQ is taking a reading along the feed line to determine that there are no standing waves along the line. (The meter on his hip is merely clipped to the belt preparatory to a run aloft to check currents.)

★ ★ ★

"Replying to your choice paragraph on page 18, March *QST*, referring to my setup on the cover. Points of small danger were listed in the comment, while the real hazards were overlooked. It is true that the operator was on the damp earth, but the headphones and microphone were grounded to the metal chassis of the receiver and transmitter, which in turn were solidly connected to the damp earth on which the operator was kneeling. All the antenna tuning gear was connected to ground and no high-voltage points were exposed.

"The real danger to the operator was that of catching pneumonia or of being struck by lightning."

— W1LJI

We might add: Or of the pole falling on top of the operator!

**SWITCH
TO SAFETY!**



Unattended by the fanfare which usually accompanies a major development, experimental frequency-modulation broadcasting not only is under way but is giving outstanding results in noise-free high-fidelity reception. Limited, because of the width of the band required, to the ultra-high frequencies, the prospects for its use by amateurs on frequencies above 112 Mc. hold promise of extended range and generally improved results. This article by Prof. Noble, of the faculty of Connecticut State College, designer of the college FM station, WIXCS, and WDRC's WIXPW, explains in simple language the basic differences between amplitude and frequency modulation, and describes the elements of the Armstrong system.

Frequency Modulation Fundamentals

How Frequency Modulation Works; Its Advantages in Overcoming Noise and Interference

BY DANIEL E. NOBLE,* WICAS

Two 50,000-watt experimental transmitters and several lower-powered transmitters will be placed in regular operation in the Fall using the Armstrong frequency-modulation system. The marked noise suppression which is the important characteristic of the system will make possible a new standard of high-fidelity reception. The writer has been asked to explain the action of this frequency-modulation system without too much technical terminology. With all qualifications aside, the picture looks something like this:

Every amateur knows what frequency modulation is — it's something in his transmitter operation that he doesn't want! To make the picture a little more exact, we shall make use of a pure sine wave alternator. A pure sine wave is a single-frequency wave; that is, no side bands and no harmonics will be associated with it. A perfect frequency meter could locate only one frequency with such a wave. If our alternator is the usual motor-driven type with an external field supply, we can vary the voltage output of the alternator by varying the field current. Let's vary the field current slowly up and down and observe the result. First, the output voltage of the alternator will increase and decrease, and we have a condition commonly referred to as amplitude modulation. See Fig. 1 (A, B, and C). Second, the output wave is no longer a pure sine wave, and if we examine the wave with our perfect frequency meter we shall find several frequencies present, because only the pure sine wave will be limited to a single frequency. So much for amplitude modulation.

Frequency Modulation

Now regulate the field supply so that the amplitude of the alternator output will not change

* Whitney Road, Storrs, Eagleville, Conn.

while the driving motor is made to speed up and slow down. The frequency of the alternator will be determined by the speed of the motor; if we speed up the motor the output frequency will increase, and it will decrease when the motor slows down. Assuming that the amplitude of the output remains constant, we have produced a frequency-modulated wave by the simple process of speeding up and slowing down the motor. What has happened to the wave? First, obviously the wave is no longer a pure sine wave, since the frequency is changing. Second, since the wave is not a pure

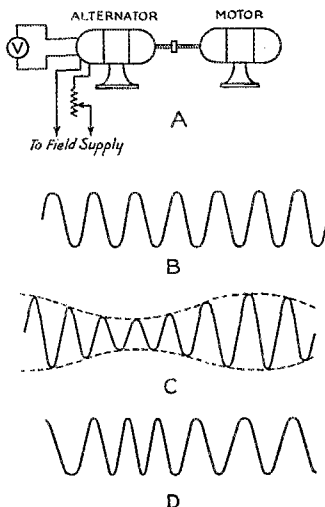

Fig. 1 — Illustrating amplitude and frequency modulation. A, the motor-driven alternator used as an example; B, output with constant field and constant speed (sine wave); C, output with constant speed and variable field (amplitude modulation); D, constant amplitude and variable speed (frequency modulation).

sine wave, several frequencies will be present (theoretically, an infinite number). When we neglect inertia and speed up and slow down the motor in such a way that the change in speed is at

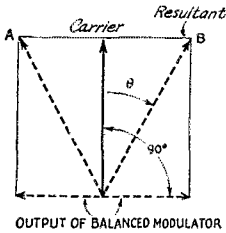

Fig. 2 — Vector Diagram of phase modulation. The modulator vector reverses, producing a resultant Θ degrees ahead or behind the carrier vector. This is equivalent to a sudden change in the time axis, with the result that the frequency changes. The vector will oscillate back and forth between A and B at the modulating frequency. The more rapid the oscillation the faster the change in the time axis, therefore the greater the frequency deviation produced.

the rate of ten cycles per second, and the cycles are perfect sine-wave cycles, we will produce a frequency series for a 1000-cycle generator something like this: . . . 1000 - 30, 1000 - 20, 1000 - 10, 1000, 1000 + 10, 1000 + 20, 1000 + 30 . . . and so on to an infinite number of side bands. Although frequency modulation will

produce a composite wave made up of the carrier, plus and minus a regular harmonic series of the modulating-signal frequency and the carrier, we are fortunate in the fact that the amplitudes of the side bands decrease rapidly as the signal harmonic number increases.

To go back to our motor-generator again, the motor was speeded up and slowed down to produce our frequency modulation but we didn't say how much we speeded it up or how much we slowed it down. We can change the motor speed so that the frequency will vary instantaneously as follows: 1000→1025→1000→975→1000 cycles, and make the entire excursion in one-tenth of a second for a modulating frequency of ten cycles per second. Or we can go 1000→1050→1000→950→1000 in one-tenth of a second for a 10-cycle modulation frequency. The difference is found in the more extended change in frequency in the second case. This change is called the "deviation." For the first case the deviation is 25 cycles and for the second, 50 cycles. Deviation is then the maximum instantaneous change in frequency. Just to increase the confusion, we might add that we can't find the deviation with the frequency meter since no continuous spectrum is produced but, rather, we produce discrete side bands which may be detected and their physical existence made evident by means of our frequency meter. These side bands may be found far beyond

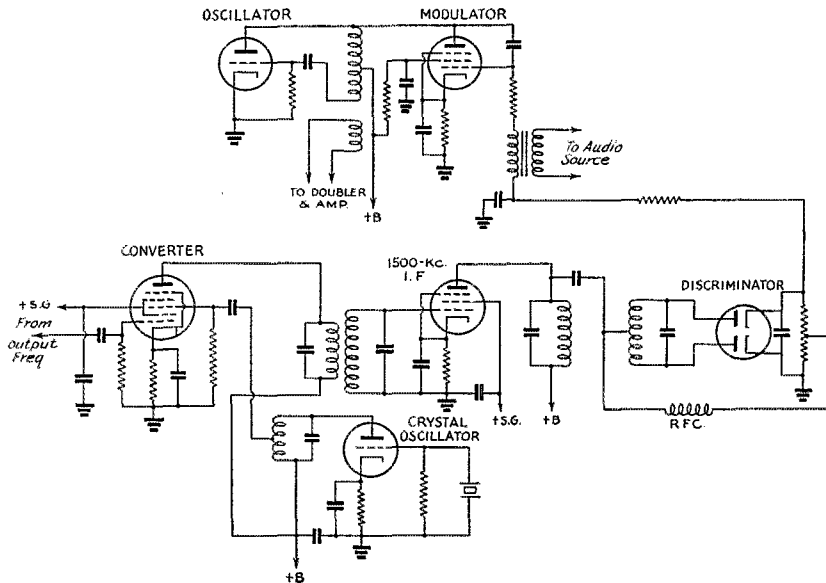

Fig. 3 — A practicable frequency-modulator circuit, after Weir. The oscillator is frequency-modulated by the a.f.c. tube (modulator) which causes a frequency deviation in proportion to the amplitude of the audio voltage. A small part of the output signal is fed to the converter tube, which is heterodyned by a stable crystal oscillator to give a beat frequency at 1500 kc. The i.f. output operates the rectifier (discriminator) and by providing the modulator with a d.c. bias which varies when the mean oscillator frequency tends to change (a.f.c. action) maintains the carrier frequency constant. Deviations of approximately 30 to 40 kc. may be obtained in the region of 20 Mc. using a 6L6 modulator and 6F6 oscillator. The stability of the system will be determined by the discriminator circuit stability.

the limits of the deviation. We might define the maximum instantaneous frequency for our special case as the frequency we would get from our alternator if we held the speed constant when the maximum speed was reached. We do not actually produce such a maximum frequency because the speed does not remain constant. All this leads to a conclusion that we can expect the band-width of the frequency modulated wave to be greater than twice the deviation.

Producing Frequency Modulation

A frequency-modulated wave may be produced much more readily with vacuum tube equipment than with rotating machinery. Rotating a condenser back and forth to change the capacity in an oscillator circuit will produce a frequency-modulated wave. Placing a condenser microphone in an oscillator circuit in such a way

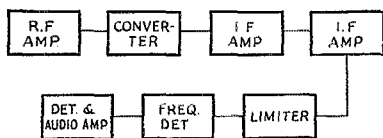
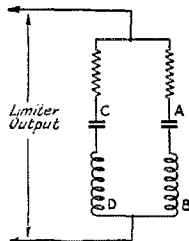

Fig. 4 — Essentials of a superhet receiver suitable for frequency-modulated signals.

that changes in the microphone capacity will influence the frequency of the oscillator is an obvious means of producing a modulated wave. The circuit used in automatic frequency control systems is an excellent frequency-modulation system.

The modulation method invented by Major Edwin Armstrong is very stable since the carrier is controlled by a quartz crystal oscillator. A 200-kc. oscillator supplies voltage to a phase-shift network from which two components of the carrier are extracted, differing only in phase. One component is 90° out of phase with the other. Mathematically, the difference between the amplitude-modulated wave and the frequency-modulated wave is the difference in the phase relations between side bands and carrier. If the side bands of an amplitude-modulated wave could be extracted from the carrier, shifted in phase 90° , and then recombined with the carrier, a frequency-modulated wave would result. Major Armstrong did not extract the side bands but he did arrange to produce side bands without a carrier by means of a balanced modulator working with one of the 200-kc. components mentioned above, and then to combine the side bands with the second component in such a way that the side bands were 90° out of phase with the normal arrangement for carrier and side bands in the amplitude modulated wave. His result was a frequency-modulated wave of the special type sometimes referred to as a "phase-modulated" wave. Another way to describe the action of

Fig. 5 — Elementary detector circuit for frequency-modulated waves. CD is tuned to the lower extremity of useful side bands, AB to the upper extremity. The voltage appearing across either circuit is determined by the amplitude of the audio modulating voltage. A hybrid wave appears across each circuit. Rectification recovers the audio component.



Major Armstrong's modulator is to say that he combined a carrier voltage with a side-band voltage which had been rotated through 90° . This gives us the simple picture of two vectors 90° out of phase combining to give the resultant voltage. Fig. 2 will assist the reader to visualize the process. As the side-band voltage is increased and decreased, the resultant of the two vectors is caused to shift phase. The shift in phase corresponds to a frequency change, and the amount of frequency change produced will depend upon the magnitude of the phase shift and upon how rapidly the phase shift is taking place. Since the magnitude and the speed of the phase shift is determined by the side-band vector, the deviation produced will be determined by the magnitude and the frequency of the modulating signal. The only difference between pure frequency modulation¹ and phase modulation is the fact that the deviation is a function of the amplitude only of the modulating signal for pure frequency modulation while the frequency of the signal also determines the deviation for phase modulation. A network placed in the audio input amplifier making the output signal voltage inversely proportional to frequency will make the overall response independent of signal frequency, and thus the phase modulator will produce a pure frequency-modulated wave. The actual deviation produced at 200 kc. is small, something of the order of 15 to 20 cycles. Therefore, a series of doublers must be introduced to increase the maximum deviation to 100 kc. A total of twelve or thirteen doubler stages is used to reach the required deviation.

A system of modulation suggested by Murray C. Crosby and developed by Irving R. Weir makes use of the automatic frequency control variable oscillator for modulating the frequency, and of the a.f.c. discriminator circuit for stabilizing the oscillator carrier. Fig. 3 illustrates the type of circuit used. The modulator tube injects 90° out-of-phase current into the oscillator tank circuit. The effect of changing the modulator

¹ The term "phase modulation" is something of a pain. Actually there are as many types of frequency modulation as there may be functions of X. Phase modulation is one type. The type referred to as "pure" frequency modulation is the unadulterated, holy, sweet, etc. variety in which the deviation produced is a linear function of the modulating signal amplitude only. "Phase modulation" is still "frequency modulation."

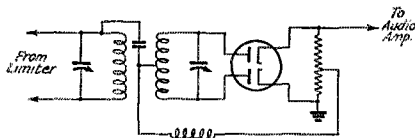

Fig. 6 — The discriminator circuit combines the functions of frequency detector and rectifier to recover the audio signal.

injector current is comparable to changing the tank capacity in the oscillator circuit. The stabilizing circuit functions in the usual a.f.c. manner.

Receivers

The receiver requirements are not so complicated as one might suspect. The usual superheterodyne is used with a few additions and changes. The pass band must be greater than twice the transmitter deviation. A limiter precedes the detector, and this limiter has the very important function of "wiping off" any amplitude modulation which may have been introduced by noise voltages. The limiter passes on the frequency-modulated wave with constant amplitude to the frequency detector, which changes the frequency-modulated wave into a hybrid wave with both amplitude and frequency modulation components. An ordinary detector then recovers the signal from the amplitude component. Fig. 4 illustrates the line-up. Figs. 5 and 6 show two frequency detectors.

A simple circuit of the type shown in Fig. 7 also will act as a frequency detector. The carrier is tuned in on one side of the resonance curve. A steady-state r.f. voltage will result from the unmodulated carrier, and modulation will produce instantaneous frequency changes. Taking *A* as the operating point, any change corresponding to an increase in frequency of the signal will increase the amplitude of the voltage across the parallel-resonant circuit, and an equivalent decrease in frequency will decrease the voltage across the circuit. Therefore, since the modulation produces magnitudes of frequency change or deviation corresponding to the amplitude of the audio modulating signal, and since the rate at which the changes or deviations take place corresponds to the frequency of the audio signal, the voltage appearing across the parallel-resonant circuit will be amplitude-modulated. Frequency modulation will also be present but we are no longer interested in that. Rectification will recover the audio signal. Any receiver of the usual type can be made to receive frequency-modulated signals after a fashion by detuning slightly, but the reader is assured that the "fashion" is not very satisfactory.

Noise Suppression

Remarkable results in the suppression of noise

and interference are possible with the frequency modulation system. Since the limiter wipes off all amplitude variations, noise of this type must appear as frequency modulation produced by the phase shift resulting from the combination of the signal and noise voltages. For the case where the peak noise amplitude is half the signal amplitude and the phase relation between signal and noise is ninety degrees, the maximum phase shift would be approximately 26.5° . Very little frequency modulation will be produced if this phase shift is the result of noise modulated by a low-frequency audio component, but the frequency modulation will increase directly with the frequency of the audio noise component. The receiver will display greatest susceptibility to noise frequencies above audibility. Logical design of the receiver would call for a sharp cut-off of the audio amplifier response or, better still, a falling high-frequency characteristic, which will reduce the hiss response. A simple predistortion network at the transmitter will present a compensating rising high-frequency response so that the overall response of the system is flat. This is the arrangement used in the stations now on the air.

The very remarkable effect of the limiter action upon the suppression of interference has been demonstrated by Weir.² He reports that with two stations operating on the same channel the stronger station would prevail 100 per cent at the receiver whenever the stronger station's signal was more than twice the strength of the weaker signal. He also reports in the same paper that no interference area of the usual kind existed where the signals were of nearly the same ampli-

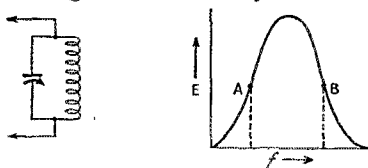

Fig. 7 — A parallel-resonant circuit will act as a frequency detector when tuned to carrier at points *A* or *B*. With the circuit tuned so that the carrier is at *A*, the voltage across the circuit will rise and fall in step with the deviation produced by the modulating voltage; the result is an amplitude-modulated wave which is also frequency-modulated. A rectifier will recover the amplitude audio component.

tude. In this area the movement of the antenna a few inches would throw one program out and bring in the other one. The presence of standing waves accounts for the phenomenon since the nodes would permit the selection of the required voltage radio.

Mathematically the action of the limiter is rather complicated, but the results of the limiter action are an overall effect of cutting the amplitude of the received voltage in such a way that

² I. R. Weir, "Field Tests of Frequency and Amplitude Modulation with Ultra-High-Frequency Waves," Part I. *General Electric Review*, May 1939.

the strong signal component dominates while the weak signal is suppressed. In other words, the strong signal will always take control of the receiver. The frequency-modulation system permits ² as much as 25 db gain in signal-plus-noise-to-noise ratio over that possible with an amplitude system of equal carrier strength.

While this gain in equivalent power is due in part to the limiter action it is also the result of the very interesting effect which makes the magnitude of the recovered power at the receiver a function of the modulation deviation. If a deviation of 50 kc. produces voltage A at the receiver, then a deviation of 100 kc. will produce a voltage two times A at the receiver. Here the received voltage has been doubled without changing the carrier power at the transmitter. In the amplitude case the peak carrier power must increase four times when the modulation changes from zero to 100 per cent. Since without the power change the received voltage increases for the frequency-modulated system with an increase in deviation, it follows that the advantage of the system over the amplitude system will increase as the deviation is increased. The practicable limits must be determined by available channel width. The Federal Communications Commission has assigned 200-kc. channels for the broadcast stations now in operation. For this channel width the deviation will probably be restricted to 80 kc. or less. Present standards seem to point to a modulation index (that is: ratio of deviation to audio frequency) of $\frac{80,000}{15,000}$ or approximately 5.3.

Necessarily this is a very sketchy account of Major Armstrong's invention. The writer hopes that it may serve as an introduction to the subject, and for those who are interested in the more detailed and technical aspects a carefully selected bibliography is appended.

* * *

Selected Frequency Modulation Bibliography

1. Carson, John R. "Notes on the Theory of Modulation." *Proceedings IRE*, Vol. 10, No. 1, February, 1922. First paper in which the frequency-modulated wave is analyzed mathematically and the required "band width" determined.

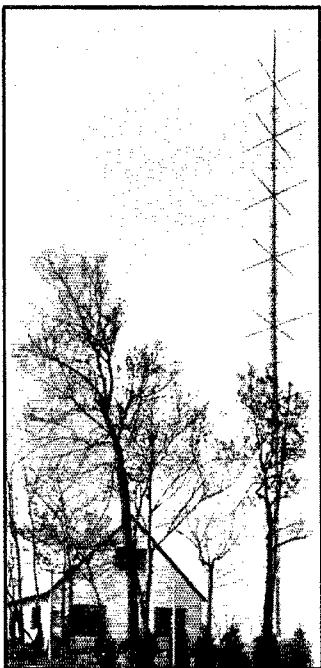

Transmitter house and six-bay turnstile antenna at W1XPW, a 1000-watt experimental frequency-modulated transmitter located on top of West Peak, Meriden Mountain, near Meriden, Conn. The transmitter operates on 43.4 megacycles. WDRC, Inc., is the owner.

2. Armstrong, Edwin H. "A Method of Reducing Disturbances in Radio Signaling by a System of Frequency Modulation." *Proc. I.R.E.*, Vol. 24, No. 5, May, 1936. Undoubtedly the classical paper in the field. The first published account of the wide-band frequency modulation system.
3. Crosby, Murray C. "Frequency Modulation Noise Characteristics." *Proc. I.R.E.*, Vol. 25, No. 4, April, 1937. Mathematical treatment and experimental verification of wide-band frequency modulation vs. amplitude noise suppression.
4. Roder, Hans. "Frequency Modulation." *Electronics*, Vol. 10, No. 5, May, 1937. Mathematical analysis of validity of noise-suppression effect in wide-band frequency modulation.
5. Carson, John R. and Fry, Thornton C. "Variable Frequency Electric Circuit Theory with Application to the Theory of Frequency Modulation." *Bell System Technical Journal*, Vol. 16, No. 4. Fundamental formulas for variable frequency electric circuit theory are developed. Transmission, reception and detection of frequency modulated waves are studied analytically.
6. Roder, Hans. "Tuned Circuits and a Frequency Modulated Signal." *Proc. I.R.E.*, Vol. 25, No. 12, December, 1937. Mathematical treatment of tuned circuits.
7. Weir, I. R. "Field Tests of Frequency- and Amplitude-Modulation with Ultra-High-Frequency Waves." *General Electric Review*, May, 1939, Part I; June, 1939, Part II. A very important paper of interest to both the technical and non-technical readers. Describes a simplified transmitter.
8. Day, John R. "A Receiver for Frequency Modulation." *Electronics*, June, 1939. The first published constructional data for a seven-tube frequency-modulation receiver.

Strays

W5CVO says that the aluminum cores of acetate recording discs for 16-inch transcriptions make good material for small chassis, such as the one required for the "Economy Forty" described in *QST* for April. These discs are often obtainable at b.c. stations. The material covering the aluminum may be removed by boiling in water and peeling it off.

— . . . —

W8FJL built a 56-Mc. spiral-rod oscillator using a pair of 35T's. During the process of shoving different materials in the field of the spiral, it was found that bakelite *boiled*, but that hard rubber and Isolantite reached the same temperature, warm to the touch. Hard rubber ought to be as good as Isolantite at high frequencies, so long as it is not subject to moisture.

— W8PUF

The Two-Band Three-Element Rotary

Building a Close-Spaced Array for Two-Band Operation

BY E. E. SCHROEDER,* W9TB

THE International DX Contest is really the ideal proving ground for amateur equipment, and entering it without something new to try out is like reading a book or seeing a movie for the second time.

When it came time for the 1939 Contest, a general survey disclosed a definite weakness in the antenna department. With the ornery neighborhood kids continually cutting down my rhombic, and new neighbors building all around me, it became apparent there was little room left for a barrage of antennas. Any new antenna, therefore, had to be something compact, and of course with some gain. There was no hope for 40 meters. A rotary for 20 and one for 10 would probably take care of those bands, but two rotaries would run into considerable money and be hardly worth it, since we seldom operate on 10 meters except during contests.

A plan was evolved whereby one rotary could easily be converted from 20 to 10 meters. According to Brown's data on close-spaced elements,¹ it

* The Columbia Broadcasting System, 410 North Michigan Ave., Chicago, Ill.

¹ Brown, "Directional Antennas," *Proc. I.R.E.*, January, 1937; Stavrou, "Directional Arrays Using Half-Wave Elements," *QST*, May, 1938.

A close-up of the reflector element and stub showing the tuning extensions. The director element is arranged in the same manner. This curving arrangement of the stub keeps it securely in a limited space and places the tuning extensions in a downward position, making them accessible from the supporting pole. No. 8 wire, spaced 6 inches, is used for all stub sections.

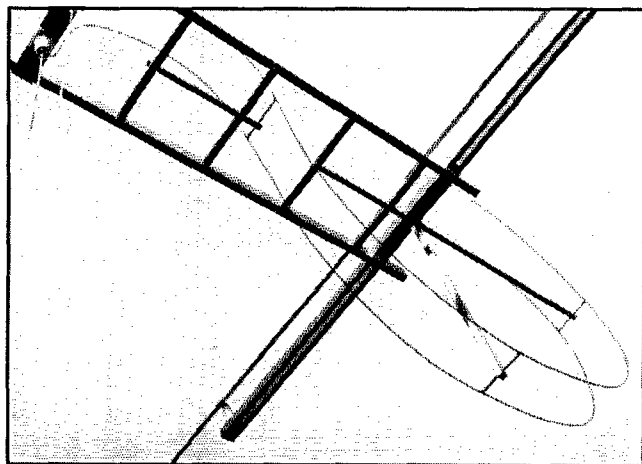

was found that a compromise on spacing of elements could be worked out without any appreciable loss on either band. Because some of the elements are parasitically excited, their tuning becomes critical. To get the best results in the separated c.w. sections of the 20-meter band it would be necessary to re-tune the elements when moving from one section to the other. The spacing (in wavelengths) would be doubled and the elements would not be exactly resonant to the harmonic frequency because of end effects when switching to 10 meters, and it would be necessary to re-tune the elements when changing bands. For convenience, it was decided to split each element in the center, and bring open-ended stubs over to a position where these ends could easily be reached from the tower or pole and tuned by means of short automobile telescoping antennas connected on the ends. A 600-ohm open wire line was selected for feeding. To get a proper match and still be able to re-tune the radiator element for frequency and band changes, a matching stub was also used.

It can readily be seen that with this set-up, the element-stub arrangement becomes harmonically related between 20 and 10, and will be in the proper phase relationship. Any one half element, along with its half of the open end stub becomes approximately one half wavelength on 20. The currents in the stub wires are 180 degrees out of phase, thereby cancelling radiation, while the currents in each half element are the same as though the element were connected through at the center (Fig. 2A).

On 10 meters, each half element becomes a half wave instead of a quarter wave, and each half of the stub does likewise. The current phasing looks as in Fig. 2B.

Feeding the radiator is a bit of a problem. In our case the rotating head has a steel pipe, 1 inch inside diameter, for a drive shaft through which the stub is brought down. Two leads of 43 strands of No. 26 enameled copper wire, with high-grade insulating washers slipped over them, are brought down through the drive shaft and then fan out to join the stub. The stubs, on the radiator and parasitic elements, are made of No. 8 wire spaced

6 inches. On 20 meters the impedance at any point along the flexible coupling leads does not exceed 250 ohms, and therefore the close spacing and effects of the steel pipe will not be noticeable. However, on 10 meters this same position will have very high impedance, and the above conditions will have a shortening effect on the stub, which would necessitate a great amount of tuning of this stub. Instead, it was decided to use a separate shorted stub (for compactness) with its own 600-ohm transmission line, which could easily be switched at the point where the flexible stub leads connect to the stationary stub. With this set-up, a perfect impedance match can be obtained on both 20 and 10.

The necessity for climbing the pole to change bands is of course a disadvantage, but it solves the problem for those who do not care to put out the cash for two rotaries, and yet want to retain the advantages of two-band operation. It is also a disadvantage to have to climb the pole to retune for different frequencies within one band, but it's there to take advantage of if you want to get the most out of your rotary. More on frequency *vs.* front-to-back ratios later. All the above disadvantages could be overcome by the use of remote control equipment, but this runs up the cost. The flexible lead arrangement is not entirely desirable either, but it works FB and could be improved upon for

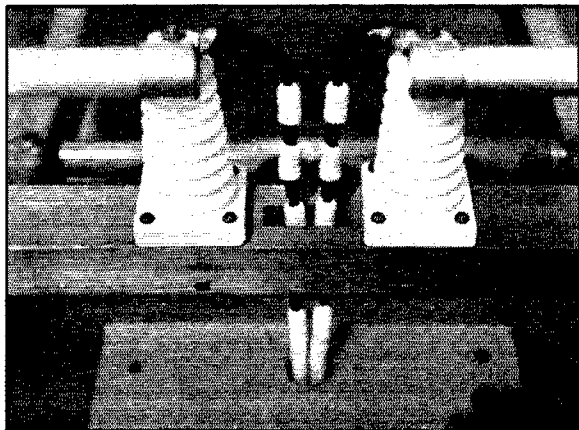

Flexible leads from the radiator, insulated by ceramic beads, pass down through the drive shaft to the matching stub.

10-meter operation by using a larger drive-shaft pipe, or any other arrangement whereby more clearance and greater spacing could be used, to reduce dielectric losses and leakage during wet weather.

Tuning

For field strength measurements, a half-wave doublet was set up at the same height as the rotary, 100 feet away, and the twisted pair feeder from the doublet stretched over to the rotary. A current squared galvanometer connected to the feeder gives readings directly proportional to power. The transmitter is fired up and the rotary excited on 20 meters and aimed directly at the pickup antenna. The director stub is tuned for maximum power pickup in the doublet. The rotary is then turned around 180 degrees and the reflector stub tuned for minimum power in the doublet. Next, the radiator stub is tuned. Our

favorite method for doing this is to shunt the r.f. galvanometer across the stub wire directly on each side of the feeder wire connection. These two readings should be the same. If the reading on the short end (considering half of the element and half of the stub as a unit) is higher, then the stub is too long, and vice versa. Next the feeder is matched into the proper point on the stub. This can be done by any standard practice. The one used here is adding a half wave length of transmission line, and adjusting the coupling until the line measures the same current at transmitter, and for a double check, cutting the half wave into a quarter wavelength. Feeder current should of course remain the same. As a final check, all measurements and adjustments are re-checked.

Worried about having to put up two rotaries for 10- and 20-meter operation? Here's how W9TB licks the problem and, incidentally, gives himself a sharper beam on 28 Mc.

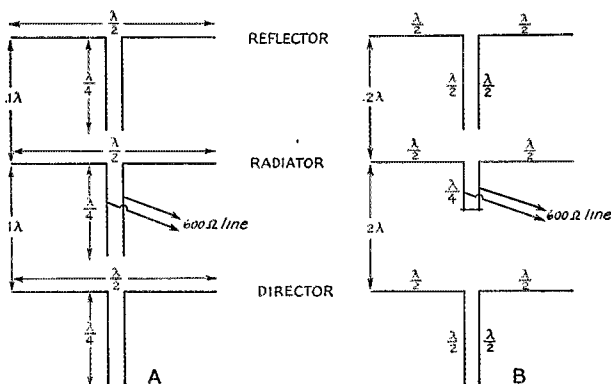
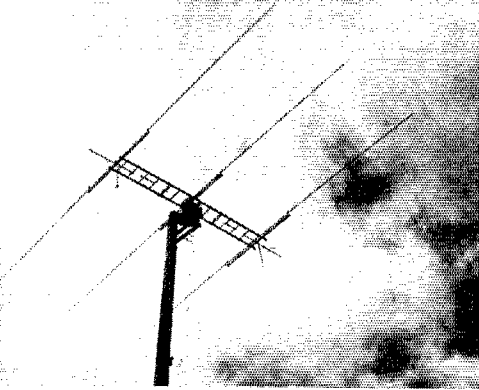

Fig. 1 — The electrical dimensions of the W9TB two-band rotary antenna. When changing from one band to another, a different stub and feed line is connected to the radiator, and the lengths of the parasitic element-stubs are readjusted.



The three-element rotatable directive antenna at W9TB can be used on either 14 or 28 Mc. by the proper selection of feeding stub and slight readjustment of element length. It is mounted on the top of a 54-foot pole.

The field strength was then plotted as the rotary was rotated. In order to get as nearly accurate readings as possible, the power input to the rotary was increased in even multiples, as the pickup power started dropping off. This multiplier was used as a correction factor in plotting the results. For example, when the pickup power dropped from 10 watts to 1 watt, the power input to the rotary was increased so that the doublet pickup power again read 10 watts, which means that the power was increased 10 times, so any following readings were divided by 10 for actual readings. By the time the rear was measured, the power had been increased 30 times, and the maximum front-to-back ratio was found to be 3330 to 1. Measuring each 15 degrees all the way around, and averaging up the measurements taken over the rear 180 degrees, the ratio was 1000 to 1. These measurements were made on 14,200 kc. Without re-tuning the beam, the front-to-back ratio was measured on 14,000 and 14,400 kc. and found to be 13-1 and 52-1 respectively. It would be interesting to measure the difference in actual gain over this same frequency range without re-tuning, but of course this would run into complications. The stubs were adjusted for maximum

front-to-back ratios on 14,000-14,200-14,400 kc. and the settings jotted down.

Being completely satisfied with the operation on 20 meters, the tune-up procedure was run through on 10 meters, using the same procedure. Since the contest was about to start, very little time was used for this tune-up, and the results obtained are not presumed to be the best obtainable. Nevertheless, the results were very FB. The front-to-back ratio was only 57 to 1, but the width of the lobe was found to be very narrow, due to the fact that each of the three elements are now working as half waves in phase. The front to side ratio could not be measured accurately, but it is somewhere between 5000 or 20,000 to 1.

Referring to the table of dimensions, I might say that any change in material, size of wire, spacing, etc., may alter the lengths a great deal.

◆ Strays ◆

An economical way to reduce initial drift in superhet receivers is to operate the heaters of the high-frequency tubes from a separate filament transformer operating continuously.

— WSQP

— —

In an ad on page 78 of June *QST* I read that some new dingus will permit you to work as close to the band as it is safe for any amateur to do. Please tell me how far out of the band I must stay to be safe. Hi!

— W4ANN

— —

If your mike batteries are fairly well advanced in age, a 0.01- μ f. condenser across the battery will undoubtedly improve quality and response.

— W8RMG

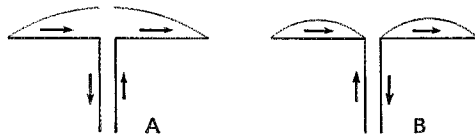

Fig. 2 — The current distribution of a current-fed half-wave element with quarter-wave matching stub is shown at A. At twice the frequency, the current distribution becomes as at B and the system is still very close to resonance, operating as collinear half waves in phase.

DIMENSIONS OF THE TWO-BAND ROTARY

Antenna length (each half element)	16 ft. 9½ in.			
Director length (each half element)	16 ft. 7¾ in.			
Reflector length (each half element)	17 ft. 4 in.			
Spacing between elements	6 ft. 11 in.			
	14,000 kc.	14,200 kc.	14,400 kc.	28,000 kc.
Antenna stub length	19 ft. 4½ in.	18 ft. 9¾ in.	18 ft. 6 in.	4 ft. ½ in.*
Director stub length	18 ft. 5 in.	17 ft. 8 in.	17 ft. 5¾ in.	16 ft. 6¾ in.
Reflector stub length	19 ft. 8 in.	19 ft. 1¾ in.	18 ft. 7¾ in.	18 ft. 2¾ in.

* This stub end is shorted.

600-ohm feeder tap for 20-meter operation at 14,200-kc. settings on stubs — 16 ft. 5¾ inches from bottom of stub.
600-ohm tap for 10-meter operation at 28,000-kc. setting on stubs — 6 inches from bottom.

Low-Pass Filters for Time-Delay Circuits

More Rapid Operation with Less Distortion in A.M.C. Circuits

BY JAMES H. OWENS,* W3ASZ

IN ARTICLES dealing with automatic modulation control circuits, it has often been written, "the time-delay circuit must be slow enough so that it does not cause wave-form distortion, and yet fast enough to give a build-up of the weakest syllables." This sounds good, and the average amateur, like the writer, might build such a circuit and believe he is getting just that — with a resistance-capacity filter — until such time as he has actually drawn curves on its performance. Then he will find the fastest possible time delay far too slow for syllabic build-up, because a resistance-capacity filter has an attenuation characteristic of only 3 db per octave.

Knowing that unloaded single-section low-pass filters have an attenuation characteristic of 9 db per octave, it was decided to try such an arrangement in the a.m.c. filter circuit. This gave a definite improvement in syllabic modulation and completely eliminated the tendency of hum, motorboating, wave-form distortion and frequency doubling which is apparent with a resistance-capacity network which is not too slow. Whereas with a resistance-capacity network it is only possible to get a build-up of some weaker words, with the low-pass filter it is really possible to build up the power of the weaker vowel and consonant sounds in words.

*6301 Banbury Road, Govans Station, Baltimore, Md.

The curves of Fig. 1 show the differences between resistance-capacity and low-pass filters of correct and haphazard design. Curve A is for a low-pass filter of correct design. This circuit will permit true reproduction down to 40 cycles and still provide an almost perfect gain shift in one-fifteenth of a second. A resistance-capacity network curve is drawn to coincide with it at 10 cycles, and it will be seen that this network gives as much distortion at 600 cycles as the low-pass filter does at 40 cycles.

Curves C and D are also comparative and are drawn to coincide at 60 cycles. Again it will be observed that the low-pass filter, by its sharp cutoff, provides a faster time delay in gain shift with less distortion of the lower-frequency tones. And curve C is a haphazard filter utilizing the secondary of an old mike transformer and a 0.1- μ fd. capacitor. The particular transformer used had a zero-current inductance of 625 henrys, which is a fair average. Actually, if the inductance were between 300 and 1500 henrys, with a 0.1- μ fd. capacitor, the cutoff frequency would be changed but a few cycles and the slope of the curve less than one db per octave. With amateur transmitters, where the lowest speech frequencies are about 96 cycles, this is not important.

For those interested in design considerations, the value-determining factors will be given for

Advocating the substitution of a low-pass filter for the RC circuits used for obtaining a time constant in a.m.c. circuits. Simple design dope, based on original experimental work by the author.

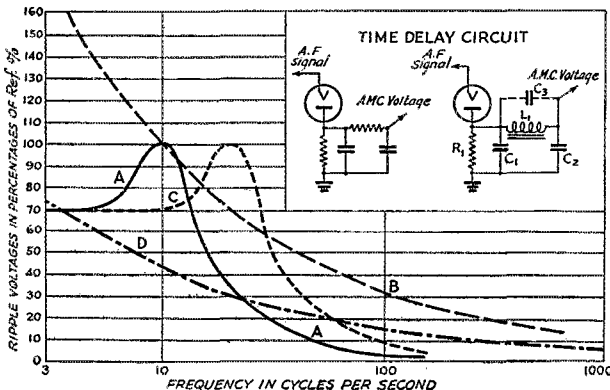

Fig. 1 — Experimental curves showing the comparative performance of low-pass and resistance-capacity filters. Curve A: low-pass filter; C₁, 0.083 μ fd., C₂, 0.166 μ fd., R₁, 189,000 ohms, L₁, 1500 henrys. Curve C: low-pass filter; C₁, 0.05 μ fd., C₂, 0.1 μ fd., R₁, 160,000 ohms, L₁, 625 henrys. Curves B and D, resistance-capacity filters; B is equivalent to A at 10 cycles, D equivalent to C at 60 cycles.

constructing low-pass filters for time-delay circuits. Because the filter is designed to work into a theoretical open circuit (actually, leakage resistance will be something not less than 10 megohms) the value of L_1 would be too high for amateur practice. Therefore, the first design consideration will be to select R_1 , which should be of the lowest value consistent with available current from the a.m.c. rectifier and required a.m.c. voltage. C_1 will then have a reactance equal to R_1 at the cutoff frequency (highest point of the curve). L_1 and C_2 will have equal reactances and it will be satisfactory to make each equal, at the cutoff frequency, to one-half the resistance of R_1 .

It is possible to steepen the slope of the low-pass filter curve even more by paralleling L_1 with a capacitor which will resonate at a frequency four times the cutoff frequency of the filter. This is given not as a matter of importance, but just as a matter of fact.

Sample Calculation

To work out values for a trial problem, assume that one section of a 6H6 will be used for rectifying, and that the audio power is to be taken from the output of the audio amplifier or a small separate amplifier tube, resistance coupled to the 6H6. The current capacity of the 6H6 is 2 ma., but it might be desirable to keep the total rectified current less than one ma. maximum. It is further known that it will not be necessary to have over 50 volts negative to be delivered to the suppressor of a pentode or the injection grid of a pentagrid mixer. Using Ohm's Law, it is found that with 0.001 ampere and 50 volts, R_1 could be chosen with as low a value as 50,000 ohms.

Twenty cycles is recommended as a safe cutoff frequency, because this will allow excellent gain shift in one-thirtieth of a second and will not distort wave form at frequencies as low as 80 cycles.

C_1 will then be found as follows, remembering that the impedance of C_1 equals R_1 at the cutoff frequency.

$$C_1 = \frac{1}{2\pi f Z}$$

where $Z = 50,000$ ohms
 $f = 20$ cycles

$$C_1 = \frac{1}{6.3 \times 20 \times 50,000} = 0.16 \text{ } \mu\text{fd.}$$

The reactance of L_1 will be equal to $\frac{R_1}{2}$ at the cutoff frequency.

The formula for L_1 is:

$$L_1 = \frac{Z}{2\pi f}$$

where $Z = 25,000$ ohms
 $f = 20$ cycles

$$L_1 = \frac{25,000}{6.3 \times 20} = 198 \text{ henrys}$$

C_2 will also be equal to $\frac{R_1}{2}$ at the cutoff frequency, or $2C_1$. Therefore C_2 is 0.32 $\mu\text{fd.}$ C_3 will resonate with L_1 at four times the cutoff frequency. The formula is:

$$C_3 = \frac{1}{4\pi^2 f^2 L_1}$$

where $f = 80$ cycles.

Therefore

$$C_3 = \frac{1}{4 \times 9.8 \times 6400 \times 198} = 0.02 \text{ } \mu\text{fd.}$$

All values and their satisfactory equivalent: can now be given:

$R_1 = 50,000$ ohms	(equivalent)	50,000 ohms
$C_1 = 0.16$ $\mu\text{fd.}$		0.15 $\mu\text{fd.}$
$L_1 = 198$ henrys		200 henrys
$C_2 = .31$ $\mu\text{fd.}$		0.25 $\mu\text{fd.}$
$C_3 = .02$ $\mu\text{fd.}$		0.02 $\mu\text{fd.}$

We repeat that the values are not critical, and that L_1 can be any high impedance choke rated over 200 henrys, or the secondary of almost any microphone transformer.

If it is desired to know the exact zero current inductance of L_1 , this can be had by writing the manufacturer, by testing it with an inductance bridge, or by resonating it with a capacitor of known value (using an oscillator and oscillograph) and computing its inductance.

The writer will be glad to answer any inquiries accompanied by a stamped and self-addressed envelope.

Rocky Mountain Division Convention

Denver, Colo., August 19th-20th

THE Mile High Radio Association is sponsoring the Rocky Mountain Division Annual Convention to be held at Denver, Colo., on August 19th and 20th. Convention headquarters will be at the Hotel Cosmopolitan. A cordial invitation is extended to all amateurs to attend.

After registration the program will start with a welcoming address by Governor Carr of Colorado to be followed by an interesting program of technical and instructive talks. Saturday evening will be taken up by contests of all sorts and special games will be provided for the ladies, so bring them along. Sunday morning there will be a "chuck" wagon breakfast, golf and baseball.

Tickets are on sale at \$2.50 each until August 15th, at which time price will be increased to \$3.00. Get busy and send in your registration to W. M. Reed, Secretary, 912 Continental Oil Building, Denver, Colo.



NAVAL COMMUNICATION RESERVE NOTES

SEVENTH NAVAL DISTRICT

A LOOK at a hurricane map will immediately disclose that Southern Florida is the apparent focal point of the tropical hurricanes so prevalent in the months of September, October, and November. These cyclonic storms originate well to the eastward and travel, at relatively slow speeds, in a westerly to north-westerly direction, increasing speed of translation as their tracks curve northward. When they approach the continent they are usually fully developed into a howling, terrifying, destructive wind. Velocities have been known to reach 200 miles per hour. Those who have never been through one have no conception of the disaster, damage, and loss of life such a "blow" leaves in its wake.

Thus the Naval Communication Reserve in the Seventh Naval District has a special function in time of peace — that of furnishing adequate communication facilities in case of failure of the regular channels. To this end the Naval Communication Reserve is prepared to work with local chapters of the American Red Cross to the fullest extent. Required, therefore, are portable installations not dependent upon commercial power, antennae located in protected areas in such manner that they can withstand any kind of blow, very able operators, and much advance tactical planning. The everyday training that the Naval Communication Reserve offers its members makes an excellent groundwork for "disaster preparedness." Several times in the past few years the NCR of the Seventh Naval District has had opportunity to demonstrate the practicability and great value of a trained, well-disciplined radio network, when all forms of commercial communication in large areas of Florida had been wiped out.

Looking at Florida we find Master Control Station, NIB, located at Miami, at the extreme southern end of the state, with Alternate Control Station, NDU, at Jacksonville, 350 miles to the north. This whole area is then divided into three sections. Nearly all areas of large population have a Unit centered therein. The expansion of this branch of the Naval Reserve will ultimately permit formation of Units in every large Florida city. Stations still welcome new men who are interested in radio communications, in serving their country, and who want to be included in the fine organization we of the Naval Communication Reserve believe we have.

The radio network drills of the Seventh Naval

District are patterned after those of the National Eastern Network, which is controlled by NAA. During "Cast" and "Baker" drills a great deal of official traffic is handled, thus killing two birds with one stone; training operators to handle naval traffic correctly and decreasing the amount of traffic through the mails necessary for the administration of the various units in the organization. At the conclusion of "Baker" and "Cast" drills all Section and Unit control stations are included in a District Tactical Drill, which is conducted alternately by NIB and NDU. The problems in use of Naval Communication procedure and solution of maneuvering board and cryptographic problems are substantially the same as in the National Net. On the first and third Thursdays of each month, while NIB and NDU are participating in National Drills, the various Section and Unit control stations rotate as District Guard Station, collecting traffic and conducting a District Tactical Drill in the same manner as do NIB and NDU.

It may be of interest that the Naval Communication Reserve was initially organized in the Seventh Naval District, later spreading all over the United States and its possessions. The first Naval Reserve radio station, NRRG, was located at Orlando, Florida, in 1927. The first transmitter was a pair of 50-watters in a Hartley, "self-rectified" circuit. The receiver used was the old Grebe regenerative type, which was still in extensive use in the Naval service in those days. Despite what would now be considered very crude construction, no difficulty was experienced in working the next established NCR station, in Maine. The personnel manning this first station were pioneers, in a way, amateurs with a determination to build something fine that might eventually prove of value to their country. The results were astounding: in a dozen years the Communication Reserve has built itself into an organization of approximately 6000 officers and men, extending all over the United States.

To the amateurs who contributed their services in the organization of the Naval Communication Reserve we owe a debt of gratitude. They should be very pleased that their brain-child has grown to such large proportions and at the same time continually increased training standards, so that the NCR is now capable of fulfilling its mission — to adequately augment the Communication Service of the regular Navy in case of war or national emergency.

Portable-Emergency Transmitters

Five Variations in Compact Equipment Design

You'll find plenty of ideas on small transmitter construction and design in this story. Even more important, you'll find a lot of useful tuning and adjustment kinks that can be applied to any rig.

THERE is little need to dwell on the high interest shown in portable equipment during the past few years. Floods, hurricanes and earthquakes have made the amateur emergency-conscious to a greater degree than ever before, and every well-rounded amateur has at least given some time and thought to emergency gear even if he hasn't had an opportunity to build it. The annual Field Day contest brings out more stations each year.

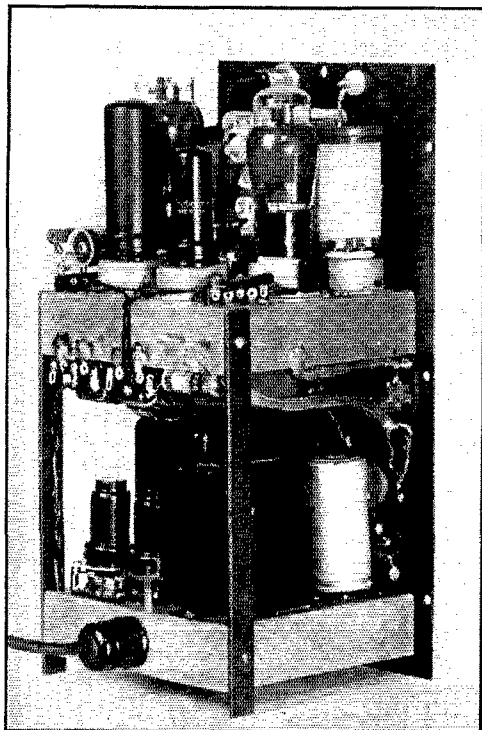

The W9ACO portable is patterned after the Norfolk outfit but features a built-in universal power supply, capable of either 110-volt a.c. or 6-volt storage battery operation. R.f. and audio on upper deck; the bottom deck carries the power supply.

Portable-emergency gear gives an amateur a real chance to demonstrate his ingenuity. Limited, in most cases, to low power and few tubes, the designer has a better chance to think out every detail than he would if the set were large and more complicated. Many a home-station transmitter is never really finished, but the portable one must be a complete unit before it will withstand the rigors of field operation. And we find it hard to believe that any amateur, no matter how many kilowatts he has burned, fails to get a bang out of working with a low-powered rig once in a while and finding that he can get out much better than he thought. (You should have heard some of the Century-Clubbers that participated in Field Day tell about the DX they worked with their 20-watt rigs!)

Here are five portable transmitters, similar in some respects and vastly different in others, but all mighty capable of doing the job for which they are designed.

* * *

A Universal Portable Transmitter

BY ED. HLAVATY, W9ACO

THIS transmitter, complete with modulator and a.c.-d.c. power supply, is built in a 15- by 7 $\frac{3}{4}$ - by 7-inch cabinet. The total weight is approximately 30 pounds. With 110 volts a.c. available, the input to the final runs 20 watts on 'phone and 30 watts on c.w. With a 6-volt storage battery power source, the input is 8 to 10 watts on 'phone and 20 watts on c.w.

The circuit is similar to that used by the Norfolk amateurs,¹ and uses a 6F6G Pierce oscillator to drive a 6L6G amplifier. A 6C5 speech amplifier, working from a single-button microphone, is resistance-coupled to a 6L6 Class-A modulator which is transformer-coupled to the r.f. amplifier. The use of a single-button microphone is economical and reduces the problem of elimination of vibrator hash and hum. Referring to the circuit, Fig. 1, it will be seen that a "high-low" switch, S₃, introduces dropping resistors in the screen circuits of the 6L6's. This changes the operating conditions of the modulator and modulated final to optimum for best efficiency at an input of 8 to 10 watts. Under these conditions, the total transmitter current is just within the current rating of the vibrator.

One might question the reduction of power by

¹ Priest and Turner, "Norfolk Amateurs Prepare for Emergencies," *QST*, September, 1938.

decreasing the screen potentials on the final amplifier and the Class-A modulator instead of loosening the antenna loading and not modulating heavily. However, the antenna loading should be adjusted to load the final to about 25 ma. when the switch is in the "low" position for battery operation, and if the screen voltage were not decreased the screen current would go up and the efficiency would be low for the final amplifier. If the total input to the final is 8 watts, 4 watts is the maximum audio power that is necessary, and there is no point in using more power to the Class-A modulator than is needed to deliver the 4 watts. The lower cathode current correctly adjusts the bias.

The resistance in the screen grid circuit of the Class-C final amplifier, except the 100-ohm parasitic suppressor, should be paralleled by a condenser equal at least to the r.f. screen-grid by-pass condenser. If this condenser is omitted, considerable audio distortion will result, especially when the screen grid resistance is high for low-power output.

A marked decrease in distortion will be noticed, particularly with small transformers, that reach saturation easily, when the d.c. current of the modulator is made to buck the effect of the final plate current through the transformer. The cor-

- C₁ — 200- μ fd. midget variable.
- C₂ — 320- μ fd. midget variable.
- C₃ — 260- μ fd. midget variable.
- C₄ — 0.0025- μ fd. mica.
- C₅ — 0.002- μ fd. mica.
- C₆ — 70- μ fd. mica.
- C₇, C₉, C₁₁, C₁₂ — 0.004- μ fd. mica.
- C₈ — 0.01- μ fd., 600-volt paper.
- C₁₀, C₁₃, C₁₄, C₁₅, C₁₈ — 8- μ fd., 50-volt electrolytic.
- C₁₅ — 0.05- μ fd., 400-volt paper.
- C₁₇, C₂₆, C₂₇, C₃₀ — 0.1- μ fd., 400-volt paper.
- C₂₁, C₂₂ — 8- μ fd., 400-volt electrolytic.
- C₂₃ — 0.004- μ fd. mica.
- C₂₄, C₂₅ — 0.001- μ fd. mica (used only with OZ4 rectifiers).
- C₂₈ — 0.02- μ fd., 600-volt paper.
- C₂₉ — 0.5- μ fd., 200-volt paper.
- Ch — 12-henry, 150-ma. choke.
- R₁ — 50,000 ohms, 1-watt.
- R₂ — 1000 ohms, 1-watt.
- R₃, R₁₂ — 75,000 ohms, 1-watt.
- R₄, R₉ — 10,000 ohms, 5-watt.
- R₅, R₁₈ — 15,000 ohms, 1-watt.

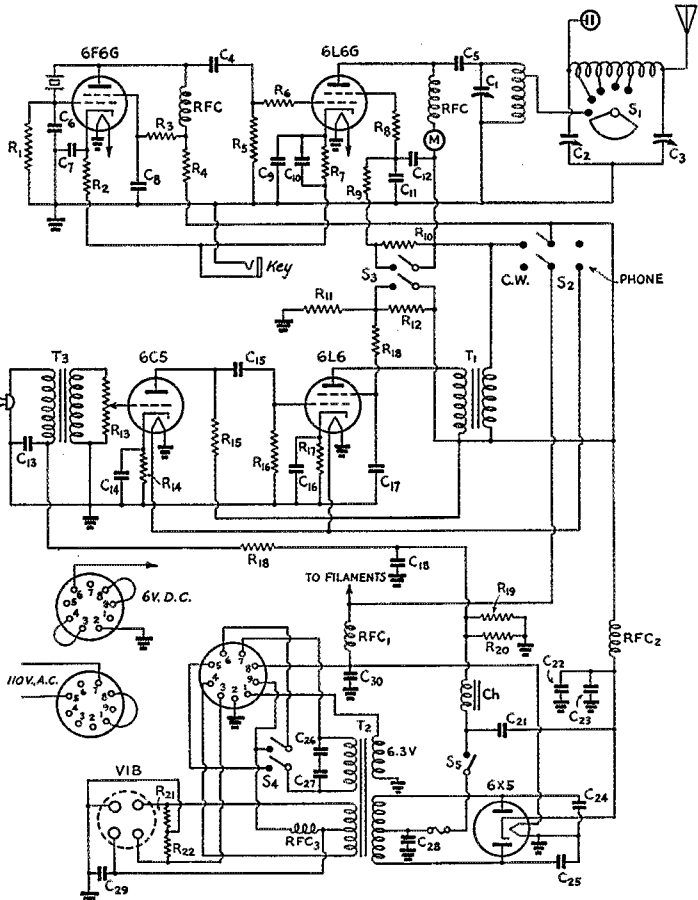
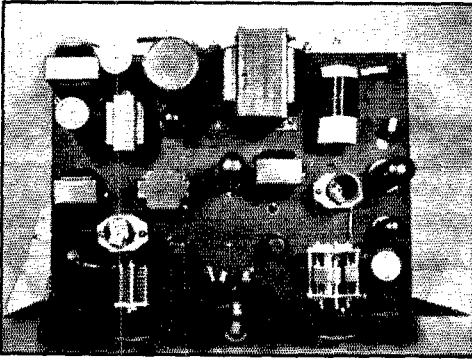

Fig. 1 — Circuit of the W9ACO portable.

- R₆, R₈, R₁₉, R₂₀ — 100 ohms, 1-watt.
 - R₇ — 250 ohms, 5-watt, wire-wound.
 - R₁₀ — 200,000 ohms, 1-watt.
 - R₁₁ — 100,000 ohms, 5-watt.
 - R₁₃ — 100,000-ohm volume control.
 - R₁₄ — 3500 ohms, 1/2-watt.
 - R₁₅, R₁₆ — 100,000 ohms, 1-watt.
 - R₁₇ — 300 ohms, 5-watt.
 - R₂₁, R₂₂ — 200 ohms, 1-watt.
 - T₁ — Output transformer, 6000 ohms to 4250 ohms (UTC S18).
 - T₂ — Dual primary transformer (Thordarson T14R40).
 - T₃ — Single-button microphone transformer (UTC S5).
 - S₁ — 6-point tap switch.
 - S₂ — D.p.d.t. toggle switch.
 - S₃ — D.p.s.t. toggle switch.
 - S₄ — D.p.s.t. toggle switch, heavy duty.
 - S₅ — S.p.s.t. toggle switch.
 - RFC — 2.5-mh. r.f. choke.
 - RFC₁ — 20 turns No. 16 d.c.c. self-supporting, 1/2" diameter.
 - RFC₂ — Broadcast-type choke or winding from 175 kc. i.f. transformer.
 - RFC₃ — 60 turns No. 12 enam. layer-wound on 1" long form, 3/8" diameter.
- Vibrator is a Mallory 294 or 825 (the 825 will handle more current). Coil dimensions same as in original article (QST, September, 1938).



A complete portable station, including receiver, transmitter and universal power supply, leaves W9TMY prepared for any emergency. The receiver, on the left-hand side of the chassis, is patterned after the W8QBW two-tube of the January, 1939 QST, and the transmitter (on the right) is the well-known 6CS-6L6 combination, with built-in universal antenna coupler added. Power supply along the rear of the chassis and modulator in the center round out the works.

rect connection can be determined easily by trying the two possible primary connections and using the one that gives the best quality.

The power supply is universal and compact. The Thordarson power transformer is a standard unit with dual primaries — one for 110-volt a.c., the other for 6.3-volt battery-vibrator operation. The transformer also includes a 6.3-volt filament winding which is used only when 110-volt a.c. operation is desired.

A standard full-wave rectifier circuit is used employing two 6X5 (or OZ4 tubes) with each tube acting as a half-wave rectifier, i.e., the plates are paralleled in each tube. Using OZ4 tubes eliminates filament power for the rectifiers and they are preferable for portable 'phone work. However, on c.w. they will cause a slight keying chirp, since they lag in passing current until the load reaches about 40 ma.

The switching for 110-volt a.c. or 6.3-volt d.c. operation is accomplished by the plug-in power-supply cords. For 110-volt a.c. operation, the plug disconnects the vibrator and connects the 110 line to the primary of the transformer through the on-off switch and the tube heaters to the 6.3-volt winding. For 6-volt d.c. operation the vibrator is connected into the circuit by the battery plug while the 110-volt a.c. primary is left floating and the heaters are switched from the transformer to the battery. The 6 volts d.c. is supplied through a pole of the heavy duty 10-ampere d.p.d.t. switch. The other side of the switch is used to control the 110-volt a.c. when that current is available.

To prevent excessive arcing at the vibrator contacts, a capacity whose reactance will counteract the inductive reactance of the transformer is needed to reduce the arcing and consequent

wear. The correct capacity can be put across the contacts directly but, at the low potential of 6 volts, a high capacity would be required. Since the same result will be accomplished by using a lower capacity at a higher voltage, it is advantageous to put the capacity across the 110-volt primary. Too high or too low a capacity for this condenser will manifest itself as bad peaks at the closing of the contacts on each half cycle if the vertical plates of a cathode-ray tube are connected across the full vibrator primary and a sweep frequency is used that is high enough to get three or four cycles on the screen.

Excessive capacity under load shows up as too slow a cutting-off of the voltage at the end of each half cycle, and insufficient capacity under load is indicated by too sharp a cutting-off of the voltage at the end of each half cycle. It is advisable to use slightly more than the optimum amount of capacity, to take care of the increasing time interval as the contacts on the vibrator wear out. Mallory-Yaxley vibrators, which operate at 115 cycles, require a smaller condenser than a vibrator such as the Electronic Laboratories (Indianapolis, Ind.) No. 490 which is a 60-cycle affair. However, the No. 490 will handle 125 watts from a 6-volt battery.

To improve further the vibrator contact life, two 200-ohm non-inductive carbon resistances are connected from each side of the vibrator primary to ground, to absorb surge voltages at the vibrator contacts.

The photo indicates roughly the parts layout used. The plug receptacle in the power supply and the plugs on the a.c. and d.c. cords were changed to nine-prong so that one side of the supply to the vibrator could be broken, since it had a tendency to hum with a.c. operation when directly connected across the 6.3-volt primary.

* * *

QRR Rig—1939 Model

BY C. E. McGUIGAN, W9TMY

A QRR rig, brought up to 1939 requirements, should include transmitter, receiver, modulator, power supply for both 110 a.c. 25- or 60-cycle, and 6-volt d.c., together with the antenna tuning system, all in a single unit.

That seems like a fair-sized order, but it can be done on a 12- by 17- by 3-inch chassis and 8¾-inch relay-rack panel. It includes break-in, standard parts, ease of control and simplified tuning, an output of 15 watts on c.w. and 10 on 'phone.

In the power supply, the transformer selected from the parts morgue was a fair-sized 25-cycle, 110-volt job, capable of putting out about 425 volts each side at about 75 to 100 ma. A 7-volt center-tapped winding of No. 13 enameled was

added (after the other filament windings had been removed) to supply the heater voltage when used on 110 a.c. and as the primary of the transformer when 6 volts d.c. was used. With the high-voltage d.c. output from the 6X5 (or 84 or 6W5G), the ordinary run of wet electrolytic condensers proved to be fair heavy duty bleeders, so 600-volt paper condensers were substituted, with a great increase in efficiency and prolonged rectifier tube life. The circuit diagram of the changeover switch (for d.c. to a.c.) is self-explanatory, but *don't* try to run the rig on a.c. with the vibrator in the socket! Both the 110- and 6-volt lines are fused for safety.

Be sure to put in the hash filters and use condensers of high enough voltage rating. If you can't get all the hash out, get an audio transformer and put the 'phones across the output terminals and go exploring. You will find that the vibrator itself probably puts out more hash than the rest of the circuit combined. Shielding or rearrangement of parts is about all you can do to help this situation.

Complete details of the receiver may be found in the January, 1939 issue of *QST*. The only circuit change made was to use a 6J7 and 6C5 and to wire B-plus to the audio amplifier screen terminal so that a 6F6 can be used if desired. An output transformer is connected as a choke to feed the audio plate coupling the 'phones through a condenser. This keeps plate voltage out of the 'phones and protects your crystal 'phones.

The transmitter was taken from the September, 1938 *QST*, and modified to use a 6L6 in the output. The use of octal sockets and tubes increases the flexibility of the entire job, giving the choice of several types of tubes in the event that something goes haywire.

The oscillator is wired up so that you can use any triode or power pentode, such as 6C5, 6F6, 6V6 or 6L6. There is plenty of grid drive to the final with any of these tubes. The condenser between the plate and crystal saves crystals and dispositions. Up to 3 and 4 ma. final grid current with the amplifier loaded can be expected.

The shunt-feed tank circuit was used to keep high voltage off the tank, and it also saves the

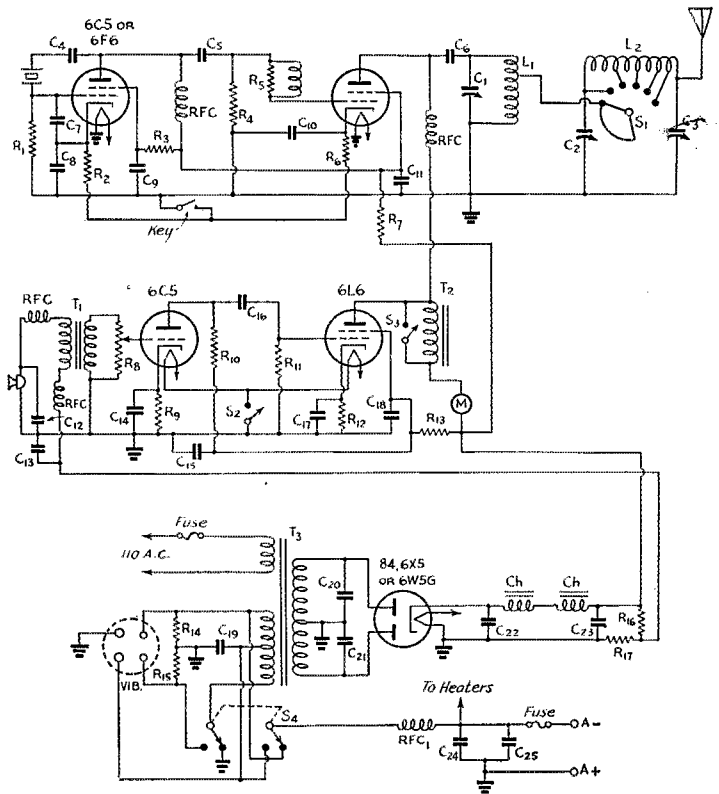

Fig. 2 — The transmitter and power-supply circuit at the W9TMY portable station.

- C₁ — 150- μ fd. variable.
- C₂, C₃ — 200- μ fd. midget variable.
- C₄, C₈, C₉, C₁₀ — 0.005- μ fd. mica.
- C₅, C₁₂ — 0.0001- μ fd. mica.
- C₆, C₁₁, C₂₄ — 0.002- μ fd. mica.
- C₇ — 50- μ fd. mica.
- C₁₃ — 5- μ fd., 25-volt electrolytic.
- C₁₄ — 10- μ fd., 25-volt electrolytic.
- C₁₅ — 4- μ fd., 450-volt electrolytic.
- C₁₆, C₂₅ — 0.02- μ fd. paper.
- C₁₇ — 25- μ fd., 50-volt electrolytic.
- C₁₈ — 0.1- μ fd. paper.
- C₁₉ — 0.5- μ fd. low-voltage paper.
- C₂₀, C₂₁ — 0.01- μ fd., 2000-volt mica.
- C₂₂, C₂₃ — 8- μ fd., 600-volt paper.
- Ch — 30-henry, 150-ma. choke.
- R₁ — 25,000 ohms, $\frac{1}{2}$ -watt.
- R₂ — 1000 ohms, 1-watt.
- R₃ — 75,000 ohms, 1-watt.
- R₄ — 15,000 ohms, 1-watt.
- R₅ — 100-ohm carbon with 8-turn choke of No. 18 wire wrapped around the resistor.
- R₆ — 500 ohms, 10-watt.
- R₇, R₁₃ — 10,000 ohms, 10-watt.
- R₈ — 500,000-ohm volume control.
- R₉ — 3000 ohms, $\frac{1}{2}$ -watt.
- R₁₀, R₁₁ — 100,000 ohms, $\frac{1}{2}$ -watt.
- R₁₂ — 250 ohms, 10-watt.
- R₁₄, R₁₅ — 50 ohms, 1-watt.
- R₁₆ — 25,000 ohms, 50-watt.
- S₁ — 6-position shorting switch (Yaxley 161C).
- S₂, S₃ — S.p.s.t. toggle switch.
- S₄ — D.p.d.t. toggle switch.
- T₁ — Single-button microphone transformer.
- T₂ — 30-henry, 100-ma. choke.
- T₃ — 425-volt, 100 ma., 25-cycle transformer with 7-volt filament winding of No. 12 wire added. (Thordarson T14R40 can be used.)

tube if the tank coil is removed, since the screen current remains at a low value. Don't try to pinch pennies in buying the coupling condenser between plate and tank coil, and a good mica condenser of 200-volt rating is suggested.

The coils were wound and trimmed so that the proper LC ratio would be maintained (about 1 μ fd. per meter) and taps taken off about one-third down from the plate end. Remember that the plate and grid ends of the coils should be on top. In connecting r.f. chokes, hook the inside turn of pie-wound types to the plate.

The antenna tuning system needs no explanation except the band switch used to short turns. It is a Yaxley 161-C with four contacts, single section. A piece of the main circular ring was cut out so that the coil could be disconnected to bring the final condenser into resonance. This arrangement is quite flexible and will match any skywire used either with ground or without.

Be sure to use good condensers in the cathodes of the audio tubes, and r.f. chokes on each side of the microphone transformer. Bring up the gain until the plate meter begins to kick. The 6L6 modulator plate drew 40 ma., so the r.f. amplifier was loaded to 40 ma. to get the best match possible.

In laying out the chassis, follow the positions for transformers as shown in the picture, since

this arrangement seems to give the least hash and hum. The filament leads and high voltage leads were put in shielding and soldered to the chassis, not so much for shielding as to keep them in place and out of stray fields.

I have discovered that this unit serves very satisfactorily as regular station transmitter and receiver as well as being completely portable for QRR work. One Sunday morning's round table proved that the rig could be used on 160 'phone and seemed reliable up to 50 miles. On 40- and 80-meter c.w., all districts report consistent signals.

* * *

A Portable for 3.5-, 14- or 28-Mc. 'Phone or C.W.

BY T. E. TAPPAN, W8AVD

THE oscillator was built to operate as an e.c.o., Tri-tet or straight pentode. Using a 6V6 tube in place of the 6F6, and a 7-Mc. crystal, gives ample output on 20. Even on 10 meters I get about 4 ma. grid current to the amplifier grid. Changing the oscillator circuit is accomplished by a toggle switch on the panel and tuning the cathode tuning condenser till it either shorts out

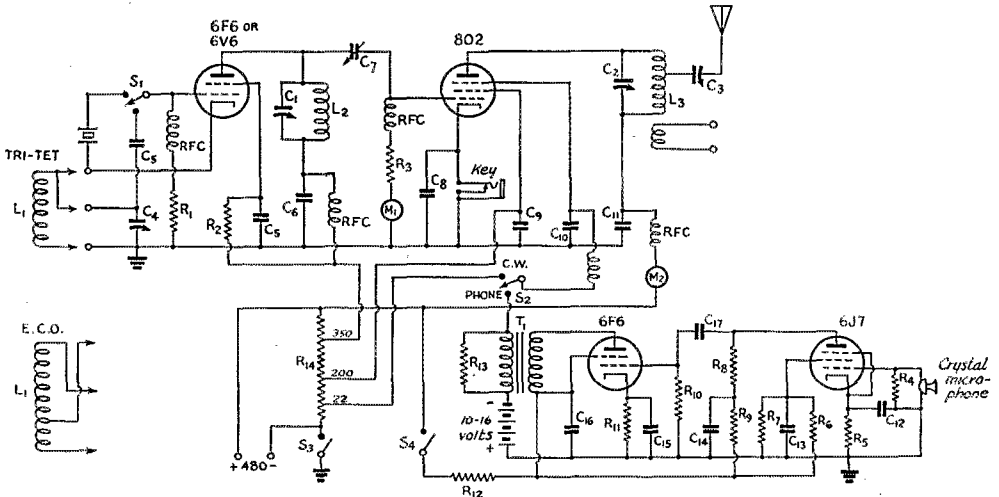

Fig. 3 — Diagram of the W8AVD rig.

C₁, C₂, C₃, C₄ — 100- μ fd. variable.
 C₅, C₈ — 0.001- μ fd. mica.
 C₆, C₉, C₁₁ — 0.002- μ fd. mica or paper, 600-volt.
 C₇ — 35- μ fd. variable or fixed.
 C₁₀ — 0.0001- μ fd. mica.
 C₁₂ — 10- μ fd., 25-volt electrolytic.
 C₁₃, C₁₇ — 0.01- μ fd. paper.
 C₁₄, C₁₆ — 8- μ fd., 500-volt electrolytic.
 R₁ — 100,000 ohms, 1-watt carbon.
 R₂ — 25,000 ohms, 10-watt.
 R₃ — 15,000 ohms, 2-watt.
 R₄ — 2 megohms, 1/2-watt.

R₅ — 2000 ohms, 1/2-watt.
 R₆, R₈, R₁₀ — 250,000 ohms, 1/2-watt.
 R₇, R₉ — 50,000 ohms, 1/2-watt.
 R₁₁ — 400 ohms, 1-watt.
 R₁₂ — 10,000 ohms, 10-watt.
 R₁₃ — 7000 ohms, 2-watt.
 M₁ — 0-15 ma.
 M₂ — 0-75 ma.
 R₁₄ — 25,000 ohms, 75-watt wire-wound adjustable.
 T₁ — Grid-modulation transformer (Thordarson T 78D46).

COIL TABLE FOR THE W8AVD TRANSMITTER

L_1	1725-2000 kc. e.c.o.	60 turns No. 24 d.s.c. tapped at 16th turn
	7000-7300 kc. e.c.o.	15 turns No. 16 tapped at 3rd turn
	Tri-tet and 7-Mc. crystal	7 turns No. 16
L_2	3.5-4.0 Mc.	35 turns No. 16
	14.0-14.4 Mc.	8 turns No. 16
	28-30 Mc.	5 turns No. 10
L_3	3.5-4.0 Mc.	39 turns No. 14 d.c.c. $1\frac{3}{4}$ " diam.
	14.0-14.4 Mc.	11 turns No. 10 enam. $1\frac{3}{4}$ " diam.
	28-30 Mc.	8 turns No. 10 enam. $1\frac{3}{4}$ " diam.

L_1 and L_2 are $1\frac{3}{4}$ " diam.

or tunes the circuit, whichever the case may be. The rest of the oscillator circuit is conventional.

The 802 final is pretty much standard. A toggle switch changes the suppressor voltage from 22 volts positive for c.w. to 16 volts negative for 'phone. The third toggle switch is a d.p.d.t. permitting the filament and high voltage to be removed from the audio section when using c.w. When operating in the field, battery drain is an important factor. The fourth toggle acts as a stand-by switch, cutting the negative to the whole set. Keying is a simple matter and is done in the cathode circuit of the 802. I found that by using different sizes of r.f. chokes in the grid, plate and suppressor circuits helped to stabilize the 802's operation. The shield for the 802 was made from an old coil shield can.

When tuning up, the grid current to the 802 is always set at about 5 ma. on 'phone and 3 or 4 on c.w. I use an oscilloscope for checking the adjustments, but a little care without it will make for an excellent quality 'phone.

Adjustment of the final for 'phone operation is simple enough. First, throw the toggle switch S2 to the "c.w." position and load up the rig for a plate current of 50 ma. Then throw the switch to the "phone" position and adjust the battery bias for 25 ma. plate current. This voltage happens to be about 16 volts negative for my set-up. A good percentage of modulation is noted on the oscilloscope.

◆

The portable-emergency rig at W8AVD uses a suppressor-grid-modulated 802 in the output stage. The oscillator is connected either Tri-tet or e.c.o. by plugging in the proper coil.

◆

Some good "don't's" to keep in mind: Don't try to use over 500 volts on the 802. Don't use over 50 mils at any time on the plate. Don't run over 5 or 6 grid ma. In operating a pentode r.f. amplifier, the grid current is the key to its success. Increasing and decreasing it varies the screen current very rapidly. With low grid drive, the current is too low and the output drops off very fast. Excessive grid drive will cause high screen current and quickly ruin the tube. In my experience with pentodes, I have found that one or two grid ma. will vary the screen current from 10 to 20 ma. Use no more than the right amount of current, and the pentode will do its work nicely.

This rig can be powered completely from a 6-volt battery and vibropack, or from B batteries if necessary.

I have contacted stations all over the states with this rig on 20, and on 75 it's as easy to QSO stations as it is with my larger transmitter. The S-meter readings from stations a good distance away in daylight on 75, averaged S7 with many an S9.

* * *

A Simple Portable Transmitter

BY FRANCIS L. SHERWOOD,
W8NCM

A TRANSMITTER for portable use should be capable of being put into operation with as little effort and fussing as possible. This means a transmitter with as few stages and controls as possible. With this idea in mind, the transmitter circuit shown in Fig. 4 was designed. The rig will feed any type or length of antenna on 160, 80 and 40 meters, 'phone or c.w., *without changing any coils and without band switches!*

The original idea was to make a transmitter capable of working all bands down to 10 meters, but the circuit became complicated and the rig required too many controls. By eliminating the gear that would be necessary to work 10 and 20 meters, we arrived at the simple circuit shown. The oscillator is the familiar Pierce type, requiring no tuned circuits. Not having any tuned circuits in the plate of the oscillator removed the necessity for neutralizing the final amplifier, and

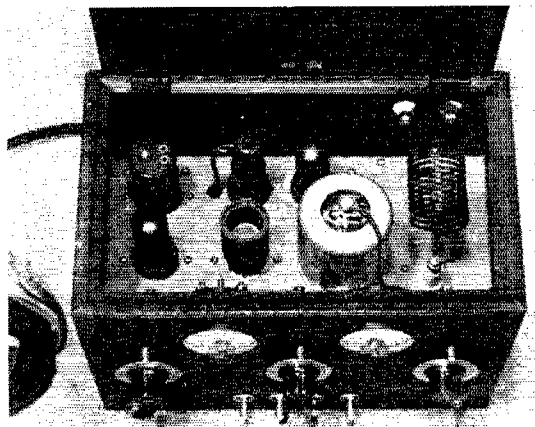

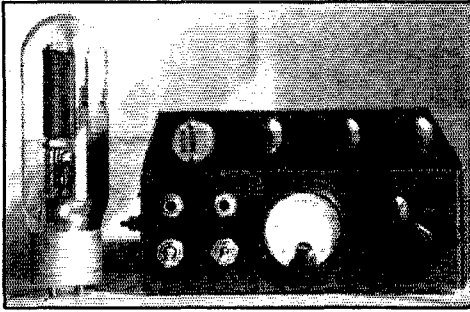

This handful of transmitter, built by W8NCM, is good for three-band operation, 'phone or c.w. Three 6L6 tubes are used; the circuit features an untuned Pierce oscillator and a universal antenna coupler also used as the final tank. This is a top view of the gadget — it is used with the tubes in a vertical position.

not having to neutralize the final amplifier makes it possible to work without a tank coil. In place of the tank coil, a coupling network is used.

Rather large condensers are required for the network, but this allows operation on three bands without changing coils. The network operates normally on 160 and 80 meters because of the large capacity of the condensers, but has a standing wave on it on 40 meters.

The transmitter uses all 6L6 tubes. They were selected because they are cheap and require little drive. However, the oscillator does not have to be a 6L6, and a 6V6, 6F6, 6C5 or 6J5 can be used if the crystals used are fairly active. With cheap crystals, the 6L6 seems to work the best. Also, 6L6's are used because it is only necessary to have one spare tube in case of tube failure instead of two or three types. If heater drain is an important factor while operating from a storage battery, a 6C5 or similar low-drain tube can be used as the oscillator if you have good crystals.

The transmitter modulator circuit is also extremely simple. There is sufficient audio power to overmodulate the final even when running 40 watts input. There are no speech amplifiers or expensive transformers to buy or build. The input transformer is a high-gain single-button microphone to single grid transformer. The secondary should be a high-impedance winding so that you won't have to climb inside the mike to get enough gain. The tube is biased by a cathode resistor in the 6L6 modulator tube, and this resistor must be heavily by-passed by at least 25 μ f. or the quality will be rough and you won't be able to get all of the available audio power from the modulator.

The best microphone we have found for this type of rig is either a Stromberg-Carlson or a Western Electric of the late type used in their cradle 'phones. Both the Western Electric and Stromberg-Carlson have excellent quality and high output. They will not pack when left on for

long periods of time or if the microphone current is too high. There is a switch on the front of the transmitter that cuts out the choke and plate voltage to the modulator while operating on c.w.

The transmitter is mounted in an aluminum cabinet measuring $8\frac{1}{4}$ by $5\frac{1}{2}$ by $6\frac{1}{2}$ inches. The three tubes and the crystal mount on a step $2\frac{1}{2}$ inches high and 2 inches deep. This allows the tubes to be in the open and makes a strong and neat arrangement for the whole rig. The set weighs about 12 pounds and mounts easily in an automobile or fits almost anywhere on the operating desk.

The power supply can be practically anything. For home use, I use a 500-volt, 150-ma. power supply and run the rig at 40 watts input on c.w. and about 25 watts input on 'phone.

The transmitter will feed practically any length of antenna on all three bands. Zepp antennas can be fed by connecting the two feeders together and using it as an end-fed antenna. With a 10-foot piece of wire for the antenna on 160 meters, it is possible to work about 10 miles during the day with good reports. With a half-wave antenna on either 160 or 75 meters, it is very easy to work about 80 miles on 'phone in the daytime.

The only difficulty I have had with antennas is in trying to feed a quarter-wave job. This is

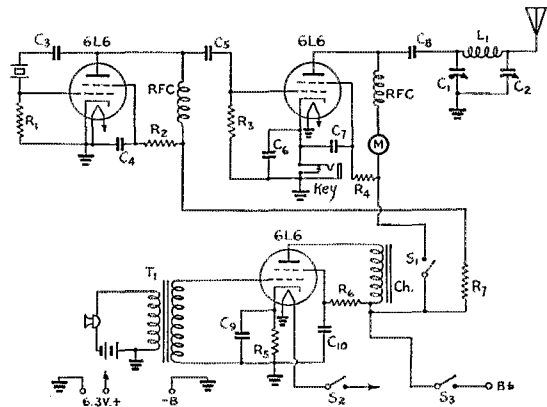

Fig. 4 — Diagram of the W8NCM simple portable.

- C₁, C₂ — 200- μ f. variable.
- C₃, C₄, C₆, C₇, C₈ — 0.001- μ f. mica.
- C₅ — 0.0001- μ f. mica.
- C₉ — 25- μ f., 50-volt electrolytic.
- C₁₀ — 2- μ f., 450-volt electrolytic.
- Ch — 20-henry, 125-ma. choke.
- L₁ — 90 turns No. 22 on $1\frac{1}{4}$ " form.
- M — 0-100 ma.
- R₁ — 50,000 ohms, $\frac{1}{2}$ -watt.
- R₂, R₃ — 20,000 ohms, $\frac{1}{2}$ -watt.
- R₄ — 15,000 ohms, 10-watt.
- R₅ — 450 ohms, 10-watt.
- R₆ — 5000 ohms, 1-watt.
- R₇ — 7500 ohms, 10-watt.
- S₁, S₂, S₃ — S.p.s.t. toggle switch.

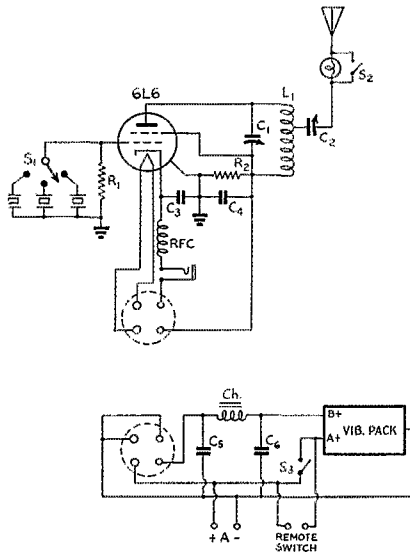

Fig. 5 — The transmitter of W6OQH.

- C₁ — 50- μ fd. variable.
 - C₂ — 100- μ fd. variable.
 - C₃ — 0.00025- μ fd. mica.
 - C₄ — 0.01- μ fd. mica or paper.
 - C₅, C₆ — 8- μ fd., 450-volt electrolytic.
 - Ch — 25-henry, 100-ma. choke.
 - L₁ — 36 turns on 1 1/2" diam. form for 3.5 Mc.
 - R₁, R₂ — 50,000 ohms, 2-watt.
 - RFC — 2.5-mh. r.f. choke.
 - S₁ — Multi-point rotary switch.
 - S₂, S₃ D.p. s.t. toggle switch, connected in parallel for heavy duty.
- Vibrator pack is a Mallory No. 552.

because the maximum capacity of the output condenser of the network is not large enough to match a quarter wave. However, this can be remedied easily by putting a series condenser between the end of the antenna and the rig, and it will then tune up like any other antenna. Another important consideration in getting out well is the ground system. When using an antenna shorter than a half wave, one should use a ground or counterpoise hooked to the frame of the transmitter. This doesn't have to be anything elaborate—the automobile body makes a pretty

Built in a small cabinet with hinged cover, the transmitter at W6OQH uses a built-in vibrator power supply. A plug disconnects the r.f. portion from the power pack when the transmitter is removed. Crystal switching from the front panel proves a big advantage during traffic and normal operation.

good ground for a short antenna strung in a nearby tree, or the farmer's fence can be called into service.

For best results, the transmitter final should operate as a straight amplifier at all times, which means a crystal for each band. This may sound expensive, but crystals are cheap.

It is not advisable to double in the final because with the small grid leak, it doubles poorly. This helps to make sure the rig is on the right band.

To tune up the rig, place a crystal for the desired band in the socket and connect the antenna. To test the rig, a small 10-foot wire in the room may be used. Regardless of the antenna, the procedure is the same. Have the output condenser C₂ tuned for maximum capacity. Turn on the power and adjust the input condenser C₁ for minimum plate current. If the input is too low, decrease the capacity of C₂ a slight amount and readjust C₁ for minimum current. Repeat this procedure until the input is where you want it. The 40-meter band is tuned the same way. The standing wave will take care of itself and you won't even know it is there. If you are not able to make the plate current meter dip anywhere in the range of the condenser, it is because the end impedance of the antenna is too low and is loading the circuit too heavily. To prevent this, put in a series condenser and adjust it till the end of the antenna is sufficiently high impedance so that it falls within the range of the network.

* * *

A Self-Contained Portable

BY HAP MAULE, W6OQH

LACKING regular power at this location, dependence has been placed on a small transmitter and Vibrapack power supply. The results have been quite satisfactory, and our regular work on the AARS net has never suffered from equipment breakdown.

The transmitter is a regenerative 6L6 crystal oscillator coupled to the antenna by a hybrid system that works quite well. Crystal switching

(Continued on page 86)

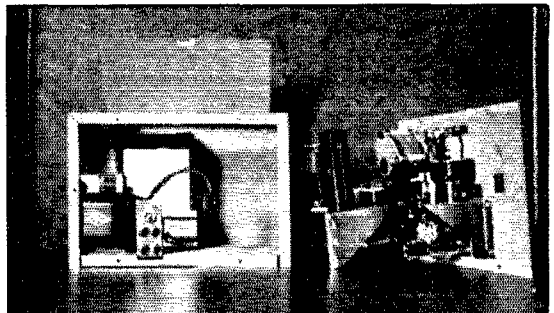

★ WHAT THE LEAGUE IS DOING ★

COMMITTEE APPOINTMENTS

THE President announces the appointment of the following two Board committees as instructed at the recent meeting of the Board:

Committee on Amateur Frequency Assignments, for the year until the next Board meeting: Mr. Noble, chairman, and Messrs. Young and Mathews.

Committee to examine the Wouff Hong plan: Mr. Martin, chairman, and Messrs. Adams and Blalack.

The President is, ex-officio, a member of all Board committees also.

BY-LAWS REPRINTED

THE Constitution & By-Laws of the League have been reprinted to show the changes made at the last meeting of the Board. Any member of the League may obtain a copy free upon request to Headquarters.

WASHINGTON NOTES

THERE'S not much doing at Washington during the hot weather. Bills to reorganize or investigate the F.C.C. have been abandoned for this session of Congress. It seems that a broad investigation of the wire telegraph industry will be authorized by Congress. No news yet on authorizing carrier-riding on 112 Mc. up.

QUESTIONNAIRE DATA

REMEMBER the questionnaire the League sends to each new and renewing member? They show some interesting things about us:

Our membership divides 31.2% Class A, 32.1% Class B, 7.5% Class C, 9.6% foreign licensed (including Canada), and 19.6% unlicensed. Considering only the United States membership, it divides 34.5% Class A, 35.6% Class B, 8.3% Class C, and 21.6% currently unlicensed. Considering just the licensed U.S.A. membership, it divides 44% Class A, 45.4% Class B, 10.6% Class C. Our average age for all members is 29.5 years, that for the U.S.A. licensed membership 29.9%, with all classes of license at nearly the same figure.

We notice some quite interesting things on the equipment used. Nearly 60% of our transmitters are under 125 watts input and only about 15% are above 300 watts; the average power input appears to be about 175 watts. Our tabulation shows that 95.8% of amateur transmitters are home-made, only 4.2% factory-made. Receivers, on the other hand, run 67.3% manufactured to 32.7% home-made. In the low-power brackets, however, the ratio is just about 50-50, the

percentage of manufactured receivers increasing steadily with increase in transmitter power.

EXECUTIVE COMMITTEE MINUTES

CONTINUING our publication of minutes begun last month, we present below an abstract of the minutes of the meetings of the A.R.R.L. Executive Committee held during the year preceding the last meeting of the Board — by direction of the Board and for your information.

Meeting No. 152, August 10, 1938

Meeting in the headquarters office of the League, with Vice-President Bailey in the chair, the Executive Committee: Approved, with certain changes, the tentative program for the national convention at Chicago in September; directed the attendance at the national convention of Messrs. Woodruff, Bailey, Warner, Hebert, Handy, Hull, Grammer, Rodimon and DeSoto; requested the Chicago Area Radio Club Council to keep its convention records in such fashion as to supply certain data on attendance; ordered that Public Service certificates be issued to Mrs. Dorothy Hall, W2IXY, and to Andrew Young, VR6AY, in recognition of meritorious work in the relief of Pitcairn Island, and directed the editor of *QST* to endeavor to secure material for a *QST* article on the work done; approved the holding of six A.R.R.L. conventions; granted affiliation to seven clubs, reaffiliated two, terminated the affiliation of four for non-compliance with Board regulations; approved plans for the dedication of WIAW on Sept. 2d.

Meeting No. 153, September 3, 1938

Meeting in Chicago with full attendance, the Executive Committee: Examined a petition in good order nominating R. H. G. Mathews as a candidate for director from the Central Division in the autumn elections; were advised by the Secretary that the most recent unbroken membership of Mr. Mathews began in November, 1936, and that F.C.C. records showed his most recent license to operate amateur stations expired October 23, 1929; after discussion, admitted Mr. Mathews to its meeting at his request, and invited a statement; heard him urge that the requirement of four years' membership and possession of amateur operator license did not specify the four years immediately preceding nomination; after his retirement, upon further discussion, concluded there was reasonable doubt of the Board's actual intention in adopting the existing language; directed the Secretary to lay the question before the Board of Directors to state, for the information of the Committee, exactly what was contemplated by the language of By-Law 12 in this respect.

Meeting No. 154, November 2, 1938

Meeting at the headquarters office, the Executive Committee: Authorized the holding of two divisional conventions; authorized the Treasurer to reinvest funds on hand from the redemption of certain bonds in \$3000 U. S. Treasury 3's, due 1955, quoted 107-108, to yield about 2.55%; granted affiliation to four clubs; heard a report from the Communications Manager on the first two months' operation of WIAW; authorized the purchase of emergency power equipment for WIAW; proceeded then to an examination of the nominations for director and alternate director in the 1938 election, with rulings and findings as reported in detail in December *QST*.

Meeting No. 155, December 20, 1938

At a meeting at the headquarters, with full attendance the Committee: Constituted itself a committee of tellers as

prescribed in the By-Laws, to canvass the votes in the 1938 elections; appointed ten clerks to assist in the work of opening ballot envelopes; made a careful counting of the ballots, with findings as reported in detail in February *QST*; certified the same for the permanent records of the League and discharged its clerks; named May 5 and 6, 1939, as the dates for the annual meeting of the Board of Directors; approved the holding of a Dakota Division convention at Minneapolis any week-end in May not conflicting with the Board meeting; heard from the Treasurer that he had purchased \$3000 of United States Treasury 3% bonds at a cost of \$3196.88; granted affiliation to two clubs and reaffiliated one; heard brief reports from the Communications Manager and Secretary on current affairs.

Meeting No. 156, April 21, 1939

At a meeting at the headquarters office with full attendance, the Executive Committee: Authorized Assistant Secretary DeSoto to sign League checks on behalf of the Secretary during the month of May only; approved the holding of nine A.R.R.L. conventions; granted affiliation to seventeen clubs and terminated the affiliation of two for non-compliance with Board regulations; cast the vote of the A.R.R.L. in favor of the representation of the I.A.R.U. at the Stockholm meeting of the C.C.I.R. in June, 1940, by the Sveriges Sandareamatörer.

Pacific-Southwestern Division Convention

**San Francisco, Calif., September
2nd, 3rd, 4th**

ONCE again the convention of the Pacific and Southwestern Divisions will be a joint affair. The convention is sponsored by a committee of representative amateurs of the San Francisco Bay Area, appointed by Director J. L. McCargar, operating as the Bay Counties Radio Amateurs Association, Inc. Hams everywhere take notice that you are cordially invited to attend the 20th Annual Pacific and the 4th Annual Southwestern Division Convention to be held jointly at San Francisco, Calif., September 2nd, 3rd and 4th, 1939. The Hotel Whitcomb, overlooking the Civic Center, will be the headquarters.

The program has been prepared so that a variety of events will take place during the three-day affair. A 60-mile tour that will cross both bridges and include a trip through the big RCA transmitting plant at Bolinas, ending up at the Golden Gate International Exposition on Treasure Island, where W6USA will have open house, has been planned. At the Exposition, RCA will give a special television demonstration and G.E. Co. will give a special showing of its International Short-Wave transmitter W6XBE.

Entertainment, dancing, outstanding technical speakers, open forum, army net, naval reserve and DX meetings. A big Banquet and real prizes. A Wouff Hong initiation will be held and other special events. "It's going to be a big affair."

Registration Fee: \$3.75, includes all events.

Further information may be obtained by writing Bay Counties Radio Amateurs Association, Care Whitcomb Hotel, San Francisco.

Dr. Arthur E. Kennelly

DR. ARTHUR EDWIN KENNELLY, a former member of the A.R.R.L. Board of Directors and Professor Emeritus of electrical engineering at Harvard and the M.I.T., passed away in Boston on June 18th at the age of 77, after a long illness.

Prof. Kennelly had a long and most distinguished career in electricity, during which he earned many honors. He began as an apprentice electrician on a cable ship, becoming senior ship's electrician in his company. From 1887 to 1894 he was Edison's principal electrical assistant. He laid several cables for the Mexican government in 1902. He was on the Harvard faculty from 1902 to 1930, and from 1913 to 1924 was a professor at M.I.T. Well known in international scientific circles, he was a former president of the American section of U.R.S.I., 1933 recipient of the Edison medal, and had been awarded the cross of the Legion of Honor.

He was greatly interested in amateur radio. He was a director of our League during the years 1922 and 1923. When the international radio conference was held in Washington in 1927, Dr. Kennelly was a staunch and invaluable friend of the amateur, serving as chairman of one of the subcommittees of the all-important Technical Committee. Much of the qualities of Kennelly the man, and a glimpse into his love for amateur radio, may be seen in the greetings he sent to A.R.R.L. on the occasion of our twentieth anniversary and published in *QST* for May, 1934. Said he then:

In our childhood, we read of fairies, witches and other supernatural folk careering abroomstick over the skies. The A.R.R.L. has out-realized those nursery tales with nothing but an antenna as a vestige of the broom fancy, for the radio amateur actually launches his personality into the upper air beneath the layered ionosphere almost at light speed, and calls upon his friends, perhaps half-way around the world — friends whose language he may not know, and whom he may never be able to meet face to face — to close the circuit of his thought.

The messages our radio amateurs exchange are bright with greeting, sympathy, and good cheer. The radio amateur language is highly distinctive, being mostly basic English interlarded with many international code-letter groups and abbreviations, more euphonious when transmitted than when vocalized. It sounds cheerily in buzzing dots and dashes through the head-phones of the listening amateur. *QST* is its journal and its theme is 73. What an army of goodwill and international amity are the world's radio amateurs! Their whisperings over all the oceans make for peace. So long as the amateurs are allowed to talk to each other freely, the world's peace is assured. Only with war and violence is the amateur's voice hushed.

We all hope that in the next twenty years these knights of the joyous venture may continue their happy and helpful service to mankind, utilizing the ionosphere which radio science ever seeks to explore and understand. As in the past, we must all endeavor to make their useful influence realized

(Continued on page 74)

Polystyrene: Its Electrical and Mechanical Characteristics

How to Use It in Amateur Equipment

BY HERBERT S. RIDDLE,* WIDSK

POLYSTYRENE is a transparent solid dielectric, formed by the thermal polymerization of monomeric styrene, $C_6H_5CH:CH_2$. This first sentence disposes neatly of the chemical side, and from here on we can interest ourselves only in the physical and electrical properties of polystyrene, and its application in amateur transmitters.

Several years ago, in Europe, rapid strides were made in the molding of small electrical parts from polystyrene materials, and it was not long before a few of the radio parts manufacturers in this country were doing the same. The polystyrene material was imported from England in the form of crystals or coarse powder, and compression-molded to the required shapes. The pieces produced by this method were very expensive because the cost of the polystyrene crystals or powder produced abroad was between two and three dollars per pound, plus duty. This imported material had other disadvantages aside from high cost, such as a very low softening point, lack of clarity, and instability when exposed to sunlight. The United States is now foremost in the development and use of new plastic materials, and a domestic polystyrene is now produced

* Monsanto Chemical Company, Plastics Div., Springfield, Mass.

which has electrical properties equal to those of fused quartz, excellent water resistance and dimensional stability up to $184^\circ F$.

The electrical qualities vary little with frequency, as shown in the following table:

Frequency Cycles/sec	Power Factor Per Cent	Dielectric Constant	Loss Factor
60	0.02	2.55	0.0005
50,000	0.022	2.58	0.0006
20,000,000	0.028	2.6	0.0007
200,000,000	0.04	2.65	0.0009

These extremely low-loss characteristics, comparable only to fused quartz, are maintained even under very adverse moisture conditions; tests show 0.00 per cent water absorption after 48 hours immersion, and 0.05 per cent after over 300 hours immersion. The dielectric strength is about 500 volts per 0.001 inch, in thicknesses of $\frac{1}{8}$ inch.

In appearance polystyrene resembles glass, being a very light (specific gravity 1.05), non-inflammable transparent solid, the usual form being sheets, rods or tubes, with polished surfaces. The clarity of this material is so great that news print may be read through a solid polystyrene rod 24 inches long. The material also sounds like glass when dropped or thrown upon a hard surface, but polystyrene differs from glass in that it does not break.

With a little care, no difficulty will be experienced in fabricating the material to any shape; however, it may be well to outline a few general rules to follow when working it:

Sawing — Strips or sheets are easily sawed to size with a regular hack saw, backing up the polystyrene with a piece of board to prevent burring of the cut edges. The sheet may be scribed with a sharp point as a guide to sawing. The sheets cannot be cracked off in a straight line by scribing one or both sides as with glass. The sawing must be done at a reasonably slow speed so that the saw blade will not become hot and cause softening of the material, and consequent sticking of the saw.

Drilling — Care must be exercised in center punching, because a heavy blow with a center punch may cause a small "star" fracture. The drilling should be at slow speed to avoid heating of the drill and softening of the material. Polystyrene drills as readily as bakelite.

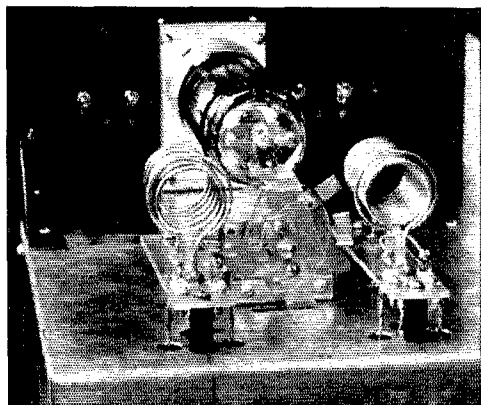

An example of how polystyrene can be worked. The switch shown here was constructed by the author from sheet material. Note how the upper part of the stationary member is bent over to form a support and terminal for the plate cap of the tube.

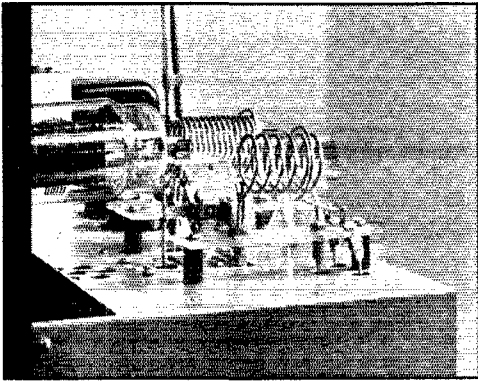

A good way to make a link mounting. Polystyrene is easily cemented.

Tapping—No difficulty is experienced in tapping, using a hand wrench.

Turning—As with sawing and drilling, cutting must be done at slow speed to avoid heating of tool and material.

Polishing—Sawed edges may be finished with a file and then buffed to regain the glass-like surface. The buffing must be done very lightly.

Bending—Polystyrene may be bent or formed into various shapes, but must be heated to over 200° F. In the case of smaller strips to be bent into angles, this may be done by holding that portion of the strip to be bent about one-quarter inch from the soldering iron until the material has softened. The strip may be readily bent to the desired shape, and sets immediately, the bent portion being fully as strong as the original sheet. Larger sheets may be bent to different shapes by inverting the family flat iron, covering it with several layers of cloth and placing the polystyrene sheet on the cloth. A pair of heavy cotton gloves is of great help in handling the hot sheet.

Cementing—The material may be readily cemented to itself by the use of toluol, a solvent for polystyrene. The best procedure is to clamp the two pieces to be cemented in the proper position and apply toluol to the joint. The toluol will run into the joint, dissolve the material to

provide a bond and then dissipate, leaving a strong joint. A joint thus made may be handled in just a few minutes but does not obtain its full strength for several hours.

Heat—No difficulty has been experienced from tube or inductance heat in actual operation. Care should be taken, however, about soldering the lugs or other hardware in direct contact with the polystyrene, since the high temperature will cause temporary softening of the material under the lug.

The greatest need for a good dielectric is in the tank circuits of our transmitters. In the writer's transmitter, polystyrene was substituted for condenser strips and coil mounting strips of other material, which had actually swelled and bubbled up to almost twice its thickness because of heat developed by the power leaking through it. Several other transmitters have been changed over to polystyrene insulation in the final tank circuit, and the increased efficiency and output have been surprising. In one case substitution of polystyrene for a bakelite type insulation on the tank condenser, tank coil and neutralizing condenser of a 14-Mc. 'phone transmitter resulted in a power output increase of 40 per cent. No other changes were made in the circuit or input.

Polystyrene material is very adaptable to the construction of coil supports and switches, condenser strips, and similar insulators for medium- and high-power amplifier stages. The photograph shows the plate cap support and plate lead switch of the 100-watt output buffer in the writer's transmitter, switching pre-tuned 14-Mc. and 28-Mc. tanks. This stage may be switched when in operation.

This article is in no sense a technical treatise on all the characteristics of polystyrene. The coincidence that the writer is both an amateur and connected with a chemical company specializing in the field of plastics gave us the opportunity to try this material in our own outfit and those of a few friends. The results obtained, plus the fact that polystyrene is bound to find increasing use as a radio insulator, particularly for use at ultra-high frequencies, justified an article summarizing the electrical characteristics of this material and the methods of using it.

Strays

On June 5th, I received a QSL from VK2EO in the morning, played tennis with VE5EO in the afternoon and QSO'd W4EO in the evening.

— VE4EO

Polystyrene is an insulating material known by various trade names, the most familiar of which is "victrol." The acknowledged leader in point of low losses, its mechanical properties are such as to make it ideal for some applications, unsuitable in others. Recent developments in manufacture have raised the softening point and lowered the cost to an extent which will encourage its wider use in amateur equipment.

**SWITCH
TO SAFETY!**



"5 and 10" From Shack or Car

Dual-Purpose Equipment with Better Mobile Performance

BY S. GORDON TAYLOR,* W2JCR

THERE are many hams who, having sampled the pleasures of portable-mobile operation in the days of the 5-meter modulated oscillator, once again feel the urge to indulge this hobby. Because of the new F.C.C. regulations of the past winter, however, the old rig is in the junk heap and they are faced with the necessity of starting again from scratch in providing themselves with legally stable equipment.

There is no getting away from the fact that this type of operation now falls more definitely in the luxury class, requiring more tubes and therefore involving more power. Moreover, considering the cost there are many who feel that the investment is not warranted if they are going to wind up with perhaps only a couple of watts into the car antenna. The answer for them seems to lie either in giving up the portable-mobile idea entirely, or else going into it in a way that will provide enough flexibility and enough advantage to justify the use of higher power — perhaps comparable with that of the average home rig on five.

This latter can be achieved, for instance, by building the rig to cover both 5 and 10 meters, and making it equally suitable for home or car use. This plan seems worthy of consideration, especially for the hams who have been off "five"

* Consultant, 145 West 188th St., New York, N. Y.

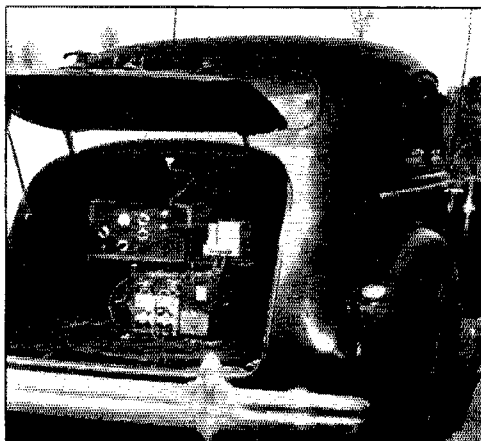

The rig described here as permanently installed in W1KTF's car, complete with separate battery, 60-watt vibrator supply, relays, fused switches, etc. The battery is just behind the control panel to keep the 6-volt supply leads short. All 6-volt switching is by relays controlled from the dash.

since their modulated oscillators were banned, or those who have been operating other bands but would like to try a fling at five and ten.

Power Supply

In the matter of power, the main problem is that of supply for car operation, and this must of necessity be the governing factor. Otherwise there is little difference in cost between a rig which puts 2 watts into the antenna and one putting out several times this power, assuming crystal control in both cases. Fortunately, most modern cars provide a husky charging rate, much higher than the normal requirements for lights, starter and horn. If the car is driven a fair bit, therefore, the battery will usually boast a surplus. Whether or not this will be sufficient to take care of a transmitter of moderate power is a matter that will vary with the individual owner, and is one which he will have to figure out for himself.

As for supply equipment, a new vibrator pack just placed on the market¹ provides 60 watts of high-voltage plate supply with a switch-selected choice of 600 volts at 100 ma., 450 volts at 120 ma., 300 volts at 200 ma. or 225 volts at 200 ma. In either of these last two positions this unit supplies practical power for a very respectable rig, allowing up to 30 watts or thereabouts into the r.f. final with enough left over for the exciter and modulator stages. The battery drain of such a unit ranges approximately from 8 to 19 amperes, depending on the voltage tap used and the amount of power drawn by the transmitter. Add to this a drain of probably two or three amperes for the transmitter filaments plus whatever is required by the receiver filaments, and the total is easily found.

In estimating battery drain, it should be borne in mind that the transmitter is in operation during only a relatively small part of the time; also, that the lowest voltage tap will probably provide enough power if battery economy is important. On the other hand, the receiver is on the air when the transmitter isn't, so there will be some plate drain throughout the operating period, assuming the battery supplies both receiver and transmitter.

If the estimated drain is more than the car battery and charging generator can logically stand, the difficulty can be overcome in two ways. Either use a separate storage battery for the rig, with provision for overnight charging in the home

¹ Radiart Vipower Model 4202.

The Transmitter

Since the new regulations, the cost of a mobile 5-meter rig admittedly is higher. Acceptance of that fact, plus some new equipment, leads to a different angle on mobile operation.

garage, or provide means for giving the car battery an occasional booster charge as needed. If there is an old charger around from the pre-a.c. era of radio, so much the better.

An important and novel feature of this Radiart unit is that it has terminals for operation from the a.c. line and therefore will also serve as the power supply for the rig when operating in the shack or when operating portable in a location where an a.c. light line is available. It therefore lends itself admirably to this idea of a dual rôle. Operating from a.c., the vibrators are slipped out of their sockets and a special 115-volt winding on the transformer primary is utilized, providing slightly higher outputs than those obtained in battery operation.

For the transmitter portion of such a medium power installation, the circuit shown in Fig. 1 is one which has aroused considerable local interest. It was designed and built by Glenn Pickett, W2IDV, and incorporates some features suggested by Art Haynes, W2JHV. Duplicates built by W2IDV are already in portable-mobile use by W1KTF and W2KKT and in the home shack of W2JHV, and all of them are receiving extremely favorable reports on quality, stability and signal strength. It speaks well for the rig that W1KTF was able to get an S8-plus report from a station 60 miles away when operating from the car near his home in Stamford, Connecticut.

To avoid the use of more than one exciter stage, and to concentrate as much power as possible in the final and modulator, a 20-meter crystal is employed in an 89 Tri-tet circuit. There are those who frown on the 89 for this purpose but Pickett found after trying a flock of other tubes, that the 89 provided the greatest freedom from drift, parasites and the other faults to which these high-frequency crystals and circuits seem to be

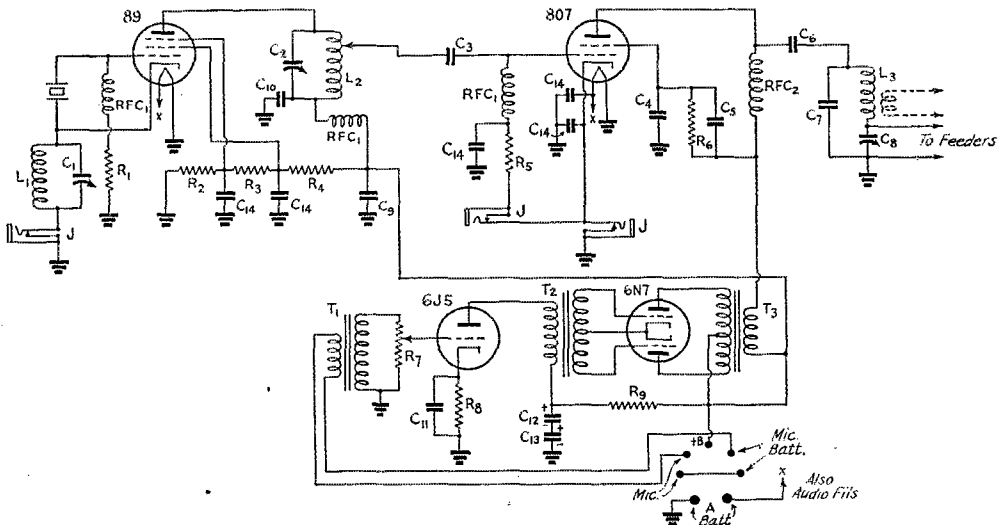

Fig. 1—The transmitter circuit.

- L₁—8½ turns No. 14 enamelled, close-wound, inside diameter 1 inch.
- L₂—8 turns No. 14 enam., double-spaced, inside diameter 1 inch, tapped 2½ turns from plate end.
- L₃—28 Mc.: 12 turns No. 12 enam., inside diameter 1 inch.

- C₁—75- μ fd. variable (National UM-75).
- C₂—30- μ fd. variable (National UM-35).
- C₃—50- μ fd. mica.
- C₄, C₅—0.002- μ fd. mica, 400-volt.
- C₆—0.002- μ fd. mica, 1000-volt.
- C₇—25- μ fd. variable (National U/MA-25).

- C₈—100- μ fd. variable (National UM-100).
- C₉, C₁₀—0.01- μ fd. paper, 600-volt.
- C₁₁—10- μ fd. 25-volt electrolytic.
- C₁₂, C₁₃—4- μ fd., 450-volt electrolytic.
- C₁₄—0.01- μ fd., 400-volt paper.
- R₁—50,000 ohms, 1-watt.

- R₂—10,000 ohms, 1-watt.
- R₃, R₄—25,000 ohms, 1-watt.
- R₅—50,000 ohms, 1-watt.
- R₆—15,000 ohms, 2-watt.
- R₇—0.5-megohm potentiometer.
- R₈—1000 ohms, 1-watt.
- R₉—5000 ohms, 1-watt.

- T₁—Single-button microphone transformer (UTC-S6).
- T₂—Class-B input, 6J5 to 6N7 grids (UTC-S8).
- T₃—Class-B output, 6N7 to load, tapped (UTC-S18).
- J—Closed circuit jack.

heir. Moreover, the 89 is not critical as to crystals and provides more than enough drive even when doubling in the 807 final, although not quite enough to permit the use of a 40-meter crystal for 5-meter operation.

One reason for the success of the 89 in this Tri-tet application is the careful selection of voltages for the suppressor and screen. Those employed are 50 and 150 respectively, both obtained through a voltage divider network as shown in Fig. 1. Plate voltage, on the other hand, is not at all critical so far as the oscillator characteristics are concerned, although it does affect output. The L/C ratios follow conventional Tri-tet practice, with plenty of tuning capacity in the cathode circuit and little in the plate.

The 89 doubles to ten meters, with the 807 working straight through for 10-meter operation and doubling for 5-meter service. For those who question the efficiency of doubling in the final it is an interesting fact that actual measurements, working the 807 into a non-inductive load, show the 5-meter output to be only 20 per cent less than when working straight through on 10 meters. The actual figures were 15 watts on 10 and 12 watts on 5; both with 28 watts into the 807.

The antenna matching network arrangement is one of W2JHV's contributions and is ideally suited for mobile work, where antenna and feeder values can be almost anything — and usually are. Twisted pair, spaced pair, concentric line or single feeder — this matching network takes them all in stride. Simply by varying the capacity of C_8 , anything from a few ohms up to several hundred can be accurately matched.

The Class-B modulator using a 6N7 represents just about the most economical arrangement possible for full carrier modulation. The input and output transformers are tapped to provide wide leeway for matching. The 6J5 fully drives the 6N7 when fed from a single-button carbon mike at normal voice level. Static plate-current drain for the entire audio system is between 35 and 45

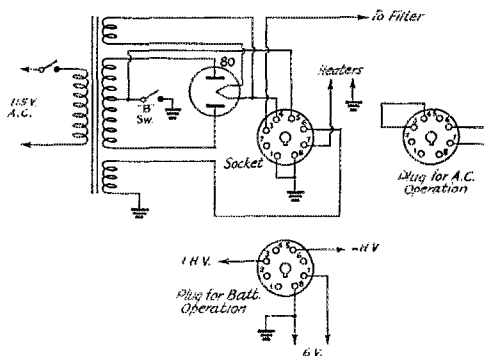

Fig. 2 — The plug system used for changing from a.c. to battery power supply in the Hallicrafters "5-10" receiver. A vibrator supply using tube rectification is necessary if the receiver "B" switch is to be operative, since packs using synchronous vibrators have the negative "B" grounded internally.

ma., depending on voltage. Peak current is between 50 and 70 ma.

All connections for filament and plate supply, as well as for the microphone and microphone battery, are provided in a single plug socket mounted on the rear of the chassis. The transmitter is small enough to mount in a 14- by 8- by 7-inch Par-met cabinet as shown in the photographs. A meter on the front panel, with jacks in the oscillator and 807 cathodes and the 807 grid circuit, provide for all necessary measurements when tuning up the rig. Filament and plate switches could have been included in the transmitter but were omitted in favor of remote switching from the car dash (or operating table).

Receiver Equipment

In the matter of receiving equipment this same idea of home and mobile service is possible and the choice is no longer limited to the superregenerative "rush-box." In fact its inadequate selectivity rules this receiver out if 10-meter operation is contemplated. Even on five meters the superior selectivity and sensitivity, the effective noise limiter and a.v.c. systems, the band-switching and band-spreading of a well-designed u.h.f. superhet offer advantages which, in the opinion of many hams, more than offset the lower cost and smaller size of the "rush-box." This is particularly true if the superhet is designed to operate both from the a.c. line or car battery, a feature introduced to the ham in the Hallicrafters "510" Sky rider.

Fig. 2 shows the simple arrangement employed in this receiver to permit almost instantaneous changeover from battery to line operation. The filament and high-voltage supply leads from the

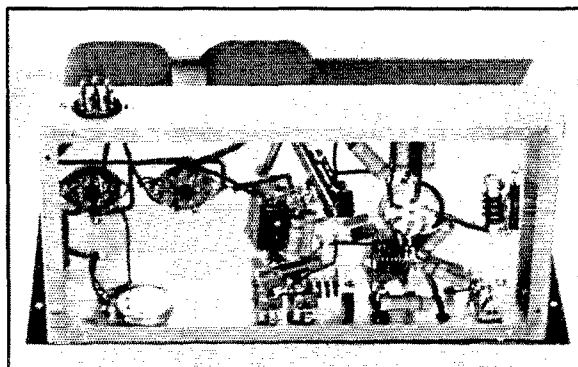

Bottom view of the transmitter. Power, mike and mike battery connect through plug at the left.

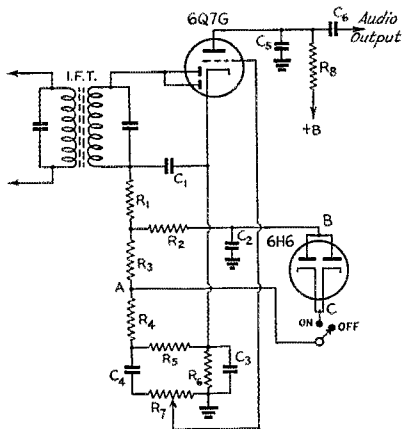

Fig. 3 — The second detector circuit with the Dickert noise limiter used in the "5-10." Its operation is described in the text. Values are as follows:

- | | |
|---|---------------------------------|
| R ₁ — 20,000 ohms. | R ₈ — 0.1 megohm. |
| R ₂ — 1 megohm. | C ₁ — 100 μ fd. |
| R ₃ — 0.1 megohm. | C ₂ — 0.05 μ fd. |
| R ₄ — 0.1 megohm. | C ₃ — 0.1 μ fd. |
| R ₅ — 0.25 megohm. | C ₄ — 0.02 μ fd. |
| R ₆ — 300 ohms. | C ₅ — 100 μ fd. |
| R ₇ — 0.5-megohm volume control. | C ₆ — 0.05 μ fd. |

R₆ and C₃ are the usual cathode resistor and by-pass for the audio amplifier; C₄ and R₇ the audio input coupling elements; C₅, R₈ and C₆ form the conventional audio output circuit. These values may be changed to suit the particular duo-diode-triode tube used.

built-in a.c. power supply terminate in the socket, which is mounted on the outside rear of the chassis, and are connected to the receiver circuit only when the a.c. plug is inserted in this socket. For car operation, the battery plug provides all operating power from the car battery and external vibrator unit. A separate vibrator supply (one of the 300-volt, 100-ma. type) may be used, but the car transmitter supply will also serve this purpose, assuming its output voltage approximates 300 volts.

The noise limiter system (which is of course essential in any superheterodyne used for mobile operation) of this same receiver consists of the 6H6 diode shown at the right in Fig. 3 and its associated resistor and condenser, R₂ and C₂. This system is fully automatic, adjusting itself to the signal level and chopping off noise peaks above this level. Its operation is briefly as follows.

With a signal carrier present a voltage is built up across the detector diode load. This makes the 6H6 diode plates negative with respect to its cathode by the amount of the voltage developed across R₃. With a sudden noise impulse of greater amplitude than the signal the detector load voltage increases, but because of the time lag in R₃C₂, this change is not immediately transmitted to the diode plates. Point A of the load therefore becomes momentarily more negative than point B, allowing current to flow through the diode and shorting point A to ground through C₂, thus effectively killing the audio for a tiny fraction of a second. At the expiration of this time interval circuit conditions again become normal.

This arrangement is highly effective in killing ignition and other noise made up of spaced impulses. It is not, however, effective on continuous noise because with this type the 6H6 plates are held continuously negative with respect to the cathode just as would be the case with a normal signal.

The ratio of the resistance of R₃ to the balance of the resistance in the diode load circuit determines the level above which peaks are cut. This could be set to cut only the peaks which exceeded those representing 100 per cent modulation of the signal. However, a far better speech-to-noise ratio is obtained by adjusting the resistor values to cut all peaks above about 60 or 70 per cent. This sacrifices some speech output, but the speech energy contained in peaks rising above this level is only a small fraction of the total speech whereas a great deal of the troublesome noise energy lies in this range from 60 to 100 per

◆
 Inside the 5-10-meter transmitter. The 89 at the right doubles from a 20-meter crystal, driving the 807 as a doubler on five or straight through on ten. The 6J5-6N7 Class-B modulator at the left provides plenty of push from a carbon mike, even with 30 watts into the 807.
 ◆

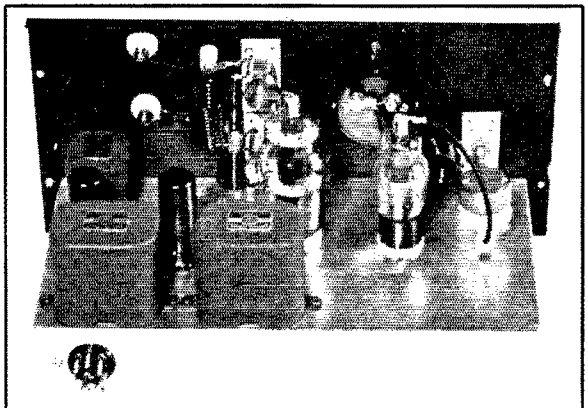

cent modulation. The practical result is that speech level is reduced just perceptibly while troublesome noise is reduced in far greater proportion.

It may be felt that the equipment discussed in this article leans too strongly toward the de luxe variety to be practical for the average ham for occasional or even frequent portable-mobile operations, and such a feeling is quite justified. But for the ham who wants results more or less comparable with those obtained from a home rig, such equipment solves the problem. The transmitter described is entirely practical for any type of mobile operation, however, because where battery economy is important it can be operated from a smaller vibrator or generator such as the 300-volt, 100-ma. units in common use. This will provide 10 to 12 watts into the 807 with sufficient left over for the other tubes. Or the HY60 can be substituted for the 807 for low-power operation to gain the advantage of its lower filament drain.

In connection with this question of power, it should be remembered that 12 watts into the final of a crystal-controlled rig is equal to several times that power into a modulated oscillator, because it is concentrated on a single frequency instead of being spread over a band perhaps 200 kc. wide. This is particularly true where the receiver at the other end is a superhet with good selectivity.

Central Division Convention

**Columbus, Ohio, September
8th-9th-10th**

A CORDIAL invitation is extended to all amateurs to attend the 1939 Central Division A.R.R.L. Convention and Trade Show, sponsored by the Columbus Amateur Radio Association, to be held at the Deshler-Wallick Hotel, Columbus, Ohio, September 8th, 9th and 10th. Those amateurs who have attended former conventions and hamfests know that Columbus has always put on a good show.

A program has been prepared which surpasses all previous efforts, and arranged to please everybody. All the speakers will be outstanding in their field; the Trade Show will be one of the highlights of the convention. A code speed contest, a banquet on Saturday evening with a full hour of high-class floor-show entertainment. A large list of prizes is assured, and a good prize for the ham coming from the greatest distance.

Be sure to bring the YL, XYL and OW as the committee has arranged a very fine program for them, also a large list of prizes for them. The registration fee is \$3.00; ladies \$2.50. All tables at the banquet will be reserved. Those desiring tables reserved and additional information should write the general chairman, J. M. Bayes, W8BZY, 371 Olentangy Street, Columbus, Ohio.

Henry Edward Benner, W6NVE

HENRY BENNER met death by electrocution last June 18th.

His death points anew the lesson borne by the A.R.R.L. Safety Campaign. It was the result of carelessness such as has been only too common amateur practice in the past. It offers still another horrifying demonstration of the lethal power that exists in any amateur station.

The details of Henry Benner's death have been reconstructed from newspaper accounts and a report by a close friend, whose identity is withheld by request.

At about 1 P.M. on Sunday, the 18th, he was in his upstairs radio room working 160-meter 'phone. The station was so arranged that the transmitter stood in back of the operator while he was seated at the operating position. It is understood that there was no ordinary send-receive switch on the operating table; instead, in order to send, the operator had to switch off the receiver and then turn on the transmitter by means of a key located on a small table beside the transmitter, at his back.

It happened that the regular plate power transformer had burned out, and a temporary replacement had been provided in the form of a 1-kw. "pole pig" which supplied 1800 volts to the pair of 35T's. This transformer being too large to fit inside the rack, it had been placed on the small table holding the key. Temporary leads running near the key connected the transformer to the rectifier-filter system behind the panel.

At the moment of the fatality, it is believed that Benner was preparing to make a call. Holding the grounded stand of the double-button carbon microphone in his right hand, with the other he reached behind him to turn on the transmitter. After closing the key, in bringing his hand back it touched one of the exposed high-voltage leads to the transformer. Both hands were burned; the grounded microphone completed the return circuit for 2200 volts. His body crashed to the floor. . . .

Downstairs his wife heard the fall. Rushing upstairs, she found him lying on the floor, the microphone near by. Realizing the danger, Mrs. Benner nevertheless pulled her husband's body to a safe distance by his trousers leg. The transmitter was still alive. Neighbors, answering her summons, with difficulty succeeded in disconnecting the transmitter from the line.

Death was instantaneous, according to the coroner.

W6NVE was well known in amateur circles on the Coast, having operated a powerful 160- and 20-meter 'phone for a number of years. A native

(Continued on page 76)

HOW WOULD YOU DO IT?



KINKS IN FEEDING ROTATABLE ANTENNAS FOR CONTINUOUS ROTATION

IN PROBLEM No. 27, Our Hero was in search of some new ideas in feeding rotatable antennas which would permit continuous rotation. While entirely new ideas failed to develop, nevertheless several worth-while kinks were uncovered which will be welcomed by anyone contemplating a rotatable job. These little details usually cause the most head-scratching. Let's take a look at some of them.

Robert Murray of Long Island City, N. Y., who has given Our Hero many a lift in the past,

W3GHW of Philadelphia avoids the use of any form of sliding contact by mounting a feeder tuning unit on the rotating pole and link-coupling the antenna tank circuit to the transmission line as shown in Fig. 2. Series or parallel tuning will be used depending upon the length of the feeders between the antenna tuning unit and the antenna. The link winding is held in place by supports extended from the ground or a stationary platform. It would seem that the practicability of winding the coils about the pole would be limited to

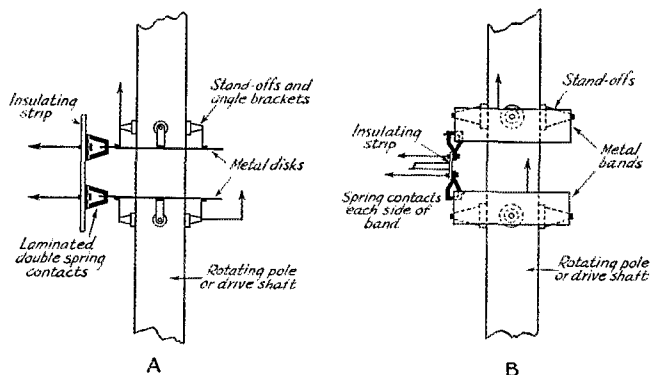
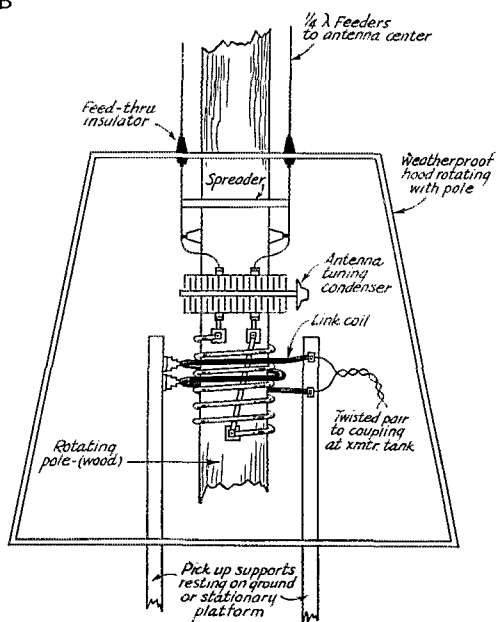

Fig. 1 — New ideas in sliding contacts for rotatable antenna feeder connection to permit continuous rotation. The broad surfaces take care of any wobble in rotating mast or driving shaft.

and Winfred Lowe of New Brunswick, N. J., say that it's often hard to avoid wobble in a rotating shaft carrying sliding contacts for feeder connections between the stationary and moving portions of the antenna structure, particularly if the entire mast rotates. The slip-rings and brushes commonly used do not always give satisfactory contact. To overcome this, Mr. Lowe suggests the use of relatively wide disks as the movable contacts which are pinched between pairs of sliding spring contacts as shown in Fig. 1A. Good contact is provided in spite of reasonable wobble in any direction. Mr. Murray's idea, shown at B, is essentially the same except that his movable contacts are in the form of wide metal bands with the edges in a vertical plane. He claims that vertical surfaces are less susceptible to accumulations of ice or dirt. The stationary contacts may be made up in the form of laminations of phosphor-bronze strips. Mr. Murray suggests that spring battery clips would make good contacts if the points of the teeth are filed down.

Fig. 2 — One method of transmission line — antenna system coupling which eliminates sliding contacts. The low-impedance line is link-coupled to a short tuned line.



wooden poles of small diameter. The sheltering hood is fastened to the pole so that it rotates with the pole. Feed-through insulators are fitted in the top of the hood for the feeders and any space between the hood and the pole should be plugged to make the hood water-tight on top.

W9AYH of Louisville has the most complete solution submitted in the contest, the chief disadvantage being that the idea is applicable to vertical antenna elements only. The antenna-system arrangement is quite similar to that described by W2BSF and W2AJF in *QST* for March 1938, and is shown in Fig. 3. The antenna remains stationary while the reflector and director rotate about it. Thus, the problem of making contact between a stationary line and a rotating antenna does not exist. The novel feature of the design by W9AYH is that the pole itself is of metal pipe and a portion of it is made to serve as the antenna. A one-quarter wavelength "J" matching section is fastened to the pipe three-quarters of a wavelength down from the top; the first half wavelength from the top forms the antenna. Since the bottom of the "J" section is at ground potential, the fact that the pipe mast is set in the ground makes no difference. In fact, good lightning protection is automatically provided. The top end of the "J" section is fastened to the mast with a stand-off insulator to provide rigidity. The "J" section may be fed with a 600-ohm open line or a low-impedance cable and adjusted until standing waves disappear from the line.

The rotating director and reflector are sup-

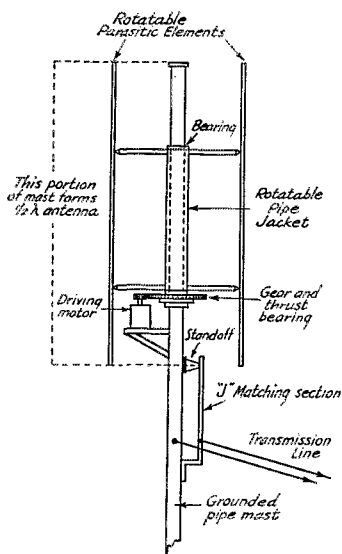

Fig. 3—A vertical system in which a portion of the grounded pipe mast forms the stationary antenna, eliminating the necessity for feeding a movable antenna element. The director and reflector rotate about the antenna.

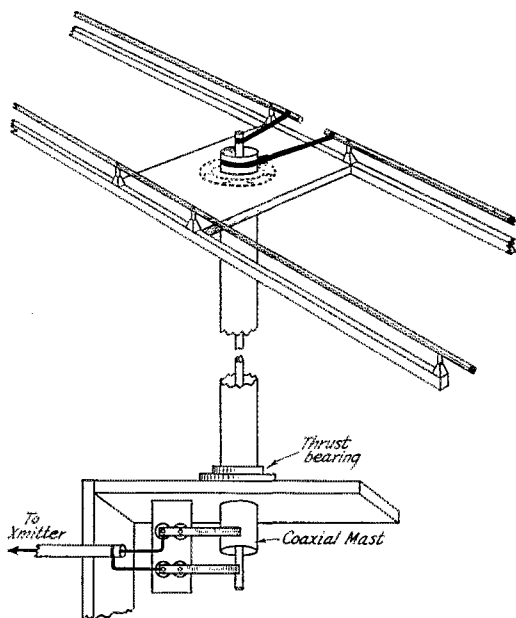

Fig. 4—In this scheme, the rotating pipe mast is used as the outer conductor of a concentric transmission line or matching section.

ported by arms fastened to a section of larger-diameter pipe which slides over the mast and is set in bearings at top and bottom.

Henry Riesmeyer of New Kensington, Pa., has an idea which doesn't solve the problem of contact between stationary and rotating members, but it has interesting possibilities in feeding the low-impedance antenna. A section (or more than one section) of pipe serves as the rotating mast and also as the outer conductor of a concentric transmission line or matching section. A rough idea of the construction is shown in Fig. 4. A second pipe or section of tubing inside the first completes the concentric line. Any type of sliding contact could be used at the base.

If the section is used as a 72-ohm line, it may be of any length and the ratio of inside diameter of outer conductor to outside diameter of inner conductor should be 3.32 to 1. A diameter ratio of 3 to 1 will produce a 66-ohm line. In the case of either, some matching arrangement will be required between the line and the antenna. This may consist of a tuned tank circuit with two links, one to the line and the other to the center of the antenna.

A similar arrangement may be used as a matching section, providing that the pipes are cut to one-quarter wavelength or some odd multiple of one-quarter wavelength. In this case, the top end of the matching section may be connected directly at the center of the antenna. Assuming an antenna impedance of 15 ohms for a two-element

system and a 72-ohm transmission line between transmitter and the lower end of the matching section, the ratio of diameters should be 1.72 to 1. If the impedance at the center of a three-element antenna system is 7 ohms and a 72-ohm transmission line is used, the ratio should be 1.46 to 1. If a 600-ohm line is used instead of the 72-ohm line, the ratios should be 4.87 and 2.95 to 1 respectively for antenna impedances of 15 and 7 ohms. The problem of support and insulation of the central conductor should not be insurmountable. In all probability, a short tower support, fitted with a bearing, would be necessary.

Prize Winners

First Prize — DeAlva C. Summerford, W9AYH, Louisville, Ky.

Second Prize — A. Henry Ricsmeyer, ex-W8CHT, New Kensington, Pa.

In addition to those mentioned previously, we wish to thank the following for their contributions: W1ALJ, W5FCR, W9OMA, Ernest Kopulos, Wymond Martin and E. C. Sherman.

Maritime Division Convention

Moncton, N. B., September 2nd, 3rd, 4th

ALL OM's, XYL's, Youngsquirts, Lids and Windbags, are requested to keep September 2nd, 3rd and 4th open and prepared for a big hamfest in connection with the official Maritime Division Convention to be held under the auspices of the Moncton Amateur Radio Club at Moncton, N. B., Canada. Further information may be obtained from G. E. Brown, VEIRC, Secretary, 32 St. George St., Moncton, N. B.

West Gulf Division Convention

Wichita Falls, Texas, September 8th and 9th

A SUPER-STREAMLINED program is slated for the thirteenth annual West Gulf Division Convention to be held under the auspices of the Wichita Falls Amateur Radio Club at the Marchman Hotel, Wichita Falls, Texas, September 8th and 9th. The rapid-fire program will commence with registration Friday, until noon, at the Marchman Hotel. At one p.m. the gang will leave in convoy to visit many local interesting points, ending with a sumptuous barbecue with all trimmings. "Jitter-bugs," "rug-cutters," "alligators" and the like will have their fling Friday night at the dance. You can't miss the jamboree.

The convention activities proper will begin Saturday at the Municipal Auditorium and will consist of many interesting talks, movies, etc. A midnight conclave of the Royal Order of the Wouff Hong is being arranged.

If you want more information drop a note to Champ Smith, W5AAM, Secretary, Box 21, Wichita Falls, Texas.

Wisconsin State Convention

(Central Division)

Wausau, Wis., September 2nd-3rd

FOR the first time an official A.R.R.L. Wisconsin-Upper Michigan Amateur Radio State Convention will be held under the auspices of the Wisconsin Valley Radio Association, at Wausau, Wis., September 2nd and 3rd.

Activities will begin with registration from ten to twelve o'clock noon Saturday and will wind up with a banquet and prize drawing Sunday evening. One of the high lights of the convention will be the open-air session Sunday morning on the highest point in the state, Rib Mountain. Transportation will be furnished and a feature of this session will be demonstration of types of emergency equipment. The Saturday night party will be at the Hotel Wausau Ballroom and will feature moving-pictures, music, dancing and refreshments. An open forum will be conducted by Director R. H. G. Mathews on Sunday afternoon. An interesting equipment exhibit will be held in conjunction with the convention. 'Phone and c.w. transmitters will be on the air and if you wish to operate bring your ticket.

REMEMBER! This convention is planned for your family so bring all members.

For further particulars write W9ZTO, Box 432, Wausau, Wis.



DIXIE JONES' OWL JUICE

THERE is a species of insect operatin' ham rigs in this here Army Amateur Ham System, and maybe elsewhere, which oughto be mashed underfoot and deprived of their lowly lives. For instance, I'm a-workin' my usual mess of ham skeds and I'm about four jumps behind myself and I got six guys standin' by waitin' to be cleared, and I call this nit and he chirps right back and I bust loose with a message and what does he do but open the key on me and say "wait a minnit 'till I git some paper," or "wait a minnit 'till I git a pencil," or just plain "wait a minnit." Doggone such folks anyhow. They had all day yesterday and all day to-day up to then to git their stuff together, but they mess around twiddlin' their digits and don't do it 'till they git on my time. I wouldst commit mayhem upon the person of such weevils.

— W4IR of the Dixie "Squinch Owl"

U.H.F. Activity at Summertime Peak

56-Mc. DX Continues—112-Mc. Interest Increasing

THE 56-Mc. band put on a good DX show again this year. Conditions provided for good contacts on at least 17 days during May and 18 days during June, on which we have received reports. It is likely that unreported work will account for even more days. From mid-May to mid-June things were at their best. In late June conditions became "spotty." The last report received at this writing is from W5AJG, covering several W8 contacts on June 27th. The following reports, by dates, constitute supplements to the work recounted in July *QST* (page 52), and summaries of new work not previously mentioned. It is interesting to note that low power holds its own well on 56-Mc. Many stations with good DX records use but moderate input. Additional reports, as things happen, will be much appreciated. Please give times of contacts or reception as well as dates, and, if possible, distances covered.

May 3d: W6QLZ, Phoenix, Ariz., heard W6QDU, Oakland, Calif. QDU was using only 3 watts. QLZ reports the band open on April 29th, 8 to 9 P.M. MST, May 3d, 8 to 9 P.M., and May 16th, 6 to 7 P.M., but no contacts made. **May 6th:** W7GBI, Great Falls, Mont., worked W6DNS, San Diego, Calif., at 10:25 P.M. MST GBI heard about fifteen W6 'phones this night. **May 15th:** In addition to the work already reported for this date, W3RL, Herndon, Va., worked W9WDA, Duluth, Minn., at 7:43 P.M. EST and W9GGH, Kenosha, Wis., at 8:06 P.M.; heard W9WWH, Racine, Wis., at 7:57 P.M. W3RL runs 250 watts to P.P. 35T's, crystal controlled on 56,826 kc. An 8-element rotary beam and an 11-tube super complete the layout. W3HJQ, Washington, D. C., worked W9WDA and W9ZUL, heard W9ANA. Input at W3HJQ is 100 watts, receiver is homemade 11-tube super, antenna two half waves in phase in vertical plane. **May 16th:** W3RL worked W4DRZ, Ft. Lauderdale, Fla., 7:35 P.M. EST and W4FBH, Decatur, Ga., 7:41 P.M.; heard W4EDD at 7:08 P.M. W3HJQ worked W4DRZ, heard W4EDD and W4FBH. W3FX, Philadelphia, worked W4EDD, Miami, Fla., 5:45 P.M. EST and W4FBH, 7:25 P.M. W3FX runs 20 watts or less to an RK34 final on 58.58 Mc. Antenna is a vertical "J," receiver a converter feeding an SW3. W8JLQ, Holland, Ohio, reports hearing W8CJM, in the 100-200 mile range. Even this is good 56-Mc. DX in his area, says JLQ. **May 17th:** W6IOJ, North Hollywood, Calif., worked W7AMX, Portland, Ore., W7AVO, Portland, W7AQJ, Vancouver, Wash., and W7FDJ,

Houlton, Ore. W6IOJ has 200 watts on 56,636 kc. and a 10-tube super for reception. Antenna: 6 half waves in phase, horizontal. **May 25th:** W8JLQ logged a good lot of 100-200 mile signals: W8CIR CJM NYD MDA OXS VO JAH SLU BJG NZ. **May 26th:** W3HJQ logged W4EDD. W5ATW, Houston, Texas, heard W4EDD at 7:10 P.M. CST. Receiver at W5ATW is home-made super-regen., transmitter 25 watts, crystal controlled. W8JLQ logged W8MDA, QDU, GU. **May 27th:** W3HJQ logged W4FLH. W9USI, Brookings, S. Dak., worked W8NOR, N. Tonawanda, N. Y., 10:47 A.M. CST and W8RV, Buffalo, N. Y., 10:54 A.M. W9USI is using a new rig consisting of 7-Mc. crystal, 6L6 osc. to 14 Mc., 807 to 28 Mc., pair of 807's to 56 Mc. and pair of 808's final, running at 250-watts input on 56,120 kc. His receiver is a DM36 and RME 69 combination. Antenna is six-element close spaced horizontal rotary, made of electrician's conduit $\frac{1}{2}$ " OD. W5ATW heard W4CLH at 5:30 P.M. CST.

May 28th: W3RL worked W9WDA at 11:36 A.M. EST, heard W9USI at 11:20 A.M. W9WDA, Duluth, Minn., worked W8QFX, Tarentum, Pa., in addition to W3RL. W9USI worked W3AIR, Princeton, N. J. (9:55 A.M. CST), W2CUZ, Yonkers, N. Y. (10:06 A.M.), W2FJB (10:12 A.M.), W2HWX, Oceanport, N. J. (10:15 A.M.), W2IUN, Jamaica, N. Y. (10:25 A.M.) and W1EYM, Fairfield, Conn. (10:30 A.M.). On **May 29th:** W8JLQ logged W8LJP, QDU, CIR and NYD, and on the **30th** he worked W8MDA, Ann Arbor, Mich., at 3:00 P.M. **May 31st:** W3RL worked W9BJV, Watertown, S. Dak., 1:30 P.M. EST, W9USI 1:41 P.M., and W9AZE, Bellingham, Minn., 1:53 P.M. W9BJV has 150 watts on 57,000 kc. W8JLQ heard W8LJP, VO and CVQ. W6IOJ logged W7EMP, Walla Walla, Wash. W9USI made eleven QSO's between 12:42 and 3:00 P.M. CST, with Virginia, New York, Michigan and Ohio. This included three contacts with W3RL and individual contacts with W8NOR, FXM, LZN, OJN, SFF, RV, MMH, and W2CUZ. W3FJ, Richmond, Va., heard W9USI working W3RL at 2:30 P.M. EST. One of the best bits of work on the 31st were W6QLZ's contacts with W7AVO and W7AQJ — the first Arizona — W7 QSO's on 56-Mc. These contacts were between 8 and 8:30 P.M. MST. W6QLZ also heard W7CEC, W7EMP and W7AMX. W6QLZ uses a 28-Mc. crystal and 6J5G-6L6G-35T, 110-watts input. For receiving he uses a Skyrider 5-10 and a 12-tube super-infra.

W6QLZ, Phoenix, Arizona

Clyde Criswell, W6QLZ, established the first Arizona-W7 56-Mc. contacts, with W7AVO and W7AQJ, on May 31st. W6QLZ's 5-meter work during May and June averages about 1025 miles per QSO. The rig consists of 28-Mc. crystal, 6J5G, 6L6G and 35F final running at 110 watts input. Receivers are a Skyrider 5-10 and a homemade 12-tube super-infra. Antenna: Turnstile, 12 feet high.

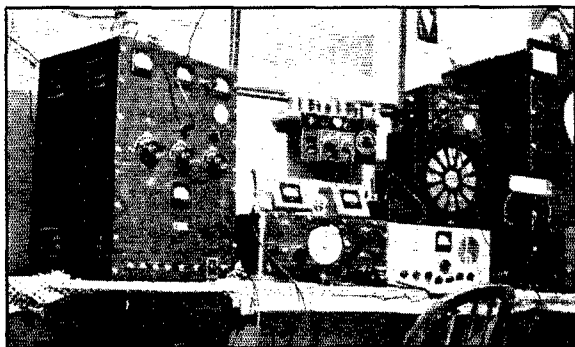

June 1st: W6QLZ worked W5AJG cross-band at 10:00 A.M. MST, QLZ on 28 Mc., AJG on 56 Mc. At 11:55 A.M. W6QLZ had a 100 per cent two-way 56-Mc. contact with W7AMX. W8JLQ logged W8SLU, IUD, VO, LZN and CIR.

June 2d: W5AJG, Dallas, Texas, caught the band open from 8:55 P.M. to midnight CST and worked W8SLU, Auburn Heights, Mich., at 8:55 P.M. and W8QA, Canton, Ohio, at 11:45 P.M. From 10 P.M. to midnight he heard W2JCY, W3ANA, AIR, DBC and BZJ. **June 3d:** W5AJG worked W3CUD, BZJ and RL, the latter for 35 minutes. These contacts were established from about 8:30 to 9:00 A.M. CST. W3FX worked W1KTF, Stamford, Conn., at 7:10 A.M. EST, FX using c.w. June 2d and 3d were active days in the east with W1, W2 and W3 districts working together like locals. W1HDQ, Mt. Wilbraham, Mass., was particularly outstanding, working Virginia, D. C., Delaware, Pennsylvania, etc., with ease. W2LJJ, East Rockaway, N. Y., using Browning preselector as converter for 56 Mc. and HQ120 receiver, with 3.5-Mc. antenna logged the following from 11:30 P.M. on the 3d to 12:30 A.M. EDST on the 4th: W1KTF, W3AIR, W2LUR, BMT, ETN, CUZ, QA, AMJ, JCY, W3BZJ and BYF. **June 4th:** W5ATW logged W8CIL, Sherman, N. Y., at 3:00 P.M. CST. W3HJQ logged W4FLH and W4EDD. W3RL worked W4EDD at 9:23 A.M. EST. W5AJG heard W4CPX, Columbia, S. C., testing with W4EXJ. W2LJJ logged the following from 10:30 A.M. to 1:00 P.M. EDST: W4EDD, W2HYJ, AMJ, LUR, W1KTF. From 1 to 5 P.M. he logged W2CUZ, ETN, KBG, FGB and AMJ, and from 9 to 10:30 P.M. W2KYT, GPO, MO, BGH, BRO, KHR, KNV, WIEER, EYM and KGE. **June 5th:** W5DXB, Vivian, La., worked W4EDD at 8:00 A.M. CST. W3FJ heard W4EDD at 7:00 P.M. EST, working many W8's and W3's. W3HJQ worked W4EDD, heard W4FLH. W3RL worked W4FLH, Miami, at noon EST, heard W4EDD at 9:13 A.M. W5AJG heard W2FGB, New York, for about ten minutes at 2:10 P.M. CST.

June 6th: W6QLZ reports the band open into the W8 and W9 districts on this date at about

8:45 P.M. MST. He heard W9ZJB and W9AHZ of Kansas City, Mo. As W8's and W9's faded rapidly out, East and Southeast Texas came in and W6QLZ contacted W5EEX and W5ATW of Houston, and heard Fort Worth and Brownsville. W5ATW was running 25 watts to a 24. W5EEX was using an HY25 with 20-watts input, and a 3-tube blooper for reception. W6IOJ worked a VE5, and heard W7MB (harmonic) working a G. W5BYV, McCamey, Texas, logged W6IOJ, W6AVR (Colton, Calif.) and W6AVT (Los Angeles) from 11:30 P.M. to midnight CST, with signals S7-9 the entire time. W5BYV's antenna is a 5-element beam, 50 feet high; receiver uses RK1851 r.f., RK1853 r.f., RK1852 mixer and HY615 osc., with usual i.f. and a.f.

June 7th: W5DXB worked the following between 7 and 9 P.M. CST: W3RL, W3AIR, W1HDQ, W8QDU (Detroit), W2MO (Livingston, N. J.), W2AMJ (Bergenfield, N. J.), W1KLJ (New Britain, Conn.) and W2CUZ. W5AJG reported the band open to the west at 10:20 A.M. CST, when he worked W6DNS, San Diego. W5AJG makes the following observation: "The 28-Mc. band doesn't have to be on 400 or 500 mile short skip as it was last year before the 56-Mc. band is open. Long skip can prevail on 28-Mc., but usually the same direction is open on 56. I didn't notice that last year. Seemed that 28 Mc. had to be open for very short skip before 56 was open." From 6 to 9 P.M. CST on the 7th the band opened for some prolonged operation. W5AJG worked the following: W3RL, HDC, EIS, DBC, AIR, HJQ, BZJ, FQS, FVR, HKM, AWM, W8QDU, MST, LKD, VO, CIR, MHM, QA, NYD, IEF, PEJ, W2AMJ and MO. He heard W1EER, W2BW and W8TGJ. W3HJQ heard W5EHM in addition to AJG. W5ATW worked W8CIR (7:20 P.M. CST), W8NYD (8:33 P.M.), W9CBJ (8:55 P.M.) and W9ZHB (11:07 P.M.); heard W8QDU, W9GGH, FEN, AQQ and W1KLJ.

June 8th: W3HJQ worked W9ZHB, Zearing, Ill., and W9ZJB, Kansas City, Mo. W8OKC, Shamokin, Pa., heard W9AHZ and other Kansas City stations between 7 and 8 P.M. EST. W1LLL, Hartford, Conn., worked W9AHZ at 6:30 P.M.

56-Mc. Reports Needed!

FIFTY-SIX MEGACYCLE DX work may be less novel now than it was a year ago, but the need for accurate reports is not a bit less urgent. Ham activities furnish practically the only basis for study of ionosphere behavior in this frequency range, so we have an excellent opportunity to perform a useful service. It requires only a few minutes' time to make out a report giving this essential information:

1. Station heard or worked (specify which) with its location.
2. Date.
3. Time (be sure to specify the time zone and whether daylight-saving or standard time is used).

You don't need to have a transmitter on the air — reception reports are just as valuable as QSO's providing there is no doubt about the accuracy with which call letters are identified. If "doubtful" calls are included, *please so indicate*.

Besides the 56-Mc. data, reports on "short skip" work on 28 and 14 Mc. also can be used to advantage. Include this dope with the 56-Mc. work, but be sure to show plainly the bands to which the reports refer.

Look back through your log and help the work along by listing all the data you have for this year. Reports should be addressed to A.R.R.L., 38 La Salle Road, West Hartford, Conn. We'll take care of getting the information into the proper hands.

EST and W9GHW, Kirkwood, Mo., at 7:30 P.M. W9USI worked W5AJG (9:25 A.M. CST), W8CVQ, Kalamazoo, Mich. (10:10 A.M.), W8NOR (10:30 A.M.) and W9HDU, Colorado Springs, Colo. (9:15 A.M., cross-band, 28-56). W9BRN, Butler, Mo., spent some time listening during the days 56 was open and on the 8th from 5:47 and 6:52 P.M. CST logged the following: W1IZY, SI, KJT, KLJ, CKJ, HDQ, W2LDV, LLL, AMJ, JCY, HMS, CUZ, GTO, ISY, W3AIR and W8OKC. At 3:25 P.M. he logged W2JVZ. The band folded up at 7:00 P.M. CST. W9BRN uses a Hallcrafters 5-10 receiver hooked to a 3.5-Mc. center fed Zepp. **June 9th:** At 9:55 A.M. CST W5AJG hooked W8QQS, Saginaw, Mich., and from 9:15 to 9:45 P.M. worked W8LJP and W8LZN of Detroit. W1LLL had FB contacts with W4DRZ (6:15 P.M. EST), W9EMR, Indianapolis (7:20 P.M.), W9ZJB (7:45 P.M.) and W9AQQ, Indianapolis (8:00 P.M.) and also worked W9ZPN and W9DSC. W9WDA, Duluth, worked W3EIS, Takoma Park, Md. W3HJQ QSO'd W9PQH (Batavia, Ill.) and W9FEN (Chicago) and heard W9WDA, AHZ, SMM, AZB and USI.

W8OKC logged W4DRZ (7-7:10 P.M. EST) and W9ZHB, W9ARN, W9CBJ and W9AHZ (8-9:30 P.M.). VE2AX heard W9DHW at 9:32 P.M. EDST. At 12:04 P.M. CST W9BRN heard W4FPM, Atlanta, Ga. (28-Mc. harmonic), at 1:48 P.M. W8QVC, and then from 4:33 to 7:02 P.M. logged the following: W1LLL, KWR, KJT, JFF, LKM, KTF, KGE, JNX, KXK, GRV, JQL, SI, GJ, HXP, ANA, GQA, KXJ, LFS, HQP, W2FBA, LDV, JCY, AMJ, CUZ, EKC, KLZ, W3RL, GLX, DOD, BZJ, W8CIR, JHW and EID. **June 10th:** W9USI worked W5AJG, 9:15 A.M. CST. Between 8 and 9 P.M. CST W5AJG worked W8RV, W9NY, W9ARN, heard W8CIR, W9ANA, W8QA. W3HJQ logged W9USI and AHZ. W9BRN, from 7:45 to 8:24 P.M. CST, logged W2AMJ, W3DBC, EZM, W8LJC, IUD, LAD, NKJ, PT, LJP, RV and CDU. The most consistent signal was that from W8LAD, who was running 150 watts to a T55. At 3:31 P.M. W9BRN heard W9ANA on c.w.

June 11th: W3FJ, Richmond, Va., worked W9WDA, Duluth, at 4:30 P.M. EST and heard W9USI (6:45 P.M.) and W9OLY, Des Moines, Iowa (8:10 P.M.). Transmitter at W3FJ: 6J5G-6L6-6L6-HK24 with 60 watts to final; receiver: 1851 r.f. followed by super-regen; antenna: two half waves stacked horizontal. W6QLZ, Phoenix, made contact with W7EMP, Walla Walla, Wash. QLZ figures his average miles per contact as 1025 miles. W8OKC logged W9AHZ and W9SMM? of Kansas City, 6:30 to 7:30 P.M. EST. W9WDA reports contacts with W5DXB and W5EKU of Vivian, La., W3FJ, W3HJQ, W3DBC, W3RL, W9GHW, W9ZJB, W5ML (Oil City, La.) and W5EHM (Dallas, Tex.). W3HJQ, Washington, worked W9WDA, MIW, PQH, AZE, USI and AHZ, heard W9ZHB, ZJB, SDS, SMM, OLY, ARN, GHW and ZD. W5AJG, between 8 and 10 A.M. CST, worked W3CUD, BZJ, RL, EIS, HPD, W8MST, QFX, CIR, FDF, TT and FKR, heard W3HQJ, GNA, W8GVE and SPU. Between 6 and 8 P.M. CST W5AJG worked W8NOJ, FKR, RV, W9DSC, HRC and ZJB, heard W9ISM, LJP, WDA, W8QDU, NYD, NZ, QA, W2HWY and W3EZM. W9BRN logged the following between 4:24 and 8:36 P.M. CST: W1KJT, ANA, LLL, IZY, JTM, KLJ, JQA, HXP, IDQ, W2QA, KKS, FBA, DB, ISY, AMJ, HWX, W3BYF, DOD, DBC, RL, BZJ, CGZ, HJQ, EZM, EWM, W5AJG, EHW, W8JHW, FXM, MST, OKC, RAD, QFX, PGJ, NOJ, QQS, NYD, W9AHZ, SMM, MIW, GGH, WDA and AZE. **June 12th:** The band was wide open from 6:20 to 9:00 P.M. EST and W8OKC, Shamokin, Pa., worked W4FBH, W8RSS, W9SQE, MYW, PQH and VHG; heard W9UYD (c.w.), KDB, ZJB, ARN, AHZ, BZJ, LF (c.w.), EMF, CLH, OLY and W2MO. The layout at W8OKC is 6J5G crystal osc., 6L6 doubler, TZ40 final, with 90-watts input. Receiver is an SX16 with 1851 preselector. Antenna consists of two 2-section

vertical 8JK beams, half wave apart and fed in phase; this is fed with a tuned line spaced two inches. W3FJ found the 12th the best day he experienced with W9CJB, MQM, ZUL, FEN, WDA and W8RKE worked, and W9OLY, ARN, VHG and W8CVQ heard, all between 7:10 and 8:30 P.M. EST and all signals S8-9. W3CYW, Richmond, Va., also worked much DX this night. W8BCL, Perry, N. Y., running only 16-watts input, worked W9AQQ, Indianapolis, and heard W9TPI, DSC and HRC, all Indiana, and W9SMM, Kansas City, all from 7 to 9 P.M. EST. W8BCL reports good reception with a 56 super-regen. W9WDA worked W3FJ, CYW and RL. W3HJQ has a good list this date, worked: W9ARN, TPI, VHG, UDO, OFL, IZQ and W8CVQ; heard: W9UYD, VPN, UJE, CLH, ZUL, OLY, ANA, NY, DWU, W8RKE and GRP. W3FX QSO'd W9ARN, Bartonville, Ill. (7:45 P.M. EST) and W9MXX, Chicago (8:05 P.M.). W1LLL, Hartford, worked W4DRZ (6:10 P.M. EST), W9ZJB (7:37 P.M.), W9ARN (7:55 P.M.) and W4FBH (8:14 P.M.).

From 6:08 to 9:25 P.M. EST on the 12th, W8PK, East Bloomfield, N. Y., worked W4FBH, W9HRC, W9AQQ, W9SMM, W9AHZ, W8NOR and W8RV, heard W4DRZ, W9KTB, TPI, VPN, ARN, NYV and LF (c.w.). W9NYV, Kimmswick, Mo., was using only 10 watts. W9BRN's log for the period 5:34-7:42 P.M. CST, the 12th, shows 70 stations heard! — W1AVV, JQA, JAX, KJT, ANH, KLJ, JQL, KXK, KHL, IZY, KMC, HDQ, JNX, JNC, LKM, EVI, KCB, SI, W2LHK, AMJ, GPO, LLL, LDV, MR, BW, BRI, DB, KKS, FBA, HMS, ISY, IVO, GFH, MO, IHG, JYF, CUZ, KLZ, W3AWM, DBC, RL, GSH, HJQ, FJI, HKM, EIS, CUD, FVR, HJT, AIR, FND, EZM, BYF, DYE, BZJ, HOH, W4FTH (No. Carolina), W8PK, JHW, LL, OKC, NOJ, FKD, FQS, NOR, RV, SOK, AGU, W9ARN and ZJB. **June 14th:** W1LLL worked W4EDD at 5:20 P.M. EST. **June 18th:**

W9WDA worked W5AJG, EHM, W9ZJB, SMM and AHZ. Between 9 A.M. and noon, CST, W5AJG worked W8SLU, RKE, QDU, W9FEN and WDA; heard W9NY and ISM. **June 24th:** W9WDA made contacts with W3DEB, RL, BZJ, BYF, GQS, W2JCY, FGB, CDC, W1LLL and W8EID. **June 25th:** W8OKC found the band open from 5:55 to 7 P.M. EST and worked W9GHW, Kirkwood, Mo.; heard W9ARN, ZHB and VHG. W8OKC seconds the motion of W3BYF in regard to increased use of c.w. operation. Auto ignition noise makes a 'phone carrier unreadable, where a keyed signal would be R5. W5AJG worked W8NYD, SKR, NOR, TT and LKD, and heard W8LJP, between 8 and 11 A.M. CST. He worked W8FXM and QQS when the band opened for a few minutes between 6:30 and 6:45 P.M. CST. **June 27th:** Between 5 and 6 P.M. CST, W5AJG worked W8PK, LJP, QQS, JLQ and NXB, heard W8QDU, LBJ and NOB.

112 Mc.

MATCHING the 80-mile two-way contacts between W1BBM and W1SS (reported in July *QST*), W6MAK, W6MYC and W6OJB established 112-Mc. contact over a distance of 75 miles on May 21st. Both W6MAK and W6MYC were using transceivers with 6C5 oscillators and 6F6 modulators. Antennas were 36 ft. long, mounted on top of the transceivers. The first 75-mile contact was at 4:00 P.M. PST between W6MAK at Griffith Park, Calif., and W6OJB at Oak Glen. W6OJB also used a transceiver. At 8:20 P.M. W6MYC (Pasadena) and MAK both worked W6OJB, with R5S8 reports all around. An earlier test, on May 6th, resulted in a 38-mile contact between W6MAK on Mt. Wilson and W6MYC near San Pedro. Another Pasadena ham active on "2½" is W6LQM, using a 6C5-6F6 transceiver.

— — — —

EASTERN MASSACHUSETTS ACTIVITY

By A. A. Stockellburg, W1SS

The rapid expansion of the use of "2½ meters" in New England, and particularly in the Eastern Massachusetts area, has resulted in a better understanding of what to expect from the band, increased knowledge of transmitters and antennas, and many exciting contacts for all. There are now over 100 New England stations on 112 Mc., more than sixty of them in the Metropolitan Boston vicinity. The first of the year activity was practically zero. The normal range at this writing is about 30 miles, and with mobile stations on Mt. Wachusetts, 40 to 45 miles, with signals perfectly readable. The greatest distances so far worked and reported are 80 miles (W1BBM-W1SS), 74 miles (W1BBM-W1JUN), 65 miles (W1LEM-W1BBM), and 49 miles (W1BOO-W1SS). The following notes on tube line-ups, antennas, etc.,

(Continued on page 78)

8 CONSECUTIVE QSO'S—7 DISTRICTS QSO!

ON JUNE 7TH W1CND brought GM6RG up to Mt. Wilbraham to show Bryan how W1HDQ worked DX on 56 Mc. While they were there contacts were made with W5DXB and W8EID. On the 8th HDQ worked W9UYD, W9GHW, W2GPO, W1JTB and W3AC/3. The next time on the air was the 12th and the first contact was with W4DRZ! There it is; in 8 consecutive QSO's, and no thought of trying for any sort of a record, 7 different districts were worked. Ed. Tilton gives GM6RG credit for starting something on the 7th!

Entertaining Uncle Oscar

'Phone, 160 Meters and Fiction (?)

BY ERIC ADAMS,* VE3ALG

HAM is faced with the pleasant task of demonstrating his station to Uncle Oscar, just in from the country. Leads uncle into the shack and heartily hopes that everything will work, since uncle shows signs of great enthusiasm. Recalls final tank condenser arced four times on last transmission; hopes uncle will accept same as natural phenomenon should it occur again. Prepares for ordeal by turning on receiver, transmitter and soldering iron since past experience has shown that this last item must be used at least once per QSO on the average.

Is glad he has returned to 160 'phone since Uncle Oscar will no doubt find 'phone far more interesting than c.w. Uncle mentions that he has heard much about inter-continent amateur contacts and casually requests that his nephew raise Africa or Europe. Ham explains that such things are not done on 160 'phone (and feels like adding, "Or any other band," as far as he is concerned). Uncle Oscar gets very excited and shouts, "I knew them newspaper articles was lies! It's agin the laws of nature to talk to fellers in them places! How could a body talk to someone in China when it ain't every feller what speaks Chinese? Take me fer example, I don't reckon as how I know a word of anything but English."

Ham is not impressed with his uncle's English and feels like telling him to improve it before worrying too much about his inability to speak Chinese, but respect for his elders throttles this remark. Ham decides to impress uncle by drawing sparks off the antenna with a pencil. Sparks are too feeble to excite the ham-mind but nevertheless uncle is interested and promptly wants to light a cigar on the antenna condenser. Ham says it can't be done and leaves room to get matches, since he is afraid of his lighter ever since he "fixed" it and it emitted a seven-inch column of flame, nearly setting his hair on fire.

Ham returns and is horrified to find Uncle Oscar kneeling behind rig with one hand on rack and his nose about a quarter of an inch from cap of one of the 866's. Wonders if it would be best to shout warning, or take more definite steps to enable Uncle Oscar to continue living. Decides on latter course and gently but firmly drags uncle backwards by the ears amid S9 protests at such unfriendly handling. Protests cease after ham explains exact details, taking care to

point out that an arc jumping from the end of one's nose looks silly, even though the victim is in no condition to worry very much. Uncle says he only wanted to see inside of rig and proves his genuine interest in radio by asking: (1) What would happen if a bird sat on the antenna? (2) Does steam come off the antenna if the rig is on while it is raining? Ham is not very sure about the first question and idly grabs the *Handbook* to look up under "bird." Is somewhat disappointed to find nothing so devotes his remarks to the second question and emphatically denounces idea of steamy antenna.

Hunts over band which shows little sign of activity, so puts rig on and calls a long CQ, interrupting same with frequent insulting remarks directed at local hams who might be listening and who might come on the air to defend their honor. Allows uncle to hear transmission by using earphones on receiver. Uncle listens attentively and finally remarks, "Say, this feller's voice sounds a little like your own, don't it?" Ham stops CQ long enough to point out that it is his own and that is possibly why there is some resemblance. Explains to uncle what is happening and continues calling. Looks over the band and is rather pleased to hear local calling him in an irate voice suggesting a QSO of the 160-meter-feud type. Station calling seems to be using a telephone mike and modulating about seventeen per cent; the quality being very hard to read. Ham opens QSO by asking, "What did you say you were selling?" which remark is calculated to at least trigger off a "different" contact. Meanwhile uncle asks what country the station they are working is located in, and if the operator can speak English. Ham explains station being worked is four blocks away and that the operator

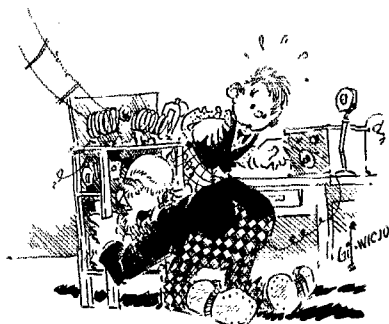

509½ Yonge St., Toronto, Ont.

is speaking English. Uncle replies that he cannot make out a word that is being said and why not use the telephone if the other fellow is only four blocks away? Ham decides poor quality is main reason for his uncle being unable to understand QSO, so on next transmission withdraws his report of Q5 S9 and substitutes Q-zero S9, after which he signs off with a few "73's" and several other c.w. abbreviations which were never neant to invade the 'phone bands.

Ham looks over the band again and hears another local calling an out-of-town station which he happens to know is right on his frequency, so when local stands by he conveniently comes on shouting, "Hello test!" Needless to say other local comes back bewailing fact that out-of-town station was put out of the picture. Ham says he is very sorry and obligingly supplies a Q5 S9 report followed by a series of highly complimentary and exaggerated remarks regarding fidelity, etc. Lengthy QSO, follows during which such topics as rotary beams, 5-meter DX, and YL's are discussed in great detail, most of the detail being reserved for the YL portion of the transmission. Second transmission is utilized to take apart several of the more popular transmitting tubes, which are heartily condemned by both hams. The fact that neither ham owns, or knows anyone who owns, one of the tubes is a matter of apparently little importance. Third transmission deals with popular commercial receivers which are treated with the same derision given the tubes previously. Both hams are unanimous in stating that they wouldn't dream of trading their own home-made receivers for any one of the commercial models which they have just discussed. Neither ham bothers to mention he recently looked over a few catalogs and cast many envious glances at the receivers just panned with such gay abandon.

Ham suddenly remembers his uncle and turns around to find that gentleman sound asleep, despite the fact that radio history is being made. Finally wakes uncle by shouting violently. Uncle jumps up, mumbling unintelligibly, but quickly quiets down and devotes a rather sleepy interest to the QSO which terminates three minutes later when the other ham remembers a date with his YL. Ham feels very disgusted with everything, especially his uncle, and resolves never to undertake further demonstrations for anyone; then mentally decides to make Susie the one exception. Telephone rings and ham finds next-door neighbor wants to know if he is on the air since said neighbor has been bothered with considerable QRM for the last few minutes. Ham simply states he is not on the air, which remark he feels is the solemn truth, as he is speaking on the telephone at that exact instant and, therefore, is not on the air; whether he was on or not a few seconds previously is a side-issue which ham does not consider necessary to discuss.

Loud and unpleasant snores, very similar in tone to some foreign (and domestic) c.w. signals, give audible evidence as to Uncle Oscar's condition. Ham is completely fed up with both Uncle Oscar and 160 meters. Decides to leave them both strictly alone and goes downstairs to listen to Jack Armstrong on b.c.l. set.

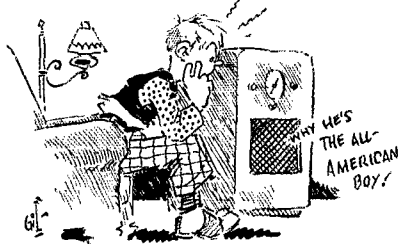

1.75-Mc. W.A.S. Party Results

THE "160 Meter" gang turned out in great style for the W.A.S. Party held on that band the week-end of February 18th-19th. If there were any question about what could be done on that band, it certainly must be answered now! The 'phone portion of the band was crammed full of contest calls from one end to the other — and it wasn't just QRM either; contacts were established right and left. The big surprise of the affair was the activity of the c.w. operators. At the height of the party the 1715-1800 kc. region sounded like 3.5 Mc. on a busy night. Many participants used both 'phone and c.w. with much success and there were a good number of 'phone-c.w. QSO's. It was real sport all the way through!

The Party ran from 3:00 P.M. PST, February 18th, until 12:01 A.M. PST, February 20th. Participants were allowed operation in any twenty hours of this thirty-three hour period. Scoring was based on the number of stations and states worked. Each station counted one point, total points being multiplied by the total states worked.

W9UWL, Illinois, succeeded in contacting the greatest number of states — 37. Those missed were Oregon, Nevada, Idaho, Arizona, Utah, Montana, Wyoming, Colorado, New Hampshire, Vermont and Florida. Second in number of states and highest scorer was W4BPD, South Carolina, with 5040 points, 36 states. He missed Arizona, Idaho, Montana, Nevada, New Mexico, North Dakota, Oregon, South Dakota, Utah, Vermont, Washington and Wyoming. Leader in number of contacts was W9HHR, Wisconsin — 150. Other highs in contacts were W8IAR (two oprs.) 142, W4BPD 140 and W3BJU and W6QEU 136. The ten highest scorers: W4BPD 5040, W9HHR 4800, W8IAR 4118, W9UWL 4107, W9KOH 3270, W3BJU 3264, W6QEU 3264, W8RUM 3232,

(Continued on page 84)

★ I. A. R. U. NEWS ★

Devoted to the interests and activities of the

INTERNATIONAL AMATEUR RADIO UNION

Headquarters Society: THE AMERICAN RADIO RELAY LEAGUE, West Hartford, Conn.

MEMBER SOCIETIES

American Radio Relay League
Asociatia Amatorilor Romani de Unde
Scurte
Associazione Radiotecnica Italiana
Canadian Section A.R.R.L.
Ceskoslovenski Amatéri Vyslacci
Deutscher Amateur Sende-und-Empfangs
Dienst
Eesti Raadio Amatooride Uhing
Experimental Radio Society of Egypt
Experimenterende Danske Radioamatorer
Federation des Emetteurs Belges
Irish Radio Transmitters Society

日本アマチュア無線聯盟 Japan
Liga Colombiana de Radio Aficionados
Liga Mexicana de Radio Experimentadores
Magyar Rövidhullámú Amatőrök Országos
Egyesülete
Nederlandsche Vereeniging voor Interna-
tionaal Radioamateurisme
Nederlandsch-Indische Vereeniging Voor
Internationaal Radioamateurisme
Newfoundland Amateur Radio Association
New Zealand Association of Radio Trans-
mitters
Norsk Radio Relé Liga

Polski Zwiasek Krotkofalowcow
Radio Club de Cuba
Radio Club Venezolano
Radio Society of Great Britain
Rede dos Emissores Portugueses
Reseau des Emetteurs Français
Reseau Luxembourgeois des Ama-
teurs d'Ondes Courtes
South African Radio Relay League
Suomen Radiomattori Seura r.y.
Sveriges Sandareamatorer
Unión de Radioemisores Españoles
Union Schweizer Kurzwellen Amateure
Wireless Institute of Australia

SWITZERLAND

THE *Union Schweiz Kurzwellen Amateure* (Switzerland) held its annual general assembly in Zurich on May 30th, at which time an election of officers was held. HB9AA and HB9RBA were re-elected respectively President and Vice-president-Treasurer. HB9BO was elected Traffic Manager, succeeding HB9T who is on an extended visit to America. HB9C is the new Secretary, while HB9M remains as Editor and HB9RMD as QSL Manager.

Swiss amateurs are much concerned over an apparent wish of their government to take away the frequencies 14-14.1 Mc. beginning in September. The suspicion has not been quite escapeable that the administration aspires to establish some high-frequency broadcasting stations in this range, considering the vigorous way in which they supported broadcasting vs. amateurs in this band at Cairo. This is a little amusing now, inasmuch as it is certain that if there is any amateur band that cannot be diverted to another purpose without causing international QRM, it is our 14-Mc. band. Switzerland is a party to the international convention and regulations, and it is certain that if she commenced the operation of any non-amateur stations in our 14-Mc. band, she would promptly be the recipient of formal diplomatic protests from the many countries in which this is an exclusively amateur band.

WE HAVE several items of particular interest about amateur activities in Australia:

TOKEN OF APPRECIATION

During discussion on international amateur affairs at the 1938 W.I.A. convention, all delegates were unanimous in their praise of the work done by the A.R.R.L. and in their appreciation of the manner in which the A.R.R.L. had acted as Headquarters Society of the Union, according

to Hon. Fed. Secretary H. W. S. Caldecott. As a result, it was decided that a token of appreciation in the form of an Australian boomerang should be presented to the A.R.R.L. This beautifully-engraved token is now framed on the wall of the Secretary's office of the Headquarters Society. The inscription reads: "Presented to the A.R.R.L. as a token of appreciation of the efficient and impartial manner in which they have acted as Headquarters Society of the I.A.R.U. --- W.I.A. Federal Convention, 1938."

VK-ZL DX CONTEST RESULTS

As a part of Australia's 150th anniversary celebrations, the 1938 VK-ZL Contest was an unqualified success. From all parts of the globe have come letters of congratulation and thanks. There were large increases in the number of entrants from all countries, and in Australia and New Zealand the number was almost doubled over that of 1937.

In the senior section, the trophy for that station outside VK-ZL obtaining the highest score was won by W. M. Atkins, W9TJ, with 19,740 points, representing 118 contacts on three bands in 28 districts. Close behind was W6KRI with 19,376 points. C. Miller, VK2ADE, with a score of 91,300 points, won the trophy for the highest-scoring VK-ZL station. New South Wales was awarded the third trophy, that for competition between the Australia-New Zealand districts.

Every log was thoroughly checked. A T6 report, properly substantiated, was sufficient for disqualification, and a close watch was also kept on the band edges. The Contest Committee, through Chairman VK2TI, would like to thank all those societies and individuals who cooperated in making the Contest a success. Lack of space dictates that we publish at the end of I.A.R.U. only a few outstanding scores in the senior contest.

BUSH FIRES

Never before in the history of the Australian Commonwealth have there been such widespread and destructive bush fires as there were in January of this year, climaxing months of drought and days of high temperatures. On Friday the thirteenth, with temperatures throughout Victoria and South Australia between 110 and 120 degrees and fires fanned by a 40-mile-per-hour gale, the situation got rapidly out of hand. With half of Victoria ablaze, towns wiped out and the death roll mounting, communication to the stricken areas became a matter of paramount importance. Australian amateurs, who had read of amateur emergency work in the United States during floods, hurricanes, etc., and whose only thoughts were, "It can't happen here," found themselves in the midst of an emergency just as vital. The affected divisions of the *Wireless Institute of Australia* offered the full resources of their organizations to the authorities. Their main problem was to get sufficient operators who at a moment's notice could leave their homes and jobs for an indefinite period.

The forest commission in Melbourne selected a number of "message center" points to which they needed communications badly, and within a short time amateur emergency stations were on their way to the most vital points, some of them 250 miles away. Each station took full camping equipment and food for three to four days; in addition to hurriedly-collected portable equipment, genemotors, vibrator packs, etc. One party, on arriving at its assigned destination, found the entire town wiped out! Another kept an operator at the key while helpers splashed water on the walls of the shack to keep them from catching.

Amateur communications work was organized, spontaneously, on the network principle of a control station for each set of portables, the control stations all tying in to one district headquarters station. Emergency conditions existed for nearly two days, during which Australian amateur radio rendered yeoman service. Fortunately, rain finally arrived and enabled the army of fire-fighters to bring it under control.

And while the bush fires raged in eastern Australia, the northwest coastline was hit by a cyclone which did enormous damage by high wind and water, washing away many houses and destroying all means of communication. Here, again, amateur radio provided the necessary contact with outside relief agencies until commercial mains could be restored.

Most of this information has been taken from the bulletins "Amateur Radio" and "Break-In," of the W.I.A. and N.Z.A.R.T., respectively. It is pleasing to note that both publications, realizing that an even better communications job could have been done had there been advance preparation and organization, are urging their amateurs to become emergency-conscious, to build portable equipment, and to join military reserves to receive training in organization for such disasters.

VK-ZL CONTEST LEADING SCORES

Australia. VK2ADE 91,300, VK2HF 62,656, VK2TI 35,002, VK3KX 30,426, VK3HG 15,300, VK3WL 13,940, VK4JX 60,437, VK4BB 56,252, VK4AP 24,575, VK5FM 13,302, VK5FL 9300, VK5LD 5797, VK6AF 18,864, VK6MW 13,040, VK6FL 12,420, VK7JB 5082, VK7LZ 4875.

New Zealand. ZL1DV 67,940, ZL1BT 15,183, ZL2QA 64,974, ZL2GN 42,720, ZL3AZ 30,160, ZL3GU 14,500, ZL4DQ 62,832, ZL4BR 12,825.

North America. W1COM 912, BFA 237, W2BHW 14,388, HHF 6860, JWZ 4050, DZA 2580, DEU 1624, ICX 1200, HZN 840, HAY 515, IB 355, ION 236, AV 48, W3BES 5580, GEH 5060, GHB 2187, GTR 1848, GVE 696, GGT 665, GHD 665, WU 236, FQO 141, QYV 108, EPJ 12, HNN 12, W4DCZ 2362, EQC 2400, CN 2214, FOY 440, EBY 405, DOY 12, EEO 12, W5WG 17,334, KC 4020, EZA 3620, EWZ 1274, W6KRI 19,376, IOJ 16,150, OEG 14,856, IPH 9780, MXN 7922, PNO 7769, AWY 4280, ACL 4017, EGH 2466, JGQ 2268, KQK 1958, QBY 1850, ONG 1460, PJR 1064, BQ 1056, QAP 672, MHB 428, MUR 231, PBV 151, CJ 70, ABE 12, LFX 12, LVQ 12, MUF 12, W7CMB 8702, DVY 7543, ABC 1287, FXF 236, W8OQF 2097, ACY 1344, JAH 1267, JMP 959, PTB 875, DAE 615, ITK 236, LOF 236, QXM 171, W9TJ 19,740, CWW 7218, WTW 5992, JCU 3762, BFL 2224, GKS 2142, VW 1968, HUV 1476, QMD 1008, EKC 505, CUE 236, TKN 192, BBS 108, RQS 48, VE3KP 1855, T2FG 1881, XE1AM 810, NY1AD 918, K4ESH 960.

Europe. ON4GU 108, OZ2M 90, ES1E 192, OH5NF 959, F3MN 1818, D4AFF 4125, G2LB 2070, G3CW 416, G5MY 828, G6XL 4565, G8KP 276, I1KN 2270, LY1KK 1379, ZB1J 2456, PA0XF 2280, G16YW 108, LA1G 1953, SP1LP 735, YR5ML 1778, SM7MU 2970, GM6RV 1712, HB9AK 3267.

Asia. VS7MB 4250, XU8DI 565, VU2AN 924, J2JJ 8398.

Africa. ST6KR 685, CN8AG 280, VQ8AF 48, ZS5U 234.

South America. LU7AZ 4158, PY1AJ 399, CE4AD 1368, CX1BG 1561.

Oceania. VR4AD 12,308, K6CGK 14,508, PK3EM 5369, KA1DL 1246.

★ NEW TUBES ★

EIMAC 75T

THE Eimac 75T is a new triode with a 75-watt plate-dissipation rating designed to develop high power at low plate voltage. The grid lead comes out the side of the tube. The plate lead at the top is fitted with a shield to reduce heating at the plate seal. Characteristics and recommended operating conditions are as follows:

Characteristics:

Filament Voltage.....	5
Filament Current.....	6.5 amp.
Amplification Factor.....	10.6
G-P Capacity.....	2.3 μ fd.
G-F Capacity.....	2.2 μ fd.
Max. Plate Current.....	175 ma.
Max. Plate Voltage.....	3000
Plate Dissipation.....	75 watts

Typical Operating Conditions Class C:

Plate Voltage.....	750	1000	1500
Plate Current (ma.).....	435	175	175
Grid Current (ma.).....	30	30	30
Grid Bias.....	-150	-200	-300
Power Output (watts).....	70	125	200

At a plate voltage of 2000, a pair of these tubes as Class-B amplifiers will deliver 400 watts audio to a 12,500-ohm load.



HINTS AND KINKS FOR THE EXPERIMENTER

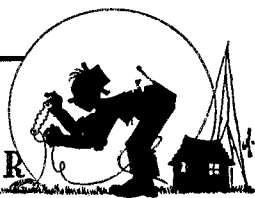

KINKS FOR PORTABLE TRANSMITTERS

HAVE a couple of suggestions that may or may not interest the boys. One is that of using flashlight lamps as resonance indicators in low-power rigs where either cost or space eliminates

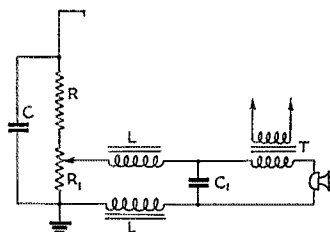

Fig. 1 — Circuit for eliminating microphone battery in portable transmitter.

R-C — Usual values of cathode resistor and by-pass condenser.

R₁ — 100-ohm wire-wound, 25-watt.

C₁ — 25–50 μ d., 50-volt.

L — W. E. Co., 46-N Retardation coil. (Small 2-winding chokes, 100 ohms per coil. Almost any small iron-core chokes may be used, such as old high-resistance door bell or buzzer coils.)

T — Usual mike transformer.

meters. On my portable I placed lamps in series with the tank tuning condensers and they worked out swell with no noticeable bad effects, even though I was afraid one in the oscillator tank would cause poor keying. A 6N7 is used as a c.c.o. and doubler-buffer; with a plate voltage of 300 volts, 2.5-volt lamps light to about $\frac{3}{4}$ brilliance at resonance. Mounting the sockets right on the tank condensers keeps leads short.

Then, in order to eliminate the grief caused by "mike" batteries, either from being "down" or forgotten, it was decided to eliminate them. It was reasoned that since the modulated amplifier plate load was constant, that mike voltage could be taken from the drop across the cathode resistor. In this case a pair of 807's was used. A 100-ohm wire-wound-resistor was used as indicated in Fig. 1. A variable resistance was used to accommodate various single-button mikes, and checks on a

'scope and on the air indicate operation just as satisfactory as with batteries. If the original cathode resistor is slider type, and only one mike is ever used, the 100-ohm variable may be eliminated. In either event, adjust tap or slider for correct button voltage at no signal input, and final running at normal rating. The filter was required to eliminate motor-boating. While I do not recommend its universal use, the idea does provide a very satisfactory substitute for batteries in a portable, where this fawney hi-fi stuff is skipped in favor of simplicity. The combination of the two ideas contributes to the cause in more ways than one, as you can see. Extra and unattached parts are easily forgotten, broken or a dozen other things when you grab the portable for a hurry-up day afield.

— Herb Walleze, W8BQ

The idea of obtaining microphone voltage from the cathode biasing resistance was suggested also by Malcolm Stevens, W8IWG.

CODE PRACTICE MACHINE

I HAVE a code machine with which I mastered the continental Morse code, which can be built for little or nothing if one has or can get an old phonograph spring motor. I believe it will be of considerable interest to the would-be hams who read *QST* and the Old Timer who desires to increase his code speed.

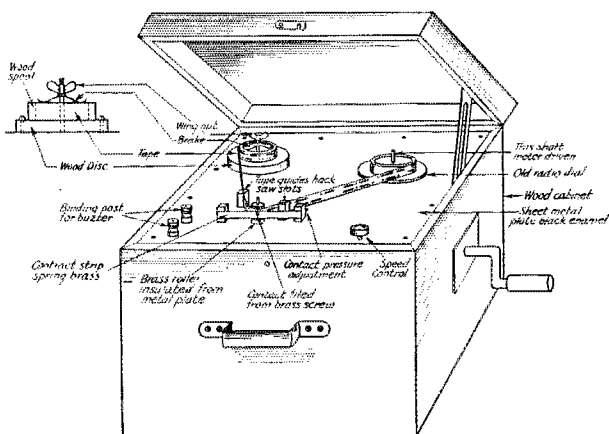

Fig. 2 — Code machine made from old phonograph spring motor and junk-box parts.

I thoroughly cleaned the motor, part by part in gasoline to remove any grit that would prevent smooth operation. The motor was carefully assembled and lubricated with a good grade of machine oil. In running a test on the motor I found that the speed of turntable shaft was too great and the power not sufficient to pull the tape, so the turntable shaft was sawed off at the frame and the gear shaft next to it was extended so as to obtain power there. In running a test on the motor again the speed was found to be correct and the power sufficient to pull the tape.

Constructional details are shown in Fig. 2. I tape mounted the motor with rubber shock absorbers on a sheet-steel foundation from the junk box and allowed the shaft mentioned above to protrude through. An old radio dial was mounted on it as a receiver for the tape. A post was mounted for the roll of tape. Guides were mounted to assure accurate travel of the tape. A brass roller was used for the contact to make electrical connection through the tape. The tape travels on this brass roller similar to a belt on a pulley. The contact was filed from a brass screw in such a manner as not to damage the tape and mounted on a piece of spring brass in such a manner that it would make contact with the brass roller, thus making the dots and dashes as the tape traveled past. There are several adjustments on this contact strip to set the contact for proper pressure, etc.

The last thing to make was the cabinet which was made of wood and stained and varnished. A buzzer and oscillator were tried on the machine, and both work FB. After about two months of steady practice of about two hours per day, I mastered 18 w.p.m. and passed the code test FB the first time.

The machine made such a hit with other would-be hams that it has been in constant use since I finished with it, and is engaged for months to come. Only four tapes were purchased and they are in perfect condition after six months of continuous use. Tapes may be purchased for one dollar each.

The machine has a wide range in speed from about 3 w.p.m. to 60 w.p.m. and it is very easy to control the speed to suit the operator. If I am lucky enough to ever get it back, I hope to try it out on the rig as an automatic sender and use it for calling CQ, etc. Hi!

— J. S. Branch, W4FWO

CHEAP RELAYS FOR KEYING AND OTHER USES

PERHAPS many of the radio amateurs have overlooked an excellent supply of relays for keying and other numerous uses around the ham rig.

With simple adjustments and alterations inexpensive auto generator cut-outs make reliable, fast-acting relays which can follow a "bug" at 40 w.p.m. These cut-outs can be picked up when

discarded at garages. About half of these so-called worthless cut-outs are still serviceable as relays. If worst comes to worst, brand-new ones can be purchased at mail order houses for as low as 27 cents each.

The alterations are simple. Carefully remove the dust cover. Cut and remove the larger outer winding from the core, being careful not to damage the high-resistance winding of fine wire. Next, loosen the spring tension on the armature. This is necessary because the tension is factory-adjusted to require a generator voltage of about 7 to close the contacts. By loosening this tension, the relay will work satisfactorily on as low as $1\frac{1}{2}$ volts, although 3 volts is better. The spring tension is adjusted by bending the spring holder or stretching the spring according to the individual construction.

When the tension is O.K., clean the contacts (if an old cut-out is used), adjust the spacing of the contacts, put a connecting lead on the lower contact strip and replace the dust cover.

These make excellent relays where single-contact single-throw is needed. They are fully shielded and quite noiseless in operation. I have found the Ford cut-out makes the best relay and is easiest to convert, although Delco-Remy and others are O.K.

Originally the upper contact is shorted to the frame of the relay along with one lead from the high-resistance winding. If desired, a little in-

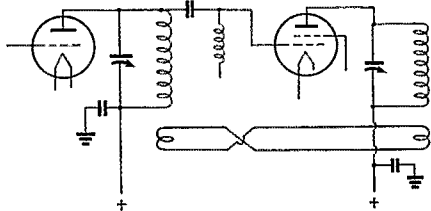

Fig. 3 — Link neutralizing for tetrodes and pentodes such as 6L6, 6V6 and other tubes sometimes difficult to neutralize by other methods. Links must be poled correctly. (See text.)

genuity will show how to insulate these two connections.

— Harold K. Long, W7CQK

LINK NEUTRALIZING FOR LOW-CAPACITY TUBES

IT HAPPENED upon a rather simple and inexpensive way to neutralize a tube while experimenting with my RK-39 buffer. This is one of the beam tubes which has such a small grid-plate capacity that it is difficult to neutralize properly and, for that reason, I had been letting mine run unneutralized. Under certain conditions, oscillation would occur since it was being biased with a small cathode resistor.

The solution proved to be a form of inductive neutralization. In this case, the coils did not need

to be coupled directly. A one- or two-turn link was placed near the cold end of the coils as shown in Fig. 3.

Reversing one of the links proved to be necessary in order to provide out-of-phase voltage for neutralization. The link on the oscillator plate coil was wound on the form; the link coupled to the plate coil of the buffer was held near the coil and the distance varied until neutralization occurred. Neutralization was obtained with the link coil about two inches away from the tank coil in my case. The line can be any reasonable length and either twisted or paralleled line could be used just as in link circuits. Tighter coupling and more turns would probably be necessary for tubes with larger grid-plate capacities. The great advantage of this scheme is that it requires no neutralizing condenser and does not use center tapped coils, although it can be applied in cases where coils are already center-fed. The "grid" coil can be either the plate coil of the preceding stage, as shown, or the usual coil right in the grid circuit when used with standard link coupling.

— Alan P. Buffington, W3EEW

A similar idea is used with success by Bud Keller, W6QAP, in neutralizing a 6L6G.

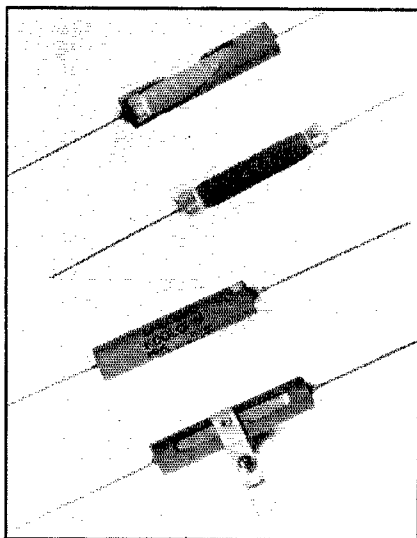

ceeded by 25 per cent, returning to the original color when the overload is decreased. The lower unit is an adjustable type, with a slider working on a single-layer resistance winding.

Because the turns of wire can be wound very closely together, it has been possible to wind non-inductive Koolohm units which in independent laboratory measurements show no measurable inductance at frequencies up to 50 Mc. The distributed capacitance of a 10-watt non-inductive unit is approximately 2 μ fd.

Koolohm units are available in 5- and 10-watt sizes in the construction illustrated. Larger resistors are similar, but have metal outside jackets and are provided with lug terminals at the ends, thus permitting all but the actual terminals to be at ground potential.

— G. G.

— — —

New Radio Control Relay

CONVINCED that there is an important field for relays in radio-controlled model work, Sigma Instruments of Belmont, Mass. (whose earlier products have been specified in *QST* articles on the subject), have developed a new relay of exceptional characteristics which should prove ideal for such applications.

Superficially, the new relay — Type 3-U — is similar to the regular Type 3-A in appearance. There has been added a cobalt steel permanent magnet which has been drawn down to proper flux density after initial magnetization. As a consequence, the relay is unilaterally poled — that is to say, the relay is extremely sensitive to small currents flowing in one direction. With a heavy hairspring, the torque is so increased that much greater contact pressures are obtainable.

(Continued on page 74)

★ NEW APPARATUS ★

A New Type of Wire-Wound Resistor

EVERY amateur has at least one wire-wound resistor somewhere in his equipment, and probably knows that it is constructed by space-winding bare wire on a ceramic tube and then covering the wire by a coating of cement or vitreous enamel. Practically all power resistors use this type of construction. The use of insulated wire, which is a feature of a new type of resistor marketed by Sprague Products Company under the name "Koolohm," is an innovation in resistor construction, made possible by the development of a new type of insulation of ceramic nature which is fused on the wire at red heat and is thus capable of withstanding the high temperatures at which such resistors operate. The use of insulated wire permits winding the turns so that they actually touch, allowing the use of a layer winding to accommodate a large number of turns of relatively large wire in a small linear space.

The photograph shows an exploded ten-watt resistor. The central core is the same size as the conventional 1-watt carbon unit, and the resistance wire is wound on by the progressive universal method. A ceramic jacket is placed over the ends and then sealed on so that the unit is insulated and watertight. The small dot at the right on the complete resistor is normally red, but turns brown when the dissipation rating is ex-



CORRESPONDENCE FROM MEMBERS

The Publishers of *QST* assume no responsibility for statements made herein by correspondents.

THE NEW B. C. SETS

56 Pearl St., Gardner, Mass.

Editor, *QST*:

Your editorial this last month in regard to the new broadcast receivers being put on the market certainly hit the nail on the head. I am heartily in favor of something being done about these so-called "modern" receivers, because they have caused me considerable embarrassment lately.

A very close friend of mine recently asked me to recommend a good radio receiver, as he was planning to trade in his two-year-old model for a new one. I obligingly recommended a regular standard make set selling for around \$75.00, nationally advertised, and supposed to be the very latest thing in the B.C.L. line.

A couple of days later my friend called me on the 'phone, and very excitedly told me that there must be something wrong with my 20-meter 'phone transmitter because he could hear me blasting through on at least two places on the broadcast band on his new receiver! A thorough checkup on my transmitter showed it to be working properly. I asked him to connect up his older model again. No interference was found at any point on the dial. Luckily, the new set was only on trial, so I firmly recommended that he have the old set overhauled and forget about getting a new one. In fact, I'm scared to death to recommend *any* of the new receivers to any of my acquaintances. When anybody asks me about buying a new receiver now, I tell them to have their old set overhauled by a good radio repair man and they will be much better off.

This state of affairs is pretty rotten, if you ask me, and I believe that the various manufacturers would be surprised if they knew how much influence the amateurs have in the buying of new receivers. The amateur is frequently consulted by his friends and neighbors to help them pick out the radio for them to buy. He is regarded as an authority in the radio game, and whatever he recommends is supposed to be the best. He is not connected with any commercial interest, and therefore his choice is supposed to be the "tops." You can well imagine my feelings after getting reports of QRM from *my* station on a receiver of my choice a good half a mile away, when a set a few years old in my house isn't bothered a bit.

I believe the A.R.R.L. can be of great service to amateurs and B.C.L.'s also by making a survey of the new receivers on the market and pub-

lishing a list of those sensitive to every amateur transmitter in town.

— Gordon V. N. Wiley, W1AUN

GOOD TASTE

Editor, *QST*:

. . . Many times I have tuned my receiver to some 'phone station and immediately I would hear some fellow telling the other about his big drunken orgy of the night before, and to come on over and take a "blam" with him. Such conversation on the air, for the public to hear, is idiotic, and it leaves a bad impression on the minds of those that might be listening. No doubt individuals, on hearing a conversation of this nature on the amateur bands, think that the operator should be bathing with the swine instead of exercising his voice on a microphone. The right to drink or not to drink belongs to the individual, but by the same token he should keep his private affairs strictly to himself, in my opinion.

I would not have you think that I am a fanatic on the subject or that the office that I hold (Police Judge) has influenced me any at all in what I have to say, for that would be far from the real truth. It just isn't good manners to carry on a conversation of this nature, and in many cases betrays the raising of the individual. . . .

— Vernon E. Congleton, W9DPW

STRENGTH IN NUMBERS

• Box 203, Jonesboro, La.

Editor, *QST*:

I have read so many letters from amateurs and non-amateurs kicking about what A.R.R.L. is doing and not doing, that it burns me up. A.R.R.L. is doing its very best as I see it, except for one thing. They do not bear down hard enough on the subject of getting more new amateurs. Our strength, as in any other thing, is in numbers. The more active stations we have, the stronger we will be.

We Americans haven't lost any of our bands recently, but some of our foreign brothers have. Why do the commercials want our bands so badly? There are spaces on any short-wave receiver wider than any of our bands, where there are apparently no stations. Then, in other spots, you can find a whole flock of commercials who do nothing but send V's and sign.

(Continued on page 88)



OPERATING NEWS



F. E. HANDY, W1BDI, Communications Mgr.

E. L. BATTEY, W1UE, Asst. Communications Mgr.

Handsome silver cup trophies are being awarded this month to the winners of A.R.R.L.'s all-season Official Relay Station and Official 'Phone Station competitions for their October-May '39 standing. This coming October, a new series of Cup Trophies for the best official station performance will be announced. All League members should now qualify for these important and leading station appointments,* so their radio activity starting in October may count toward next season's awards!

Benton White, W4PL, of Shepherd, Tenn., wins the big first-prize cup for the best traffic handling work of any O.R.S. in the nation. His totals for the seven months aggregated 15,448 messages handled, around 2200 a month average! He led the B.P.L. time after time. Consistent and reliable schedule keeping is a habit with W4PL, and this fine record is no spurt for a few months alone, but crowns a history of brass-pounding that any amateur might be proud of! W4PL took part in general League activities, and found time for some fishing and photography besides. Our hat is off to W4PL! The second prize winning entry in the O.R.S. competition was received from **Alfred Stekevicz, W1KIN**, Hudson, N. H. He also receives a loving cup, suitably engraved, and is to be congratulated for his accomplishment. A leading member of the New Hampshire Net, W1KIN also has a file of worthwhile traffic handled as a concrete token of consistent work. Congrats and best wishes to both of you.

Official 'Phone Station performance for the same period was based on experimental, constructional and operating results, with points also for ingenuity, engineering, article contributions, the number of stations worked between (and in) the quarterly tests. The competition on all the different factors was quite keen, W2JZX leading in operating credits, W6IWU on engineering and ingenuity, and W8BTP on fixed credits for contributions and organization work. All three contenders receive cups, with the over-all point summaries placing their relative standings as follows:

Mrs. Viola Grossman, W2JZX, East Rockaway, L. I., N. Y.	1338.5
George R. Stray, W6IWU, Ducor, Calif.	1140.0
Melvin L. Gelow, W8BTP, Kalamazoo, Mich.	609.0

* Information on O.R.S., O.P.S. and all other League appointments is available to Members, free on request. To those not A.R.R.L. Members a booklet, with full information on the field organization, and data on amateur emergency communication, will be sent on receipt of 10¢.

Heartly congratulations to all the above winners are in order. There are some features in these stations all of us will do well to copy. W2JZX has given special attention to safety. Appropriate grounds have been installed, and everything on the panel front is dead as per the A.R.R.L. Code for 'Transmitter Construction. "Frequency insurance" feature at W6IWU is a series of pilot lights connected to the crystal tap switch, showing which of five frequency bands is in use, and the frequency. One can't so easily switch a 'phone band crystal to an off band spot with such an indicator! — F.E.H.

BRIEFS

Amateur operators located on the coast of the Gulf of Mexico, operating in the 7-Mc. band, are invited and urged to affiliate with the Gulf Coast Storm Net. For complete details write to the Galveston Amateur Radio Club, 2021½ Strand, Galveston, Texas. The key station, W5DIG, operates on 7181 kc. and weekly schedules and drills are held every Sunday from 10:00 A.M. to Noon, C.S.T.

The "A.T.E. Net," operating on 3570/7140/14280 kcs., is composed of Associated Technical Engineers of the National Broadcasting Company. Their main get-together is on Monday evenings, and during the summer operation is usually on 7140 kc. The net at present includes about 20 stations in New York City, Washington, Chicago, Cleveland, Denver, San Francisco and Hollywood. The prime purpose is the establishment of a frequency common to the gang for use in case of emergency. Some traffic is handled, but rag chewing is the main activity.

The Mid-South Amateur Radio Association has applied for the call W4USA for use in connection with a station at the amateur radio exhibit, Mid-South Fair, in Memphis, Tenn., the first week in September. This Association is also providing all-summer communication to Camp Currier, a Boy Scout camp 35 miles from the city of Memphis. There are no commercial communication facilities at the camp.

WMC/W4XCA Amateur Radio Program

"The Romance of Radio," a thirteen weeks' series of amateur radio programs, is being broadcast by WMC (780 kc.) and W4XCA (31,600 kc.) each Sunday at 3:30 P.M. C.S.T. The entire story of amateur radio is being presented in dramatic form, with all parts being taken by licensed operator members of the Mid-South Amateur Radio Association of Memphis, Tenn. Listen for WMC or W4XCA, and please drop a card to Station WMC, Memphis, Tenn., reporting reception of either station. The programs conclude on September 3d.

DJDC Contest

The Fourth Annual German DX Contest (DJDC) will be held the four week-ends of August, starting with the 5th. The contest runs each week-end from 1200 GT, Saturday, to 2400 GT, Sunday. Scoring is the same as in 1938, and reference should be made to page 43 of August 1938 QST for complete details.

PRIZES FOR BEST ARTICLE

The article by Mr. Dawkins Espy, W5CXH,* wins the C.D. article contest prize this month. Each month we print the most interesting and valuable article received marked "for the C.D. contest." Contributions may be on any phase of amateur operating or communication activity (DX, 'phone, traffic, rag-chewing, clubs, fraternalism, etc.) which adds constructively to amateur organization work. Prize winners may select a 1939 bound *Handbook*, *QST*, Binder and League Emblem, six logs, eight pads radiogram blanks, DX Map and three pads or any other combination of A.R.R.L. supplies of equivalent value. Try your luck. Send your contribution to-day!

One-Track Amateurs

BY DAWKINS ESPY, W5CXH*

ARE YOU a one-track amateur? Do you really get into the true ham spirit and enter lots of activities or are you like a tight-rope walker who can't see anything but the wire that he is walking on? Are you a traffic man who never has a rag chew or a contest man who never turns on the transmitter between go's, or a technical standstill who doesn't remember the line-up of the rig? Part of the amateur's code says that he should be "balanced" and this can well apply to his operating activities.

Of course it's nice to have your friends on one band but, for a night of real pleasure, operate an hour on each of the other bands and meet lots of interesting new people that you never knew existed. If the transmitter won't operate on those other bands, that indicates that the experimental part of your hobby has been seriously neglected, for once a transmitter is built you are not getting full returns from your investment unless you go to the slight additional cost and trouble necessary to make it operate on all bands. And if the lack of antenna space is your excuse, woe be unto you, for you are not a true ham if you can't make a 14-Mc. half-wave load up on 1.75 Mc., even though at reduced efficiency.

If your experimental nature is lacking, don't spend all of your available time working the rig, but rather try out a few of the new circuits occasionally and see how much pleasure you can get out of seeing that oscillator put twice as much grid drive into the buffer. And if you are lucky and have enough room to put up one decent antenna, don't be satisfied with it until you have tried ten others that don't work as well. If you have never had a QSO on 56 Mc. simply because you won't make the big rig work on "five," or won't build up the small amount of equipment necessary to enjoy "five," then you have missed the biggest thrill of all.

I often chuckle to myself when I hear someone say that he is only running 30 watts, so he never works any DX. Why it wouldn't be a bad bet to say that a large proportion of the DX stations worked are not using any more power than that; so when you say you don't have enough power to contact DX you mean enough "operating" power not "electrical" power.

If you belong to that group of 'phone men who can't do much better than receive their own call letters in code, why don't you call CQ C.W. once in a while? You'd be surprised what a confident feeling it is to know that you would recognize QRR if you heard it. Then, it's interesting to belong to a net and see the business-like manner in which organized groups work. If you are interested in emergency work, A.R.R.L. needs more Emergency Coordinators and members in the Emergency Corps. But for a real genuine week-end of excitement, nothing takes the place of an

* Phone Activities Manager, Louisiana, 2223 State St., New Orleans, La.

O.P.S. contest for the 'phone boys and an O.R.S. contest for the c.w. boys. Get in touch with your Section Manager if you are interested in O.P.S., O.R.S. or any other League appointment. If you have a fairly high power station and ten or more spare minutes a week, then you possess all the necessary requisites for an Official Broadcasting Station appointment. For those that want some definite indication of station accomplishment there are W.A.S., W.A.C., and the Century Club. If you take pride in your gift of gab, all you have to do is find some member of the Rag Chewers Club, talk with him for at least a half hour, and then both you and the other operator report the QSO to Headquarters in order for you to gain membership. For tops in operating ability, the A-1 Operator Club membership is awarded upon recommendation of two members. The old timer, if he were licensed twenty years ago, is eligible for the Twenty Year Club.

There are two outstanding contests each year sponsored by A.R.R.L. They are the DX Contest in March and the Sweepstakes Contest in November. The contests are so designed that a person with a full-time job can operate on an equal basis with the man that has all his time to spend on ham radio. The DX Contest is a measure of the station's ability to contact foreign stations, while the Sweepstakes Contest is a measure of the station's ability to contact domestic stations. If you have been missing these fine opportunities for measurement of station and operator efficiency, and real operating pleasure, don't let another contest slip by.

The annual A.R.R.L. Field Day, held each June, provides the opportunity to test your portable-emergency equipment at the same time you enjoy a good time "in the open." An amateur's education is not complete until he has participated in one of these intensely interesting and pleasurable affairs.

Amateur radio is becoming as well divided as most of the professions, so much so, that one can hardly expect to enter into all the fine phases provided; but most of us could get lots more out of our hobby if we just would put forth a little additional effort and not be a "one-track amateur."

The booklet "Operating an Amateur Radio Station," which is available from A.R.R.L. Headquarters (free to members, 10¢ to others), outlines in detail the many A.R.R.L. operating activities, awards and appointments. Every active amateur should have a copy in order to know how to get the most out of his operation, and how to avoid becoming a "one-track amateur."

— — —

BRIEFS

A net of amateur stations, whose operators are in the ranks of the Civil Aeronautics Authority, is being organized in the 7-Mc. band. This net, consisting of stations located in California, Arizona, Nevada and Utah, will operate on a spot frequency. Amateurs of the C.A.A. located in the states mentioned and interested in obtaining further information are urged to communicate with Irving E. Astmann, W6OMR, U. S. Airway Communication Station, Norden, Calif.

— — —

COLLEGE HAM NEWS

Zeta Chapter of Rho Epsilon at Montana State College boasts of new call letters W7HLX. Eta Chapter at Tri-State College held a "benefit show." W8NNI/9 has been operating at the chapter's NIPA station. Epsilon Chapter officers at Armour Institute of Technology for next fall include W9OYU, President, W9QYE, Vice-President, and W9SKF, Treasurer. Alpha Chapter members operated W7YH during W.S.C. open house, originating many messages. W7YH W.A.C.'d during the DX contest. W3FUR reports that 135 persons attended the University of Colorado's annual hamfest. Features were a hidden transmitter hunt, and a good feed. A W8 was heard on 56 Mc. by one of the mobile units. Station W2BXX of Brooklyn Polytechnic Institute was destroyed by fire. W7FEW is president of the W.S.C. Chapter of Pi Kappa Alpha Social Fraternity. W7ELN has been selected captain of the 1940 U. of W. track squad. Hams attending colleges or universities are invited to send "college ham news" to Nilo E. Koski, W7LD, National Secretary of Rho Epsilon Fraternity, 5822 E. Green Lake Way, Seattle, Wash.

Hamfest Schedule

July 30th, near Peoria, Ill.: An all-day hamfest will be held on Sunday, July 30th, under the auspices of the Peoria Amateur Radio Association. The reception committee will be on the grounds as early as 7:00 a.m. The location is on Route 150, about two miles north of Peoria. Signs will be posted at various points as an aid in locating the site. Come early and enjoy a full day of good hamfesting.

August 5th, 6th and 7th, at Jenny Lake, Wyo.: The seventh annual Jenny Lake Hamfest, otherwise known as the WIMU Hamfest (Wyoming, Idaho, Montana, Utah), will be held on August 5th, 6th and 7th. Jenny Lake is located near Moose, Wyo., at the foot of the Grand Teton Mountains. These WIMU affairs are always well attended and are strictly informal. Most of the gang bring their own camping equipment and eats. A limited number of cabins are available for those not wishing to camp out. All amateurs are invited and urged to bring along the YF and youngsters. There will be fun for all. Those desiring cabins should communicate with L. D. Branson, W7AMU, Casper, Wyo., regarding facilities.

August 6th, near Pittsburgh, Pa.: The South Hills Brass Pounders and Modulators' Sixth Annual Hamfest will be held this year at South Park, near Pittsburgh, at the Spreading Oaks Grove, August 6th. Excellent shelter, parking and dancing facilities are available. Registration, \$1.00. Don't miss this get-together. There is always plenty doing at the South Hills Hamfest!

August 13th, near Gallion, Ohio: A picnic and general

get-together for the "Ohio Regulars" (traffic net) will be held on Sunday, August 13th, at Sugar Grove Lake, near Gallion, Ohio. All amateurs who wish to meet some of the Ohio traffic gang are invited.

August 27th, near Chicago, Ill.: On Sunday, August 27th, at Frankfort Park, on U. S. Route 45, one mile north of U. S. Route 30 — just southwest of Chicago — the Hamfester's Radio Club of Chicago will conduct its Sixth Annual Hamfest and Picnic. The site selected is an excellent grove with the finest facilities for the event, including a baseball diamond and an enclosed dance pavilion. There will be the usual games and races and many other attractions. W9SXZ will defend his title as champion pie eater. There will be a complete trade show and an amateur show par excellence, a unique and different code contest and that intriguing game — Hammo.

The winning Hamfester Field Day Group will have one of its stations on the air . . . a chance to see the Model T "power house" and the collapsible 45-foot poles! Prizes will be on hand in profusion — to the tune of a value of \$1000 ham net. Refreshments will also be on "tap." The 1937 picnic had an attendance of 1600 persons. The 1938 affair was omitted in deference to the National A.R.R.L. Convention. This year provisions are being made for 2500. Tickets purchased before August 18th will be 30 cents, 40 cents thereafter. Requests for tickets should be sent to Robert LaGrau, 6624 Stewart Ave., Chicago, Ill. Give yourself a treat.

Be on hand to enjoy this big affair!

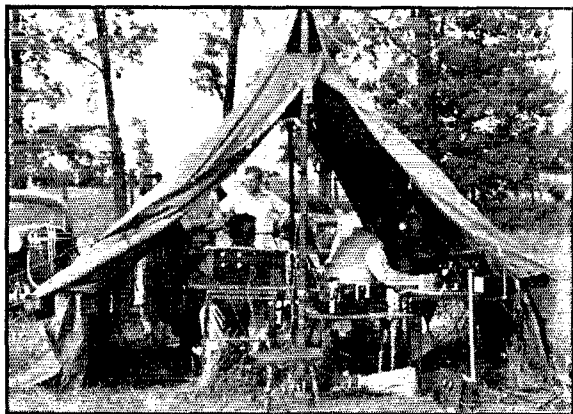

"CQ FD de W2OQ/2"

To the hundreds who participated in the A.R.R.L. Field Day activities, this scene will bring back memories of the eventful week-end of June 17th-18th. This particular shot is of W2ICO and W2DXO operating the two c.w. units of the Northern Nassau Wireless Assn. group, which operated at Glen Cove, N. Y., under the call W2OQ/2. It is a quite typical F.D. set-up.

It was the most successful Field Day ever held! From the standpoint of scores, early reports indicate that all records have been shattered. Although too early to state definitely, it appears that the Egyptian Radio Club, W9AIU/9, again took the lead with about 440 contacts, 5700 points!! Other high club groups reporting to date include the Jersey Shore Amateur Radio Assn., W2AER/2, 4293 (313 contacts); Bridgeport Amateur Radio Assn., W1JHT/1, 4005 (260 contacts); Tri-County Radio Assn., Inc., W2GW/3, 3762 (245 contacts); Northern Nassau Wireless Assn., W2OQ/2, 2907; Austin Radio Club, W9LTC/9, 2664; Suffolk County Amateur Radio Club, W2AVS/2, 2448; Beacon Radio Amateurs, W3ATR/3, 2421; K.B.T. Radio Club, W8NWH/8, 2205; Chester Radio Club, W3DGM/3, 2151; Steubenville Amateur Transmitter's Assn., W8CHE/3, 2079. Leading individual groups so far reported are W8QAN/3, 2439; W8BQ/8, 2203; W8NAB/8, 1971; W6NIK/6, 1817; W1EH/1, 1719; W8DS/8, 1656; W4RO/4, 1602; W9ARN/9, 1557; W9FPO/9, 1521.

O.B.S.

The following is a supplement to the list of A.R.R.L. Official Broadcasting Stations in October QST (page 71): W3EUH, W5MH.

Washington Amateurs, Attention!

"Bob" King, W7ETK, is leading a movement to secure amateur call letter automobile license plates in the state of Washington. He has printed a supply of petitions, ready for signatures, and will distribute them free to Washington radio clubs. Where no club is organized he will forward a petition to any town or city upon application by an individual licensed operator, for available signatures in that area. Club officials and other interested individuals should write immediately for petitions. Address W7ETK, 1704 South 56 St., Tacoma, Wash.

In recognition of their outstanding service to the city of Westerly, R. I., in handling hundreds of messages for that isolated community following the hurricane of September, 1938, the Western Union Telegraph Company, on June 25th, awarded to six radio amateurs specially designed Certificates of Public Service. The amateurs honored were Wilson E. Burgess, W1BDS, Edward A. Dolan, W1KCG, George W. Marshall, W1KRQ, and Gerald W. Mason, W1KRF, of Westerly, R. I.; and Clark C. Rodimon, W1SZ, and Byron Goodman, W1JFE, of West Hartford, Conn. The certificate presentation was made at Westerly by J. D. Feisenheld, W3MI, Director, Amateur Radio Relations, Western Union. Also present were Mr. Butler, Western Union superintendent, Providence, R. I., and E. L. Battley, W1UE, A.R.R.L. Assistant Communications Manager.

During the period April 28, 1930 through April 27, 1939, W5BMI made 23,495 contacts, all on c.w. — an average of 7.2 QSO's per day over the nine-year period

W9LLG at Eagle Butte, S. Dak., is operated by Helen Payne, YF of Jerry Payne, W9LMC. W9IYN, in Grant, Nebr., is operated by Henry Harding. On September 16, 1938, LLG, LMC and IYN were passing the time of day on 1.75-Mc. 'phone. LLG's sister, Mary Garth, was put on the mike at Eagle Butte and introduced to Hank (IYN). That started something. Mary, at LLG, and IYN set out to make a QSO record with 88's very much in the foreground. Pictures were exchanged. The postmen at Eagle Butte and Grant grew round-shouldered. Finally Hank couldn't stand the suspense any longer, and on May 15, 1939, arrived at Eagle Butte to see if it were really true. Apparently it was; he and Mary were married the following day at Rapid City, with LMC as best man and LLG as matron of honor!

—W9VOD, S.C.M., South Dakota.

W5NN, W8NN and W9NN can all be found blasting away within a few kilocycles of each other at the low-frequency end of 7 Mc.

W6HOE, who is located at the Monrovia, Calif., Fire Department, says his department claims the fire alarm heard at the greatest distance. He was in 'phone communication with VK5LW, one night, when the alarm went off. VK5LW reported reception was fine.

Chance for Hams on W.P.A.?

In Maine, radio instructors are being furnished for some of the C.C.C. camps by the W.P.A. To qualify a man must be on W.P.A. The pay is about \$60 per month, with board and room furnished, and the instructors eat and live with the officers. Several Maine amateurs have secured such positions. Requests for transfer in a similar capacity to C.C.C. camps in your area may be made via your local W.P.A. officials, or you may visit nearest C.C.C. camps and suggest they call on W.P.A. for instructor personnel.

F.C.C. Disciplinary Actions

On May 16, 1939, the Federal Communications Commission adopted order suspending the radio amateur license with Class "A" privileges of Freeman Lang, K6KRG, Honolulu, for a period of three months, because he left his amateur station under the control of unauthorized persons; he did not post his amateur radio station license or a facsimile thereof, and on March 24, 1939, a proper station log was not maintained at K6KRG of communications between that station, operated by certain unlicensed persons having control thereof, and amateur radio station W6JYH operated in Los Angeles, Cal., by the licensee of K6KRG, all in violation of the Commission's Rules.

The F.C.C. announced on May 2, 1939, that Andrew Gibbs Cochran, 17 years old, of Chicago, Ill., has been convicted as a delinquent under the Juvenile Delinquency Act for operating an unlicensed radio station in violation of Sections 301 and 318 of the Communications Act of 1934, as amended. The conviction followed disregard of previous warnings by the Commission.

Robert Rittinger, Alfred Boardman and Anthony Lucas, all of Chicago, were apprehended in early May, charged with operating unlicensed amateur radio stations. All three were held to the grand jury by United States Commissioner Edwin K. Walker. The result of the cases is not yet known. Members of the Chicago Area Radio Club Council were instrumental in tracking down at least one of these unlicensed operators.

Minnesota Police Net

The Minnesota State Bureau of Criminal Apprehension has requested the aid of an organized amateur radio network throughout Minnesota, and various cities in North and South Dakota. Bob Hall, W9CRO, of State Police station KNHD, has compiled a list of cities to be covered, and Dick Kirby, W9LCT, A.R.R.L. Route Manager, So. Minn., is undertaking the organization of this special net. Important traffic has been promised and the net will also originate a de-

Brass Pounders' League

(May 16th-June 15th)

Call	Orig.	Del.	Rel.	Extra Del. Credit	Total
W7EBQ	0	0	1929	0	1929
W6FWJ	430	444	44	440	1358
W2SC	26	106	820	202	1154
W9QIL	39	135	813	127	1114
W6LUJ	160	294	246	289	989
W3EML	56	151	428	141	776
W5DKR*	275	124	187	187	773
W6IOX	19	29	558	26	632
W5DAQ	186	148	129	129	592
W5BN	183	142	133	133	591
W3BWT	28	86	350	78	542

MORE-THAN-ONE-OPERATOR STATIONS

Call	Orig.	Del.	Rel.	Extra Del. Credit	Total
W5OW	179	196	892	105	1372

These stations "make" the B.P.L. with total of 500 or over. One hundred deliveries + Ex. Del. Credits also rate B.P.L. standing. The following one-operator stations make the B.P.L. on deliveries. Deliveries count.

W4BED, 242	W2JZX, 137	W6DH, 105
W2HMJ, 227	W6QCX, 122	W5EDY, 104
W3QP, 212	W7GP, 121	W2KWG, 103
W4AGI, 205	W1KIN, 118	W9ZFC, 102
W6ZX, 186	W1KH, 109	W6NTP, 101
W7APS, 184	W9LCT, 109	More-than-one-opr.
W5MN, 181	W5FDR, 108	W1AW, 132
W8QGD, 144		

A.A.R.S.

MORE-THAN-ONE-OPERATOR STATIONS

Call	Orig.	Del.	Rel.	Extra Del. Credit	Total
WLM (W3CXL)	139	117	2514	60	2830
WLXA	735	514	438	0	1687

A total of 500 or more or 100 deliveries Ex. D. Cr. will put you in line for a place in the B.P.L.

* All traffic handled on radiophone.

tailed daily weather report. Operators willing to cooperate are requested to communicate with W9LCT, 1149 First Street, S. W., Rochester, Minn., for complete details. There are many Minnesota cities not yet covered.

W6LMV is operating 28-Mc. 'phone aboard the yacht "Noname," entered in the trans-Pacific yacht race from Treasure Island to Honolulu. LMV planned to be on the air during the race and also during the return trip from the Islands, that is, until around September 1st. He is running 30 watts to an 807 on 28,530 kc. and is to be on the air daily from about 4:00 to 6:00 p.m. PST while under sail. Special QSL cards will be sent to all stations worked.

The Delaware Valley Radio Association's amateur radio display at the Trenton, N. J. Y.W.C.A. Hobby Show (May 10th-13th) created great general interest. The Association's station, W3AQ, was operated on all bands. Messages were handled and many visitors had their first opportunity to talk over an amateur radio station. Among those assisting W3GNU, who was in charge of the exhibit, were W3CCO, W3ZI, W3EUH, W3AFH, W3VE, W3HWO, W3FNL, W3HTJ and W3CFS.

We are informed, on reliable authority, that extra bronze Wouff-Hongs from the San Joaquin Valley Hamfest are available — as long as they last. They are the same size as those at the national convention (Chicago) but are of cast bronze. One can mount a mike on it. They are \$1.50 f.o.b. to any ham, long as they last. Write H. S. Walling, W6PPO, Box 933, Fresno, Calif. (The base inscription "SJV Radio Club Hamfest, Fresno Apr. 22" can be ground off on request.)

How's DX?

HOW:

This department calls attention to so many lousy practices in DX-ing that you've probably decided we're sour on the whole thing and gripe because we can't work anything. That's not exactly so — we just like to see games played by the rules — and we intend to pour it on every time we run into something in this DX game that bothers our not-too-sensitive proboscis.

Last month we told you about the Long Island K7 getting a YV contact. Now we have an angle that's worse, because it can do nothing but create bad feeling between W's and DX stations. FB8AB (yes, he's back) forwarded a letter from a well-known W in which the W takes FB8AB to task for not QSL-ing. The W accuses FB8AB of "bad sportsmanship" for not sending a card. We'd like to suggest that that's the wrong approach to squeezing a card out of a DX station, and we wouldn't blame FB8AB if he never sent a card to that particular W. We hope Paul doesn't get his impression of all W's from this one.

However, the depths of diplomacy were reached by the W (a near-local, we reluctantly admit) who, when he didn't get a card from VP7NT, threatened to write to the British government demanding that VP7NT's license be taken away because the VP refused a demand for a card. What a dimwit! The F.C.C. would no doubt take away the W's license if he didn't QSL everyone he worked — phooey. Both VP7NT and FB8AB have been mighty fine about sending cards to everyone, as far as we know, but how long they'll keep at it with cracks like the above from W's we don't know. So, even if you don't care personally what a DX station thinks of you, at least try to remember that your actions reflect on all W amateurs. And, fortunately, the large majority of them are pretty decent, or else we've been taken in rather badly.

One more item. Some months back everyone was knocking off OY4C and wondering whether or not he was a phoney. We carried a radiogram from the fellow (February, 1939, QST) in which he said he wasn't in Faeroes. Some cards came through from him recently, but they don't carry any address. We don't even know how to get in touch with him to find out what country he was in. However, since we know he wasn't in Faeroes and yet don't know where he was, we ask that you please do not send in his card for OY credit in the DXCC. Possibly someday we can find out where he was and at that time your card will be good for something. (Jeeves, bring me that copy of "The Enjoyment of Living.")



When HB9J visited the States a short while back, he was in good hands all the while. Here's Exhibit A, taken while Jean was visiting the HQ gang. From left to right: W2BHW, W2BJ, HB9J and W2AIW.

WHERE:

SURE, you think all we do is dig up nasty things to tell you guys, but it ain't so. We're happy to let you in on a little secret W1ICA passed along to us, if you'll promise not to be in too big a rush. Anyhow, from July 30th or 31st to August 5th, HB9CE will be in *Liechtenstein*, signing HB1CE. He plans to use 14,410 kc. and will have a T9 note. Nurses, doctors and ambulances will all be QRX You've been so patient that we're going to let you in on another little tid-bit. Maybe you've all worked American Samoa but, if you haven't, you'll be glad to know that Jerry Petranek, ex-W9SEC, ex-W3HWG, should be on from KH6 very shortly. His address will be Naval Station, Tutuila, U. S. Samoa You'll recognize our old touch when we tell you that the HI2AC who was on in the Contest, and whose alleged address we carried in this pillar, was a W6 operating in K4. That makes him a phoney and very much in the hair of the rest of us. K4FCV and HI7G gave us the lowdown W6POX heard a VR3WK (7220 T7) and wonders about him, as does W2LMN about TA1AA (14,410 T9), worked around midnight W7AYO heard that VR3WK about a week after working ZK1AR (14,425) and thinks the same guy was at the key both times. Quite likely a VK on a ship The gang is still knocking off ZB2B (14,140 'phone and c.w.). The address is R. Solly, P. O. Box 201, Gibraltar. The station belongs to the Royal Engineers (Signals) Club W9AZT worked a nice one, if OK; J9PK (14,410 T9), who gives his QTH as Juluit, Marshall Islands. KB6ILT (14,380 T9) had no dope on J9PK but said that J8PG (14,440 T8) is OK Cards for KC5C can go care of W8LCN. KC5C is not a ship but a European station still active in a country where they've temporarily suspended amateur operation W9LBB tells us YN9G (14,430 T8) is OK in Nicaragua. A QSO list is due here sometime from the guy W2GVZ grabbed his 126th when he worked UX1CP (14,400-14,300 T8) in Franz Joseph Land QSL to HR4CX (14,420 T8), care of W4DHG, according to W6LDD W4CEN says that VI4A/VI4W claims to be VS5AD working aboard a ship. Tom puts a big question mark after ZD9L (14,410 T9), who says his prefix is approximately correct. How quaint! CX2AJ's new address is Box 122, Montevideo G6RH worked FF3Q (14,390 T9) at 2000 GMT, who gave his address as Martin, 14 Ave. Foch, Dakar, French West Africa We don't know for sure about this LZ1AK (14,440 T9), but if we were the wagering type we'd offer 10-to-1 he's a phoney. Yes, and in spite of the fact that he gives his address as Melvin Jamison, Kamizak, East Greenland, that's what we'd also give on OX7AD (14,330 T7) Our platform during the next campaign will be "P.O.T.P." Derived from an old Broadway Indian legend, it means "Phooey On The Phonies."

WHAT:

SOME of the lads worry about the cards sent in for checking in the DXCC, so Joe Moskey asked us to tell you that cards are checked but once a month. The same goes for WAS. In the case of DXCC, the deadline is the last day of the month, which means that cards received on or before the 31st of July will be used for the September rating, and so on. Joe would like to run it more on a "short-order house" basis, but the large volume of cards makes this the only practical way. So bear with him, and remember that the so-and-so even treats us at HQ the same way.

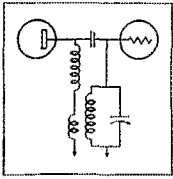

GETTING communication receiver performance on five meters is quite a problem, as we have been finding out this last year. It is not a project that we recommend for the home workshop, so whatever we have to say about the new NHU receiver on this page is not intended for the constructor.

Nevertheless, we did run into some interesting things. An oscillator of the grid tickler type proved much more satisfactory for the HF oscillator than the more usual types. It is very stable, and can be compensated for line voltage variations nicely. Also, the cathode is at ground potential, which helps a lot. Although it is not an "electron-coupled oscillator" it is actually electron coupled, because it is fed into the suppressor grid of the mixer tube where it modulates the electron stream.

We had to devise a new RF coupling arrangement, since the familiar types give very poor performance at high frequencies. The low-turn-primary RF transformer (such as is used in the SW-3) begins to lose its effectiveness at about 20 MC, principally because its impedance becomes too low to be a good tube load. The high-turn-primary transformer also goes haywire. As you know, it makes use of resonance between tube capacity and primary inductance to provide extra gain at the low frequency end of each coil range. The broad resonance peak obtained in this way does a nice job of compensating. However, at five meters, tube capacity is large enough to provide a comparatively high-C circuit, with fairly good Q, so that a sharp resonance peak is obtained at one fixed frequency. Also the natural resonance of the primary usually shows up somewhere in the coil range. The system used in the ten and twenty meter coils of the HRO gives excellent performance, as you doubtless know, and is much better than conventional circuits at high frequencies. But it did not give the kind of performance we wanted on five meters.

The circuit we finally worked out is shown above. It uses two separate closely-coupled primaries as well as a coupling condenser, and it works fine. The theory is too involved to give here, but the general idea is that there are several kinds of coupling present and if the system is worked out carefully enough it is possible to balance them against each other to obtain very high and uniform gain. The system is described in more detail in the NHU instruction book, and you can have a copy free for the asking.

We have two reasons for being so generous with instruction books. One is that when a receiver is bought, the purchaser is usually so anxious to get it on the air that he does not take the time to read up on it. So we would like to send the instructions on ahead. The other reason is that the more you know about the new NHU, the more we think you will want to own it.

While we are on the subject of receivers, we want to point out that the NC-101X amateur communication receiver is now also available with the direct reading dial used in the NC-100XA. The NC-101X is *not* being discontinued, however. Many operators prefer the PW micrometer dial, some like a direct reading dial. Take your choice.

DANA BACON AND WILLIAM LARKIN



No worries about Humidity with -

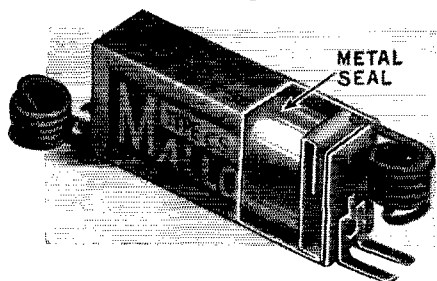

P. R. MALLORY & CO. Inc.

MALLORY CONDENSERS

On the Job!

The inside of a Mallory Replacement Condenser never makes the acquaintance of humidity or moisture because Mallory's perfected metal seal never lets them in. This heavy metal seal is around the actual condenser, and *inside* the carton as shown by the illustration.

This metal seal, together with the final sealing of the outside carton is so impervious to moisture that even immersion in flood waters has failed to affect or change its characteristics.

Yet this is only *one* feature of Mallory Replacement Condensers. If you are not using Mallorys you still have to meet up with some of the best condensers there are. Let your distributor know that you want all the dope right now.

P. R. MALLORY & CO., Inc.
INDIANAPOLIS INDIANA
 Cable Address—PELMALLO

Use

P. R. MALLORY & CO. Inc.

MALLORY

APPROVED RADIO PRECISION PRODUCTS

Use

YAXLEY

APPROVED RADIO PRECISION PRODUCTS

WHEN:

Isn't it a shame about 7 Mc.? Gosh, all W6OLU could scare up were J8CL (7150), J8CV (7200), J8CV (7135), J8CH (7110), J3EK (7150), J6CD (7220), J6DJ (7140), XU8WM (7140), XU8KO (7180), XU8NA (7230), KAIHQ (7140), KA3RA (7040), KB6OCL (7155) and PK1FK (7080), along with a flock of J2's and other XU's. Between 4 and 7 A.M. PST seems to be the time W6POX is another staunch supporter of 7 Mc., offering KB6ILT, HR4AF, and a 2½-hour rag-chew with ZL2MM as evidence.

There are still a lot of brass rings to be had on the merry-go-round called the 20-meter band. W4CEN says around 0230 GMT is a good time for VU7BR (14,340 T9) at Bahrein and 0300 is the time for ZC6RL (14,335 T9). Other stuff is LX1RB (14,330 T6) maybe, VS6's in the morning EST between 6 and 7, and MX1A (14,405 T6) W2GVZ passes along VQ2GW (14,360), ZD2C (14,325) and VQ2BI (14,300) W4FTJ adds HPLX (14,380 T9), VK9RM (14,300 T9), VK9VG (14,375 T9), KAIER (14,280 T9) and J2IX (14,400 T9) W6MUS submits SP1YX (14,420 T7), VP7NT (14,410 T8), SPIKM (14,415 T7), CE3CB (14,405 T7) and D3CDK (14,410), while W5AVF pops up with J6DV (14,310 T9), VK9DK (14,310 T9) and KAIHR (14,285 T9) W7AYO has CT1JS (14,410), VQ8AF (14,300), KA7EC (14,350), PY5QJ (14,405), FA8BG (14,410), CR7AF (14,300), CT1ZZ (14,405) and J8CH (14,360), and W4BPD's fine list includes VS2AL (14,390 T9), VS2AE (14,375 T9), KD6QH (14,385 T9), PK1TM (14,375 T9), XU8MI (14,350 T9), and ZELJS (14,360 T9), all in the morning between 6 and 8:30 Depend on W6SN to knock them off anytime he gets on: CPLXA (14,430), G16WG (14,360), HB9AW (14,440), HK2BL (14,410), CR7AK (14,360), YP1DM (7150), HH2EH (14,400), ZE2JC (14,300), who is ex-ZS4T; LIIR (14,400), G15QX (14,380), VQ8AS (14,340) and CR4HT (14,400) At W1RB, it's U1BL (14,400), VK9XX (14,280), UK5CO (14,410) and LX1MB (14,420) W2KUW has VQ4RH (14,310 T8), UK5KJ (14,420 T7), I1ZZ (14,410 T9), YT7VN (14,420 T8) and J3DF (14,410 T9), while W2KIK adds YV5ABQ (14,250), VP1JR (14,420), PJ3CO (14,270), and HH2MC (14,395) W2HHF scares it up as usual: CR4MM (14,405 T6), CR7BC (14,320), K7GFY (14,380 T8), VS6AX (14,380 T9), XU2AU (14,400), SU5AA/P (14,360), MX3C (14,380), J5CX (14,290) and ZELJN (14,360 T8) At W9YFV: KAIMN (14,375 T9), XU6ST (14,340 T8), U9ML (14,450 T9), XU8HM (14,360 T8) and KAI5P (14,405 T9) W6MUS adds VP1BA (14,415 T7), U3CY (14,410 T7), HK1AE (14,350 T9) and G16TK (14,360 T6) A new beam brought J2NG (14,390 T9), J5DC (14,410 T9), J8CD (14,400 T9) and a flock of other stuff to W9NTA.

'PHONE:

G5RV SAYS VS7RA (14,280) is quite consistent, and he has also worked VP6LN, VU2FA, OA4AW, ZS1AX, ZS2X, EK1AF, ZB1E, VQ2CM, SU5BO, CX2CO and CR7AK CN8AG heard a ZK1AA (14,040) during the Contest We hear that YL2CD will be on 14,040 on Sept. 10th, 17th and 24th, at 05 GMT and on 28,080 on Nov. 12th and 19th, at 15 GMT W6IDY rises to the defense of the 'phone contingent, claiming that they're all too modest, and admits that if he weren't modest he'd tell about CN8BB (14,070), PK6OM, VS2AL, G6RH, G8TD, G12CC, GM2UU, ZS2BJ, J2KN, G8IL, ZS2AV, J8CI, PK2LZ, GW3JI, XU6KL, and a flock of others, all in the low end of 20 W5EYZ feels much the same way, but we grilled him and got him to admit to KA2OV, VK2AJK, G2AV, VK7CL, F8NT, PY2BA, ZS4H, CE3CG, OA4R, PK6XX, VK9VG, CT1QA, ON4DI, PK3WI, and a host more. F8RV, CN8BA, J2GR, VK2AIU, W5FAB and YV4AX gave him a 4½-hour WAC one morning between 1:15 and 5:45 W6MGZ was in a real DX round-table QSO the other morning when KAI1CW, KAI1AF, KAI1B, KAI1M, KA7HB, XU8RB, W9BBU and MGZ got together. The contact lasted for two hours, with good signals all around. Earl says to look for F1NC (14,075) and PK1RI (14,030) Well, now that the 'phone reports are — ahem! — rolling in, we'd like to see frequencies on a few more of the rarer stations, to help the gang along.

"HQ-120-X"

With BUILT-IN
VOLTAGE REGULATOR

For
GREATER
STABILITY

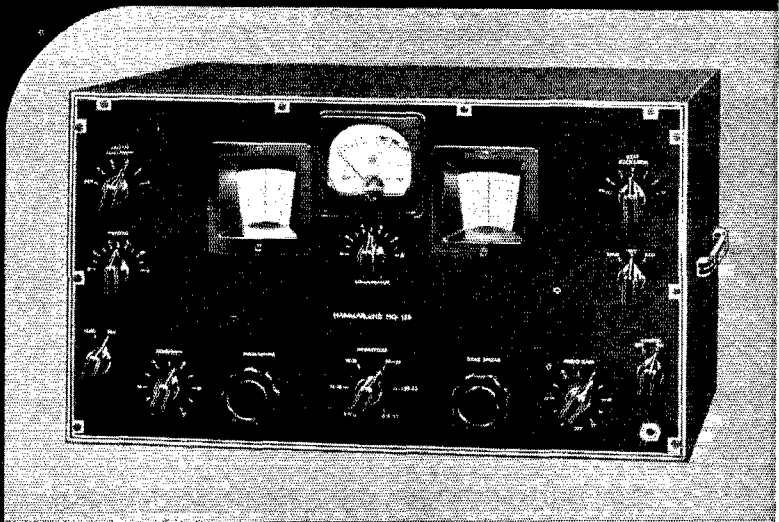

FOR IMPROVED STABILITY, the "HQ-120-X" has a built-in voltage regulator to maintain constant voltage to the high frequency oscillator. Sudden changes in line voltage do not cause oscillator frequency shift. The voltage regulator also eliminates frequency shift during reception of rapidly fading signals, with the AVC system in operation. Fading signals cause a wide change in plate current of the tubes controlled by the AVC system and this change is reflected in a change in oscillator plate voltage which in turn shifts the oscillator frequency. That is why it is difficult to hold rapidly fading signals with a very selective receiver. The voltage regulator in the "HQ-120-X", however, eliminates oscillator voltage variation. Voltage regulation becomes extremely important when the crystal filter is used for phone reception. The additional selectivity, due to the crystal filter, requires much greater stability because a slight shift in oscillator frequency will result in considerable distortion.

The "HQ-120-X" is a HAM receiver and has every modern feature that will increase the enjoyment of amateur operation. Try an "HQ-120-X" and note the smooth action of the crystal filter, accurately calibrated bandspread dial, improved noise limiter, and its many other features that make it a perfect receiver. Send for 16-page booklet!

HAMMARLUND MFG. CO., INC.

424 W. 33 St., New York

Canadian Office: 41 West Ave. No., Hamilton, Ont.



HAMMARLUND

A New CARDWELL ULTRA HIGH FREQUENCY Transmitting Condenser Series

These seven new "N" types complete a series of 10 models in this efficient line of medium power transmitting condensers for 5-10 and 20 meters.

Built right — priced right, Cardwell "N" types will make your new U.H.F. job look better and work better.

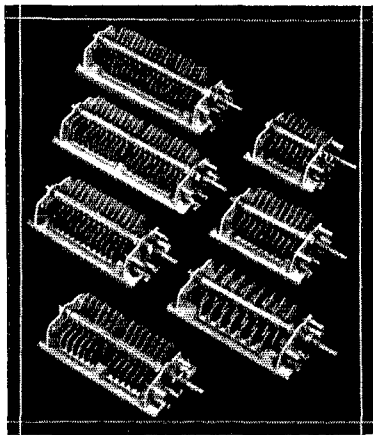

Specifications of "N" TYPE U.H.F. SERIES

FRAME — No frame or tie rods. Aluminum end plates supported directly on heavy lateral ceramic bars which carry stators.

SHAFT — 1/4" cadmium plated steel on which rotor assembly is securely locked.

PLATES — Aluminum alloy .040" thick with edges rounded and buffed.

BEARINGS — Long Nickel Plated brass shoulder type front bearing, with ball thrust rear bearing. Laminated phosphor bronze rotor contactor.

AIRGAP — .070" — 3000 V. peak — (NT)
.084" — 4200 V. peak — (NP)
.171" — 6000 V. peak — (NG)

INSULATION — Alsimag No. 196.

MOUNTING — Single hole, front panel with mounting posts or chassis mounting on feet which form part of end plate. Or use type "M" bracket and mount upside down for lowest capacity to ground.

ULTRA HIGH FREQUENCY SINGLES

Type Number	Cap. Range	Nr. Plates	Airgap	*Dimension "A"	Net Price
NP-50-DS	50-9	13	.084"	2 1/2"	\$2.10
NP-75-DS	75-11.0	19	.084"	3 1/16"	2.46
NP-100-DS	100-13	25	.084"	4 1/4"	2.82
NP-150-DS	150-19	39	.084"	5 3/8"	3.66
NG-35-DS	35-11	15	.171"	4 1/2"	3.12

ULTRA HIGH FREQUENCY DUALS

Type Number	Cap. Range	Nr. Plate Per Section	Airgap	*Dimension "A"	Net Price
NT-50-GDI	50-7	11	.070"	3 1/16"	\$3.60
NP-35-NDI	35-5	9	.084"	3 1/16"	3.60
NP-35-DD	35-5	9	.084"	3 1/16"	3.21
NP-50-DD	50-9	13	.084"	4 1/4"	3.60
NP-75-DD	75-11	19	.084"	5 3/8"	4.32

*Dimension "A" is distance between inside faces of end plates. For overall length back of panel, add 1 3/32" to "A" dimension.

‡.025" plates, buffed and polished.
‡.040" plates, buffed and polished.

WHO:

P22SU is NOT a phoney — QSL via W4CCH or A.R.R.L. No doubt you can guess who he is
G5RV (14,800 T8) needs only Arizona for WAS, after grabbing W6QQ (14,300) for Nevada and W7E2C (14,280) for Wyoming. He's on regularly from 05-08 GMT
W7GXR is pleased to represent Idaho most any day from 7:10 P.M. local time, on 14,045 or 14,360
W1DQ says that G6IA is coming to the U. S. in July, and will bring over 1000 cards with him. (Gosh, Jeeves, I hope you didn't mail that nasty letter I wrote)
W2IYO earned himself the rep of a "ladies' man" when he worked ZS1DB to complete a YL WAC
W3EVW isn't really sore, but he wishes that the guy who's bootlegging his call on 7 Mc. would work something besides W2's, else EVW's DX reputation may suffer
You can stop looking for V86BF now. We heard that the *Pang Jin* sank in the Red Sea while being towed by a Greek steamer. Fortunately, all hands were saved
W6OMR says that W6PCK will be operating portable in the Bering Sea this summer, on 7020 and 14,040 kc. He works with a bug consistently, so you might get out the old wrist oil
W9QIY, ex-9RWE, made his WAC with a single 807 final
Fred Elser now has three WAC certificates: W3LQW, W1KOM from last year, and pi3AA (Philippines to you) in 1926
W2GVZ is really going long-hair on us, and his Maebeth quotes like this: "DX doth murder sleep" and "Uneasy lies the head that wears the cans." *DX vobiscum!*
— *IF1JPE*

A.R.R.L. Official Observers

IN THE past few months, many amateurs have had occasion to thank O.O.'s for helpful notifications or opinions concerning harmonics, or transmitter adjustment. There has been something approaching an epidemic of "harmonics" this past season. It called for some special bulletins to Observers at the height of the season, asking for renewed attention to frequency measurement and notifications — and thanks to the unselfish efforts of this group, hundreds of amateurs were called upon personally to examine their transmitter adjustments, and correct improper conditions that were dangerous both to the individual and the fraternity.

Observers are glad to help over-the-air as well as through mail notices, if you will call upon them. Some (depending on their equipment) specialize in frequency measurement, some in calling attention to improper broadness of signals, a.c. notes, poor spacing, over-modulation, bad speech quality, procedure, instability, etc. We are pleased to list herewith all Observers in the nationwide system appointed to date, so that amateurs may call upon them, ask frequency measurement or other checks more often, etc., for the general good of amateur radio.

W1ARB	W2GJL	W4EBZ	W7GP	W9CWW
W1AVC	W2GRG	W4MS	W8AJJ	W9DUD
W1AVP	W2HDJ	W5AIR	W8AVK	W9ENF
W1AXN	W2HYL	W5APW	W8BFF	W9FR
W1BHM	W2HZR	W5AZB	W8BLH	W9GBZ
W1BJP	W2LXQ	W5BKH	W8BQ	W9HEN
W1BMW	W2JHB	W5DAQ	W8BWW	W9HEO
W1DDY	W2JKQ	W6AK	W8CIO	W9HHS
W1DVW	W2KJY	W6BQI	W8CKO	W9JNU
W1EAO	W2JH	W6BVK	W8CO	W9JVF
W1FL	W2VH	W6CFN	W8DGL	W9KEF
W1FZH	W3AME	W6CZ	W8GJM	W9KHC
W1GAG	W3AXU	W6DFO	W8IBR	W9KUI
W1GHT	W3BEI	W6BAH	W8JEX	W9LEZ
W1IF	W3XL	W6FW	W8KX	W9QXC
W1IB	W3EFP	W6GM	W8OGK	W9RO
W1IIT	W3ERW	W6ITH	W8OJL	W9RSO
W1JDP	W3EMX	W6IKJ	W8PUN	W9RZA
W1JTD	W3EPU	W6KEO	W8PWW-9	W9SJK
W1KIN	W3FRY	W6LD	W8QGD	W9SVH
W1LN	W3EZ	W6LLW	W8ADN	W9SYI
W1VP	W3GY	W6PSQ	W8AFO	W9WTD
W2AZV	W3HXQ	W6QA	W8ARE	CM2WW
W2B2T	W3UVA	W6QAP	W8AYH	VE2AB
W2ZF	W3VF	W7CJR	W8BEZ	VE3MB
W2GDF	W4ABS	W7CQK	W8BPU	VE4HM
W2GFW	W4ASR	W7CTA	W8BRX	
	W4COT	W7EMT	W8CWI	

Langley Field, Va. (U. S. Air Corps) has seventeen amateur stations operated by Langley Field personnel. Count 'em: W3AW, BED, BJE, ELJ, EZH, EZY, DRK, GON, GTS, HCC, HDQ, HEN, HWJ, HXD, HYA, HZU, IBO. And the lads say they have no serious QRM!

**THE ALLEN D. CARDWELL
MANUFACTURING CORPORATION**
83 PROSPECT STREET, BROOKLYN, NEW YORK

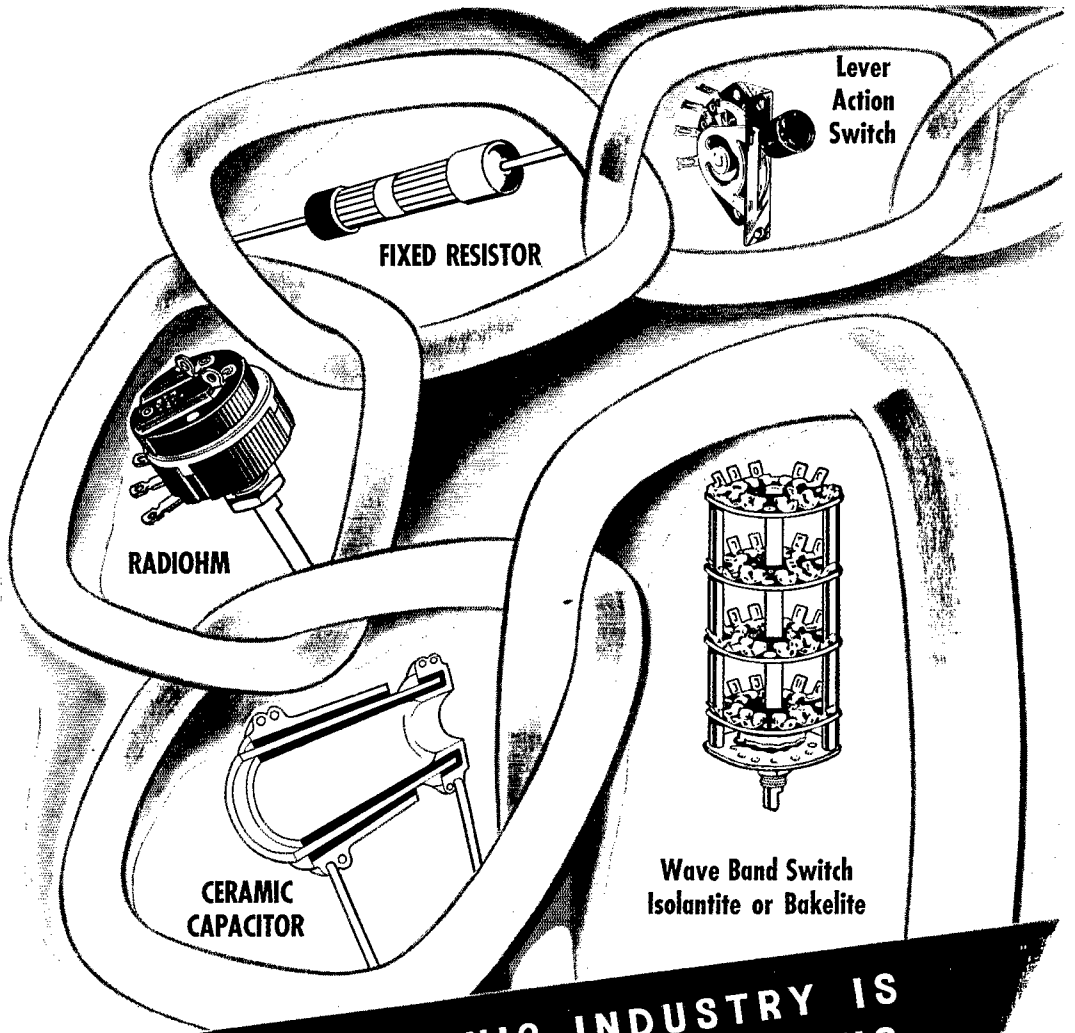

FIXED RESISTOR

Lever
Action
Switch

RADIOHM

CERAMIC
CAPACITOR

Wave Band Switch
Isolantite or Bakelite

**THE ELECTRONIC INDUSTRY IS
LINKED WITH THESE FAMOUS
PRODUCTS by CENTRALAB**

New developments; some ephemeral and visionary; many sound and practical, are breaking on the horizon. And today, as in the past, Centralab plays an impor-

tant part in the electronic industry—in the designing laboratories of manufacturers — on the benches of experimenters — in the "trouble-shooting" service-man's kit

and in tiny ham shacks. For wherever Quality, Dependability and Reliability count . . . there Centralab serves supreme. For sound or sight . . . CENTRALAB.

CENTRALAB DIV. of GLOBE-UNION INC., Milwaukee, Wis.

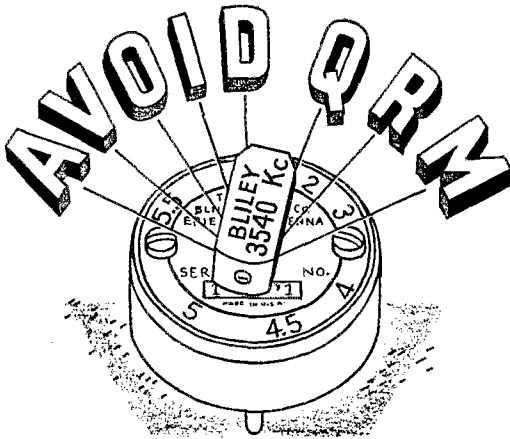

BY FREQUENCY SELECTION

The ability to shift your transmitter frequency for dodging QRM often means the difference between a successful QSO and an incomplete contact. With the Bliley VF1 Variable Frequency Crystal Unit, you can instantly change your frequency simply by turning the control knob. And, because the VF1 unit affords full crystal control at all frequencies within its adjustable range, stability is maintained without the necessity of resorting to complicated equipment.

The specially finished crystal in the VF1 Unit has a drift of less than 4 cycles/mc./°C. It will directly replace fixed frequency crystals now in use where adequate power output is realized from the oscillator stage. The total frequency variation obtainable is approximately 6kc. with the 80-meter unit and 12kc. with the 40-meter unit.

Don't let QRM cripple your transmitter — purchase a VF1 Crystal Unit from your Bliley Distributor and choose clear channels by selecting your frequency.

Type VF1 40-Meter Crystal Unit, minimum frequency ± 15 kc. of specified \$7.50

Type VF1 80-Meter Crystal Unit, minimum frequency ± 5 kc. of specified \$7.50

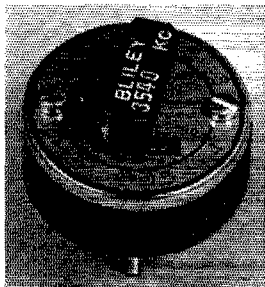

BLILEY TYPE VF1 VARIABLE CRYSTAL UNIT

MEMBERS, DX CENTURY CLUB

G6WY (No. 5).....	144	PA0XF (No. 43)....	109
W8CRA (No. 1).....	142	W4CYU (No. 78)....	109
W6GRL (No. 15)....	142	W3DDM (No. 72)....	109
W2GTZ (No. 12)....	139	W2BYP (No. 102)...	109
W2GT (No. 32)....	139	W6HX (No. 21)....	108
W1SZ (No. 7).....	137	W8BKP (No. 65)....	108
W1TW (No. 3).....	136	W1HX (No. 119)....	108
W2GW (No. 11)....	135	W2AAL (No. 81)....	107
W3EMM (No. 58)....	134	VE2AX (No. 84)....	107
W8DFH (No. 14)....	133	W1DUX (No. 82)....	107
W6CXW (No. 4)....	132	G5BJ (No. 93)....	107
G2ZQ (No. 6).....	132	G2DH (No. 101)....	107
W6KIP (No. 28)....	132	W9UM (No. 108)....	107
W1TS (No. 9).....	130	W1ADM (No. 110)....	107
ON4AU (No. 40)....	130	G2TR (No. 83)....	106
W8BTI (No. 56)....	129	W1CH (No. 91)....	106
W1LZ (No. 10)....	128	W2OA (No. 73)....	105
W9TJ (No. 67)....	128	W4DRD (No. 94)....	105
W4BPD (No. 70)....	128	G5QY (No. 103)....	105
G6RH (No. 36)....	127	W1AXA (No. 104)....	105
W2BHW (No. 39)....	127	E1SF (No. 19)....	104
W8DHC (No. 27)....	126	W1ZB (No. 62)....	104
W5BB (No. 37)....	126	W2CBO (No. 86)....	104
W2CMY (No. 68)....	126	F8RR (No. 98)....	104
W3CHE (No. 87)....	126	W3AG (No. 107)....	104
HB9J (No. 13)....	125	W6TJ (No. 114)....	104
W9ARL (No. 18)....	125	W6FZY (No. 115)....	104
W8OSL (No. 23)....	125	W3BES (No. 121)....	104
W1DF (No. 29)....	124	HB9BG (No. 127)....	104
W2LUF (No. 33)....	124	G6KP (No. 45)....	103
W1FH (No. 71)....	124	W8KKG (No. 109)....	103
W3EPV (No. 74)....	124	WK2DG (No. 112)....	103
W2HHF (No. 54)....	123	W1BGY (No. 128)....	103
W4CEN (No. 60)....	122	ZS2X (No. 124)....	103
W8ADG (No. 63)....	122	W4CBE (No. 20)....	102
W8LEG (No. 25)....	121	W1WV (No. 69)....	102
W8OQF (No. 30)....	121	W1FTR (No. 123)....	102
W5VU (No. 38)....	121	F8RJ (No. 8)....	101
W8DWV (No. 17)....	120	VK3JK (No. 57)....	101
J5CC (No. 46)....	120	W4AJX (No. 75)....	101
W1BUX (No. 2)....	118	W6DOB (No. 76)....	101
W9KG (No. 16)....	118	SUIWM (No. 89)....	101
W9ADN (No. 61)....	117	W8EUY (No. 97)....	101
W9PST (No. 35)....	117	W1CC (No. 106)....	101
D4AFF (No. 99)....	117	SUISG (No. 117)....	101
W7AMX (No. 26)....	116	J2JJ (No. 125)....	101
W9GDH (No. 41)....	116	W5CUJ (No. 130)....	101
W3EDP (No. 53)....	116	VK3CX (No. 134)....	101
W3EYV (No. 55)....	116	W6AGH (No. 140)....	101
W9FS (No. 77)....	116	W1GCX (No. 142)....	101
W8JMP (No. 22)....	115	G6NF (No. 105)....	100
W6ADP (No. 34)....	115	W2AER (No. 111)....	100
W9EF (No. 44)....	115	W6KRI (No. 113)....	100
W2CYS (No. 52)....	115	W9UQT (No. 116)....	100
ZL1HY (No. 59)....	115	W8AU (No. 120)....	100
W1JPE (No. 66)....	115	W8OXO (No. 122)....	100
W8NJP (No. 90)....	115	G6MK (No. 132)....	100
W9KA (No. 42)....	114	VE2EE (No. 133)....	100
W2GVZ (No. 80)....	114	W2BXA (No. 135)....	100
W9TB (No. 95)....	114	G2MI (No. 136)....	100
G5RV (No. 64)....	113	W3BEN (No. 137)....	100
W8MTY (No. 129)...	113	W8IWI (No. 138)....	100
W2JT (No. 131)....	113	VK2ADE (No. 139)....	100
VK5WR (No. 49)....	112	W1GDY (No. 141)....	100
W6GAL (No. 50)....	112	W8QXT (No. 143)....	100
W3EVT (No. 51)....	112	VE3QD (No. 144)....	100
W3FRY (No. 85)....	112	ZL1GX (No. 145)....	100
W2ZA (No. 88)....	112	HB9CE (No. 146)....	100
W5KC (No. 92)....	111	HB9X (No. 147)....	100
W3GAU (No. 96)....	111	W9CWW (No. 148)....	100
G5BY (No. 118)....	111	W2GRG (No. 149)....	100
G6CL (No. 24)....	110	W7DL (No. 150)....	100
ON4UU (No. 31)....	110	W9RCQ (No. 151)....	100
W2CJM (No. 47)....	110	W1ICA (No. 152)....	100
W6FZL (No. 48)....	110	W2IOP (No. 153)....	100
W2DC (No. 79)....	110	W3KT (No. 154)....	100
W2DSB (No. 100)....	110	W4MR (No. 155)....	100
G5BD (No. 126)....	110	W1ZI (No. 156)....	100

The following have submitted proof of contact with 75-or-more countries: G3BMP, PA0QF, W6GHU, W9AJA 99; W1BXC, W4CCE, W8HGUY 98; G6GHI, W1BY, W3ZX, W8DOL 97; W3GHE, W5ASC, W8AAJ, W8BOX 96; F88AB, G6XL, W1GNE, W4EQK 95; W8CJQ 94; PA0QZ, VK6SA, W2ALO, W3EMA, W8BAM, W6FKZ, W8SBF 93; W2BMX 92; W2CTO, W8QDU, W9RBI 91; G6VE, LU7AZ, W3AIU, W6MVK, W8KTW 90; G6ZO, W2BJ, W3OP, W6TT 89; G2DZ, W3AOG, W3JM, W8JAE 88; SP1AR, W9AEH 97; W3ELH, W4DMB, W8LFE, W8IQB, W9LEH 86; W4CFD, W6GK, W8LAV 85; G8IG, SM6WL, W2CUQ, W3AGV, W8BWB, W9OVU 84; OZ7CC, W1BFT, W2AWF, W6GPE, W8BFG, W9BLZ 83; W1AVK, W1EWD, W3AYS, W8KUT 82; SP1LP, VE2GA, W2WQ, W8DAE 81; VE2TI, W2BNX, W8BYN, W3EPR, W6LJD, W8AAT, W8DGP, W9GMV 80; W3GHD, W8JFC, W9MRW, W4TZ 79; W6AM, W8FJN 78; G3BD, W2BZE, W4EPY, W8OKH 77; W8VK, PA0JMW, W1BGC, W2ELG, W8SB, W6TBB, W8LZB, W9LCS, W111 76; D3CSC, VK3HG, W1DOV, W4OG, W8JDP 75. Radiotelephone: W4CYU 86; W6OCH 84; W2IXY 83.

*First in theory . . . First in practice
First in the "rigs" of radio "hams"*

EIMAC 75T

Only one month old—but the most talked of tube ever introduced to the amateur. Thousands have acclaimed their approval. Low voltage operation with an extremely high power output is the factor that has made this tube such a favorite.

**450 WATTS OUTPUT . . . ON 5
METERS WITH A PAIR OF 75T's &
ONLY 2000 VOLTS ON THE PLATE**

● This performance is in keeping with all Eimac tubes, but at a vastly lower voltage than ever before. 75T is a "natural" for class "B" audio, using the new gas-filled regulator tubes for bias. 1500 volts on the plate with a VR-150-30 for bias gives 300 watts of class "B" output. 1100 volts on the plate with a VR-105-30 gives 225 watts. Static characteristics of the 75T are similar to the 211 types which makes it ideal for low voltage, high power operation.

This is the tube that amateurs have always needed; the tube that will convert an old "rig" into a modern transmitter. Go to your dealer's and inspect the new 75T—see the new heat shield—the new radical shape. Get your copy of the folder covering its characteristics, but, most important of all, install 75T's in your transmitter and get more results with a low voltage on the plate than you've ever had before.

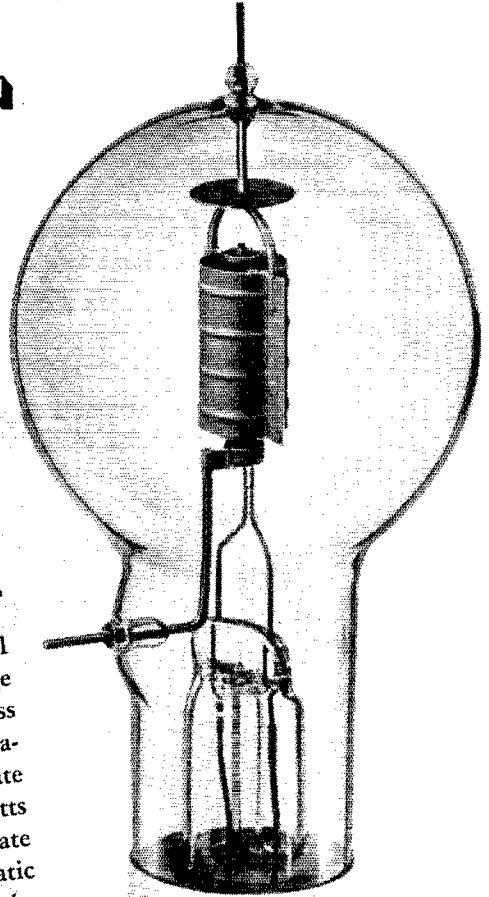

Eimac
TUBES

EITEL-McCULLOUGH, INC., San Bruno, California

There's an "MC" behind every QSO!

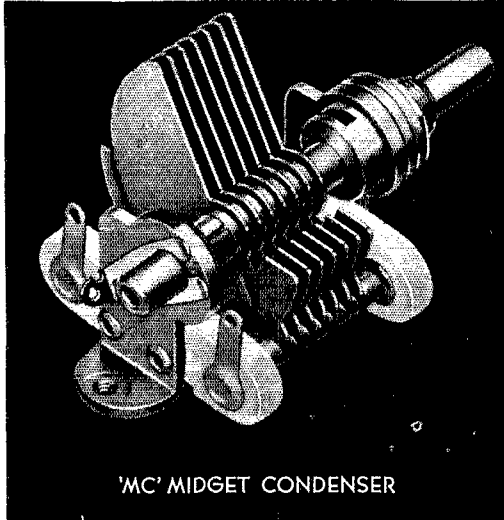

MC MIDGET CONDENSER

HAMMARLUND'S "MC" midget variable condensers have found universal application in amateur receivers, transmitters, monitors and frequency meters. Their thoroughly rugged construction and small size have made them leaders in their field. The type of construction employed in the "MC" makes it suitable for use in ultra-high frequency apparatus. There are no shorted turn effects because there is no frame-work to cause such losses. Heavy brass plates are soldered in place for low contact resistance and they are insulated with pure Isolantite treated against moisture absorption. There are 30 types in the "MC" line to cover every conceivable amateur or laboratory requirement.

SEND FOR "39" CATALOG!

HAMMARLUND MFG. CO., INC. Q-8-39
424-438 W. 33d St., N. Y. City

Please send me new "39" catalog.

Name.....

Address.....

City..... State.....



HAMMARLUND

Canadian Office: 41 West Avenue No., Hamilton, Ont.

ELECTION NOTICES

To all A.R.R.L. Members residing in the Sections listed below:
(The list gives the Sections, closing date for receipt of nominating petitions for Section Manager, the name of the present incumbent and the date of expiration of his term of office.) This notice supersedes previous notices.
In cases where no valid nominating petitions have been received from A.R.R.L. members residing in the different Sections in response to our previous notices, the closing dates for receipt of nominating petitions are set ahead to the dates given herewith. In the absence of nominating petitions from Members of a Section, the incumbent continues to hold his official position and carry on the work of the Section subject, of course, to the filing of proper nominating petitions and the holding of an election by ballot or as may be necessary. Petitions must be in West Hartford on or before noon of the dates specified.
Due to a resignation in the Alaska Section, nominating petitions are hereby solicited for the office of Section Communications Manager in this section, and the closing date for receipt of nominations at A.R.R.L. Headquarters is herewith specified as noon, Friday, September 1, 1939.

Section	Closing Date	Present SCM	Present Term of Office Ends
Oklahoma	Aug. 15, 1939	Carter L. Simpson	Aug. 23, 1939
Idaho	Sept. 1, 1939	Carl Eichelberger	June 15, 1939
Alaska	Sept. 1, 1939	Leo E. Osterman (resigned)
Nevada	Sept. 1, 1939	Edward W. Heim	June 14, 1937
Philippines	Sept. 1, 1939	George L. Rickard	Oct. 15, 1938
Indiana	Sept. 1, 1939	Noble Burrhart	April 15, 1939
Md.-Del.-D. C.	Sept. 1, 1939	Edgar L. Hudson	July 15, 1939
Eastern N. Y.	Sept. 1, 1939	Robert E. Haight	Sept. 16, 1939
Eastern Fla.	Oct. 2, 1939	L. A. Connolly	Oct. 15, 1939
Missouri	Oct. 2, 1939	Letha Allendorf	Oct. 19, 1939

In Canadian sections nominating petitions for Section Managers must be addressed to Canadian General Manager, Alex Reid, 169 Logan Ave., St. Lambert, Quebec. To be valid such petitions must be filed with him on or before the closing dates named.
1. You are hereby notified that an election for an A.R.R.L. Section Communications Manager for the next two-year term of office is about to be held in each of these Sections in accordance with the provisions of the By-Laws.
2. The elections will take place in the different Sections immediately after the closing date for receipt of nominating petitions as given opposite the different Sections. The Ballots mailed from Headquarters will list in alphabetical sequence the names of all eligible candidates nominated for the position by A.R.R.L. members residing in the Section concerned. Ballots will be mailed to members as of the closing dates specified above, for receipt of nominating petitions.
3. Nominating petitions from the Sections named are hereby solicited. Five or more A.R.R.L. members residing in any Section have the privilege of nominating a member of their Section as candidate for Section Manager. The following form for nomination is suggested:

(Place and date)

Communications Manager, A.R.R.L.
38 La Salle Road, West Hartford, Conn.

We, the undersigned members of the A.R.R.L. residing in the Section of the Division hereby nominate as candidate for Section Communications Manager for this Section for the next two-year term of office.

(Five or more signatures of A.R.R.L. members are required.)
The candidates and five or more signers must be League members in good standing or the petition will be thrown out as invalid. Each candidate must have been a licensed amateur operator for at least two years and similarly a member of the League for at least one calendar year, immediately prior to his nomination or the petition will likewise be invalidated. The complete name, address, and station call of the candidate should be included. All such petitions must be filed at the headquarters office of the League in West Hartford, Conn., by noon of the closing date giving for receipt of nominations. There is no limit on the number of petitions that may be filed, but no members shall sign more than one.
4. Members are urged to take initiative immediately, filing petitions for the officials for each Section listed above. This is your opportunity to put the man of your choice in office to carry on the work of the organization in your Section.

— F. E. Handy, Communications Manager

ELECTION RESULTS

Valid petitions nominating a single candidate as Section Manager were filed in a number of sections and, as a result, the Constitution and By-Laws, electing the following officials, the term of office starting on the date given.

Maine	H. W. Castner, W1HE	June 7, 1939
North Dakota	Anton C. Theodos, W9WWL	June 14, 1939
Northern Minnesota	Edwin Wicklund, W9IGZ	June 15, 1939
Northern Texas	Lee Hughes, W5DXA	June 15, 1939
Sacramento Valley	Vincent N. Feldhausen, W6MDI	June 15, 1939
Iowa	L. B. Vennard, W9PJR	July 3, 1939

In the East Bay Section of the Pacific Division Mr. Horace R. Greer, W6TI, Mr. D. Reginald Tibbetts, W6ITH, and Mr. S. C. Houston, W6ZM, were nominated. Mr. Greer received 106 votes, Mr. Tibbetts received 85 votes and Mr. Houston received 28 votes. Mr. Greer's term of office began May 29, 1939.
In the Southern New Jersey Section of the Atlantic Division Mr. Lester H. Allen, W3CCO, and Mr. W. Raymond Tomlinson, W3GCU, were nominated. Mr. Allen received 87 votes and Mr. Tomlinson received 64 votes. Mr. Allen's term of office began June 22, 1939.
In the San Francisco Section of the Pacific Division Mr. Kenneth E. Hughes, W6CIS, and Mr. Henri J. Ballros, W6LMD, were nominated. Mr. Hughes received 78 votes and Mr. Ballros received 33 votes. Mr. Hughes' term of office began July 5, 1939.

Newcomers TO THE "19" SERIES

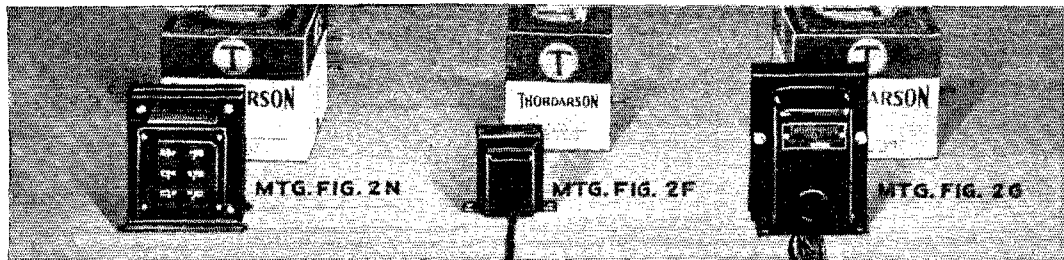

To meet certain specific amateur requirements, Thordarson engineers have designed eleven new transformers and thus round out the "19" Series. All of the "19" Series units are designed especially for amateur use and give Thordarson quality in the popular price field. These additions include: one driver transformer, two universal bias transformers, one

universal modulation transformer, one combination plate and filament transformer, one input choke, one smoothing choke, and four filament transformers with multiple secondaries. Catalog information on these additional units is given below. For complete information on the full series see your distributor or write factory for your free copy of the new catalog 400-D.

T-19D06 — DRIVER TRANSFORMER for Class B use with 6A6 and 6N7 tubes. Ratio Pri. to $\frac{1}{2}$ Sec. — 5:1, 4:1, 3:1, 2.5:1. Mtg. fig. 2F. Amateur price \$1.80.

T-19R30 — COMBINATION PLATE AND FILAMENT TRANSFORMER for low power stage transmitter applications. Sec. A.C. load volts 560-0-560. Delivers 400 D.C. volts at 150 M.A. Filament windings: 5V at 3A; 6.3V at 3A Ct.; 7.5V at 2.5A Ct. Mtg. fig. 2G. Amateur price \$4.65.

UNIVERSAL BIAS TRANSFORMERS
Mounting figure 2N. No filament winding.

T-19M13 — UNIVERSAL MODULATION TRANSFORMER with tapped coils allowing matching of any modulator tubes to any Class C R.F. load. 15 watts capacity. Prim. M.A. 50 per side; Sec. M.A. 50 in series, 100 in par. Mtg. fig. 2N. Amateur price \$2.40.

T-19R31 will supply D.C. voltages of 10 to 100 in approx. 5 volt steps at 200 M.A. Amateur price \$3.30.
T-19R32 will supply D.C. voltages of 100 to 400 in approx. 15 volt steps at 200 M.A. Amateur price \$4.35.

T-19C39 — INPUT CHOKE with capacity of 150 D.C. M.A. — and inductance of 5-20h. Mtg. fig. 2F. Amateur price \$1.95.

T-19C46 — SMOOTHING CHOKE with capacity of 150 D.C. M.A. and inductance of 12h. Mtg. fig. 2F. Amateur price \$1.95.

FILAMENT TRANSFORMERS WITH MULTIPLE SECONDARIES

One transformer from this group will often supply all filament voltages required. Secondary 2 of T-19F77 and Secondary 1 of T-19F78 have 7500 volts insulation. Mounting figure 2G.

Type No.	Sec. Volts	Sec. Amps.	Amateur Price
T-19F76	Sec. 1, 5V	3	\$2.85
	Sec. 2, 7.5V tapped at 6.3 and 5	6	
T-19F77	Sec. 1, 5V	3	4.20
	Sec. 2, 2.5V Ct.	10	
	Sec. 3, 10V tapped at 7.5, 6.3 and 5	8	

Type No.	Sec. Volts	Sec. Amps.	Amateur Price
T-19F78	Sec. 1, 2.5V Ct.	10	\$3.15
	Sec. 2, 5V	3	
T-19F79	Sec. 1, 6.3V Ct.	3	4.05
	Sec. 2, 10V tapped at 7.5, 6.3 and 5	10	

THORDARSON ELECTRIC MFG. CO.

500 W. HURON ST., CHICAGO, ILL.

Demand "Power by Thordarson"

Station Activities



ATLANTIC DIVISION

EASTERN PENNSYLVANIA—SCM, John B. Morgan, W3QP—Ass't S.C.M. in charge of Emergency Coordination, 3AKB, R.M.'s: 3AKB, 3AQN, 3ASW. The Main Line Radio Club staged one of their hidden-transmitter hunts, using our shack as the hide-out. One member, using a unidirectional loop, did some very impressive work in riding up the beam into our driveway; he was the only one to find the location in the time allotted. The bi-directional loops had considerable trouble, mostly it seemed from not going far enough away from the plane of the first bearing to get an accurate cross-bearing. About 30 O.R.S., including two ladies, 3AKB and 3FXZ, plus 20 non-ham YF's and YL's, descended on us one Sunday afternoon for a "conference." The Eastern Penna. Traffic Net, under the leadership of Paul Stumpf, 3AQN, had a very beneficial meeting, during the time the YF's and YL's were preparing a picnic, which was the first time most of the members had met each other. A general discussion of Net policies and procedure was hashed over, with the feeling expressed that the best service to be rendered was when most of the members could operate simultaneously. Accordingly it was decided to use the Net frequency, 3835 kc., for checking-in and instructions and traffic work by the Net Control, while the others would gradually acquire crystals for spots close to the Net frequency and would switch to these for clearing traffic among themselves and then QRX again on 3835 for further instructions from the Control. It was decided to change the Net operating time to 11:00 P.M. EDT daily during the summer. Field Day brought out one of the finest collections of equipment on record. Frankford Radio Club had the use of a barn in which they erected a 3.5-Mc. half-wave, no part of which was less than 56 feet above the ground. During a brilliant electrical storm two of their gang were in a tree-top with a 56-Mc. rig, when a bolt hit the wires nearby and put out of commission the line being used to illuminate the branches so they could climb around. Scores were prodigious, with five HRO's on batteries and as many transmitters on portable a.c. generators. The York Road Club also had a lot of trouble from rain and lightning, but kept going pretty well through the night, with six complete rigs working for a time until the moisture began to blow filter condensers and wiring became soggy and shorted. With the E. Pa. Traffic Net working and other nets indicating summer operation, there should be plenty of traffic for those who will spare the time. Reports are wanted definitely all summer.

Traffic: W3ADE 15 3AQN 14 3BES 7 3EEW 129 3EFH 2 3CEML 776 3GDI 22 3GHD 3 3GJY 315 3GKO 325 3GUB 3 3GYY 4 3HBJ 19 3HCT 1 3HFE 6 3HQE 30 3HRS 90 3HVV 11 3IAY 6 3QP 344 3RR 41 3ASW 232 3ATF 5 3CDT 5 3EKG 142 3EU 4 3FLA 37 3OML 2 3RHE 6 3SNZ 10 3SSP 1.

MARYLAND-DELAWARE-DISTRICT OF COLUMBIA—SCM, Edgar L. Hudson, W3BAK—3CQS, 3CXL, R.M.'s. 3BWT, Chief R.M. HUP would be interested in arranging schedule with any other 3.5-Mc. station in order to help them work Delaware for W.A.S. BAK is experimenting with a two-section 8JK beam. CDG took a 807-word message from SN for local Reserve Officer's Association. BHE, DIC, FRV, BFX and DOG attended the hamfest in Balto., May 13th. HZH and HXP have W.A.C.'d from two different points. HQU sent a couple of messages to China through 2HWL. BWT will continue to operate schedules through the summer. HUM has new QTH, and finds it PB for antenna.

Traffic: W3BWT 542 CXL 175 (WLM 2830) ICT 32 HUM 35 GYQ 53 HQU 25 HZH 8 BFX 6 CDG 4.

SOUTHERN NEW JERSEY—SCM, Walter Filson, W3BEI—This report prepared by W3BEI: The term of office of the retiring S.C.M. expired June 15th. I wish to thank all those who made it possible for S. J. to show a sizeable amount of traffic and also quite some activity, and those officers of the several clubs who have sent in necessary information on the happenings of their particular section. I have enjoyed working with the boys. I trust the new S.C.M., Les Allen (W3CCO) will carry on the work of the S. J. Net which operates on 3700 kc. and which was started by 3ZX, the previous S.C.M., and has continued to operate for the past three years. BYR has put in e.c.o. I trust the gang will

give the new S.C.M. their best efforts as they have while I held the office. My cooperation goes with relinquishing the office, and what help I can give will be freely given. DGE is back on with a 'phone rig. GRO is working out on 28 Mc. since rebuilding his T-125 stage. HGN has an efficient "V" beam for 28 and 14 Mc. GEV now has his 8JK beam working as well as the V Beam for Europe. GNU has a complete set-up for emergency work; 1000-watt power source and 100-watt transmitter operating from 56 to 1.75 Mc. CCO has new final amp. under construction for the little rig on 28 and 14 Mc. COP moved across the street and is now in N.N.J. Sorry to lose you, Joe. Another E.C. was appointed for the region of Audubon, Haddonfield, Haddon Hts., Camden, Merchantville, etc., W3KW, who also has a 75-watt portable-mobile rig installed in his radio service truck. Lots of luck and good traffic to the Section.

Traffic: W3BZX 110.

WESTERN NEW YORK—SCM, H. E. Preston, W8CSE—R.M.'s: 8BJO, 8DSS, 8FCG, 8JTT. P.A.M.: 8CGU, E.C.'s: 8GWY, 8RGA, 8RVM. Section O.R.S. net frequency 3720 kc. It is with deep regret that we chronicle the death of Horace Ashworth, W8HNT of Brockport, on June 3rd. One of the most active stations in the Section, he will be missed by the many friends he had made over the air. The traffic men suffered a loss when JTT obtained a position in Cleveland, Ohio. Good luck, Roger, and the best of good wishes from all the W.N.Y. gang. The Rochester Amateur Radio Assn. has had a very successful year and celebrated with a picnic at Westminster Park on July 9th. On June 6th the club elected the following officers: MC (ex-8EBS), Pres.; BJI, Vice-Pres.; RYL, Sec.; DFN, Treas. An executive committee consisting of OSX, NCM, NBI, AGU and FNT was also selected. RGA is trying to get on 56 Mc. OQC rebuilt, and the new rig does everything but the housekeeping. ACY is knocking off PK's and KA's on 14-Mc. 'phone. DOD has QSL's from 99 countries. MC's XYL got her ticket. The Rochester Association gave a farewell dinner to M. W. Grinnell at Pittsford Inn, Pittsford, on June 10th. We will be sorry to lose our Radio Inspector, who certainly was a good friend to the amateurs in his district. DLK is trying his luck on 7 Mc. MQX is doing his stuff on 1.8-Mc. 'phone. NNJ rebuilt his speech equipment to incorporate speech compression, and is delighted with the results. AXE, AYE, KYM, OZN, QLV, QJG, RVM and SHP attended East Ontario Hamfest on June 11th; QLV won the major prize, a T55. We have a new arrival in Sidney working under the call TEW; he came to us from Poughkeepsie where he signed 2GFD since 1932; his antenna system is worthy of description: It is a Zepp with 492-foot flat top and 95-foot feeders which go to a tuned coupling unit; this unit is coupled to the transmitter with 35 feet of transmission line!! SBV hooked 7HCY in Billings, Mont., and was very much surprised to find that 7HCY was a native of Elmira and had gone West in 1933. RTX has a dandy transmitter with a Bud 500-watt final unit. NNJ visited FFN, AVD, TEP and CP. AVD puts out a nice signal on 3.9-Mc. 'phone with his 2-watt portable. There were a great many portable stations active in the A.R.R.L. Field Day. JUG/8 of Syracuse and HQW/8 of Auburn did some fine work. KIR operated from a location on Skaneateles Lake. Several stations reported hearing 3USA. PLA leads the traffic list this month.

Traffic: W8RVM 4 JTT 34 CGU 15 RTX 4 DHU 7 FCG 104 PLA 116 PCN 98 CSE 83.

ROANOKE DIVISION

NORTH CAROLINA—SCM, W. J. Wortman, W4CYB—The swimming hole is a more comfortable place than the operating table, but let us hear from you fellows that are on the air. DWB is experimenting with antennae. DGV is rag-chewing on all bands. DGU worked his first G. AAK is fighting QRN on 3.9-Mc. 'phone. TO is working DX on 14 Mc. AIT has new 14- and 28-Mc. rotary beam. DCG is working 7 Mc. after staying with 14-Mc. 'phone for 67 countries. AKC and CCO have lined up schedules for summer traffic. Shove them your traffic, fellows. While the hot weather is here, get out and try those portables; line up with the Emergency Corps, and be set for any emergency next winter. All Official Stations check again on your certificate dates. Several cancellations are coming up if not renewed before long. 73—Buck.

Traffic: W4CCO 16 DCG 7 TO 6 DW 4 DGU 2.

SOUTH CAROLINA—SCM, Ted Ferguson, W4BQE: FFO and COL are attending summer school at Univ. of N. C. CQU has his regular schedules. FHE is building new 100-watt all-band transmitter. BNN schedules DGD and

EHF. DGD works cross-band with AOB. DRE is operating 7 Mc. EXJ operates 1.75-Mc. 'phone and 7-Mc. c.w. DPN swapped his Class "C" for a "B" ticket. EGH says 28 Mc. is FB on short skip. CQG is harvesting QSL's from the DX contest. EDQ says short skip on 28 Mc. works FB. DQY takes 56-Mc. rig with him on his honeymoon. Optimist? New hams: GCW Liberty, FNS and FYL Greenville. Welcome, fellows. DAM changed QTH to Greenville. FNC sticks to 1.75-Mc. 'phone. BJJK is heard on 1.75 Mc. between working hours. CZN keeps schedules on 3.5 and 7 Mc. DXF spends most of his time rag-chewing on 3.5 and 7 Mc. DNR divides time between 1.75-Mc. 'phone and 3.5-Mc. c.w. GB will be back on 'phone. CPX is taking a shot at 56 Mc. FMZ operates 3.5 and 7 Mc. The following are working 56 Mc. and would appreciate any heard reports: EXJ, DQY and CPX. The Palmetto Amateur Radio Club, Inc., took part in the Field Day under the call GB, and enjoyed the week-end at Krellair.

Traffic: WAFFH 40 FNC 14 CQU 13 BPD 11 DRE 9 DGD-CZA 8 EZF 7 FEE-BNN 6 ETP-EDQ-CZN 5 EGH 4 EHF 2 FAV-DQY 1.

VIRGINIA — SCM, Charles M. Waff, Jr., W3UVA — R. M.'s: GTS, HDQ — P.A.M.'s — AJJ, GWQ-ELN. GTS and HDQ are consistent reporters and traffic handlers. Congrats on FB work, and thanks for your cooperation in reporting regularly. HAE is building 7-Mc. antenna mast. ICQ is new ham at Cape Charles with 6L6G crystal. Welcome, OM! BZE reports the Richmond Amateur Radio Club operates 3FB1/3 in Field Day with a flock of rigs and 500-watt gas-driven generator. GTS is back on 7 Mc., letting EUG handle his traffic until August. FJ was QSO six W8's and one W9 on 57.5 Mc. in one hour, in one evening. CYW has had many QSO's with W8 and W9 on 56 Mc. CFL is experimenting with 56 Mc. HBH visited his home in Mineral. CSC is new member of A.A.R.S. Net. GEX needs only Miss. and North Dakota for W.A.S. GJP is getting out FB on 28-Mc. 'phone. FQO has 54 countries confirmed; EMA has 94. UVA has 76 confirmed and has W.A.S. BSY is back in Charlottesville after operating portable the last nine months in Tucson, Ariz., and Gainesville, Fla. Don't forget the Roanoke Division Convention, August 5th-6th, at Charleston, W. Va. Take your vacation in the W. Va. mountains! See you there.

Traffic: W3ELN 220 GTS 5 FJ 4 CYW 3 ICQ 2.

WEST VIRGINIA — SCM, C. S. Hoffmann, Jr., W8HD — August 5th and 6th are red-letter days for this Section. They will mark the Divisional Convention date, the third time such an event will be held in this Section in the history of amateur radio! See you there! OXO (R.M.) is rebuilding for fall Trunk-Line season. ASI/8 spent 26 hours on during F.D., using 14, 7 and 3.5 Mc. CLQ and OJI got married during month. MZD visited Chicago. OXO promises a State-Wide Net on 3770 kc. this fall! BOK and EP were heard on c.w.! TID and PME at Bethany College are working on 'phone and c.w. JM has new Jr. YL: Born June 1st, name: June Morris (8JM) Hi! CGY visited ADI/PHY. BRE is moving from WPAR. MOI works plenty of 14-Mc. 'phone DX. RWY returned from New Jersey. SDU is on 3.5 Mc. MLW moved to Beckley. KIU/DSJ, Dr. Friend, in his final report, before moving to Harvard U., reports having completed 56-Mc. tests and QSO's with 8CIR, 8CLS and 8NYD from the Chest Mountains. RFP has new Class A license and call TNC at W.V.U. Horace Atwood, Jr., TNC/RFP is taking over Dr. Friend's duties. New O.R.S.: SKD and JM. BHG moved. LCN is building new 14-Mc. rotary beam. The S.C.M. and many of the Wheeling gang visited the Atlantic Division Convention at Pittsburgh during June.

Traffic: W8OXO 75 KIU/DSJ 38 MOL 14 PHY 7 TID 6 JM 2

HUDSON DIVISION

EASTERN NEW YORK — SCM, Robert E. Haight, W2LU — HXQ, our YL O.R.S. and O.P.S., is doing a fine job for 2USA. KUV, in camp at Tobyhanna, Pa., schedules KWG. L&D is on all bands with new rig, 6J5-807-T55. LU enjoyed vacation in wilds of Maine. LEL is operating on 7038 kc. HNH is perking out FB with 35 watts on 1.8 and 3.9 Mc. LLU is heard on 3580 and 3568 kc. KFB reports new rig at FTG, 30 watts Rochelle High School, 53 crystal osc., 801 final, 30 watts. KPH, LIC and LRW joined the A.E.C. ACB, our E.C. of Schenectady area, his asst. E.C.'s J.R.Z., CJP, KUD, CBD and HZL and all members of S.A.R.A. are to be commended for their Field Day demonstration. A 121-word Red Cross message from the Red Cross officials

at Schenectady to the national Headquarters was delivered in Washington at 5 p.m. on 3.5 Mc., and a 52-word reply received at 6 p.m., with the cooperation of 3BWT at Wash. Your S.C.M. wishes all members of E.N.Y. Section an enjoyable vacation, and would like to hear from all hands. 73. Traffic: W2HXQ 307 KWG 150 L&D 60 LU 49 LEL 18 HNH-LLU 1.

NEW YORK CITY AND LONG ISLAND — SCM, Ed L. Bannach, W2AZV — LXX is out for O.P.S. appointment on 28 Mc. The June Field Day was a huge success in this Section. JHB was in the F.D. for the first time. HLI, IZJ and JUX were operating W8 from Tusten, N. Y. LR and ITX were portable in Amityville. PF and his gang were out in a truck in the wilds of S. I. The Suffolk Amateur R.C. operated from Camp Baiting Hollow on the L. I. sound. DOG reports from N. J. CWP moved to 165 W. 197th St., Bronx. MAZ moved to Great Neck. LEB, LVN and LNU are on 1.75-Mc. 'phone. LNF is building complete line of test equipment. BTC is looking for small gas generator for his portable rig. LYP is on with his first rig. APM and JSV are on 112 Mc. HBO worked JTP on 112 Mc. BOT is back on 3.5 and 7 Mc. CHK took an auto trip through Canada. JBL is back in Brooklyn. HMJ is WLNX in the A.A.R.S. AXZ operates in the S.N.Y. A.A.R.S. on 7 Mc. KKW worked Nevada and got his W.A.S. using less than 100 watts input. EVA is still looking for Nevada. LZR has worked 26 states with 25 watts to a 6L6G on 7 Mc. LBI has a low-power 1.75-Mc. 'phone for local work. HXT keeps his schedule with 5ELC going past the fourth year. LXQ is rebuilding 1.75-Mc. rig. FF is going to try television. Short skip on 28 Mc. helped IYX work nearby states for his W.A.S. IOP made the C.C. All A.E.C. stations who have received the pink registration form are requested to send them in, or they will be dropped from the active list. The Section Net continues to be very active during the summer months. All active stations are invited to join. The frequency is 3710 kc., time 7:30 p.m. LR is the control station. The hurricane season will soon be with us, and all stations who can possibly do so are urged to have some form of self-powered portable equipment operating, especially on the 56- and 3.5-4-Mc. bands, both 'phone and c.w. We want to be prepared to meet anything that may happen in case regular communication should fail. The emergency frequency for this Section is 3710 kc. LNN is struggling along on 7 Mc. with 15 watts.

Traffic: W2SC 1154 HMJ 399 JZX 209 DBQ 117 (WLN8 57) LR 117 PF 98 LZR 84 LOQ 70 AXZ 58 ITX 52 GDF 40 AZV 37 BGO 33 JHB 25 CHK 20 LBI 22 IOP 25 CET 16 KKW 13 FLD 12 DLR 9 ADW-CIT 8 JDG-BYL 7 IRC-AA-AZM 6 AHG 5 IYX 3 IXQ-HGO-LWE-JBL-HBO-LGK 2 DOG-DMM-BXR-EYE IHYC (WLNX 53).

NORTHERN NEW JERSEY — SCM, Fred C. Read, W2GMN — KTR has been busy working up local emergency net in Perth Amboy. MEY made first report. KHA handled traffic at Bayonne High School "Open House." IMT is active on 1.75-Mc. 'phone. CMZ is on 28-Mc. 'phone with new beam antenna. FB is building 1000-watt transmitter for 1.75-Mc. 'phone. BYD moved to new home in Cranford. CAY spent a pleasant vacation with VE1KK in Berwick, N. S. CAK, "M.D.," is now at Bellevue Hospital, N. Y. C. Anyone interested in traffic handling at or with the New York World Fair station 2USA, please communicate with Traffic Control Committee, 2USA Radio Club, New York World's Fair, Flushing, L. I. GMN extends grateful thanks to all of you for your fine cooperation and trusts that you will give your best support to your new S.C.M.

Traffic: W2KHA 166 CGG 57 GVZ 52 CJX 10 LMN 6 MEY 3 ISF 2 JUC-CIZ 1.

NEW ENGLAND DIVISION

CONNECTICUT — SCM, Frederick Ells, Jr., W1CTI — The New Haven Amateur Radio Ass'n put on the Third Eastern DX Round-Up, June 1st, a very successful and enjoyable affair, attended by over 200 hams from near and far. GM6RG was the main speaker and gave a very fine talk. KAK has a 'phone rig on 1.75 Mc. DUE works DX on 14 Mc. KYQ is planning emergency hook-up with Police Dept. KPJ is still in Boston. HYF won a TZ40 at Springfield Convention. LZC is a new ham at Northville. The Connecticut Brass Pounders Association took part in Field Day. Operation was on 3.5 Mc., using BCG's transmitter and a National NC100XA. A.C. power was supplied by a Home-lite 1-kw. gas-driven generator. CBA/1 was set up in a tent in a lot off Long Ridge Road, Stamford. Operators included BCG, CNU, CTI, EER and 2AHL. BHM worked

(Continued on page 78)

ABBOTT

• DK2 •

2 1/2 METER TRANSCEIVER



SENSATIONALLY LOW PRICE

LESS TUBES AND BATTERIES

\$27.50

LIST PRICE

40% Discount to Amateurs

GENERAL: The DK2 is a completely self-contained 112 mc radiophone transmitter and receiver, for use in your car, plane, boat, or while being carried, for portable work. It is very simple to operate. The working range is between 2 to 30 miles depending on the location. Astonishing results have been obtained.

SPECIFICATIONS

CASE: Size 11 1/2" long x 9 1/2" high x 6 1/2" wide, grey wrinkle finish metal, heavy leather handle. All batteries are self-contained in case. Removable side panel for easy access to the batteries and tubes.

PANEL: Beautifully finished in black enamel with silver scales and lettering.

CONTROLS, ETC.: Two ceramic insulators are supplied for antenna, special large easy tuning knob, volume control on and off switch which acts as such in the receive position and as a gain control in the transmit position, transmit and receive switch, microphone and headphone jacks.

FREQUENCY: Will cover 112 mc to 118 mc (amateur 2.5 meter band).

BATTERY REQUIREMENTS: Three 45 volt B batteries like Burgess 5308, and four No. 6 dry cells, or two Burgess 2F2H batteries.

TUBES USED: One type 6J5GTX; one type 6G6G.

SHIPPING WEIGHT: 12 pounds.

Order from your nearest distributor — if not yet stocked we will temporarily fill orders direct

Some Territories Still Open to Responsible Representatives
BULLETIN ON REQUEST

ABBOTT INSTRUMENT, INC.

51 Vesey Street

New York City

★ S. F. TRANSMISSIONS ★

Date	Schedule	Station	Date	Schedule	Station
Aug. 4	A	W9XAN	Sept. 1	B	W6XX
	B	W6XX	Sept. 8	A	W9XAN
Aug. 11	A	W9XAN		A	W6XX
	A	W6XX	Sept. 15	BB	W6XX
Aug. 18	BB	W6XX		A	W9XAN
	A	W9XAN	Sept. 16	BX	W6XX
Aug. 19	BX	W6XX	Sept. 17	C	W6XX
Aug. 20	C	W6XX	Sept. 22	A	W6XX
Aug. 25	A	W6XX	Sept. 29	A	W9XAN
Sept. 1	A	W9XAN		B	W6XX

STANDARD FREQUENCY SCHEDULES

Time (p.m.)	Sched. and Freq. (kc.)		Time (p.m.)	Sched. and Freq. (kc.)	
	A	B		BB	C
8:00	3500	7000	4:00	7000	14,000
8:08	3600	7100	4:08	7100	14,100
8:16	3700	7200	4:16	7200	14,200
8:24	3800	7300	4:24	7300	14,300
8:32	3900		4:32		14,400
8:40	4000				

Time (a.m.) Sched. and Freq. (kc.)
BX

6:00	7000
6:08	7100
6:16	7200
6:24	7300

The time specified in the schedules is local standard time at the transmitting station. W9XAN uses Central Standard Time, and W6XX, Pacific Standard Time.

TRANSMITTING PROCEDURE

The time allotted to each transmission is 8 minutes divided as follows:

2 minutes — QST QST QST de (station call letters).

3 minutes — Characteristic letter of station followed by call letters and statement of frequency. The characteristic letter of W9XAN is "O"; and that of W6XX is "M."

1 minute — Statement of frequency in kilocycles and announcement of next frequency.

2 minutes — Time allowed to change to next frequency.

W9XAN: Elgin Observatory, Elgin National Watch Company, Elgin, Ill., Frank D. Urie in charge.

W6XX: Don Lee Broadcasting System, Los Angeles, Calif., Frank M. Kennedy in charge.

WWV Schedules

EACH Tuesday, Wednesday and Friday (except legal holidays), the National Bureau of Standards station, WWV, transmits with a power of 20 kw. on three carrier frequencies as follows: 10:30 to 11:30 A.M., E.S.T., on 5000 kc.; noon to 1:30 P.M., E.S.T., on 10,000 kc.; 2:00 to 3:30 P.M., E.S.T., on 20,000 kc. The Tuesday and Friday transmissions are unmodulated c.w. except for 1-second standard-time intervals consisting of short pulses with 1000-cycle modulation. On the Wednesday transmissions, the carrier is modulated 30% with a standard audio frequency of 1000 c.p.s. The standard musical pitch A=440 c.p.s. is also transmitted from 4:00 P.M. to 2:00 A.M., E.S.T., daily except Saturdays and Sundays, on a carrier frequency of 5000 kc., power 1 kw., 100% modulation. The accuracy of the frequencies of the WWV transmissions is better than 1 part in 5,000,000.

YOUR STAMP
OF
APPROVAL



ON THE
OK **T-55**

Radio Amateurs by the thousands throughout the entire world have placed their stamp of approval on Taylor T-55's. Their acclaim and enthusiastic endorsement of the T-55's long life and fine performance has created a new standard of transmitter tube values.

THREE YEARS OF SALES LEADERSHIP

Three and one half years ago, the T-55 caused a sensation by its universal, quick acceptance. The T-55 has continued its steady march of sales popularity. TODAY IT IS RECOGNIZED THE SALES CHAMPION IN ITS CLASS. In practically every country of the world, these popular tubes are delivering peak performance to thousands of satisfied Radio Amateurs.

NEW T-55 IMPROVEMENTS

- Semi Thin Wall Anodes
- Sturdier, Heavier Filament (7.5 volts @ 3.0 amps)
- Better Insulation
- All Molybdenum Grid
- Alsimag Base
- All these added perfections at no additional cost to you.

These improvements have been made on the T-55 to increase your pleasure in its performance, and to bring you more hours of trouble-free uninterrupted operation. If you are interested in a medium power class "C" Amplifier tube, give the T-55 full consideration. Wait for what the T-55 is truly the Champion in its class. You're always sure with Taylor Tubes.

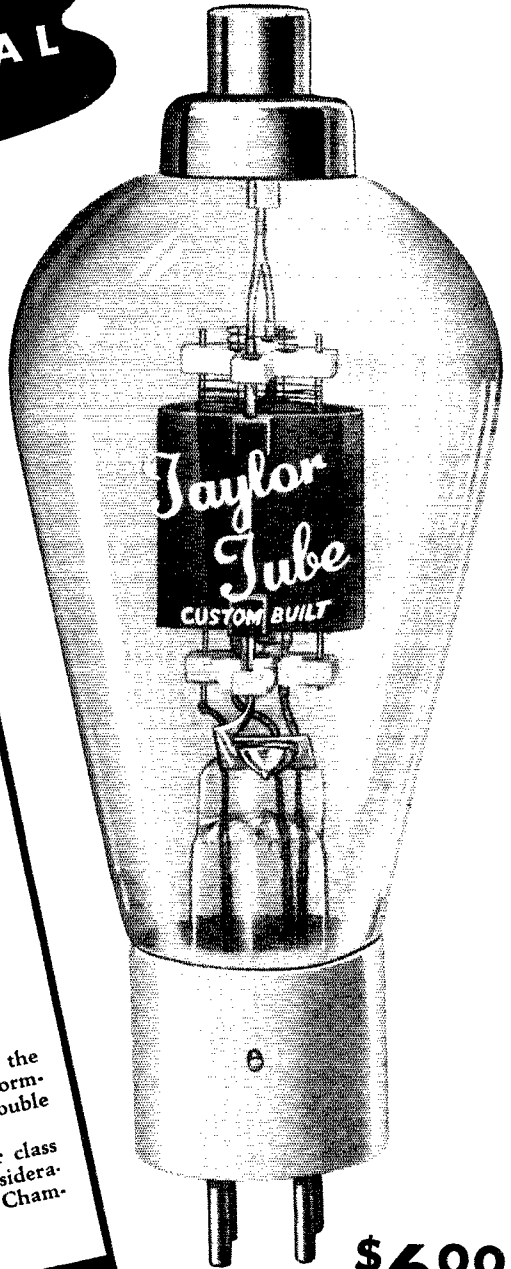

\$6.00

ACTUAL SIZE

"More Watts Per Dollar"

TAYLOR TUBES, INC., 2341 WABANSIA AVE., CHICAGO, ILLINOIS

(Continued from page 69)

VK7 and HR. JAK has a new rig on the air. BYW added another ham to his shack; it's a boy. Congrats. JQK received an S9 report from E16G. AVC continues his fine work as O.O. Any active amateur interested in joining an emergency net and living in towns served by the N. Y., N. H. & H. R. R., please get in touch with KQY who is acting as Regional Coordinator. EH/1 was operated in the Field Day from South Lyme by EH, JFN, JPE, LVQ and JEQ. BDI spent a few hours in the F. D. operating BDI/1 at Newington.

Traffic: W1AW 228 JXP 56 BDI 15 TD-KQY 14 KQY 8 UTI 4 HYF 3 GB 2.

MAINE — SCM, H. W. Castner, W1IE — Greetings, fellows, and thanks for so many reports. We're off to a flying start. LHI is out in N. Y. State now. LER goes to U. of M. in the Fall. LHM is building a fine shack and is on 1.75-Mc. 'phone. 1FZ is going to add 1.75-Mc. 'phone. GQ is joining A.R.R.L. We are starting a 1.75-Mc. 'Phone Net along the coast, and all the boys are invited in. HLT is on 1.75 Mc. frequently. We have a code practice schedule three times a week, Mon., Wed. and Fri., at 12.15 p.m. to 12.45 p.m. Any of you fellows around the state that want practice, listen for W1IE on 3597 kc. on this schedule and report if you are copying. KNJ is active on all bands. LDC has added a Harvey 75T and an NC100X with a Utah Jr. stand-by. We want many more registrations for emergency work. Would like to hear from any of you boys that are interested. We have some dandy certificates all ready for any A.R.R.L. appointments. We need a lot more O.R.S. and O.P.S., and I'm ready to consider R.M. and P.A.M. applications. Don't be timid. It's very pleasant work and won't interfere with anything else you have to do. Let's hear from all of you. Would like to have a personal letter from everyone, whether League member or not. Let's put Maine way out in front!!!

Traffic: W1MLL 71 FBJ 11 DFQ 8 LRP 4 IIE 1.

EASTERN MASSACHUSETTS — SCM, Larry Mitchell, W1HIL — Ass't S.C.M.'s: 1GAG, 1JJY, R.M.'s: 1JJY, 1JSM, 1EPE, 1KZT, 1QW, 1IHI. New O.R.S.: FWQ. New O.P.S.: JCX, JDG, LMB. LWH is ex-6PQM. Welcome to the Section. Walt. HIL enjoyed fine A.A.R.S. meeting at Castle Island, Boston Harbor, June 3rd. Join the Army, gang! IIM reports Parkway Radio Ass'n hopes to get call HOB for club station. IIM, INL and IBS operated portable from Bolton, on A.R.R.L. Field Day. First reports from new hams: LZV, Rosindale, 1ZW, Quincy. Welcome, Jim and Bill. Let's hear from all you new hams. GAG is moving to Stoneham. ERH has 300 watts on 7 Mc. LSW has new Amp-plex Beam. 6NWP-1 worked West Coast on 9 watts portable-mobile. FVN has new 3-element beam. NP is coming on 'phone. DNL works DX with 30 watts. LMB is great rag-chewer. JDG will be portable in Maine until Sept. LNN reports Traffic Net 7.2 to 7.25 Mc. Contact 2LSD for dope. LVV expects to be on 3.5 Mc. with e.c.o. BDU joined new "Forty Traffic System" along with LMO. WV works lots of DX on 14 Mc. Our sympathies to AAR and XYL in loss of new Jr. op. HWE keeps usual 56-Mc. schedules. AKY will soon have W.A.C. JGQ is still working on new rig. AKS leads the traffic parade. FWQ handles traffic in good style. AGX keeps regular schedule for summer on 56 Mc. GCU reports activity on 112 Mc. KH visited 6USA and 2USA. KHE-1 operated during Field Day at Sandwich. Operators were KHE, CBZ, ICA, 1KU, AGW, HQL and JYJ, all of Radio Operators Ass'n of New Bedford. HKK put beam up 70 feet with aid of 8 linesmen. KVT is at camp in N. Y. KYN got gift of Class B mod. 1QX is rebuilding Class B 'phone. HQV is working in Portsmouth. N.C.R. activities concluded with assembly at Lynn, June 20th. QW very kindly offers to take on job of E.C. for his Section. Thanks, Wes. How about someone in Boston making such an offer? LXJ of Marblehead applied for O.R.S. After Sept. 1st a new list of active A.R.R.L. appointees will be published here. Report if you expect to be on this list.

Traffic: W1AKS 290 KH 171 LWH 168 JCK 126 (W1VG 68) JYJ 93 FWQ 38 QW-AGX 34 HWE 30 AAR 26 LMO 21 WV 13 BDU 7 LVV 6 LNN 5 JDG 3. (April-May: W1LVV 5.)

WESTERN MASSACHUSETTS — SCM, William J. Barrett, W1JAH — BVR presided at Boston meeting of First Corps Area A.A.R.S., June 3rd. KUV is sporting new Class A ticket. KZU erected new rotatable beam. New 'phones in West. Mass. include MBT and MBX. JAH gave emergency equipment a workout in A.A.R.S. test and also a few hours in A.R.R.L. Field Day. AJ got up an antenna at new QTH. KJK got back from long stay in Racine. KLN operated at KJK to maintain schedules. COI revamped

a.m.c. in speech amplifier. Incidentally, COI and BVR have not missed a monthly report in the three years I have been writing this report and, believe me, that's a record of which to be proud! LDE is taking life easy on 14 Mc. this summer. DCH reports for Chair City Radio Ass'n. New officers: Pres., JXE; V.-P., BIV; Activities Dir., KIK; Secy-Treas., DCH. New O.R.S.: HNE and DCH. How about some reports for next month?

Traffic: W1BWR 2 (W1G 66) GZL 14 JAH 10 (W1GH 7) AJ 9 KJK-RB 5.

NEW HAMPSHIRE — SCM, Carl B. Evans, W1BFT — The Fourth Test Mobilization of the New Hampshire Emergency Net will be held on Sunday, August 6th, with morning schedules similar to those used on the third Mobilization last May. A general bulletin will be mailed out with all the necessary details. CORRECTION!!! The Sixth Annual N. H. State Hamfest and A.R.R.L. Convention will be held at the Hotel Carpenter at Manchester on Saturday, September 23. The Manchester Radio Club at a recent meeting had a talk and demonstration of artificial resuscitation given by an expert from the Public Service Co. of N. H. Afterwards all members of the club who were present participated in a general try-out of the system by alternating on each other. M.V.A.R.A. participated in the Annual June Field Day by operating four transmitters on all bands at Bow, N. H., under the call DMD/1. One hundred and thirty-five stations were worked in 28 states with inputs averaging 15 watts. The following operators participated: AWU, BFT, ILN, IVU, JBA, JCA, JJD, LIN, LVG. IP is chasing DX. JKH has a Collins 4A transmitter. JCA has been active on 3.9-Mc. 'phone. APK is experimenting and getting very good results with facsimile. The Farmers Net held an outing on June 25th at Wallis Sands. AQW is now located in Newton, Mass.

Traffic: W1KIN 141 DMD 1.

RHODE ISLAND — SCM, Clayton C. Gordon, W1HRC — KZN has e.c.o. 802 working on all bands. KYP is struggling with a knotty 6L6G amp. on 7 Mc. LQL rebuilt r.f. section of his rig and put up new 7-Mc. antenna. JRY worked 4EDD, 9ARN and 9GGH on 56 Mc. LWA joined P.R.A. MBM is new ham. JF finished up a portable rig for a.c. or 6-volt operation and self-powered portable receiver which somewhat overshadowed in performance the other portable rigs used in P.R.A. Field Day trials. DDY had good results from a generator on his emergency receiver. HJB is on 56- and 28-Mc. 'phone. The gang at AQ now has emergency equipment powered by gasoline generator which is performing fine. Their transmitter uses a 6C5 Pierce oscillator and 6L6G feeding an 809 final. This equipment was taken to Boston on June 3rd to the A.A.R.S. meeting, where it shined among the others present, and was taken to Foster Center on the Field Day contest. CPV also had a vibropack which satisfactorily powers the exciter section of this transmitter, and with this outfit alone he was able to hold a solid hour QSO with 3EDC in North Hills, Pa., on 3.5 Mc., at 10 p.m. FB, boys.

Traffic: W1LWA 4.

VERMONT — SCM, Clifton G. Parker, W1KJG — DQK, KEP, LYA and FSV attended N. E. Convention. KXY and FSV were in Boston for A.A.R.S. meeting. Radio Club at Rutland was active for Field Day with 3-kw. generator furnishing power for at least 4 rigs. Vt. A.A.R.S. shut down on schedule drills for summer, but for traffic can generally find one or two stations at 3715 kc. at 7 p.m. Vt. needs O.R.S. badly in southeastern section of the state. GAE and KXY visited FXV who in turn visited EOB. Several of northern amateurs have call letter plates to match automobile registration plates — for particulars inquire of JLF, St. Johnsbury. MCQ is new Stowe amateur. IEQ is doing some operating at DQK. KEP is Ass't Coordinator for North Troy area. KOO, traveling around Vt. for Socony, reports interesting visits with several amateurs. DQK and AD are now O.P.S. JMO, CBW, GQJ and JLF were busy preparing for portable work at Harvey's Lake celebration on July 4th, where they were to furnish communication facilities for handling traffic on one-way roads and control of speedboat races. BNS is banging on 3.5 Mc. with AAJ being heard there also. CBW has new rig with T55 final. LBJ is on 1.75-Mc. 'phone with '46-'46 combination. Hope more of the Vt. gang will get in monthly reports on amateur activities. My belated thanks for the nomination as your S.C.M. KJG is back in home quarters and is on 3715, 3745 and 1827 kc. HQ's calls our attention to practical use of 1715-1800 kc. for traffic nets on short haul. Suggestions for a try-out on Vt.

Net in this band will be appreciated. Is there an amateur who will volunteer to endeavor to build up some occupancy here for V.7?

Traffic: W1FSV 32 KJG 18.

SOUTHEASTERN DIVISION

ALABAMA — SCM — James F. Thompson, W4DGS — R.M.'s: 4DS, 4APU. P.A.M.'s: 4DHG, 4BMM. E.C.'s: 40A, 4CRG, 4ECI. O.O.'s: 4ELX, 4EBZ, 4BYW. EVJ had 918M as visitor. EVJ has new e.o.o. going. KF has FB portable. EWR, ex-8BUL, is on 3.5 and 1.75 Mc. with pair of '10's. EBZ has a Hammarlund receiver. 1HRO, ex-W4 at U. of Ala., was again a visitor to Mtgy. and Tuscaloosa. ERW schedules DAU, who is a leader at Camp Andrews, Scout Camp. ERW added 35T and has P.P. final now. CWB visited F.C.C. Monitoring Station at Marietta, Ga. EJQ sent in cards for his W.A.S. on 28-Mc. 'phone. EDW has new 400-watt mod. all-band rig, and is building a 4-element rotary beam for 28 Mc. GDK and GDJ are new calls in Dothan. EUY is going away to school, but will have portable rig along. FXN is very active new call at Dothan. ETY is heading to 28 Mc. EJQ is coming back to 1.75 Mc. to work the boys around home. DHG was again a visitor at WMPM and Mtgy. FUM has new HQ120. FQP and FXT have new 1-kw. rig about ready to go. BCU was a visitor with AUP. FLS has new rig for 7 and 14 Mc. with 6A6-507-809-P.P. 211's with 500 watts input. BLG rebuilds for 28-, 14- and 3.9-Mc. 'phone. GDU (the OM) and GDV (the XYL) got going with a bang on 7 Mc. with a 6L6, and worked a K6 right off. GBV sucs likes 7 Mc. DXB had FB time at Rome Hamfest. DAI is back with a kw. on 7 Mc. FTV is setting up in the Bankhead Hotel in B'ham. BCU had rig out Field Day. FHD has 1.75-Mc. 'phone fever. CDV has pair of '10's on 7 Mc. CYL works all bands up to 28 Mc. EIJ, CVM, CYL, GDU-GDV, FYF and EAY keep 1.75-Mc. 'phone open. ELX, the Tusky O.O., operates mostly on c.w. and has HRO receiver and e.o.o. and crystal in transmitter with 200 watts. EYV has slick little 60-watt rig with 6E6-807, all in a steel cabinet about the size of a receiver. CIU and EBD say that the recent hamfest in B'ham was the best they ever attended. A coincidence: CIU in Jasper; DIU in Gorgas; BWG in Jasper and FWG in Gorgas. EBD QSO'd his 1st YV. DD applied for O.R.S. BFU is really working that DX on 14 Mc. We need Emergency Coordinators in Gadsden, Sheffield, Troy, Dothan and Mtgy. How about some offers? EBZ will be glad to take your report each month and forward it. FYF was a visitor with FXT and FQP. GAG has Sky Champion receiver. APJ has nice signal on 7 Mc. Look out for a QSO Party along about the last of Aug. 73. — Jim.

Traffic: W4ERW 78 EVJ 38 FBZ 30 FHD 24 GAG 16 FLS 8 DXB 7.

EASTERN FLORIDA — SCM, L. A. Conolly, W4DVO — Ass't S.C.M., Forrest W. Dana, W4AGR. R.M.'s: 4COB, 4PEL. P.A.M.: 4DDB, 800D and 8LEN spent vacation during June in Tampa. EBP is "Sparks" aboard Square-rigged Yacht *Seven Seas*. 8QMR returned to N. Y. for summer. GBC joined the "Florida" Net, making it Coast-to-Coast in Fla. This net also has direct connections with La., Tenn., Ala., Miss., Mo., Texas, N. C. and Calif. Flowers to DNA, N.C.S. EPV is rebuilding. ERU is working portable at Clearwater Beach. DNJ took unto himself an XYL. WS bought new Howard 450. DZS is new A.A.R.S. member on 7-Mc. Net. DWG and EFM now have Class "B" tickets. DAH took Class "B" exam. AJD has new rig, pair 6L6's crystal, pair 35T's, buffer, and pair 250TH's final, all stages push-pull. BJN, Ex-W4UL of Jacksonville, but lately of Mobile, Ala., is second mate on Waterman Line Steamer *Arizona*, and operates 28.5-Mc. portable 'phone on board ship. ANH with 6 watts input, held one hour 100% QSO on 28.5-Mc. 'phone with 9ZHL on May 30th. FSS, ex-8QCO and 3DVF, in Daytona Beach, was heard S6 in England on 2-Mc. 'phone last March. BYF schedules K5's for traffic on 14 Mc. EPW is taking vacation in N. C. FRE and FWU are on 112 Mc. DVB visited folks in St. Pete on week's vacation. DWU visited CQR in Macon, Ga. EKG returned to Tenn. AKJ, home from Ga. Tech., spent June with folks at Tampa. FIR took Teleg. 3rd exam. GAT is new Tampa ham. DWU is building new band-switching rig, working all bands, 'phone and c.w. EBE is on 7 Mc. with

'47 crystal, '10 final with 40 watts input. AFQ bought second-hand "Whippet" auto engine to run 1-kw. a.c. power plant. GAD and DRX have first-class 'phone tickets. DGW is having swell time visiting European ports as "Sparks" aboard Barquentine Yacht *Sea Cloud*. DVO depleted the family coffers to the extent of new NC100XA and new 350-watt a.c. plant. 73. — 4DVO.

Traffic: W4PEI 10 BYF 13 DNA 27 DZS 11 DVO 38 FWN 6 EFM 32 EBE 15. 8QMR/4 40. K5AA 388.

WESTERN FLORIDA — SCM, Oscar Cederstrom, W4AXP — R.M. — N.C.R.: 4DXQ. The KB-FAX Hamfest was well attended. About 70 registered for the luncheon which was held at the Inianola Inn at Fort Walton on the Gulf of Mexico. The ham coming from the greatest distance was 5AGZ, Vicksburg, Miss. A good time was had by all. EDW and newly acquired YF made the hamfest as part of their honeymoon trip. Congrats Mr. and Mrs. SC officiated as M.C. The YL's and YF's were very much in evidence and carried off some of the prizes. Congrats, Jimmie and Myrt, and may you have many more hamfests as pleasant as this one. MS worked ZS6AD the long way around, using his 8JK beam. AXF is heard again. DLB (ex-Ty of Pensacola) from Memphis visited the gang. VR will be on soon. QK and FRQ are very active. FWY is going to Mo. on vacation. FIH pounds brass at NAS. UW has been transferred to the broadcast station at Ocala. FGW has new SW3. EAD is back on 7 Mc. PBW and LT came to the hamfest with the N.C.R. gang. EPT gave his emergency rig a tryout, and it works fine. FJR is keeping the West Fla. traffic moving. Lola has an emergency-powered rig ready for service. GAM is the newest ham in Panama City. FBN and FVJ report that WTAL, local BC station, has a 100% ham staff: FVJ, FXS and FLV. FVJ has a nice 802 rig on 1.75 Mc. FBN is going to tickle the ether with an 809 and bring 'em in with a Sky Buddy. BOW is back on 7 Mc., and has an emergency-powered rig. CJE from Jasper is in Tally. FCE has new Sky Champion. Congrats to our Director and YF on their new-comer. AXP is remodeling shack and transmitter. PL paid a visit to the Section. 9SZI is with Eastern Air Lines at Tally; he is on 3.9-Mc. 'phone. We are glad to have him with us. Thanks a lot to you all for the reports. 73 until next month. — S.C.M., Oscar, AXP.

Traffic: W4FJR 116 AXF 92 EPT 76.

GEORGIA — SCM, Leland W. Smith, W4AGI — R.M. and E.C., 4VX and 4ECZ. Those of you in the Section who did not attend the Rome Hamfest missed the finest gathering of Georgia amateurs we have seen in a long time. There were hams from seven states present, and it was a pleasure to meet and talk with all of them. EQB erected a two-element beam for 14 and 28 Mc. FRF added another unit to his two-element beam on 28 Mc. ERS rebuilt using a pair of TZ40's in final on 14 and 28 Mc. ANN is rebuilding an homemade steel rack. The Albany Radio Club recently organized, with following officers elected: BIW, Pres.; ESA, Vice-Pres.; DIA, Secy. FID moved from Atlanta to Albany, and is on 14 and 28 Mc. in new QTH. DIA is working 14 Mc. with a pair of HK24's in final. MA is rebuilding with higher power. IR, BED, BAQ and FDJ went to town in the A.A.R.S. ZCB contest. FDJ has new half-wave 14-Mc. doublet with concentric cable. VX and ECZ were very active in the Field Day. AGI and BED held schedules each night for two weeks during the encampment of the 19th Battalion, U.S.M.C.R., at Parris Island, S. C. Each schedule lasted from three to four hours, and almost 300 messages were handled. Let your S.C.M. know what you are doing during the summer months and what you plan to do this fall. 73 to all of you. — Leland.

Traffic: W4AGI 360 BED 350 AOB 191 VX 44 ECZ 35 ERS 21 EYK 17 FDJ 11 FCW-ANN 4 MA 3.

WEST INDIES — SCM, Mario de la Torre, CM2OP — K4KD schedules W9GDM and W9CRX, both at Cham-paign, Ill. KB4FCS, Virgin Islands, is active on the 14-Mc. high end. CM2AF was visited by a "stork," and we hope the little YL will be a good operator. Congratulations, Alberto! CM2AW arrived home from Georgia Tech. CM7FR is improving his rig with a couple of T40's. CM2DB is planning on a "Californian" kilowatt. CM2AD is going active again on c.w. only. CM2BG is proud of his new NC-4A. CM2BK installed a Johnson Q ant. CM2FA is working lots of DX. CM2OP is very glad to see how the gangs reports are coming in. Keep 'em coming, fellows! 73.

MIMS NEWS

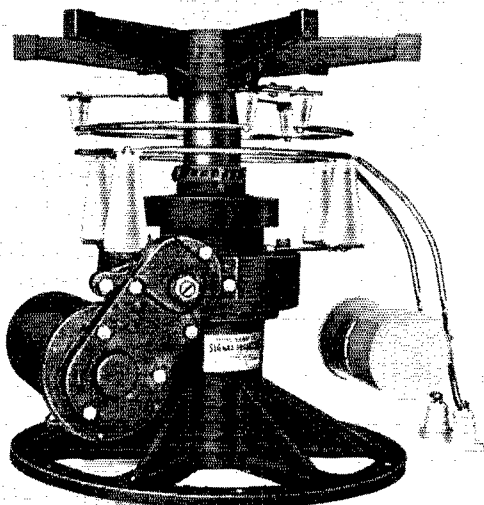

DE LUXE ROTATOR — Mechanically

- ★ Strong — weighs 56 pounds.
- ★ Size — 15" diameter base and top.
- ★ Shaft — 2 1/8" diameter tempered steel.
- ★ Rugged — high steel content castings.
- ★ Powerful — ample turning torque.
- ★ Positive — solenoid brake locks any position.
- ★ Weather-proof — completely enclosed.
- ★ Quiet — non-interfering motors.
- ★ Efficient — precision ball and roller bearings.
- ★ Design — especially for Inductostub feed.

Hey — Everybody:

MIMS SIGNAL SQUIRTERS are now available from outstanding distributors of Amateur Equipment.

Originally, the Signal Squirters were sold direct to the amateur for we were pioneering a new field. That this policy was well founded is evidenced by the steady advance we have made in design and performance. RIGHT NOW — "THANKS" to every one of you. We look forward to your continued support and advice as we go marching on.

Liberal time-payment plans and our new literature are available from many suppliers; such as Allied Radio Corp., Bob Henry, Montgomery Ward, The Radio Shack, Radio, Inc., of Tulsa, Wholesale Radio Service, Willard Wilson. If your dealer is not yet prepared to serve you with MIMS products, we will appreciate hearing from him — and from you.

MIMS SIGNAL SQUIRTERS are strictly "Ham" designed and engineered. We are proud of them and the records they have made all over the world. We hope that you, too, will take advantage of the performance of the Signal Squirter in the enjoyment of the grandest of all hobbies.

73.
M. P. Mims, W5BDB

SEE YOUR DEALER

MIMS RADIO CO.
SIGNAL SQUIRTER
PRODUCTS
TEXARKANA ARK. TEX.

Dr. Arthur C. Kennelly

(Continued from page 51)

internationally; so that modestly-adequate channels may be reserved for their activities in the great spectrum of radio-frequency allotments. Congratulations and success!

Isn't that a grand piece of writing? It is the testimony of one who loved us.

Dr. Kennelly was the originator of the hypothesis that an ionized layer in the upper atmosphere causes radio waves to bend around the surface of the earth. At about the same time, Oliver Heaviside, an English physicist, advanced the same concept. For years the English journals spoke of the "Heaviside Layer," the American ones of the "Kennelly Layer." Eventually they more or less got together on it and the region came to be called the Kennelly-Heaviside Layer, abbreviated K.H.L. The press, in noting Dr. Kennelly's passing, spoke of him as "co-discoverer" of the layer. It may interest our readers to know that he was actually the first. He published an article in the *Electrical World and Engineer* for March 15, 1902, in which he hypothesized a reflecting layer at an elevation of about 50 miles. Heaviside's first publication on the subject — a rather weak passing treatment on a "possible" basis, by the way — appeared in an article on telegraphy in Vol. XXXIII of the *Encyclopedia Britannica*, first published on Dec. 19, 1902. In recent years, of course, our knowledge has progressed to the place where we know there is not one layer but many, only one of which is the original Kennelly (or Heaviside) Layer which bent the long waves of early days around the curving globe; and now we call the whole region the ionosphere.

In Prof. Kennelly's passing, the scientific world has lost a brilliant mind, the whole world a charming gentleman, ourselves a valued friend.

A New Relay

(Continued from page 58)

The Type 3-U relays are normally supplied adjusted for operation at one milliwatt, which with the 10,000-ohm coil means 3.6 volts at only 0.3 ma. At 12-milliwatts input the spring tension can be considerably increased to provide much heavier contact pressures.

The magnetic materials employed in the new relay consist of parts fabricated from nickel-iron alloy, similar if not identical to permalloy. The parts are fabricated and then returned to the steel mill, partially assembled, for annealing under proper temperature control conditions, in an atmosphere of hydrogen. By the use of this process the magnetic properties of the material are claimed to be permanent.

The relay is supplied either with prong base for tube socket mounting or without. The use of a dust cover is recommended in view of the fact that the permanent magnet tends to collect magnetic particles from the atmosphere, with resulting danger that accumulation of particles of this type in the relay mechanism might interfere with its operation.

— C. B. D.

Make
MOST EFFICIENT
use of your
STATION POWER



Model 1696

Price

\$33.00

with New

TRIPLET

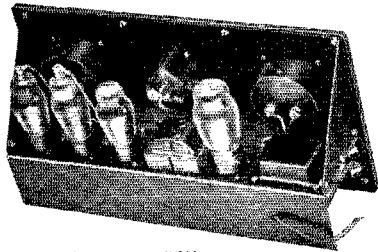

INTERIOR VIEW

**MODULATION
 MONITOR**

- ★ **USABLE ON ALL AMATEUR BANDS**
- ★ **PERMITS COMPLIANCE WITH FEDERAL REGULATIONS**

- **RED DOT Lifetime Guaranteed Meters**
- **110 Volt AC 60 Cycle Operation**
- **Two meters — one for Carrier, one for Per Cent Modulation**
- **Calibrated Neon Light for Instantaneous Peaks**
- **Tip Jacks for Phone Connection**
- **Uses Vacuum Tube Rectification**

MODEL 666-H

FOR all amateur use
 . . . 5000 Volts self-
 contained . . . Pocket
 size AC-DC Volt-Ohm-
 Milliammeter . . . No
 external multipliers
 necessary.

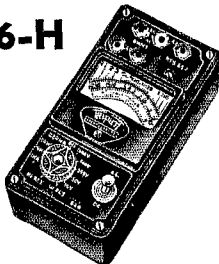

Price . . \$14.50

HERE is what hams have been waiting for to help them comply with Federal Regulations . . . a Modulation Monitor at a moderate price. Has self-contained carrier level adjustment control and modulation selector can be set for any desired modulation, 50% to 120% on positive peaks; 50% to 100% on negative peaks.

Whenever modulation exceeds the pre-set point, neon light flashes. Meter operates in less than 300 milli-seconds for full scale deflection and has delay circuit on down stroke, thus permitting accurate readings. Pilot light shows on and off condition. Switch can be thrown for observing either positive or negative peaks.

Features and accuracy compare favorably with most expensive types of modulation monitors. The RED DOT on the dial means meters are guaranteed for life against defects in materials and workmanship.

Model 1696 in Metal Case with Black Suede finish.
 Price **\$33.00**

Also available as a rack panel mounting unit.
 Price **\$33.67**

FREE TECHNICAL DATA ON REQUEST

THE TRIPLET ELECTRICAL INSTRUMENT CO.
 258 Harmon Ave., Bluffton, Ohio

Please send me technical data on Triplet New Modulation Monitor Model 1696. Model 666-H.

Name

Address

City State

OHMITE DUMMY ANTENNA

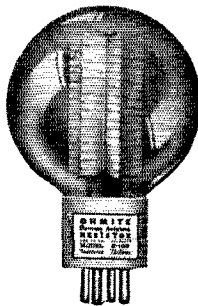

10 ways to
improve your rig

Do You Know: How much actual power is delivered at the end of your transmission line? Whether mismatch exists? Whether modulation is producing the required increase in power into the antenna? Find out this and more — step up efficiency — with the Ohmite Dummy Antenna, Model D-100, 100 watts, .75 ohm,

600 ohm and other resistances. **\$5.50**
List Price.....

Also available in 250 Watt Model

Send Today for Free Bulletin 111

OHMITE MANUFACTURING CO.
4864 Flounoy St., Chicago, Ill., U.S.A.

Be Right with **OHMITE**
RHEOSTATS • RESISTORS • TAP SWITCHES

Henry E. Benner, W6NVE

(Continued from page 38)

of California, he was born in Manton on December 22, 1901. At the time of his death he resided in Red Bluff, Tehama County, where he was employed by the Forward Bros. Lumber Co.

He is survived by his wife, Mrs. Alma Benner, and three small children, Noreene, Charles and Henry, Jr.

★ A.R.R.L. QSL BUREAU ★

For the convenience of its members, the League maintains a QSL-card forwarding system which operates through volunteer "District QSL Managers" in each of the nine United States and five Canadian districts. In order to secure such foreign cards as may be received for you, send your district manager a standard No. 10 stamped envelope. If you have reason to expect a considerable number of cards, put on an extra stamp so that it has a total of six-cents postage. Your own name and address go in the customary place on the face, and *your station call should be printed prominently in the upper left-hand corner.*

- W1 — J. T. Steiger, W1BGY, 35 Call Street, Williamansett, Mass.
- W2 — H. W. Yahnel, W2SN, Lake Ave., Helmetta, N. J.
- W3 — Maurice Downs, W3WU, 1311 Sheridan St., N. W., Washington, D. C.
- W4 — G. W. Hoke, W4DYB, 328 Mell Ave., N. E., Atlanta, Ga.
- W5 — E. H. Treadaway, W5DKR, 2749 Myrtle St., New Orleans, La.
- W6 — Horace Greer, W6TI, 414 Fairmount Ave., Oakland, Calif.
- W7 — Frank E. Pratt, W7DXZ, 5023 So. Ferry St., Tacoma, Wash.
- W8 — F. W. Allen, W8GER, 324 Richmond Ave., Dayton, Ohio.
- W9 — Alva A. Smith, W9DMA, 233 East Main St., Caledonia, Minn.
- VE1 — L. J. Fader, VE1FQ, 125 Henry St., Halifax, N. S.
- VE2 — C. W. Skarstedt, VE2DR, 236 Elm Ave., Westmount, P. Q.
- VE3 — Bert Knowles, VE3QB, Lanark, Ont.
- VE4 — George Behrends, VE4RO, 186 Oakdean Blvd., St. James, Winnipeg, Manitoba.
- VE5 — H. R. Hough, VE5HR, 1785 First St., Victoria, B. C.
- K4 — F. McCown, K4RJ, Family Court 7, San-turce, Puerto Rico.
- K5 — Norman F. Miller, K5AF, 15th Air Base Squadron, Albrook Field, Canal Zone.
- K6 — James F. Pa, K6LBH, 1416D Lunalilo St., Honolulu, T. H.
- K7 — Jerry McKinley, K7GSC, Box 1533, Juneau, Alaska.
- KA — George L. Rickard, KA1GR, P. O. Box 849, Manila, P. I.

Cheap INSURANCE



Wet type electrolytics have a place in some of your circuits. Especially for taking heavy punishment of peaks and surges. Self-healing, they instantly reform after breakdown.

★
AEROVOX "wets" offer adequate venting to safeguard against excessive gas pressures while avoiding leakage and seepage of electrolyte, and troublesome corrosion of components.

Ask . . .

Your jobber can show you these wet electrolytics, 150, 250, 350 and 500 v. D.C. peak, 4 to 40 mfd. Ask for latest catalog.

AEROVOX
CORPORATION
NEW BEDFORD, MASS.
IN CANADA: AEROVOX CANADA, Limited, Hamilton, Ont.

The RADIO SHACK

Presents
hallicrafters
Skyrider **DEFIANT**

MIMS SIGNAL SQUIRTER

We have been appointed distributors for MIMS SIGNAL SQUIRTER. Available on our liberal time payment plan. Write for particulars.

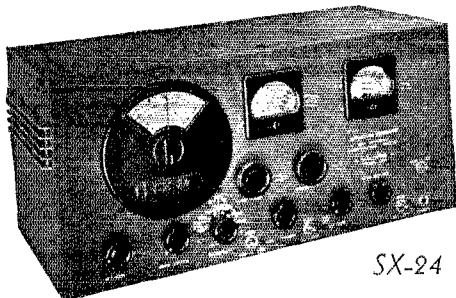

SX-24

WITH FREQUENCY METER TUNING
INCLUDING TUBES AND
CRYSTAL BUT LESS SPEAKER **\$69.50**
Speaker \$12.50 extra

General Coverage: 43.5 to .54 MC in 4 bands —
Built-in Noise Limiter — Crystal Filter — Variable
Selectivity — Frequency Stability — Break in Re-
lay Operation — 9 TUBES — S Meter calibrated
in S units and DB — Main Tuning Dial directly
calibrated — Electrical Band Spread directly cali-
brated.

LIBERAL TIME PAYMENT PLAN

Model	Down Payment	Per Month for 12 Months
SX-24	\$13.90	\$5.00
SX-24 and speaker	16.90	5.90

HALLICRAFTER FREQUENCY STANDARD

Model HT-7

FOR USE IN

- Checking Transmitter
- Frequency Receiver
- Checking Receiver
- Calibrations
- Calibrating Receivers
- Bandsetting Receivers
- Locating Signals for Sked
- Setting ECO Frequency

NET PRICE **\$29.50**

Complete
or \$5.50 Down and
\$4.83 per month for
6 months

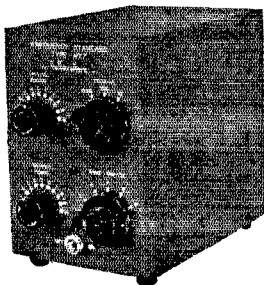

Sensational Value

TRANSMITTING CONDENSER

Cap. Mfd.	Working Volts	Net Price
2	1000	\$.95
2	2000	1.49

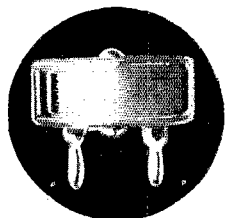

X-CUT 40-METER MOUNTED CRYSTAL

7000 to 7200 KC

Supplied within 10 KC of your
desired frequency.

Special Net Price **\$1.95**

UNMOUNTED CRYSTALS

7000 KC TO 7300 KC

Within 10 KC of your desired
frequency.

Special Low Price **\$1.35**

BUY ON
EASY TERMS

MAIL ORDERS
PROMPTLY FILLED

EXPORT DIVISION
9 CORNHILL ST., BOSTON, MASS., U.S.A.

The RADIO SHACK

46 BRATTLE ST. - BOSTON, MASS. - U.S.A.

QUALITY ABOVE ALL

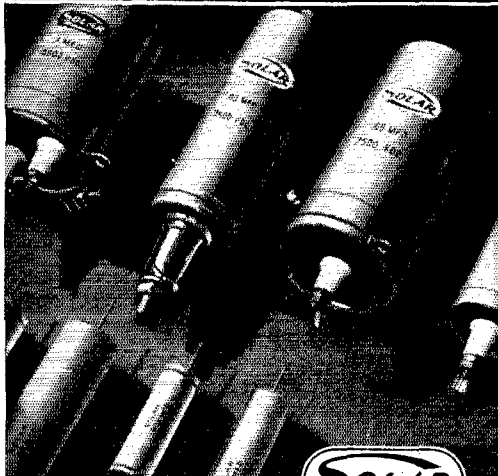

TELEVISION CAPACITORS

For Advanced Amateur Experimental Use
Wider High Voltage Safety Margins
Write for Our Bulletin T-1

SOLAR MFG. CORP.

Bayonne • New Jersey

RADIO ENGINEERING



RCA Institutes offer an intensive course of high standard embracing all phases of Radio and Television. Practical training with modern equipment at New York and Chicago schools. Also specialized courses and Home Study Courses under "No obligation" plan.

Illustrated Catalog on request

RCA INSTITUTES, INC. Dept. ST-39

A Radio Corporation of America Service

75 Varick St., New York 1154 Merchandise Mart, Chicago

READ AND SEND CODE

Learn Easily at Home
This Quicker Way

No experience needed. Beginners read code quickly, copy accurately. If already an op, speed up your wpm with this approved, amazing, all Electric Master Teleplex Code Teacher. Only instrument ever produced which records your sending in visible dots and dashes on specially prepared paper tape—then sends back your own key work at any speed you wish. Fascinating, fool-proof—get results because you learn by HEARING as well as SEEING. That is why thousands agree this method is surest and quickest. While not designated standard equipment, Teleplex is used at many U. S. Army Posts, Naval Training Stations. We furnish Complete Course, lend you the New All Electric Master Teleplex, and personal instruction with a MONEY-BACK GUARANTEE. Low cost, easy terms. Write today for folder Q-8, no obligation.



'HAM' SPECIAL

Standard Teleplex—a highly efficient code teacher using heavy specially prepared waxed paper tape, having two rows of perforations. Write for Free folder "Q.T.8."

TELEPLEX CO., 67-68 Park Place, New York

In Canada, Write

Canadian Electronic Institute, Toronto, Ontario



**ALWAYS
BE
CAREFUL**



(A) Kill all transmitter circuits completely before touching anything behind the panel.

(B) Never wear 'phones while working on the transmitter.

(C) Never pull test arcs from transmitter tank circuits.

(D) Don't shoot trouble in a transmitter when tired or sleepy.

(E) When working on the transmitter, avoid bodily contact with metal racks or frames, radiators, damp floors or other grounded objects.

(F) Keep one hand in your pocket.

(G) Develop your own safety technique. Take time to be careful.

Death Is Permanent!

U.H.F. Activity

(Continued from page 45)

should prove of value to those planning on using "2½" as well as to those already on the band.

What They're Using on 2½

WIBBM, North Harwich, Mass.: Antenna: Western Y matched impedance, with 6' by 6' chicken wire screen as a parabolic reflector, 440-ohm feeders; 15 watts input to 6J5G transmitting tube. Receiver: 6J5GT feeding a Breting 9 audio. DX: 80 miles. WIBHL, Hopkinton, Mass.: Antenna: J type with reflector and director, all in attic, E01 feeder to RK34 in short lines, 42 modulator; 14 watts input. DX: 28 miles. WIDEK, Waltham, Mass.: RK34, 42's modulator, 76 speech. Western Y antenna. Receiver: 6J5GT to audio amplifier. DX: 38 miles. WIDPP, West Concord, Mass.: RK34 to a Western Y antenna. Receiver: 37 to audio amp. DX: 30 miles. WIEYR, Sharon, Mass.: Western Y antenna. RK34 short lines, 2A5 modulator, 5B mike. Receiver: Acorn 955 to 41 audio. WIFIK, Lincoln, Mass.: Pickard antenna. Pair '45's long lines, modulator 59's, speech 56. Receiver: 56 detector, 56 audio. Also transceiver for mobile work, 37-41. WIFBX, West Roxbury, Mass.: HK24's short lines grid and plate, 65 to 100 watts input. Modulator, 6L6's Class B to four '46's Class B, crystal mike. Receiver: 6J5GT, 6C5, 6V6 audio. WIFSN, Malden, Mass.: Western Y antenna. Pair 6F5's TNT, 6L6 modulator. Receiver: 41 detector, 6F6 audio. WIGCU, Waltham, Mass.: RK34 short lines. Modulator: '46's Class B. Receiver: Superhet. Western Y antenna. WIHXY, Everett, Mass.: 6A6, 42 modulator. Western Y antenna. Receiver: 41 detector. WIJLI, Dedham, Mass.: HK24's short lines, modulator four '46's Class B 2A5's, 56 speech. Receiver: 6J5GT to audio amplifier. Mobile rig:

NEW

Safety

**IN THE NEW
STANCOR**

**"Thorobred"
TRANSFORMERS**

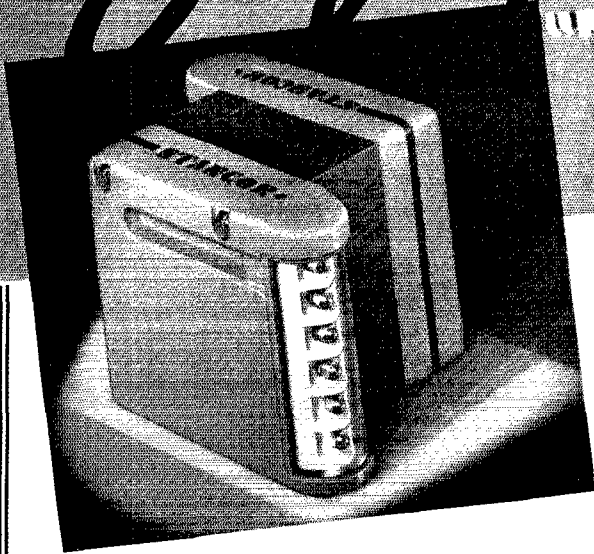

America's FIRST Safety Plate Transformer — has fully protected, advantageously located, readily accessible — yet visible terminals. Novel method of connecting coil leads to extra heavy terminals, mounted in oversize porcelain insulator. Special impregnation together with special compound filling, assure greater margin of overall safety. Rigidly constructed — cast iron cases provide exceptionally rugged chassis mounting. Built to last a lifetime. Truly the outstanding transformer available anywhere.

● The three new transformers described are evidence of Stancor's leadership in providing the latest in transformer developments.

They enhance Stancor's complete line of transformers for every purpose. For the ultimate in transformer values consult Stancor's Catalog 140-A now available from your Jobber. It gives you complete technical information and valuable charts to assure you that the correct transformers are being used at all times.

**STANDARD TRANSFORMER
CORPORATION**

1500 N. Halsted Street, Chicago

**Note These New Additions
to the STANCOR Line**

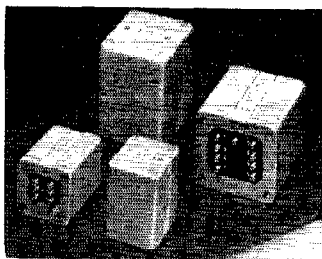

The New STANCOR "HI-FI"

Advanced in design "High Fidelity" coils are of pie-wound and hum bucking construction. Uniform frequency response from 30 to 15,000 C.P.S. High Permeability alloy laminations. Attractive in appearance and price.

The New STANCOR TINYTRAN

For Portable Equipment, aircraft work — size 15/16" in diameter by 1 1/4" in overall height. Hum pick-up is extremely low. New beauty, new performance.





**POCAHONTAS
SAVED JOHN SMITH
FROM ONE BIG HEADACHE!**

But stop to consider the *countless headaches* we save every day, right here at Terminal!

There's no need to fear a "shortage" at Terminal, one of the best stocked radio supply houses in the East! And why fret over a "puzzler" in your rig — when experienced hams are here to help you! Prices, too, need not faze you, because they're always low at Terminal!

So stop worrying... visit the Terminal store nearest you!

TERMINAL Radio Corp.

68 West 45th St. • 80 Cortlandt St.
2 stores in NEW YORK CITY
Vanderbilt 6-5050 • Cable: TERMRADIO

Pair of 76's TNT; modulator, 6A6 Class B, 37 speech; receiver, 37-41; two Mallory Vibropacks; antenna, two-foot rod against ear ground, tapped off to feeder seven inches above ground. **WIJOU**, Southville, Mass.: Antenna: Two half waves in phase. Pair of RK18's, tuned filaments, parallel plate rods; modulator, pair 6E6's. Receiver: 76, 6F6. **WIJQA**, Randolph, Mass.: HK24's short lines. Receiver: 6J5GT detector to audio amplifier. **WIKDY**, West Newton, Mass.: Half-wave single-wire-fed antenna, 25 feet high, to a single HY616 plate and grid rods. Modulator: 6L6, SB mike. Receiver: Acorn 955 to 6F6 audio. **WIKIK**, mobile, Mt. Wachusets, Mass.: Transceiver, 37-41. **WIKNI**, West Medford, Mass.: Johnson Q antenna. Pair '45's TNT. Modulator: 2A5 Class A, two stages speech, crystal mike. Receiver: 6J5GT to 41 audio. **WIKWR**, Stoneham, Mass.: Operating mobile with 37-41 transceiver. **WIKXR**, Cambridge, Mass.: HK24 short lines. Receiver: 37-41. **WILAT**, Boston, Mass.: Single '45 with 28 watts input. Modulator: 2A5, 56 speech. Receiver: 37 with separate quench tube. **WILDD**, Roxbury, Mass.: Pickard antenna. 6E6 TNT. Modulator: 42's parallel, 76 speech; 15 watts input. Receiver: 6J5GT, 76, 42 audio. **WILEM**, South Boston, Mass.: Johnson Q antenna. 6E6 TNT. 2A5's modulator, 56 resistance coupled speech. Receiver: HY615, 56, 2A5 audio. **WILIO**, Newtonville, Mass.: Transceiver, 76-41. **WILMU**, Waban, Mass.: Half-wave doublet antenna. Pair '45's short lines, '47 modulator, 27 speech. Receiver: 56-27. **WILSR**, Randolph, Mass.: Western Y antenna, 22 feet high. Transceiver: 56-2A5. **WISS**, Arlington, Mass.: Johnson Q antenna, 42 feet high, 440-ohm feeders. Also Yagi beam using Johnson Q, 440-ohm feeders, one reflector in back of antenna, one reflector each side, three directors in front. Beam is in attic and rotates 320 degrees. Signals S3 on straight antenna will be S7-8 on beam. Transmitter: Pair HK24's untuned grid, tuned plate line to coil. Receiver: National 1-10. Mobile rig: Four-foot rod, Zepp-fed; RK34 TNT; modulator, 79 Class B, 89 speech, SB mike; receiver, 6J5GT, 37, 41; dynamic speaker.

WILDD, Roxbury, has made 508 contacts with 39 stations since December 1st. While running two watts input to transceiver at Gloucester, Mass., **WILVN** was heard at **WISS**, a distance of 27 miles.

Additional 112-Mc. Notes

W9LRT, **W9UTS**, **W9OBW** and **W9YGW** are working for more activity around Chicago. **W9UTS** is using a pair of 801's parallel rod oscillator with 90 watts input. **W9LRT** and **W9YGW** use 76's in their rigs. These four stations are on the air around 8 P.M. EST nearly every evening, and invite contacts. . . . The Queens Radio Amateurs recently held a "2¼ meter" contest. **W2CWE** was first prize winner with 76 points. **W2AOD** and **W2GGN** tied with scores of 44. Practically the whole club participated, and the band was jammed with signals each Sunday of the fray. Highlights were contacts between **W2CWE**, Brooklyn, N. Y., and **W2LOC**, West Orange, N. J. (18 miles), **W2HIK**, West Orange, and **W2BRO**, Delawanna, N. J. (18 miles). **W2CWE** used a single '45 in linear oscillator running about 20 watts. **W2GGN** used the same outfit toward the close of the con-

Special Summer Offer Good Only Until September 10 . . .

FREE CREDIT 4 Months to Pay—Only 20% Down and NO CARRYING CHARGES!!

Every Set Shipped in Brand New Original Unopened Factory Carton

★ PLATE AND TRANSFORMERS

600 VOLTS 200 MILS
Special NEWARK value! Famous plate and filament transformer made for us only. Thousands used in Ham rigs. 600-0-600 at 200 M.A., 2.5v. at 10 amps.; 5v. at 3 amps. 7.5v. at 3 amps. Weight 10 lbs. Use this transformer for your buffer and final amp. stages. Just the thing for 46's, 120's, 807's.
Price (N1000)..... **\$2.95**



Oil Filled, Oil Impregnated FILTER CONDENSERS

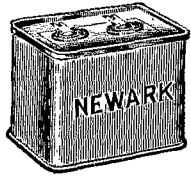

Only \$1.25
(1250 v. DC; 3 mid; 3 1/4 x 3 1/4 x 1 1/4; 1 1/2 lbs.) included in your time payment order for only 25c to 55c extra down payment. These are well-known makes and only a few left of each. Guaranteed at rated voltages.

DC Volt	Mfd.	Size	Wt.	Price
2000	2	4 1/4 x 3 1/4 x 1 1/4	1 1/4 lbs.	\$1.50
1250	3	3 1/4 x 3 1/4 x 1 1/4	1 1/4 lbs.	1.25
1500	3	5 x 3 1/4 x 1 1/4	1 1/4 lbs.	1.50
1500	4.4	5 x 3 1/4 x 1 1/4	1 1/4 lbs.	1.75
1500	5	3 3/4 x 3 1/4 x 1 1/4	1 1/4 lbs.	1.90
2000	8	5 x 3 1/4 x 3 1/4	2 1/4 lbs.	2.75

★ Your CALL LETTERS in GOLD 10c ★

Big shadowed decalcomania letters nearly TWO INCHES high. Put them on your HAM SHACK door, auto window, etc. Send dime for yours today. Be sure to give your call letters.

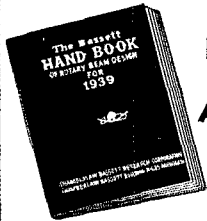

NEW BASSETT BEAM ANTENNA MANUAL

25c

42 pages chock-full of real meaty dope on rotary beam antenna design, engineering and operation. The most up-to-date book of its kind on the market today.

Newark can supply all new ham equipment as advertised anywhere and any time by any reputable manufacturer — on the same four-month credit plan, — no carrying charge.

Full line of amateur equipment, sets and parts totaling \$25.00 or more now available on a new credit plan. Pay only 20% down. Balance in FOUR EQUAL MONTHLY PAYMENTS and no carrying charges — no interest — no service fees. All merchandise shipped immediately, from big stock on hand, as soon as credit is ok'd.

➔ NATIONAL ➔

NC 101X..... \$129.00

Only \$25.80 down, \$25.80 per month. Four months to pay — No carrying charge.

NC 100XA..... \$142.50
Only \$28.50 down, \$28.50 per month.

NC 44..... \$49.50
Only \$9.90 down, \$9.90 per month.

NC 80-81X..... \$99.00
Only \$19.80 down, \$19.80 per month.

HRO DE LUXE..... \$179.70
Only \$35.94 down, \$35.94 per month.

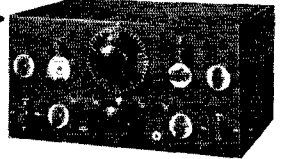

HAMMARLUND ED-4 TRANSMITTER KIT

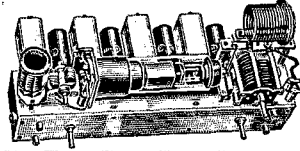

The ED-4 is identical to EU-4 except that additional Hdwe. is provided for adding RK-47 or 814 Beam Power Tube. This forms a 100 Watt Xmtr. measuring only 17" x 8" x 9 1/4". The ED-4 can also be used for driving a high power final amplifier such as the PA-500.

ED-4 — Foundation Unit only.....\$8.10

ED-4 — Foundation Unit with Kit of Hammarlund Units only...\$31.59

WRITE FOR FREE BOOKLET

HQ 120..... \$129.00

Only \$25.80 down, \$25.80 per month. Four months to pay — No carrying charge.

HALLICRAFTER Frequency Standard HT 7 \$29.50

For Use in Checking Transmitter Frequency, Checking Receiver Calibrations, Calibrating Receivers, Bandsetting, Locating Signals for Skeds and Setting ECO frequency.

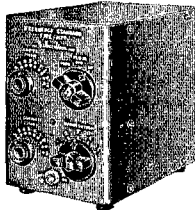

RME 70 \$138.60

Only \$27.72 down, \$27.72 per month. Four months to pay — No carrying charge.
RME 69.....\$152.88
Only \$30.58 down, \$30.58 per month.

RME 70 — DB 20 combination.....\$181.80
Only \$36.36 down, \$36.36 per month.

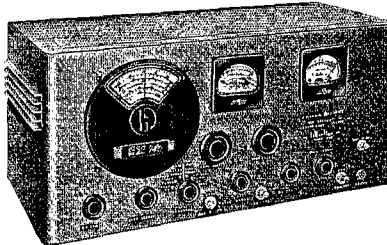

Brand New — Latest Out HALLICRAFTER SX 24

Complete with Tubes, Crystal and Speaker, \$81.50. \$16.30 down, \$16.30 per month. 4 months to pay. No carrying charge.

SX 25..... \$127.50
\$25.50 down, \$25.50 per month.
SKY BUDDY..... \$29.50
\$5.90 down, \$5.90 per month.
SKY CHAMPION..... \$49.50
\$9.90 down, \$9.90 per month.
SKY RIDER #10..... \$69.50
\$13.90 down, \$13.90 per month.
SKY RIDER MARINE..... \$64.50
\$12.90 down, \$12.90 per month.

★ NEWARK'S FAMOUS 6% EXTENDED PAYMENT PLAN

is also available on orders of \$60 or more, sets and parts, for those desiring a longer time payment period. Send only 20% DOWN PAYMENT with your order. Add 6% carrying charge to the remaining balance and simply divide by the number of months you wish to pay, up to 12 months.

WRITE TODAY FOR OUR FREE CATALOG

NEWARK Electric Company

323 W. MADISON ST.
Dept. Q CHICAGO, ILL.

QUESTION: What's the finest capacitor money can buy?

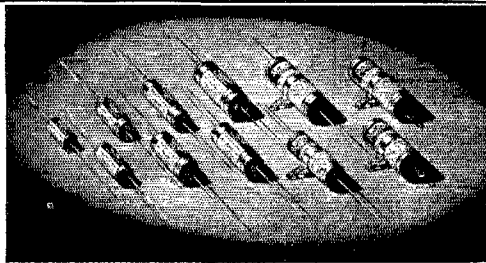

Many amateurs will say —

ANSWER: CORNELL-DUBILIER — but they cost no more!

**HERE'S A TYPICAL EXAMPLE —
TYPE BR (Blue Beaver) DRY ELECTROLYTIC CAPACITORS**

FEATURES: Exclusive electro-chemical etching; eliminates corrosion. Hi-purity aluminum foil; better direct current leakage recovery. Special C-D super-purity cellulose separator; long life. Double ageing; stable characteristics. All aluminum tube and accessories; uniform results in all weather. Special vent safety under all operating conditions. Tubular compact construction; allows ease of wiring into circuit.

For complete details on the type BR and other C-D capacitors send for catalog No. 165A.

Product of the World's Largest Manufacturer of Capacitors



**CORNELL-DUBILIER
ELECTRIC CORPORATION**

1013 Hamilton Boulevard, South Plainfield, New Jersey
Cable Address: "CORBU"

110 VOLTS AC Katolight Plants

Anytime, Anywhere! with
Have special plant for operating radio receivers and transmitters. Close voltage regulation. Full 850 watts AC and 100 watts at 6 volts. Filtered and Shielded.
Amateur's price—JRA5, 950 watt \$66.00
Amateur's price—JRS5, 550 watt 97.50

Other sizes up to 10,000 watts.
Both gasoline and Diesel.

KATOLIGHT, Mankato, Minn., U.S.A.

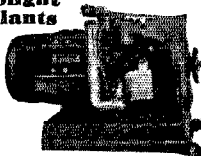

OWN A NEW VIBROPLEX FOR

Genuine Improved **VIBROPLEX** Latest Model

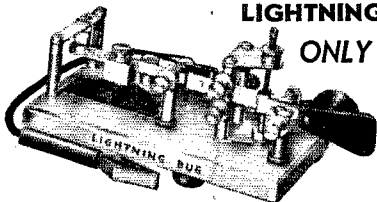

**LIGHTNING BUG
ONLY \$13.75**

Mounted on Heavy Black Base

Formerly sold for \$17.00

Nickel-plated \$2 additional

THIS is the same Genuine Great New Easy-Action Vibroplex that formerly sold for \$17.00 — the same fine instrument that is preferred for its ease of handling, fine quality signals, and all 'round satisfying performance. Now, for the first time you can own this amazing BUG for only \$13.75. Mail us your order to-day. Money order or registered mail. This unusual low price is limited and may be withdrawn without notice. Don't miss this opportunity to own the BUG you've always wanted at a price you can afford to pay. Act NOW! Write for new complete catalog just off the press and new price list.

THE VIBROPLEX CO., INC.
832 Broadway, New York, N. Y.

**JUNIOR
only \$12.50**

Small, highly efficient BUG. Complete with wedge and cord

test. W2AOD used a '10 linear oscillator with 40 watts input. All antennas were single wire-fed verticals. W2CWE, AOD, GGN, LPJ, CKQ, KPA, LUX, LGS, KXG and LEA were active in the contest. Non-members worked included W2KDB, KBH, HBO, HIK, LOC and BRO. . . . W3AXC and W8ICD are maintaining a 112-Mc. circuit in the New Brunswick, N. J., area. W2AHN, Westfield, N. J., has been worked by W8ICD (about 13 miles). W3ICD has grid and plate lines '45's; 20 watts; super-regen receiver. W3AXC has a long line rig with 70 watts. W3ICD was heard by W2KYT, Franklin Square, Long Island, N. Y. (about 50 miles), on June 2d, 9:00 to 10:30 P.M. EDST. W2KYT heard LCD calling W3DWL, Baltimore, and W2JTP, Hempstead, L. I. ICD was S7 on peaks. W2KYT has worked W2BZB, Fallsades, N. J., and W2HCL, Grantwood, N. J. (each about 20 miles distant), and W2BRO, Delawanna, N. J. (25 miles). KYT has also worked several Brooklyn stations and heard W2DAR, West Orange, N. J., and W2FER, Nutley, N. J. He is using an RK34 with 30 watts input and a two-wire matched impedance antenna, 35 ft. off the ground. Receiver uses 6J5G and 42. . . .

J. J. Edgerly, W1BOO, of Swansea, Mass., writes as follows: "The first 2½-meter activity started here when I built a couple of experimental transmitters and receivers about three years ago. Since then progress has been made to the point where there are now about eleven transmitters and sixteen receivers here in the vicinity of Fall River. There are four portable-mobile transmitters in town, and we are conducting experiments on 3-element beams (all copper tubing, using three fittings and no insulators). I have built seven rigs for some of the hams around here, using HY25's in the better ones. Inasmuch as the transmitters use only the tubes, copper tubing for plate and filament lines, two sockets, two 4" and one 1" insulators, and no resistors, condensers or chokes, outside of the power supply, they are the answer to a ham's prayer for a cheap and well-performing rig. The HY25's work fine on as low as 250 or 300 volts, and when a chap wants to increase power he has only to increase his power supply voltage. The rig at W1BOO has a pair of HY25's, T.P.T.F., working at 40 watts input, with a half-wave vertical radiator. Receiver is a National 1-10 using half-wave vertical antenna of telescoping copper tubing, for tuning. This latter is very important. There are 36 or more active stations in this vicinity. We are on the air every evening from 7:30 EDST and Sunday mornings."

W1BOO has worked W1AHP, BJE, CRN, EBA, FDR, GPE, GWL, IVA, JGD, JUN, KEL, KZN, LCN, LKH, LRO, MHB, MXA and SS (49 miles), and heard BBM (57 miles), DTW, JQA, FBE, LKN, BGA, KFL, LEM (44 miles) and OJF.

According to W1DWK, Devon, Conn., "2½ meter" activity is quite high in Southern Connecticut. W2BXW, portable-mobile near Stamford, was contacted by W1CPL of Devon, a distance of about 25 miles. W2KYT, Franklin Square, L. I., has been heard in the vicinity of Bridgeport, about 46 miles. W1CPL finds 112 Mc. better than 56 Mc. for local work, comparing miles per watt for a given signal strength. W1FMU, Devon, has an RK34 oscillator on the band. Active stations in the Bridgeport area are W1CPL, JH, JKC, JRV, KQT, LPW, LRW, LEI, KJF, DWK and KPN (portable-mobile). Elevation above sea level in this area varies from 20 to 80 feet, with most of the gang on an average of 45 feet. For antennas, the Yagi beam and all its variations is the most popular, but dipoles, a 3.5-Mc. Zepp, and all forms of 8JK beams from simple to square corner all work well. Says W1DWK, "Believe it or not, some tubes that work on 2½, although not efficiently, are 201A, Sperton C401, 250, 245, 226, 227 and 56. . . . Better receivers will be the answer to making this band even more popular than 5 has ever been."

Strays

The capacity of the National NC600 cartridge-type neutralizing condenser can be increased to 6 or 7 μfd. by winding a metal band about 5/8-inch long around the ceramic and soldering it to the lead cap opposite the adjusting screw. As an alternative, a piece of tinfoil may be used. In this manner I used the condenser to neutralize a type HY40.

— W6HJT

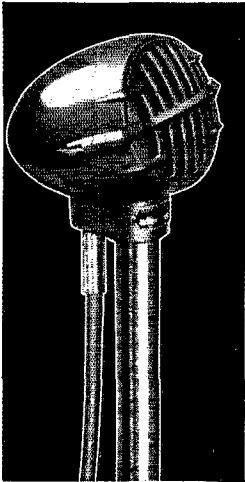

JT-SERIES

PHOTO CONTEST ANNOUNCEMENT

Winners in Astatic's Photo Contest closing August 1, will be announced in the September issue of QST.

Astatic JT-Series Crystal Microphones

Available in Voice and Wide-Range Models

The JT-Series, primarily intended for Public Address, is presented in four new, semi-directional models of contemporary design that fill a long standing demand for a really good low priced microphone for universal use. Voice or wide-range models with 7-ft. cable. **LIST PRICE \$16.50**

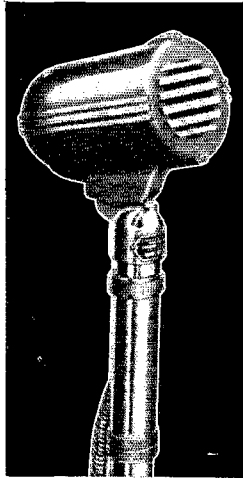

DYNAMIC

New Dynamic Microphone

Correctly designed magnetic structure and carefully proportioned acoustic circuit, together with Astatic's precision-centered, unitary moving coil system, provide a response characteristic substantially flat from 50 to 7,000 cycles. Tilting head for semi or non-directional positions. Output level -55 db. Two-tone opalescent gray and chrome finish. Equipped with plug-connector and 25-ft. cable.

Model DN-50 LIST PRICE \$20.00

Transformer Models \$22.50

(See Jobber or Write for New Catalog No. 12)



Astatic Microphone Laboratory, Inc.

Youngstown, Ohio

Licensed Under Brush Development Co. Patents

SICKLES COILS

SECURE A COPY OF OUR NO. 939 CATALOG FROM YOUR JOBBER

F. W. SICKLES COMPANY

300 Main Street

Springfield, Mass.



TRANSFORMERS

For Radio and Television Applications

Specialists in the engineering and production of quality transformers, Acme solicits your inquiry. Manufacturers of transformer specialties such as the

ACME VOLTROL

manually operated voltage regulator, stepless control from 0 to 130 volts. Panel mounted type illustrated \$12.00. Write for Bulletin.

THE ACME ELECTRIC & MANUFACTURING CO.
38 Water Street

Cuba, N. Y.

• TELEGRAPHY—TELEVISION—TELEPHONY •

AVIATION

TRANSRADIO
PRESS

TELETYPE

TYPEWRITING



PRACTICAL
EXPERIENCE

STUDIO —
TRANSMITTER —
ANNOUNCING

The major technical training equipment owned by Port Arthur College and in operation on the college campus consists of the 500-Watt Commercial Broadcast Transmitter of Station KPAC; two-way Television Transmitter and Receiver; Latest Type RCA Marine and Airways transmitter installation complete; SOS Automatic Alarm; Marine Direction Finder; Trans-radio Press Receiving Equipment, and Laboratory complete where students assemble composite transmitters, amplifiers, audio amplifiers, R. F. amplifiers, etc.

Port Arthur College pioneered the teaching of Radio with classes in 1909, and for thirty years has maintained an active Employment Bureau for the placement of its graduates.

If interested in details about Radio Course, write for Bulletin R

PORT ARTHUR COLLEGE ■ PORT ARTHUR (World-Known Port), TEXAS

Just what the
doctor ordered...

Ours is a "personal" service, whether we meet personally or not... we sell no "hokus-pokus" gadgets... and no all-purpose "solutions" for your xmitter troubles...

We cater mainly to amateurs everywhere... and we must RETAIN this patronage to exist. For years we have serviced you and other discriminating members in the amateur field... and we hope to continue doing so for many, many more years. Our method? ... Simple...

Our store does not depend upon "bargain-counter-specials" with a "buy-at-your-own-risk" policy... We sell standard products that we can GUARANTEE...

Nor are our prices influenced by a "get-as-much-as-we-can" urge... HARVEY charges are standard and popular.

Simple... We SATISFY our customers...

W2KWY, W2LJA, W2BQL, W2IJL

OUR *Best* VALUE IS OUR RECORD OF LOYAL SERVICE

HARVEY
Radio Company of New York

103 WEST 43rd STREET • NEW YORK, N. Y.

CABLE ADDRESS: "HARADIO"

1.75-Mc. W.A.S. Party

(Continued from page 47)

W4EWP 3007, W9PV 2772. Highest scorer among those who used "c.w. only" for transmissions was W1BFT, 2178.

Logs were received from 163 operators in 39 states and Canada, and to use a time-worn phrase, "A good time was had by all" — both those who aimed at highest honors and those who were in it "just for fun." New states were worked by many. Several reported coast-to-coast contacts, among them W4BPD, W6QEU, W4EWP, W2KNO, W6KZN, W3GDI, W2CAY, W1DVC and W8PK. W6OXQ, on test schedule with K6PTW, 10:57 P.M. PST, February 19th, received a report of R5S5 on c.w., R4S5 on 'phone. K6PTW reported hearing W6AM, W7FWC, W6KUN, W6KZN, W6JWY and W6FTH. W6KZN was logged during the Party by VK3NG aboard the S.S. *Lanena* on the east coast of Tasmania at 1:25 A.M. PST, February 19th, R3/4S6. Between 0530 and 0630 GT, February 19th, G6WY logged the following (figures denote signal strength): VE1EA-6, W1APK-4, W1BB-6, W2DSH-5, W2FAR-5, W3BJU-5, W3BTQ-3, W8JSW-3 and 'phone W4BPD-3. G2PL logged the following on 1.75-Mc. 'phone during the party: W1DES, W1CPI, W1AAR, W9DAW, W8ETM and W4BAJ; on c.w. G2PL logged W3BJU. One feature of the Party was the successful use of low power by many participants. These used less than 40-watts input: W6PBQ 35, W8LIZ 15, W9MUX 32, W8ROA 20, W9QIM 19, W8KXS 21, W9CFB 7.5, W8QDP 15, W1HGX 30, W8PU 7, W9BKH 16-20, W2HBO 15, W1KIK 35, W9ZXA 30, W9SCH 9, W2CFW 10, W4EPT 20, VE3AWE 15.

The complete score list follows, giving score, number of states and number of contacts. Stations whose calls appear in boldface type submitted the highest scores from their respective states.

— E. L. B.

W4BPD	5040-36-140	W1BB**	1800-20-90*
W9HHR	1800-32-150	W6KZN	1748-19-92
W8IAR**	4118-29-142 ¹	W3GDI**	1680-24-70
W9UWL	4107-37-111	W8BOF	1680-20-84
W9KOH	3270-30-109	W8DOD*	1680-21-80
W3BJU**	3264-24-136	W5GNY	1620-27-60
W6QEU	3264-24-136	W9OGL	1584-22-72*
W8RUM	3232-32-101	W3EUH	1560-24-65
W4EWP	3007-31-97	W3BFX	1540-22-70
W9PV	2772-33-84	W6PRQ	1469-13-113
W3FDY	2576-28-92	W4FLS	1421-29-49
W1KUU	2553-23-111	W3FWP	1386-21-66
W2KNO	2553-23-111	W1GME*	1368-18-76
W8RGR**	2457-27-91	W8FKO*	1360-20-68
W4EGH	2310-30-77	W4FRX	1323-27-49
W1ERX	2288-26-88	W3EUK	1320-24-55
W1BFT*	2178-22-99	W8SVS	1200-24-50
W1ZK**	2100-20-105	W2CAY**	1197-21-57
W1AAR	2016-24-84	W8PIK	1173-17-69
W8RYM*	2016-21-96	W8PAK	1170-15-78
W4BZD	1890-27-70	W1JXV	1155-21-55

* Transmissions by c.w. only.

** Transmissions by both 'phone and c.w.

(Stations not marked by asterisks used 'phone only.)

¹ W8RYZ was assistant opr. at W8IAR. ² W1BB and W1HFF operated W1BB. ³ Portage Park Radio Club station: operated by W9TXZ, W9AAU, W9MFS, W9ZFP, W9ZSS, W9BEA, W9ULX, W9OLD, W9NPA. ⁴ W8CYQ was operated by F. E. Larham (CYQ) and C. E. Drakeley. ⁵ W8QGD, W8QQK and W8FTW were operators at W8PVK. ⁶ W2HBO operated Tu-Boro Radio Club station W2JIQ. ⁷ HQs staff members; not competing. ⁸ W1JTD operated W1AW.

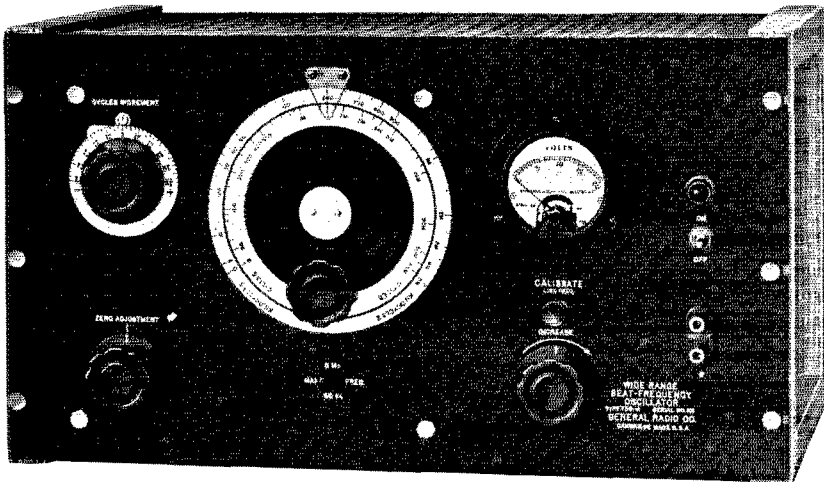

● FOR TESTING TELEVISION AMPLIFIERS, coaxial cables and other wide-band systems, the new G-R Type 700-A Beat-Frequency Oscillator is ideal. It has a direct-reading range of 50 cycles to 5 Mc., excellent frequency stability, constant output voltage within 1.5 db over its entire range, good waveform, and is a-c operated. It is moderately priced at \$555.00.

WRITE FOR BULLETIN 453 FOR COMPLETE DATA

GENERAL RADIO COMPANY, CAMBRIDGE, MASS.

\$29.50 SKYROTORS \$84.50

Model T

Model B

Model T SKYROTORS have been added to our popular Model B SKYROTORS giving us 7 motor drive units priced from \$29.50 to \$84.50.

The same high standards of material and workmanship are used throughout.

Write today for illustrated data sheets.

Also W8JK and 2 and 3 element 10 and 20 meter beam-kits using General Rotary elements and SKYTOWERS, the aristocrats of radio masts.

BEE ENGINEERING COMPANY

7665 Grand River Ave. Detroit, Mich.
The BEE-LINE from DETROIT

EASY TO LEARN CODE

It is easy and pleasant work to learn the modern way — with an Instructograph Code Teacher. Ideal for the beginner or advanced student. ■ Many tapes available ranging from alphabet for beginners to typical messages on all subjects. Speed range 5 to 40 WPM. ■ Always ready, no QRM, beats having someone send to you.

FOR SALE OR RENT

STANDARD with 10 tapes and book of instructions \$20.25

JUNIOR with 5 tapes and book of instructions (not rented) \$12.00

RENTAL Standard with 10 tapes and book of instructions \$3.00 first month, \$2.25 each additional month. All rental payments may be applied on the purchase price should you decide to buy the equipment.

Write for details today

INSTRUCTOGRAPH COMPANY

Dept. Q, 912 Lakeside Place, Chicago, Illinois

Representatives for Canada:
Radio College of Canada, 863 Bay Street, Toronto



A GOOD NAME GOES A LONG WAY

One of the outstanding superiorities of Ken-Rad Radio Tubes lies in the unusual skill in assembly, which makes for dependability in use.



Ken-Rad Radio Tubes

KEN-RAD TUBE & LAMP CORPORATION - OWENSBORO, KY.
Manufacturers of all types of radio tubes and Ken-Rad Electric Lamp Bulbs

GET THE FACTS ON CODE FROM CANDLER!

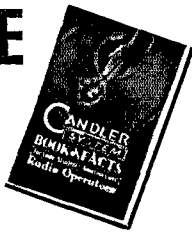

The man who has taught thousands the amazing Candler special method of real code speed. Don't spend hours alone, trying to overcome your own faults — let Candler correct them by the same method he has used to teach speed champions. Candler's expertly directed practice will help you even if you are a beginner starting to learn. Candler has the real short cut to code speed — ask any skilled "op" — and the cost is very low.

FREE! Write today for the big 52-page book — packed full of real helpful information, including new F. C. C. regulations, probable exam. questions. Don't delay — send for this book NOW! — There is no obligation.

CANDLER SYSTEM CO.

DEPT. Q8 ASHEVILLE, NO. CAROLINA, U. S. A.

LEARN RADIO • TELEVISION

60-page catalog on request. Oldest, largest and best equipped in New England.

MASS. RADIO SCHOOL

18 Boylston Street

Boston, Mass.

TIME right now to turn to pages four and five of this issue for the bargain of your radio **LIFE FORTUNE**
It is decidedly easy on your **FORTUNE**

An Amateur Version of a POLICE CAR TRANSMITTER popularly priced

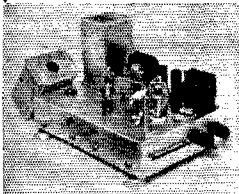

Type T-510 — 12 watt Crystal Controlled PORTABLE MOBILE TRANSMITTER with 28 and 56 Mc Band Switching.

See our line of APPROVED transmitters at our permanent QTH, the nearest radio factory to the NEW YORK WORLD'S FAIR grounds.

Completely revised literature just released on all models.

Type T-510 Kit.....\$21.80

RADIO RECEIVER LABS.

8627 115 Street

Richmond Hill, New York City

Cable Address: "RATRALAB"

W8MFV	1144-22- 52	W9QG*	338-13- 26
W8LCN*	1105-17- 65	W4FDE	308-14- 22
W3BTQ*	1102-19- 58	W2HAP	299-13- 23
W8IZS*	1064-19- 56	W1JRW	290-10- 29
W8BLP**	1037-17- 61	W3GWQ	288-12- 24
W3DQ	940-20- 47	W9BKH**	288-12- 24
W8CYQ	912-19- 48*	W1APK**	286-11- 26
W5CXH	897-23- 39	W8PBX	270-10- 27
W3ADE*	893-19- 47	W2HBO*	260-10- 26
W9MUX*	882-21- 42	W9MWU	256- 8- 32
WIDVC	864-18- 48	W9OPA	247-13- 19
W2KON	855-15- 57	W1KIK*	242-11- 22
W3FMF	840-21- 40	W9PNE*	231-11- 21
W6AM	840-15- 56	W9DI**	198-11- 18
W6ZM	816-12- 68	W1EWN	192- 8- 24
W3BHE	810-18- 45	W1EHJ*	190-10- 19
W9HUV*	810-18- 45	W7AXS	189- 7- 27
W3DGM*	800-16- 50	W9ZXA	184- 8- 23
W8ROA	800-16- 50	W8CSE*	180- 9- 20
W2HRZ	792-18- 44	W8HFR	165-11- 15
W9RII	792-22- 36	W3NT*	162- 9- 18
W9QIM*	722-19- 38	W2DOG**	160- 8- 20
W8KXS*	714-17- 42	W9SCH*	160-10- 16
VE3ATQ	704-16- 44	W9DDD	120- 8- 15
W8VZ	703-19- 37	W6OXQ	100- 5- 20
W9CFB*	703-19- 37	W3FJ	98- 7- 14
W9QLF	693-21- 33	W2CFW*	91- 7- 13
W9GPO	680-20- 34	W8CBI**	88- 8- 11
W2BFA**	672-16- 42	W5GAQ	84- 7- 12
W3GKR	644-14- 46	W9VRZ	78- 6- 13
W1KKB	629-17- 37	W4EPT*	72- 6- 12
W9UTL	600-15- 40	W9YZT	72- 8- 9
W4APU*	595-17- 35	W9RBR*	70- 7- 10
W9KBP	585-15- 39	W2JMX	70- 5- 14
W8QDP*	578-17- 34	W3HBE	63- 7- 9
W8PK*	576-16- 36	W6PDV	60- 5- 12
W5AHX	560-16- 35	W3HYF	28- 4- 7
W7GNJ	550-11- 50	VE3AW	20- 2- 10
W1HGX*	528-12- 44	W8LUJ	20- 4- 5
W8ORM**	528-11- 48	W3EOJ	18- 3- 6
W9TQD*	522-18- 29	W7BIS	18- 3- 6
W9WKP**	504-18- 28	W8PVK	18- 2- 9*
W9EKK	493-17- 29	W2JQV*	12- 3- 4*
W8MVQ*	462-14- 33	W6PQQ	12- 2- 6
W2EYS*	455-13- 35	W2ITV	10- 2- 5
W9ZAD**	420-15- 28	W8RRG	9- 1- 9
W8PU*	407-11- 37	W2LXI	6- 2- 3
W9SGL*	405-15- 27	W8ROX	5- 1- 5
W8ATT*	392-14- 28	W5SI	4- 2- 2
W3HLC	360-12- 30	W6DHS	3- 1- 3
W8KIJ*	360-12- 30	W2LNN	2- 1- 2
W1ERG	352-11- 32	W1AW**	2592-27- 967-*
W1KNC	350-10- 35	W1UE*	1491-21- 717*
W4FQP	345-15- 23	W1TS*	930-18- 557

Portable-Emergency Transmitters

(Continued from page 29)

is provided for, and one crystal socket is mounted on the front of the panel so that different crystals can be used in time of emergency.

The rig is housed in a cabinet 7 inches high, 10 inches wide and 6 inches deep. The chassis is home-made and shaped so that it contains the r.f. portion of the set but leaves room for the Vibrapack, which is permanently mounted to the floor of the cabinet. A four-prong plug and socket is used to connect the power supply to the r.f. portion, and allows the r.f. portion to be used with another power supply or the vibrator supply to be used with another transmitter when the occasion arises. The entire unit weighs about 15 pounds.

The antenna coupling may not be the best but it has always worked well here, loading wires anywhere from 2 to 400 feet in length. A distance of 25 miles has been worked on 80 meters with only a 6-foot wire for the antenna. Using the regular antenna, and running 275 volts at about 60 ma. to the set, no trouble is experienced with working stations up and down the coast from Canada to Mexico.

NO INTEREST CHARGE

absolutely no interest, finance, or service charge of any sort. On longer terms you can use Bob Henry's convenient 6% terms. All sales handled by myself so no finance company or third party is involved in the transaction. Your order will be shipped promptly from one of the world's largest stock of amateur receivers. So order from W9ARA and be assured of less cost, less red tape, and quicker shipment. Remember I specialize in supplying the newest equipment soonest. Order from this ad or write for full information.

You can buy any amateur receiver, transmitter, or parts for 20% down; balance in four equal monthly payments and you pay only the cash price with

COMPARE THESE TERMS WITH ALL OTHERS

Model	Cash Price	Down Payment	Payment	
			4 months	12 months
SX-24.....	\$69.50	\$13.90	\$13.90	\$4.90
SX-23.....	115.50	23.10	23.10	8.16
Sky Buddy.....	29.50	5.90	5.90	2.08
HQ-120X.....	129.00	25.80	25.80	9.11
RME-70.....	138.60	27.72	27.72	9.79
HRO Deluxe.....	179.70	35.94	35.94	12.70
NC101XA and 101X.....	129.00	25.80	25.80	9.11
NC100XA.....	142.50	28.50	28.50	10.07
Howard 460.....	79.95	15.99	15.99	5.64
Breting 9.....	54.00	10.80	10.80	3.81

Similar Terms on other receivers, transmitters, kits, parts

FLASH — Mims and other antennas available on my 6% terms. We can supply Thordarson and other kits assembled, wired, tested and ready to use

You can reach me by letter, telegram, phone, or visit nearly 24 hours a day, 365 days a year. I will help you get the best equipment for your use and will personally see that you are 100% satisfied. Your inquiries invited.

HENRY RADIO SHOP

211-215 North Main Street

Butler, Missouri

Bob Henry
W9ARA

THE COIL YOU WANT!



Whether it's a band expanding I.F.; Iron Core High Q High Gain I.F.; Regenerative Iron Core I.F.; B.F.O.; Noise Silencer; Oscillator; Multi-Band; or any other coil used in communications or broadcast receivers, or in UHF transmitters — you will find it in the latest catalog of DX precision made coils. DX Coils are used by well-known receiver manufacturers, engineers, service men, set builders, etc. Teachers of radio and students praise the color coded circuits shown in the catalog (DX Coils are color coded too) and say they are easy to understand. Leading radio parts jobbers have DX Coils

or can get them for you at attractive prices. Send 15 cents today with your jobber's name and receive the De Luxe DX catalog illustrating all coils in full size photos.

Also manufacturers spiderweb loop antennas used on latest model receivers

DX RADIO PRODUCTS COMPANY
1575-D Milwaukee Avenue Chicago, Illinois, U.S.A.

NEW VALPEY

Type VO 1

CRYSTAL OVEN

This new and improved crystal oven has been designed so that any crystal unit which mounts in a five prong tube socket can be plugged into it. The oven in turn plugs into the socket from which the crystal has been removed.

The oven operates on from 6 to 8 volts at .75 amperes and will hold the temperature constant to 1 degree centigrade. Heater voltage may be taken from the oscillator filament supply.

Descriptive folder available from your dealer or direct

THE VALPEY CRYSTALS

Box 321 HOLLISTON, MASS.

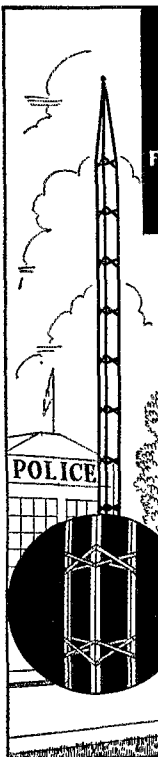
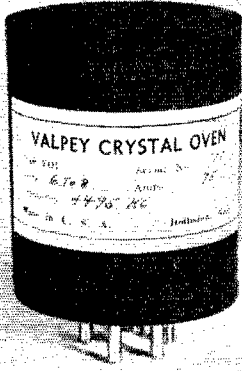

LOW COST STEEL ANTENNA TOWER

Used and Endorsed by
FEDERAL, STATE, COUNTY, CITY GOV'TS.,
FORESTRY, HIGHWAY PATROLS
and HAMS everywhere!

ONLY 60¢ PER FOOT Complete!

This remarkable low price is possible only because we produce many thousands of these towers each year for use with our Wincharger. Price includes necessary guy wires and tower sections of 10 or 20 ft. lengths with 5 ft. tapered stub top.

LIGHT, STURDY, RIGID

Thousands in use as vertical radiators and horizontal antenna supports. Scientifically braced. No points of undue strain. Both vertical angles and cross braces now hot dip galvanized.

SAFELY ERECTS TO 200 FT.

Quickly and easily erected, without skilled assistance, to heights of from 25 ft. to 200 ft. Enthusiastically used and recommended by police and broadcast operators for thoroughly satisfactory service.

READ U. S. FORESTRY LETTER!

Your tower was installed on Signal Peak, a Lookout Station on the Yakima Indian Reservation, at an elevation of 5,111 ft. above sea level. We have found the Wincharger tower 100% satisfactory and it has stood up under 70 mile winds, snow and ice which are severe at almost a mile up from sea level. Thomas L. Carter, Forest Supervisor, Office of Indian Affairs, U. S. Department of the Interior, Toppensish, Wash.

Order Direct From
WINCHARGER CORPORATION
Sioux City, Iowa



SPECIAL for AUGUST

GENUINE C-D CONDENSERS OIL IMPREGNATED — WAX FILLED LIMITED QUANTITY

	1000 V.*	1500 V.*	2000 V.*	3000 V.*
1 Mfd.	\$.75	\$1.10	\$1.29	\$1.98
2 Mfd.	—	1.59	1.95	3.24
4 Mfd.	1.59	2.29	2.95	—

* These voltages are actual D.C. Working Voltage

ROTARY BEAM HEADQUARTERS BASSETT — GENERAL ROTARY — MIMS — PREMAX — AMPLEX & Others

Sun Radio is fully equipped to provide your rotary antenna needs — as well as to assist you technically with your antenna problems. We will be pleased to supply information and descriptive circulars.

INFINITE XTALS

The Communication Measurements Lab **FRECO**
Variable Frequency Control

Built with frequency meter precision construction. T9X note on all bands to 56 Mc. Supplied with cable to plug into crystal socket of transmitter, providing stable control equal to an infinite number of crystals. Uses 6SK7, VR105 and 6L6 Tubes. Complete with tubes, less power supply. Net. **\$45.00**

FLASH! Television Experimenters!

We have essential components for deflecting circuits for RCA Kinescopes. These include:

High-voltage power transformers and capacitors vertical and horizontal oscillation (feedback) transformers, a vertical output transformer, horizontal output transformer, coupling capacitors, deflecting yokes, sockets, etc.

Come in or write in for the RCA folder describing these parts and showing complete diagrams for power supply and deflecting circuits.

KEEP UP TO DATE

Drop us a post card and your name will be placed on our mailing list for catalogs and interesting bulletins and circulars.

2 1/2 Mh. R. F. CHOKES

125 Ma. Rating. Standard 4-pie construction on ceramic with pigtail leads

14c

or 5 for **48c**

Every amateur should have a few of these useful R.F. chokes handy.

ABBOTT 2 1/2 METER TRANSCEIVER

Now you can really operate portable all summer. Model DK2 — Entirely self-contained — Tubes, Batteries, Transmitter and Receiver. Overall 11 1/2" x 9 1/2" x 6 1/2". Working range 2 to 30 miles.

Complete less tubes, batteries, microphone.
Amateur net **\$16.17**

VISIT SUN'S HAM SHACK AND
OPERATE ALL THE LATEST RECEIVERS

★ EXPORT ORDERS SOLICITED

★ MAIL ORDERS PROMPTLY FILLED



RADIO CO.

212 Fulton Street, Dept OT New York

Cable Address **SUNRADIO NEW YORK**

Strays

In order to limit the discharge of a condenser through the human body to only an unpleasant "kick," it is necessary to limit the capacity of filter condensers used at various voltages to the following values: 10,000 volts, 0.02 μ f.; 5000 volts, 0.08 μ f.; 2000 volts, 0.5 μ f.; 1000 volts, 2 μ f. These capacities at these voltages store an amount of energy equivalent to one Joule. It has been determined that this quantity of energy will not deliver a deadly shock. — *Sprague Condenser News*. Judging from some of the notes we hear on 14 Mc., some of the DX brothers are playing plenty safe!

— . . . —

W1LUX works for Lever Bros., manufacturers of Lux soap products.

— . . . —

Tungsol is publishing a handy booklet of tube-base diagrams. A 2-inch by 3-inch page is devoted to each diagram and the booklet has a spiral wire binding so that it lies flat when opened to any desired page.

— . . . —

For plugging mistakes in panels, small chromium-plated plugs with wing-nut fastenings are obtainable from many automobile supply houses. They are known as auto body plugs.

— W9DOY

— . . . —

Why aren't rivets used more frequently instead of machine screws in amateur construction? In many cases they are easier to use than machine screws and do not project as much as round-head screws. They can be removed quite readily with a hand drill.

— W9DOY

Correspondence

(Continued from page 58)

The most powerful nations of the world can get together on any other international subject, why not on radio communications? Why can't the small allotment of frequencies that we in the United States have, be for the entire world?

Maybe if the Federal Communications Commission of the United States was made up of engineers and technicians, and not of men who were given the job as political favors, allotments could be made which would be more favorable to everyone concerned.

What about a little publicity in our daily newspapers, and weekly and monthly magazines that are not strictly radio publications? The movie stars, radio stars, famous athletes, etc., that are amateurs, would make great human interest stories. Then tell the world the good that the amateurs have done in disasters the world over. Remind them also, that amateurs did 90 per cent of the experimental work that developed the short waves, and that we are getting nothing for it but a swift kick in the pants.

I wonder if the manufacturers of amateur equipment ever think how quickly they would be out of business if amateur radio is finally killed? Big business has always been able to pull strings in Washington; why not pull a few for us?

Now how about the A.R.R.L., in conjunction with the amateur societies of other countries, forming something like a 250,000 Club? With 250,000 amateurs in the world in the next five years, we would possibly have a louder voice in

Where to buy it

A directory of suppliers who carry in stock the products of these dependable manufacturers.



ALBANY, N. Y. Uncle Dave's Radio Shack 356 Broadway
ATLANTA, GEORGIA 265 Peachtree Street
 Wholesale Radio Service Co., Inc.
BOSTON, MASS. Radio Shack 46 Brattle Street
BOSTON, MASS. 110 Federal Street
 Wholesale Radio Service Company, Inc.
BRONX, N. Y. 542 East Fordham Rd.
 Wholesale Radio Service Company, Inc.
BUTLER, MISSOURI 211-215 N. Main Street
 Henry Radio Shop
CHICAGO, ILL. 833 W. Jackson Blvd.
 Allied Radio Corp.
CHICAGO, ILL. 901-911 W. Jackson Blvd.
 Wholesale Radio Service Company, Inc.
CINCINNATI, OHIO 1103 Vine Street
 United Radio, Inc.
DETROIT, MICH. 325 E. Jefferson Ave.
 Radio Specialties Co.
DETROIT, MICHIGAN 11800 Woodward Ave.
 Radio Specialties Co.
HARTFORD, CONNECTICUT 227 Asylum Street
 Radio Inspection Service Company
HOUSTON, TEXAS 4021 Huey Street
 R. C. Hall & L. F. Hall
JAMAICA, L. I. 90-08 166th Street
 Wholesale Radio Service Company, Inc.
KANSAS CITY, MO. 1012 McGee Street
 Burstein-Applebee Company
NEW YORK, N. Y. Harrison Radio Co. 12 West Broadway
NEW YORK, N. Y. 100 Sixth Ave.
 Wholesale Radio Service Co., Inc.
NEWARK, N. J. 24 Central Ave.
 Wholesale Radio Service Co., Inc.
READING, PENN. 404 Walnut St.
 George D. Barbey Company
SPRINGFIELD, MASS. T. F. Cushing 349 Worthington St.
WASHINGTON, D. C. 938 F Street, N. W.
 Sun Radio & Service Supply Co.

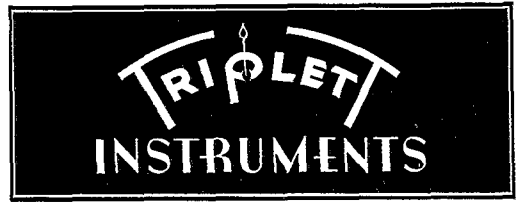

ALBANY, N. Y. Uncle Dave's Radio Shack 356 Broadway
ATLANTA, GEORGIA 69 Forsyth Street, N. Y.
 Garvin Electric Company
ATLANTA, GEORGIA 265 Peachtree Street
 Wholesale Radio Service Company
BOSTON, MASS. Radio Shack 46 Brattle Street
BOSTON, MASS. 110 Federal Street
 Wholesale Radio Service Company, Inc.
BRONX, N. Y. 542 East Fordham Rd.
 Wholesale Radio Service Company, Inc.
BUTLER, MISSOURI 211-215 N. Main Street
 Henry Radio Shop
CHICAGO, ILLINOIS 833 W. Jackson Blvd.
 Allied Radio Corp.
CHICAGO, ILLINOIS 25 North Franklin Street
 Electric & Radio Supply Co., Inc.
CHICAGO, ILL. 901-911 W. Jackson Blvd.
 Wholesale Radio Service Company, Inc.
CINCINNATI, OHIO 1103 Vine Street
 United Radio, Inc.
JAMAICA, L. I. 90-08 166th Street
 Wholesale Radio Service Company, Inc.
LITTLE ROCK, ARKANSAS 409 W. 3rd St.
 Beem Radio Company
MINNEAPOLIS, MINNESOTA 1124-26 Harmon Place
 Lew Bonn Company
MONTREAL, CANADA 285 Craig Street, West
 Canadian Electrical Supply Co., Ltd.
MUSKOGEE, OKLAHOMA 204 No. Twelfth Street
 Home Radio Mart
NEW YORK, N. Y. 100 Sixth Avenue
 Wholesale Radio Service Company
NEWARK, N. J. 24 Central Ave.
 Wholesale Radio Service Company
READING, PENN. George D. Barbey Co. 404 Walnut Street
WASHINGTON, D. C. 938 F Street, N. W.
 Sun Radio & Service Supply Co.

Listings on this page do not necessarily imply endorsement by QST of the dealers or of other equipment sold by them.

★ ★ ★

We Repeat

the F.C.C. requires a record of all transmissions. Have you a separate log for your portable mobile work? You will find that a separate log will help you maintain the standards of your station in the field as you would at its base location.

35¢ each, 3 for \$1.00

★ ★ ★

**AMERICAN
RADIO RELAY LEAGUE, INC.**
WEST HARTFORD, CONN.

★ ★ ★

PRACTICAL RADIO ENGINEERING *Complete COURSE IN ONE YEAR!*

Train now for new opportunities in Radio and Television Engineering. One-year residence course begins Sept. 18 in our new building. Learn by theory and practice in modern-equipped shops and "labs". Write today for details about CRRI residence and home-study courses. Free book on request. Dept. Q-8, 3224-16th St. N. W., Washington, D. C.

SEND FOR FREE CATALOGUE

CAPITOL RADIO ENGINEERING INSTITUTE

PRECISION CRYSTALS

Highest quality crystals carefully prepared for frequency stability and maximum output—rigidly tested to assure you of dependable operation. Be sure of your transmitter frequency—use **PRECISION CRYSTALS**.

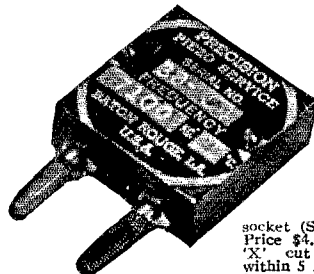

Low frequency drift unit supplied within 5 Kc. of your specified frequency in the 40, 80 or 160 meter bands calibrated to within .03%. Supplied in holder as illustrated to plug into G.R. type jacks or in round holder to plug into a tube socket (See Jan. issue QST). Price \$4.00. Highest quality "X" cut crystals supplied within 5 Kc. of your specified frequency in the 40, 80 or 160 meter bands and calibrated to within .03%. Supplied mounted. Price \$3.50. Please state if holder as illustrated or round holder for tube socket is wanted.

Precision crystals for commercial requirements quoted on at your request. Now in our tenth year of business.

PRECISION PIEZO SERVICE
427 Asia Street Baton Rouge, La.

affairs concerning us. Already I can hear some of the old-timers and newcomers too, screaming at the thought of 250,000 amateurs, but if we intend to keep our present frequencies, we must have amateurs to keep them well occupied.

Here's another thought. In the past, there have been several radio magazines that have used lots of pages fighting A.R.R.L. Why not enlist their help in fighting with A.R.R.L. for the amateurs they both say they represent? It will be very much to everybody's advantage, for we can never get anywhere divided.

And last but not least, with present world relations as they are, 250,000 amateurs in the world would go a long way toward promoting peace and good will among the nations of the world. After enjoying many pleasant QSO's with a foreign brother amateur, you would hate very much to think of having to shoot him down on the field of battle.

— Arthur H. Loe, W5BQD

DX ANALYSIS

6729 Oglesby Ave., Chicago, Ill.

Editor, QST:

I recently took it upon myself to survey the DX Century Club and also those stations with 75 or more countries to their credit, to learn what equipment they were using and to get advice as to what I might use in getting back on the air.

The results of the survey were very illuminating. I sent out a total of 180 letters and was gratified to receive 149 replies — truly amazing evidence of the co-operative spirit of the amateur fraternity.

A general breakdown indicates that the DX'er builds his own transmitting equipment but buys his receiver. From the 149 replies received from all over the world, as well as the U. S. A., only 37 had constructed their own receivers. The remainder used factory-built receivers obtained from eight different manufacturers. Some of these receivers are five years or more old and in many instances their owners evidenced interest in more recently advertised models in preference to the receiver they were now using. Some of those who had built their own receivers indicated that if they had to do it over again they'd buy a manufactured receiver.

In constructing my new station I felt that additional information as to the average power used by the group would be of great help to me.

Below are the four groups with their average input power to the final stage — as well as the average for the total 149 stations figured to the nearest round number.

Members	Average Input Power
DX Century Club — U. S. A.	650 watts
DX Century Club — Foreign	106 "
Stations 75 or more countries — U. S. A.	500 "
Stations 75 or more countries — Foreign	220 "
Average Power Entire Group	370 "

The antennas being used are stated below in the order of their preference (some stations used more than one antenna).

End-Fed Zepp	"V" Beams
Single-Wire Fed Hertz	Rhombic
End-Fed Single Wire	3 Element Rotary Beams
Vertical Zepp	Center-Fed Zepp
1/4-Wave Doublets	3JK
2-Element Rotary Beams	"Y" Matched Impedance
Q Fed	Marconi

I wish to take advantage of this opportunity to thank all members of the select group for their wonderful response to my appeal. The willingness of these folks is proof positive that there is something definitely fine in this hobby of ours — that friendship and courtesy are the distinguishing characteristics of ham radio. Long may it live!

— Van Turner

**SWITCH
TO SAFETY!**

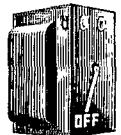

HAM-ADS

(1) Advertising shall pertain to radio and shall be of nature of interest to radio amateurs or experimenters in their pursuit of the art.

(2) No display of any character will be accepted, nor can any special typographical arrangement, such as all or part capital letters be used which would tend to make one advertisement stand out from the others.

(3) The Ham-Ad rate is 15¢ per word, except as noted in paragraph (6) below.

(4) Remittance in full must accompany copy. No cash or contract discount or agency commission will be allowed.

(5) Closing date for Ham-Ads is the 25th of the second month preceding publication date.

(6) A special rate of 7¢ per word will apply to advertising which, in our judgment, is obviously non-commercial in nature and is placed and signed by a member of the American Radio Relay League. Thus, advertising of bona fide surplus equipment owned, used and for sale by an individual or apparatus offered for exchange or advertising inquiring for special equipment, if by a member of the American Radio Relay League, takes the 7¢ rate. An attempt to deal in apparatus in quantity for profit, even if by an individual, is commercial and all advertising by him takes the 15¢ rate. Provisions of paragraphs (1), (2), (4) and (5) apply to all advertising in this column regardless of which rate may apply.

Having made no investigation of the advertisers in the classified columns, the publishers of *QST* are unable to vouch for their integrity or for the grade or character of the products advertised.

QUARTZ — direct importers from Brazil of best quality pure quartz suitable for making piezo-electric crystals. Diamond Drill Carbon Co., 719 World Bldg., New York City.

USED receivers. Bargains. Cash only. No trades. Price list 3¢ W3DQ, Wilmington, Del.

QSL'S. Free samples. Printer, Corwith, Iowa.

CALLBOOKS — Summer edition now on sale containing complete up-to-date list of radio hams throughout entire world. Also world prefix map, press schedules and new time conversion chart. Single copies \$1.25. Canada and foreign \$1.35. Radio Amateur Call Book, 610 S. Dearborn, Chicago.

QSL'S. Cuts. Cartoons. Free samples. Theodore Porcher, 7708 Navahoe, Philadelphia, Pa.

CRYSTALS. mounted, 80-160, \$1.25. V-cut 40 \$2.25. K9 Crystals, 338 Murray Ave., Arnold, Pa.

QSL'S. Finest at lowest prices. Samples. Maleco, 1805 St. Johns Place, Brooklyn, N. Y.

WHY not get better deal. Used receiver list free. W9RA, Chirad, 415 So. Dearborn St., Chicago.

QSL'S. 1939 designs. Best stock and workmanship. Free samples to hams. W2FJE, 101 Hanson Place, Brooklyn, N. Y.

1000 watt G.E. transformers 1100-2200-4400 volts each side c.t. Guaranteed. \$13.50. Dawson, 5740 Woodrow, Detroit, Mich.

QSL'S. Three colors. Samples. W9RUI, Auburn, Neb.

MACAUTO code machines: low monthly rental 50,000 words practice tapes. Write N. C. Ayers, 711 Boylston St., Boston, Mass.

QSL'S — samples. Brownie, W3CJI, 523 No. Tenth St., Allentown, Pa.

NEW Type AB low drift crystal mounted in ceramic holder — 40, 80, 160 meters, \$2.50 each. Faberadio, Batavia, Ill.

QSL'S. SWL's. 100 — 3 color — 75¢. Lapco, 344 W. 39th, Indianapolis, Ind.

QSL'S? World's finest. Free samples? W8DED, Holland, Mich. (Biiley crystal sales.)

RME-69, \$85. W7ALH, Naches, Wash.

SELL: 2 Mac Keys @ \$4. W1ICW.

FOR sale: 1937 Sky Chief and Utah, Jr. transmitter in good condition, \$40. W1KZM.

QSL'S, all colors, cartoons, snappy service. Write for free samples today. W1BEF, 78 Warrenton, Springfield, Mass.

FOR sale: Kohler model 1M21 1500-watt 115-volt a.c. light plant. Used 6 months. Ideal for emergency power supply, camp, filling station, sound truck. Bell complete with 55 gal. tank and fittings, \$275. V. W. Hodge, Claremont, N. H.

SELL cash: Weston 660 analyzer, \$25; 662 Weston oscillator, \$18.; 1-1503 Triplett tube tester, \$40. Send stamped envelope for list of surplus equipment. Dr. Simpson, Ridgway, Pa.

DOUGLAS Universal modulation transformers offer you a wider impedance range, better quality at the lowest price obtainable; 50-watt pair, \$4.95; 100-watt pair, \$7.75. One-year guarantee. Postpaid in U. S. Write W9IXR, Rice Lake, Wis.

WESTINGHOUSE dynamotors 27½/350 volts 80 mils mounted pair with switchboard, 0-50-500 voltmeter and filter, \$9.; G.E. Thermoammeter 0-1 ampere, \$3.25; eight W.E. 206AH polarized SPDT relays 5 ohms 5 mils, \$1.50 each; IRE Proceedings 1931 complete, \$1.75; W.E. 8C program supply amplifier, \$13.; Weston 0-3 a.c. voltmeter, \$1.85; standard W.E. weight Channel iron, two 12' lengths undrilled, \$3.50 each; 72' relay rack W.E. weight and dimensions tapped 12/24 screws, \$4.75; new Jewell model 88, 0-500 microammeter, \$3.75. Clair Lewis, Houlton, Me.

QSL'S. Printed day order received. Samples. W5GG, Cleveland, Miss.

WANT used HRO or NC101X. W3GGS.

SELL 80-watt cee transmitter, tubes, coils, meter, power supply, two crystals, cabinet — \$35. W1KOO, Orleans, Vt.

SELLING KW transmitter as parts. Stamp for real bargain list. No junk. W3ESY, Hellam, Pa.

WANT 200-300 watt phone — CW transmitter. W3FJK.

WANTED: B.S. receiver in exchange for lathe. Sta. A, Box 21, Boston, Mass.

\$\$\$\$ saved on your rotator completely equip your beam. \$34. buys steel frame hollow shaft rotator, silent motor, Selsyn-chronous indicator. Tip-down heads. Alumalloy elements light, strong as steel. Coaxial verticals. Quarter brings Bassett's beam handbook, our bulletins, photos. Rotary Array Service, W8ML.

SELL Handbook 50-watt economy modulator with tubes, \$20 W8QXM.

CRYSTALS in plug-in heat dissipating holders — 160-80, \$1.25; (No Y cuts); 40X, \$1.60. State frequency desired. C.O.D.'s accepted. Pacific Labs., 1042 S. Hicks, Los Angeles.

SELL: National 1-10, complete tubes, coils, \$33; SX-16, built-in noise limiter with toggle switch (as in SX-17), \$70. W2HCY.

CRYSTALS: police, marine, aircraft, broadcast, and amateur. Write for quotations. C-W Mfg. Co., 1170 Esperanza, Los Angeles.

SELL: National bench relay rack; monitor speaker panel. Trimm featherweight phones. Interested? Write E. J. Brija, 12 Somerset St., Garfield, N. J.

TRANSFORMERS: plate, filament, and special transformers designed, rebuilt, and rewound to your specifications. Low prices and liberal trade-in allowance. Write for prices on your requirements. G. G. Wise, 2060 Simon St., Philadelphia, Pa.

SELL to highest bidder or trade for 16 mm. movie camera: QSTs — 1923, Dec.; 1924, Sept., Oct.; 1925, 1926, 1934, 1935 complete. unbound; 1927 through 1933 complete, bound with Index. A.R.R.L. Handbooks — Editions: 1st through 4th, 6th through 11th. Don Farrell, Chittenango, N. Y.

TRANSMITTER 250 watts phone and CW, new. TZ40's. Modulators, TZ40. Relay rack speech and microphone. 3 bands. \$125. Hallierafter receiver S11, \$40. W3ARR.

SELL: three-band CW xmitter, heavy duty 2000-volt supply, and Skyrider 8-9 receiver, complete \$125. No trades. Earl Fouché, 1314 Hacienda St., Bellflower, Calif.

YOUR call letters in neon complete with transformer, \$7.50 net. W8PCV, 35 Forest Ave., Jamestown, N. Y.

SELL: designs 600 watt rig, RME-69, Johnson Q. Photo and details on request. W9ZOI, Olathe, Kansas.

TRADE on sailboat or sell: 800-watt 80-meter CW transmitter. Also new parts for 370-watt 805 Class B modulator and 2A3 driver. W3AMI.

CRYSTALS: marine, police, and amateur frequencies. Descriptive catalog. Ham Crystals, 1104 Lincoln Place, Brooklyn, New York.

SACRIFICE complete station: SX16 receiver, crystal, speaker; all parts build 250 watt PP T-40; two power supplies; 6 crystals — \$175. f.o.b., or \$155. where is as is. D. O. Easton, 115 S. E. 32nd, Oklahoma City, Okla.

TELEPLEXES, Instructographs, omnigraphs bought, sold, traded. Ryan's, Hannibal, Mo.

CRYSTALS: for \$1.60 you can get a fully guaranteed 40 or 80 meter T9 crystal of unquestioned quality. Why pay more or take chances on a no-name crystal of doubtful performance? T9 ceramic holder, \$1. Fast service and close frequency choice featured. C.O.D.'s accepted. Fine commercial crystals on order. Sold by these and other reputable dealers: Hieronymus Radio, 88-34 209th St., Queens Village, N. Y.; Radio Doc, 721 S. Main, Los Angeles, Calif.; Henry Radio, Butler, Mo.; Frank Anzalone, 375 W. 46th St., N. Y. C.; Hamrad Wholesale, London, Eng.; and Eidson's, Temple, Texas.

TRADE imported Austrian 30-piece drafting set, never used; cost \$125. Want late model motor-driven reversible 3 element 30 meter beam, complete with elements and remote direction indicator. Must be perfect in every way. Give full details first letter. W6HL.

WANTED: a.c. or d.c. generator, 110 or 220. VE2CN, Rouleau Sidine.

COMPLETE station, now surplus, 42 crystal 807 final CW rig, two power supplies, standard steel chassis and panel, break-in, finest parts, good condition, ready to operate. Hallierafter S-15 Challenger used 6 months, perfect. Best offer takes all. W1KLR.

CODE classes 25¢ per hour; inquire. Radio License Training School, 728 S. Hill St., VA8870, Los Angeles.

SELL: transformer 2400-1750-0-1750-2400 volts a.c. 600 mils. \$15. R. Laurensen, 812 Coal St., Wilkinsburg, Pa.

FOR sale: FBXA receiver, preselector; 180-watt transmitter, power supplies, meters. Make offer. W9VTM, Pocahtontas, Iowa.

WHETHER you pay cash, trade equipment, or buy on terms financed by myself, it pays you to write W9ARA, authorized factory distributor for all amateur receivers, transmitters, parts. Write. W9ARA, Butler, Mo.

RECONDITIONED guaranteed receivers and transmitters shipped on ten-day trial. Practically all models at big savings. Model S19 Sky Buddies in factory-sealed cartons, \$19.50. Terms. List free. W9ARA.

I can supply all the Thordarson, National, Utah, UTC transmitter kits either in kits or assembled, wired, and tested ready to use. Terms. Write. W9ARA.

GENERAL Radio — Roller-Smith 0-1.5 and 0-2.5 r.f. ameters, \$1.95. Signal Corps V.T. frequency meters, \$4.95. Signal Corps receivers, transmitters, parts. 5-10 auto converters wired, tested, \$15.94. Ditto 5-10 18-watt phone — CW transmitters, \$38.19. Write for bargain list. Radio Specialists, W9LLX, 215 No. Ada St., Chicago.

1.5-volt synchronous vibrator supply. For new 1.5-volt tubes. 90 volts, 11 milliamperes. Number 6 cell lasts 20 to 30 hours. 6" x 3" x 5" grey enameled metal case. Hum and hash filters. Weight, 2.5 pounds. Complete, postpaid U.S.A., \$7.95. W. Parisee, W9GZ, 1406 Chicago Ave., Evanston, Ill.

CALLS — for panel mounting. Half-inch white translucent letters, black background. 1" x 3 3/4". Can be rear illuminated. \$1. R. T. Dalton, 36 Ridge Rd., Rutherford, N. J.

RCA ATR-219 or Barr DB3 transceiver, \$12.; RME-510X, \$29.; 510 Skyriders relay cabinet, \$55.; PR-10, \$25. complete; RME-70 like new, \$119. complete. Van Sickle Radio, W9KJF, Indianapolis, Ind.

RECEIVERS — reconditioned and guaranteed. Send for bargain list. Everything for the amateur on lowest payments to suit individual. World clocks, \$3.95, aluminum tubing for beams. Send for catalog. Wholesale Radio Labs., Council Bluffs, Iowa. W9GFQ.

CRYSTALS: famous P.R., mounted in latest Alsimag 35 holders — 40, 80 meter PR-X, 160 meter PR-Z, \$3.; 40, 80 meter PR-Z (low drift), \$3.50; 20 meter PR-20, \$4.50; unconditionally guaranteed. Immediate shipment. Wholesale Radio Labs., Council Bluffs, Iowa.

WANTED: Super-Pro, ten-meter model, cash. W7DVY.

KODAK wanted, 3A, with adapter. Swap radio equipment. W9RQZ.

**SWITCH
TO SAFETY!**



RADIO COURSES

New Fall Classes Start in September

- RADIO OPERATING • BROADCASTING • CODE
- RADIO SERVICING • TELEVISION
- ELECTRONICS — 1 year day course; 2 years eve.
- Day and Evening Classes — Booklet upon request

NEW YORK YMCA SCHOOLS

4 West 63rd Street, New York City

Piezo-Electric Crystals Exclusively

- Quality crystals of all practical frequencies supplied SINCE 1925. Prices quoted upon receipt of your specifications.

Our Pledge: **QUALITY FIRST**

SCIENTIFIC RADIO SERVICE

"The Crystal Specialists Since 1925" University Park, Hyattsville, Md.

RADIO

ENGINEERING, broadcasting, aviation and radio telegraphy and telephony, Morse telegraphy and railway accounting taught thoroughly. 48 weeks' engineering course, equivalent to three years of college radio work. School established 1874. All expenses low. Catalog free.

DODGE'S INSTITUTE, Day Street, Valparaiso, Indiana



For precision work, these RCA Piezo Electric Calibrators are "just what the doctor ordered"

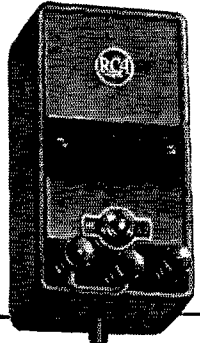

TELEVISION — Here is a small crystal oscillator unit with fundamental frequencies of 250 kcs. and 2000 kcs. Selection of either frequency is obtained by means of a two-way switch. Harmonics of these fundamental frequencies provide accurate signals for calibration use in the television bands. This RCA calibrator has an acorn type oscillator tube (RCA 955) and offers accuracy of plus or minus .05%. Individual temperature correction factor furnished with each unit to facilitate checks to within ten cycles in a million. Stock No. 157. \$46.50 net.

RADIO — The Standard Piezo Electric Calibrator for general purpose use is Stock No. 9572 — similar to No. 157 above — except it offers fundamental frequencies of 100 kcs. and 1000 kcs., each having prolific harmonics. Guaranteed accuracy of fundamentals .05%. \$29.95 net.

Over 386 million RCA radio tubes have been purchased by radio users... In tubes, as in Parts and Test Equipment, it pays to go RCA All the Way.



Test Equipment

RCA Manufacturing Co., Inc., Camden, N. J.
A Service of Radio Corporation of America

All the Latest Developments in Vertical Radiators and Beam Antennas

No matter what type of beam or array you plan, you can build it better with Premax Elements. Send for catalog and special prices.

PREMAX PRODUCTS

DIV. CHISHOLM-RYDER CO., INC.

3919 Highland Ave.

Niagara Falls, N. Y.

SEND FOR TECHNICAL BULLETIN H-3

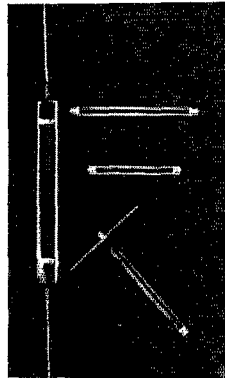

UNBREAKABLE

Genuine Du Pont Lucite

NO-TV Feeder Spreaders and Heavy Duty Insulators

Four features make these spreaders indispensable for your new feeder system.

1. NO-TV — set screw at each end holds feeder wire in place without tie wires.
2. Light in weight — 1/4 weight of ceramic spreaders.
3. Excellent insulation at high frequencies.
4. Unbreakable — no new ones to buy.

2" \$1.15 4" \$1.18 6" \$2.11

If your dealer cannot supply you order direct

CALDWELL PRODUCTS Inc.
Radio Division
Mount Vernon, New York

Your Nearby Dealer Is Your Best Friend

Your nearby dealer is entitled to your patronage. He is equipped with a knowledge and understanding of amateur radio. He is your logical source of advice and counsel on what equipment you should buy. His stock is complete. He can supply your needs without delay. His prices are fair and consistent with the high quality of the goods he carries. He is responsible to you and interested in you.

One of these dealers is probably in your city—Patronize him!

ATLANTA, GEORGIA

Wholesale Radio Service Company, Inc.
265 Peachtree Street
"The World's Largest Radio Supply House"

NEW HAVEN, CONNECTICUT

Hatry & Young, Inc.
1172 Chapel Street
National, Taylor, Kenyon T Line, Radiotron, Howard, etc.

BALTIMORE, MARYLAND

Radio Electric Service Co.
3 N. Howard St.
Everything for the amateur

NEW YORK, N. Y.

Wholesale Radio Service Company, Inc.
100 Sixth Avenue
"The World's Largest Radio Supply House"

BOSTON, MASS.

Wholesale Radio Service Company, Inc.
110 Federal Street
"The World's Largest Radio Supply House"

NEW YORK, N. Y.

Harrison Radio Company
12 West Broadway
Harrison Has It! Phone WOrth 2-6276 for information or rush service

BRONX, NEW YORK

Wholesale Radio Service Company, Inc.
542 East Fordham Road
"The World's Largest Radio Supply House"

PHILADELPHIA, PENNSYLVANIA

Eugene G. Wile
10 S. Tenth Street
Complete Stock of Quality Merchandise

BUFFALO, NEW YORK

Radio Equipment Corp.
326 Elm Street
W8PMC and W8NEL — Ham, service and sound equipment

PROVIDENCE, RHODE ISLAND

W. H. Edwards Company
85 Broadway
National, Hammarlund, Hallicrafter, Thordarson, Taylor, RCA

JAMAICA, L. I., NEW YORK

Wholesale Radio Service Company, Inc.
90-08 166th Street (Merrick Road)
"The World's Largest Radio Supply House"

RICHMOND, VIRGINIA

The Arnold Company
Broad at Harrison St.
W3EQQ — "The Virginia Ham Headquarters" — W3FBL

MONTREAL, CANADA

Canadian Elec. Supply Co., Ltd.
285 Craig St., W.
Quality parts and equipment for discriminating buyers

TORONTO, CANADA

A & A Radio Service Supply
101 Queen Street, West
Canada's Foremost Radio Supply House

NEWARK, N. J.

Wholesale Radio Service Company, Inc.
24 Central Avenue
"The World's Largest Radio Supply House"

WINNIPEG, CANADA

Electrical Supplies, Ltd.
306-10 Ross Avenue
Western Canadian Amateur Headquarters for Leading Lines

YOU CAN BE SURE
WHEN YOU BUY FROM

QST

ADVERTISERS

“Advertising for *QST* is accepted only from firms who, in the publisher’s opinion, are of established integrity and whose products secure the approval of the technical staff of the American Radio Relay League.”

Quoted from QST’s advertising rate card.

Every conceivable need of a radio amateur can be supplied by the advertisers in QST. And you will know the product has the approval of the League’s technical staff

Index to Advertisers

Abbott Instrument, Inc.	70
Acme Electric & Mfg. Company, The	83
Aerovox Corp.	76
Astatic Microphone Laboratory, Inc.	83
Bee Engineering Company	85
Bliley Electric Company	64
Caldwell Products, Inc.	92
Candler System Company	86
Capitol Radio Engineering Institute	90
Cardwell Mfg. Corp., Allen D.	62
Centralab	63
Collins Radio Company	Cov. 2
Cornell-Dubilier Electric Corp.	82
DX Radio Products Company	87
Dodge’s Institute	92
Eitel-McCullough, Inc.	65
General Radio Company	85
Hallicrafters, Inc., The	1, 2
Hammarlund Mfg. Company, Inc.	61, 66
Harvey Radio Company	84
Henry Radio Shop	87
Instructograph Company	85
Kato Engineering Company	82
Ken-Rad Tube & Lamp Corp.	85
Kenyon Transformer Company, Inc.	7
Mallory & Company, Inc., P. R.	60
Massachusetts Radio School	86
Mims Radio Company	74
National Company, Inc.	Cov. 3, 59
New York YMCA Schools	92
Newark Electric Company	81
Ohmite Mfg. Company	76
Port Arthur College	83
Precision Piezo Service	90
Premax Products	92
RCA Institutes, Inc.	78
RCA Mfg. Company, Inc.	Cov. 4, 92
Radio Mfg. Engineers, Inc.	95
Radio Shack, The	77
Radio Transceiver Laboratories	86
Rek-O-Kut Corp.	90
Scientific Radio Service	92
Shuler Supply Company	80
Sickles Company, F. W.	83
Solar Mfg. Corp.	78
Southwest Radio Supply	88
Standard Transformer Corp.	79
Sun Radio Company	88
Taylor Tubes, Inc.	71
Teleplex Company	78
Terminal Radio Corp.	80
Thordarson Electric Mfg. Company	67
Triplett Elec. Instrument Company, Inc.	75
United Transformer Corp.	96
Valpey Crystals, The	87
Vibroplex Company, Inc., The	82
Wholesale Radio Laboratories	77
Wincharger Corp.	87
Yaxley	60

RME
TIME WILL TELL

Seeing
is
Believing

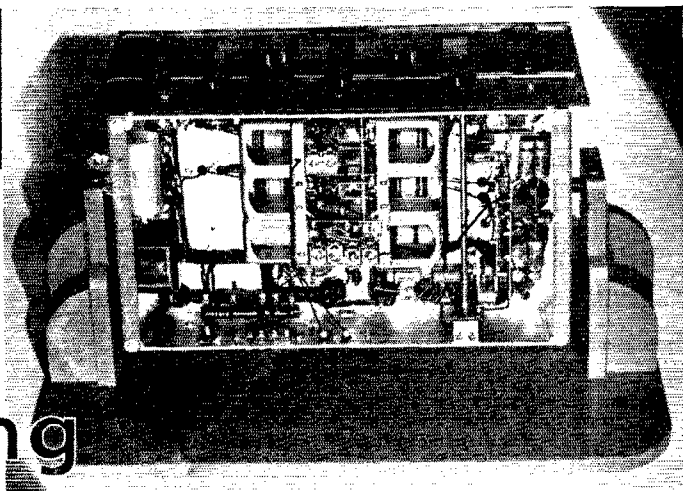

'ONE ILLUSTRATION IS WORTH TEN THOUSAND WORDS' WAS EFFECTIVELY DEMONSTRATED AT THE RECENT RADIO TRADE SHOW HELD IN CHICAGO. —

OUR 'CUT-AWAY' MODEL OF THE RME-70 RECEIVER WAS SUCH A REVELATION AND COMMANDED SO MUCH INTEREST ON THE PART OF DEALERS AND CUSTOMERS WHO LIKE TO SEE THE 'INSIDES' THAT WE HAVE DECIDED TO CIRCULATE SUCH A UNIT AMONG DEALERS THROUGHOUT THE COUNTRY. —

WATCH FOR THIS 'DEMONSTRATOR' AT YOUR RME SUPPLY HOUSE. —

RADIO MFG. ENGINEERS, INC.
111 HARRISON STREET
PEORIA, ILLINOIS



VARI-MATCH TRANSFORMERS

ARE THE IDEAL UNIVERSAL UNITS FOR EVERY AMATEUR AND PA APPLICATION

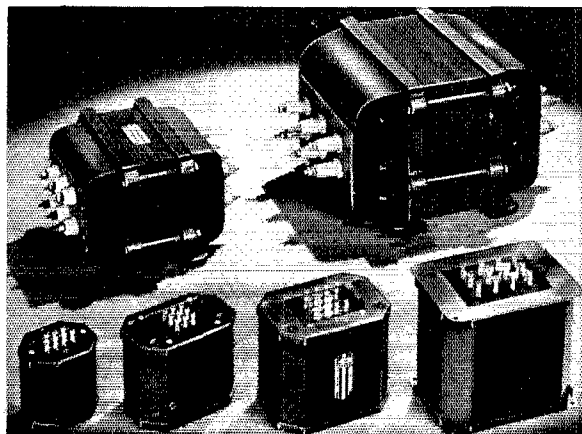

VARIMATCH MODULATION TRANSFORMERS

UTC VARIMATCH Modulation Transformers Will Match ANY Modulator Tubes to ANY RF Load . . .

- VM-0 Maximum audio output 12 watts. \$3.00
- VM-1 Maximum audio output 30 watts. \$4.80
- VM-2 Maximum audio output 60 watts. \$7.50
- VM-3 Maximum audio output 125 watts. \$12.00
- VM-4 Maximum audio output 300 watts. \$19.50
- VM-5 Maximum audio output 600 watts. \$42.00

VARIMATCH INPUT TRANSFORMERS

Varimatch Input Transformers will take care of practically every driver requirement.

PA-51AX Single 56, 6C5, 45, 59, 6L6, 2A3, etc. to class B 46, 59, 79, or A prime 42's, 45's, etc. \$3.30

PA-53AX Push Pull 45, 59, 2A3, 6L6, etc. to class B 210, 801, 800, 35T, RK-18, 203A, ZB-120, etc. \$4.50

PA-59AX 500 ohms line to 805, 838, 203A, 210, 800, ZB-120, etc. \$4.50

PA-238AX Push Pull Parallel 45, 2A3, 6L6, etc. to push pull parallel 838, 203A, ZB-120, or to class B 204A, HF-300, 849, etc. \$10.50

PA-512 500 ohms line to class B, 150T, HF-300, 204A, etc. \$12.00

PA VARIMATH TRANSFORMERS

The new UTC PA Varimath transformers will match practically any tube in their power range to a 200-500 ohm line or to any voice coil.

- PVM-1 For all audio tubes up to 12 watts. \$3.00
- PVM-2 For all audio tubes up to 30 watts. \$4.80
- PVM-3 For all audio tubes up to 60 watts. \$7.50
- PVM-4 For all audio tubes up to 125 watts. \$12.00
- PVM-5 For all audio tubes up to 300 watts. \$19.50

LINE VARIMATCH TRANSFORMERS

The UTC LINE VARIMATCH units will match any single or group of voice coils to a 500 ohm line. Impedance range is from .2 to 75 ohms in 50 combinations . . . UTC LINE VARIMATCH AUTOFORMERS will match one to ten 500 ohms lines or LVM 500 ohm windings to the 500 ohm output of an audio amplifier.

- LVM-1 15 watt Line Varimatch unit. \$2.70
- LVM-2 40 watt Line Varimatch unit. \$4.20
- LVM-3 75 watt Line Varimatch unit. \$6.00
- LVM-10 15 watt Line Varimatch Autoformer 500, 250, 167, 125, 100, 83, 71, 62, 50 ohms. \$2.70
- LVM-11 30 watt Line Varimatch Autoformer. \$4.20
- LVM-12 60 watt Line Varimatch Autoformer. \$6.00
- LVM-13 125 watt Line Varimatch Autoformer. \$10.80
- LVM-14 300 watt Line Varimatch Autoformer. \$15.00

ALL PRICES SHOWN ARE NET TO AMATEURS

UNITED TRANSFORMER CORP.

Write: COMMUNICATIONS DIV. ★ 150 VARICK ST. ★ NEW YORK, N. Y.
EXPORT DIVISION: 180 VARICK STREET NEW YORK, N. Y. CABLES: "ARLAB"

QST for August, 1939, EASTERN Edition

RUMFORD PRESS
CONCORD, N. H.



THE *New* NHU RECEIVER

The new National NHU Communication Receiver brings outstanding performance to the range from 27 to 62 megacycles. All features commonly found in the finest communication receivers are provided in the NHU, including a wide range crystal filter.

Many details of the NHU are unique. The RF circuit and tubes are built completely inside the frame of the condenser, thus making a compact assembly with the shortest possible leads from coils to condensers to tubes. The coils are mounted radially in a cast aluminum turret which is easily rotated to position by a knob on the front panel. Inertia-type tuning is used, with a ratio of approximately 70 to 1. The dial pointer is positively driven by rack and pinion, and moves vertically when the coil range is changed, so that it always points to the right frequency.

You are cordially invited to inspect this fine instrument at your dealers.

NATIONAL COMPANY, INC., MALDEN, MASS.

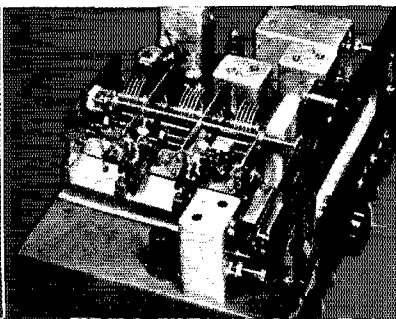
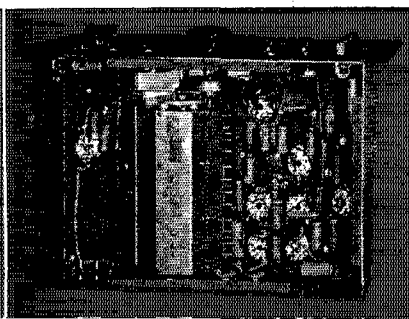
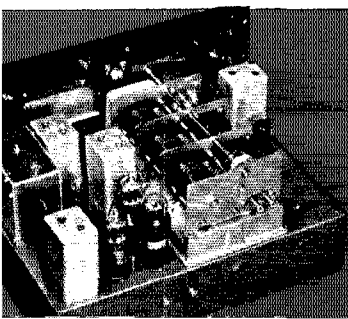

INSTALL IT...
THEN *forget* IT!

RCA-866
HALF-WAVE
MERCURY-VAPOR
RECTIFIER

A rugged, reliable, economical tube of proven performance.

Peak plate current,
 1 ampere maximum.

Peak inverse voltage,
 7,500 volts maximum.

\$1.50

For Higher Voltages...

RCA-866-A

Peak plate current,
 1 ampere maximum.

Peak inverse voltage,
 10,000 volts maximum.

\$2.50



LESS COST PER
HOUR OF SERVICE

When you install RCA-866 Mercury-Vapor Rectifier Tubes you can for-

rectification problems for a long, long time. For the sturdy tubes are really built to last—to give you dependable service at absolute rock-bottom cost per hour of service. That's why they're the best known, most widely used tubes of this type on the market—and have been for many years.

Like that of other RCA Transmitting Tubes, the history of the RCA-866 is one of constant engineering progress. Since its introduction, for instance, the stem and anode structures have been greatly strengthened. Other improvements and changes have provided better shielding and eliminated breakage cracks. Improved exhaust technique and a more effective getter have minimized detrimental gases. As new cathode materials have been developed, they have been employed with resulting higher thermionic emissivity and assurance of longer life even under severe conditions of use.

... And so it goes. Always a good performer, RCA-866 tubes are better today than ever before. They save you money. They will not let you down!

Visit the RCA Television Exhibits at the Golden Gate International Exposition and the New York World's Fair

Radio Tubes

FIRST IN METAL—FOREMOST IN GLASS—FINEST IN PERFORMANCE
 RCA MANUFACTURING CO., INC., CAMDEN, N. J. A Service of The Radio Corporation of America