

QST

January, 1940
25 cents

devoted entirely to

amateur radio

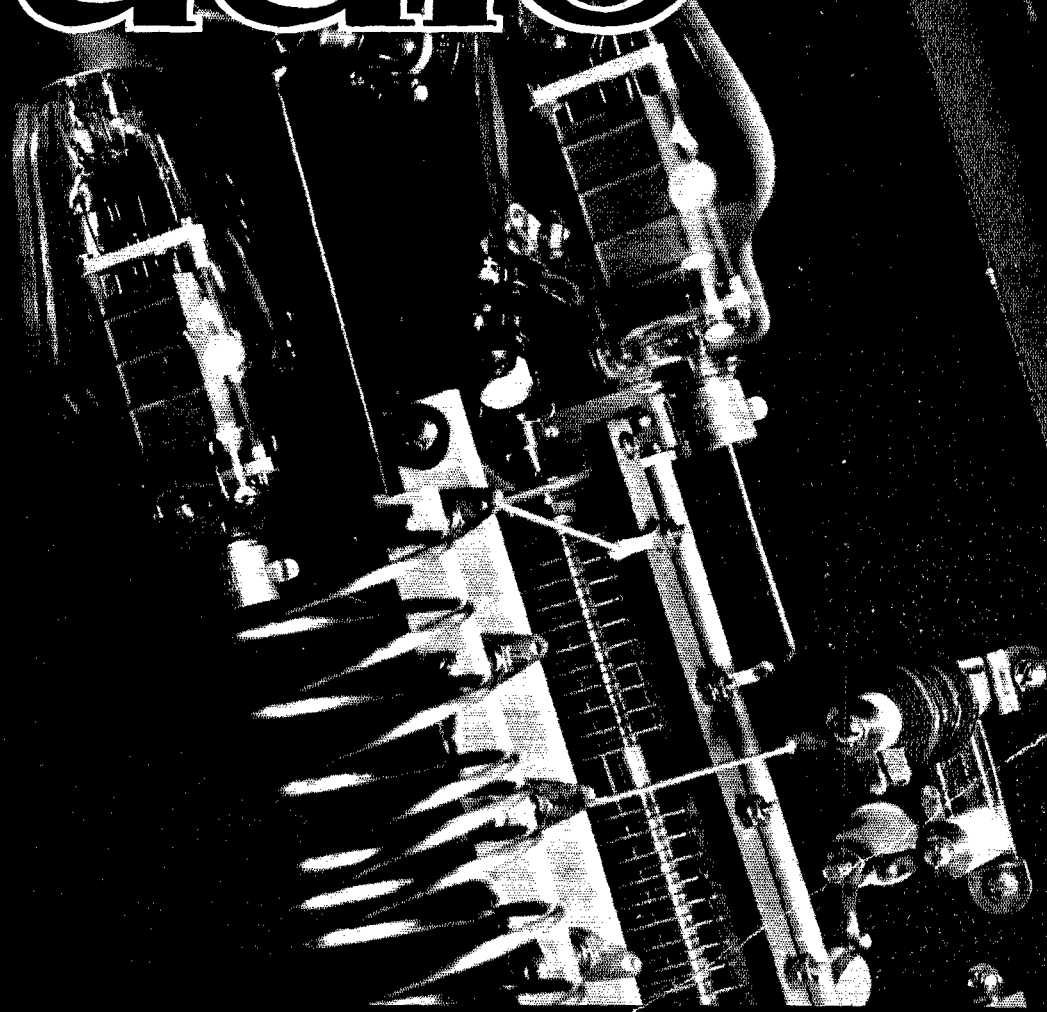

In This Issue—Frequency Modulation for the Amateur

COLLINS 231C

Collins 231C automatically controlled multi-frequency transmitters are an essential part of many radio communication systems. Some of these installations are entirely unattended and are operated from a distance of several miles. Up to ten frequencies are used and the frequency is instantly shifted several hundred times a day.

Collins Autotune completely solves the frequency shift problem. This device automatically re-positions all tuning adjustments for any of ten predetermined (but unrelated) frequencies within an interval of four seconds or less.

Second only to Collins Autotune in importance is the automatic control system. In certain arrangements the operator using only a microphone, key and telephone dial linked to the transmitter over a single telephone circuit is able to control the transmitter completely.

Power Output: 1000 watts.

Frequency Range: 2,500-20,000 kc.

Number of Frequencies: 10 frequencies throughout the range.

Frequency Stability: .03% to .01% depending on rating of crystal.

Antenna Impedance: Unbalanced antennas and transmission lines having an impedance of 70 to 600 ohms with up to 60° phase angle. Balanced antennas and transmission lines having an impedance of 300 to 2,500 ohms with up to 60° phase angle.

Audio Response: Rising audio response 150 cycles to 500 cycles and within ± 2 db between 500 cycles and 2,500 cycles. Response at 60 and 3,000 cycles more than 40 db below 1,000 cycle reference. Audio response may be modified for different types of service.

Amplitude Distortion: The amplitude distortion less than 6% RMS total harmonics at any modulation level up to 100%.

Residual Carrier Modulation: More than 40 db below 100% modulation.

Carrier Shift: Less than 2% at 100% modulation.

Keying System: Tube producing essentially square wave impulses at rates up to 5,000 c.p.s. For manual and machine keying or facsimile.

Power Requirements: Two or three phase, 220V. 50/60 cycles. A1: 3.46 kw. A3, 100% mod: 4.44 kw. Power factor: 90%.

Size: Two cabinets, each 78" high by 24" deep by 24" wide.

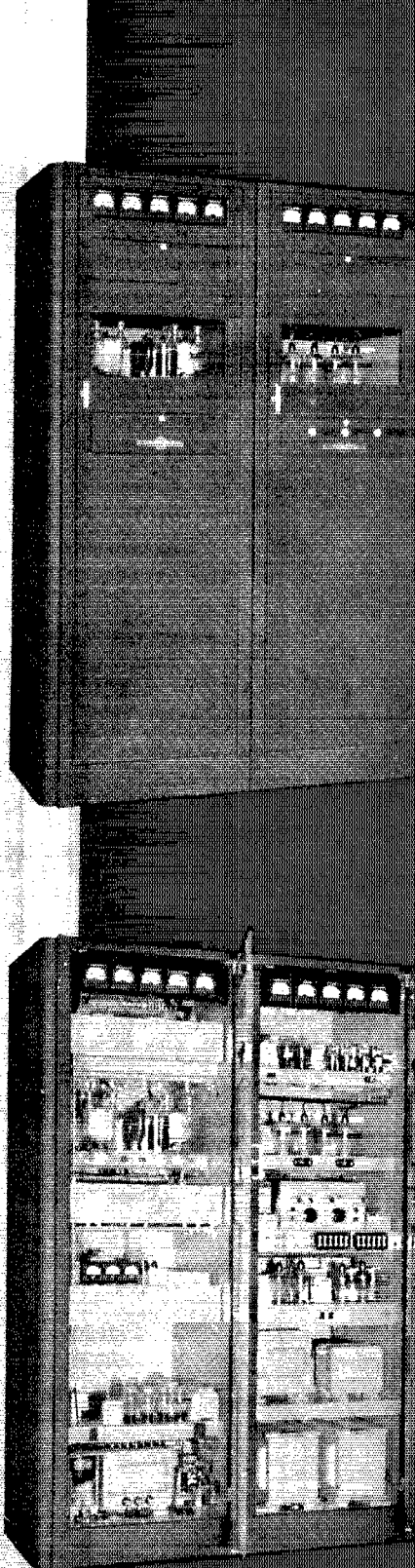

COLLINS RADIO COMPANY

CEDAR RAPIDS, IOWA NEW YORK, N. Y.: 11 WEST 42 ST.

FIVE SHORT YEARS

Just five years ago this month, the first Hallicrafters advertisement appeared in QST. With the production of that original S4 model, we joined an august company of builders of communications equipment. They have been fine, clean competitors with a standard of ethics commensurate with the dignity of the amateur fraternity.

Al Ready, owner of the National Company, has been known for years. Lloyd Hammarlund is one of our best friends. And it has been good to see Jim Millen start out on his own. No one would have thought Jim would do what we do.

E. G. Shaikhauser and Russell Franck launched RME shortly before we entered the field. They have been a real success, and we are happy to see it. To the others, too, who have successfully to build equipment to your specifications, we hope they have found a favorable

All together, we have constantly endeavored to in-

to improve electrical apparatus and
mechanical tolerances.
The progress in these fields has been constantly simplified by
such improvements as hand-switching in both receivers and
transmitters, and the use of power supplies in receivers, and
strictly functional design. The newer tubes have
become more compact—the size of a transmitter has been cut
in half.

A whole station now sits on a single desk—and blasts its way
around the world. And always the costs have been lower
and lower.

No one knows what the next five years will bring in technical
developments. Some of us have visions, and the finest engi-
neers in the world are burning the laboratory lights far into
the night to make those dreams practical.

You have been mighty nice to us these past five years and we
hope to pay you back with better and better equipment. In
the meantime, a Merry Christmas.

The **Hallicrafters** Inc.
CHICAGO, U. S. A.

"WORLD'S LARGEST BUILDER OF AMATEUR COMMUNICATIONS EQUIPMENT"

JANUARY 1940

VOLUME XXIV

NUMBER 1



STAFF

Editorial

KENNETH B. WARNER, W1EB
Editor and Business Manager

CLARK C. RODIMON, W1EB
Managing Editor

GEORGE GRAMMER, W1DF
Technical Editor

DONALD H. MILX, W1TS
BYRON GOODMAN, W1JPE
Assistant Technical Editors

VERNON CHAMBERS, W1JEQ
Technical Information Service

JAMES J. LAMB, W1AL
Consultant

Advertising

F. CHEYNEY BEEKLEY, W1GS
Advertising Manager

CHARLES BRUNELLE
Asst. Advertising Manager

Circulation

DAVID H. HOUGHTON
Circulation Manager

RALPH T. BRAUDIN, W1RAW
Asst. Circulation Manager



OFFICES

38 La Salle Road
West Hartford, Connecticut

Subscription rate in United States and Possessions and Canada, \$2.50 per year, postpaid; all other countries, \$3.00 per year, postpaid. Single copies, 25 cents. Foreign remittances should be by international postal or express money order or bank draft negotiable in the U. S. and for an equivalent amount in U. S. funds.

Entered as second-class matter May 29, 1919, at the post office at Hartford, Connecticut, under the Act of March 3, 1879. Acceptance for mailing at special rate of postage provided for in section 1103, Act of October 3, 1917, authorized September 9, 1922. Additional entry at Concord, N. H., authorized February 21, 1929, under the Act of February 28, 1925. Additional second-class entries to cover sectional editions authorized March 20, 1935.

Copyright 1939 by the American Radio Relay League, Inc. Title registered at United States Patent Office.

QST

devoted entirely to

AMATEUR RADIO

PUBLISHED, MONTHLY, AS ITS OFFICIAL ORGAN, BY THE AMERICAN RADIO RELAY LEAGUE, INC., AT WEST HARTFORD, CONN., U. S. A.
OFFICIAL ORGAN OF THE INTERNATIONAL AMATEUR RADIO UNION



CONTENTS

Editorials	9
Splatter	10
Wide-Band Frequency Modulation in Amateur Communication	
<i>George Grammer and Byron Goodman</i>	11
The Triangle Antenna	20
<i>James Arnold, W6QCC</i>	
More on the Combined Beat Oscillator and I.F. Amplifier	
<i>R. A. McConnell, W8FJ</i>	22
Who Can Work Most States on U.H.F. in 1940?	23
What the League Is Doing	24
Bound Volume XXIII of QST	25
WWV Schedules	25
Experience Speaks	25
A.R.R.L. Announces U.H.F. Marathon for 1940	
<i>F. E. Handy, W1BDI</i>	26
A.R.R.L. QSL Bureau	27
Regeneration in the Preselector	28
<i>G. H. Browning</i>	
Ham Shacks	32
Compactness With Economy	34
<i>Allen Monderer, W9VCX</i>	
On the Ultra Highs	38
<i>E. P. Tilton, W1HDO</i>	
Improved Pi-Section Antenna Coupler	40
<i>R. B. Jeffrey, W8GDC</i>	
Switch to Safety	41
Personality Over the Air	42
<i>E. Lowell Kelly, W9EWL</i>	
Reactance Calculations With the Lightning Calculator	
<i>Robert R. Buss</i>	44
New Transmitting Tubes	45
<i>HK257, 811, 812, HY615</i>	
New Receiving Tubes	47
<i>1R5, 1S4, 1S5, 1T4</i>	
Q Measurements	48
<i>C. B. Stafford, W9KWP</i>	
Naval Communication Reserve Notes	52
<i>First Naval District</i>	
How Emergency Coordinators Work	
<i>Roy C. Corderman, W3ZD</i>	54
Book Reviews	57
3rd Annual A.R.R.L. QSO Party	59
A Code-Practice Oscillator and C. W. Monitor	
<i>Vernon Chambers, W1JEQ</i>	60
I.A.R.U. News	62
Hints and Kinks	
<i>Another Harmonic Oscillator Circuit — Another Compact Multiple Mounting Crystal Mounting — Getting Results with the Pierce Crystal Oscillator Circuit — Homemade High-Voltage Tank Condenser</i>	64
Correspondence from Members	67
Operating News	68
How's DX?	72
Century Club	78
Convention Reports	
<i>Oklahoma State, Wisconsin State, West Gulf Division, Atlantic Division, Central Division, Massachusetts State, Vermont State</i>	116, 117, 118, 120, 122.
Hamads	123
QST's Index of Advertisers	126

HOWARD

Progressive Series

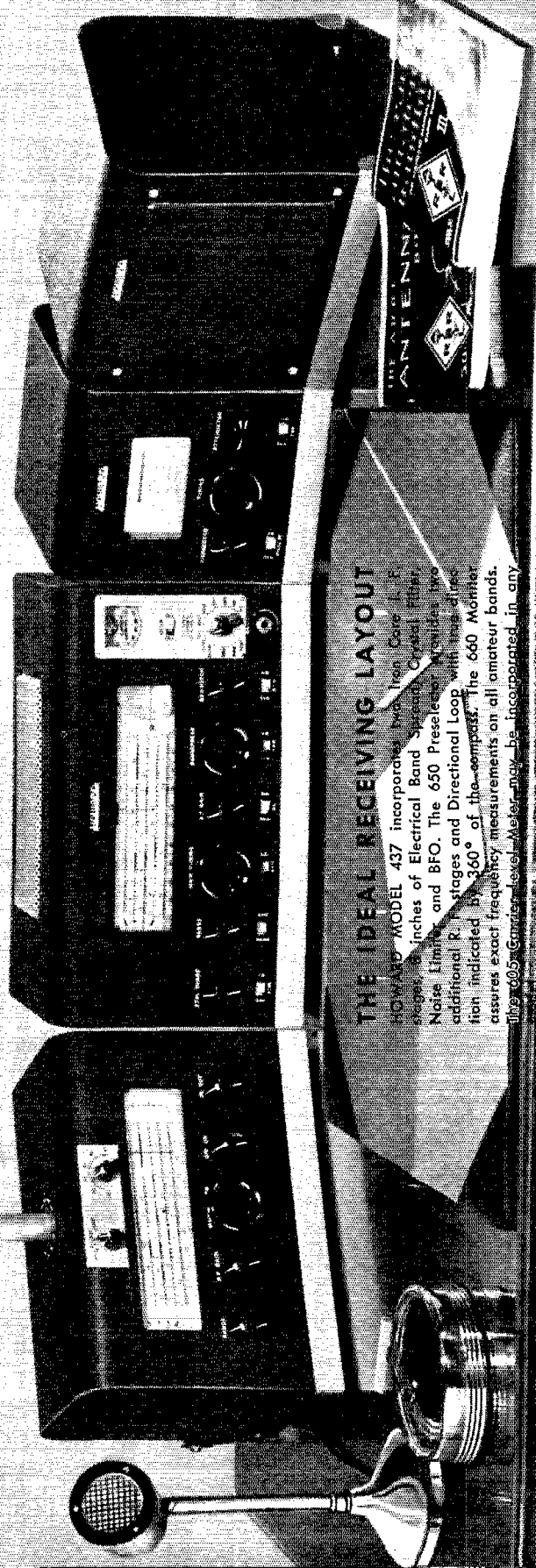

THE IDEAL RECEIVING LAYOUT

HOWARD MODEL 437 incorporates the best of both worlds. It features a 5-inch Electrical Band Spread Crystal Filter, Noise Limiter, and BFO. The 650 Prescaler provides two additional R-F stages and Directional Loop with maximum gain indicated by 360° of the compass. The 660 Monitor assures exact frequency-level measurements on all amateur bands. The 660 Guarantee-Meter may be incorporated in any

The Most Advantageous Purchase Plan Ever Offered!

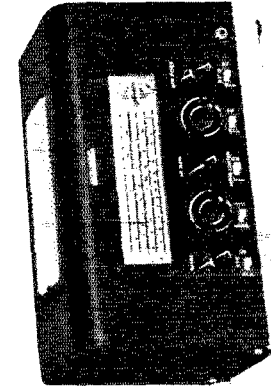

MODEL "436" \$39.95 SEVEN TUBES

Contains all features of basic MODEL 435 plus an efficient noise limiter, a new 8 inch band spread micrometer dial and the exclusive new HOWARD INERTIA KNOBS which provide fly-wheel tuning on both main and band spread controls.

MODEL "437" — NINE TUBES R. F. STAGE — CRYSTAL FILTER

Provides all of the features of basic MODEL 435, the refinements and additions of MODEL 436, plus the utility and extra sensitivity of a R. F. stage together with the additional selectivity of two iron core I. F. stages and crystal filter.

Model "437" \$54.50
— with Crystal Filter \$62.00

PROTECTS YOUR INVESTMENT . . . ENDS TRADE-IN and OBSOLESCENCE LOSSES

The new Progressive Series Plan, created and developed by HOWARD, enables every amateur to start with a modest investment and ultimately become the owner of receiving equipment that will fulfill his fondest hopes. No money need ever be invested in receiving equipment that cannot later at small cost be expanded into a unit having a higher performance factor.

The entire ideal receiver layout pictured above can be started from one basic unit—the MODEL 435. After purchasing MODEL 435, when finances permit, it may be returned direct to the HOWARD factory and converted to MODEL 436 for \$12.75—just \$2.75 more than if you had purchased the MODEL 436 in the beginning. Later, the same receiver can again be returned to the factory and converted to the advanced MODEL 437 for only \$17.05. MODEL 435 may be converted directly to MODEL 437, incorporating all of the features of MODELS 436 and 437, for just \$27.55. If MODEL 436 has been purchased first it can be converted directly to MODEL 437. Any or all of the various accessories shown above can be added to any model for still greater performance. These accessories include the field strength meter, presselector with two R. F. stages, loop antennas, frequency monitor, external speaker, etc.

ALL MODELS HAVE 4 BANDS—540 KC to 43 MC
Export Prices Slightly Higher

START TODAY!

Now is the time to start that ideal receiver layout you have always dreamed of. The HOWARD PROGRESSIVE SERIES PLAN makes this possible. You are assured of: (1) A Protected Investment! (2) No "Trade-in" Losses! (3) Factory Maintenance! This is the first time any manufacturer has built his program around his customers requirements. Write the factory or see your nearest distributor who will be glad to furnish all details.



MODEL "435" \$29.95 SIX TUBES

HOWARD MODEL 435 is the basic unit of the HOWARD PROGRESSIVE SERIES. It is one of the finest and most efficient low priced communication receiver available. It is an outstanding performer on all bands. It features: 6 tubes (6K8G mixer-oscillator, 6SK7 I. F. amplifier, 6Q7G second detector and 1st audio, 6K6 output and a 5W4 rectifier); 2½ watts power output; SEPARATE ELECTRICAL BAND SPREAD CONDENSER; CERAMIC COIL FORMS for oscillator stability; Built-in 6½ inch JENSEN ELECTRO DYNAMIC SPEAKER; Permeability type of BFO; IRON CORE I. F. COILS; COPPER-PLATED CHASSIS; SILVER-PLATED SHIELDING. The slide rule dial is silver-plated and well illuminated. A BAND-IN-USE INDICATOR is at the left of the main dial with the electrical band spread at the right.

HOWARD RADIO COMPANY

1731-35 Belmont Ave., Chicago, Ill.
Cable Address: HOWARDCO., U.S.A.

America's Oldest Radio Manufacturer

Section Communications Managers of the A.R.R.L. Communications Department

All appointments in the League's field organization are made by the proper S.C.M., elected by members in each Section listed. Mail your S.C.M. (on the 16th of each month) a postal covering your radio activities for the previous 30 days. Tell him your DX, plans for experimenting, results in phone and traffic. He is interested, whether you are an A.R.R.L. member or get your QST at the newstands; he wants a report from every active ham. If interested and qualified for O.R.S., O.P.S. or other appointments he can tell you about them, too.

ATLANTIC DIVISION.			
Eastern Pennsylvania	W3BES	Jerry Mathis	5132 Haverford Ave. Philadelphia
Maryland-Delaware-District of Columbia	W3CIZ	Hermann E. Hobbs	9701 Monroe St. Linden, Maryland
Southern New Jersey	W3CCO	Lester H. Allen	Silver Spring P.O. Trenton
Western New York	W8FLA	Joseph Frederick Chichester	704 Quinton Ave. Sonyea
Western Pennsylvania	W8FOF	Kendall Speer, Jr.	Lowber
CENTRAL DIVISION.			
Illinois	W9RMM	Leslie M. Dickson	Edelyn Farms Waukegan
Indiana	W9QG	Noble Burkhart	R. A. Box 1 Indianapolis
Kentucky	W9ARU	Darrell A. Downard	116 N. Longworth Ave. Louisville
Michigan	W8DPE	Harold C. Bird	R. F. D. 2 Pontiac
Ohio	W8AQ	E. H. Gibbs	405 Broad St. Wadsworth
Wisconsin	W9UPT	Aldrich C. Krones	3127-A West Madison St. Milwaukee
DAKOTA DIVISION.			
North Dakota	W9WVL	Anton C. Theis	c/o American Cafe Minot
South Dakota	W9VOD	Dr. A. L. Russell	Philp Kennington
Northern Minnesota	W9IGZ	Edwin L. Wicklund	R. F. D. 3 Spring Valley
Southern Minnesota	W9YNQ	Millard L. Bender	
DELTA DIVISION.			
Arkansas	WSABI	H. E. Vette	4415 West 12th St. Little Rock
Louisiana *	WSDWW	W. J. Wilkinson, Jr.	1523 Laurel St. Shreveport
Mississippi	WSEWD	Jewell W. Coie	c/o City of McComb Water McComb City
Tennessee	W4DWS	William Harold Walker	1901 Cedar Lane Nashville
HUDSON DIVISION.			
Eastern New York	W2LU	Robert E. Haight	511 South Holmes St. Scotia
N. Y. C. & Long Island	W2AZV	E. L. Baunach	102 Central Ave. Massapequa, L. I.
Northern New Jersey	W2GVZ	Joseph P. Jessup	131 California St. Ridgewood
MIDWEST DIVISION.			
Iowa	W9PJR	L. B. Vennard	P. O. Box 304 West Burlington
Kansas	W9UEG	Melvin D. Kirby	Arlington
Missouri	W9QUD	Miss Letha Allendorf	Joplin
Nebraska	W9DI	William J. Bames	Tobias
NEW ENGLAND DIVISION.			
Connecticut	W1CTI	Frederick L. B., Jr.	19 Merrill Rd. Norwalk
Maine	W1IIE	H. W. Castner	147 Church Damariscotta
Eastern Massachusetts	W1HIL	Larry Mitchell	94 Howard St. Melrose
Western Massachusetts	W1JAH	William J. Barrett	239 Columbia St. Adams
New Hampshire	W1BFT	Carl B. Evans	163 South Main St. Concord
Rhode Island	W1HRC	Clayton C. Gordon	70 Columbia Ave., Gaspee Plateau, Warwick
Vermont	W1KJG	Clifton G. Parkes	Box 337 Morrisville
NORTHWESTERN DIVISION.			
Alaska	K7ENA	Leo E. Sherman	Customhouse Wrangell
Idaho	W7EMT	Carl Eichelberger	Route 2 Kuna
Montana	W7FL	G. A. Woodhouse	Holter Dam Wolf Creek
Oregon	W7DXF	Harold W. Johnston	800 Jackson St. Pendleton
Washington	W7FCG	W. Beale	R. 4, School Ave. Walla Walla
PACIFIC DIVISION.			
Hawaii	K6ETF	Francis T. Blatt	837 16th Ave. Honolulu
Nevada	W6HIC	Edwin W. Heim	509 Claremont St. Reno
Santa Clara Valley	W6FBW	Elbert Amarantes	454 Washington St. San Jose
East Bay	W6TII	Horace R. Greer	414 Fairmont Ave. Oakland
San Francisco	W6CIS	Kenneth E. Hughes	622-36th Ave. San Francisco
Sacramento Valley	W6MDI	Vincent N. Feldhausen	113 South Quincy St. McCloud
Philippines	KA1GR	George L. Rickard	Box 849 Manila
San Joaquin Valley	W6KUT	Edwin A. Andress	2921 North Van Ness Blvd. Fresno
ROANOKE DIVISION.			
North Carolina	W4CVB	W. J. Workman	P. O. Box 566 Morganton
South Carolina	W4BQE/ANG	Ted Ferguson	1213 College St. Columbia
Virginia *	W3GWO	Frank S. Anderson, Jr.	4703 New Kent Ave. Richmond
West Virginia	W8OXO	W. D. Tabler	238 Watson Ave. Fairmont
ROCKY MOUNTAIN DIVISION.			
Colorado	W9EHC	Carl C. Drumeller	819 East Dale St. Colorado Springs
Utah-Wyoming	W7CLG	Ernest E. Parshall	Salt Creek Electric Plant Midwest, Wyoming
SOUTHEASTERN DIVISION.			
Alabama	W4DGS	James F. Thompson	12 Clanton Ave. Montgomery
Eastern Florida	W4PEI	Carl G. Schaal	Waucoma Apts. Clermont
Western Florida	W4AXP	Oscar Cederstrom	Lakeview Hotel De Funiak Springs
Georgia	W4AGI	Leland W. Smith	Second St. & Bruce Ave. Augusta
West Indies (Cuba-Isle-of-Pines- Porto Rico-Virgin Islands)	CM2OP	Mario de la Torre	Escobar 110 (Altos) Habana, Cuba
SOUTHWESTERN DIVISION.			
Los Angeles	W6MQM	Ralph S. Click	1038 Milwaukee Ave. Los Angeles
Arizona	W6KMM	Marson B. Hull	617 North Fourth Ave. Phoenix
San Diego	W6JRM	Howard K. Breedlove	R. 2, Box 636 San Diego
WEST GULF DIVISION.			
Northern Texas	W5DXA	Lee Hughes	125 N. Main St. Childress
Oklahoma	W5GFT	Russell W. Battern	431 South Buchanan Enid
Southern Texas	W5BHO	Dave H. Calk	6013 Garrow St. Houston
New Mexico	W5ENI	Dr. Hilton W. Gillett	Lowington
MARITIME DIVISION.			
Maritime	VE1DQ	A. M. Crowell	69 Dublin St. Halifax, N. S.
ONTARIO DIVISION.			
Ontario	VE3SG	F. H. B. Saxon	302 Lee Ave. Toronto, Ont.
QUEBEC DIVISION.			
Quebec	VE2CO	Lindsey G. Morris	Apt. 6, 4510 Girouard Ave., N.D.G. Montreal, P. Q.
VANALTA DIVISION.			
Alberta	VE4GE	C. S. Jamieson	581 W. Riverside Drive Drumheller, Alta.
British Columbia	VE5HP	J. Hepburn, Jr.	335 Foul Bay Road Victoria
PRAIRIE DIVISION.			
Manitoba	VE4AAW	A. W. Morley	747 McMillan Ave. Winnipeg
Saskatchewan	VE4SY	Arthur Chesworth	1071 4th Ave., N. W. Moose Jaw

* Officials appointed to act until the membership of the Section choose permanent S.C.M.s by nomination and election.

NOW...

G-E RADIO TRANSMITTING TUBES Priced Low—Unsurpassed in Value

... and backed by 27 years of G-E experience in tube design and manufacture—27 years during which G.E. was the first to develop
thoriated tungsten filaments
high-power water-cooled tubes
the screen-grid tube
mercury-vapor rectifiers
metal tubes

General Electric tube achievements time and again have led the way to major advancements in the radio art. Now General Electric presents a complete line of amateur types—priced low, and unsurpassed in value.

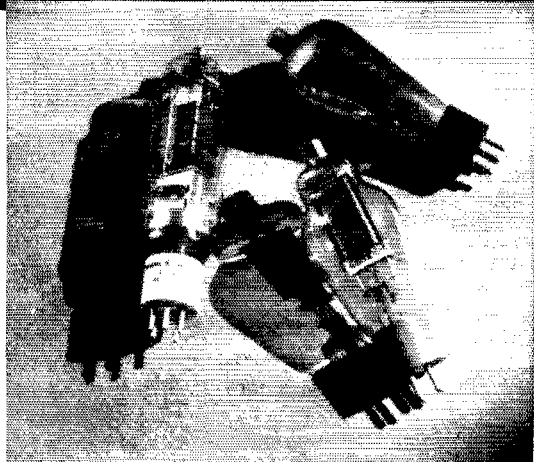

When you buy G-E radio transmitting tubes you get full benefit of the engineering and research facilities of the world's largest electrical manufacturing company.

Write for free bulletin, GEA-3315, or get it direct from your dealer. General Electric, Radio and Television Department, Schenectady, N. Y.

NOTE THESE PRICES

GL-203A	\$10.00	GL-807	\$3.50	GL-838	\$11.00
GL-204A	85.00	GL-809	2.50	GL-845	10.00
GL-211	10.00	GL-810	13.50	GL-849	120.00
GL-800	10.00	GL-811	3.50	GL-860	32.50
GL-801	3.45	GL-812	3.50	GL-866	1.50
GL-802	3.50	GL-813	28 50	GL-866A	2.50
GL-803	28.50	GL-814	17.50	GL-872	9.00
GL-805	13.50	GL-833	85 00	GL-872A	11.00
GL-806	22.00	GL-837	7.50	GL-1623	2.50

GENERAL ELECTRIC

900 23

THE AMERICAN RADIO RELAY LEAGUE

Directors

President
EUGENE C. WOODRUFF W8CMP
234 W. Fairmount Ave., State College, Pa.

Vice-President
GEORGE W. BAILEY W1KH
74 Webster Road, Weston, Mass.

Canadian General Manager
ALEX REID VE2BE
169 Logan Ave., St. Lambert, P. Q.

Atlantic Division
WALTER BRADLEY MARTIN W3QV
Box 612, Roslyn, Pa.

Central Division
R. H. G. MATHEWS ex-W9ZN
4534 Dover St., Chicago

Dakota Division
FRED W. YOUNG W9MZN
107 Hanover St., Mankato, Minn.

Delta Division
E. RAY ARLEDGE W5BI
P.O. Box 286, Pine Bluff, Ark.

Hudson Division
KENNETH T. HILL W2AHC
115 Willow St., Douglaston, L. I., N. Y.

Midwest Division
FLOYD E. NORWINE, JR. W9EFC
7405 Hiawatha Ave., Richmond Heights, Mo.

New England Division
PERCY C. NOBLE W1BVR
37 Broad St., Westfield, Mass.

Northwestern Division
RALPH J. GIBBONS W7KV
c/o United Air Lines, Portland, Ore.

Pacific Division
J. L. McCARGAR W6EY
66 Hamilton Pl., Oakland, Calif.

Roanoke Division
H. L. CAVENESS W4DW
State College Station, Raleigh, N. C.

Rocky Mountain Division
GLEN R. GLASSCOCK W9FA
2164 So. Corona St., Denver

Southeastern Division
BENNETT R. ADAMS, JR. W4EV
1512 Grove Place, Homewood, Ala.

Southwestern Division
CHARLES E. BLALACK W6GG
1273 Main St., El Centro, Calif.

West Gulf Division
WILLIAM A. GREEN W5BKH
801 Ross St., Abilene, Texas

THE AMERICAN RADIO RELAY LEAGUE, INC., is a non-commercial association of radio amateurs, bonded for the promotion of interest in amateur radio communication and experimentation, for the relaying of messages by radio, for the advancement of the radio art and of the public welfare, for the representation of the radio amateur in legislative matters, and for the maintenance of fraternalism and a high standard of conduct.

It is an incorporated association without capital stock, chartered under the laws of Connecticut. Its affairs are governed by a Board of Directors, elected every two years by the general membership. The officers are elected or appointed by the Directors. The League is non-commercial and no one commercially engaged in the manufacture, sale or rental of radio apparatus is eligible to membership on its board.

"Of, by and for the amateur," it numbers within its ranks practically every worth-while amateur in the nation and has a history of glorious achievement as the standard-bearer in amateur affairs.

Inquiries regarding membership are solicited. A bona fide interest in amateur radio is the only essential qualification; ownership of a transmitting station and knowledge of the code are not prerequisite. Correspondence should be addressed to the Secretary.



HIRAM PERCY MAXIM, FIRST PRESIDENT

Officers

President EUGENE C. WOODRUFF, W8CMP
State College, Pa.

Vice-President GEORGE W. BAILEY, W1KH
Weston, Mass.

Secretary KENNETH B. WARNER, W1EH
West Hartford, Connecticut

Treasurer ARTHUR A. HEBERT, W1ES
West Hartford, Connecticut

Communications Mgr. F. EDWARD HANDY, W1BDI
West Hartford, Connecticut

General Counsel PAUL M. SEGAL
1026 Woodward Building, Washington, D. C.

Address all general correspondence to the administrative headquarters at West Hartford, Connecticut.

"IT SEEMS TO US—"

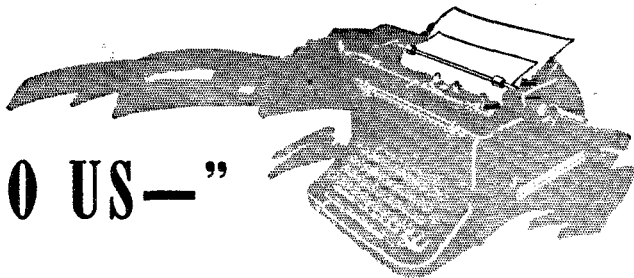

IT is the Christmas season, that time of year when the amateur radio fraternity is accustomed to spreading its greetings not only over the whole countryside but to its fellows in every corner of the world. It comes this year to a world beset by strife, a world in which there walks abroad unhappily little of the spirit of the Christ. Instead, appalling tragedy stalks much of the surface of the earth. It is close to us hams, because time and distance have meant nothing to us in our inter-communication. We miss this Christmas the cheery signals of our friends in many foreign lands.

Radio amateurs of the American republics, let us this season count our blessings and be grateful for them! Join us at the headquarters of I.A.R.U.-A.R.R.L. in wishing radio amateurs everywhere the best possible of Christ-mases! And may the New Year bring us together again in peace and plenty!

AS OLD 1939 signs off, it may do us some good to look back over the months and see what we have done to our technical and operating practices. In general, one must conclude that our art is growing up, for there were no startling and exciting new developments. Rather, it was a period of consolidating and applying previous knowledge, resulting in a general raising of performance. With an infinitude of high-efficiency parts available, amateur radio sailed in with glee and it is probable that there was more new gear built in 1939 than ever before.

The clean-up of the 5-meter band under the new regulations was first a staggering blow to occupancy. But soon there was a splendid recovery, as stable signals made possible the use of high-gain high-selectivity receivers and immensely extended station ranges. Net result now is greatly increasing interest, on a much more satisfactory basis. The year brought us some interesting breaks in the weather and added to our knowledge of transmission phenomena. The transceivers moved to $2\frac{1}{2}$ and gave that band its greatest population, while the hardier experimenters moved on to build resonant-line oscillators for $1\frac{1}{4}$. Organ-

ized operating came into the u.h.f. field. The ultra-high crowd enter 1940 poised for great things.

There was immense interest in the operating contests of the year, and both the DX contest and Field Day enjoyed record participation. With no major communication emergencies, amateur radio gave an admirable account of itself on a score of lesser occasions and, through its Field Day exercises, gave guaranty of its ability to bring an unparalleled quantity of truly portable equipment into play whenever an emergency requires it.

We became safety conscious in 1939. Realizing as never before the lurking death behind each careless practice, we examined our situation, codified our construction and our operating practices, and resolved always to "Switch to Safety."

1939 was unquestionably the high year for the installation of high-gain directive antenna systems, particularly of the close-spaced rotary type. The coaxial came to amateur radio this year, and we learned much about the more efficient transmission of power from transmitter to antenna, while the mechanics of rotaries gave us a fair introduction to mechanical engineering. With nothing particularly new, we have gained because we are more antenna-conscious, are doing more applying of what we know.

The doctrine of "frequency measurement and regular check" grew on us, and we became not only more frequency-conscious but better able to measure our frequencies. Secondary frequency standards came to many stations, and band-edge locators with stable oscillators were the order of the day. With little startling in new tubes, refinement brought us better ones for less money. In the field of reception there was, therefore, increased interest in building receivers of greater performance with fewer tubes, and we daresay there were more home-made superhet receivers built in 1939 than ever before. And this despite the appearance on the market of vastly better low-priced receivers than any previous year had enjoyed. We should mention, too, further developments in noise limiters and audio-frequency bridges

that contributed nicely to working through interference. In transmitters particularly it was a case of consolidating earlier gains. The trend was towards compactness and portability. The stable e.c.o. definitely ingratiated itself. All-band tanks offer new convenience in 1940. Phone design showed a commendable trend towards experimenting to gain more dollar-efficiency. The 1938 development of high-efficiency grid modulation reached our ranks, as did volume compression and the control of splatter, while cathode modulation made a new bow.

Nothing startling, did we say? Frequency-modulation is definitely so, and in the closing months of 1939 we were increasingly interested

in its possibilities for overcoming "man-made static" in our u.h.f. work, as well as in greatly simplifying transmitting equipment. But this belongs more in our 1940 story.

War laid its heavy hand on our foreign fellows, cut them off from us, left us only the hope for reunion in 1940. But our own numbers in the States grew to over 54,000 and we demonstrated splendidly the trust that our nation can put in us as citizens aware of our responsibilities in a mad world.

Spirit, interest, skill, technic, sense of responsibility — all seem to have precisely what it takes for a grand new year as 1940 runs up the gain control and comes booming into our lives!

K. B. W.

★ S P L A T T E R ★

AFTER we had finished reading "Doc" Kelley's "Personality Over the Air" we experienced an urge to take a whack at the same idea from another angle. Along with our note to Gil asking for the usual atmosphere we suggested a pen sketch of the author from an impression after he had read the story. Here it is!



Apparently the greatest error that Gil made was in supplying the subject with a mustache he did not possess — certainly true at the time the résumé was written.

Our Cover

You'll recognize this photo of Mix's amplifier as featured in *QST* last month. It was supposed to be our best cover idea for the month — at least until that scoop shot of Byrd's *North Star* arrived. We've tried several times to be convinced that the amplifier is now a dead issue but, with such a crisp photograph, we just couldn't resist the temptation. No, it has nothing to do with frequency modulation, but there is plenty in this issue that does — and in issues to come, for it looks like something you just won't be without if you are interested at all in the ultra-highs.

Foreign Calls Heard Lists Wanted

If you are an amateur in a country where officialdom doled out the quietus, you may still be able to listen in on the ham bands but not be able to do anything about it as far as flipping the old switch from receive to send. Would you get any satisfaction from logging the stations that you are able to hear and sending in the list to us for publication in *QST*?

So that these lists will still mean something, that is, be an exhibition of a fair piece of transmission as well as reception, we suggest that no calls of stations heard on the 14-Mc. band be included. Use all the other bands and, just for sport, plenty of diversification in covering the entire spectrum. This should certainly produce some interesting evidence of how ham signals are traveling these days. As for the Canadian boys, we suggest that they confine their lists to the ultra-high frequencies or the lower-frequency

(Continued on page 58)

FEEDBACK

P. 51, December QST

Stray on Central Techno-Services carried incorrect address. The address is 302 Fifth Ave., New York City.

Fig. 1, p. 51, November QST

Output tank of 809 should have a ground on the rotor of C_{23} where joining C_{22} .

P. 47, December QST

The jack bars mentioned in the right-hand paragraph were made of mycalex, which can be drilled — not isolantite.

Runover in the same article on page 90 should have a sentence correction "— and the cathode return lead which goes to terminal 7 on the same unit."

Wide-band frequency modulation is well on its way to a secure and expanding position in the broadcast field. To our way of thinking, it is going to carve out an important place for itself in the ham picture too. Its remarkable discrimination against man-made static as well as other types of amplitude noise make it a "natural" for ignition-ridden u.h.f. bands.

The experimenter, surfeited with the continual variations on the old theme of amplitude modulation, will find plenty to excite his interest and enthusiasm in the wide-band f.m. system, where some of our present conceptions have to be unlearned and supplanted by entirely new ideas. Here's the dope on how to get started on "F.M."

Wide-Band Frequency Modulation in Amateur Communication

Its Application and Advantages for U.H.F. Work

BY GEORGE GRAMMER* AND BYRON GOODMAN**

FREQUENCY modulation, like a weed in a flower bed, has been an undesirable offshoot which we've tried our best to eradicate in times past. With good reason, too, since it is a demonstrable fact that for transmission of the same type of intelligence a greater channel width is needed than for the familiar amplitude-modulation system, and space has been at a premium on our lower-frequency bands. But the ugly duckling is rapidly sprouting swan feathers in u.h.f. broadcasting, thanks to an entirely different method of attack by Major Armstrong,¹ and it behooves us to give a good look at frequency modulation and its application to amateur communication.

Now no miracles have been performed in making the frequency-modulated signal occupy less space than it used to; instead, the secret of f.m. performance lies in deliberately using up a whole lot more space than the amplitude-modulated signal takes. Therefore f.m. will have to be confined to the ultra-high-frequency region, where we have megacycles rather than kilocycles to play with, and where, because of shorter transmission ranges, an area like that of the United States can accommodate a tremendous number of stations all working on the same frequency without interference. At ultra-high frequencies, too, is where the outstanding inherent characteristic of f.m., reduction of re-

sponse to noise, particularly noise from ignition systems and other man-devised racket makers, is of most importance. Even the most sceptical will come away a confirmed rooter after a demonstration of a.m. versus f.m. in the presence of severe QRN of this type.

As we see it, the outstanding advantages of f.m. for amateur work are QRN reduction and simplification of transmitter equipment. The broadcasters, given an opportunity to start out

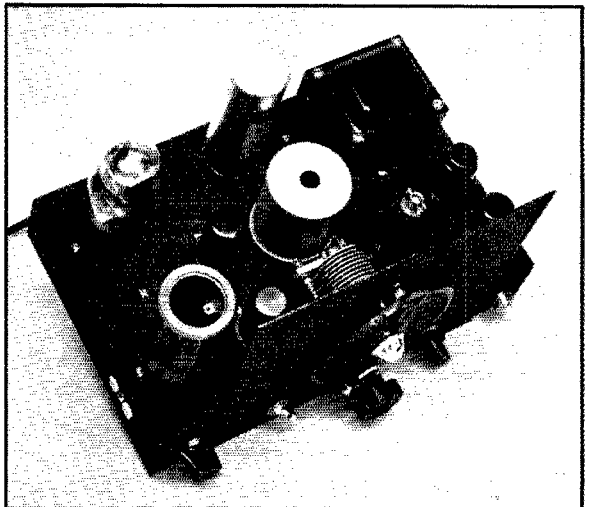

Modulation equipment is simple, compact and inexpensive. This 7 by 11 chassis contains frequency control and buffer units, the frequency modulator, speech amplifier and power supply.

The oscillator coil is in the round shield can in the center. The coil in the left foreground is the buffer output circuit. Speech amplifier and modulator are at the right, with the power supply along the rear edge.

* Technical Editor.

** Asst. Technical Editor.

¹ E. H. Armstrong, "A Method of Reducing Disturbances in Radio Signalling by a System of Frequency Modulation," *Proc. I.R.E.*, May, 1936.

afresh in new fields, are making the most of it by improving fidelity to the extent of transmitting audio frequencies up to 15,000 cycles, but we

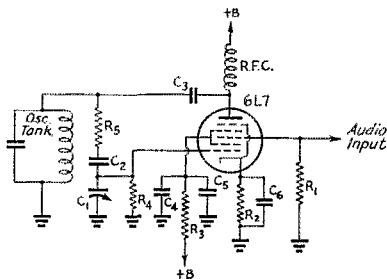

Fig. 1 — The frequency-modulator circuit.

- C₁ — 3-30- μ fd. compression trimmer.
- C₂, C₃ — 250- μ fd. mica.
- C₄ — 0.01- μ fd. paper.
- C₅ — 8- μ fd. electrolytic, 450-volt.
- C₆ — 0.01- μ fd. paper.
- R₁ — 0.5 megohm.
- R₂ — 300 ohms.
- R₃ — 30,000 ohms, 1-watt.
- R₄ — 0.5 megohm.
- R₅ — 50,000 ohms.
- RFC — 2.5-mh. r.f. choke.

need not look at that angle since our present audio range is quite adequate for communication purposes. In addition, there are secondary advantages, some of which apply particularly to the 112-Mc. band, where amateur frequency modulation must get its start. Let's take them in turn:

Noise reduction: The extent to which a frequency-modulation receiver discriminates against external noise, particularly of the impulse type, is remarkable. In some tests at WJNF, at A.R.R.L. Headquarters, where ignition and noises from electrical machinery are particularly bad on ultra-high frequencies, a perfectly readable f.m. signal could be obtained when an a.m. signal of the same carrier strength was sunk without a trace in the noise. Indeed, it seems that almost the only limit to the improvement which can be obtained in this respect is when the f.m. signal drops to the level of the inherent hiss-type noise in the receiver. With the latter type of noise

the f.m. receiver is at some disadvantage with respect to the a.m. receiver unless the incoming carrier strength is equal to or greater than that of the hiss.² This statement is subject to several qualifications, and in any event applies only to signals which are very weak and are readable on an a.m. receiver only when there is no external QRN. When the carrier becomes somewhat stronger than the hiss the signal-to-noise ratio in the f.m. receiver increases to many times (of the order of 20 db) that in an a.m. receiver having the same carrier input. Hence the silent background which is an outstanding feature of f.m. reception.

Transmitter simplification: The power required for modulation of the carrier is inconsequential, no matter what the final carrier output of the transmitter. Modulation may be applied directly to the frequency-control element, and all succeeding transmitter stages may be operated in any fashion desired, without regard to amplitude linearity. The following stages may be, and often are, frequency multipliers. Excitation worries are confined to getting power output from a stage; there is no such thing as supplying "enough excitation for linear operation" of a Class-C stage, nor critical circuit adjustments for Class-B amplification. Any stage can be loaded as one pleases. The final tubes can be operated Class-C at maximum ratings, since the plate input does not change. For the same reason, there are no condenser flashovers or equipment breakdowns from modulation peaks. Audio power amplifiers of any sort are unnecessary, since it is readily possible to get adequate frequency swing with a speech amplifier output of but a few volts at practically no power. An f.m. transmitter takes only about half the equipment needed for an a.m. transmitter of the same carrier power.

Receiver performance: At the present state of u.h.f. technique, it is difficult — even though perhaps not theoretically impossible — to obtain sufficient frequency stability on 112 Mc. to permit the use of the order of selectivity obtainable in the ordinary narrow-band a.m. i.f. amplifier.

² Murray C. Crosby, "Frequency Modulation Noise Characteristics," *Proc. I.R.E.*, April, 1937.

Fig. 2 — The oscillator-buffer circuit.

- C₁ — 250- μ fd. fixed low-drift mica.
- C₂ — 100- μ fd. variable.
- C₃ — 50- μ fd. variable.
- C₄ — 100- μ fd. mica.
- C₅ — 250- μ fd. mica.
- C₆ — 0.001- μ fd. mica.
- C₇, C₁₀, inc. — 0.01- μ fd. paper.
- R₁ — 100,000 ohms.
- R₂ — 25,000 ohms, 1-watt.

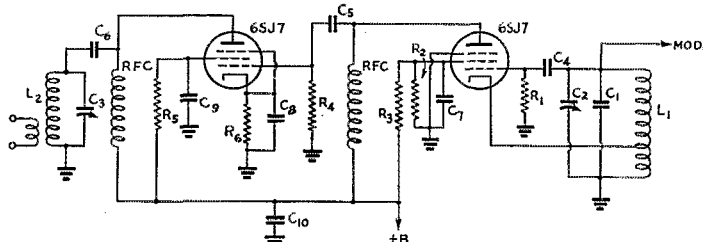

- R₃ — 50,000 ohms, 1-watt.
- R₄ — 50,000 ohms.
- R₅ — 50,000 ohms, 1-watt.
- R₆ — 300 ohms.
- RFC — 2.5-mh. r.f. choke.
- L₁ — 10 turns No. 18, length 1 inch, diameter, 1 inch, tapped 3rd turn from ground.
- L₂ — 20 turns No. 18, length 1½ inches, diameter 1½ inches.
- Link 5 turns at ground end.

This applies particularly to the h.f. oscillator in a superhet receiver, although transmitter instability is likewise greater than on lower frequencies, in terms of "absolute kilocycle" rather than percentage. There is usually some hum frequency modulation of the receiver oscillator, even with careful construction, at least when ordinary tuned circuits are used. As a result, the 112-Mc. superhet must have a relatively-wide-band i.f. if satisfactory results are to be secured with amplitude modulation. That being the case, not a great deal of selectivity need be sacrificed by using frequency modulation.

In connection with selectivity, one of the peculiar effects of f.m. transmissions has to be taken into consideration. Signals on or near the same frequency will not cause mutual interference unless the carrier strengths are almost identical.

If the strengths differ by as little as 2 to 1 the stronger signal takes control of the receiver and the others are unheard. For the most part, therefore, the use of rotary antennas (easy to build on ultra-high frequencies) should give a higher order of effective selectivity than is possible with amplitude modulation. We have some new experiences waiting for us in this respect.

The two systems, f.m. and a.m., are not mutually exclusive; that is, an f.m. receiver can be manipulated to receive a.m. signals fairly well, while an a.m. receiver will, with careful tuning and some cooperation on the part of the transmitting operator, give fairly decent reception of f.m. signals. A superregenerative receiver will work just about as well on f.m. as on a.m. transmissions; in fact, it seems likely that a good deal

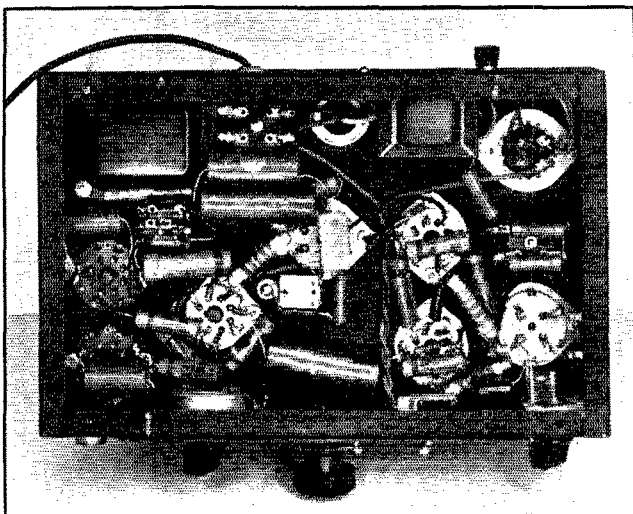

In this bottom view of the transmitting unit, the r.f. section is at the right and the audio at the left. The oscillator socket is the one just to the right of the coil socket in the center.

of the reception of unstable modulated oscillators has all along been by f.m. rather than a.m.

Finally, a modulated oscillator on 112 Mc. is easily receivable on an f.m. superhet — receivable, too, with less noise. And since the average 112-Mc. modulated oscillator swings over a considerably wider frequency range than is necessary for good f.m. reception, it becomes possible to reduce the percentage of amplitude modulation to the point which fits the receiver's frequency band, thus saving on modulator size and power. Of course the thing can be carried to its logical end and the oscillator given pure frequency modulation rather than frequency modulation via amplitude modulation, thus dispensing altogether with modulator power. We like the possibilities that this procedure opens for portable and mobile operation.

Since the principles of frequency modulation have already been discussed in *QST*,³ we shall confine ourselves here to a discussion of the various factors which apply particularly to amateur communication with frequency-modulated signals. We urge those who are not familiar with the system to give Prof. Noble's article a careful reading.

Standards

Percentage of modulation has no meaning in frequency modulation. The thing that counts is the frequency deviation from the carrier frequency for a modulating signal of the highest

³ D. E. Noble, "Frequency Modulation Fundamentals," *QST*, August, 1939.

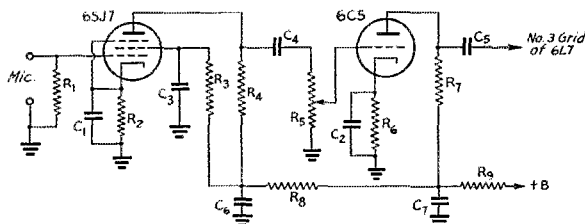

Fig. 3 — The speech amplifier circuit.

- | | |
|---|--|
| C ₁ , C ₂ — 10- μ fd. 25-volt electrolytic. | R ₃ — 1 megohm. |
| C ₃ — 0.1- μ fd. paper. | R ₄ — 0.25 megohm. |
| C ₄ , C ₅ — 0.01- μ fd. paper. | R ₅ — 0.5-megohm potentiometer. |
| C ₆ , C ₇ — 8- μ fd. 450-volt electrolytic. | R ₆ — 2000 ohms. |
| R ₁ — 5 megohms. | R ₇ — 50,000 ohms. |
| R ₂ — 900 ohms. | R ₈ — 0.25 megohm. |
| | R ₉ — 150,000 ohms, 1-watt. |

amplitude; that is, the frequency "swing" with the loudest sounds actuating the microphone. So far as the transmitter is concerned, there is no inherent limitation to the amount of swing or deviation that can be used; the only requirement to be met is that for distortionless modulation the deviation in frequency must be linear with respect to the amplitude of the modulating voltage. In practice, the limitation occurs in the receiver, in that it becomes necessary to select some pass band over which the amplitude of

the audio output can be held linear with respect to the frequency deviations of the incoming signal.

It is desirable, therefore, to set up tentatively at least some standards for amateur work. There is no need for such standards to be taken rigorously, however, since only practical use of the system will show what final standards will be desirable. The various factors to be taken into consideration include the amount of linear deviation which it is possible to secure at the transmitter by simple methods, the amount of receiver selectivity and gain necessary, and the requirements of the system for good noise reduction.

Perhaps the simplest method of generating f.m. signals is to frequency-modulate a self-controlled oscillator, in which case some compromise must be made between building an inherently stable oscillator (to minimize drift and unwanted hum modulation) and building one which is quite sensitive to the modulating voltage. In the receiver, the wider the band accepted the lower the gain, for a given number of amplifier stages. On the other hand, the mechanics of the system are such that the wider the band the better the noise suppression. Present broadcast practice is to use a deviation ratio, or ratio of maximum frequency swing on one side of the carrier to the highest audio frequency transmitted, of about 5.

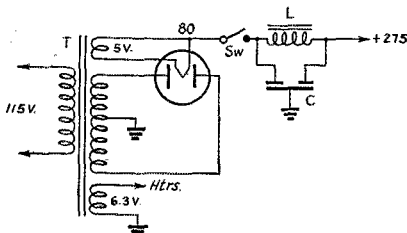

Fig. 4 — Transmitter unit power supply.

- T — Power transformer, 250 volts at 40 ma., with 6.3-volt, 2-amp. filament winding.
 L — 10-henry, 40-ma. choke.
 C — Dual-8 electrolytic, 450-volt.
 Sw — S.p.s.t. toggle switch.

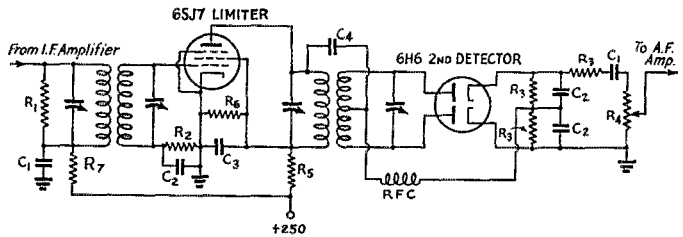

Fig. 5 — The limiter and second detector circuit.

- C₁ — 0.01- μ fd. 400-volt paper.
 C₂ — 0.0001- μ fd. mica.
 C₃ — 0.1- μ fd. 400-volt paper.
 C₄ — 30- μ fd. mica.
 R₁ — 10,000 ohms, $\frac{1}{2}$ -watt.
 R₂ — 300,000 ohms, 1-watt.
 R₃ — 100,000 ohms, $\frac{1}{2}$ -watt.
 R₄ — 1-megohm potentiometer.
 R₅ — 25,000-ohm 10-watt wirewound.
 R₆ — 1000 ohms, 1-watt (A 5000-ohm wirewound potentiometer could be used here to good advantage).
 R₇ — 2000-ohms, $\frac{1}{2}$ -watt.
 RFC — 2.5 mh. r.f. choke.
 See text for i.f. transformer data.

It seemed to us that for a starter the same deviation ratio would be about right for amateur work. Since we are interested only in transmitting audio frequencies up to 4000 or 5000 cycles for voice work, the total deviation necessary would be 20 to 25 kc. This is relatively easy to get at the transmitter even with a stable high-*C* oscillator, and also represents a satisfactory receiver compromise in that a band-width of 40 to 50 kc. is not too great for moderately good selectivity at 112 Mc., but still permits considerably higher per-stage gains than the 200-kc. band used in b.c. receivers.

The experimental equipment described here is based on such a standard. With the receiver aligned to give flat response over a 50-kc. band there will be some a.f. distortion introduced if the transmitter deviation exceeds 25 kc.; it is a simple matter to hold the modulation within whatever limits the receiver may impose. If the deviation is less than the receiver will accept the audio output will drop, just as less than 100% modulation gives lower audio volume in the amplitude system. It is desirable to swing the transmitter frequency over the full receiver range.

Modulation

The transmitter control unit shown combines an oscillator for transmitter frequency control, a buffer amplifier, the frequency modulator, a speech amplifier with enough gain for a crystal microphone, and a power supply for these circuits. It does not by any means represent the only way in which the job can be done, having been built to work into an already-existing 112-Mc. transmitter we had set up at W11NF. Since the latter outfit started out with a 7-Mc. crystal, the control unit was simply constructed to feed into the crystal stage so that stabilized f.m. could be put on the air with as little fuss as possible. It was also convenient for us to combine the various elements into one unit, although this is not essential.

The various elements of the transmitter unit are

shown separately in Figs. 1 to 4, inclusive. Fig. 2 is a rather conventional e.c.o. coupled through a choke-condenser-resistor combination to the grid of the buffer stage, the output circuit of which is tuned. The oscillator operates on 7 Mc. and uses a high-C tank circuit. Fig. 3 shows the two-stage speech amplifier, which also is quite straightforward in design. The network comprised by R_8 , R_9 , C_6 and C_7 is for plate-supply filtering in addition to that provided by the LC filter in the power supply shown in Fig. 4. The only unfamiliar device is the frequency modulator shown in Fig. 1.

The modulator circuit is of the a.f.c. type, in which the control tube acts as a variable inductance, except that instead of holding the frequency constant it is "worked backwards"; that is, it is used to vary the oscillator frequency at an audio-frequency rate. The operation of the device is no doubt familiar to those who service broadcast receivers, but is worth describing for the benefit of others who have not had occasion to use it. The control grid circuit of the modulator is connected across the small capacity C_1 , which is in series with resistor R_5 across the oscillator tank circuit. C_2 is simply a blocking condenser, and has no other function in the circuit. It may be omitted when no d.c. voltage appears across the tank circuit, as in the present case, but was installed to permit changing the circuit in the experimental layout. With R_5 large compared to the reactance of C_1 , the current through the series circuit R_5C_1 will be practically in phase with the voltage across the tank. The voltage across C_1 , however, will be 90 degrees behind the current, because of the well-known property of a condenser in causing the voltage across it to be in quadrature with the current through it. The r.f. current in the modulator plate circuit will be in phase with the r.f. voltage on the grid, and consequently lags the current through C_1 by 90 degrees. This lagging current is drawn through the oscillator tank, and since causing a 90-degree lagging current is the property of an inductance, the modulator tube simulates an inductance connected in parallel with the tank inductance. The amplitude of the lagging current, and hence the effective value of the inductance, can be varied by changing the amplification through the tube. By varying the current at an a.f. rate, we have frequency modulation. In many circuits the control voltage is applied directly to the control grid through an a.f. filter, but we preferred the isolation given by the No. 3 grid in the 6L7 for the purpose.

With the circuit constants and electrode voltages in the diagrams, a straight-line frequency deviation—No. 3 grid voltage characteristic can be obtained over a range of about plus or minus 2 volts about the operating grid bias of 3.5 volts (obtained from the cathode resistor, R_2). The deviation at 2 volts is 1500 cycles, which, since

the oscillator is operating on 7 Mc., must be multiplied by 16 to give the corresponding deviation at 112 Mc. At the latter frequency, therefore, a peak deviation of about 24 kc. can be secured with negligible distortion.

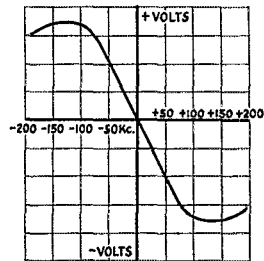

Fig. 6—The characteristic of the second detector of an f.m. receiver. The vertical axis represents the voltage developed across the load resistor as the frequency varies from the exact resonance frequency.

A detector with this characteristic would handle f.m. signals up to a band-width of about 150 kc. (over the linear portion of the curve).

Greater deviation readily can be secured by increasing the L/C ratio in the oscillator tank circuit. As mentioned previously, however, it is desirable to make the circuit as high- C as possible to minimize drift and hum frequency modulation in the oscillator itself. It seems desirable to compromise between these two considerations so that the maximum frequency deviation decided upon is secured when the limits of modulator linearity are reached, a condition which is met in the present case. This requires more modulating voltage, but at the power levels considered this is a small matter, since only 2 peak volts are needed anyhow.

The sensitivity of the modulator (cycles frequency change per volt input) will depend also upon the capacity of C_1 as well as the factors previously mentioned. In our case C_1 , a small isolantite-insulated padder was set practically at its minimum capacity of $3 \mu\text{mf}$. Larger capacity will reduce the sensitivity, and vice versa. This condenser provides a convenient means of control if the deviation is more than necessary in the first place.

Plate voltage is parallel-fed to the modulator through an r.f. choke as a matter of convenience; parallel feed is not a necessity in the system itself. The 6L7 screen is by-passed both for r.f. and audio, the latter because a change in screen voltage also affects the amplification in the tube and hence its operation as an inductance. It was found by test that a more linear characteristic was obtained when the screen voltage was not allowed to vary.

The other sections of the transmitter control circuit need little comment. With everything on one small chassis, some care must be used to avoid couplings between r.f. and audio sections. The usual care should be taken to prevent hum

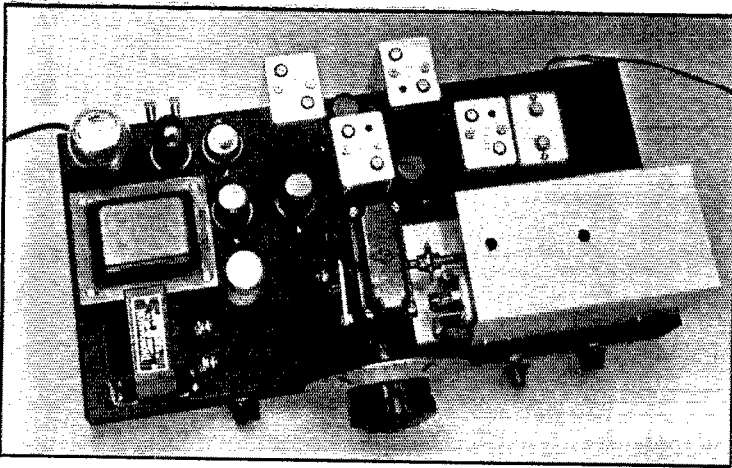

◆

The f.m. receiver looks like any conventional u.h.f. super-het. This particular one happens to be made from the front-end portion of the original "S.I.G." receiver and an i.f. amplifier using special 5-Mc. transformers. The power supply is included on the chassis. Controls on the front include audio volume control, i.f. gain control, and a switch to throw the converter into the f.m. receiver or into a conventional receiver tuned to 5 Mc., for comparison purposes.

◆

in the speech amplifier; in this particular instance we found it profitable to locate the filament wiring so that it was kept as far as possible from the grids of the single-ended tubes used. Hum in the audio system will show up as a "burble" on the c.w. signal from the oscillator when it is monitored on 7 Mc. With the No. 3 grid of the 6L7 shorted to ground the signal should be as clean as the ordinary c.w. signal. By working back towards the front end of the speech amplifier sources of hum readily can be detected and given the proper treatment. So far as the oscillator and buffer are concerned, they differ in no respect from similar e.c.o. rigs, and should be treated accordingly.

Other Methods

Frequency control of the transmitter can be handled in a variety of ways. There is no necessity for starting out on 7 Mc.; as explained before, this happened best to fit in with equipment we already had working. For stabilized transmissions, the usual crystal technique seems desirable, however, and the control unit can be made up to substitute for whatever kind of crystal is used. For instance, the buffer in Fig. 2 might just as well be a doubler to work into a 14-Mc. crystal stage. Or the whole business might be done in relatively few jumps by putting the oscillator on 18.8 Mc., tripling to 56, boosting power a bit and doubling to 112. Tripling and doubling readily can be used in many other combinations, so that relatively few tubes are needed. The 112-Mc. output stage may be either an amplifier or doubler; either works equally well so far as linearity of modulation is concerned. Also, larger buffer and oscillator tubes could be used.

For amateur work there seems to be no particular need for the extra stabilizing circuit previously described.³ While this is a necessity for fixed-frequency services where receivers often

are not subject to continuous attention, in an amateur band a small amount of drift is not serious either from a frequency or operating standpoint. As a matter of fact, practice has shown that the drift with a self-controlled oscillator is not at all bothersome, and is practically negligible after a short warm-up.

It should not be difficult to apply frequency modulation directly to a 112-Mc. oscillator, besides the method of generating frequency modulation by means of plate-voltage variation through an amplitude modulator. We shall probably see more of direct modulation in amateur work, but for preliminary experiments it seemed desirable to start out with more readily controlled transmissions.

Receiving Frequency-Modulated Signals

Possibly a bit puzzling at first, the reception of frequency-modulated signals introduces a concept in receivers which, while just as straightforward as with the conventional type, is radically different. First off, as already pointed out, the pass band for an f.m. signal must be anything from 50 to 200 or more kc. wide, depending upon the signal deviation, as compared with the pass band of a receiver for amplitude-modulated signals, which need be only 6 to 20 kc. wide, depending upon the audio-frequency range desired. Contrary to the case of amplitude modulation, the pass band in the wide-band f.m. receiver does not determine the audio range obtained. It does, however, have an effect upon the signal/noise ratio. In a receiver for amplitude-modulated signals, the signal/noise ratio is better as the pass band is decreased — in the f.m. receiver, the signal/noise ratio is improved as the pass band is increased.

This business of a wide pass band presents no particular difficulties. The front end (r.f., mixer and high-frequency oscillator) of any u.h.f.

superheterodyne is sufficiently broad to pass a band of the necessary width without attenuation, but it is necessary to go to an i.f. of 3 Mc. or higher so that the i.f. circuits will not be too sharp. For amateur purposes, a rather high i.f. is desirable to reduce image response. We decided on 5 Mc. as a suitable i.f. for the receiver shown in the photographs and used for experimental comparisons of frequency and amplitude modulation. Special transformers (Millen) were secured for the purpose through the coöperation of the manufacturer. If images are not a factor, the 3-Mc. Browning frequency-modulation transformers also can be used, with lighter loading than is recommended for broadcast reception to narrow the pass band. In practice, tightly-coupled circuits are used in the i.f. transformers, shunted by resistances of the order of 10,000 ohms further to increase the pass band. It is desirable to have good gain in the i.f. amplifier, and at least two stages should be used.

The signal from the i.f. amplifier is fed into a *limiter stage*, which is the second point where the receiver differs from the conventional type. The limiter stage is nothing more than an r.f. pentode amplifier working at low plate and screen voltage with grid-leak bias similar to a Class-C amplifier in a transmitter. Since it works at a very low plate and screen voltage (of the order of 5 to 15 volts in this receiver) it takes but little signal to saturate it and make it completely unresponsive to any kind of amplitude modulation, and at the same time it effectively acts as a type of automatic volume control. Obviously, the more gain ahead of the limiter stage the sooner it will reach saturation, which means that a weak signal will work the limiter in an f.m. receiver with adequate gain where it might not if sufficient gain were not available. It is the limiter stage that, once working at saturation, washes out practi-

cally all noise of the amplitude-modulated variety (all man-made and most set noise is of this type) and gives the widely-publicized "noise-free" reception. Although washing out amplitude modulation, the limiter will of course pass all frequency modulation.

From the limiter stage, the signal is fed into the *second detector*, which is quite different from the detector used for amplitude-modulated signals. The circuit is the same as that used in the "discriminator" of automatic-frequency-controlled broadcast receivers. It is shown in Fig. 5, and it can be seen that it appears to be a variety of full-wave rectifier, since opposite ends of the transformer secondary feed the two diode plates. However, the diode cathodes are not connected together but tie across opposite ends of a high resistance, one end of which is grounded. The center-tap of the i.f. transformer secondary is connected to the mid-point of the diode load resistance, through an i.f. choke, to provide a d.c. path for the rectified current. The center-tap is also connected to the "hot" end of the transformer primary through a coupling condenser. Thus the voltage applied to the rectifier network can be considered as consisting of two parts: that contributed by capacity coupling through the condenser and that induced by inductive coupling between the two windings. The voltage fed through by capacity coupling is in phase with the voltage across the primary of the transformer while the voltage induced by inductive coupling is always 180° out of phase with the voltage across the primary. At resonance, the current in the secondary will be in phase with the secondary voltage, since the secondary winding shows only resistance at this frequency, but at frequencies higher and lower than resonance the secondary will show inductive and capacitive reactance, respectively, and the current will lag and lead

◆
 A view underneath the chassis of the receiver shows how the by-pass condensers are bunched around the i.f. amplifier sockets, to give short leads and reduce regeneration. The rotary switch is used to switch the converter to another i.f. amplifier, for purposes of comparison.
 ◆

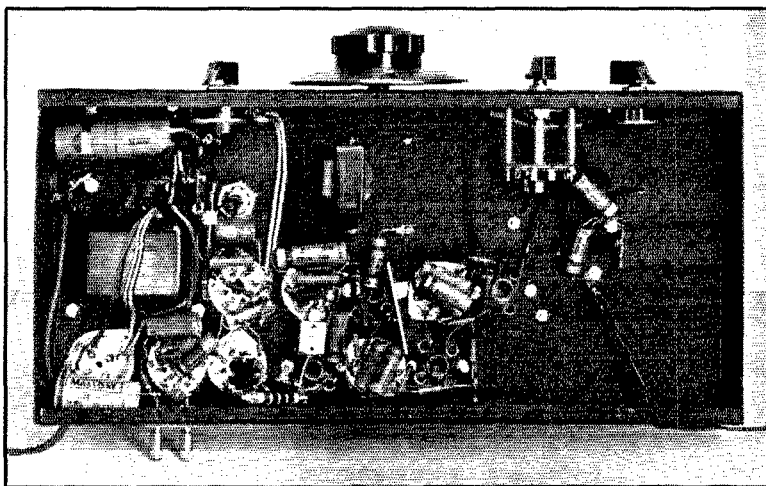

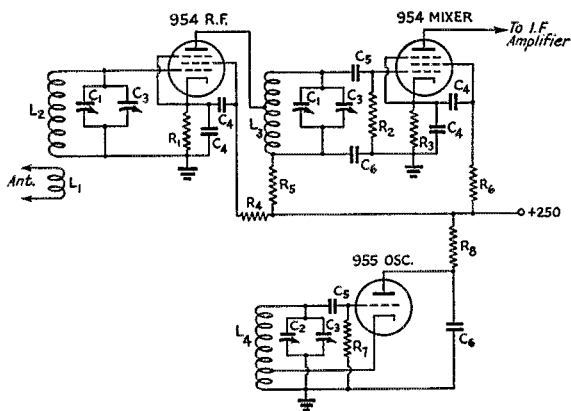

Fig. 7 — The "front end" or converter portion of the receiver.

- | | |
|---|---|
| C ₁ — 3-plate double-spaced
midget variable. | R ₇ — 50,000 ohms, ½-watt. |
| C ₂ — 5-plate double-spaced
midget variable. | R ₈ — 10,000 ohms, ½-watt. |
| C ₃ — 3-30- μ fd. mica trim-
mer condenser. | L ₁ — 5 turns No. 18 enam.
close-wound, ⅜-inch
diam. |
| C ₄ — 0.01- μ fd. 400-volt paper. | L ₂ — 5 turns No. 18 enam.
spaced to ½-inch
winding length,
⅜-inch diam. |
| C ₅ — 0.0001- μ fd. postage
stamp mica. | L ₃ — Same as L ₂ , with plate
tap on middle turn. |
| C ₆ — 0.001- μ fd. postage
stamp mica. | L ₄ — 2½ turns No. 14 spaced
to ⅝-inch winding
length, ⅝-inch diam-
eter. Cathode tap
¼-turn from ground
end. |
| R ₁ — 1500 ohms, ½-watt. | |
| R ₂ — 1 megohm, ½-watt. | |
| R ₃ — 2000 ohms, ½-watt. | |
| R ₄ , R ₆ — 100,000 ohms,
½-watt. | |
| R ₅ — 2000 ohms, ½-watt. | |

A wire from the oscillator grid is run close to the mixer grid, giving enough capacity coupling for mixing.

the voltage. The resultant rectified voltage developed across the load resistor can be drawn as in Fig. 6, which might be considered the detection characteristic of the stage. We see that, at resonance, no voltage is developed across the load resistors, but as the frequency becomes higher than resonance a proportionate negative voltage appears across the resistor, and as the frequency becomes lower than resonance, a proportionate positive voltage appears across the load resistor. Hence the audio output amplitude is proportional to the frequency deviation. For good detection, this characteristic should be linear over the pass band of the i.f. amplifier and symmetrical about the resonance frequency.

The voltage output of the detector is determined by the magnitude of the two types of coupling. In the receiver shown optimum capacity coupling was secured with a coupling condenser of about 30 μ fd., and with rather loose inductive coupling. The maximum points in either direction on the characteristic should be placed just outside the limits of the frequency band occupied by the transmitter, so that no distortion will be introduced in rectification. A wider "spread" between these two points can be used, but maximum audio output will be secured when the signal swings over the whole usable characteristic. The spread is determined principally by the Q of the secondary circuit, which may be adjusted slightly by varying the coupling between the secondary and primary, and also by loading the secondary with resistance. With the transformer used in this receiver, no resistance loading was necessary, since the coupling adjustment gave us sufficient range to permit placing the ends of the characteristic approximately 40 to 50 kc. each side of the center, with only the diodes loading the secondary.

The audio end of the receiver is conventional, and the chief necessity is to design it for adequate fidelity and sufficient power-handling ability. It is advantageous, however, to have fairly high gain, since this will permit full audio output from a relatively small signal from the detector. Although the amplitude of the r.f. signal fed to the rectifier does not vary, once the limiter is functioning, it is obvious that the value of that amplitude can be set by the initial limiting adjustment; that is, the threshold of limiting may be two volts or three volts or whatever one wishes to make it, within reason. The larger the voltage the greater the rectified current, hence the greater the audio output of the detector. By providing sufficient audio gain to make operation from a small rectified signal possible, the limiter threshold may be set quite low, with a resulting improvement in signal/noise ratio on weak signals.

Fig. 8 — The broad-band i.f. amplifier.

- | |
|--|
| C ₁ — 0.01- μ fd. 400-volt paper. |
| R ₁ — 20,000 ohms, ½-watt. |
| R ₂ — 10,000 ohms, ½-watt. |
| R ₃ — 60,000 ohms, ½-watt. |
| R ₄ — 2000 ohms, ½-watt. |
| R ₅ — 45,000 ohms, 1-watt. |
| R ₆ — 10,000-ohm potentiometer. |
| R ₇ — 300 ohms, ½-watt. |

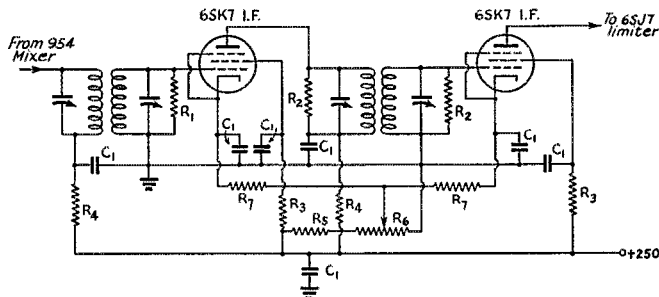

Receiver Construction and Alignment

The experimental receiver incorporates the acorn-tube front-end of the original "S.I.G." receiver⁴ with new coils for 112-Mc. operation. For comparison of the two systems the output of the 954 mixer is fed into either the f.m. i.f. amplifier or into a transformer which can be link-coupled to a conventional receiver tuned to 5 Mc. A switch on the panel permits instant change from one system to the other. This switching system is not shown in the drawings since it is not an essential of the f.m. receiver. The i.f. amplifier consists of two stages of 5-Mc. transformer-coupled 6SK7's, with the plate and grid circuits loaded to give adequate pass bands. The limiter stage is a 6SJ7 with about 8 volts on the plate. A 6H6 second detector feeds a

be set accurately on the frequency for which the i.f. is resonated. This is done by tuning the secondary circuit of the transformer, while the primary tuning chiefly affects the symmetry of the two peaks about the cross-over point. As already mentioned, the spacing of the two peaks can be controlled to a sufficient extent by adjusting the coupling between the coils. The peaks should be set 30 to 50 kc. either side of resonance. The coupling condenser can be set at maximum capacity and probably will need no further adjustment.

A fairly good job of setting the discriminator circuit can be done by ear if the signal generator can be modulated. With the carrier exactly at resonance (on the cross-over point) the audio output from the modulated signal will be almost

Fig. 9— Audio amplifier and power supply wiring diagram.

- R₁— 5000 ohms, ½-watt.
- R₂— 250,000 ohms, ½-watt.
- R₃— 75,000 ohms, ½-watt.
- R₄— 500 ohms, 1-watt.
- C₁— 10-μfd. 25-volt electrolytic.
- C₂— 16-μfd. 250-volt electrolytic.
- C₃— 0.1-μfd. 400-volt paper.
- C₄— 8-μfd. 450-volt electrolytic.
- C₅— 25-μfd. 450-volt electrolytic.
- Ch₁— 15-henry 85-ma. choke.
- Ch₂— 10-henry 40-ma. choke.
- T₁— 700-volt ct. 90-ma. transformer with 6.3 and 5-volt filament windings.

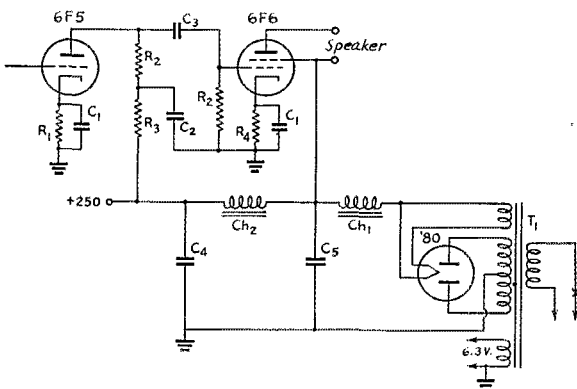

6SF5 audio which drives the 6F6 audio output tube.

The i.f. and limiter were aligned by using a signal generator for a source and a microammeter for the indicator, cut in between the limiter leak (R_2 of Fig. 5) and ground. A v.t. voltmeter across the resistor would have served as well, or even a "magic eye" can be used. The i.f. transformers were tuned to 5 Mc. and resistors added across the circuits until the pass band was flat within 1 db (90% of voltage at resonance), 20 kc. either side of 5 Mc., dropping off fairly rapidly after that.

It is essential that all i.f. circuits be tuned exactly to resonance, the necessary pass band being secured by resistance loading; "stagger" tuning may lead to considerable distortion in the rectified signal.⁵ The microammeter was then used with a 2-megohm resistor in series as a voltmeter across the diode load resistor ($R_3 + R_3$ of Fig. 5), and the input transformer to the second detector was tuned so that a characteristic similar to that of Fig. 6 was obtained. The cross-over point (zero voltage as read by the indicating device) should

zero, but as the signal generator is tuned either side of resonance the audio output will increase, becoming greatest at the peaks of the detector characteristic. By careful listening the adjustments for spacing and symmetry can be carried out in just the same way as with a visual indicator.

There is nothing difficult about the alignment process, once the principles are understood, if a signal generator (it can be a homemade affair, just so long as it is capable of being varied 100 kc. either side of the i.f. frequency) and a signal indicator (v.t. voltmeter, magic eye, or microammeter) are available. The signal generator should be fairly accurately calibrated in the region about the intermediate frequency, but this presents no problems to those who have calibrated frequency meters from WWV.

Since a wide pass band is desirable, no regeneration can be tolerated in the i.f. amplifier, and this may require a bit of experimenting with by-pass condensers and isolating resistors. It seems to be a good idea to use separate screen by-pass and dropping resistors, as well as plate isolating resistors and separate by-pass condensers. The single-ended tubes require that the cathode by-

(Continued on page 92)

⁴ See Fig. 1120, 1939 Handbook.
⁵ J. R. Day, "A Receiver for Frequency Modulation," Electronics, June, 1939.

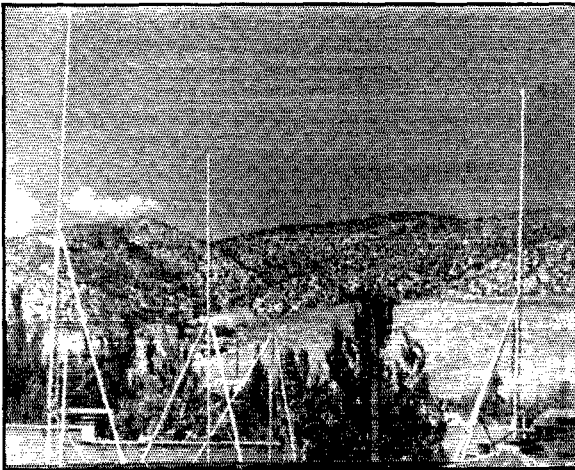

The Triangle Antenna

◆
The triangle beam at W6QCC is supported by three simple masts on the roof of the house. The shorter mast in the background supports another antenna.
◆

Selecting Directivity with a Non-Rotatable Beam

BY JAMES ARNOLD,* W6QCC

FOR the past several months here at W6QCC we have been experimenting with a 20-meter antenna system. The array has shown some very definite advantages over the antennas previously used and, while it is not intended to compete with the three- and four-element rotary antennas, it does, we believe, fill a gap between the fixed arrays and the rotaries. We have called it the "triangle array" for obvious reasons.

It is well known that two radiators spaced a half-wave apart and excited in phase show maximum radiation in a line perpendicular to the plane of the radiators. This represents the most elementary form of the broadside array. In case the radiators are excited out of phase the radiation pattern is shifted 90° to form a broad end-fire array with maximum radiation in the plane of the radiators.

Two-element arrays of this type have been used successfully for some time for increasing radiation intensity in definite directions. Reversing switches are sometimes provided to change phase and give either a broadside or end-fire array.¹ These two-element arrays are among the simplest and they give effective beams in the directions they are intended to work. The addition of a third element to form the triangle array came as an attempt to increase the flexibility of this simple directive system.

The triangle array consists of three vertical radiators located at the vertices of an equilateral triangle which is a half wavelength on a side. These radiators are operated two at a time, either

in phase or out of phase, the remaining radiator being left open. Using them this way gives six possible operating conditions. And, since the beam is bi-directional, six different operating positions effectively give selection of twelve directions distributed over 360°. This is shown in Fig. 2. In the diagram the radiators are located at E, W and S (for east, west, and south) and EW-i indicates that E and W are operated *in* phase. SW-o indicates that S and W are operated *out* of phase, etc. Thus the triangle array constitutes a means of rotating a rather broad beam in steps of 30° merely by antenna selection and phase changing, without the usual mechanical complications. As the radiators are vertical, a large share of the power goes into low-angle radiation where it is most useful. Mechanical requirements are

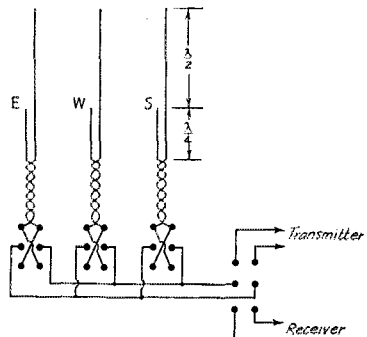

Fig. 1 — The triangle antenna consists of three vertical elements arranged in a triangle with half-wavelength sides. Phasing is controlled by closing any two switches and leaving the third one open.

* Ely, Nevada.

¹ Griffin, "Shifting Antenna Directivity by Phase Shifting," *QST*, Oct., 1935.

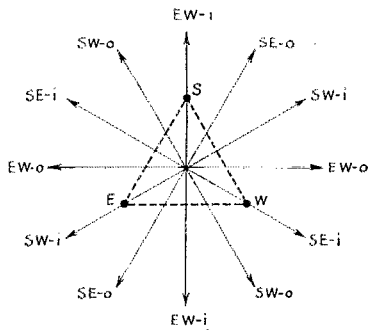

Fig. 2 — Twelve different directions can be obtained from the triangle antenna. For example, radiation along line SE-i is obtained when antennas S and E are operated in phase, while maximum radiation occurs along line SE-o when antennas S and E are operated out of phase.

very simple, since the antennas are fixed and there is no horizontal strain on the masts.

The set-up here at W6QCC is definitely not the most desirable. The radiators are the so-called type "J" antennas which are located on a comparatively flat roof in a triangle 36 feet on a side. The actual radiators are 33 feet long supported on insulators by light masts made of "2 by 2." The quarter-wave matching sections are horizontal and converge to the center of the triangle; twisted drop-cord lines (all of equal length) run from there to the switches located at the transmitter. The matching sections are raised a couple of feet above the roof to keep them out of the snow.

The selecting switches are mounted on the panel. They are simply d.p.d.t. knife switches connected for reversing and may be left open. The switches are wired so that when two of them are on the same side of center the antennas they feed are in phase and when opposite they are out of phase. The wiring diagram for the entire system is shown in Fig. 1.

◆
 The quarter-wave matching section at the bottoms of the vertical radiators converge to the center of the triangle, where the low-impedance feed lines are attached.
 ◆

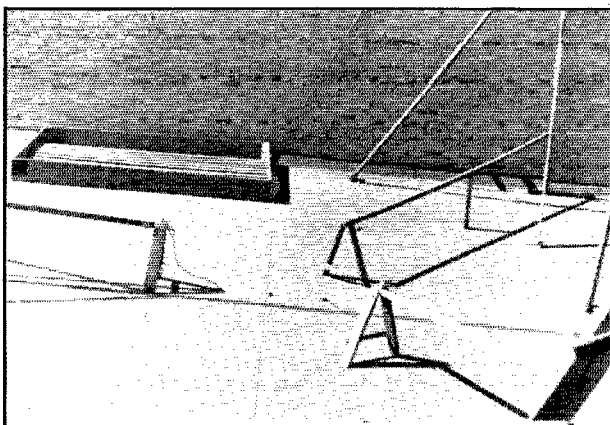

Here is another one of those antennas that has its directivity controlled by phasing instead of mechanical means. It only takes three vertical elements and three small knife switches to do the trick.

Link coupling to the tank coil was the most convenient, and no difficulty was encountered in getting the system to take power. The link coil was adjusted until the final stage was properly loaded with radiators connected. Switching the system does not affect the loading or tuning of the final stage.

Results

We have obtained quite a number of test reports on the behavior of the array when switched from one position to another. Most stations with whom we have tested report a definite but small difference between the signal strengths on adjacent positions which are 30° apart. When turned two positions (60°) the signal drops 3 or 4 S points and when turned three positions (90°) reports run all the way from "dropped from S7 to S3" to "inaudible."

The use of a volume indicator in the receiver circuit affords a convenient check on the behavior of the system as a receiving antenna. Considering a series of tests that were made over a period of several days, we found that the signal strength dropped 2 or 3 db from the loudest to the nearest adjacent position. Shifting the beam two positions dropped the signal 5 to 7 db while shifting it three positions dropped it 8 to 12 db. The average gain of the loudest position over a single antenna was 5 db by the meter.

Perhaps the most significant test is the fact that, in a hundred odd calls with the new array,

(Continued on page 53)

More on the Combined Beat Oscillator and I.F. Amplifier

An Improved Method of Adding C.W. Reception to a Receiver Not Provided with a B.F.O.

BY R. A. McCONNELL,* W8FJ

AN ARTICLE by F. W. Schor in the November, 1938, issue of *QST* explained a temptingly simple way to permit the reception of c.w. signals on superheterodyne receivers not otherwise equipped with a beat-oscillator. It was suggested that a 6L7 be substituted for the usual 6K7 i.f. amplifier and that the No. 3 grid be used to maintain oscillations at 155 kc., which is the third sub-harmonic of 465 kc. In the process of making such a conversion, the present writer uncovered several circuit considerations and variations, a knowledge of which may prove helpful to anyone who was unable to obtain satisfactory results with the original arrangement.

A first attempt to use the 6L7 showed a striking loss in receiver sensitivity, even when the coupling resistor R_1 (Fig. 1-A) was made so small that the b.f.o. was not in oscillation. This sensitivity loss was greater than could be expected from either the supply or signal voltage drop in R_1 . The explanation proved to be a simple one, namely, degeneration at the i.f. frequency due to the coupling of the plate to the No. 3 grid. Schor's circuit is redrawn in Fig. 1-A in such a way as to make conventionally evident the high-pass action of the oscillator tank circuit. The mutual inductance of the two parts of L_1 is not shown in Fig. 1-A because it is ineffective at the i.f. frequency at which degeneration takes place.

The final circuit adopted, shown in Fig. 1-B, prevents this degeneration by using a Colpitts oscillator. This arrangement has the added advantage that the rotor of C_1 may be grounded and that the somewhat critical feedback may be easily adjusted by changing C_5 , rather than by shifting a coil tap. To maintain the frequency at 155 kc., any adjustment of C_5 will require a much smaller percentage adjustment in C_1 or C_4 . Since the change in C_1 required to set the b.f.o. to any desired audio pitch is very small, the feedback is essentially constant throughout the operating range of C_1 . Thus, because the feedback is dependent on the ratio of C_5 to $(C_1 + C_4)$, whereas the frequency of oscillation is a function of the capacitance of C_5 in series with $(C_1 + C_4)$, the adjustments of feedback and frequency are relatively independent of one another when the values are as shown.

* 151 Center Avenue, Emsworth, Pa.

It is generally assumed that for satisfactory operation on c.w. signals some sort of separate manual sensitivity control must be substituted for the a.g.c. In the conversion of an all-wave b.e. receiver for communications use, such substitution proved to be an unwelcome complication. There are three reasons why an r.f. sensitivity control ordinarily replaces a.g.c. First is the fact that the b.f.o. output is generally not adjustable and, while the b.f.o. is made to oscillate weakly so as to be near the point at which the diode shifts from square-law to linear detection,¹ its output is still great enough as to actuate the a.g.c. and prevent reception of the weakest signals. This difficulty is sometimes avoided by the use of so-called "delayed" a.g.c. A second reason appears when the desired c.w. signal is relatively strong, in which case the a.g.c. action both changes the receiver transient response and causes a high noise background. These effects make the signal difficult to copy. A third reason is found when the desired signal is relatively weak in the presence of a strong interfering signal. When a.g.c. is retained, the changes in sensitivity caused by the keyed interfering signal confuse the listener and prevent achieving the theoretically desirable condition¹ that the b.f.o. signal be no stronger than the desired signal. The first two of these reasons for substituting a separate manual sensitivity control for the a.g.c. are successfully negated by the device of making the b.f.o. output controllable over a wide range. This is accomplished by making R_1 variable, as in Fig. 1-B. There is thus available a weakly oscillating b.f.o. for the reception of weak signals at full receiver sensitivity, or a strong b.f.o. signal

¹ It has been pointed out by F. E. Terman, *Electronics*, Nov., 1930, that it is peculiar to the linear detection of heterodyne signals that the difference-frequency output depends almost entirely upon the strength of the weaker of the two signals involved. The usual diode second-detector is a linear detector for all but small signal values.

It's easy to add c.w. reception to a superhet which has no b.f.o., by using this system which overcomes a disadvantage of the one previously described.

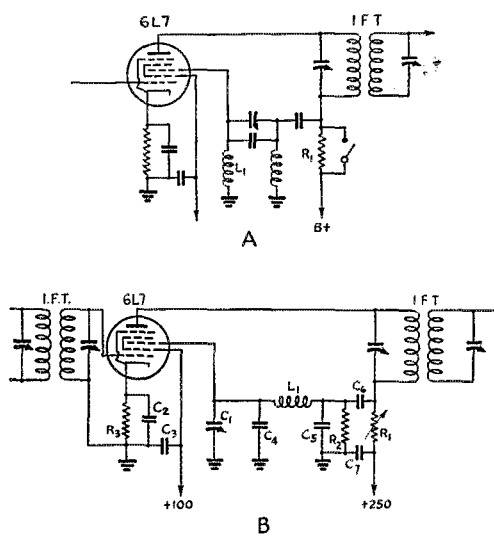

Fig. 1 — The original (A) and the revised (B) circuits for the combined b.f.o. and i.f. amplifier.
 C₁ — 70- μ fd. adjustable mica (Hammarlund MICS-70).
 C₂ — 0.1- μ fd. 200-volt paper.
 C₃ — 0.05- μ fd. 200-volt paper.
 C₄ — 550- μ fd. mica, subject to slight modification.
 C₅ — 0.01- to 0.002- μ fd. mica.
 C₆ — 0.01- μ fd. 400-volt mica.
 C₇ — 0.25- μ fd. 400-volt paper.
 R₁ — 5000- or 8000-ohm wire-wound potentiometer.
 R₂ — 25,000- or 250,000 ohms, $\frac{1}{2}$ -watt.
 R₃ — 300 ohms, $\frac{1}{2}$ -watt.
 L₁ — 2.5- μ h. r.f. choke (National R-100).

for the reception of strong signals at reduced sensitivity. The third objection to the retention of a.g.c. remains, but experience shows that this is of less practical importance than the first two. When an r.f. gain control and a.g.c. switch can be installed, the advantages to having R₁ variable largely disappear. If R₁ is not made variable, a switch to permit telephone reception must be installed, as in Fig. 1-A.

There are a number of minor points to be observed in adjusting the beat-oscillator. A.g.c. voltage must be removed from the grid of this i.f. stage, if present, otherwise the b.f.o. would limit its own output so that R₁ would not control the a.g.c. voltage as desired. Furthermore, loud signals would reduce the mutual-conductance of the 6L7 and stop the oscillator completely. If a.g.c. voltage is applied to a pentagrid-converter first-detector, it may be found that strong signals will chirp slightly until the b.f.o. is turned up. When C₅ and R₃ have been properly adjusted, the b.f.o. will slip smoothly into oscillation when R₁ is at perhaps 1000 ohms. The oscillations will be so weak as to have no appreciable effect upon the a.g.c. circuit. As R₁ is turned to maximum, the third harmonic b.f.o. output will increase continuously to a point where none but the loudest

local signals will affect the a.g.c. voltage. A 6E5 magic-eye connected for maximum sensitivity, or a d.c. v.t. voltmeter, will provide a rapid check of this adjustment. C₅ should be as large as possible. Its exact value will depend upon the value of R₃, upon the plate and screen voltages, and upon the design of the plate i.f. transformer. In the present case a value of 0.01 μ fd. was used when R₃ was made 300 ohms. R₂ is important both as a load on the b.f.o. and as a grid leak. In the writer's experience it was necessary to adjust it to within 10% of the optimum value. For further suggestions the reader is referred to Schor's original article.

Who Can Work Most States on U.H.F. in 1940?



AWARDS!
 Yes, there's a question to be decided. What enterprising amateur operator using any u.h.f. bands will work most states (of the 48 United States) from the beginning to the very end of 1940? Three suitably inscribed solid-bronze medallions, engraved with the call of the winner and the number of states he works ex-

clusively on u.h.f. in this coming year, will be awarded by A.R.R.L. All work credited must be that from one location, with the transmitter on 56-60-, 112-116-, or above 224-Mc. amateur bands.

A *location* is defined as "from places in one community, no two of which are more than 25 miles apart." The District of Columbia counts for Maryland as it was part of that state once.

Required: Written confirmations from the stations contacted, one such confirmation for each state claimed. Report new states at once, but hold confirmation cards and letters until the end of the year, when the leading operators must submit evidence to support claims, including (please) postage sufficient for the return of any such communications desired returned. All u.h.f. amateurs working for this should report their number of states (and progress) with their Marathon scores, from month to month, for QST mention. Monthly progress tables will appear from time to time. See that your call is there!

How many States can you work on u.h.f. in 1940?
 — F. E. H.

★ WHAT THE LEAGUE IS DOING ★

SPECIAL ELECTION NOTICE

To all A.R.R.L. members of the West Gulf Division:

You are hereby notified that a special election is about to be held in the West Gulf Division to elect an alternate director to fill the vacancy left by the death of W. H. Burt, W5BRC. The election will be for the unexpired remainder of the 1939-1940 term, plus the next regular term of two years, 1941-1942, as provided in By-Law 24.

If more than one eligible candidate is named, voting will take place during the month of March, 1940, on ballots that will be mailed from the headquarters office in late February.

Nomination is by petition. Nominating petitions are hereby solicited. Your attention is invited to the pertinent portions of the Constitution and By-Laws of the League, a copy of which will be mailed any member upon request. Ten or more A.R.R.L. members residing in the West Gulf Division may join in nominating any eligible West Gulf member of the League as a candidate. The following form is suggested:

Executive Committee
The American Radio Relay League
West Hartford, Conn.

We, the undersigned members of the West Gulf Division, hereby nominate W5..., of, as a candidate for alternate director from this division for the remainder of 1940 and for the next following full term of 1941-1942.

(Signatures and addresses)

The signers must be League members in good standing. The nominee must have been both a member of the League and a licensed radio amateur operator for a continuous term of at least four years immediately preceding receipt by the Secretary of his petition of nomination, except that a lapse of not to exceed ninety days in the renewal of the operator's license and a lapse of not to exceed thirty days in the renewal of membership in the League, at any expiration of either during the four-year period, will not disqualify the candidate. He must be without commercial radio connections; he may not be commercially engaged in the manufacture, selling or renting of radio apparatus normally capable of being used in radio communication or experimentation, nor commercially engaged in the publication of radio literature intended, in whole or part, for consumption by licensed radio amateurs. Further

details concerning eligibility are given in By-Law 12. His complete name and address, and call, should be stated. All petitions must be filed at the headquarters office of the League in West Hartford, Conn., by noon E.S.T. of the 20th day of February, 1940. No member shall append his signature to more than one petition. To be valid, a petition must have the signatures of at least ten members in good standing. Petitioners are urged to have an ample number of signatures, since nominators are frequently found not to be members in good standing.

Balloting will close at noon, April 1, 1940, and the successful candidate will take office as soon as the result can be determined.

All the powers of the division director are transferred to the alternate director in the event of the director's death or inability to perform his duties. This election therefore constitutes an important part of the machinery of self-government in A.R.R.L., and members are urged to take the initiative and file nominating petitions immediately.

For the Board of Directors:

K. B. WARNER,
Secretary

November 13, 1939

"DUPLIX" ABOVE 112

You may now operate "duplex" on frequencies above 112 Mc. It will be remembered that there is an F.C.C. reg stating that, except for brief tests or adjustments, 'phone stations shall not emit a carrier wave unless modulated for the purpose of communication. Last May the A.R.R.L. Board requested F.C.C. to relax this restriction as concerns the u.h.f. above 112 Mc., and in late November the Commission amended Sec. 152.43 so that the rule does not apply to $2\frac{1}{2}$, $1\frac{1}{2}$ and below 1 meter. We're free now, but let us be considerate of each other and not abuse the privilege.

At the same time, the Commission made belated corrections in our regulations to specify the upper frequency limit of the $2\frac{1}{2}$ -meter band as 116 Mc. A little flurry of excitement was caused in amateur ranks by the Commission's publication of the five amended rules which, because they quoted only those that had been corrected, created the impression in some quarters that our Class A 'phone bands had been deleted! This of course was not the case and the rule which deals with the Class A bands was not mentioned because no change was made in it. The 'phone bands are the same as ever.

SANTIAGO CONFERENCE

BY THE time these lines are read, the United States will have completed its preparation for the second inter-American radio conference and shortly before the end of the year its delegation will sail for Santiago de Chile, where the meeting opens in middle January. The United States of course continues to support the assignment of all U. S. amateur bands as exclusively amateur throughout the Americas, and it is expected that all the American administrations will join in embracing this traditional point of view. There is nothing else very exciting on the agenda from the amateur point of view. A.R.R.L. expects to be represented by Segal and Warner.

MISCELLANY

GOT your new A.R.R.L. *Handbook*? We thought you might be interested in knowing that in the first week of its appearance, something over 25 tons of the new *Handbooks* moved through the A.R.R.L. shipping room on their way to individual purchasers and dealers. And that in the preparation of the new edition, six members of *QST*'s editorial staff put in about a thousand hours of overtime work in three months. Have they been a busy bunch! Everybody says it's the finest job we've ever turned out, so we're feeling happy.

WIINF, the station of the Headquarters Operators Club, is on the air on 5 and 2½ with a neat little 200-watt station in the penthouse atop A.R.R.L. headquarters. The antenna is a vertical coaxial about 60 feet high. It is in this station that the frequency-modulation apparatus described in this issue is receiving its work-out.

If there are any K7 amateurs who do not know it: The postmasters of Alaska are now authorized to administer oaths and affirmations and to take acknowledgments — which may help in some amateur applications.

"PATRIOTS ON SHORT WAVE"

UNDER the above title, the *Chicago Daily News* printed the following editorial in late October, which we think will interest League members:

The Federal Communications Commission's prompt squelching of the suggestion that our neutrality might be in danger of violation through illegal traffic in short-wave radio messages should settle all doubts upon that score. As the commission points out, its rules forbid operation of short-wave equipment to all but American citizens, and these operators are banded together in organizations such as the American Radio Relay League, which do their own policing and are constantly on the alert to report unfamiliar messages, in secret code or otherwise, to the authorities at Washington.

Moreover, anyone familiar with the breed can testify that these "hams," as the amateurs delight to call themselves, are as ardently patriotic a group as can be found in American life. Most of us are familiar with the record of their splendid services in times of civil emergency and natural upheaval, such as floods, fires and storms. What the general public is less likely to appreciate is the fact that their coordinated

services have put them in position to prove, if the necessity ever arises, just as valuable in a military as in a civil emergency. In every state, members of the great "ham" family are tied in very directly with National Guard units and Army and Naval reservists. Many hold reserve signal corps commissions, and plans for M-Day are nearly always based to some extent upon communication provided by short-wave stations.

So widespread is the ham network, so continuous its operation and so devoted the patriotism of the men who man it at all hours and in the remotest sections, that the possibility of espionage communication or transmission of subversive propaganda via short wave, without the consent of the government, seems wholly negligible.

Bound Volume XXIII of 'QST'

WE have a limited number of Bound Volume XXIII of *QST*. This volume is made up in two sections, each containing six issues of 1939 *QST*. Handsomely bound and gold imprinted the complete volume is priced at \$7.50, postpaid.

WWV Schedules

EXCEPT for the special broadcasts of WWV using 20 kw. as described below, WWV is now running a continuous schedule (day and night) on 5000 kc. with a power output of 1 kw. This continuous transmission is modulated with the standard pitch in music, 440 cycles per second.

Each Tuesday, Wednesday and Friday (except legal holidays), the National Bureau of Standards station, WWV, transmits with a power of 20 kw. on three carrier frequencies as follows: 10:00 to 11:30 A.M., E.S.T., on 5000 kc.; noon to 1:30 P.M., E.S.T., on 10,000 kc.; 2:00 to 3:30 P.M., E.S.T., on 20,000 kc. The Tuesday and Friday transmissions are unmodulated c.w. except for 1-second standard-time intervals consisting of short pulses with 1000-cycle modulation. On the Wednesday transmissions, the carrier is modulated 30% with a standard audio frequency of 1000 c.p.s. The accuracy of the frequencies of the WWV transmissions is better than 1 part in 5,000,000.

EXPERIENCE SPEAKS

A VERY handy cleaning tool for radio apparatus is the ordinary pipe cleaner. It is especially useful in cleaning out socket prongs, variable-condenser plates, switch contacts and other hard-to-get-at parts. Alcohol is a good solvent for rosin. Dip one end of the cleaner in cleaning solution and use the other end for wiping dry. Dirty isolantite sockets can be made to look like new without dismounting.

A.R.R.L. Announces U.H.F. Marathon for 1940

BY F. E. HANDY,* WIBDI

RULES

1. The Contest is open to all licensed radio amateurs.

2. Operating and experimental work taking place during the year 1940, and reported to A.R.R.L. shall count points toward awards.

3. Contacts may be scored for each completed QSO with a station, points claimed depending on distances² measured by a great circle line between stations, as follows:

Under 25 miles	1 point
25 to 75 miles	2 points
75 to 250 miles	5 points
250 to 500 miles	25 points
500-1500 miles	10 points
Over 1500 miles	50 points

Scoring 56-60 Mc. points follows the above tabulation. *Two times* these point credits may be obtained for 112-116-Mc. band contacts, and *ten times* the basic credit for contacts reported using the frequencies above 224 Mc. assigned by the F.C.C. to amateurs.

4. In computing the point score, a competitor may claim points for each different station worked but once *on a particular band*, for the entire year. Monthly additions to credits will boost the score

* Communications Manager, A.R.R.L.

¹ See list of field organization Sections in the front of this QST.

² Normal u.h.f. work is generously credited for the marathon, points depending on distances involved, which depends on the careful adjustment of u.h.f. gear, on the antenna design, and operating ability. *The liberal credits* (1 and 2 points) *for distances up to 75 miles enables* every operator of u.h.f. gear to report a score on the u.h.f. bands!

Work up to 250 miles is harder, and 250-500 miles *much* harder, than that at lesser distances. The credit goes up appropriately to a value that will represent a return for the pains taken to assemble good apparatus, and the time used in research and testing to work the instances involved. For work 500-1500 miles, dependent on unusual refractions, freak and short-term conditions apply, with less credit (10) to efforts and efficiency than to good luck, and chance equal to all. For over 1500 miles, extra recognition is given for a rare feat, with sufficient written documentation to contribute to knowledge and frequency of occurrence of rare "skip-DX."

standing, and claim toward the 1940 U.H.F. ACHIEVEMENT Certificate. The same station may be worked on *other* of the u.h.f. bands mentioned above, for additional appropriate credit therefor. (Portable or portable-mobile work with this same station may be substituted in a list for its fixed station credit in a given band, if the distance is greater. A portable or portable-mobile equipment may be used by the competitor himself, and when duly controlled and operated by this competitor, points so attained with stations not appearing in the fixed-station portion of the particular score, will be granted. This is to say that a call signal is regarded as indicating a single station identity, whether operated in fixed or portable-mobile status. All points claimed must be those attained by an individual amateur operator himself, operating equipment under his own call *only*.)

5. Monthly claims must be made in the form of a "stations worked" list, indicating distances and points for the stations shown with the claimed total for a given calendar month. The frequency band of your transmitter shall determine the multiplier of 1, 2, or 10 applicable to particular contacts and allows cross band work to count. Monthly claims must be sent *at once*, following the end of a calendar month. To be considered for the certificate given for that month, and to be reported in the u.h.f. section in QST, or to count toward annual awards, reports for each month must bear a postmark *not later than* the tenth of the following month. (1940 U.H.F. Award for Section winners for the year's work on all u.h.f. and the bronze medallions to be engraved to credit highest communication credits in *each separate u.h.f. band* mentioned, will be determined for the Marathon after Feb. 1, 1941, based on participant's summary and *mailed-on-time monthly reports in substantiation*.)

6. Proof of contact in writing from any stations contacted may be required as prerequisite to credit, whenever thought necessary by the

Radio Contacts Jan. 1, 1940-Dec. 31, 1940, to Determine Standings Reported Monthly in QST — 1, 2, or 10 Multiplier Applies (respectively) to Points Claimed for your 56-, 112-, or 224-Mc.-and-above Frequency Band Contacts — High Monthly Scorer to Get Certificate Award — Special Certificate to U.H.F. Marathon Winner for Each A.R.R.L. Section¹ at Year-End — Leading Operator Claim for Each of Three (above) U.H.F. Band Groups also to Get a Medallion Award.



award committee of A.R.R.L.-QST staff members, and will be expected always on contact claims exceeding 500 miles.

7. Extra credit, in no case to exceed 10%, may be granted participants for reported technical achievements, submitted articles in the u.h.f. field, intelligent observation of unusual conditions, photos, etc. such to count toward marathon awards only if these items are summarized and brought to the attention of the Committee toward the end of the marathon, preferably attached to the twelfth or last monthly contact report, and 12-month summary of claims. *Operating utilization* of the u.h.f. bands will be the important determinant of the winners. All those overlooking no possible credit will take the opportunity (equal to all) to add this possible fixed credit to their general standing for the year.

AWARDS

Monthly certificates, and the special 1940 Marathon certificate awards to each Section high scorer, will be signed by the three members of this award committee, the technical editor, the contributing editor, u.h.f., and the communications manager. These are beautiful, lithographed, full 8½ by 11 inch certificates, for the (1) monthly leader^s in points (2) the highest u.h.f. scorer for the year, in each A.R.R.L. Section. The three medallion awards are to be suitably engraved bronze charms, bearing the calls of leaders considering only the work for a particular u.h.f. band. If there are fewer than three entries in any band classification the committee reserves the right to declare "no award" or if there are ties, duplicate awards will be granted. W1HDQ, W1AW, W1INF and other operator work of staff-member stations may be recorded but all such operators will be ineligible for this or other A.R.R.L. u.h.f. awards.

REPORTING

Starting January first, the U.H.F. Marathon will be in progress for one year. QST will show monthly standings of all reporting amateurs. It

* "The monthly leader" is the person showing most points, or greatest progress for a calendar month in question, without respect to the cumulative marathon-standing.

is not necessary to be a League member to take full part. Just do some u.h.f. operating and report (worked lists with claimed points, first of each month) and your chances will be excellent. Address all reports to A.R.R.L. Communications Department, West Hartford, Conn.

★ A.R.R.L. QSL BUREAU ★

For the convenience of its members, the League maintains a QSL-card forwarding system which operates through volunteer "District QSL Managers" in each of the nine United States and five Canadian districts. In order to secure such foreign cards as may be received for you, send your district manager a standard No. 10 stamped envelope. If you have reason to expect a considerable number of cards, put on an extra stamp so that it has a total of six-cents postage. Your own name and address go in the customary place on the face, and your station call should be printed prominently in the upper left-hand corner.

- W1 — J. T. Steiger, W1BGY, 35 Call Street, Willimansett, Mass.
- W2 — H. W. Yahnel, W2SN, Lake Ave., Helmetta, N. J.
- W3 — Maurice Downs, W3WU, 1311 Sheridan St., N. W., Washington, D. C.
- W4 — G. W. Hoke, W4DYB, 328 Mell Ave., N. E., Atlanta, Ga.
- W5 — James F. Manship, W5ALE, 910 So. Boston, Tulsa, Okla.
- W6 — Horace Greer, W6TI, 414 Fairmount Ave., Oakland, Calif.
- W7 — Frank E. Pratt, W7DXZ, 5023 So. Ferry St., Tacoma, Wash.
- W8 — F. W. Allen, W8GER, 324 Richmond Ave., Dayton, Ohio.
- W9 — Alva A. Smith, W9DMA, 238 East Main St., Caledonia, Minn.
- VE1 — L. J. Fader, VE1FQ, 125 Henry St., Halifax, N. S.
- VE2 — C. W. Skarstedt, VE2DR, 236 Elm Ave., Westmount, P. Q.
- VE3 — Bert Knowles, VE3QB, Lanark, Ont.
- VE4 — George Behrends, VE4RO, 186 Oakdean Blvd., St. James, Winnipeg, Manitoba.
- VE5 — H. R. Hough, VE5HR, 1785 First St., Victoria, B. C.
- K4 — F. McCown, K4RJ, Family Court 7, Santurce, Puerto Rico.
- K5 — Norman F. Miller, K5AF, 15th Air Base Squadron, Albrook Field, Canal Zone.
- K6 — James F. Pa, K6LBH, 1416D Lunalilo St., Honolulu, T. H.
- K7 — Jerry McKinley, K7GSC, Box 1533, Juneau, Alaska.
- KA — George L. Rickard, KA1GR, P. O. Box 849, Manila, P. I.

Regeneration in the Preselector

Theoretical Investigation of the Possibilities of Image Rejection and Gain

BY G. H. BROWNING*

It is generally appreciated in amateur circles that efficient preselection is advantageous from the standpoint of image rejection, gain, and increased signal-to-incoming noise ratio. Some time ago the writer had occasion to examine possibilities of several types of preselection circuits both from a mathematical and a practical standpoint. It is believed that data collected during this examination may be of general interest and will therefore be presented in the discussion which follows.

tuned circuit will have a reasonably constant Q over a considerable frequency spectrum because as the frequency is increased, the radio-frequency resistance of the coil increases in about the same proportion.) Under controlled laboratory conditions with very stable circuit components and constant temperature for these circuits, it was found that the original Q of a tuned circuit could be increased more than five hundred times so that, if a tuned circuit originally had a Q of, for instance, 100, the resulting effective Q with re-

Fig. 2 — Regenerative preselector circuit considered in the text.

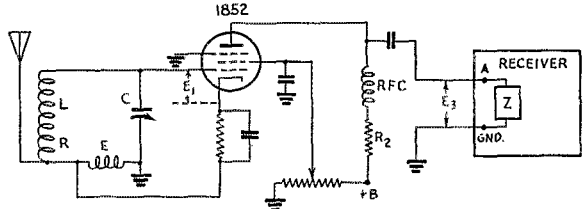

At least two straightforward and practical systems of obtaining image rejection, additional gain, and increase in signal-to-noise ratio are possible. The first system would consist of regeneration in a high- Q tuned antenna system while the second would consist of a stage or two of radio-frequency amplification without regenera-

tion. Practical experiments conducted under non-controlled conditions but using as stable circuit constants as are available at the present time indicate that the Q of a tuned circuit which was originally about 100 could be increased by regeneration to have an effective Q of from 1000 to 5000. By careful manipulation with an 1852 tube, even higher values can be obtained without the circuits breaking into oscillation. In this article, it will be assumed that the practical limit is between 1000 and 5000. For comparison purposes it might be pointed out that the Q of resonant lines is about 10,000 or more while the Q of an X-cut crystal is 25,000 or more.

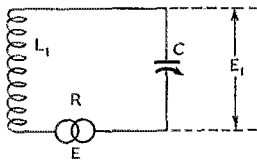

Fig. 1 — The resonant circuit and fundamental quantities.

A third system might combine the two previous methods and, from a theoretical angle, is entirely possible. However, so many difficulties are encountered in practice that this system might be ruled out because of the problem of tracking or the additional controls required.

Some years ago, work was done at Cruft Laboratory, Harvard University, on the subject of regeneration as applied to a tuned circuit to increase its Q . (The Q of a tuned circuit is the ratio of inductive reactance in the tuned circuit to the radio-frequency resistance; a well-designed

Let us first examine mathematically the voltage developed across a tuned circuit when an electromotive force is impressed in series, as shown in Fig. 1.

Let

E = series e.m.f.

L = inductance of the coil in henrys.

C = capacitance of the condenser in farads.

R = total radio frequency circuit resistance due to losses in the inductance and capacitance, expressed in ohms.

* Browning Laboratories, Winchester, Mass.

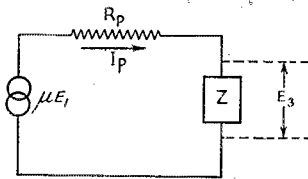

Fig. 3—The equivalent circuit of an amplifier tube and load.

I = current in amperes flowing in the tuned circuit.

$\omega = 2\pi$ times the frequency in cycles per second.

Then

$$I = \frac{E}{\sqrt{R^2 + \left(\omega L - \frac{1}{\omega C}\right)^2}} \quad (1)$$

When the circuit is tuned to resonance

$$\omega L = \frac{1}{\omega C} \text{ and}$$

$$I = \frac{E}{R} \quad (2)$$

The very approximate voltage developed across the tuned circuit under these conditions is

$$E_1 = \omega LI. \quad (3)$$

Substituting in equation (3) the value of I given in equation (2), we obtain

$$E_1 = E \frac{\omega L}{R}. \quad (4)$$

The voltage ratio or gain is equal to

$$\frac{E_1}{E} = \frac{\omega L}{R}. \quad (5)$$

But

$$Q = \frac{\omega L}{R}.$$

Therefore

$$\frac{E_1}{E} = Q. \quad (6)$$

As previously pointed out, a well-designed circuit may have values of Q from 100 to 300 and this value is reasonably constant over a considerable range of frequency.

Now regeneration applied to the tuned circuit may be considered as lowering the effective radio frequency resistance R and consequently increasing the value of Q .

Therefore we see that if, by means of regeneration, Q has values of from 1000 to 5000, the voltage which may be impressed upon the grid-cathode circuit of a tube is 1000 to 5000 times the voltage developed in series due to the incoming signal from the antenna. This statement is only true for signals of very small magnitude, because there is of course a limit to the maximum signal amplitude which can be obtained.

Regenerative Preselection

Let us examine means of obtaining regeneration and at the same time coupling the signal from the tuned circuit to the input of the radio receiver. The essential parts of such a circuit are shown schematically in Fig. 2. The signal fed from the antenna flows through a few turns of wire to ground, developing a voltage E in series with the tuned circuit. The voltage E_1 is developed across the tuned circuit and is impressed between grid and cathode of the 1852 tube. Regeneration is obtained by feedback from the plate, the amount of feedback being controlled by a variation of screen d.c. voltage. Now the quantity that we are particularly interested in is the ratio E_3/E ; for, assuming that when the antenna is switched to the receiver (point A) without the preselection stage, the voltage developed across the input of the set would be the same as that developed in the tuned circuit (E), this ratio E_3/E would give the total gain due to the preselection stage.

To evaluate this quantity, it is necessary to calculate the gain due to the tube itself or the ratio of E_3/E_1 .

The equivalent circuit of a tube used as an amplifier is shown in Fig. 3. Z , the input impedance in the average receiver, might be about 400 ohms at frequencies from 2 to 14 Mc., and as this is much smaller than the impedance of RFC plus R_2 , it will be considered as the plate circuit load. R_p is the plate resistance of the 1852 tube, or approximately 750,000 ohms. μ is the amplification factor. Now as the load impedance of 400

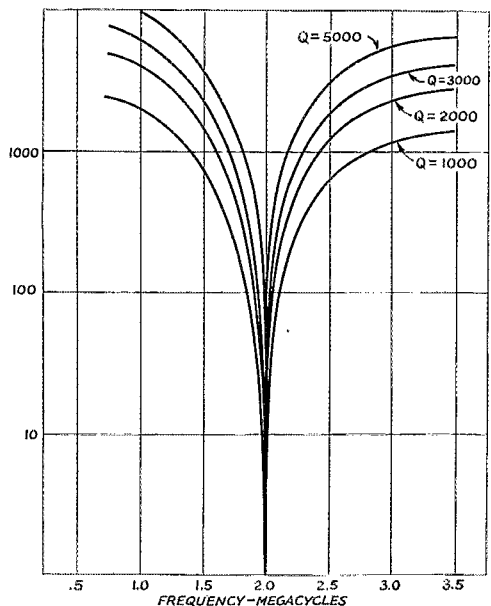

Fig. 4—Resonance curves for circuits tuned to 2.0 Mc., and having circuit Q 's from 1000 to 5000.

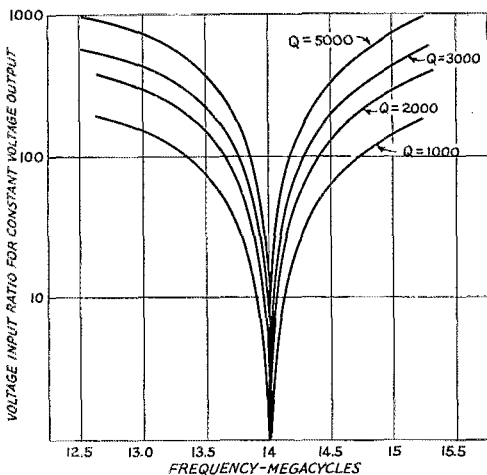

Fig. 5 — Resonance curves for circuits tuned to 14.0 Mc., with Q 's from 1000 to 5000.

ohms is entirely negligible (regardless of its phase angle) compared to 750,000 ohms, the radio-frequency current flowing in the circuit is

$$I_p = \frac{\mu E_1}{R_p} \quad (7)$$

and

$$E_3 = Z I_p = \frac{\mu E_1 Z}{R_p} \quad (8)$$

μ/R_p is the transconductance G_m which, in the case of the 1852 will be at least 6000 micromhos. Substituting this in equation (8) gives

$$\frac{E_3}{E_1} = G_m Z. \quad (9)$$

Substituting the numerical values, we find that $E_3/E_1 = 2.4$. From previous calculations $E_1/E = 1000$ to 5000. Consequently, the overall gain of the stage is $E_3/E = 2400$ to 12,000 times, according to the regeneration used. Thus, it is seen that a very large gain can be obtained with a regenerative stage if the circuit components are stable and allow smooth control of regeneration. Let us now examine the shape of the resulting resonance curves to determine the image rejection ratios which are possible. Two such resonance curves are plotted in Figs. 4 and 5 with values of Q from 1000 to 5000. All of these curves show the input voltage ratio for a constant voltage output at various frequencies close to the resonant frequency. In Figs. 4 and 5 the resonant frequencies are 2 and 14 Mc.

The image frequency is always twice the i.f. in the superheterodyne. Usually the image frequency is on the high-frequency side of the signal frequency. (This is the case if the oscillator in the receiver is higher in frequency than the resonant frequencies of the antenna and r.f. tuned circuits.) It will be noted that the reso-

nance curves are not symmetrical, and in determining image rejection ratios, it will be assumed that the image is on the high-frequency side of the signal. Therefore, if the receiver has an i.f. of 465 kc. and is tuned to 2.0 Mc., the image rejection ratio with a Q of 1000 is approximately 1000 and with a Q of 5000 is approximately 5400. If the image was on the low-frequency side of the signal even greater rejection would be obtained.

At 14 Mc., assuming the same i.f., the image rejection ratio is 130 with a Q of 1000 and 690 with a Q of 5000.

Laboratory tests indicate that the theoretical gain and image rejection could be obtained in practice if extremely weak signals were impressed on the antenna. The tests also reveal that a large amount of care in adjusting the regeneration was necessary if maximum performance was to be obtained.

Non-Regenerative Preselection

Let us now consider the possibilities of preselection consisting of a stage of r.f. amplification working into a coupling tube which in turn connects to the receiver, such as shown in Fig. 6. In the case of an r.f. pentode where the plate resistance is high compared to the load in the plate circuit, it can be shown that at resonance (maximum gain) the gain due to the tube and r.f. transformer is expressed by

$$\text{stage gain} = \frac{E_2}{E_1} = G_m Q_2 k \sqrt{\frac{L_1}{C_2}} \quad (10)$$

where E_1 is the a.c. voltage impressed on the grid of the tube and E_2 is the voltage developed across the tuned r.f. transformer.

G_m = transconductance of the r.f. tube

$$Q_2 = \frac{\omega L_2}{R_2}$$

k = coefficient of coupling between L_1 and L_2 .

L_1 = the inductance of the primary of the r.f. transformer

C_2 = capacitance of the condenser.

At 14 Mc. the constants might be somewhat as follows:

G_m for 1852 tube = 6000 micromhos

$Q_2 = 40$

$k = 0.3$

$L_1 = 0.5 \times 10^{-6}$ henrys

$C_2 = 100 \times 10^{-12}$

Placing these values in equation (10) we find that the stage gain is about 5. This value must be multiplied by the value of E_1/E (the gain in the tuned antenna circuit) and by E_3/E_2 (the gain in the coupling tube). If the antenna circuit has a Q of 40, $E_1/E = 40$. If the 1852 is used as a coupling tube and $Z = 400$ ohms, $E_3/E_2 = 2.4$ (as per previous calculations). Consequently the total gain of the system E_3/E is 480.

Thus it would appear that regeneration in the

tuned antenna circuit is capable of producing greater gain and image rejection than could be obtained from a stage of r.f. amplification. From the standpoint of signal-to-incoming noise ratio, regeneration in the antenna stage has a considerable advantage.

At 5 and 10 meters, regeneration in the antenna stage apparently is still superior to the stage of r.f. Any measurements or mathematical predictions concerning these frequencies would probably be of a controversial nature and have been omitted.

Signal-to-Noise Ratio

So far as the writer knows, there is no method of readily computing the increase in signal-to-noise ratio as the Q of the tuned antenna system is increased, though it is generally appreciated that as the band width in a tuned circuit decreases, the noise passed through the tuned circuit will decrease. As there may be misunderstandings arising from the term "signal-to-noise" ratio which is sometimes applied to the noise generated in the tubes themselves, the writer wishes to point out that the noise which is being considered is man-made interference, atmospherics, etc., entering the set through the antenna system, not that generated in the set itself due to "shot" effect and other analogous conditions. In operating a preselector close to the point of oscillation with a very high effective Q , a marked decrease in noise was obtained. In fact, the effect was so pronounced that reception was greatly improved. To verify this effect by experimental data the following set-up was made: A regenerative preselector was connected to an all-wave receiver. The signal output lead from the preselector was shielded to the antenna of the receiver with a low-capacity shield. The receiver was completely shielded with no exposed parts whatsoever which could pick up signals. In fact, the lead carrying the signal from the preselector was shielded completely to the antenna coil. The preselector was also completely shielded. The 110-volt line which fed the preselector and receiver was filtered in two places. Every precaution was taken so that all noise or signal entering the system would be picked up on the antenna and not on the 110-volt leads or the set leads.

Some little experimentation was carried on to find a noise-making device which would have

sufficiently constant noise output so that it could be measured fairly accurately on a critically damped db meter which was connected to the output of the receiver. It was found that a small universal motor served the purpose admirably while electric razors and other apparatus tried out were considerably more erratic in their performance. The universal motor was placed underneath the receiving antenna in the yard with about a 60-foot a.c. line running to it. This a.c. line was also filtered. With the universal motor running and no antenna connected to the receiver, no pick-up was obtained. When the antenna change-over switch on the preselector connected the preselector ahead of the receiver, the exposed antenna binding post on the preselector picked up a slight amount of noise from the universal motor. However, it was found by shielding this binding post that no pick-up was obtained. Thus it was felt that all the noise and the signal entering the preselector and receiver combination would be through the antenna system.

To obtain a constant measurable signal a second short antenna, paralleling the regular antenna, was attached to an all-wave signal generator. The results obtained with this set-up are as follows:

Results obtained at 19 Mc. — The signal generator was set so that when the antenna throw-over switch of the preselector connected the antenna directly to the receiver (volume control advanced to maximum sensitivity) the output meter read -4 db. When the antenna throw-over switch was operated so that the preselector was connected ahead of the receiver, the signal strength increased to $+35$ db. The tube hiss is also increased to some degree. The signal generator was then disconnected and the universal motor in the yard started. The noise pick-up on the antenna and fed directly to the receiver was $+18$ db. The signal generator was then turned on. No trace of signal could be heard from the receiver itself and the db meter still read $+18$. The signal generator was turned off, and the antenna change-over switch operated to insert the preselector ahead of the receiver. The noise, with the set and the preselector tuned for maximum, was then 25 db. With the universal motor still running, the signal generator was turned on and with the preselector ahead of the set, the

(Continued on page 58)

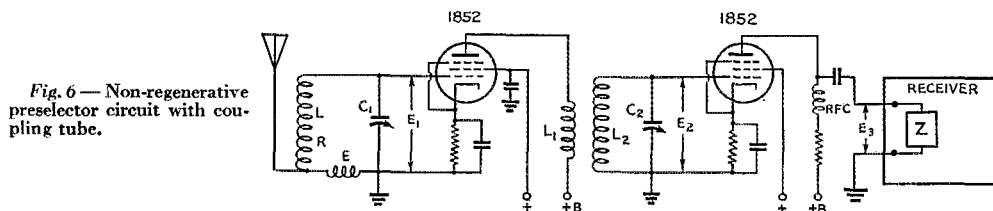
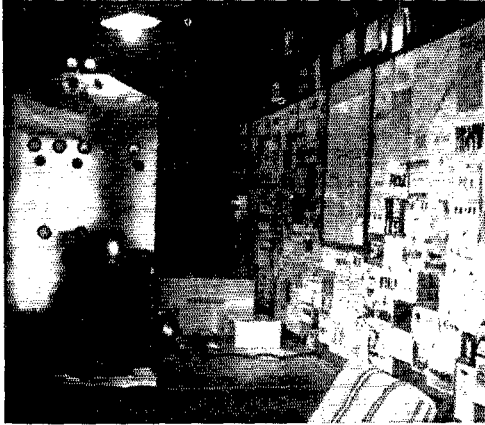

Fig. 6 — Non-regenerative preselector circuit with coupling tube.



HAM



SHACKS

← CO2LY, Havana, Cuba

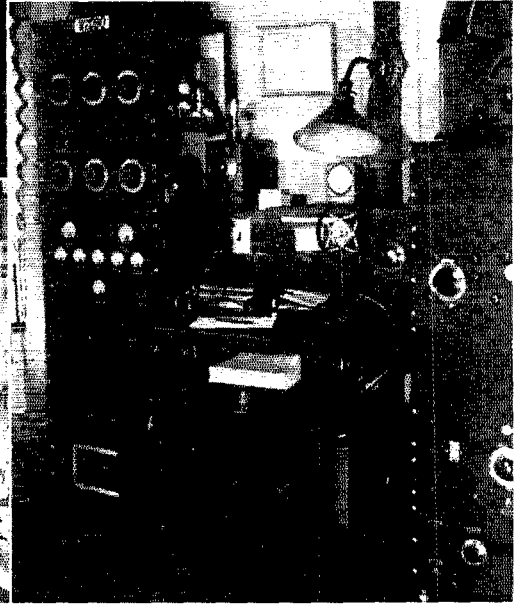

↑ PK1KS, Pangkalpinang, Sumatra
 ↖ CO2JJ, Havana, Cuba

↑ W2DBQ, Brooklyn, N. Y.
 ↖ VS6AO, Cape D'Aguilar, Hongkong



CO2LY

UP TO the time of the recent shut-down of ham radio in Cuba, Manuel Gonzalez of CO2LY in Havana was one of the outstanding characters on 14-Mc. 'phone. You were lucky to swap numbers with him during the last DX contest (he said he ran out of numbers), but you certainly can have a whale of a ragchew with the "screwball of the West Indies," as he calls himself. No moment spent with CO2LY is ever dull, especially if you are equipped for "push-to-talk." But you have to be prepared to do some fast thinking before you call him if you are to keep up with the constant fire of wit and humor which rolls off his tongue like water. Completely at ease at the mike, he's one ham who can take 'phone in natural stride free from forced or stilted effects. He doesn't know the meaning of "Hi," but you have no doubt about it when you have succeeded in hitting a vulnerable spot in his funny bone.

Since he refuses to talk shop over the air, a peek into his station should be of unusual interest. The main transmitter is the rack job to the left. It includes a single T-125 final modulated by Class-B 830's. A low-power rig on the table consists of an 807 modulated by Class-AB 6L6's and the receiver is an RME-69. The present antenna is a Johnson Q running east and west, although he has plans for a 2-element rotary.

Mr. Gonzalez is secretary to the vice-president of the Havana Electric Railway Company. Making his start in ham radio in 1937, he has since completed both WAC and WAS and has worked several good bits of DX with the "peanut-whistle."

Now that the ban is lifted, we expect that the flow of chatter which has been dammed up for the last few months will be greater than ever.

PK4KS

REMEMBER the daily dog-pile around 14,300 in the last DX contest? Each time the smoke cleared away, there at the bottom of the pile would be PK4KS bravely struggling to handle five numbers at once. For most of us, Sumatra was a new country as well as a contest multiplier.

The rig which was responsible for all the commotion is a three-stage affair with 6L6 Tri-tet oscillator, 801 buffer and a pair of T55's in push-pull in the final, operating at 225 watts input. When on 'phone, the final is modulated by a pair of Telefunken RV2400 tubes operating as Class-AB amplifiers. Both transmitter and 12-tube superhet receiver were built by Mr. Tan Koon San who owns and operates the station which is situated in Pangkalpinang. The antenna used was a half-wave dipole but a rotary 8JK is under construction.

PK4KS has been on the air only since January 1939, but in the intervening time has made WAC on both 'phone and c.w., has worked 75 countries

and needs only four states for WAS. Most of his work has been done on 14 Mc., but he occasionally chews the rag with W6's on 7 Mc. with an 8-watt rig.

His occupation is that of manager of a local talking-picture theater.

CO2JJ

CO2JJ is another well-known Cuban 'phone station. It is the station of Dr. Rene Espinosa, a dentist in Havana.

Starting up in December 1936 on 14-Mc. 'phone with 42 watts input to an 801 final, CO2JJ made WAS in the first year using only the one frequency of 14,120 kc. The present transmitter is built into a standard rack. The r.f. line-up consists of a 53 oscillator-doubler, a TZ40 buffer and T55 final running at 125 watts input. The final is modulated by Class-B 46's driven by two 57's and a Class-A 46. The receiver is the ACR-175.

The antenna is a vertical half-wave of copper tubing erected on the roof of the apartment in which CO2JJ is located. It is fed with Zepp feeders at the base.

With this modest equipment, CO2JJ has placed fourth among the 'phone stations outside U. S. A. in both of the last two DX contests.

W2DBQ

ONE OF the most consistently active hams in traffic handling and organization activities in the eastern part of the country is Dick Nebel, W2DBQ. He joined the ORS and AARS groups in 1931 and has been going strong ever since.

The transmitter consists of 59 crystal oscillator, 802 buffer, 210 driver and 242A final running at 200 watts input. Although he spends ninety per cent of his time on 3.5-Mc. c.w., the rig is capable of working all bands and is equipped for modulation with Class-B TZ20's for AARS tie-in and a few other skeds. The same single-wire and end-fed antenna has been in constant use for all work for the past several years. Receiver is the FBXA with preselector.

Dick is an R.M. and Chief Section Emergency Coördinator in the A.R.R.L. and Southern New York State Radio Aide in A.A.R.S., holding the call WLNB. Professionally he is engaged in the production of quartz crystals and associated equipment. Checking apparatus may be seen in the photograph.

In spite of the fact that he has been stricken with infantile paralysis since 1916, he's the spark plug in N.Y.C.-L.I. activities and gets around to ham gatherings in his Section.

VS6AO

IN THE lower right-hand corner we give you a peek at another of those DX stations whose operator has plenty of trouble on his hands when

(Continued on page 68)

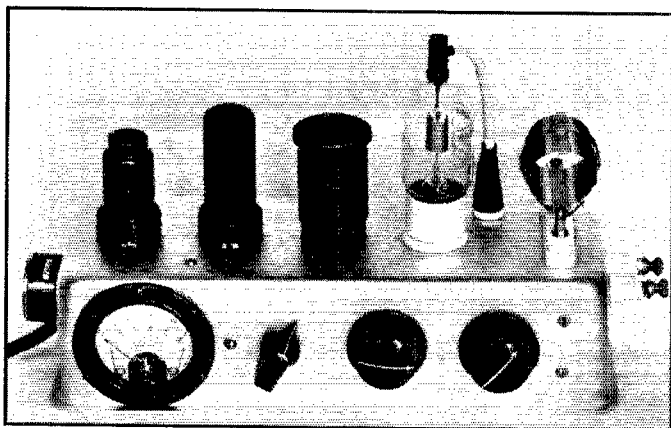

An interesting and effective outfit for the chap who hasn't room for a big transmitter, but wants a fair amount of power with multi-band operation.

Compactness, safety and simplicity of operation are outstanding features of this 75-watt transmitter. The chassis is a cake pan.

Compactness With Economy

A 75-watt Input Transmitter of "Pocket" Dimensions

BY ALLEN MONDERER,* W9VCX

THE transmitter described in this article is the result of a process of evolution and did not come from this ham's sitting down and designing a transmitter for a specific purpose. However, as the idea of an extremely small medium power transmitter grew, certain definite requirements and features became desirable or necessary. These were (1) the power input to the final plate should be between 50 and 75 watts, (2) the unit must take little physical space (the writer was still in school at that time and the rig was still being moved about), (3) it must be usable on the 10-, 20-, 40-, and 80-meter bands, and (4) modern safety requirements *must* be met.

The set originally was constructed on a cake pan obtained from the nearest hardware store. This method of construction has been recently described in *QST*.¹ The thin metal of cake pans did not prove strong enough for use in the permanent station transmitter, and something was missing in the appearance of such a unit. Subsequently the entire field of metallic kitchen utensils was investigated with a view of finding a suitable metal chassis. The problem was solved with a Mirro Aluminum Fruit Cake Pan. This is 3½ wide by 10½ long by 2¾ inches deep, and the walls are thick enough to support the parts without any bending.

* 1467 Fargo Avenue, Chicago, Ill.

¹ Gale M. Smith, "A Hurricane Emergency Transmitter and Power Supply," *QST*, July, 1939.

The Circuit

The oscillator is of the Pierce type, employing plate to grid feedback through the crystal. By loading the oscillator heavily and keeping the plate voltage low, the r.f. crystal current is in the neighborhood of 30 ma. Condenser C_3 keeps the d.c. plate potential off the crystal. This is in keeping with the safety requirements, since the crystal is above the chassis. The value of C_4 may seem large, but this helps to load up the oscillator more completely.

The buffer amplifier is a type 6V6 tube. The amount of oscillator output dictates the use of a beam tetrode in the next stage. A 6L6 was first used, but it delivered more power than was necessary to drive the final amplifier. The 6V6 gives ample output and only requires one-half as much heater current.

Coupling to the grid circuit of the final amplifier is through the untuned secondary coil L_3 , which is wound between the turns at the lower end of L_2 . This close coupling eliminates the need of tuning L_3 , and the correct grid drive is obtained by pruning the number of turns in L_3 . Bias for the final amplifier is obtained through R_5 and R_6 . Pins A and B are in the coil form (a 5-pin form is used) and are jumpered when straight-through operation is used in the final. If doubling (or even tripling) is wished, the jumper is left out and both resistors are then in series. Separate forms are used for each condition. The

jack *J* was included to allow grid modulation at a later date. It removes the bias resistors, and battery bias may be used in series with the modulator.

The final amplifier is a Gammatron HK-24. This tube was one of many tried in this position and won out through its ruggedness, ease of driving, power rating and small physical size. The plate tank circuit uses a split-stator condenser to obtain the voltage for neutralizing. The small physical space available for the tank condenser indicated one with small plate spacing. The d.c. plate potential is kept off this condenser by the use of shunt feed to the plate. This also keeps the tank coil at ground for d.c. — one of the safety features. The choke L_7 brings the coil and the hot sides of C_{12} to ground for d.c., but isolates the center-tap for r.f. If the center-tap of the coil were grounded directly, the balance of the split tank circuit might be destroyed and reneutralizing probably would be necessary with each change of coils. As it is, the neutralizing holds over all bands. Low voltage is obtainable, when tuning up, through switch Sw_2 . If the high voltage is applied before the final amplifier is loaded by the antenna, the tank condenser will arc over. The special mechanical features of this circuit will be described more fully later on.

Keying is accomplished by blocking the grid of the HK-24 with a high negative bias. For ease of operation and frequency stability, the crystal and its buffer stage are left running all during a transmission. If break-in is desired, a time delay circuit must be included to hold the oscillator and buffer on during keying. The bias for keying is supplied by the 1000-volt plate supply for the HK-24. A 40,000-ohm bleeder in the power supply is tapped at about +300 volts. The center-tap of the transformer supplying the filament current for the final amplifier is connected to this 300-volt tap. This gives the tube a negative bias, the grid return being connected to ground. To key, the 300 volts is simply shorted to ground, thus removing the blocking bias. The value of R_{11} is a compromise between a sufficient bleeder current

for good power supply regulation and a small additional load with key down. This system is free from any key clicks or thumps.

A single 10-ma. meter is used to meter the buffer plate, and the final amplifier plate and grid circuits. A two-pole, three-position selector switch connects the meter across the shunts R_7 , R_8 and R_9 . The shunts remain in the circuit at all times. The size of the shunts may be calculated from the formula

$$R_{\text{shunt}} = \frac{I_{\text{meter}} \times R_{\text{meter}}}{I_{\text{total}} - I_{\text{meter}}}$$

Construction

The general constructional details are shown in the two photographs of the unit. The crystal is at the left side. Along the top are the 6C5 oscillator tube, the 6V6 buffer, the buffer tank coil, the HK-24 final and the final tank. At the right end are the feed-through insulators for the r.f. output. Along the front panel are the meter, the switch for the meter, the buffer tuning and the final amplifier tuning. In back are the power cable, the final amplifier grid-circuit jack, and the high-low plate voltage switch.

As the below-chassis view shows, the component parts for the first two stages are closely spaced, and care must be taken in their placement. All power connections are made to the terminal strip across the back. This strip must be of a good quality to prevent breakdown from the high voltage.

The meter shunts were made by calculating the proper resistance and then selecting a wire of suitable length from the wire tables of the *A.R.R.L. Handbook*. Ordinary d.c.c. copper wire was used and the size was such that the length was about six feet. The shunts for the first two stages are wound on a small bakelite spool mounted beneath the meter. The high voltage shunt was wound on a half-watt resistor of any size above 100 ohms. This is kept from the low-voltage circuits to prevent breakdown. The switch is a standard Yaxley selector switch of the non-shorting type. Any other switch may be used if it has good insulation. The meter *must* have a

◆ Not much wasted space under the chassis. A hot-bottom view of the transmitter, showing the wiring. ◆

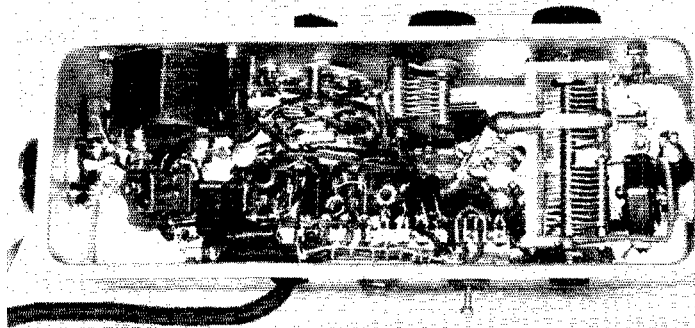

bakelite zero-set pin to keep the high voltage from appearing on the exposed portion of the transmitter.

The wiring and construction of the first two stages is quite conventional and follows usual practice. The novel features of this transmitter occur mainly in the final amplifier. The shields of the metal tubes are grounded.

The final tank coils are the National A-R16 series. Their catalog indicates that these will tune with a 30- μ fd. condenser, but inquiry at the factory disclosed that this is the capacity at

which they hit the band. Consequently a larger condenser is necessary. The only split-stator condenser made in small enough physical size for this transmitter is the Cardwell Dual "Trim-Air." Their regular stock did not include a condenser of sufficient capacity with the required plate spacing (0.030") so a special one was ordered. This follows under the standard numbering as type ER-75-AD. The rear shaft of the condenser was not cut off, but was left protruding through the rear panel, thus providing an extra point of support. Since the front bearing was

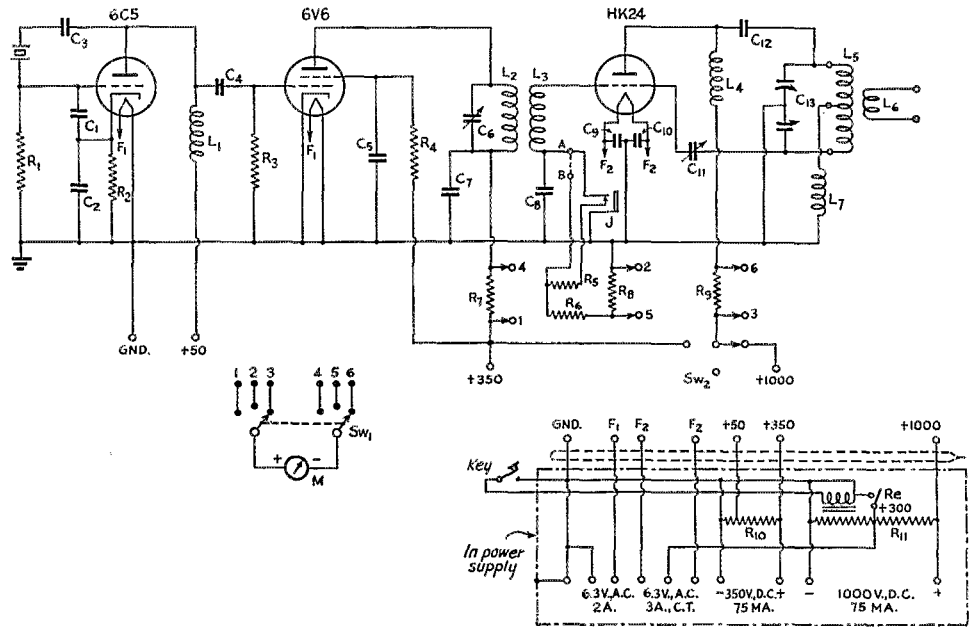

Fig. 1 — Circuit diagram of the compact 75-watt transmitter.

- C₁ — 50- μ fd. postage-stamp mica, 200-volt.
- C₂ — 0.006- μ fd. postage-stamp mica, 200-volt.
- C₃ — 0.006- μ fd. postage-stamp mica, 200-volt.
- C₄ — 0.001- μ fd. postage-stamp mica, 200-volt.
- C₅ — 0.006- μ fd. postage-stamp mica, 500-volt.
- C₆ — 100- μ fd. midget variable (Cardwell ZU-100-AS).
- C₇ — 0.006- μ fd. postage-stamp mica, 500-volt.
- C₈ — 0.006- μ fd. postage-stamp mica, 500-volt.
- C₉ — 0.006- μ fd. postage-stamp mica, 500-volt.
- C₁₀ — 0.002- μ fd. postage-stamp mica, 500-volt.
- C₁₁ — Neutralizing condenser (National NC-600).
- C₁₂ — 0.002- μ fd. mica, 1500-volt working.
- C₁₃ — 75- μ fd. dual variable, 0.030" spacing (Cardwell ER-75-AD).
- R₁ — 25,000 ohms, 1/2-watt (BT-1/2).
- R₂ — 1000 ohms, 1/2-watt (BT-1/2).
- R₃ — 100,000 ohms, 1/2-watt (BT-1/2).
- R₄ — 10,000 ohms, 2-watt (BT-2).
- R₅ — 5000 ohms, 5-watt (Brown Devil).
- R₆ — 5000 ohms, 5-watt (Brown Devil).
- R₇ — Meter shunt, 100 ma. (see text).
- R₈ — Meter shunt, 50 ma. (see text).
- R₉ — Meter shunt, 150 ma. (see text).
- R₁₀ — 20,000 ohms, 25-watt, voltage divider (Divid-ohm).
- R₁₁ — 40,000 ohms, 50-watt, voltage divider (Divid-ohm).
- L₁ — 2 1/2-mh. r.f. choke.

L ₂ , L ₃ —Buffer Band	Final Band	L ₂ Turns	L ₃ Turns
3.5 Mc.	3.5 Mc.	36 turns, No. 24 enam.	18 turns, No. 28 d.s.c.
7 Mc.	7 Mc.	18 turns, No. 18 enam.	10 turns, No. 28 d.s.c.
7 Mc.	14 Mc.	18 turns, No. 18 enam.	13 turns, No. 28 d.s.c.
14 Mc.	14 Mc.	12 turns, No. 18 enam.	9 turns, No. 28 d.s.c.
14 Mc.	28 Mc.	12 turns, No. 18 enam.	12 turns, No. 28 d.s.c.

L₃ interwound between L₂ (see text).

- L₄ — 21/2-mh. r.f. choke.
- L₅, L₆ — Amplifier tank coil, National AR-16 series, center link.
- L₇ — 2 1/2-mh. r.f. choke.
- J₁ — Closed-circuit midget jack.
- M — 10-ma. milliammeter, 2" diameter.
- Re — Keying relay, 6.3-volt a.c.
- Sw₁ — 2-pole, 3-throw selector switch.
- Sw₂ — Single-pole, 3-throw toggle switch, high-voltage type.

grounded, the rear bearing was supported on an insulated bushing to prevent closed paths in the tank circuit and thus eliminate eddy-current losses. The small grid-leak shaped device across the tuning condenser is the neutralizing condenser. The plate blocking condenser is at the right, with the plate feed choke at the left. The choke between the output feed-through insulators is the one in the center tap of the tank coil.

The only places where high voltages appear above the chassis are at the buffer tank coil and the plate lead of the final tube. The buffer coil is wound on a $1\frac{1}{4}$ inch diameter form with enameled wire. A heavy application of coil dope insulates this winding. The secondary winding must be of double-silk-covered wire and is applied after the primary is doped. The number of secondary turns is adjusted until the desired grid current flows with full load on the final.

The plate lead for the HK-24 comes through the chassis on a ceramic feed-through insulator. The flexible lead is covered with small ceramic beads, and the connection to the insulator is covered with a rubber sleeve such as is used on test clips. There is no insulated plate cap on the market for use on tubes with a pin-type terminal such as the Gammatron and Eimac series. Such an item is necessary if our equipment is not going to have exposed high voltages. In this instance, the problem was solved by making a cap from a pin-tip jack in a molded tube. The threads on the tube were turned down and the top end sealed. A hole through the side admits the beaded lead.

The keying circuit is in the power supply, which is not shown. Any supply that will furnish 350 volts at 75 ma. and 1000 volts at 75 ma. may be used. The 350-volt source cannot be tapped from the 1000-volt one, since the bleeder is used for keying. The supply in use has three 82's in a bridge rectifier, which furnishes two sets of voltages (see *A.R.R.L. Handbook*). Separate filament transformers are used for the low power and the final stages. When the key is up the final filaments are above ground by 300 volts. If the metal tubes are heated from the same winding, the heaters are 300 volts above their cathodes and the internal insulation may break down.

Operation

The tuning and operation of this transmitter is quite simple. The plate voltage of the final amplifier is removed by placing the switch Sw_2 in the open position. The neon bulb used for neutralizing cannot be larger than $\frac{1}{4}$ watt for perfect neutralizing. The neutralizing condenser is adjusted with the eraser tip of a pencil, and is then locked with the set-nut on the shaft. It will hold neutralization on all bands.

The plate current in the buffer stage is not important, and it is read only to indicate resonance. The grid current in the final should be about 20 ma. and the plate current 75 ma. when operating

under load. The high voltage should not be applied to the plate without a load.

The power supply and antenna coupling unit have not been described, since each operator has his own ideas on these matters. At W9VCX the antenna is tuned by a "pi" network, fed by a link from L_6 .

The power input to the transmitter is 75 watts, which is large considering the physical size of the rig. Higher plate voltages than 1000 are not recommended, and care must be taken in wiring to prevent breakdown at this voltage in the small chassis.

~~Strays~~

"Since left-handed bugs are somewhat higher in price and second-hand ones hard to obtain, it is useful for the 'southpaw' to know that the standard Vibroplex may be reversed by disassembling, turning the base over and reassembling." — *W9EKW*.

— . . . —

"When the type 42 in my receiver burned out suddenly the other night, and I had no spare, I substituted a 6D6 in the socket. It seemed to work almost as well as the 42 and was a most satisfactory substitute for such an emergency. The suppressor in the 6D6 assumes the role of control grid." — *Neal Corathers, Keyser, W. Va.*

— . . . —

W8AQY says that it will pay occasionally to swab the switch contacts in a band-switching receiver with a toothpick and cotton soaked in carbon-tetrachloride. This removes the accumulation of dust which is frequently responsible for noise in receivers of this type.

— . . . —

Faith Rogers, who writes a newspaper column of personal advice, has the following sentence in one of her letters to a young lady:

"Ask him something about radio; there are so many amateur operators these days."

— . . . —

For the reassurance of the low-power beginners who receive discouraging advice to the effect that present-day operation requires high-power gear, W4FRU of Memphis, Tenn., sends this note: ". . . I worked W5EWK of Tom Bean, Texas, who was using as his xmtr a '19 tube in a Hartley oscillator with 3 watts input. His report in Memphis was RST 589. W5EWK's antenna is a 66-foot grounded (Marconi), and his receiver is a 2-tube outfit using '30's.'"

— . . . —

Recovering from a case of pneumonia, W2GFW recently spent eight weeks in a hospital. A nurse, noticing him reading *QST*, remarked that there was a young fellow in another room reading the same "queer" magazine. The "other fellow" turned out to be W2LIQ, also suffering from pneumonia.



ON THE ULTRA HIGHS



CONDUCTED BY E. P. TILTON,* W1HDO

Who said "5" is a summer band? A fortunate combination of conditions during the intense activity of the second U.H.F. Relay, November 4th and 5th, offered convincing proof that both skip and local-range DX can be worked in the fall and winter months. Then, as if to show that the results earlier in the month were no freak, late November offered several more nights of good local-range conditions, in the Northeastern States at least.

If the weather had been made to order it could not have afforded a better example of the relation between atmospheric conditions and u.h.f. bending than existed over W1, W2, and part of W3 during Saturday evening, November 4th. Weather maps for Friday and Saturday tell the story, showing a storm area heading toward New England from the south and west. An unusually warm noontime sun paved the way for the inevitable temperature inversion when the cooling of late afternoon set in. By 4 p.m., November 4th, the local range at Wilbraham had stretched out to 200 miles or more, and all signals beyond actual line of sight were up to the summer average. This condition prevailed until shortly before noon on Sunday, when heavy rains sweeping in from the southwest washed out the favorable state of affairs.

Many operators were quick to take advantage of this break, with W1LLL, W1HDF, W1INF, and others in Western New England working W1HXP, W1DEI, and several others in the Boston area; no mean accomplishment when it is considered that elevations of 1200 feet or more intervene at several points, with the stations at each end at 200 feet or less above sea level. The extended local range worked to the advantage of the fellows in the New York area also, with W2MO, W2IDV, W2AMJ, and W3HOH knocking off several contacts each for 5 points (over 100 miles). It is interesting to note that work to the south and west from this area was not so successful, precipitation having already occurred in the vicinity of Washington, D. C., and over Ohio.

As to contest results, it is too early to give complete data on the standings, but it appears certain that the winner was, again, W3AC/3. Operating at High Point, N. J., the scene of his victory in the first u.h.f. contest, Goyne again turned in a total nearly twice that of his nearest competitor. Massed closely together in a scramble for second place were W2MO, W3HOH, W1KIJ, and your conductor. That the relay idea is really taking hold is shown by the tremendous increase

in participation and the greater distances covered by many of the messages. Complete details next month.

The high spot of the contest, for many, came at 4:15 p.m., Sunday; when, with activity beginning to lag, W9ZHB set the band on fire by breaking through for the first W9-W1 QSO in many a day. He was quickly followed by W9's CBJ, Washburn; ARN, Bartonville; ROQ, and LLC of Pekin; RGH, Peoria (all of central and southern Illinois); and HWF of St. Louis, Mo. While this was going on CLH, Elgin; VHG, Glenview; ZFH, Oak Park (all Illinois); and GGH, Kenosha, Wis., were working into New York, New Jersey, and Pennsylvania. All the latter group are considerably north of those reported in New England. W9ZHB was the only station reported in both areas.

Lines drawn between points where contact was established form a definite "X" near the Pennsylvania-Ohio border, indicating that a fairly small sporadic E "cloud" over this vicinity accounted for all the fun. This is borne out by the experience of W3AC/3 (northwest corner of N. J.), who, upon hearing the 1's and 2's calling 9's, turned his ice-laden beam, only to be unable to hear a trace of skip DX! In between, also, was W8PK, E. Bloomfield, N. Y., who found the band a complete washout, though short skip from W1 and W2 was very strong on "10."

A minor prelude to the skip "matinée" occurred between 10 and 11:30 a.m. This was of such limited nature that it went unnoticed by the majority of the gang. At 10:17 W8LKD, Cuyahoga Falls, Ohio, worked W1LSN, Exeter, N. H., his first W1; and W1EKT heard W9ISX, Clarendon Hills, Ill., at 11:05. After the main show described above had faded out, things opened up again at 6:25 p.m. when W9ZJB, Kansas City, Mo., was heard weakly on c.w. by W1LLL and your conductor, as he was working W9VWU. We can imagine Vince's consternation when he learned that the band was open during his one lone contest QSO!

All the DX worked and heard was apparently the result of ionization over a limited area, and it's a safe bet that, had November 5th been just any Sunday instead of the second day of the U.H.F. Relay, the whole business would have gone unnoticed. Those of us who are regularly active on "5" know of countless instances when conditions seem ripe for DX yet nothing is heard, simply because no activity is going on in the areas affected. Such a situation confronted W1KTF on November 18th, at 9:30 a.m., when Dave heard

*329 Central St., Springfield, Mass.



HK-54's, an Extended Double Zepp, and the famous Lester Converter work wonders under the guidance of Frank Lester, W2AMJ. The combination resolves in an outstanding W2.

the harmonic of a W9 working another on 28 Mc. The characteristic "swish" which so often accompanies DX was apparent but, though he CQ'd long and loud, Dave had no luck on "5." Similarly, W9ZJB and W9VWU heard a harmonic of W6CAH at 4:35 P.M., November 12th, without hearing any other sigs on "5." This is the only California sig ever heard by Vince on 56 Mc. The 1940 Marathon, announced elsewhere, should do much to stimulate consistent local activity, making it more likely that fellows will be active throughout the country when conditions break for skip DX.

HERE AND THERE:

You fellows who have a hard time drumming up local activity should have a listen to the meetings of the 56-Mc. "Minute-Men" any Sunday at 10 A.M. Under the capable control of W1EHT of Stoneham, a snappy roundtable is conducted, following which the meeting is opened to anyone within range who may wish to join in. Another example of the beneficial effects of 56-Mc. organization is the success of "The Horsetraders." Originally a group of Connecticut Valley 5-meter men, "The Horsetraders" grew out of the jocular rag-chews of W1MY, W1FLQ, W1QP, W1JLK, and others, and has, since its inception in 1935, grown to include 135 members in W1, 2, 3, 8, and 9, its scope extending from Boston to Kansas City, Mo. All good "Horsetraders" are on the air at 7:30 each Tuesday night.

W2MO, Livingston, N. J., with up to 700 watts to a pair of special FT-114-A's feeding an 8-element rotary atop a 90-foot tower, continues as one of the outstanding u.h.f. stations in the East. Earl keeps regular skeds with W3DBC, Washington, D. C. (200 miles) and W1HDQ (120 miles). And it's not all transmitter at W2MO — Earl worked

W3GMZ in Washington recently, when the latter 'was' using a 6L6 doubler-final. There's a receiver at 2MO, too! It's a Lester Converter ahead of an HQ-120. Which brings up Earl's long-time rival for top honors in W2, Frank Lester, W2AMJ, Bergenfield, N. J. That guy's *always* on! It's been said of Frank by W3AIR: "When they nail down the lid on him, he'll be calling 'CQ-Five!'" Frank's sponsorship of the Extended Double Zepp* has caused this very efficient sky-wire to be practically "standard equipment" among the u.h.f. fraternity who haven't the space or facilities for a high-gain rotary. With the aid of the "E.D.Z.," Frank's HK-54's and Converter (of course) certainly do a fine job. W2AMJ and W2MO are found regularly on 56,864 and 56,630 respectively. There are times when "5" would be plenty lonely without these two old-timers.

Big noise in the Nation's Capital is made these days by W3DBC, with 600 watts or more to a pair of 100TH's and a "Lazy-H." Blair uses a Lester Converter (it's a habit) ahead of his HRO to pull in plenty of stuff over 100 miles distant. On November 21st, at 10:30 P.M., Blair's c.w. was heard at Willbraham for a brief interval. This is a hop of about 300 miles which is not too bad for late November! Other stations active around Washington recently include W3's EEN, AWS, and IIS (ex-W2KKS).

High power, while undoubtedly an asset, is not necessary for real performance on "5." Bob Elmer, W3BZJ (56,412), does all right with 125 watts input to a pair of T-40's, having 27 states in 8 call areas to his credit. Under favorable local-range conditions Bob is frequently heard in the Boston area, some 250 miles away. W3BZJ is on nightly between 10 and 11 P.M., and usually on the job Sunday mornings. Bob's receiver is a new RME HF-10. Reliable contact is maintained with 3BKB, York, Pa. (100 miles), 3FQS, Reading, Pa., 3CUD, 3HOH, 2AMJ, 2MO, and many others.

A recent letter from W4EDD states that skeds are kept regularly with W4DRZ at 8:45 A.M. and 5:50 P.M., with few stations being heard otherwise. Both Bud and Robbie expect to give 2½ a try early in 1940. Watch for W4DX on 112 Mc. It appears that we may hear some other W4's when "5" opens up for that area again. From SCM reports we learn that 4DLO has a beam on a 95-foot pole, and that 4FOX and 4GAM are active.

From Dallas, W5AJG reports "all quiet on five." No sigs were heard during either u.h.f. contest. A number of W5's are reported a-building for 2½, so Leroy looks forward to a good showing in the Marathon. 5AJG is not exactly out of the running on 56 Mc. either, having tied W3BZJ at 27 states and 8 call areas, needing the inevitable W7.

W6QLZ, Phoenix, Ariz., continues to be one of the most enthusiastic u.h.f. men in W6. Clyde maintains skeds regularly with 6OVK of Tucson, but as yet they have been unable to break down the 140 miles of "rough old desert" in between. We hope the winters are not too severe in Phoenix, for it's sure to be cold at QLZ, with all those holes in the wall where the feeders come into the shack. We hesitate to state what Clyde uses for antennas — the dope would be obsolete before we get to press! With fairly frequent reception of West Coast 10-meter sigs up to 500 miles away, Clyde has hope of doing business on "5" also. The 10-meter sigs frequently have "rain-barrel" quality and are apparently bent into Phoenix by lower-atmospheric refraction
(Continued on page 86)

* See article by Arthur Lynch in November '39 QST.

Antennas grow on trees in Phoenix, Ariz. DX passing near Mission Ranch has little chance of escaping the sky-wires of Clyde Criswell, W6QLZ.

January 1940



Improved Pi-Section Antenna Coupler

Simple Alterations for Wider Impedance Range and Better Harmonic Reduction

BY R. B. JEFFREY,* W8GDC

ALTHOUGH the pi-section antenna-coupling network was introduced some years ago in amateur work as a cure-all for antenna-coupling troubles, those who have had occasion to use the system over a period of time under a wide range of circumstances have doubtless encountered cases where the system refused to do much of anything. Particularly bothersome are the cases where the feeders or antenna happen to be exact multiples of one-quarter wavelength long. When the feeders are exact odd multiples of one-quarter wave in length, the line impedance is very low and requires that the filter output condenser be of an impractically large value. Conversely, when feeding lines exact even multiples of one-quarter wave in length, the line impedance is so high that proper matching requires a value of filter output capacity too low to obtain in practice. In both cases, it may be possible after considerable adjusting to find some combination of inductance and capacity which will load the output amplifier, but the output condenser is a total loss so far as a convenient means of adjusting the power input is concerned. Its adjustment frequently has no effect whatsoever. Invariably under these circumstances, tight coupling between the final tank circuit and the filter must be used to obtain satisfactory loading and the taps on the tank coil must be spread out towards the ends of the tank coil. It has been demonstrated¹ that tight coupling is to be avoided if harmonic output is to be minimized.

To overcome these drawbacks, several modifications of the straight pi-section filter were tried. In an early version, tight coupling with feeders of odd quarter-wavelength multiples was avoided by shifting the inductances and capacities to form a simple series tuning system with the inductances as feeder loading coils. This arrangement worked out very well except that the loading-control effect of the output condenser was lost. The success with this system, however, finally led to the arrangements shown in the diagrams of Fig. 1. In these circuits additional inductance sections have been added in the output sides of the filters. The most simple explanation of the function of these additional inductances is that they work as loading coils to bring the antenna-system ter-

minal impedance to a value which can be readily matched by the usual filter without resorting to excessively tight coupling. With this arrangement, the output condenser has control of the loading under all conditions. It is possible to work a 30-foot antenna at 1.7 Mc. or a 200-foot antenna at 56 Mc. with equal ease. Sufficient variations in values may be obtained with the one set of coils and condensers to cover any set of conditions which may be encountered over this range of frequencies. Such an arrangement is especially advantageous in portable and emergency work where almost any old piece of wire may have to serve as the antenna.

An equally important feature of the operation of the system is that loose inductive coupling is sufficient to give proper loading under all conditions and, therefore, harmonics in the output are greatly reduced. No critical adjustments are required to obtain satisfactory harmonic reduction.

Referring to Fig. 1-A, L_1 may be approximately 75 turns close-wound on a 3-inch diameter form with five or six taps equally spaced. L_2 is simply an extension of L_1 and is used to avoid having too many shorted turns on an active coil. It

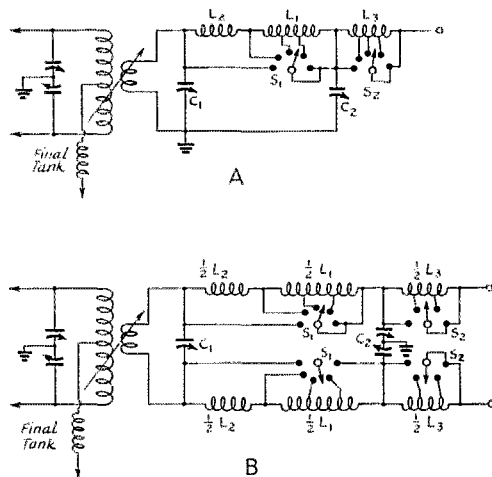

Fig. 1—Improved antenna network with wider working range. A—For single-wire feeder or end-fed antenna. B—For two-wire lines or center-fed antenna. Values are given in the text. C_2 should have a capacity of 200 μfd . per section.

* 2255 N. 4th St., Columbus, Ohio.

¹ Woodward, "About This Harmonic Radiation Problem," *QST*, Feb. 1937.

In spite of certain shortcomings, the pi-section network still remains one of the most popular types of antenna coupler. W8GDC now tells us how, with a few simple alterations, to avoid these weaknesses. The resulting coupler is truly universal and may be operated with loose inductive coupling, greatly reducing harmonic troubles.

should have about ten turns close-wound on a one-inch diameter form; it is used only when working at the higher frequencies. If high-frequency operation is not desired, this inductance may be omitted. L_3 has approximately 30 turns, close wound on a 3-inch diameter form. C_1 should have a capacity of 500 μfd . Receiving spacing is satisfactory with powers up to 200 watts or more. C_2 should have a capacity of 100 to 200 μfd , and plate spacing about twice that of C_1 . The higher capacity gives a greater range of control of loading. The three coils should be mounted so that there is no appreciable coupling between them. The coupling between the final tank coil and the filter should be very loose. Some form of variable link coupling is strongly recommended. We use Johnson variable-link coils and the angle between the axes of the link and tank coils is never less than 80 degrees.

The tuning procedure to be followed varies somewhat from that recommended for the usual arrangement of pi-section coupler. With the coupling link set near minimum, the final-amplifier tank circuit is tuned to resonance. L_3 should be short-circuited and C_2 set near maximum capacity. Then, trying various positions of S_1 , C_1 should be varied until the plate current shows a sharp increase and then tuned to plate-current peak. Rechecking resonance in the amplifier tank circuit should show little change in the resonance point. If appreciable retuning is necessary, the coupling to the tank is too tight and should be reduced. There should be very little interlocking between C_1 and the final tank condenser. If the resulting plate-current value is not the correct operating value, C_2 should now be adjusted and the tuning process repeated. A new value of plate current should result. In most cases a decrease in capacity of C_2 will result in a higher value of plate current and, *vice-versa*, an increase in capacity will reduce loading. In some cases, however, the effect of C_2 will be reversed. In any event, varying C_2 should not greatly affect the setting of C_1 . Now, if the highest obtainable value of plate current is less than the desired operating value, or if the antenna refuses to take power readily, set S_2 to include the first part of L_3 in the circuit and repeat the whole tuning process. A new value of plate current should result which will be larger than before. If it is still impossible to load the

final amplifier properly, increase the setting of S_2 until the desired operating plate current is obtained. At all times, the coupling between the final tank and the filter should be loose.

The arrangement described has been used to couple the transmitter to a single wire approximately 150 feet long on 160, 75, 20 and 10 meters. Several other antennas have been tried with equal success. It is possible to vary the loading from practically zero to maximum plate current by adjustment of C_2 and the tap switch.

Fig. 1-B shows the arrangement for center-fed antennas or two-wire lines. The coils should each have half the number of turns specified for corresponding coils in the single-wire circuit of A. In adjusting inductances, corresponding coils in each side should be adjusted simultaneously, maintaining an equal number of turns in each.

SWITCH TO SAFETY!



W2GP SENDS us a copy of Underwriters' Laboratories special report of an investigation on electrical shock as it pertains to the "electric fence." Although not about radio, much of its summary of known data has direct application to our work.

It is, of course, the current flow through the body which does most of the damage in electrical accidents. Currents as low as 49.2 milliamperes have been fatal, and there seems to be ample medical experience to show that 100 ma. maintained for more than one second is extremely likely to be fatal. Body resistance from hand to hand (our chief danger) averages around 3500 ohms, and with moist hands and good contact may be less than 1000 ohms. Of course we know that 3000-volt supplies are lethal, even before we calculate that they might cause 3 amperes to flow through the body; but we must here observe that a 300-volt supply is almost equally certain to cause death, even at average contact resistance, if the contact lasts much over a second. We have unhappily already had that proved to us in the unfortunate death of W9VYU.

What, then, are the chances of our not maintaining the contact that long? Not very good. High currents can be endured for only a very few ten-thousandths of a second without death. Moreover, the Underwriters' Laboratories ran tests to determine the maximum current that an individual could withstand for a short time and still have voluntary control of his muscles—such that he could drop an electrode or pull away from a contact. The maximum current that any individual could withstand was 10 ma., the minimum

(Continued on page 63)

Personality Over the Air

How the Ham Stacks Up in a Poll

BY E. LOWELL KELLY,* W9EWL

AMATEUR radio, as every ham knows, makes possible a unique type of acquaintanceship or even friendship. How many times have you signed "SK" or "off and clear" and then murmured to yourself, "I like that chap," or, "He's one whose CQ I will never answer again"? Accurately or not, there is a definite tendency for an operator to form certain judgments concerning the other fellow's personality, even during the first contact. With successive contacts, these first impressions are strengthened or modified until one comes to feel that he really "knows" the fellow at the other end as a personal friend.

Because of my professional interest in people, I found it fascinating to meet personally other hams with whom I first became acquainted by amateur radio. As everyone who has had similar experience will realize, many of one's previous impressions are substantiated by the personal meeting, but in other respects the individual may prove to be quite a surprise. Often I find a chap to be just as I had imagined him to be, but not always. In a few cases the contrast between my

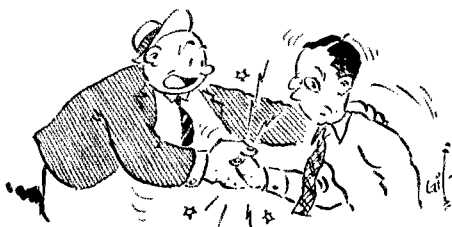

"OFTEN I FIND A CHAP TO BE JUST AS I HAD IMAGINED HIM TO BE, BUT NOT ALWAYS"

concept of the individual and his flesh and blood personality has proven so great that I could scarcely believe I was meeting the person with whom I had talked on twenty-meter 'phone.

Nevertheless, we continue to be impressed by the other fellow's voice, his grammar, his habits of speech, or, in the case of c.w., by the style of his fist, his long or short CQ's, his method of making abbreviations and many other cues. After pondering over this situation for some time, the writer decided to conduct an investigation¹ to determine which personality traits could be most

* Department of Psychology, Purdue University, Lafayette, Indiana.

¹ At the time this investigation was made, the writer was located at Connecticut State College and held the call W1KCK.

accurately judged over the air and which did not seem to be revealed in QSO's.

For practical purposes personality may be defined as the sum total of the characteristics possessed by an individual at any given time, characteristics which make him unique and enable us to recognize him as an individual. Although many tests for personality traits have been developed within the last twenty-five years, still one of the most accurate means of evaluating a given personality is that of having a number of the individual's personal acquaintances rate him on a personality rating scale. Two acquaintances will not necessarily agree concerning the relative amount of any trait possessed by an individual, but it has been found that the pooled judgment of several ratings of an individual yields a relatively stable average which does not shift markedly if a second group of acquaintances is asked to rate the same person.

A commonly used rating scale is the graphic type on which acquaintances are asked to place a check mark on a scale line indicating where, in their estimation, the individual being rated falls among a distribution of people in general. In connection with another research project, the writer had developed such a scale covering thirty-six different personality traits, thus providing a relatively complete picture of a given personality. This scale seemed to be ideally designed for the job at hand — that of comparing a given individual's personality as judged by his personal acquaintances with his personality as judged by amateur contacts. It was necessary only to secure the cooperation of amateurs and to collect such ratings from personal friends and from ham friends whom they had never met personally.

Fifty twenty-meter 'phone operators scattered over the United States were contacted by the writer and the purpose of the study explained to them. After he agreed to cooperate, each of the fifty operators was sent eleven copies of the thirty-six-trait personality rating scale. Each was instructed to: (1) send five of the scales to other amateurs with whom he had talked a number of times but whom he had never met personally; (2) give five of the scales to personal acquaintances; and, (3) rate himself on the eleventh blank. A mimeographed sheet giving instructions to the raters accompanied each scale, together with a stamped envelope and instructions to return to the writer's office for evaluation.

Although fifty operators originally agreed to

If you have ever wondered what the fellow on the other end of a QSO was like, if you have ever speculated on the personality and traits of other amateurs known to you only over the air, this article is meant for you. The author, by vocation a professor of psychology and by avocation a ham, felt the same wonder. He decided to make a study of amateur reactions to personality and apply predetermined ratings to see what the answer would be. The results here presented are probably to be followed by a more extensive survey. If you receive one of these questionnaires, don't discard it; cooperate with an effort that is worth-while and without ulterior motive.

coöperate, considerable difficulty was experienced in securing enough returns to permit a statistical analysis of the data. It seems that many of the recipients of these scales were inclined to treat them much as they do QSL's, i.e., lay them aside with the best of intentions! Finally, however, at least two amateur and two personal ratings, as well as a self-rating were returned for twenty-seven of the original fifty operators. The writer wishes to express his appreciation both to these amateurs and to their friends for their coöperation in making this study possible.

For these twenty-seven people, then, there was available a self-rating, the average of from two to five personal friends' ratings and the average of from two to five amateur ratings for each of the thirty-six traits. As has been pointed out above, personal ratings obtained from one set of acquaintances tend to agree with ratings obtained from another set of acquaintances. The relationship between the amateur and the personal ratings showed much lower correlations, indicating in general a lack of agreement between the personal judgments of amateur acquaintances and those of personal friends. This is, of course, a general statement and the closeness of agreement varies considerably according to the trait being judged. For instance, if we assume that the average rating of personal acquaintances constitute what the individual really is, we find that over-the-air judgments are most accurate with regard to ratings of a person's usual disposition, that is, whether he is pessimistic or optimistic, ratings on quietness or boisterousness (quite obvious in many 'phone QSO's!), ratings of pep, or sociability, and, surprising as it may seem, ratings of how religious an individual is. In contrast to these relatively accurate judgments on the part of amateur acquaintances, we find over-the-air judgments show no agreement with ratings of personal acquaintances for these traits: sense of humor, coöperativeness, tolerance, sincerity, popularity, and breadth of interest.

Listed above are the five most accurately judged traits and the five least accurately judged traits. Judgments with respect to the other twenty-six were of somewhat better than chance accuracy, but by and large relatively inaccurate. The question might very well be asked as to whether or not the judgments of personal acquaintances constitutes a satisfactory criterion of the person's

personality. While philosophically it is possible to hypothesize a person's real self as being something entirely different from the impression he makes on his associates, it is nevertheless true that his success or failure is largely dependent upon what psychologists call the "stimulus value of his personality," or the impression he makes on his acquaintances. All that we have done here is determine whether this impression is the same whether for personal, face-to-face acquaintances or for impressions made over the air.

It is possible that the lack of agreement between over-the-air judgments and judgments of personal acquaintances may result from the tendency of an operator to assume a different role when he sits down at the operating table than that which he plays in everyday life. In other words, it is not inconceivable that an amateur's "microphone personality" is really different from that he reveals to personal acquaintances. All of us tend to assume different roles according to the situation in which we find ourselves. The writer, for instance, is a very different person when lecturing to his classes, operating W9EWL, or attending a formal tea!

Another source of possible error in the judgments which we make of acquaintances, both personal and over the air, is the tendency to assume that, because an individual happens to be engaged in a certain occupation or be a member of a certain religious or political group, therefore has the other characteristics which we tend to associate with a given role. For instance, if during your first

(Continued on page 56)

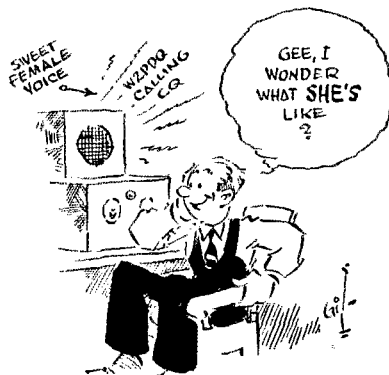

Reactance Calculations With the Lightning Calculator

Extending the Usefulness of the Type A Calculator

BY ROBERT R. BUSS*

THE A.R.R.L. Lightning Calculator is an excellent slide rule for the calculation of coil inductances and resonant frequencies of coil-condenser combinations, and is also useful for converting frequency to wavelength. However, the writer has often wished to know the reactance of a known inductance or capacitance at a given frequency, or the amount of inductance or capacity required to have a known reactance at a given frequency. Since the Lightning Calculator is essentially a slide rule, reactance calculations can be made easily by using the wavelength scale, the frequency scale, and the turns-per-inch scale. For purposes of these calculations, the wavelength scale and the turns-per-inch scale are used only as numbered scales, since the fact that they are labeled wavelength and turns-per-inch does not prevent their being used for other purposes.

Inductive Reactance

Set the culluloid indicator at No. 17 double-cotton-covered and, using the numbers on the wavelength scale to represent micro-henrys, set the value of inductance under the hairline. Notice that the inductance scales are not used. Then move the indicator so that the hairline is over the desired frequency. Then using the numbers on the turns-per-inch scale, under the hairline of the indicator will be found a number corresponding to 1/100 of the inductive reactance of the coil, that is, the reactance of the coil in ohms is 100 times the reading on the turns-per-inch scale.

Example: What is the reactance of 125 microhenrys at a frequency of 2000 kilocycles?

Solution: Set the indicator at No. 17 d.c.c. and using the numbers on the wavelength scale to represent microhenrys set 125 under the hairline (125 μ h). Now move the indicator to 2000 kc. giving 15.7 on the turns-per-inch scale. The reactance is then 100 times 15.7 or 1570 ohms of inductive reactance.

The reverse procedure is used to find the inductance required to have a given reactance.

Example: What inductance has a reactance of 400 ohms at a frequency of 7.2 megacycles (7200 kc.)?

Solution: Set the indicator at 4 on the turns-

per-inch scale ($\text{reactance}/100 = 400/100 = 4$), and set 7200 kc. under the hairline. Move the indicator to No. 17 d.c.c. and read the inductance as 8.9 μ h. on the wavelength scale.

Capacitive Reactance

Set the indicator at No. 5 double-silk-covered wire, and set the frequency under the hairline. Now using the numbers on the wavelength scale to represent micro-microfarads, move the indicator to the value of capacity. Notice that the capacity scale is not used. The number on the turns-per-inch scale under the hairline then gives 1/100 of the capacitive reactance, that is, the reactance in ohms is 100 times the reading on the turns-per-inch scale.

Example: What is the reactance of a 100- μ fd. condenser at a frequency of 5 megacycles (5000 kc.)?

Solution: Set the indicator at No. 5 double-silk and bring 5000 kc. under the hairline. Now using the numbers on the wavelength scale to represent μ fd., move the indicator to 100 on the wavelength scale. The number under the hairline on the turns-per-inch scale, 3.18, gives 1/100 of the reactance. The reactance is thus 100 times 3.18 or 318 ohms.

Again, the reverse procedure is used to find the capacity required to have a given reactance at a given frequency or to find the frequency at which a given capacity has a given reactance.

Example: What capacity is required to have a reactance of 1000 ohms at 56 megacycles?

Solution: Set the indicator at No. 5 double-silk and bring 56 Mc. under the hairline. 1/100 of 1000 is 10, so move the indicator to the number 10 on the turns-per-inch scale, and the reading on the wavelength scale gives the capacity, 2.8 μ fd.

Whenever any desired quantity is not on the scale of the Calculator, the problem can be solved by using values of inductance, capacitance, or reactance that have the decimal point shifted one or two places. The answer must be corrected to correspond. Thus if a value of inductance 100 times too large is used, the value of reactance obtained will be 100 times too large.

Example: What capacity is required to have a reactance of only 10 ohms at a frequency of 3.5 Mc. (3500 kc.)?

*Heintz and Kaufman, Ltd., South San Francisco, California.

Solution: Set the indicator at No. 5 double-silk and bring 3500 kc. under the hairline. Since 1/100 of 10 ohms is 0.1 and this figure 0.1 does not appear on the turns-per-inch scale, use the figure 10 instead. This corresponds to 1000 ohms reactance so the capacity as read on the wavelength scale, 45 $\mu\text{fd.}$, is 100 times too small. The required capacity for only 10 ohms reactance is thus 100 times 45 $\mu\text{fd.}$ or 4500 $\mu\text{fd.}$ (= 0.0045 $\mu\text{fd.}$).

Where these rules are to be used for calculating reactance, it will be helpful to print a letter L next to the line No. 17 d.c.c., and a letter C next to the line No. 5 d.s.c., to mark more clearly these two settings on the Calculator. Concise directions should be typed onto a strip of paper or cut out of the magazine and pasted on to the back of the Calculator so that they can be used easily.

★ NEW TRANSMITTING TUBES ★

NEW HIGH-POWER BEAM PENTODE

HEINTZ and **Kauffman** announce a new high high-power beam tetrode—the Type **HK257**—capable of an output of 230 watts with telegraphy at 2000 volts with a driving power of about 2 watts, 178 watts as a plate-modulated amplifier and 35 watts as a suppressor-modulated amplifier. The tube is only 6 inches high and 2 $\frac{5}{8}$ inches in diameter. It fits a giant 7-pin bayonet base. Ratings and typical operating values follow.

Gammatron Type 257 Beam Pentode

Electrical data:	
Plate dissipation	75 watts
Maximum screen input	25 watts
Filament voltage	5.0 volts.
Filament current	7.5 amps.
Interelectrode capacities:	
Plate-grid capacity	0.04 $\mu\text{fd.}$
Input capacity	13.8 $\mu\text{fd.}$
Output capacity	6.7 $\mu\text{fd.}$

Radio-Frequency Power Amplifier—Class "C" Unmodulated

	Max. Rating per Tube	Typical Operation, 1 Tube	
Power output	230	170	170 watts
Driving power	2.1	1.4	watts
D.c. plate voltage	2000	2000	1500 volts
D.c. plate current	150	150	150 ma.
D.c. suppressor voltage	60	60	60 volts
D.c. suppressor current	5	4	ma.
D.c. screen voltage	500	400	500 volts
D.c. screen current	50	14	11 ma.
D.c. control grid voltage	-500	-180	200 volts
D.c. control grid current	25	9	6 ma.
Peak r.f. control voltage	260	255	volts
Plate dissipation	75	70	55 watts

Radio-Frequency Power Amplifier—Class "C" Plate Modulated (60% Average Value)

	Max. Rating per Tube	Typical Operation, 1 Tube			
Power output	178	143	115	95	watts
Driving power	1.7	1.7	1.7	1.7	watts
D.c. plate volts	1800	1800	1500	1250	1000 volts
D.c. plate current	135	135	135	135	ma.
D.c. suppressor volts	60	60	60	60	volts
D.c. suppressor current	4	4	4	4	ma.
D.c. screen volts	400	400	400	400	volts
D.c. screen current	40	11	11	11	13 ma.
D.c. control grid volts	-500	-130	-130	-130	-130 volts
D.c. control grid current	25	8	8	8	8 ma.
Peak r.f. control voltage	235	235	235	235	volts
Plate dissipation	65	65	60	54	40 watts

Radio-Frequency Power Amplifier—Class "C" Suppressor Grid Modulated (Maximum Input Watts 110)

	Max. Rating per Tube	Typical Carrier Conditions		
Power output	35	33	32	watts
Driving power	4	1.4	2.0	watts
Audio power	100*	100*	500**	milli-watts
D.c. plate voltage	2000	2000	1500	1000 volts
D.c. plate current	100	55	70	90 ma.
D.c. suppressor voltage	-500	-300	-210	-135 volts
D.c. suppressor current	0	0	3	ma.
D.c. screen voltage ***	500	500	600	600 volts
D.c. screen current	27	44	41	ma.
Screen dropping resistor	2000	2000	5000	ohms
D.c. control grid voltage	-500	-130	-130	-130 volts
D.c. control grid current	25	3	8	11 ma.
Peak r.f. driving voltage	150	195	200	volts
Peak a.f. modulating voltage	300	210	175	volts
Plate dissipation	75	75	72	60 watts

Radio-Frequency Doubler Amplifier (Maximum Input 800 Watts)

	Max. Rating per Tube	Typical Operation		
Power output	120	110	80	watts
Driving power7	1.8	5.5	watts
D.c. plate voltage	2000	2000	1500	1000 volts
D.c. plate current	150	95	120	150 ma.
D.c. suppressor voltage	60	60	60	60 volts
D.c. suppressor current	2	4	6	ma.
D.c. screen voltage	500	500	500	500 volts
D.c. screen current	50	6	13	25 ma.
D.c. control grid voltage	-500	300	330	400 volts
D.c. control grid current	-25	2	5	12 ma.
Peak r.f. control voltage	340	400	510	volts
Plate dissipation	75	70	70	70 watts

811 AND 812

RCA ANNOUNCES two new transmitting tubes of interest to amateurs. These are the types 811 and 812.

The 811 and 812 are companion tubes which may be operated at full ratings at frequencies up to 60 Mc. and at reduced input up to 100 Mc.

* Use Type 6C5 tube or equal with 1+2 step-up transformer ratio.

** Use receiving type pentode as 6F6 and 1+1 transformer ratio.

*** Applied through the indicated screen dropping resistor.

The 811 is a high- μ tube designed primarily for r.f. service, but is also suitable for biased Class-B audio use.

The use of "zirconium-coated" nickel plates in both of these types makes possible unusually high-power capabilities for tubes of such small size. (The envelope size is the same as that of the 809.) The new coating material has high heat-dissipating qualities and excellent "gettering" characteristics. Bases are of a new substance called *micanol*. Both tubes have high perveance and require low driving power. Normal input for Class-B audio or Class-C telegraph service is 450 watts per pair under the new intermittent amateur service ratings. Other ratings and operating conditions are as follows:

	811	81#
Filament voltage (a.c. or d.c.)	6.3	6.3
Filament current	4 amps.	4 amps.
Amplification factor	160	29
Interelectrode capacities:		
Grid-plate	5.5 μ fd.	5.3
Grid-filament	5.5 μ fd.	5.3
Plate-filament	0.6 μ fd.	0.8

Typical Operation

A.F. Power Amplifier and Modulator—Class B (Two Tubes):			
	811	81#	
D.c. plate voltage	1500	1500	
D.c. grid voltage	-9	-46	
Peak a.f. grid-to-grid voltage	145	195	
Max. sig. d.c. grid current	38 ma.		
Zero-sig. d.c. plate current	20 ma.	42 ma.	
Max-sig. d.c. plate current	200 ma.	200 ma.	
Load resistance, plate-to-plate	18,000 ohms	18,000	
Max. sig. driving power	10.5 watts		
Max. sig. power output	225 watts		

Class-C Telephony, Plate-Modulated

	811	81#
D.c. plate voltage	1250	1250
D.c. grid voltage	-200	-125
D.c. plate current	125 ma.	125 ma.
Grid resistor	2500 ohms	5000 ohms
Peak r.f. grid voltage	230	245
D.c. current approx.	50 ma.	25 ma.
Driving power approx.	11 watts	6
Power output approx.	120 watts	120

Class-C Telegraphy

D.c. plate voltage	1500	1500
D.c. grid voltage:		
From a fixed supply of	-113 volts	-175
From a grid resistor of	3500 ohms	7000
From a cathode resistor of	600 ohms	1000
Peak r.f. grid voltage	225	285
D.c. plate current	150 ma.	150 ma.
D.c. grid current approx.	35 ma.	25 ma.
Driving power approx.	8 watts	6.5
Power output approx.	170 watts	170

New U.H.F. Tube

Hytronic Laboratories have announced final ratings on the HY615 designed especially for ultra-high frequency use in transmitters and receivers at frequencies up to 300 Mc. The 615, a triode, features short connection leads, relatively small internal elements resulting in low interelectrode capacities. Plate and grid leads are brought out in the form of "horns" at the top of

the bulb. The over-all height of the tube is $2\frac{7}{16}$ inches and the diameter $1\frac{3}{16}$ inch. The base is a special 5-pin octal.

The tube may be universally employed as an oscillator, in low-power transmitters or superhet receivers, neutralized r.f. amplifier, bias or grid-leak detector or as a self-quenched detector in super-regenerative receivers. Ratings and typical operating conditions are as follows:

Electrical Characteristics

Heater voltage	6.3
Heater current	0.15 a.
D.c. plate voltage	300 max.
D.c. plate current	20 ma. max.
D.c. grid current	4 ma. max.
Amplification factor	22
Mutual conductance	2200 μ hos.
Plate resistance	10,000 ohms
Plate dissipation	3.5 watts

Interelectrode Capacities

Grid to plate	1.7 μ fd.
Grid to cathode	1.4 μ fd.
Plate to cathode	1.7 μ fd.

R.F. Amplifier and Oscillator, Class C

(Plate-modulated or c.w.)

Typical operation: ¹	
D.c. plate voltage	300 volts
Grid voltage	-35 volts approx.
D.c. plate current ²	20 ma.
D.c. grid current ²	1.4 ma. approx.
R.f. power output ²	3.5. watts, approx.

Detector Operation

	Biased	Grid Leak
Typical circuit conditions:		
Plate-supply voltage ³	250	180
Grid voltage	-7 approx.	4
Load resistance	0.25 meg.	0.5 meg.
Self-bias resistor	50,000 ohms approx.	
Plate current	5	5
Grid leak	1	to 5 meg.
Grid condenser		250 μ fd.

¹ At 240 Mc. Only moderate reduction in this value will be found for frequencies as high as 300 Mc. Above this frequency, the power output decreases as the frequency increases.

² Subject to wide variations controlled by circuit constants and operating characteristics of associated input and output circuits.

³ This is a plate supply voltage value. The voltage effective at the plate will be plate-supply voltage less drop in load caused by plate current.

⁴ Grid returns through grid leak to cathode.

⁵ Adjusted to 0.25 ma. approx. with no input signal.

★ New Receiving Tubes ★

RCA ANNOUNCES a new series of miniature battery tubes designed particularly for compact light-weight portable equipment. Each tube is only about 2 inches long and $\frac{3}{4}$ -inch in diameter. High operating efficiency of these new types at 45 volts has been attained by a new design which provides compactness without decreasing the size of essential electrode parts. This compactness has been achieved by replacing the conventional base with a new glass-button, 7-pin base sealed to the glass envelope and by mount-



ing the electrodes directly on the glass button. An idea of the size may be obtained from the accompanying photograph.

A special socket has been designed to fit tubes of this series. These sockets have a maximum diameter of $\frac{3}{4}$ -inch and may be mounted in a $\frac{5}{8}$ -inch diameter hole. The sockets are fastened in any desired position by means of a simple clamping plate furnished with the socket.

The series includes a pentagrid converter, a power-amplifier pentode, a diode-pentode and a variable- μ r.f. pentode.

The filaments are designed to operate directly from a 1.5-volt dry-cell and all except the 1S4, which has a current rating of 0.1 amp., are rated at 0.05 amp.

The pin numbers in the tables of base connections follow the standard RMA system.

Tentative characteristics and operating conditions follow:

1R5

Pentagrid Converter

Filament voltage.....	1.4 volts
Filament current.....	0.05 ampere

Converter Service

Typical operation:	
Plate voltage.....	45 90 volts
Grids No. 2 & No. 4 voltage.....	45 45 volts
Grid No. 3 voltage.....	0 0 volt
Grid No. 1 resistor.....	0.1 0.1 megohm
Plate resistance (approx.).....	0.6 0.75 megohm
Conversion transconductance.....	235 250 micromhos
Grid No. 3 bias (approx.) for convs. transcond. = 5 μ mhos.....	-9 -9 volts
Plate current.....	0.7 0.8 milliamperes
Grids No. 2 & No. 4 current.....	1.9 1.8 milliamperes
Grid No. 1 current.....	0.15 0.15 milliamperes
Total cathode current.....	2.75 2.75 milliamperes

Pin Connections

- Pin 1 — Filament (-), Grid No. 5
- Pin 2 — Plate
- Pin 3 — Grids No. 2 & No. 4
- Pin 4 — Grid No. 1
- Pin 5 — Filament (-), Grid No. 5
- Pin 6 — Grid No. 3
- Pin 7 — Filament (+)

1S4

Power Amplifier Pentode

Filament voltage (d.c.).....	1.4 volts
Filament current.....	0.1 ampere

Amplifier — Class A₁

Typical operation and characteristics:

Plate voltage.....	45 volts
Screen voltage.....	45 volts
Grid voltage *.....	-4.5 volts
Peak A-F grid voltage.....	4.5 volts
Zero-signal plate current.....	3.8 milliamperes
Zero-signal screen current.....	0.8 milliamperes
Plate resistance (approx.).....	0.25 megohm
Transconductance.....	1250 micromhos
Load resistance.....	8000 ohms
Total harmonic distortion.....	12 per cent
Max.-signal power output.....	0.065 watt

Pin connections

- Pin 1 — Filament (-), suppressor
- Pin 2 — Plate
- Pin 3 — Grid
- Pin 4 — Screen
- Pin 5 — Filament (-), suppressor
- Pin 6 — Plate
- Pin 7 — Filament (+)

1S5

Diode-Pentode

Filament voltage (d.c.).....	1.4 volts
Filament current.....	0.05 ampere

Characteristics of Pentode Unit

Plate voltage.....	45 volts
Screen voltage.....	45 volts
Grid voltage.....	0 volts
Plate resistance (approx.).....	0.5 megohm
Transconductance.....	5.25 micromhos
Plate current.....	1.2 milliamperes
Screen current.....	0.3 milliamperes

Pentode Unit — Class A₁ Amplifier

Plate voltage.....	90 max. volts
Screen voltage.....	90 max. volts
Plate dissipation.....	0.06 max. watt
Screen dissipation.....	0.025 max. watt
Typical operation as resistance-coupled amplifier:	
Plate-supply voltage.....	41 volts
Screen-supply voltage.....	41 volts
Control-grid voltage *.....	0 volts
Plate-load resistor.....	1 megohm
Series screen resistor.....	3 megohms
Screen by-pass condenser.....	0.1 μ f.
Control-grid resistor.....	10 megohms
Voltage gain † (approx.).....	30

Diode Unit

The diode is located at the negative end of the filament, and is independent of the pentode unit except for the common filament.

Pin Connections

- Pin 1 — Filament (-), pentode suppressor
- Pin 2 — No connection
- Pin 3 — Diode plate
- Pin 4 — Pentode screen
- Pin 5 — Pentode plate
- Pin 6 — Pentode grid
- Pin 7 — Filament (+)

1T4

Super-Control R.F. Amplifier Pentode

Filament voltage (d.c.).....	1.4 volts
Filament current.....	0.05 ampere

* Referred to negative filament terminal.
 † Obtained when the grid of the pentode unit is fed from a source having an impedance of 1.0 megohm.

(Continued on page 90)

Q Measurements

The Home Measurement of Coil Merit Factor

BY C. B. STAFFORD,* W9KWP

MEASUREMENTS of coils have a definite place in every radio engineering laboratory, and many of us have enough equipment to make comparable measurements in our own labs. Sometimes an apparently good coil will show no gain when placed in a receiver. By Q measurements, we may determine whether the coil is at fault. The merit of winding a coil on different form materials is of interest. Other applications will suggest themselves to those who become familiar with Q measurements.

Accurate Q measurements usually require a good deal of expensive equipment. However, most of us have enough equipment in our junk boxes to make comparative measurements. If all of the measurements are made on the same pieces of equipment, the relative values of the several coils measured will be determined. In experimental construction, this is as valuable as the absolute Q .

Definition

The figure of merit of a coil, commonly denoted by the symbol Q , is defined as being equal to the inductive reactance divided by the resistance, or

$$Q = \frac{X_L}{R} = \frac{2\pi fL}{R} \quad (1)$$

In this definition, as in many others in electrical engineering, R represents not only the direct current resistance of the circuit, but also the lumped losses represented by the core and dielectric losses. Q is in a general way a measure of the efficiency of a coil. It is proportional to the ratio of the inductance — that part which is desired — to the losses. In a transmitter it partially determines the power output of the plate circuit. In a receiver, it is a vital factor in determining the selectivity, image ratio, and signal-to-noise ratio. It influences the voltage which will develop across the tank condenser in an amplifier. And last, although the list is far from complete, it determines the lowest voltage at which the oscillator of a superheterodyne will function.

If Q is determined by the use of the defining equation, the result is of little value due to the inaccuracies inherent in the simpler determinations of L and R . In order more clearly to understand the problem, this type of Q measurement will be illustrated. The first discussion will be followed by simpler and more accurate methods.

As an example of the direct application of the

defining formula, let $f = 60$ cycles per second, $L = 2$ henries, and $R = 100$ ohms. Then (App. 1) Q will be 7.54. In an air core coil for audio frequencies, in which R is approximately equal to the direct current resistance, the above method might be used to determine Q . Although beyond the scope of this article, there are better and more accurate ways of measuring the Q of audio frequency coils than the one above.

Suppose now that we wanted to use this same method to measure the Q of a radio-frequency coil. We would be unable to determine easily the correct value to use for R , and other errors would appear when we measured the inductance by the most obvious method. Because this matter of inductance measurement will be useful in a

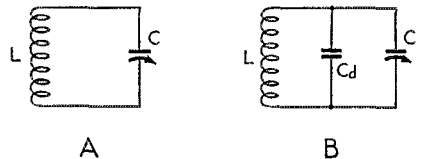

Fig. 1 — A simple resonant circuit is shown at A, while B shows the distributed capacity represented as a separate condenser.

method of Q measurement taken up later, it will be discussed rather completely.

Perhaps the most common method of finding the inductance, which is required for the computation of Q by the direct method, is to connect the unknown inductance in parallel with a known capacity and determine the resonant frequency of the combination. This requires either a known frequency and a calibrated condenser, or a calibrated variable frequency source and a known fixed condenser. Since $f = \frac{1}{2\pi\sqrt{LC}}$, we may solve for L and write

$$L = \frac{1}{4\pi^2 f^2 C} \quad (2)$$

This equation applies when the units are henries, cycles per second, and farads. Using the more common units of microhenries ($L = \mu h.$), kilocycles ($f = kc.$), and micromicrofarads ($C = \mu\mu fd.$),

$$L = \left(\frac{159,160}{f}\right)^2 \frac{1}{C} \quad (3)$$

Using this formula, and knowing the capacity and the frequency, we may solve directly for the

* 323 Wisconsin Ave., Oak Park, Ill.

inductance in microhenries. The numerous graphs and slide-rules for the determination of L , C , or f , when the other two are known, are based upon this equation. As an example of this method of solution, let us suppose that a certain coil tunes to 600 kc. with an external capacity of 410 $\mu\mu\text{fd}$.

Substituting these values into (3), we find $L = 171.6 \mu\text{h}$. (App. 2). We shall say that the inductance thus found is that indicated by the *single frequency* method at 600 kc., and we shall label this value $L_{600} = 171.6 \mu\text{h}$.

If this equation is true, we should be able to employ the same method at some other frequency and obtain the same answer. Doing this, we find that this coil requires 80 $\mu\mu\text{fd}$. to tune it to 1200 kc. This sounds, and is, reasonable, as it takes less capacity to tune a coil to a higher frequency. Substituting these new values into (3), we find $L_{1200} = 219.9 \mu\text{h}$. (App. 3). Most embarrassingly, this value for L at 1200 kc. is not the same as the one obtained at 600. Not only are we stumped in not yet having determined the value for R , but it looks as if our determination of L is also questionable. Our discrepancy of 48.3 μh . is really serious. Assuming the lower inductance to be correct, there is an error of 28.1%. In these days of accuracy of one part in millions, such an error is inexcusable.

A reasonable assumption is that we have not included all of the elements of the circuit. We started with two known values, the external tuning capacity and the resonant frequency. With broadcast stations all around us, there is little reason for frequency error, so we must have erred in our capacity measurement. As a starting point, let us assume that there is some unknown fixed capacity shunting our standard condenser. Let us replace all stray capacities by one fixed capacity. The circuit assumed in the two examples given is shown in Fig. 1-A. Fig. 1-B shows the circuit which we shall assume to exist in the following derivation.

Applying (2) to the circuit of Fig. 1-B, we find $L = \frac{1}{4\pi^2 f^2 (C_d + C_x)}$. This is true since the total

How good are the coils you've been using in your rig? If you have an e.c.o. and a vacuum-tube voltmeter you can measure their Q 's as pretty as you please. Don't let the equations scare you — you don't have to know one bit of math to get the idea.

capacity C is equal to the sum of the component capacities C_d and C_x . This applies to the general case. If we now take the two special cases of two different frequencies, indicated by f_1 and f_2 , tuned to resonance by their respective capacities, C_1 and C_2 , plus the common fixed capacity C_d , the following equations are obtained:

$$L = \frac{1}{4\pi^2 f_1^2 (C_d + C_1)} \quad (4a)$$

$$L = \frac{1}{4\pi^2 f_2^2 (C_d + C_2)} \quad (4b)$$

All of the values but L and C_d are known in these two simultaneous equations, and we may therefore effect a solution. Setting (4a) equal to (4b), and solving for C_d , we find (App. 4)

$$C_d = \frac{f_2^2 C_2 - f_1^2 C_1}{f_1^2 - f_2^2} \quad (5)$$

Now we have obtained a formula for determining any fixed shunting capacity associated with the coil being measured. This in itself is a useful formula for it permits us accurately to measure the distributed capacity of a coil. The adjacent and/or overlapping component lengths of the turns of a coil form condensers. Their total capacities are generally considered constant for any given winding. If the two frequencies used above differ by a ratio of two to one, as in the examples given, the resulting error is negligible.

Since we know C_d in terms of f and C , we may simplify either (4a) or (4b) and solve for L (App. 5). Using the common units (App. 6), we find

$$L_{\mu\text{h}} = \frac{(f_1^2 - f_2^2) \times 10^{12}}{4\pi^2 f_2^2 f_1^2} \times \frac{1}{C_2 - C_1} \quad (6)$$

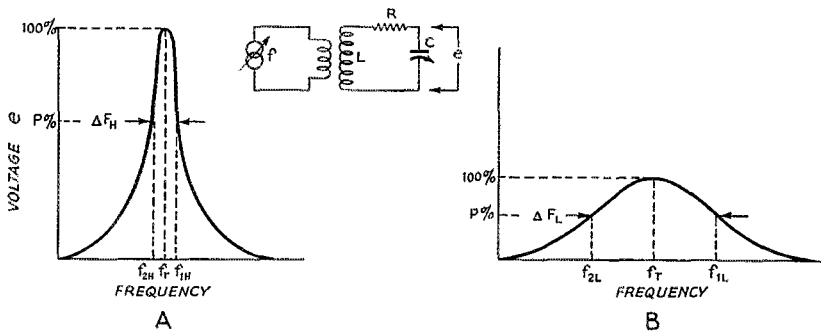

Fig. 2 — Resonant curves of a high- Q circuit (A) and a low- Q circuit (B).

If one uses the same two frequencies for the majority of the measurements, the factor multiplying $C_2 - C_1$ can be once determined and remembered

or recorded as a constant. Table 2 shows a number of useful values. In (6) it makes no difference which subscript is used to denote the higher or lower frequency, so long as it is used the same

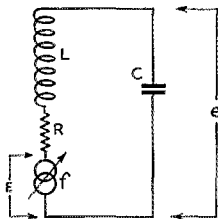
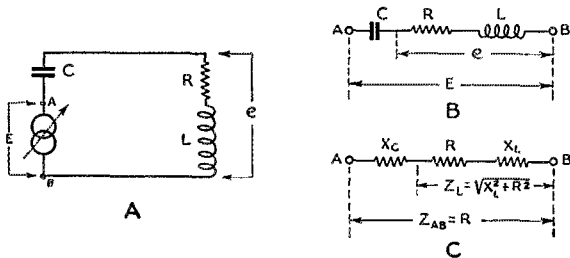

Fig. 3 — The equivalent circuit of the insert of Fig. 2.

way for both the capacity and frequency. If an error is made in this respect, the resulting value of L will be negative. It should be noted that although this equation is derived from (2), it is considerably different in appearance. (6) is the correct one to use when one does not know the total capacity which is tuning the coil. The error made in the examples was caused by the assumption that the external capacity was the only capacity present. Most coils would not have a distributed capacity as high as the coil used for an example.

Employing the values already given for 600 and 1200 kc., we find the inductance to be (App. 7) $L_{1200-600} = 159.9 \mu h$. This is the true inductance of the coil. Table 3 gives the calculated inductance versus the method of calculation. From this the conclusion may be drawn that, for a given coil, the lower the frequency the more accurate will be the determination of the inductance by the single frequency method. This is reasonable to assume, since the lower the frequency the greater will be the capacity which is necessary to tune the coil to resonance. The distributed capacity is treated as a constant and, as the total capacity increases, the distributed capacity, and consequently the error, becomes a progressively smaller percentage of the total capacity. Therefore, at a sufficiently low frequency, C_d may reasonably be neglected.

Fig. 4 — The circuit used to show the relation between Q and voltage gain (A), redrawn for impedance analysis (B), and shown in terms of impedance (C).



If we could determine the effective total resistance, we would be able to calculate the Q of the coil. But it is even more difficult to determine the value of R at radio frequencies than it is in the audio range, so we are again stumped. So the problem must be approached from another angle.

Band-Width Method

Perhaps the most accurate method of measuring Q is the band-width method. The shape of the resonance curve of a coil and condenser is partially determined by the Q of the circuit. Since the losses in the condenser are generally negligible, we may say that the shape of the resonance curve is governed by the Q of the coil. If the coil has a low Q , the curve will be wide and flat. If the coil's Q is high, the curve will be high and narrow. Fig. 2 shows the curve of the voltage developed across a coil and condenser plotted against the frequency impressed upon it. The insert shows the circuit used to determine the curve. A constant voltage of variable frequency is impressed on the coil by a loosely-coupled primary, and the voltage is measured across the resonant circuit. As the impressed frequency approaches, passes through, and exceeds the resonant frequency of the circuit, the voltage across the coil will rise to a peak and then fall. From inspection of the figure, it may be seen that ΔF is defined as the difference between the two frequencies at which the output voltage is $P\%$ of the peak voltage. The additional subscripts in Fig. 2-A and 2-B indicate the high (H) or low (L) Q curve. It should be noted in Fig. 2-B that ΔF for a lower Q coil is much greater than for a high Q coil. This term ΔF is known as the band-width of the resonance curve. From inspection of the figures, it appears that, if a proper and convenient value is assigned to P , and since the Q of a circuit is apparently some function of the band-width, this characteristic might be used to determine Q .

Let us first assume that the reactance at the point where the voltage is $P\%$ of the peak value is equal to the resistance, of $X = R$. Over the narrow range of frequencies employed in a single Q measurement, we may assume that the coupling, and therefore the voltage which develops across the coil, remains constant. With this in view, we may redraw the circuit shown in Fig. 2-A and place the generator in the secondary. This is

TABLE I

Symbols and Abbreviations

- C* — Capacity
- C_d* — Distributed capacity
- E* — Voltage — fixed for any one measurement
- e* — Voltage — varies with adjustment during measurement
- f* — Frequency
- P* — % voltage, when *R* = *X*, is of resonant voltage
- Q* — Figure of merit
- R* — Resistance representing losses in the circuit
- X_L* — Inductive reactance
- X_C* — Capacitive reactance
- Z* — Impedance
- Δ — Small change or difference in the factor indicated

shown in Figure 3. From inspection we see that this is merely a series circuit composed of *R*, *L*, *C*, and a variable-frequency constant-potential generator. Since the impedance of the circuit is $Z = \sqrt{R^2 + X^2}$ at resonance, when the reactance *X* is zero, $Z_r = \sqrt{R^2} = R$. At *P*% down, when *R* is equal to *X*, $Z_1 = Z_2 = \sqrt{R^2 + R^2} = \sqrt{2}R$. Apply Ohm's Law for alternating current, $I = E/Z$,

$$I_r = \frac{E}{R} \text{ and } I_1 = I_2 = \frac{E}{\sqrt{2}R}$$

In view of the fact that the frequency is varied over such narrow limits, the reactance of the condenser in the circuit may be treated as a constant. If such is the case, the voltage *e* across the condenser is proportional only to the current flowing through the circuit. Using the values above to obtain the ratio of the voltage at *P*% down to the voltage at resonance

$$\frac{e_1}{e_r} = \frac{I_1}{I_r} = \frac{\frac{E}{\sqrt{2}R}}{\frac{E}{R}} = \frac{1}{\sqrt{2}} \tag{7}$$

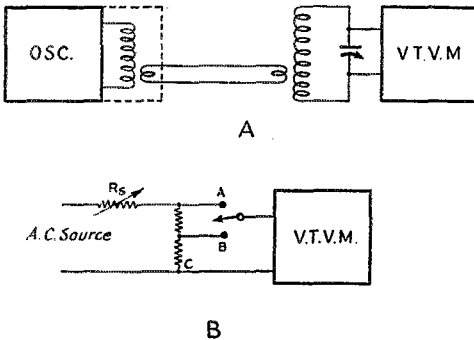

Fig. 5 — Circuit used with the band-width and capacity methods of *Q* measurement. The oscillator r.f. circuit need only be shielded in cases where the vacuum-tube voltmeter picks up signal from the oscillator by radiation. B shows the v.t.v.m. calibrating circuit (see text).

$$e_1 = \frac{e_r}{\sqrt{2}} \text{ or } P = 70.7\%$$

This says that when the resistance and the reactance are equal, the voltage across the parallel circuit will be 70.7% of the voltage at resonance. Let us now apply this information to the evaluation of *Q*.

For fixed values of *L*, *R*, and *C*, as shown in Fig. 3, we may say that the capacitive and the inductive reactances change the amount between the limits of *f*₁ and *f*₂ as previously defined. A general proof of this is given in item 8 of the appendix. Since the total change in reactance as

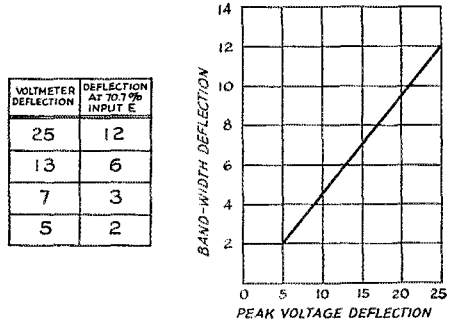

Fig. 6 — Table and graph for finding deflection equivalent to 70.7% of the input voltage necessary to produce any given deflection.

the frequency is varied slightly is equal to the sum of the changes in inductive and capacitive reactances, and since these two are equal, the total change is equal to twice the change of either of the components. The change in inductive reactance is $\Delta X_L = 2\pi\Delta fL$. The total change is, therefore,

$$\Delta X = 2\Delta X_L = (2)(2\pi\Delta fL) = 4\pi\Delta fL \tag{8}$$

The total change of frequency is $\Delta f = f_r - f_2 = f_1 - f_r$. We may now rewrite (8) as

$$\Delta X = 4\pi(f_r - f_2)L = 4\pi(f_1 - f_r)L \tag{9}$$

Since at resonance the reactance is zero, we may say that ΔX , which is the change in reactance (from zero) as we go to either *f*₁ or *f*₂, is equal to the total reactance at either of these frequencies. From this we may write

$$\begin{aligned} 4\pi(f_r - f_2)L &= \Delta X = X = R \\ 4\pi(f_1 - f_r)L &= \Delta X = X = R \end{aligned} \tag{10}$$

Adding the above two simultaneous equations (App. 9), we find

$$f_1 - f_2 = \frac{R}{2\pi L} = \Delta F \tag{11}$$

Dividing both sides of (11) by *f_r*,

$$\frac{\Delta F}{f_r} = \frac{R}{2\pi f_r L} = \frac{1}{Q} \text{ or } Q = \frac{f_r}{\Delta F} = \frac{f_r}{f_1 - f_2} \tag{12}$$

This expression, (12), is actually used for measuring *Q*. From this we may say that *Q* is equal to

(Continued on page 108)



NAVAL COMMUNICATION RESERVE NOTES

The First Naval District

THE Naval Communication Reserve of the First Naval District has on its roster list 590 enlisted men and 67 officers. Many of the members of this N.C.R. group are active amateurs owning and operating their own radio stations. The greater part of these officers and men are engaged in the communication or allied fields and the enrollment presents an excellent cross section of present-day communication.

The First District Naval Communication Reserve is based at the Boston Navy Yard in a building recently modernized and devoted entirely to Naval and Marine Corps Reserve activities. The first floor of the building offers an excellent place for drilling, lecturing or general assembly and is capable of accommodating over 1000 men. On the floor of this assembly hall is painted the outline of a destroyer deck, marked off as to frames, and having a raised platform at one end, representing the bridge of a ship. This drill area is available to Naval Communication Reserve as well as to the other Reserve organizations.

The third floor of the Reserve building houses the master control station NDA, which has been completely remodeled and modernized during the past summer. Antennas are available for several frequencies by a system of selective switching. Operating positions are available, each with its keying control and headset outlet. As this article is written, a new transmitter is being installed. The frequency range being from 2000 kcs., to 8000 kcs., and the output being 150 watts. A commercial type Hallicrafter type S-22 for long-wave work and a crystal-filtered SX-15 receiver for Naval frequency operations have been installed during the past year.

Adjacent to NDA is the N.C.R. Staff Head-

quarters where staff meetings are held throughout the year on the first Thursday of each month. Staff meetings are supplemented by instructional meetings on the third Thursday of each month from September through June. The current instructional course promises to be outstanding. Naval Communication Reserve Instructional Officer, Lieutenant George H. Burrows, U.S.N.R., has arranged for Commander E. B. Robinson, U. S. Navy, to give a series of eight monthly lectures, beginning in October. Commander Robinson is Senior Instructor, U. S. Naval Reserve, for the First Naval District.

Considerable space has been given in *QST* to the general organization of the Naval Communication Reserve in various naval districts, therefore it will suffice to outline briefly the current organization. The District consists of the states of Maine, New Hampshire, Vermont, Massachusetts and Rhode Island. The Naval Communication Reserve in this territory is subdivided into seven Sections, each Section being composed of several Units. There are at present a total of thirty-six Units which completely cover the major portion of the New England States, with the largest membership in the coastal areas. Consistent with the Navy Department's policy, a system of rotation of duty for Staff Officers has been put into effect by the N.C.R. Commander, Lieutenant Commander Raymond B. Meader, U.S.N.R. As of 1 September, 1939, the First Naval District N.C.R. Staff is as follows:

Lieut. Comdr. W. H. Miller, USNR — Material Officer.
Lieut. M. D. Chace, USNR — Personnel Officer.
Lieut. G. H. Burrows, USNR — Instructional Officer.
Lieut. H. D. Kaulback, USNR — Operations Officer.
Lieut. L. G. Cumming, USNR — Editor of N.C.R., Information.
Lieut. (jg) A. E. Linell, USNR — Executive Officer.
Lieut. (jg) N. L. Abbott, USNR — Security Officer.
Ensign W. S. Rogers, USNR — Supply Officer.



◆
Alternate Control Station,
NDR, Portland, Me. Ensign
T. F. Courneen, U.S.N.R., is
officer in charge.
◆

Section Commanders are included in the following list:

- Section One, Maine — Lieut. N. C. Little, USNR (W1OR).
Section Two, New Hampshire — Lieut. R. T. Smith, USNR (W1LBD).
Section Three, Northeastern Massachusetts — Lieut. (jg) R. W. Hart, USNR (W1AAE).
Section Four, Southeastern Massachusetts — Ensign D. M. Stanier, USNR (W1EOZ).
Section Five, Cape Cod, Massachusetts — Lieut. A. E. Snow, USNR (W1RZ).
Section Six, Rhode Island — Lieut. (jg) H. Young, USNR (W1CAB).
Section Seven, Western Massachusetts — Lieut. (jg) C. J. Green, USNR (W1ASU).

Sections and Units are active throughout the year and during the nine months' period from 1 September to 1 July, the Naval Communication Reserve sponsors an annual radio competition patterned after the national competition. The active drill season terminates with the award of a trophy each June. Every year a military drill competition is held, the winner receiving the District Military Efficiency trophy.

The training program for the Naval Communication Reserve includes not only procedure practice by means of radio drills, but also military drill and instruction in duties aboard ship. Active duty at naval stations and on board ships of the Navy is provided each year for the personnel to the extent which funds and equipment permit. During the past summer, 21 officers and 57 enlisted men of the Naval Communication Reserve have performed tours of training duty, usually of two weeks' duration. This duty was in many cases on board ship and in other cases at the Naval Radio Station, Boston, Naval Reserve Aviation Base, Squantum, and at Direction Finder Stations of the First Naval District.

Much has been written about the very fine work carried on by Naval Communication Reserve Sections Five, Six and Seven of the First Naval District, during the hurricane of 1938, and details will be omitted from this article. Suffice it to say that official recognition and much publicity was given to the very valuable work performed by Section Commander A. E. Snow, U.S.N.R., on Cape Cod, Section Commander H. Young, U.S.N.R., in Rhode Island, and Section Commander C. J. Green, U.S.N.R., in central and western Massachusetts.

It is felt that the interest of many amateurs in the Navy is being stimulated by current conditions. The Naval Communication Reserve of the First Naval District will welcome inquiries from amateurs and others as to the qualifications necessary for enlistment. Information may be obtained from the Personnel Officer, Lieut. Myron D. Chace, U.S.N.R., at 74 Grand View Road, Arlington, Massachusetts.

The Triangle Antenna

(Continued from page 81)

we have averaged one QSO per 2.93 calls whereas with the old antenna — a two-wavelength horizontal Hertz about 40 feet high — we averaged one QSO per 5.22 calls. At the same time the incomplete QSO's dropped from 39% to 22%. The calls were all of the same nature — stations we heard, interspersed with a few CQ's of our own — and are entirely comparable. This change has not been wholly due to increased radiation but due to the combined effects of increased radiation and better receiving conditions. The increase of signal strength and the decrease of QRM is most noticeable.

We haven't worked any foreign DX with the array although we did manage to get a few tests from VE's before they were closed down. The final input here runs from 35 to 70 watts depending upon the load on the local power lines, and all work has been on c.w.

Several speculative points are worthy of mention in connection with the triangle array. One is the effect of the idle antenna. Before we built the array we did a bit of theorizing and even ventured a few predictions as to its probable effect. We have, however, been unable to verify any of our predictions so will have to say simply that we do not know what effect, if any, the idle antenna has.²

In the matter of feeding the array, it seems that a single open-wire line with remotely-controlled relays at the base of each antenna for switching and phasing would be the most desirable system. The losses in the present twisted pairs are probably considerable. Feed lines must be of equal lengths to the matching sections to insure proper phasing. Feed systems for vertical radiators have been adequately discussed in the *A.R.R.L. Handbook* and *QST*.³

The triangle array may be used on the lower frequency bands where rotary antennas are impractical. Using quarter-wavelength Marconi units, the array may be used on 40 and 80 meters without going to excessive heights and possibly even on 160 meters if top-loading⁴ is employed. The triangles will, of course, be larger. Multi-band operation is also possible, although the beams will change relative position and shape as the triangle becomes an integral number of wavelengths on a side.

We wish here to thank the fellows who tested with us and to invite anyone with an inclination toward experimentation to give the triangle array a trial.

² It might be worth while to short the feed line of the unused antenna at the station end, to detune it and reduce its pickup and consequent interference with the pattern. — Ed.

³ Lynch, "Feeding Vertical Antennas," *QST*, Jan., 1939.

⁴ Ferrill, "Simple Vertical Antennas," *QST*, Feb., 1939.

How Emergency Coördinators Work

Their duties, and agencies served—Assistants and committees, assignment of responsibilities—A.R.R.L. Coördinators members of Red Cross committees—More Coördinators and Emergency Corps Members Invited

BY ROY C. CORDERMAN*

SOME years ago, to more effectively organize amateurs for operation in disasters and to represent our amateur service abilities properly to the public and to the agencies in each locality, the American Radio Relay League adopted a policy which called for appointing "Emergency Coördinators" in each community.

Prior to the actual emergency, A.R.R.L. Coördinators register the equipment of all local amateurs in a city, as well as contact all the organizations that logically might require help from amateurs in reaching some point outside the affected area. In time of disaster the American National Red Cross assumes responsibility for family relief under the authority as stated in its Congressional Charter which outlines the disaster responsibility of the Red Cross, "To continue and carry on a system of national and international relief in time of peace and to apply the same in mitigating the sufferings caused by pestilence, famine, fire, floods, and other national calamities, and to devise and carry on measures for preventing the same." The local chapter of the Red Cross, aided by its National Organization, takes charge of family relief immediately. The Chapter will be in constant touch with its national headquarters to advise the extent of the disaster and the kinds of material, financial and personal assistance required. If ordinary communication channels have been destroyed, this Red Cross report is likely to come to the amateur for transmission. If the amateur has previously made the acquaintance of the Red Cross people he will know it is an official message, otherwise he should ask the one sending the message to identify himself. It will naturally be followed by a reply from the outside stating how soon assistance can be expected.

The civil government of the community, the head of which may be a mayor, a board of county commissioners, a police chief, etc., may also require assistance, and communications from such officials to a state government may also come to an amateur to handle. When the civil government fails to function due to death of the leaders or other inadequacy, the National Guard will be called upon to preserve order and safety. There is always the possibility it may require amateur assistance to supplement its own communica-

* Regional Emergency Coördinator (Potomac Valley) W3ZD, 4401 Leland St., Chevy Chase, Md.

tions. It is well for Coördinators to be acquainted with all agency officials before an emergency arises.

Besides the Red Cross and the government agencies, there are other organizations we may serve with whom coöperative steps should be taken during an emergency. These include the public utilities such as power companies, telephone and telegraph companies, railroads and airlines. These organizations in general have their own communication channels or lease such channels and in the event of the loss of these channels during a disaster, assistance would be necessary until such time as their own channels could be restored. In fact, radio contact may serve vitally in aiding to restore other channels of communication needed by the public.

In each community certain other organizations customarily assist in communications work during an emergency. These include broadcasting stations, Boy Scouts, the American Legion and the newspapers of the community. Although the means by which they would accomplish their assistance may be quite different from that of the amateur whose specialty is point to point, two-way communication, the objective would nevertheless be the same, and coöperation can make the accomplishment of the objective easier for all.

The general public also calls on amateurs to send word to relatives, friends, neighbors and acquaintances. These requests must be controlled to prevent congestion of amateur channels at any time when there is agency and official traffic to take care of. In the latter stages of general emergency, as wire service is being restored, amateurs often win fine public approbation through handling this secondary traffic. An advance organization setup that will permit the amateur to refer his friends to some central point for assistance or for filing messages for deferred transmission will prevent this congestion. Every Red Cross chapter has a sub-committee on "registration and information" with responsibilities for answering inquiries of relatives, friends, and others about the welfare of persons in the disaster area. There is needed, then, close coöperation with the Red Cross for prompt handling of such requests received by the amateur. It should be arranged to have these messages go through the Red Cross or through one of the telegraph companies either

of which would be quite willing to set up a central point for the collection of personal messages. As was mentioned in October *QST* " . . . traffic will not in general come from or through any one source or agency. Priority will be determined for each dispatch filed by any or all agencies on the principle of the greatest good of the greatest number, and in view of the public interest involved."

The leadership of each Coördinator requires contact and understanding with all others locally having means of communication, or needing amateur facilities in order to correlate available channels, to aid in routing any message to any particular point effectively. Most of all, however, coördination of amateur facilities and groups is necessary, and in a body as large as amateur radio this is in itself a major problem. Emergency Coördinators are urged by A.R.R.L. to become acquainted with Route Managers, P.A.M.'s, net control operators in A.A.R.S. groups, unit and section commanders in the N.C.R. and others, in order to enlist their active advance collaboration in plans and in order that all regular facilities and circuits may be known and fitted into emergency communication plans that will utilize each station and circuit effectively. In fact "Liaison" Coördinators in A.A.R.S. and certain N.C.R. groups assist tremendously in promoting smooth coördinated communications setups and planned operating to serve the public interest in event of emergency.

A.R.R.L. Emergency Coördinators in most cities appoint Assistant Coördinators specializing in work in different amateur bands to aid in *registering and mobilizing amateur facilities* for the whole amateur service, and constituting a *committee to plan*. The Coördinator and/or the committees should, wherever possible, assign definite duties to certain persons, for any contingency. For example, in Washington, we have one person who is responsible for emergency station equipment; another, for emergency station personnel; another, responsible for gasoline driven power units which can be used with fixed stations; and finally one who acts as recorder or secretary to our group.

The creation of interest in his program prior to an emergency is perhaps the greatest problem which an Emergency Coördinator will encounter.

Unless his community has gone through emergencies, the attitude too often is, "It couldn't happen here." A method which has been followed in the Washington area and which has been quite effective started with the preparation and distribution of a directory of organizations, which would require, would assist in the furnishing of, or which would have an interest otherwise, in emergency communications. This directory after the initial issue was revised at six-month intervals with the addition of the names of such other organizations as had been located, and the needed corrections to bring it up to date. Copies of the directory with an explanatory letter were sent to the newspapers and press releases regarding it developed a certain amount of general public interest. After several directories had been distributed, a "get acquainted" meeting of representatives from the various listed organizations was called. Arrangements were made with the Red Cross to use the District Chapter Auditorium. Although the stated objective of this meeting was to become acquainted, a presentation and discussion of the problems which each of the organizations expected might arise during an emergency was made by each of the representatives when he was called upon. The newspapers were represented by reporters at this meeting and the publicity which followed, not only properly recognized the Coördinator, but lent aid to his efforts in preparing his community to meet a communication emergency, and obtaining fullest amateur coöperation and registrations.

The District of Columbia Chapter of the American National Red Cross, understanding the need for communication coördination, invited us to become a member of its chapter Transportation and Communication Committee for disaster relief and in our local case also to act as vice-chairman of this committee for radio communication. Many chapters will have two committees, one for Transportation and one for Communication, which is optional. The new disaster instruction manual within the Red Cross organization includes a recommendation that bears directly on amateur participation. After referring to the desirability of enlisting amateur operators in emergency communication plans and test drills, the manual reads:

A.R.R.L. SCM's, at this writing, are expanding the League's field organization and public service, by appointing additional Coördinators for coverage of as many cities and towns as possible. This timely article, by a Coördinator, tells how Coördinators work, points to the need of the amateur service for Coördinator-representation in every community. Can you help cover a point not already covered? Has a Coördinator been appointed in your city? Are you registered in the Emergency Corps? Do you have its identification card? Coördinator appointments are made by SCM's. Information from SCM's or Hq. on request.

— *Communications Manager.*

The American Radio Relay League has designated Emergency Coördinators in many communities to unify the service of amateur radio operators for emergency communication. The Emergency Coördinators should be made a part of the Sub-Committee's plans.

The Sub-Committee, through the representatives of commercial communication companies and amateur radio operators, should coördinate means for receiving and transmitting all Red Cross messages so that emergency traffic will receive priority. The plan may include a message center maintained under the control of the Sub-Committee through these representatives.

With this more definite place on Red Cross committees for A.R.R.L. Emergency Coördinators, organization work in so far as the local community is concerned should be much easier for all than it has been in the past. The Red Cross has been through thousands of emergencies, and in recent years it has found its communication problems considerably reduced in those communities where League Coördinators have been on the job.

A final word to the amateurs who live in a community which has no Coördinator. Contact the League at once regarding your community, giving your name as a candidate for Coördinator or giving the name of some other amateur who you know to be a leader. First of all, *every licensed amateur* should register his facilities in the A.R.R.L. Emergency Corps. A postal to Hq. will bring the Form 7 blank. In each county, some Coördinator must represent the League and the amateur service on the Red Cross Committee handling communications problems. Your neighborhood in its entire history may never have had an emergency, but one can never tell when one may come. "It *can* happen there!"

Personality Over the Air

(Continued from page 45)

QSO with a brother ham he tells you that he is a banker and you were asked to rate his personality immediately afterward, you would undoubtedly rate him as possessing the characteristics which you attribute to most bankers. Your rating of him as a personality would probably be quite different had he told you he was a grocery clerk or, let us say, a policeman. Inasmuch as a person's occupation is usually one of the first personal bits of information exchanged between amateurs, it is quite likely that this factor influenced the ratings unduly.

If the personal and amateur ratings do not agree very closely, what about a comparison of self-ratings and those of the two types of acquaintances? Self-ratings by the twenty-seven amateurs were found to show but little agreement with ratings by either of the two groups of acquaintances. In other words, an amateur may consider himself to be such-and-such, his personal acquaintances regard him as something else, and the impression which he gives over the air is still different. How-

ever, the relationship between self and personal ratings is closer than between self and amateur ratings. It is interesting to note that the traits showing the most agreement for self and amateur ratings are "pleasantness of voice," "quietness-boisterousness," "generosity," and "conventionality." Even for these traits, the agreement is not very close. We must conclude either that amateurs do not give the impressions over the air which correspond to their evaluations of themselves, or that they were not frank in their self-estimates.

I am sure all amateurs will also be interested in the question of whether or not these twenty-seven amateurs as a group were rated by their personal acquaintances as markedly different from any other group of the population. In other words, are amateurs the peculiar sorts of individuals they are sometimes considered to be? In this connection, the data are quite flattering. As a group, these twenty-seven amateurs are rated as superior to a group of thirty-eight college men on twenty of the thirty-six traits and inferior on only six. In most cases the superiority is not great, but the direction and amount is enough to suggest that this group of twenty-seven Class-A amateurs represents a distinctly superior group of the general population. For instance, they were rated as better adapted to social situations, more friendly, more punctual, more coöperative, more persistent, more honest, more optimistic, more sincere, more entertaining, and more dependable than the college men with whom a comparison was made.

Lest the picture be too flattering, it should be added that the group is inferior to the college men in that they were rated slightly less handsome, considerably less religious, somewhat less courteous, somewhat poorer dressers, as having more narrow interests, and as less conventional than the average college man. Just how serious these defects are and whether they are more than offset by the favorable ratings is left to the reader to judge.

Many factors prevent this from being a conclusive study. The number of cases studied is much too small and at least five ratings by personal acquaintances and five by amateur acquaintances should have been available for each person. Of the total of 550 scales sent out, less than half were ever returned for evaluation. Some amateurs report that their operating is so irregular that they do not really know five brother amateurs well enough to ask them for a rating. Then, too, it must be admitted that many amateurs do not take advantage of the opportunity which our hobby offers for making new acquaintances. "Your signal is a 5, r 9 plus, — rig here is a 6A6 crystal — etc." does not enable one to learn much about the other fellow as a person.

It would be extremely interesting to repeat the experiment with a group of exclusively c.w. amateurs to learn how the impression of one's fist (!)

compares with the impression of one's voice as regards the accuracy of the resulting personality ratings. It might also thus be possible to answer the old question of whether or not real personality differences exist between those who stick to c.w. and those who are primarily interested in 'phone operation. The difficulty of obtaining sufficient coöperation in this little study makes the writer feel somewhat loath to attempt to repeat it with c.w. operators. Or are c.w. operators as a group perhaps more coöperative?

★ BOOK REVIEWS ★

The Pageant of Electricity, by Alfred P. Morgan, D. Appleton-Century Co., Inc., New York. 363 pages, 85 illustrations. Price, \$3.50.

One assumes that this is the same A. P. Morgan who was responsible for writing *Wireless Telegraph Construction for Amateurs* in 1910, although his publishers make no mention of the fact. If this is true, he is not likely to repeat his three-decades-earlier success. *Wireless Telegraph Construction* became the standard handbook for amateurs of its time, but *The Pageant of Electricity* has little prospect of becoming the standard reference work in its field — the history of electricity. This was probably not the intention, anyway. If the author's sole purpose was to write an entertaining and informative narrative of electricity for popular consumption, then he has done a satisfactory job. Such an objective more or less justifies the superficial character of the subject matter, the use of legendary figures and interpretations already established in public fancy. There is little in the way of new and original research in the volume; it is chiefly a compilation of material already presented in a variety of standard sources. One attempt at departure from tradition concerns the origin of broadcasting. This attempt is something less than constructive. Morgan cites Lester Spangenberg's amateur station 2ZM as antecedent to KDKA, loudest claimant to the honor of having been the first broadcaster. While there is no doubt that 2ZM was one of the first amateurs to transmit voice and music by radio, and thereby one of the first stations in the world to do so, it seems to us there must be an essential distinction between the commercial and the amateur in referring to broadcasting. From that standpoint WWJ and W8KK (KDKA) share the honor between them — WWJ being first on the air, and KDKA first to attract a substantial b.c.l. audience.

Except possibly for the brief sections devoted to radio — many of the phrases of which will ring familiarly — the amateur can extract measurable enjoyment from this layman's-eye view of the electrical tradition. Legendary, fictional, factual or whatnot, it is pleasant reading.

Look and Listen, by M. B. Sleeper, The Norman W. Henley Publishing Co., 2 West 45th St., New York. 96 pages, 71 illustrations. Price, \$1.00.

Television and Short-Wave Handbook, by F. J. Camm, Fortuny's, 67 West 44th St., New York. 270 pages, 130 illustrations. Price, \$2.50.

Television Cyclopaedia, by M. N. Beitman, Supreme Publications, Chicago.

This television triumvirate tends to create in this reviewer a mood of philosophic rather than of technical discussion. The stuff these books contain is so very similar to that we

saw published fifteen or twenty years ago about radio. *Look and Listen* is a set-builder's construction kit, and is actually an assembly manual for a commercial kit now on the market, with a background in the way of fundamentals and miscellaneous television information. *Television and Short-Wave Handbook* (written and printed in England), while a comprehensive and moderately intensive exposition of principles suitable for the earnest amateur or engineering student, is also directed primarily at the set-builder and home constructor. *Television Cyclopaedia* gives definitions of television terminology in glossary fashion; it is intended as an introduction to television for amateurs, servicemen and set-builders.

All of which implies a belief on the part of the sponsors that there is to be another era of home set-building — that the phenomenon of the "kit" and the "hookup" that dominated 1924-1929 is to be reincarnated. If that is true, then the basis of a literature for such an era can here be found. Add to it the material on television fundamentals and construction in *QST* and contemporary magazines, and you'll have a practical working knowledge of the subject. Maybe, after all, here is one of the missing keys to future success that the art of television seems still to be vainly seeking.

Radio Interference Suppression, by Gordon Wm. Ingram, Electrical Review, Ltd., Dorset House, Stamford St., London, S. E. 1. 162 pages, 60 illustrations. Price 5/- net (by post, 5/3d, or about \$1.25).

An informative review of electrical interference and its suppression in a wide variety of industrial and domestic applications. Valuable chiefly to the engineer seeking a broad picture of the field, but useful also to the serviceman and amateur.

Radio Service Trade Kinks, by Lewis B. Simon, McGraw-Hill Book Co., New York. 269 pages. Price, \$3.00.

The author, manager of a chain of radio stores in New York, has been active in radio servicing since 1921. In this book he has listed alphabetically the hundreds of makes and models of broadcast receivers he has serviced, citing their customary ailments and mentioning the cures. As a guess, more than five hundred types are thus treated. These are adequately indexed for ready reference.

In style and format — spiral binding, coated paper, 9 x 11 page size — the volume suggests the salon rather than the shop, but for any serviceman with \$3.00 cash this should be no serious disadvantage. He would stand a very good chance of getting the \$3.00 back in time saved later on.

— C. B. D.

Aeronautic Radio, by Myron F. Eddy; 502 pages, 199 illustrations. Published by The Ronald Press Company, New York City. Price, \$4.50.

The amateur thumbing through this volume will find an unexpectedly home-like atmosphere about it — maybe this aeronautical radio isn't such a fearsome subject after all! Closer inspection discloses the reason: 34 of the 178 drawings are from two A.R.R.L. publications, the *License Manual* and the 1938 *Handbook*, all but a few of them without benefit of intermediary draftsman. Here and there are a few individual touches; some of our "A's" and "B's" and "C's" have been cut off, and now and then the sections of multipart drawings have been arranged in different fashion, but the parenthood is indelibly stamped on the children. With them, of course, is much of our accompanying text; edited, often, but recognizable. Our 1938 list of preferred tube types is there intact; a few selected items from our tube tables also have been included, but we don't know where the reader will look to find the socket connections, since the corresponding diagrams from the '38 *Handbook* were not reprinted, nor is there any appropriate footnote to explain just what those "T's" and "I's" and "J's" mean.

Our contribution to the book is, of course, on fundamen-

tals. If the author's good taste in selecting his sources extends to the aeronautical sections (we presume it does, judging by the list of acknowledgments in the Preface where, incidentally, no mention is made of A.R.R.L. publications) the text is no doubt a reliable collection of information useful to those interested in airways operating. The larger portion of the book is devoted to commercial equipment for both ground stations and planes, radio beacons, and other radio appurtenances to aviation. There are also chapters on installation and maintenance of equipment on airplanes, traffic control, and related subjects. A useful appendix is a set of definitions of over 250 terms commonly encountered in the technical literature.

The diagrams of commercial equipment are, of course, those furnished by the manufacturers. In the others, we noticed only one obvious error, the omission of blocking condensers between the driver and Class-C amplifier in a typical circuit given in Fig. 76 (not from the *Handbook!*), resulting in the driver's plate voltage being applied to the amplifier grids. — G. G.

Regenerative Preselector

(Continued from page 31)

signal could be heard very plainly and the db meter read 34. The above figures would indicate that the signal-to-noise ratio was markedly increased with the preselector ahead of the receiver and that the signal strength under those conditions was approximately the difference between the db meter reading with the noise and the reading with noise plus signal, which would be 9 db. To determine whether or not this marked increase in signal-to-noise ratio was approximately the same at other frequencies, the same procedure was repeated at 14 Mc.

Results at 14 Mc.

Signal without preselector: -5 db.

Signal with preselector: +35 db.

(Universal motor started.)

Noise without preselector: +18 db.

Noise with preselector: +24 db.

Noise plus signal without preselector: +18 db.

(No signal could be heard from the speaker.)

Noise plus signal with preselector: +35 db. (The signal could be heard plainly along with the noise.)

It would appear from the above figures that the signal, under noise conditions and with the preselector, was again about 9 db.

Results at 1.7 Mc.

Signal without preselector: -7 db.

Signal with preselector: +34 db. (There was quite a material increase in set noise.)

(Universal motor started.)

Noise without preselector: +22 db.

Noise with preselector: +28 db.

Noise and signal without preselector: +22 db.

(The signal could not be heard above the noise.)

Signal and noise with preselector: +32 db. (Signal could be heard, but not as well as at the higher frequencies.)

The above data would indicate that the signal was greater than the noise by about 4 db.

Thus, it would appear from the experimental investigation carried out that the regenerative preselector had a very beneficial effect on signal-to-noise ratio, especially on the higher frequencies.

Ham Shacks

(Continued from page 53)

he dares to call CQ. This time it's none other than our old friend VS6AO in Hongkong. A. Harbottle is the operator who, not satisfied with his daily chore of nursing several marine, broadcasting and commercial outfits, finishes the day with an evening of "Sure QSL" on 14- or 28-Mc. c.w.

The transmitter enclosure houses a rig consisting of a 42 crystal oscillator, 6L6G doubler and a pair of T20's in parallel. The receiver is an NC100 preceded by an RME DB20 preselector for which there is plenty of need in avoiding QRM from his near-by commercial charges. The antenna is a single-wire voltage-fed 14-Mc. Hertz.

VS6AO spent 16 years in the British marine service, starting back in the days of fixed spark gaps and magnetic detectors.

We're all hoping it won't be long before we again hear the call that starts 1000 W keys rattling in unison.

Splatter

(Continued from page 10)

bands. This is just a thought and if enough interest is shown in this type of work we'll blow a page or two in *QST* each month to this activity. This might well go on until the lid is off once more. Start 'em coming, gang!

— . . . —

Lyle Peer, W2ACB, comes forth with a potent suggestion. He advocates that we publish some short technical kink that has been tried out and proved to solve the particular problem. So we are starting out this month with our first item "Experience Speaks," and we expect to publish one of these technical squibs in a box under that heading each month.

— . . . —

CHRISTMAS

Greetings

TO ALL HAMS

*from the Crew
at Headquarters*

3rd Annual A.R.R.L. QSO Party

January 6th-7th (Sat.-Sun.)—For Member-Fun and Fraternalism—Tie Holder with Call Insignia To Be Awarded in Each Section—Start a QSO List, Call "ARRL de . . ."—Use Any Bands, 'Phone or Telegraph—Try Your Luck in the Party

LEAGUE Members only are eligible. It is a family party for all of us members, a chance to meet our fraternity brothers. CQ's are out! The way to get contacts in this will be to send "ARRL de . . ." In the course of a contact members will tell each other two things, the *name* of their Section¹ and the *date* their membership expires, month and year.

Members in each Section are invited to chat with as many other A.R.R.L. members (anywhere) as they can. The leading member in each Section will receive *his own call* on the diamond shaped pendant tie holder.

Log forms (not necessary) will be sent free on request to Hq., or rule your own, just three columns listing *calls, Sections,¹ dates*. In radiotelephone contacts the Section, membership month and year will be named. No special order is required. It's a "one operator" activity, or separate scores for each operator may be sent in.

Radiotelegraph members will abbreviate Section names and use four numerals to show membership dates. "Conn 0343" will mean "Connecticut Section, my membership good through *March 1943*" for example. Information to be exchanged in every case comes right off your own *League membership certificate or pocket card*. Members will not enter in either a radiotelegraph or radiotelephone classification. Many use both. Scores can be all by one mode, or part telegraph and part voice—and any combination of frequencies you like. When completing contacts, be sure to add to fraternalism by giving your personal "sine"² (c.w.)² or nickname ('phone) before

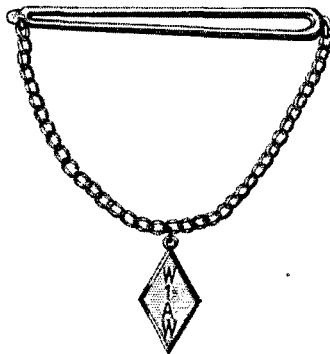

your identifying call in conclusion of QSO's. Advance entry is unnecessary. Just take part and send in the list of members you worked with claimed score. Tell us in reporting, what frequency bands you worked, please, for information.

Starting Time: Saturday, January 6th, 2300 11 P.M. Greenwich; 3 P.M. PST; 4 P.M. MST; 5 P.M. CST; 6 P.M. EST or the equivalent at any point.

Ending Time: Monday, January 8th, 0801 8:01 A.M. Greenwich; 12:01 A.M. PST; 1:01 A.M. MST; 2:01 A.M. CST; 3:01 A.M. EST or equivalent.

Operate *any 20* hours of the 33-hour party. State contest hours you did *not* operate if your score is over 10,000.

Scoring: 1 point for each complete set of information sent; 1 point for each set of data received and logged. No member can be worked to get more than one complete exchange for 2 points. The sum of points will be multiplied by the num-

(Continued on page 80)

¹ See complete list of A.R.R.L. field organization Sections, in the front of this issue of *QST*. An award is also available to the leading member in each continent (outside field organization territory). All members outside the field organization use the name of their continent instead of a section abbreviation. Note that CO-CM, K4-6-7, KA and VO as well as W members are in the field organization and cannot be also counted under a continental status. Hq staff stations and W1AW will participate but are not eligible for awards.

² The personal "sine" or sign consists of the initials of the operator, the first and last letters of his name, an abbreviation for his name, or other identifying designation. For example our "sine" is "FH," while our nickname (some prefer "handle") is "Ed." It's fraternal in amateur work and the mark of a real and experienced operator as well to *have* a personal sine and use it. In commercial work, the operators in a given service are often assigned personal identification to use in putting handling data on messages without confusion between two operators of the same name. In amateur work the "sine" has this use but is mainly used for fraternal, as well as convenient *personal* identification. The operator-sign is not required in our Party but is highly recommended for use at least on sign-off.

Don't Miss It!

**Most easy to take part. Enjoyable!
SWAP name of Section and month-
and-year of membership expiration.
Send us worked list.**

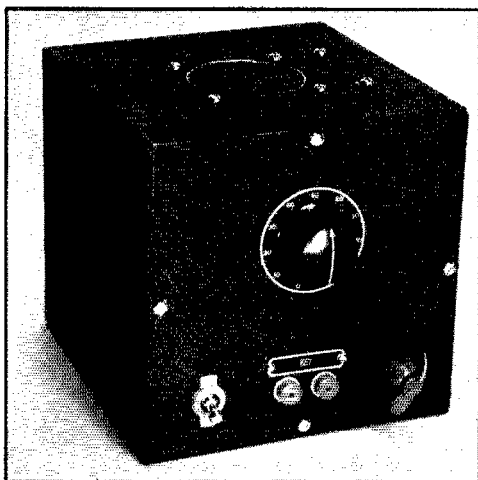

Useful for Individual or Group Code Instruction or as a Keying Monitor

◆
 Front view of the code-practice oscillator and c.w. monitor all assembled. Notice the speaker grille on the top. The top of the box serves for a baffle.
 ◆

A Code-Practice Oscillator and C.W. Monitor

BY VERNON CHAMBERS,* W1JEQ

A SURVEY of Technical Information Service letters definitely indicates that beginners still turn to audio-oscillators as a means of generating code-practice signals. Usually they spend a few dollars for components and then find little use for the parts after the code has been mastered, the license obtained and the station assembled. As we experienced this same situation ourselves, we set out to do something about it.

Naturally, the first consideration was cost. Catalogs showed that one of the "old-reliable" oscillators (that's not its official name) could be built for approximately four dollars, including tubes and batteries, but that such a budget allowed only a bread-board affair with headphone output. Further study of the catalogs showed that we could dress up the gadget, make provision for either six sets of headphones or a loud speaker in the output circuit and also make arrangements for using it as a transmitter keying monitor—all for approximately eight dollars, only twice the cost of the crude oscillator.

Fig. 1 shows the circuit. The audio oscillator is the ordinary feedback type which has been described in past issues of the *Handbook*. The additions needed to permit the several types of operation are not many. The selector switch, SW_2 , is connected for monitoring when thrown to position No. 1. This brings the speaker into the circuit and

connects the oscillator to the leads which run to the transmitter (a few more words about that later). In position No. 2, SW_2 places the "B" battery, the key and the speaker in series for code-practice work. The third set of switch contacts is left open to help prevent accidental shorting of the speaker and headphone circuits. A short between these two circuits might be disas-

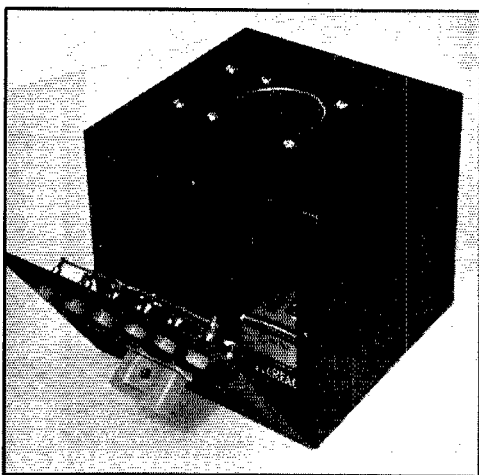

The rear view showing the terminal assembly.

*Technical Information Service.

trous in the event of a voltage breakdown when the unit was wired into the transmitter. The battery, key and headphones are in series with the switch turned to the fourth set of contacts.

Fig. 2 shows the transmitter center-tap circuit as modified for operating the monitor. The resistor R_1 should be chosen to give a voltage drop of 12 to 15 volts for the monitor plate circuit. Ohm's Law is used to calculate the resistance value. For instance, to obtain a 15-volt drop in a transmitter center-tap circuit carrying a combined plate and grid current of 100 ma., the resistance must be

$$R = \frac{E}{I}$$

or $\frac{15 \text{ volts}}{0.1 \text{ amp.}}$, which equals 150 ohms.

The resistor-drop method of obtaining plate voltage for the oscillator may be employed with any type of final amplifier, but it must be remembered that the voltage drop adds

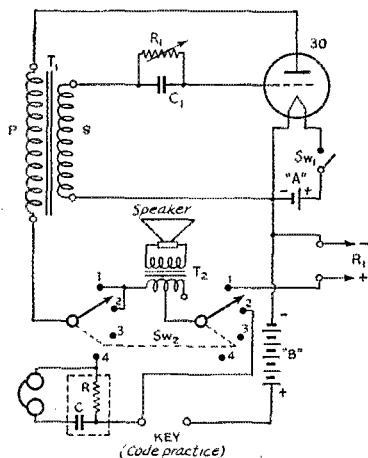
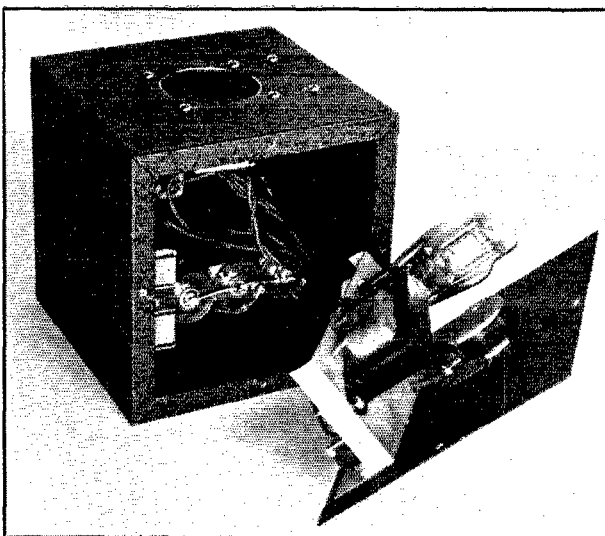

Fig. 1 — Circuit of the oscillator monitor.

- C_1 — 0.01- μ fd., 400-volt tubular paper.
- R_1 — 500,000-ohm variable.
- T_1 — Coupling transformer, 3:1 ratio (Thordarson T13A34).
- T_2 — Output transformer; plate to 3-6 ohm V.C. (Thordarson T14S83).
- Sw_1 — S.p.s.t. toggle switch.
- Sw_2 — 2-circuit, 6 contacts per circuit (Yaxley 3226J) (2 sets contacts unused).

Additional parts used are as follows: Speaker (Oxford type 2-ZMP); cabinet, 6- by 6- by 6-inch (Bud CU1098); chassis (Bud CB-522); One Type 30 tube; two or three 1.5-volt flashlight cells (paralleled); one 22.5-volt "B" battery (Eveready No. 763 or Burgess No. 4156); two or more pairs tip jacks (Bud PJ-837); one output terminal assembly and plug (National FWJ and FWF); one small dial plate; two small knobs.



The front "open-for-inspection" view.

to the amplifier grid bias and subtracts from the plate voltage. However, this has little effect on the amplifier operation and need not be taken into consideration if the drop is limited to 15 volts or so.

As a safety precaution, the dropping resistor, R_1 , should have two or three times the necessary wattage rating. If the resistor were to burn out, a rather high voltage would appear across its terminals and damage to the oscillator unit

probably would result. The required rating can be calculated after the correct resistance has been determined, simply by squaring the transmitter plate current and multiplying by the resistance ($I^2 \times R$). For instance, the resistor in the example above would have to dissipate 1.5 watts, the product of 0.1 amp. by 0.1 amp. by 150 ohms. Thus, to assure a safety

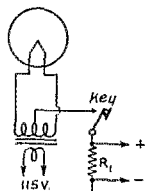

Fig. 2

factor a 5- or 10-watt resistor should be used.

The photographs show the unit in finished form and also "open-for-inspection." The variable pitch control is mounted toward the top of the front panel with the code oscillator key terminals below. The filament switch is to the left and the selector switch to the right. On the top is a 2-inch hole behind which the speaker is mounted. A disc of copper screen is placed between the speaker and the mounting surface. The two screws which hold the output transformer in place are at the right.

The photograph above shows the tube and audio transformer mounted on the chassis, the

(Continued on page 88)

★ I. A. R. U. NEWS ★

Devoted to the interests and activities of the

INTERNATIONAL AMATEUR RADIO UNION

Headquarters Society: THE AMERICAN RADIO RELAY LEAGUE, West Hartford, Conn.

MEMBER SOCIETIES

American Radio Relay League
Asociația Amatorilor Romani de Unde
Scurte
Associazione Radiotecnica Italiana
Canadian Section A.R.R.L.
Československá Amatérská Vysílači
Deutscher Amateur Sende-und-Empfangs
Dienst
Eesti Raadio Amatooride Ühing
Experimental Radio Society of Egypt
Experimenterende Danske Radioamatører
Fédération des Emetteurs Belges
Irish Radio Transmitters Society

日本アマチュア無線聯盟 Japan
Liga Colombiana de Radio Aficionados
Liga Mexicana de Radio Experimentadores
Magyar Rövidhullámú Amatőrök Országos
Egyesülete
Nederlandsche Vereeniging voor Interna-
tionaal Radioamateurisme
Nederlandsch-Indische Vereeniging Voor
Internationaal Radioamateurisme
Newfoundland Amateur Radio Association
New Zealand Association of Radio Trans-
mitters
Norsk Radio Relæ Liga

Polski Związek Krotkofalowcow
Radio Club de Cuba
Radio Club Venezolano
Radio Society of Great Britain
Rede dos Emissores Portugueses
Reseau des Emetteurs Français
Reseau Luxembourgeois des Ama-
teurs d'Ondes Courtes
South African Radio Relay League
Suomen Radioamatööriilitto r.y.
Sveriges Sändareamatörer
Unión de Radioemisores Españoles
Union Schweiz Kurzwellen Amateur
Wireless Institute of Australia

INVENTORY

WE CANNOT find much encouragement in the results of a survey of international amateur activity. But since facts are facts and cannot be ignored, let's take a look at some statistics and see where we are:

As of the middle of this year, there were 32 active societies affiliated with the Union. Of the countries thus represented, only 8 permit amateur radio operation at present. They are: United States, Estonia, Japan, Colombia, Hungary, Mexico, Netherlands East Indies and Venezuela. Perhaps it should be noted that in the "shut-down" column are listed Italy, who does not legally permit amateur operation anyway; Spain, shut down for the period of civil strife but now expecting to resume amateur operation shortly; and Cuba, temporarily closed pending formation of new amateur regulations. The mortality rate among the societies themselves has not been so high; we know of only three which have been forced to cease operation completely — P.Z.K., R.E.F. and U.S.K.A. There may be others.

Disregarding Union membership for the moment, a check of 85 large (with respect to normal amateur radio activity) countries and colonies shows that 53 are off the air and only 32 are on. In point of number of amateurs, we find that 15,000 of the world's approximately 20,000 (exclusive of U.S.A. and possessions) amateurs are silent, or a percentage of 75 off the air.

U.R.E. REORGANIZATION

THE *Unión de Radioemisores Españoles* reports itself making good progress, with the election of a general board as follows: Angel Uriarte (EA4AD), president; Jose Gutierrez Corcuera (EA4AT), vice-president; Manuel Rodriguez Cano (EA4BE), treasurer; Francisco

Bellon (EA4AQ), auditor; and Jesus M. Cordova (EA4AO), secretary. The address is as before: Box 262, Madrid.

The society hopes to obtain very soon the necessary permit for normal operation and government licensing. Plans are also being made to take up with the telecommunication authorities the actions of the Cairo conference with respect to their effect on amateur radio, particularly with reference to 7-Mc. broadcasting. It is the wish of the society to resume publication of the official organ as soon as possible, although it is realized that to do so successfully necessitates a partial completion of the business cycle in radio parts sales so there will be advertising revenue available.

SOUTH AMERICA

ALTHOUGH to our knowledge no South American country has closed down its amateurs, several have issued government orders concerning neutrality which affect the extent of amateur operation. Argentina, for example, on September 20th prescribed the following restrictions on amateur activity: Communication, actual or attempted, with stations in belligerent countries is prohibited; in domestic communication and that with any Spanish-speaking country, only that language may be used; all communication containing comment, news or even simple reference to the political or economic situation of any country is prohibited; amateurs should operate only during the period of the working day and on pre-selected frequencies — the government is sending a questionnaire to each licensee requesting him to pick a frequency and regular hours for his future operation; strict fulfillment of regulations regarding third-party traffic is ordered. The government has selected a number of stations to act as deputy monitors of amateur activity.

Chile issued an order on November 1st concerning neutrality in communications, and although we do not have details it is believed similar provisions were included for amateurs.

A number of radio amateurs in Colombia have affiliated themselves with the newly-formed government radio reserve, the "Army Radio Net," similar to the Army Amateur Radio System in the United States. "Thus," says the government announcement, "our amateurs are preparing to serve the interests of our country in an efficient manner."

SWEDEN

EUROPEAN conditions have forced the close-down of amateur radio in still another neutral country — Sweden. However, "... the interest for ham radio is still left," says SM5KP, "and the majority of active amateurs are now rebuilding and improving their equipment in order to make a good come-back when we are allowed to go on the air again one day."

QSL BUREAUS

THE following changes should be noted:

France — Bureau suspended.

Spain — U.R.E., Box 262, Madrid.

Sweden — Bureau suspended.

U.S.A., Fifth District — James F. Manship, W5ALE, 910 So. Boston, Tulsa, Oklahoma.

CUBA BACK ON THE AIR

BEGINNING about the 1st of December, and continuing over a period of several days, Cuban amateurs, in groups, were given authority to return to the air; all of them should be on by the time this material appears. It is not known at the moment what important changes, if any, were made in the law governing amateurs, but we shall report any such news of interest next issue.

On a commission designed by the Secretary of Communications to confer with him on the formation of the new law were Sres. Justo Mahia y Rivas, CO2JM, head of the short-wave section of the *Radio Club de Cuba*, Guillermo Madrid, CO2WM, and Rafael Bordenave, CO2RW.

ICELAND

IN THE midst of these dark days for European amateur radio, there comes a note from our friends in Iceland telling of their battle to secure government licensing of amateur activity in that country. Undaunted by continued opposition, they are persistent in their efforts to win recognition of the authorities and an eventual official fostering of amateur activity.

HERE AND THERE

AUSTRALIAN amateurs who own b.c.l. sets will have to secure regular listeners' licenses for their operation as soon as the expiration date shown on their amateur licenses has been reached.



J. A. Gilmand, operating ON4SG portable on 80-meter c.w. in Kessel, Belgium, sometime before September 1st.

Before suspension of amateur radio, possession of a station license exempted the holder from having to obtain a second permit for his broadcast receiver. . . . Although the exact date is not known, amateurs in Roumania were closed down in the early weeks of the war. . . . We notice in foreign magazines, both commercial publications and amateur organs, a number of articles on "learning the code." . . . Word comes that all amateur stations in Austria and Germany are closed and all transmitting apparatus has been confiscated by the post office department, but that the hams are very busy improving their code ability and building receiving and auxiliary equipment. . . . It is customary for this department to carry in the January issue a complete list of countries as compiled by the A.R.R.L. for its DX Century Club. Since no major change has been made in the list as published a year ago, it will not now be repeated. . . . The *Wireless Institute of Australia*, upon taking the matter up with their P.M.G. Department, were advised that "call signs at present held by experimenters will be reserved for them when licenses are again issued."

Switch to Safety!

(Continued from page 41)

6 ma., the average 7.8 ma. Using pliers held in each hand as electrodes, the maximum voltage that any subject could take and still release was 40 volts a.c., the average 27.8. That means that if you get a really good grip on a fresh 90-volt B-battery you probably won't be able to release it. In fact, in some tests where 22 subjects completed a circuit by trying to pick up an object immersed in a bucket of water, it was found that the maximum voltage the individual could withstand was between 12 and 20, and the doctor in charge of the tests concluded that, regardless of the general health of the men, anything over 12 volts was extremely dangerous under wet conditions! So how much chance have we got of ever getting away from 1500 or so?

Switch to safety!



HINTS AND KINKS FOR THE EXPERIMENTER



ANOTHER HARMONIC OSCILLATOR CIRCUIT

IN deciding on a crystal oscillator circuit there are many points to consider:

1. Should a triode, a tetrode, or a pentode tube be used?
2. Will the frequency be stable?
3. Will the crystal operate at low r.f. current?
4. Will the plate reaction on the grid circuit be minimized?
5. Will the circuit be suitable for the production of harmonics?
6. Will few component parts be used?
7. Will the circuit permit using crystals ground for all bands from 10 to 160 meters?

It is difficult to satisfy completely all of these conditions, but the circuit of Fig. 1 does approach this ideal.

The oscillator tube shown may be either a tetrode, or a pentode with suppressor connected internally or externally to cathode. This choice was made because electron coupling could be employed, immediately providing the answers to considerations 1 and 4, since the output circuit has little effect on the crystal grid circuit with screen and plate coupled in this fashion. The crystal, screen, cathode, 0.0005- μ fd. condenser, and the 100- μ fd. condenser form the oscillator proper. With no tuning coil placed in the oscillator portion of the circuit band changing is simplified and fewer parts are used.

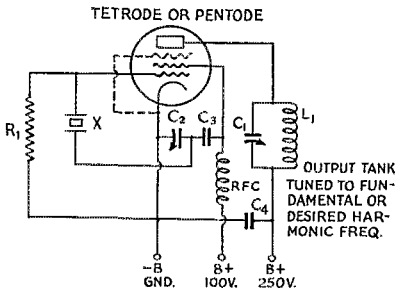

Fig. 1 — Harmonic crystal oscillator with one tuned circuit.

- C_1, C_2 — 100- μ fd., variable.
- C_3 — 0.0005- μ fd., 600-volt mica.
- C_4 — 0.002- μ fd., 600-volt mica.
- R_1 — 40,000-ohm, 2-watt carbon.
- L_1 — Output tank coil, determined by frequency band.*

* Suitable coils are listed in Chart, Fig. 516, 1940 Handbook.

If the operation of the oscillator is confined to use with 160- and 80-meter crystals, a 50- to 75- μ fd. fixed condenser may be substituted in the circuit for the 100- μ fd. variable condenser shown, reducing the cost of the oscillator and simplifying adjustment.

Excellent harmonic output may be obtained with this arrangement, the second harmonic nearly equals the fundamental output, and fourth-harmonic power is appreciable.

The oscillator operates in the following manner: The screen grid acts as a plate (similar to Tri-tet operation), the 0.0005- μ fd. condenser blocks the direct current and provides one part of a capacity voltage divider for the r.f. voltage developed in the screen circuit. The 100- μ fd. variable condenser acts as a by-pass to the screen circuit and the crystal grid circuit, a common impedance to these two circuits but not to the plate circuit, providing the feed-back from screen to grid necessary for oscillation. Experiments have shown that the plate-circuit isolation is excellent. Interaction from tuning and loading is reduced to a minimum. Frequency change with tuning of the plate-circuit is negligible.

The size of the grid-leak resistor may be determined experimentally for best fundamental or best harmonic output, depending on the major use of the oscillator. The 40,000-ohm resistor shown should be satisfactory for harmonic operation. Voltages as low as 160 volts plate and 75 volts screen, and as high as 480 volts plate and 250 volts screen have been used with entirely satisfactory results. The simplicity of construction and adjustment make this oscillator a very worth-while unit for the amateur station.

— Donald A. Bush, W8ONW
214 Third St., Aspinwall, Pa.

ANOTHER COMPACT MULTIPLE CRYSTAL MOUNTING

JOSEPH JAREK, W8TKA, sends in the description of the multiple crystal-mounting unit shown in the sketch of Fig. 2. The foundation is a National PB-10 coil shield which will accommodate 12 $1\frac{3}{8}$ -inch crystal holders in an extremely small space. The unit may be plugged into the usual 5-prong socket used for single crystals.

Pin-type jacks are used for the contacts. There is sufficient space for four pairs on each of the broad sides of the shield can and the narrow sides

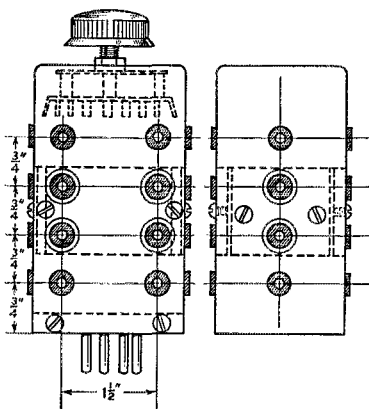

Fig. 2 — Compact multiple crystal holder made from coil-shield plug-in unit. The arrangement accommodates 12 crystals.

will accommodate two pairs each. Of each pair, one contact may be grounded to the can, while the other must be insulated. An insulated-type jack may be used, or clearance holes may be drilled as shown in the sketch and the holes backed up with pieces of polystyrene sheet in which the jacks are mounted. Incidentally, the new ultra-compact ceramic crystal socket made by Millen should be just the ticket for this job. The standard spacing of $\frac{3}{4}$ -inch is used between the jacks of each pair and the double rows on each of the broad sides are spaced $1\frac{1}{2}$ inches.

The Yaxley type 1311L 11-point, single-circuit switch which is used just fits inside the top of the can so that care should be exercised in mounting it with the shaft in the exact center of the top.

The easiest way to wire up the unit is to solder leads of about the right length to the switch terminals before mounting the switch and then mount the jacks, one at a time, starting at the top connecting each one as it is mounted. The can is grounded to one of the base pins, while the switch arm is connected to another so that correct connections to the circuit are made when the unit is plugged in.

GETTING RESULTS WITH THE PIERCE CRYSTAL OSCILLATOR CIRCUIT

MANY of us are attracted by the simplicity of the Pierce crystal oscillator circuits. However, there seems to be an abundance of grief connected with getting them to operate properly. Extremely active crystals such as "AT" or "Y" cuts usually perk OK, but the ordinary garden variety of "X" cut plates displays a great tendency to do just nothing. The following suggestions may be of help to those having trouble with the circuit.

Fig. 3-A will be recognized as the oscillator used in W8NCM's ultra-simple portable rig described on page 23 of August (1939) *QST*. With

many crystals this circuit performs perfectly. With many others of good make it absolutely refuses to produce a thing. A 50- μ fd. variable condenser connected between the grid and the cathode as shown will allow any crystal to be used. The adjustment of this condenser is fairly critical and should be made with care so that the crystal r.f. current will not rise to a value sufficient to fracture the crystal. The smallest amount of capacity that will cause reliable operation should be used. The same idea applies to the ordinary triode version of this circuit except that perhaps a larger condenser may be needed.

Fig. 3-B is also a well-known circuit and is often recommended for harmonic operation. It is used in the 6L6 two-band transmitter in Fig. 836 in the 1939 *A.R.R.L. Handbook* and is the circuit used in W6OQH's emergency portable on page 29 of August, 1939, *QST*. More frequently than not the second harmonic is absolutely nil. This is because the Pierce triode circuit utilizing the screen grid for its "plate" must be capable of oscillating of its own accord when delivering output on the second harmonic. The regular plate circuit is merely an amplifier of the second harmonic. The crystal circuit should oscillate even if the plate coil is removed. If it does not there will be no second harmonic output in a properly operating circuit. The answer again is to place a small variable condenser between the grid and cathode of the oscillator tube. The adjustment of this condenser is rather critical and, as with the Tri-tet circuit, it should be set to give

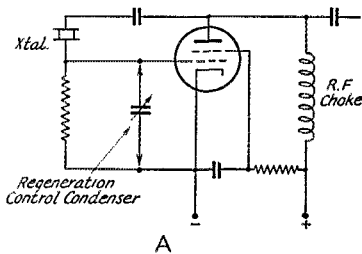

A

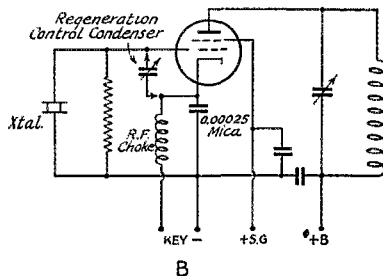

B

Fig. 3 — Circuits for introducing regeneration in Pierce and gridplate oscillators to help operation with stubborn crystals.

the greatest output consistent with the lowest crystal current. When operating on the fundamental frequency, this condenser should be set at zero or preferably removed from the circuit. All the rules that apply to Tri-tet operation should be observed.

Only tubes with negligible plate-to-grid capacity should be used for fundamental operation unless provision is made to reduce greatly the amount of regeneration in the circuit.

A word about the crystals and their holders would not be out of place. The crystal holder plates should be ground to a smooth flat surface the same as the crystal itself. Warped plates are the cause of many crystal troubles. Both the crystal and the plates should be thoroughly cleaned with carbon tetrachloride and great care taken not to touch them with the fingers afterward. The pressure exerted by the crystal holder spring often causes erratic operation. Ready-mounted crystals are usually adjusted at the factory. When crystals are changed from one holder to another it would pay one to experiment a little with the pressure of the spring in the holder. In some cases, failure to oscillate may be caused by excessive capacity between the plates of the crystal holder. The remedy is to replace one of the plates with one of smaller size. Disks or square plates about half an inch across have proved very satisfactory with 80-meter crystals.

— Ed. Preston, W8CSE

HOMEMADE HIGH-VOLTAGE TANK CONDENSER

ALTHOUGH variable condensers with close plate spacing require high mechanical precision, it is possible to build a satisfactory high-voltage transmitting condenser with no more mechanical skill than that possessed by the average amateur who is familiar with the use of tools. Of course, the inaccuracies which develop will result in a condenser slightly larger in size for a given break-down voltage, but this is usually of little consequence.

The accompanying sketch and photographs of Figs. 4, 5 and 6 show the details of a tank condenser which should withstand a peak voltage of about 5000 per section. The capacity will run

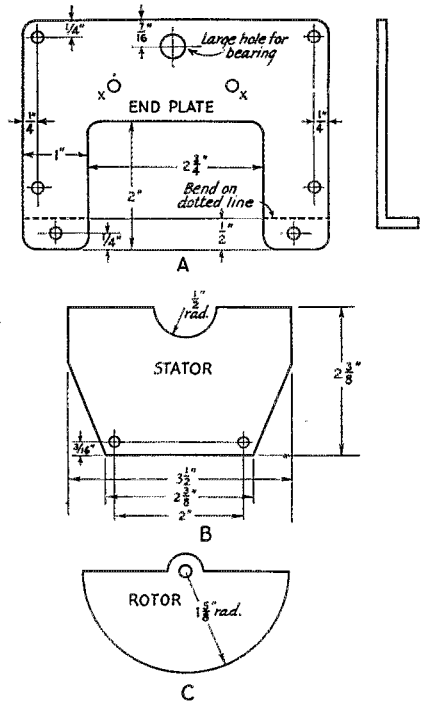

Fig. 6 — A — End plate. B — Stator plate. C — Rotor plate.

about 50 μfd . per section. The material may be purchased for about four dollars.

Referring to the sketch, the end plates A are cut from $1/8$ -inch brass, copper or aluminum. After the two pieces have been cut roughly to size, they may be clamped together with a pair of screws through holes drilled for the purpose, such as those shown in the drawing of Fig. 6 at X. They may then be finished up together with a file and the pieces will be identical. The mounting feet are bent at the dotted line after making deep scratches along the line on each side of the piece.

The condenser plates are cut from $1/32$ -inch sheet aluminum, which in my case was obtained

(Continued on page 98)

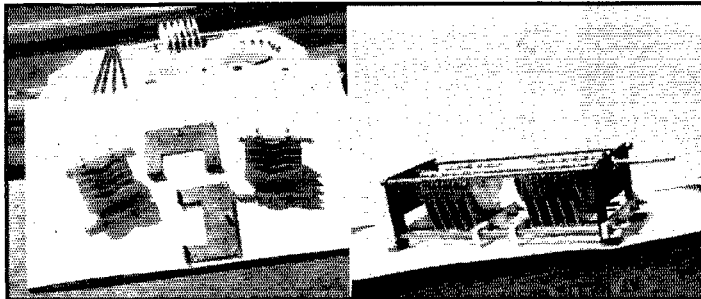
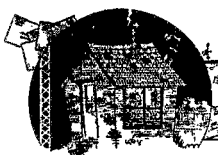

Fig. 4 (L.) — Various sections of the homemade tank condenser before assembly. The end plates and the two completed stator assemblies are in the foreground and the rotor assembly for use.

Fig. 5 (R.) — The complete tank condenser ready for use.



CORRESPONDENCE FROM MEMBERS

The Publishers of *QST* assume no responsibility for statements made herein by correspondents

AN O.O. OBSERVES

319 Wisconsin St., Sparta, Wis.

Editor, *QST*:

In keeping with my appointment as Official Observer, I fully expected to do some "observing," but I wasn't expecting to do so much. Perhaps it was reasonable to expect an abundance of bad notes and off frequency operation during the Sweepstakes when so many more amateurs take to the air, but the old F.C.C. say-so still holds — "there may be an excuse but there is no reason."

As an Official Observer I certainly do not intend to become over-exacting. If an amateur has a bad note and is continually working to make it better, then I'm not going to hop all over him, but I expect to land rather hard on the fellows who operate day after day when they know their signals are not up to the standards set forth by the F.C.C. During the Sweepstakes I noticed that many of the violations I encountered were by newcomers to amateur radio, fellows who have had their tickets a year or less. Let it be said, however, that plenty of violations from the old-timers were heard also, and that brings up my idea as to why the newcomers seem rather lax in many cases. They listen to some of the other fellows who have been on the air several years and hear some rather flagrant violations, therefore they think that the F.C.C. regulations aren't really as binding as they are. Then when they get their transmitters going, they do not consider the regulations to any great extent. The result is just that many more violations to deal with. There is only one remedy for this situation, and that is for all amateurs, with no exceptions, to take particular care to see that their operation and equipment meets F.C.C. standards. Our government has been generous with us during these uncertain times, and in return we should show our appreciation by observing not only the neutrality regulations but *all* regulations, thereby giving no cause for cancellation of privileges due to misbehavior citations. A "misbehavior" can be exemplified by calling to mind the fellow who appeared on 6990 kc. with a T4 chirpy signal and made it highly difficult to copy the Armistice Day message from WLM.

Amateur radio is strong in this country. It can be made stronger if we all realize that F.C.C. regulations are not a collection of 1000 new jokes.

— Glen C. Daniels, W9YXH

USE OF THE S-SCALE

Pleasant Valley, Conn.

Editor, *QST*:

That our system for reporting signal strength remains unsatisfactory is generally recognized. I wish here to propose simple means that might enable "R" or "S" reports to accomplish what was originally intended, namely to convey an accurate description of station performance during a given contact.

The present deficiencies arise mainly from two sources: dissimilarity of receiving equipment, and lack of a common denominator for what we refer to as "conditions". Under the dissimilarity of equipment may be lumped not only the hodge-podge of "R" and "S" meters, but other structural and electrical differences, difference in location, in antenna systems, in noise levels.

To take a convenient example, my receiver is one of the stingiest on S points. Yet it is a fact that, with a preselector and one of these down-on-the-farm high-gain antennas, I can

often tune all the way from 14,150 to 14,250 kc. without the needle of the meter dropping away from the pin once. (I have reference to the right hand pin.) But only three or four stations on the band can be easily read despite the fact that all of them are entitled to S9 plus plus reports — unless I should choose to say, "Well, old man, you have the needle up against the pin, but in all honesty I should say you are about S8."

On the other hand, with no change whatever in the meter adjustment as provided on the rear of the chassis, I can sometimes read perfectly a signal so weak as to fail to push the needle up to S1. This generally occurs on the 75-meter band during quiet forenoon hours on the weaker signals. And here, I believe, a report of S1 is just as misleading as a report of S9 plus in the first instance.

Does the solution lie in establishing a standard based on microvolts at the receiver? I don't think so. It may be a matter of academic satisfaction to know that you are putting umpty-ump microvolts into the other fellow's shack, but that is small satisfaction if he comes back nevertheless with "QRM".

What we seek is some standard of comparison that will be independent of both man-made and God-made variables, that will provide a common denominator for receivers, both single-signal supers and t.r.f.'s, for antennas, locations, and varying conditions prevailing in the ham bands.

My proposal is that we select as this standard the loudest signal or signals on the band at the time of operation, and call this signal strength S5. (One to 9 embraces too many divisions.)

Instead of adjusting the potentiometer which sets the meter from the rear of the chassis, let's have it out on the front panel, preferably right under the meter. Each time you sit down to operate your rig — or shift to a new band — spin the bandspread, note the tops in signal strength, and set the meter to read S5 on that signal. In other words, when conditions change, S5 changes.

The discrepancies that may creep in, using this system, are far preferable to the virtual meaninglessness that now prevails. An S5 report would mean, "Your signal is as loud as any on the band," and 5 plus would mean that no other signal was so strong. S4 would mean very strong; S3 would mean average; S2 would mean weak, and S1 would mean as weak a signal as could be picked up. . . .

How about some discussion?

— Jonathan Eddy, W1LAU

AND LEAP YEAR COMING ON!

Bowbells, N. Dak.

Editor, *QST*:

The letter from W7FWB which you published in July *QST* has brought remarkable results, and the YL Radio League is advancing by leaps and bounds.

Although we have already contacted over one hundred YL ops, I feel sure that this letter, if published, will reach many more who do not yet know about the club.

All YL's and XYL's who have their own tickets are eligible for membership, and may have more information about the club by writing to me. We may be few in number in comparison with the number of OM's, but by working together we can show that we hold a definite place in amateur radio.

— Enid Carter, W9NBX, Secretary, Y.L.R.L.
(Continued on page 96)



OPERATING NEWS



F. E. HANDY, WIBDI, Communications Mgr.

E. L. BATTEY, WIUE, Asst. Communications Mgr.

The A.R.R.L. Member Party comes but once a year. On the ultra-highs or the low-low frequencies alike, it's a chance for members to get acquainted. As at least one fellow said in speaking of the "SS," the joy of it is like a convention. That is especially true of the A.R.R.L. Party. You meet a bunch of old friends and make some new. Fellowship is emphasized in the QSO's even as a hearty handclasp is the outward symbol of our convention and hamfest adventures. All members are urged to take part. See announcement this issue. For those who like to keep track, a simple scoring plan is included. But you don't have to pay any attention to "points" . . . enjoy the contacts . . . test your rig . . . meet the gang . . . and report, whether you spend ten minutes or hours at the controls. The dates? January 6th and 7th.

The Century Club rules are re-run in this issue, brought up to date by inclusion of the rule against submission of altered cards, with the penalty therefor. In order that Century Club policies may not be in conflict with our war neutrality responsibilities and recommendations (p. 66, Nov. 1939 QST) that we do not work belligerent nations' amateurs under any circumstances, a new rule, now effective is that confirmations of contacts with any such countries will not count. The list of such countries is that determined by Presidential proclamation. Of course for the most part all warring nations already have terminated or suspended amateur licenses, effective with the date of declaring war, so the effect is only to eliminate any improper encouragement of work with the few political-military pseudo-amateur or definitely bootleg stations.

U.H.F. DX? 1940, with interest in the ultra-highs growing by leaps and bounds will see a lot of records shattered, DX and otherwise. Did you notice that all hams are asked to report their new states, for an award to see who can roll up the most states during the year? The record of u.h.f. STATES will amount to the same thing for the u.h.f. gang that the CENTURY CLUB means to the low-frequency men who are after countries!

A beautiful CUP Trophy may move to parts unknown this coming year. We're giving it the best of care. Known as the M.R.A.C.-A.R.R.L. 56-Mc. Achievement Award, it was announced in July 1937 QST. For the information of possible winners we summarize the award conditions:

For the first licensed U. S. amateur work, two-way between continents . . . the great circle distance covered in excess of 2000 miles . . . the transmitters utilizing 56-60 Mc., this award will be made. Written evidence from all principals must show what information was exchanged, and prove to the satisfaction of the officers of the Milwaukee Radio Amateurs' Club and the American Radio Relay League that two-way communication was effected.

The U.H.F. Marathon for 1940 gives everybody a chance at development of the important u.h.f. bands—56-112-224-and-up Mc.! Analysis of member-equipment shows a surprising amount of u.h.f. equipment put to work as a sideline in low-frequency stations. This contest should be an invitation to get the habit of a night or two a week working the ultra-highs, or perhaps we should suggest week-ends as the profitable time for all concerned to try out for new contacts. At any rate, don't leave your u.h.f. stuff in the attic, for next summer to roll around. Get in on this

part of amateur radio, too, and send in your points each month. Work with some other local hams to better your set up. Use a few postal cards or low-frequency messages for experimental skeds and try to extend your range. Each Emergency Coördinator may need a local u.h.f. net to connect important local points with communication in emergency, if and when hurricane, flood, 'quake, or other disaster requires. These frequencies are well fitted for reliable work when we learn how to make full use of them. Our public service planning makes it desirable that all u.h.f. equipment, emergency powered or otherwise, be registered in the League's Emergency Corps. Do all you can on u.h.f. and report points for the Marathon each month.

The A.R.R.L. Emergency Corps Needs You. Re-registration is now the order of the day for all amateurs throughout the entire League Emergency Corps. We start every year right by having a complete overhaul of the personnel of the A.E.C. The League field organization of today is founded on the principle of qualification for posts, of service to brother amateurs or the public (in each appointment), on a showing of consistent activity or re-registration to show continued availability and readiness for service. That part of League organization which is dedicated to emergency work receives suitable blanks each year-end for return to the League Headquarters to make a complete reconstruction of personnel records possible. Men who have changed equipment so show; those who have moved indicate new address; those whose work has required giving up amateur activity, or who for other reasons do not reply, are dropped from the rosters until again heard from. Only new members of the Corps receive the A.E.C. Emergency-Identification Cards, since the original cards are continuing in effect, if blanks are returned.

During December and January each A.R.R.L. Emergency Coördinator has been asked to plan local ways and means and take steps to enlist new A.E.C. Members. All amateurs are behind the Emergency Corps in spirit. In practice the League aim is to be able to show the F.C.C. and the Red Cross that all active amateurs are actually enlisted! Operators and regular stations are needed in the program as much as those with emergency power. The plan is for some sort of annual roll call or mobilization meeting to be arranged in each community for the purpose of REGISTERING EVERY AMATEUR STATION IN THE A.R.R.L. EMERGENCY CORPS and furthering the plans for use of amateur facilities in the community and public interest in the event of any communication need. Just as the Red Cross holds an annual Roll Call, this is our invitation to you to attend such a meeting (or get blanks from us direct) all to help in practical emergency preparedness, and to extend the readiness and prestige of the amateur service. This invitation isn't to League members alone, but to all amateurs, for the good of amateur radio. If you haven't, will you do your part and register, please!

— P. E. H. —

— . . . —

Unlicensed Operator Indicted

Preston Funk of Philadelphia was indicted recently by the Federal Grand Jury for operating an unlicensed radio station, masquerading as an amateur. Funk, who holds neither operator nor station license, was operating on 1.75-Mc. 'phone using the call W3IAN (which is properly assigned to an amateur in Newport News, Va.). He was tracked down by L. E. Kearney, R. I., by means of a direction finder and mobile receiver equipped with field strength meter.

PRIZES FOR BEST ARTICLE

The article by Mr. Charles F. Rockey, W9SCH,* wins the C.D. article contest prize this month.

Each month we print the most interesting and valuable article received marked "for the C.D. contest." Contributions may be on any phase of amateur operating or communication activity (DX, 'phone, traffic, rag-chewing, clubs, fraternalism, etc.) which adds constructively to amateur organization work. Prize winners may select a 1940 bound *Handbook, QST*, Binder and League Emblem, six logs, eight pads radiogram blanks, DX Map and three pads or any other combination of A.R.R.L. supplies of equivalent value. Try your luck. Send your contribution to-day.

Key Adjustment

BY CHARLES F. ROCKEY, W9SCH*

AFTER having listened to, and indulged in, all manner of code manipulation on the various amateur bands during the last five years. I have formed the opinion that many of the "punk fists" heard on the air are not the result of inability or "cussedness" on the part of the respective operators but of improperly adjusted keys.

Of late there has been much said about the proper use and adjustment of the semi-automatic or "bug" key, therefore more along this subject would obviously be superfluous. However, doubtless due to its simplicity and apparent obviousness, the subject of proper use and adjustment of the common, so-called, hand key has been almost neglected. Result: possibly thirty percent more "lids" than need be.

Fundamentally the hand key is nothing more or less than a simple lever of the second class, which your physics professor will tell you is a lever wherein the resistance or counter effort is situated between the effort point and the bearing or fulcrum and in which case the effort and counter effort oppose each other in direction. In the case of the key, the counter force is represented by the spring and the power to balance it is, of course, the operator's arm. The fact that there is a back stop, and the presence of the contacts, is incidental to the fundamental analysis. Therefore, a little thought will reveal that in the operation of brass pounding, what one really does is to periodically overbalance the spring tension, by pressure of his wrist to the extent that the end result of closing the contacts is obtained. Thus it is readily seen that in pounding the key one is not working against the contacts but against the spring. The spring, however, is not the only factor. Assuming that, as in all good keys, the trunnion bearings are quite frictionless the other factor that must be considered is the distance over which the effort must move, inasmuch as the work accomplished is not the force exerted alone or the distance alone but the product of the two. Thus the problem resolves itself into that of balancing the operator's physical characteristics with the characteristics of the key which involve the spring tension, and the distance of vertical knob travel, a case of mechanical impedance matching, as it were. It is easy, then, to see that when the key is properly adjusted the operator is working at his peak of efficiency. When the spring is too loose or when the distance of knob travel is too small the operator must work against himself and therefore he wastes energy, while it is easy to see how a too stiff spring or too wide contacts (too much vertical knob travel) will likewise tire one out. From this it may be gathered that there is a critical key adjustment for every operator, which indeed seems to be the case. In my own case it appears that the "best" adjustment seems to vary, slightly, from day to day, facetious as it may seem. There can be no hard and fast rules for key adjustment because individuals are so

unlike. However a few principles, humbly suggested, might be in order:

1. Adjustments should start at minimum spacing and spring tension and be increased until things "feel right." One must be his own judge in this matter and no rules can be set. Again — let it be stressed that no one else can properly set your key for you.
2. Plenty of time should be taken in these adjustments and they should be corrected from time to time. This is no "set and forget" matter if best results are to be had. "Trifles make perfection but perfection is no trifle."
3. DO NOT MAKE THESE ADJUSTMENTS WITH THE TRANSMITTER ON THE AIR. This should be presupposed, but bears repetition anyway. Use a buzzer or oscillator for listening tests.
4. Make sure that your key is in good condition to begin with. If it isn't, fix it up or throw it out and get one that is. One cannot play a sonata on a cow bell!

In conclusion, let me suggest that you try re-adjusting your key and see whether it doesn't improve your operating pleasure and skill. You will probably find as a result that where you were formerly a "QRU 73 cul" artist, you will become a staunch supporter of the "Royal Order of Bacon Rind Munchers," and the other fellows will be glad to QSO you. Try it and see.

— — —

Brass Pounders' League

(October 16th-November 15th)

Call	Orig.	Del.	Rel.	Extra Del. Credit	Total
W7EBQ	17	60	1662	40	1779
W6DH	98	226	648	210	1182
W5FDR	87	198	726	146	1157
W9QIL	65	125	885	79	1154
W3EML	96	158	673	136	1063
W4PL	15	29	929	10	983
W5MN	16	29	776	69	890
W4IR	17	67	668	29	781
W9EKQ	7	32	668	0	707
W1LWH	28	58	594	14	694
W9NFL	7	25	595	20	647
W3BWT	44	62	473	54	633
W5CEZ	34	146	416	24	620
W9YKH	44	50	494	23	611
W3CIZ	40	102	348	92	582

MORE-THAN-ONE-OPERATOR STATIONS

Call	Orig.	Del.	Rel.	Extra Del. Credit	Total
W5OW	400	515	1236	371	2522
KA1HQ	271	122	618	114	1125
W2SC	42	159	592	151	944
W9BNT	83	139	469	31	722
W1AW	53	251	157	242	703

These stations "make" the B.P.L. with total of 500 or over. One hundred deliveries + Ex. Del. Credits also rate B.P.L. standing. The following one-operator stations make the B.P.L. on deliveries. Deliveries count.

W2IOP, 300	W6MDI, 134	W8IHR, 113
W6PCP, 206	W9UN, 134	W2LZR, 110
W6LUI, 197	W6MFH, 131	W8QGD, 110
W6NRP, 174	W1JXP, 128	W2ITX, 107
W7APS, 159	W1FFL, 124	W6HH, 105
W6CFN, 146	W9THS, 118	W5DLZ, 102
	W6MQM, 114	

A.A.R.S.

MORE-THAN-ONE-OPERATOR STATION

Call	Orig.	Del.	Rel.	Extra Del. Credit	Total
WLM (W3CXL)	166	152	3300	66	3684

A total of 500 or more or 100 deliveries Ex. D. Cr. will put you in line for a place in the B.P.L.

* 233 Franklin, River Forest, Oak Park, Ill.

W1AW Operating Schedule

OPERATING-VISITING HOURS

3:00 P.M.-3:00 A.M. E.S.T. daily, except Saturday-Sunday.

Saturday — 8:30 P.M.-2:30 A.M. E.S.T.

Sunday — 7:00 P.M.-1:00 A.M. E.S.T.

OFFICIAL BROADCAST SCHEDULE (for sending addressed information to all radio amateurs).

Frequencies

C.W.: 1761-3825-7280-14,254-28,600 kcs. (simultaneously)

Starting Times (P.M.)		Speeds (W.P.M.)								
E.S.T.	C.S.T.	M.S.T.	P.S.T.	M	T	W	Th	F	Sat	Sun
8:30	7:30	6:30	5:30	20	15	25	15	20	—	20
Midnight	11:00	10:00	9:00	15	25	15	20	15	15	—

PHONE: 1806, 3950.5, 14,237, 28,600 kcs.

Each code transmission will be followed in turn by voice transmission on each of the above frequencies.

GENERAL OPERATION:

Besides specific schedules in different bands, W1AW devotes the following periods, except Saturdays and Sundays, to GENERAL work in the following bands:

Time, E.S.T.	Frequency
4:30 P.M.- 5:00 P.M.	28,600 kc. Fone/CW
6:00 P.M.- 6:30 P.M.	14,237 kc. Fone
6:30 P.M.- 7:00 P.M.	14,254 kc. CW
8:00 P.M.- 8:30 P.M.	14,254 kc. CW
9:30 P.M.-10:00 P.M.	3950 kc. Fone
10:00 P.M.-10:30 P.M.	14,237 kc. Fone
11:30 P.M.-12:00 A.M.	1761/1806 kc. CW/Fone
1:00 A.M.- 2:00 A.M.	3825 kc. CW
2:00 A.M.- 3:00 A.M.	7280 kc. CW
7:00 P.M.- 8:00 P.M.	Skeds on 80 meters.
10:30 P.M.-11:30 P.M.	Nat'l Trunk NCS 3670 kc.

At other times, and on Saturdays and Sundays, operation is devoted to the most profitable use of bands for general contacts and to participation in special week-end operating activities. The station is not operated on legal national holidays.

Give W1AW a call for an accurate frequency measurement, to communicate with any department of A.R.R.L., to rag-chew when time permits, or to pass a message to ham friends in other places or on other bands.

BRIEFS

Add father-and-son schedules: W8TLR, East Cleveland, Ohio, father; W8OYE, Springfield, Ohio, son.

A suggestion on how to locate small towns is offered by W6LCS, O.R.S. The Official Railway Guide lists alphabetically all points which are on a railroad. Opposite each town's name is shown the railroad or railroads on which it is located and the number of the time table in which the town appears; a map is shown for each railroad — and there you are. W6LCS points out that old R.R. guides are just as useful as new ones, and it is quite often possible to secure one from your local agent.

October '39 O.R.S.-O.P.S. Parties

THE October O.R.S. and O.P.S. get-togethers provided the usual good sport, with the scores bearing out this fact: 76 operators made scores of over one million points in the O.R.S. Party! W3BES again leads this group — unless the confirmation of essential details on W9VES' reported score (over 18 million) comes through. W8OFN has given the lads something to think about — placing second. In the O.P.S. group, W8FJU stepped into first place, followed by

W2HXQ. Congratulations to all the operators listed below.

The next quarterly O.R.S./O.P.S. Parties are scheduled for January 20th-21st. Plan accordingly, and don't miss out on the fun! Non appointees should take steps to look into the qualifications for appointments and get in on the many interesting activities enjoyed by the O.R.S. and O.P.S.

OFFICIAL RELAY STATION SCORES (OCT.)

Station	Score	Dif. Sigs.	Dif. Sects.	Heard	Power (Watts Input)	Operating Time
W3BES	17,003,808	224	48	14	200	30 h.
W8OFN	15,699,204	192	52	1	800	20 h.
W1TS	14,444,804	209	49	8	350	20 h.
W1JTD	11,550,000	184	47	36	150	20 h.
W9EYH	11,171,600	169	51	20	90	20 h.
W2HMJ	10,697,625	180	45	—	300	18 h., 25 m.
W4EV	10,070,306	151	51	18	300	18 h., 40 m.
W8JTT	9,436,929	167	52	36	125	19 h., 15 m.
W3DGM	8,292,500	168	46	25	40	20 h.
W8TNC						
(W2CTT op.)	8,080,368	166	47	6	700	17 h., 15 m.

Station	Score	Sigs.	Sects.	Station	Score	Sigs.	Sects.
W6RBQ	8,004,535	142	45	W5KC	3,673,655	112	43
W3GDI	7,036,016	147	45	W5AZB	3,701,308	113	45
W3GHM	6,815,340	145	44	W3HQX	3,460,860	113	40
W1EOB	5,820,870	146	40	W2LXI	3,375,112	130	36
W3GJY	5,179,920	150	41	W8SJJ	3,297,460	116	42
W8RMH	5,149,606	143	44	W8GBF	3,257,600	119	41
W2JKH	5,059,456	145	43	W3FLH	3,209,250	112	38
W6CIS	5,003,880	104	43	W6BAM	3,111,768	93	39
W9TQD	4,894,680	125	43	W6PGB	2,948,804	134	40
W7CMB	4,876,110	108	45	W3GUM	2,947,062	120	34
W8ROX	4,412,880	140	40	W3GYQ	2,888,912	114	38
W6PBV	4,028,135	99	40	W1KQY	2,730,896	119	40
W2KHA	4,008,788	139	35	W7GPP	2,707,968	90	38
W9ILH	3,968,803	112	45	W2LMN	2,625,036	98	40
W8LII	3,877,440	122	46	W5EWZ	2,602,404	96	42
W2KXF	3,711,360	122	38				

OFFICIAL 'PHONE STATION SCORES (OCT.)

Station	Score	QSO's	Sects.	Heard	Power (Watts Input)	Operating Time
W3FJU	6600	53	24	5	1000	7 h., 54 m.
W2HXQ	5740	45	20	31	200	7 h., 35 m.
W1FBJ	4104	42	18	9	500	5 h., 30 m.
W1COI	3621	39	17	9	400	6 h., 30 m.
W2DVC	3168	26	18	23	400	4 h., 30 m.
W2CHK	3120	30	15	29	100	5 h., 45 m.
W3HAL	2975	35	17	—	600	6 h., 15 m.
W8MBW	2924	30	17	11	150	3 h., 15 m.
W1KTE	2499	27	17	6	60	4 h., 34 m.
W8BFB	2144	24	16	7	250	5 h., 55 m.

Station	Score	QSO's	Sects.	Station	Score	QSO's	Sects.
W8KBJ	2100	28	15	W8EQN	1408	20	11
W2CET	2067	31	13	W1AAR	1352	20	13
W3BRZ	2025	21	15	W4BPD	1330	19	14
W3DRQ	2025	25	15	W3FPC	1298	16	11
W1EAO	2010	24	15	W6CHV	1260	15	14
W8BQA	1781	21	13	W8KSJ	1120	16	10
W7GNJ	1632	18	16	W4AAK	1068	17	12
W3OQ	1625	21	15	W1ATE	1053	15	13
W1GZL	1548	19	12	W2FMX	1034	16	11
W9TRN	1470	18	15	W1KZU	891	15	11

High 1939 "SS" Scores

"C Q SS" — the "call heard 'round the world"!!

What a contest it was! The 10th A.R.R.L. Sweepstakes has left an impression that will take more than time to erase. Even now, two weeks later, the smoke has not yet cleared away from the field of battle: tuning through the various bands we still hear, "How was your score?" . . . "Made XXXXX points here." . . . "How did WXXXX make out?" . . . etc. We won't attempt to estimate the total participation, but the number of reports received to date indicates a previously unequalled figure. Logs have so far arrived from more than 850 operators, and they are still coming, in big batches, every mail. Knowing that everyone is anxious to know how some of the gang made out, we're listing the "claimed scores" of a bunch of the high pointers. Note that W1TS and W8DOD on c.w., and W9RBI and W2HXQ on 'phone, claim all 64 sections worked (the total is 64 since the 7 VE sections are off the air). W1TS worked all sections on the first week-end! Many operators worked all states in the contest. W8LEC on the second week-end made WAS in a total elapsed time of 22 hours, 45 minutes, with less than half of that time actually spent as operating time! And he did it all on 14 Mc. Additional records undoubtedly will come to light later. The complete official results are scheduled for April QST. The listings following show score, stations worked and sections worked, in that order:

W9UYD	13197-125-53	W1JNX	12341-144-43
W5DYT	13160-141-47	W6CHV	12000-100-48
W7GNJ	13008-136-48	W3GWQ	11045-118-47
W6QOZ	12690-143-45	W8JM	10165-114-38
		W6IMV	10105-111-47

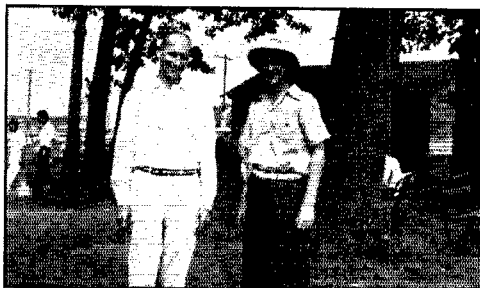

The New Jersey S.C.M.'s

Pat Jessup, W2GVZ (left) and Les Allen, W3CCO (right) took office as S.C.M.'s for the Northern and Southern New Jersey A.R.R.L. Sections, respectively, in the early summer of 1939. Asst. S.C.M. Ed Raser, W3ZL, snapped the photo at the Delaware Valley Radio Ass'n Outing at Trenton, Aug. 6, 1939. "Pat" is active in practically every phase of ham radio, being an E.C. and R.M., member of the DX Century Club, ardent rag-chewer, and a heavy traffic handling O.R.S. "Les," who does most of his operating on 'phone, is also a busy man as president of D.V.R.A., attending to the multitudinous tasks of an S.C.M., issuing bulletins for the S.N.J. ORS Net and the Section, etc. Two real hams, both doing a "crackajack" job as S.C.M.!

Contest Score Corrections

We are advised by the VE/W Contest committee that W2GSA's correct score in that contest was 27,082 (138 contacts). This makes GSA the second highest scoring W operator.

In the '39 Field Day results the score of W3RR/3 should have been listed as 1002 (88 contacts) instead of 534.

Winner of the club certificate for the Antwerp Radio Club, ON4BC, in the '39 DX Contest was ON4IF, rather than ON4PW as indicated in Oct. QST. Additional information received after the DX contest results were published have made possible club awards in the Dayton Amateur Radio Ass'n and the Birmingham Amateur Radio Club. W8CED won a c.w. club certificate in the D.A.R.A. W4ECI won the c.w. certificate, W4ERX the 'phone award, in the B.A.R.C.

The October meeting of the Western Slope Radio Club (Grand Junction, Colo.) was held at Grand Mesa, highest flat top mountain in the world — 10,000 ft. high, 200 lakes, 26 square miles. Among those in attendance were W9GLT, W9OSD, W9MGX, W9GKW, W9GMB and M. E. Erickson, club president.

New Mexico Weather Net

W5HAG heads the newly formed New Mexico Weather Bureau Net. Under supervision of the U. S. Weather Bureau station at Albuquerque, weather, crop and river level information is supplied efficiently from all parts of the state by amateur radio.

Brad Martin, W3QV, Director, A.R.R.L. Atlantic Division, was laid up in the hospital for quite a period during November. Hospital visits are not an unusual thing, but for Brad it represented the first time since getting his ham ticket that he had been off the air for as long a time as one week. And Brad got the call 3QV in April 1920. That is certainly a record for continuous activity!

C. W.		W3DMQ	46000- - - -
W2IOP	101500-653-63	W3GHD	46000- - - -
W9FS	99735-654-61	W3GDI	45820-317-58
W3BES	97000- - - -	W2LXI	45630-352-52
W8OFN	96797-626-62	W1BII	45600-383-60
W2GSA	94472-610-62	W6NLZ	45360-305-60
W1TS	83120-520-64	W7EK	44820-374-60
W8DOD	82800-523-64	W3BKZ	44368-378-59
W8OKC	77216-526-59	W1KFN	43120-392-44
W7CMB	76151-485-63	W3FSP	42798-323-53
W8NLQ	76125-525-58	W6MUO	42630-295-58
W9RSO	76097-499-61	W7GPP	42487-315-55
W9YCF	70293-457-62	W9WTW	42240-353-60
W2HHF	70009-451-63	W3GET	42000- - - -
W3ATR	67270-451-56	W2IRV	41918-312-54
W3GHM	67000- - - -	W7UQ (W9AHR, op)	41850-271-62
W3FRY	63000- - - -	W8SBV	41310-306-54
W1EOB	62221-408-61	W3KT	41000- - - -
W9YTH	62220-408-61	W9MIN	40745-281-58
W4CYC	61878-420-59	W3HLZ	40530-387-42
W1KQY	61180-437-56		
W1ICA	61076-401-61	'Phone	
W3GRF	60000- - - -	W6ITH	55800-450-62
W2JKH	59500-425-56	W9RBI	44504-280-64
W8JTT	58725-406-58	W6QEU	37250-302-50
W2GUP	57348-486-59	W5BB	31124-252-62
W2AYJ	57000-397-58	W9YQN	31000-250-62
W3AGV	57000- - - -	W6DTB	29610-235-63
W8NCJ	55825-385-58	W9ZTO	27592-242-58
W9GKS	55676-356-63	W2JUJ	25300-232-55
W9YXO	55370-399-56	W2HXQ	24448-191-64
W3FLE	55000- - - -	W9NDA	23790-196-61
W8OQF	54312-438-62	W6AM	23659-201-59
W9VBQ	54290-357-61	W7HEY	22880-211-55
W6AXC (W6BRR, op)		W9UVA	21862-165-55
	53485-346-62	W9ZVX	21708-204-54
W8OXO	53350-390-55	W1ATE	21417-184-59
W9ERU	53238-467-57	W9PNX	21340-194-55
W3GJY	53000- - - -	W4DRZ	18821-163-59
W8LCN	51584-417-62	W6FUO	17808-168-53
W6PBV	50250-338-60	W3HDJ	17690-153-58
W6PCE	48825-316-62	W9ZIX	17600-161-55
W9BQJ	48400-352-55	W9GDB	15480-137-48
W4CEN	48203-411-59	W9KQX	15360-130-48
W1UE	47925-321-60	W9KOH	15126-181-46
W9MGN	47250-316-60	W7FQT	14750-154-50
W7JC	47100-398-60	W9ADJ	13464-132-50
W8PSR	46480-332-56	W8CWY	13409-128-53
W9AOB	46207-306-61		



How's DX?



HOW:

Ob's blood, but you chaps are persistent! Knowing full well that DX is so low it has to stand on a box and reach up to touch bottom, you are still tenacious enough to sneak a squint at the pillar, in the faint hope that someone uncovered something you missed. Well, a few of them did, but mostly it's mighty tough going.

All of which reminds us that this might be a very good time for you to catch up on your QSL cards. A lot of our amateur friends in the belligerent and near-belligerent countries have only their fond memories and an occasional radio magazine to keep up their interest and ham spirit, and we feel certain that an odd card or two showing up everytime the postman always rings twice would help a lot. A few of them have their receivers and listen to their old friends, but a card or two would be a tangible thing that would bring a lot of pleasure to our DX friends. Oh, sure — you're just like we are — you don't owe anyone a card. (Jeeves, I did too QSL those fellows!)

That fellow we mentioned last month as having offered the W1 QSL Manager some gear for cards apparently can't take it. He got real sore when he read about it on this page and wrote to W1BGY, threatening him with all sorts of dire this and that. That's the sort of fellow we'd expect to find trying to buy his way into the DXCC but, when it comes to a showdown, all our chips go on the Manager. And why pick on BGY? — we made the cracks.

WHERE:

IF THE guy's really OK, WITS pulled a nice one by working **KH6RZQ** (7000-7025 T9), who came through the other yawning between 2 and 4 A.M. The story he told was that he uses 10 watts input and an 8-wave-length Vee, and had only been on a few days. We hope he's legit, because we'd heard that it isn't too easy to get a license out there in Samoa Just so the cards won't continue to come in, don't confuse the Kwantung that **XU6W** gives for a location with the Kwantung of **J8PG** (14,300 T7) — they aren't the same place and the **XU** rates with the rest of China — the **J8P** is a separate country **XUIA** (14,340 T8c), who comes through in the early evening, gives his address as Provincial Health Center, Ninghia, Inner Mongolia, which, if true, would make him the long-sought-for Mongolian and a new country. Inner and Outer Mongolia both rate as Mongolia on the list. **W2ZA**, **W2BHW**, **W2BJ**, **W8CRA**, **W8OSL** and **W2ARB** were among those who snagged him There is plenty of evidence, presented mostly by **W2GT** and **W2AVO**, to indicate that **AC4JS** was in Tibet and not in China as rumored last month. No cards as yet, however Mail has been returned from the addresses given by **FF3Q**, **VS9BC** and **YA5UR** Even Jeeves agrees with us about **ZB4UC**, so it should be easy to cross him off the list Some of the gang are going to be disappointed to learn that they didn't work **LZ1ID**, but the signal that was active with that call around early October wasn't the real guy and wasn't in Bulgaria. He was in Europe, near there, but got a little too anxious **W1ZI** worked **UX1CP** (14,400 T9) at 23 GT, which should be enough tip if you missed Franz Joseph Land when he was on before. QSL via **C.S.K.W.** (and keep your fingers crossed!) Don't waste your time on **PZ6ZK** **W8PQQ** got a letter from **VR4AD** saying he was going to Ocean Island, which should give us all a crack at **VR1** when the lads get back on **SM5XH** has a nice letter and, among other things, confirms your suspicion that **TA1AA** was just another one for the red side of the ledger.

WHEN:

FORTY was almost as good as 20 last month — which isn't saying much for either. **W4MR** worked **HA8D** (7020) and **W1MEC** (the latest HQ 25-hours-a-day ham)

worked **HA7YL** (7115 T6) around midnight, while **W1TS** grabbed off the **KH6** we told you about. Speaking of the Pacific Islands, **W3CWQ** thinks these lads out there might well do a bit more listening, since they come through back east well around midnight **W7GZN** head **D4BRJ** (7030 T9) at 8 P.M.

It's possible to scare 'em up on 20, but not as easy as it once was **W4EV**, whom you used to know as **W4APU**, has his finger in the pie again and comes out with **EATAV** (14,370 T9), **PK1AC** (14,300) **K5AX** (14,330) in Panama and **LXISS** (14,230), while hearing such worthies as **CP4CD** (14,400 T7) and **OQ5BA** (14,275 T9) **W7FOG** reports working **U9MN** (14,350 T8), **XU6K** (14,370 T9) and **KB6RWZ** (14,385 T9), and hearing **D4BRJ** (14,360 T9) **W2GUM** has a nice list which includes **XUBWS** (14,400), **J2OV** (14,400) and **J3DG** (14,400) worked in the evening, and **U7A** (14,370), **XU8MI** (14,350), **XU8HM** (14,400), **XU6DX** (14,275 T8e), **XU5HR** (14,370 T7), **XU4A** (14,360), **XU2MC** (14,350), **J3FP** (14,375), **J8CH** (14,370), **PK1TT** (14,360), **KA1FG** (14,340), **KA1PO** (14,345), **KB6RSJ** (14,380) and **CR6AI** (14,360) during the early watch **W2HEHF** is in with his usual fine dope, including **KAIWW** (14,340), **UK9AN** (14,400 T6), **U4AL** (14,370), **U4AM** (14,360 T7), **KALJM** (14,310), **XUORK** (14,360), **OQ5HM** (14,380), **U9AW** (14,370 T8), **XU5HN** (14,300), **XU0A** (14,290 T8), **KAIER** (14,350), **KAILB** (14,270), **CR6AF** (14,300), **HS1BR** (14,385), **XU5LT** (14,290), **J2MH** (14,400) and **KAI8N** (14,280), **CT4AA** (14,400) and **PK3AC** (14,350 T8) were heard **W8PQQ** received cards from **LX1RB** (14,350 T9x), **LX1SI** (7050 T9x), **J9CA** (14,380 T9x) and **J8CG** (14,380 T9x), in case you were wondering about any of them.

*PHONE:

W1WV has been putting in some time on 10 'phone, and passes along the word that pickings aren't too bad down there, what with **OQ5AB**, **HA1K**, **EA7BB**, **HC2CG**, **HC2CC**, **LU7DQ**, **LU9BV**, **T13AV**, **T12RC**, **CE3AG**, **HC1JB**, **PY2AK**, **YV5AK** and **CE3CZ** on **W6KYL** says that out his way **XU8MC**, **XU8RJ**, **XU8AM**, **KAI1Z**, **KALME**, **KAI1BB**, **KAI1AP**, **KAI1ER**, **KAI1ML**, **J2KN**, **J8CI**, **J2XA** and **J3CX** are all on 10 **W6ITH** adds **YN3DG** (28,150), **PY1AZ** (28,060), **J3FZ** (28,150), **VY1AQ** (28,200), **CE1AH** (28,290), **XU8ZA** (28,120), **XE1CQ** (28,340) and **TC9AA** (28,350) to the above.

On 20, the only dope we have is from **W6ITH**, who says his new rhombics are really laying down a signal. The stuff worked includes about everyone on the air: **CE3AG** (14,150), **LU7BK** (14,085), **CE3CK** (14,010), **CX2CO** (14,070), **LUSAN** (14,050), **CE3AC** (14,010), **CE3EW** (14,090), **LU6DJ** (14,075), **J2NQ** (14,040), **K7HCX** (14,240), **KAILZ** (14,150), **J2NG** (14,110), **EK1AF** (14,070), **CE1AH** (14,040), **OA4C** (14,265), **HC1CC** (14,200), **CX2BK** (14,120), **K4FKC** (14,155), **PY2AC** (14,150), **LU5EZ** (14,000), **LUSKA** (14,005), **OA3D** (14,065), **TI4AC** (14,050), **LUSAB** (14,040), **OA4AI** (14,015) and **J2XA** (14,145).

The second 'phone station to reach the 100 mark in the CC is none other than **Larry Barton**, **W60CEH**, which, for our money, represents plenty of work, no matter how you look at it. Nice going, mister!

WHO:

W6LPX MADE his WAC with 45 watts to a 6T.6G Anyone who hasn't received his card from **E16G** can get it by writing to **W4CEN**, who has the cards and log of the Irish ex-ham **XU4XA** is apparently off the air for good, or at least until he returns to W, says **W2GT** **VU7BR** QSL-ed all of his contacts, so if you don't receive his card after a reasonable time, try again.

(Continued on next left-hand page)



SINCE the very beginnings of radio, the amateur has had a brilliant record of achievement. There has been outstanding pioneering, such as the exploitation of the wavelengths below 200 meters fifteen years ago. There has been skillful research, like the important work on the DX characteristics of the ultra-high frequencies now being done. There have been great inventions, such as the single-signal super from the laboratories of the ARRL. The list is long and impressive.

In addition, technical improvement has been matched by the development of operating skill. Amateurs have shown their resourcefulness in emergencies, establishing life-saving communication networks under conditions that seemed hopeless and cooperating heroically with relief organizations. The value which the Army and Navy place on the amateurs' skill is witnessed by the Army-Amateur Net and the Naval Reserve. And few explorers would care to set out on an expedition without first enlisting amateur help.

This is the brilliant record of the past, but with the new year, a new page in history is turned. What of the future? At the moment, it may appear dubious, but the future is probably FB. Amateur radio is immeasurably stronger than it was twenty-five years ago, when the World War threatened to put it permanently out of existence. It has many friends, a strong organization, and history of achievement. It has capable leadership by men who are proud of a great tradition. We do not doubt their ability to steer the ARRL through the stress of war time, nor do we doubt that amateurs will give them the cooperation that is essential to their success. The future of amateur radio lies in the hands of the "W's", and we are confident that it is safe.



While we are handing out the laurel wreaths, we should like to pass one to the dealers, too. It seems to us that they deserve a lot of credit. Many of them are amateurs, and out of their wealth of experience they have helped many a budding ham to get well started. Generous of their time when an amateur wants to talk over his problems, and quick to meet his needs, they are far more than just merchandisers. We think their service to amateur radio has been very real.

*To them, to the League, and to all Hams in every land,
we wish a Merry Christmas and a Happy New Year*

W. A. READY



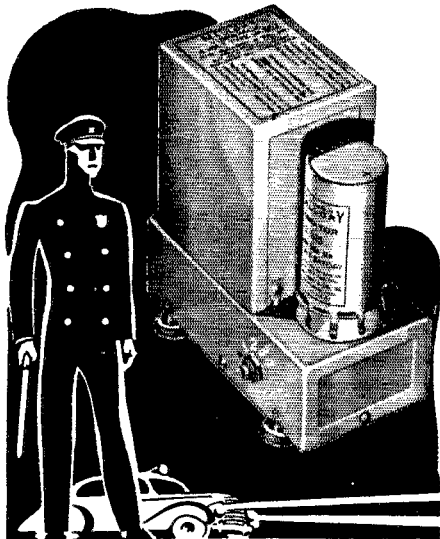

P. R. MALLORY & CO. Inc.
MALLORY Vibrapacks
(TRADE MARK REG. U. S. PAT. OFFICE)
**are on 24 hour patrol duty with
 the Baltimore Police Department**

Forty-two Mollory Vibrapacks are in service in the Patrol Cars of the Baltimore Police Department. Powering police receivers on a 24-hour-a-day schedule, these vibrator power supplies are making new records for dependability, economy and efficiency. This performance is not an isolated instance, but is a duplication of the satisfactory operation of thousands of other installations. It is not hard to understand why Vibrapacks are so popular. They provide:

1. Maximum dependability.

Indispensable in police, sheriff, fire department and government applications; valuable in amateur and non-commercial installations; the conservative design, careful workmanship and fine materials of Mollory Vibrapacks insure their reliable, consistent performance.

2. Low service cost, minimum time out for service.

The only part of a Vibrapack which normally ever wears out or requires replacement is the long-life, heavy-duty vibrator. When required after an extended period of service, vibrator replacement can be made in a moment—no tools required.

3. High efficiency.

This means lower drain on the storage battery, longer battery life, less battery servicing, longer periods of operation between charges and a lower charging rate for the car generator.

4. Lower first cost.

An important consideration in this day of restricted budgets. Mollory Vibrapacks are made in 6, 12, and 32 volt models, with outputs up to 60 watts. Get your free copy of the Vibrapack Technical Data Sheet Form E-555-B. Ask your Mollory-Yaxley distributor, or write

P. R. MALLORY & CO., Inc.
 INDIANAPOLIS INDIANA
 Cable Address—PELMALLO

Use
P. R. MALLORY & CO. Inc.
MALLORY
 APPROVED RADIO
 PRECISION PRODUCTS

Use
YAXLEY
 APPROVED RADIO
 PRECISION PRODUCTS

He's pretty good about those things W4ZZ is off on a trip to the West Indies and plans to drop in on as many of the gang as he can find W2GVZ says a law-abiding ham is one who calls a dubious DX station and then hopes it doesn't answer! As far as that goes, a DX man is one who has the cards to prove that such a thing as DX used to exist. Remember?

— WJPE

— —

A.R.R.L. DX Century Club Rules

(1) All contacts must be made with stations working in the authorized amateur bands using amateur calls.

(2) In cases of countries where amateurs are licensed in the normal manner, credit may be claimed only for stations using regular government-assigned call letters. This shall not militate against claimed credits for contacts prior to publication of this section that might otherwise have been claimed earlier. No credit may be claimed for contacts with stations in any countries in which amateurs have been temporarily closed down by special government edict where amateur licenses were formerly issued in the normal manner.

(3) QSO's taking place after December 15, 1939, with any stations in any countries included in any Proclamation of Neutrality of the President of the United States of America, shall not count for Century Club credits. The countries listed in such proclamation are: Germany, France, Poland, United Kingdom, India, Australia, Canada, New Zealand, and Union of South Africa. If further countries are added to this list by the President, QSO's with those countries shall not count from effective date of such additional proclamation.

(4) All stations contacted must be "land stations" . . . contacts with ships, anchored or otherwise, cannot be counted.

(5) All stations must be contacted from the same state or call area, where such areas exist, or from the same country in cases where there are no call areas.

(6) The A.R.R.L. list of countries, printed periodically in QST, will be used in determining what constitutes a "country." (January, 1939 QST, contains the A.R.R.L. list.)

(7) In cases of countries no longer in existence, credit will be allowed for these, if they were recognized as separate countries by A.R.R.L. at the time of contact.

(8) Confirmations must be submitted direct to A.R.R.L. Headquarters for all countries claimed. Confirmation from foreign contest logs may be requested in the case of the A.R.R.L. International DX Competitions only, subject to the following conditions:

(a) Sufficient confirmations of other types must be submitted so that these, plus the DX Contest confirmations, will total 75 or more. In every case, contest-confirmations must not be requested for any countries from which the applicant has regular confirmations. That is, contest-confirmations will be granted only in the case of countries from which applicants have no regular confirmations.

(b) Look up the contest results as published in QST to see if your man is listed in the foreign scores. If he isn't, he did not send in a log and no confirmation is possible. Logs for the 1935, 1936, 1937, 1938 and 1939 contests only are available. Results of these contests appear in the September, 1935; September, 1936; October, 1937; November, 1938; and October, 1939 issues of QST.

(c) Give year of contest, date and time of QSO.

(d) In future DX Contests, do not request confirmations until after the final results have been published, usually in one of the early fall issues. Requests before this time must be ignored.

(9) In accordance with the Century Club policy as outlined in the How's DX department, April, 1939 QST, all confirmations must be submitted as received from the stations worked. Any altered or forged confirmations submitted for C.C. credit will result in disqualification of the applicant from QST listings as well as from membership in the club. Any Century Club member submitting forged or altered confirmations must forfeit his membership.

(10) Contacts may be made over any period of years, and may have been made any number of years ago, provided only that all contacts be made from the same state or call area (or country, where no call areas exist) and by the same station licensee; contacts may have been made under different call letters in the same area (for country), if the licensee for all was the same.

(Continued on next left-hand page)

The 100% ham Receiver!



HQ-120-X

EVERY receiving problem confronting the radio amateur was carefully analyzed during the design of the "HQ-120-X." Three very important features were the result of this analysis. Variable crystal filter selectivity for phone as well as CW reception has had the effect of more than doubling the width of the amateur phone bands. This high degree of selectivity cuts down background noise and hiss as well as general QRM. The next important feature is the calibrated band spread dial making it easy to spot stations with a remarkable degree of accuracy. The third

feature is the antenna compensator. With this control, the operator is assured of peak efficiency at all times, even with the simplest form of antenna. Your local Hammarlund dealer will be pleased to demonstrate these as well as other outstanding features of the "HQ-120-X."

WRITE FOR BOOKLET!

HAMMARLUND MFG. CO., INC.
424-438 W. 33rd Street, New York City

Q-1-40

- Please send 16-page booklet (HQ)
- Please send "40" catalog

Name.....
 Address.....
 City.....State.....

Canadian Office: 41 West Ave.
No., Hamilton, Ont.



HAMMARLUND



“What!

No Pyranol Capacitors?”

Better look again, OM, because G-E Pyranol capacitors are small—so compact that your sock could hold several. If you didn't get some—well—the next best thing is to trot out the dog team and mush to the nearest G-E dealer. He'll *gladly* supply you with these top-quality transmitting condensers, because he *knows* they'll give you satisfaction.

G-E Pyranol capacitors are built to rigid specifications, individually tested, guaranteed to operate at 10 per cent above rated voltage. They're reasonably priced, too.

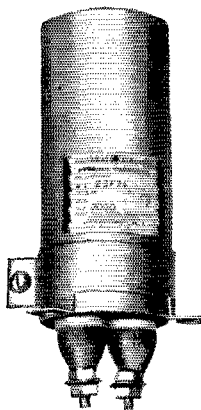

A new bulletin, GE-2021B, gives you all the latest dope, including sizes, and details of both upright and inverted mountings. Get a copy from your dealer, or write to General Electric Co., Radio and Television Department, Schenectady, N. Y.

GENERAL ELECTRIC

900-25

(11) The Century Club award and QST listings for confirmed contacts with 75 or more countries is available to all active amateurs, everywhere in the world.

(12) Following the first listing of any station in QST, confirmations from additional countries may be submitted as received, and the original listing will be changed in subsequent lists.

(13) Stations reaching the 100-confirmations mark will automatically be enrolled in the DX Century Club.

(14) Sufficient postage for the return of confirmations must be forwarded with the application. In order to insure the safe return of large bunches of confirmations it is suggested that enough postage be sent to make possible their return by *First Class Mail, Registered*.

(15) Address all applications and confirmations to the Communications Department, A.R.R.L., 38 LaSalle Road, West Hartford, Conn.

(16) In submitting confirmations they should be accompanied by a list of claimed countries and stations representing each country to aid in checking and for future reference after your confirmations have been returned to you.

We are again printing the Century Club rules, with clarification of certain points, since it has been some time since this information appeared in QST. Kindly refer to the above in preparing to submit confirmations. This will answer practically every question you may have. The rules as they now stand are effective with publication of this issue of QST.

— . . . —

Virginia Hams Serve

Virginia radio amateurs were active in furnishing communication for the Norfolk & Western R. R. on November 5, 1939, during a heavy snowstorm which blanketed the Shenandoah and eastside valleys west of the Blue Ridge. W3BIG, Shenandoah, Va., with 16 inches of snow and all regular communications methods cut off, came on the air at 9:30 A.M. and handled all communication for the N. & W. until regular lines were restored in the afternoon. All a.c. power was off in Shenandoah from 10:00 to 11:30 A.M. W3AVL, Waynesboro, with 12 inches of snow and the same conditions as in Shenandoah, handled traffic for both the N. & W. and Western Union. W3BTM, Roanoke, handled all traffic from W3BIG and W3AVL, maintaining direct telephone communication with the N. & W. Roanoke dispatchers' office. W3AHQ, Staunton, when power went off in Shenandoah, started for that city with emergency equipment, stopping at W3DWE and W3EPK for additional gear; he was held at W3EPK by word that power had been restored. W3CNY, Roanoke, went to Shenandoah on work train to help with communications. W3AVL, Waynesboro, met the train carrying W3CNY, with a portable transmitter for use in Shenandoah. The following participated in relaying messages and clearing the frequency used: W3AIJ, W3AJA, W3DPV, W3DWE, W3EPK, W3FBR, W3FGJ, W3GWQ, W3UVA.

— . . . —

A.R.R.L. Code Practice Stations

The following amateur stations are transmitting code practice on regular schedules, as listed:

Station	Frequency	Days	Hours
W1JVB Conn.	1808 kc.	Tues. & Fri.	8:00-8:30 P.M. EST
W1JNU Mass.	1978 kc.	M-T-T-F	6:30-7:00 P.M. EST
W3BFE Maryland	1888 kc.	Mondays	8:00-8:30 P.M. EST
W3HBE Delaware	1915 kc.	Fridays	6:00-7:00 P.M. EST
W6DPT Calif.	1700 kc.	Mon. & Thurs.	7:30-8:30 P.M. PST
W6HUX Calif.	1960 kc.	Mon. & Fri.	7:30-8:30 P.M. PST
W8CBI Ohio	1900 kc.	Tuesdays	6:30-7:30 P.M. EST
W8NQS Michigan	1952 kc.	M-T-W-T-F	7:50-8:10 A.M. EST
W8QBU New York	1815 kc.	Wednesdays	7:30-8:00 P.M. EST
W8RFM Penna.	1814 kc.	Mon. Wed. Fri.	6:30-7:00 P.M. EST
W8SDO Ohio	1989 kc.	Mondays	6:30-7:30 P.M. EST
W9BB Nebraska	1950 kc.	M-T-W-T-F-S	7:00-8:00 P.M. CST
W9BSP/UA Kans.	1903 kc.	Daily	7:30-8:30 P.M. CST
W9CEJ Kansas	1921 kc.	Tues., Thurs.	8:30-7:30 P.M. CST
W9MWU Illinois	1919 kc.	M-T-W-T-F	5:00-5:45 P.M. CST
W9NAA Indiana	1875 kc.	M-T-W-T-F	6:30-7:30 P.M. CST

Attention is also called to the "Official Broadcast Schedule" of A.R.R.L. Headquarters station W1AW (elsewhere in this issue). These W1AW transmissions are sent at constant rates of speed and provide good practice, especially for the man who wishes to get beyond the 13 w.p.m. stage.

3 BRAND NEW AMPLIFIERS

FEATURING CATH-O-DRIVE *Modulation*

*With Adaptations for
PLATE MODULATION and P.A. WORK*

DESIGNED AND ENGINEERED BY TEMCO
Manufacturers of Quality Amateur Gear

A FEW OF THE MANY FEATURES

- Incorporates a peak limiter.
- Output taps from 40 to 3000 ohms in practical steps.
- Can be used for a driver for a higher powered stage.
- Real "Professional" appearance.
- Extremely Economical! Build it yourself and use some of those "spare parts".
- Interchangeable Output transformers make these kits **UNIVERSAL***

*Complete chart shows the many applications possible. See Special literature at your jobber's for a correct transformer to suit your application.

THE KENYON '50'

(See top illustration.) Uses 6F6-6SF5-6H6-6SJ7-80. Conservatively rated at 5 watts Class A, 110 db Gain. Basic kit consists of Par-Metal punched deluxe chassis with screen cover and 5 KENYON QUALITY TRANSFORMERS. Amateur net price of Foundation Kit.....\$18.75

THE KENYON '150'

(See middle illustration.) Uses 6SJ7-6C5-6H6-80-pp6V6. Conservatively rated at 15 watts Class AB, 110 db Gain. Basic kit consists of Par-Metal punched chassis, sloping front cabinet and 6 KENYON QUALITY TRANSFORMERS. Amateur net price of Foundation Kit.....\$22.78

THE KENYON '600'

(See bottom illustration.) Here is a real amplifier designed for broadcast but available for the first time at a real saving. Uses 6SJ7-6SF5-6N7-6F6-6H6-pp6L6-82-83. Power supply on separate chassis reducing all possibility of hum pick-up. Smart, modern with up to the minute circuit design. Rated at 60 watts output 125 db gain with pp6L6's operating class AB-two. Basic kit consists of Par-Metal punched chassis, amplifier screen cover, sloping front cabinet and 7 KENYON QUALITY TRANSFORMERS. Amateur net price of Foundation Kit.....\$35.13

All three KENYON AMPLIFIERS are modern in design with sloping front cabinets. Your jobber can supply you with the basic kits as well as all other needed parts. Complete literature, parts list and data sheets are also available. If he cannot supply you, write us direct giving us his name and we will see that your order is filled.

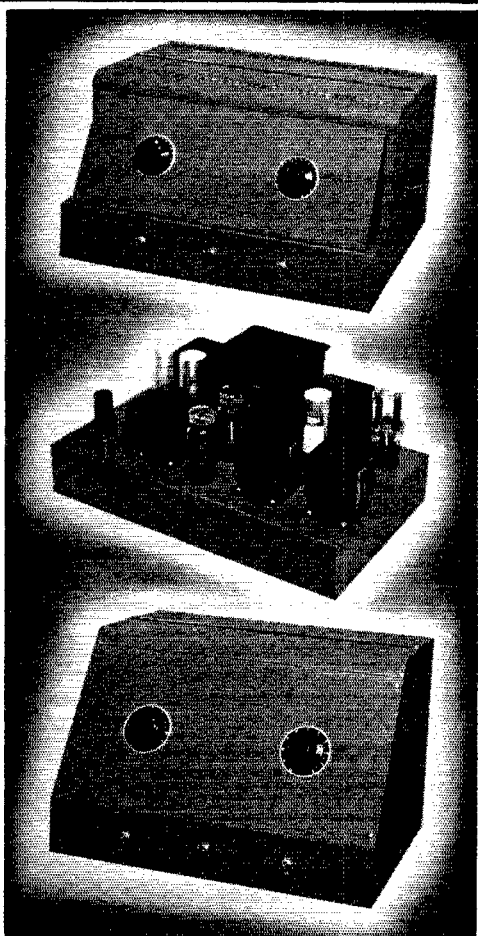

KENYON TRANSFORMER CO., Inc.

840 BARRY ST., NEW YORK, N. Y.

Export Department: 25 Warren St., New York, N. Y.

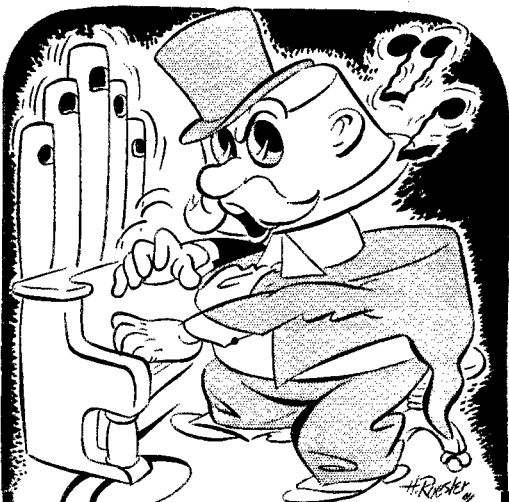

Sweet and
(WITH ACCENT ON THE)
LOW

"When the organ plays at twilight" can you still hear the LOW notes when the volume is turned down?

With Old Man Centralab at the console you get true tone compensation . . . for his Standard and Midget Radiohms are available with 1, 2, 3 taps to match the original control.

Wherever tapped controls are indicated be sure to use Centralab with the long straight resistor strip that gives smooth accurate attenuation throughout the entire circumference.

Old Man Centralab suggests:
With short wave listening on the up, Centralab Wave change switches do the trick . . . better.

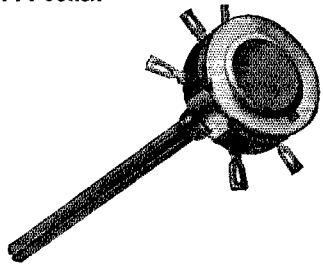

Centralab
DIVISION OF GLOBE-UNION INC.
Milwaukee, Wisconsin

MEMBERS, DX CENTURY CLUB

W6GRL..... 147	G5BD..... 115	W3BEN..... 104
W8CRA..... 144	W9KA..... 114	W1GDY..... 104
G6WY..... 144	G5RV..... 114	W1GCK..... 104
W2GT..... 144	W8BKP..... 114	W9CWV..... 104
W2GTZ..... 142	W1WV..... 114	W2BMX..... 104
W1TW..... 141	W2DC..... 114	W8LFE..... 104
W2GW..... 141	G2DH..... 114	G6KP..... 103
W6KIP..... 140	G5BY..... 114	W8KKG..... 103
W9TJ..... 140	W2CJM..... 113	J2JJ..... 103
W8DFH..... 139	W4DRD..... 113	W5CUJ..... 103
W1SZ..... 137	W8MTY..... 113	W3KT..... 103
ON4AU..... 137	G6CL..... 112	W1ZI..... 103
G2ZQ..... 136	W6GAL..... 112	W8DOD..... 103
W3EMM..... 136	W3EVT..... 112	W9NNZ..... 103
W6CXW..... 135	W4CYU..... 112	W2GNQ..... 103
W1TS..... 134	W3GAU..... 112	W4IO..... 103
W1LZ..... 133	W1ADM..... 112	W3GEH..... 103
W5VU..... 133	W8QXT..... 112	W6AHZ..... 103
G6RH..... 132	W2AAL..... 111	W4CBY..... 102
W8BTI..... 132	W3BES..... 111	W8AU..... 102
W4BPD..... 132	ON4UU..... 110	W8OXO..... 102
W8DHC..... 131	PA0XF..... 110	W1FTR..... 102
W2BHW..... 131	W6FZL..... 110	W2BXA..... 102
W5BB..... 130	VE2AX..... 110	W1GNE..... 102
W3CHE..... 130	W2DSB..... 110	W4BVD..... 102
HB9J..... 129	W9UM..... 110	W2AV..... 102
W8OSL..... 129	W2AER..... 110	W3ZX..... 102
W2CMY..... 129	W81WI..... 110	F8RJ..... 101
W1FH..... 128	W5QL..... 110	VK3KX..... 101
W3EPV..... 128	W2IYO..... 110	W6DOB..... 101
W8OQF..... 127	W3DDM..... 109	SU1WM..... 101
W8ADG..... 127	W6FZY..... 109	W8EUY..... 101
W9KC..... 126	W2GRG..... 109	W1CC..... 101
W2UK..... 126	W3FQP..... 109	SU1SG..... 101
W2HHF..... 126	W6HX..... 108	G6MK..... 101
W9ARL..... 125	ZS2X..... 108	W6AHZ..... 101
W2ZA..... 125	W1DUK..... 107	W4MR..... 101
W1DF..... 124	W2CBO..... 107	W6GHU..... 101
W2JT..... 124	G5BJ..... 107	W6BAM..... 101
W8DWW..... 123	VK2DG..... 107	W6KWA..... 101
W8LEC..... 123	W7DL..... 107	W1RY..... 101
W4CFN..... 123	W6MVK..... 107	W4EQK..... 101
D4AFF..... 123	VK3QK..... 107	VK6SA..... 101
W8NJP..... 122	W1BXC..... 107	G6NF..... 100
W9TB..... 122	W1IAS..... 107	W6KRI..... 100
W3EDP..... 121	G2TR..... 106	W9UQT..... 100
W8JMP..... 120	W1CH..... 106	VEEE..... 100
J5CC..... 120	W3AG..... 106	VK2AE..... 100
W2GVZ..... 120	W6TJ..... 106	HLGX..... 100
W9GDH..... 119	HB9GC..... 106	HBX..... 100
W1JPE..... 119	W1BGC..... 106	W9RCQ..... 100
W3FRY..... 119	G2MI..... 106	ZL1MR..... 100
W1BUX..... 118	VE3QD..... 106	PA0QF..... 100
ZL1HY..... 118	HB9CE..... 106	W8BSF..... 100
W9ADN..... 118	W2VY..... 106	D3BMP..... 100
W9FS..... 118	W2OA..... 105	W3AGV..... 100
W7AMX..... 117	G5QY..... 105	W8JTW..... 100
W9PST..... 117	VK3CX..... 105	W8HGW..... 100
W1AXA..... 117	W1ICA..... 105	W8JAH..... 100
W3EVW..... 116	W2IOP..... 105	W9LBB..... 100
W5KC..... 116	W4TO..... 105	W4CCH..... 100
W2BYP..... 116	W8LYQ..... 105	W2ARB..... 100
W6ADP..... 115	W9RBI..... 105	W5ASG..... 100
W9EF..... 115	E15F..... 104	W2ARB..... 100
VK5WR..... 115	W1ZB..... 104	W8JIN..... 100
W2CYS..... 115	W4AJX..... 104	W2AZ..... 102
WIHX..... 115	F8RR..... 104	W6OCH..... 100

The following have submitted proof of contact with 75-or-more countries: W8AAJ, W9VDY, W8QDU, W9AJA 99; W2ALO, W2BJ, W6ADT 98; G6GH, W1IOZ, W2JME, W4TP, W8LZK 97; W1AVK, W2CTO, W8B0X 96; F8LX, FB8AB, G6XL, W3AIU, W3EMA, W8IQB, W8PQQ 95; W3A0O, W3FLH, W8CJJ, W9BEZ 94; G6Z0, ON4GK, PA0QZ, W2WC, W3OP, W4TZ, W6FKZ, W6MEK, W6TT 93; SP1LP, W3GHD, W4DMB 92; W9GBJ 91; D3CSC, G6YR, LU7AZ, ON4FF, SP1AR, W1CBZ, W8KTW, W9JDP 90; W1KHE, W2CUQ, W8AAT 89; G2DZ, W3JM, W9PGS 88; G8IG, W2BZB, W6GPP, W9AEH 87; W1BGC, W8DAE, W9FLH, W9VKF 86; VK2TI, W1DOY, W4CFD, W6GK, W8LAV 85; SM6WI, W1BFT, W6AM, W8BWB, W9OVU 84; OZ7CC, VE2GA, VK3HG, W2AWF, W2FLG, W6DTB, W6KUT, W8BFG 83; EI4J, W1EWD, W3AYS, W8BWC, W8OUK 82; W6NLZ, W9GY, W1BPN, W2BNX, W2HTV, W3BVN, W3EPR, W4OG, W6LDJ, W8DGP, W8ITK, W9DIB, W9GKS, W9GMV 80; PY2DN, W3EUJ, W8CED, W8JFC, W9MRW 79; W3DRD, W4EPV, W8FJN, W9YNB 78; G3BD, LA2X 77; PA0JMW, W3BSB, W9HUV, ZEI1J 76; W1EH, W4AHF 75.
Radiotelephone: W2GW 99; G5RV, W2IXY, W4CYU 89; W3EMM 86; W8LFE 84; W1AKY 81; W2IKV 80; W1ADM 78.

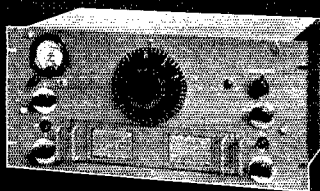

HRO

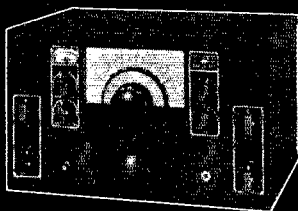

NC-100A

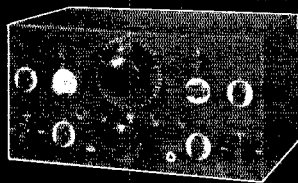

NC-101X



NC-44

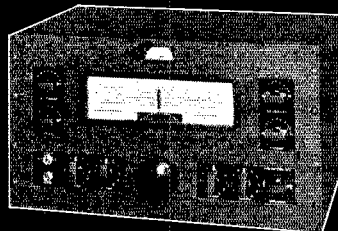

NHU

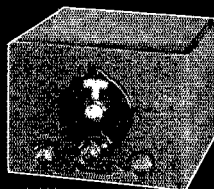

SW-3

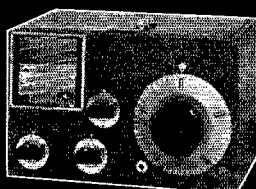

ONE-TEN

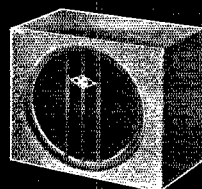

SPEAKER

HRO A professional receiver, designed for maximum performance. Features include two high-gain preselector stages giving exceptional signal to noise ratio, crystal filter, micrometer dial, S meter, AVC, Beat Oscillator. List Price \$342.50* and up, including coils, speaker and power supply.

NC-100A & NC-101X Fine Communication Receivers with splendid tone. These 11 tube superheterodynes are self-contained except for the speaker and are equipped with an effective noise limiter. The NC-100A series is ideal for broadcast reception as well as communication work. The NC-101X covers only the amateur bands. Features include one stage of preselection as well as complete communication equipment. For the NC-100A, List Prices begin at \$200.00*, including speaker, coils and power supply. For the NC-101X, List prices begin at \$215.00*, with crystal filter.

NC-44 For capable performance at very low price. A seven tube superheterodyne with continuous coverage from 550 KC to 30 MC. A CW oscillator is provided. List Price \$82.50*, including coils, power supply and speaker.

NHU A specialized communication receiver covering the range from 27 to 62 MC. The NHU is a high performance superheterodyne provided with all features and controls commonly needed in communication work, including a wide range crystal filter. List Price \$304.50*, including speaker, coils and power supply.

ONE-TEN A specialized receiver for the range from one to ten meters. The One-Ten receiver is intended primarily for the experimenter. It is a thoroughly satisfactory receiver for the ultra-high frequencies. Four tubes are used; RF (954), superregenerative detector (955), first audio and output audio. List Price \$85.00, with coils but without tubes, speaker or power supply.

SW-3 A dependable regenerative receiver. The SW-3's eight year reputation for performance and dependability give it preference for many classes of work. It uses three tubes in a highly developed circuit that provides maximum sensitivity and flexibility. Coils are available to cover the range from 9 to 3000 meters. List Price \$35.00, without coils, phones, tubes or power supply. Coils list at \$5.00 per pair for all ranges below 200 meters.

* Complete price listings will be sent on request. The prices given above are for AC models with complete equipment. With less complete equipment, the price will be lower in most cases.

NATIONAL COMPANY, INC., MALDEN, MASS.

NATIONAL RECEIVERS

CARDWELLS

*in a few
1940 applications*

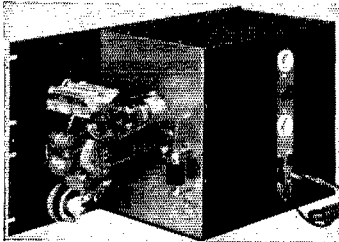

★
In Glen
Browning's
NEW All
Band Exciter

a CARDWELL Midway Transmitting Condenser helps grind out a conservative 35 watts of driving power — on 5 bands, for any 240 watt amplifier.

Send for full details with circuit diagrams

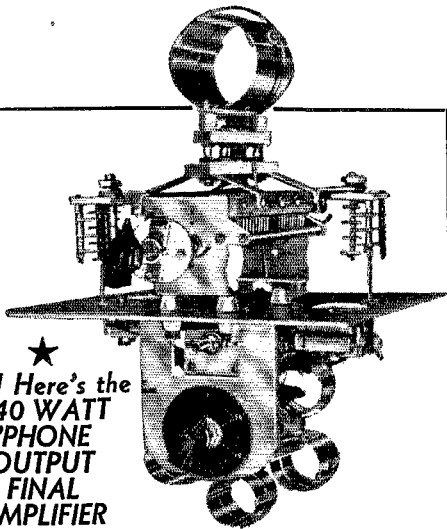

★
And Here's the
240 WATT
'PHONE
OUTPUT
FINAL
AMPLIFIER

Not a kit we are trying to sell you — just a tested layout for the new RCA 812's, Taylor T-55's, HK-24's or similar tubes, which can be easily driven by such an exciter as the Browning.

Write for free drilling templates and directions
Transfer this tested layout to your chassis, where you want it

- Includes:**
- CARDWELL "AFU" Foundation
 - CARDWELL EU-100-AD. Trim-air dual
 - Barker & Williamson coils and baby turret

**THE ALLEN D. CARDWELL
MANUFACTURING CORPORATION**
83 PROSPECT STREET, BROOKLYN, NEW YORK

Forty Traffic System (FTS)

Some 200 stations are now enrolled in the Forty Traffic System. All stations in the "FTS" group are urged to operate within the 7200-7250-ke. region of the 7-Mc. band, although stations outside this sector are also invited to join. Organization of the "FTS" started in March, 1939, and has been carried on by Nils Michaelson, W2LSD, O.R.S. It has as its purpose the furtherance of message handling in the 7-Mc. band and the bonding together of operators interested in traffic work. Membership is open to any licensed amateur using 7 Mc., provided he will agree (1) to maintain at least one regular ninety-minute operating period per week from 2000-2130 EST (the "FTS" traffic hours); (2) handle any message within a 36-hour period; (3) solicit messages from friends and acquaintances; (4) cooperate with all stations, FTS or not; (5) use the 24-hour method of time keeping; (6) make use of the general call "CQ QRU FTS? DE . . ." during the FTS traffic hours and at other convenient times. W2LSD issues an FTS bulletin, "Etherettes," which goes to all members. Anyone interested in joining the Forty Traffic System, or securing further information on same, should get in touch with W2LSD at 55 Temple St., Harrison, N. Y. Included in the FTS Roster are the following stations, many of them being O.R.S. with connections to the regular A.R.R.L. organized traffic routes on the 3.5-Mc. band: WIAJ BDU DEU GMR GWK JAM JDP JWA JZB KCQ KKS KRX KVT KYB KNJ LAL LDD LFB LGJ LJJ LLA LMN LMO LNE LNN LOB LPX LRK LRP LSE LTT LVV MCX UE W2AEU BXP CKQ CZN DBW GBJ GXR JDC JRT JUC JWF KJU KKR KKK KXZ KMZ KXZ KZU KZX LEL LHP LME LMN LMR LPJ LQP LSD LWP LXA LXI LZR MAK MCI MDE MEI MGG MII USA W3BHP EEW EGN EUC FUM GGP HDP HDW HEZ HFG HGK HHR HLQ HLZ HQX HRD HRS HSP HTI HWV HZV IAJ IBG RR W4AKC BWV CQX DJJ DNR ECH FDB FRH FTS FRU GAG GGD W5CWW ELW GSD HJF HNO IFD W6JUF LTJ NGC RAM W8BOB DKL EGY EHA FEW FNT KNP LXR MGT NCJ NZH PAB PTJ QCU QER QIM QKQ QYK QZH RAP RIM ROB RUF RVF RVR RYM SCW SFC SJF SNW SQU SVH TEL TEO TNA TRB W9AGI BQC BRD CRK CXQ DIJ EIH EYH GGG HOE IIL ITH JKI KBL KUF LAR LNQ LPD MJN MPW MUX NZF ONL QIN QKL RPW RWS TKG UYP YDR YKG YTS YQM YWH ZDS ZJP

College Ham News

BY NILO E. KOSKI, W7LD*

CHAPTERS of Rho Epsilon at Washington State College, Univ. of Washington, Armour Institute of Technology, Montana State College, and Tri-State College have begun activities for the year. The National Intercollegiate Press Ass'n, an activity of Rho Epsilon, is underway with W7GWT, W7YH, W7HIX, W9YW, W9HPE, and W9VGT active. Stations at other colleges may become affiliated by writing to the national N.I.P.A. manager, Sigmund Mentzel, W9PBT, 4819 N. Melvina Avenue, Chicago, Ill.

Rho Epsilon is making a survey of college radio clubs by means of questionnaires. The first of these is entitled "Financing a College Radio Club." Clubs not having received a questionnaire are requested to write the National Secretary for a copy.

W9YW, Epsilon chapter's station at Armour Tech. in Chicago, expects to work the new Antarctic Expedition which Admiral Byrd is leading. Schedules may be maintained with the "Snow Cruiser." A rotary beam on 28 and 14 Mc. and a kw. input will do the job on 'phone and c.w. Classes in code instruction for beginners are held at the Zeta Chapter at Montana State College. The chapter's station, W7HIX, is on the air with 250 watts input. The station of Eta Chapter's President, W9HPE, is the official Eta Chapter station for 1939-40 at Tri-State, Angola, Ind. Chapter members are securing sweaters with the Rho Epsilon emblem attached. Officers of the chapter include W9HPE, President; W5GWK, Secretary; and W6NMH, Treasurer. Beta Chapter at the U. of Wash. is holding monthly dinner meetings open to all campus hams. Twenty-four were present for the first meeting at which W7EAW described his experiences hunting bulls on Chirikof Island.

* National Secretary of Rho Epsilon Fraternity, 5822 E. Green Lake Way, Seattle, Wash.

(Continued on next left-hand page)

both look alike

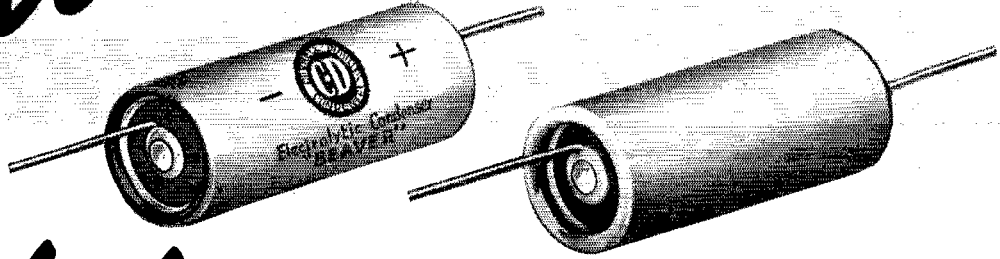

but

... that's where the similarity ends. For one of these capacitors was built by Cornell-Dubilier, and that means built with greater care — extra quality at no extra cost. Take the C-D Type BR "Blue Beaver."

Here's a space-saving unit that offers exclusive electro-chemical etching — eliminates corrosion; hi-formation process — affords higher voltage breakdown; — better impregnation, lower power-factor; special C-D super-purity cellulose separator — extra long life; double ageing — stable characteristics; all aluminum tubes and accessories — prevents galvanic corrosion; special vent — safety under all operating conditions; compact tubular construction — allows ease of wiring into circuit.

Amateurs who want the most-for-the-money get it in C-Ds. Be specific — order capacitors by name. Your jobber will appreciate it, for he knows the difference. Type BR's described in catalog No. 175A free on request.

Product of the world's largest manufacturer of capacitors

MICA • DYKANOL • PAPER • WET AND DRY ELECTROLYTICS

you can rely on

CORNELL-DUBILIER
a great name in capacitors



**CORNELL-DUBILIER
ELECTRIC CORPORATION**

1013 Hamilton Boulevard, South Plainfield, New Jersey

Cable Address: "CORDU"

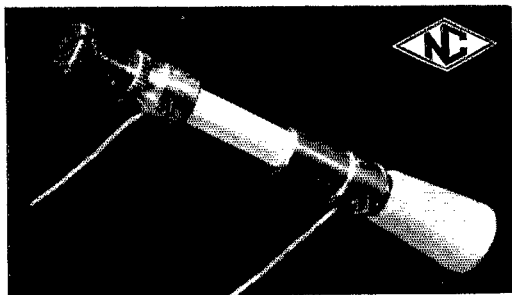

● For convenience the new models of the NC-600U Neutralizing Condenser are now provided with a small stand-off insulator for chassis mounting. For pig-tail mounting, the insulator may be unscrewed and used for other purposes. Type NC-600U Neutralizing Condenser, List Price \$.55 with insulator. Type NC-600, without insulator, List Price \$.45

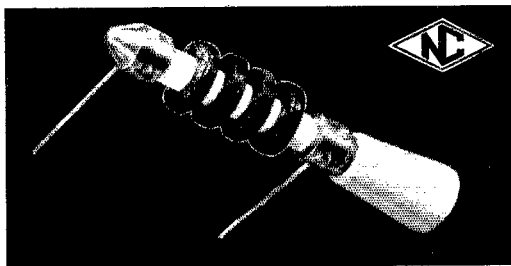

● The R-100U and R-300U Chokes are likewise available with the removable stand-off insulator. Type R-100U has an inductance of $2\frac{1}{2}$ mh and a current rating of 125 ma. Type R-300U has an inductance of 1 mh and a current rating of 300 ma. Type R-100 and Type R-300 are similar but without the stand-off insulator. List Price, Type R-100U or R-300U, \$.60. List Price, Type R-100 or R-300, \$.50

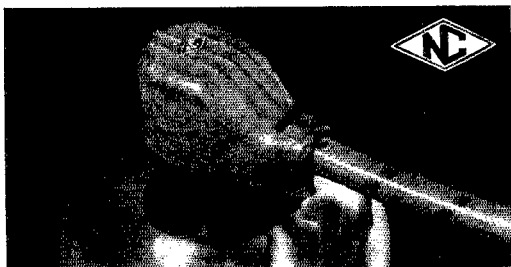

● The Type SPG Safety Plate Grip is of molded R-39 and is an important aid to safety when using 866's or other tubes having 9/16" diameter caps. The conductor opening is large enough to receive high tension (spark plug) cable, but an insulated bushing is supplied for smaller wire. Type SPG, List Price, \$.35

NATIONAL COMPANY, INC.
MALDEN, MASS.

a small island 100 miles off the coast of Alaska. W7GWT participated in the Sweepstakes Contest with members keeping a continuous watch. Chapter President W7ESK was highest scoring W7 on 'phone in the last DX contest. The members are building and experimenting with 112-Mc. pack sets for use at track meets and crew races. Members of Alpha Chapter at W.S.C. have rebuilt W7YH for N.I.P.A. work, and have a new NC100X receiver. Charter members of the new Theta Chapter of Rho Epsilon at the Newark College of Engineering include W2KBS, W2HIT, W2JSX, W2KCN, W2IZP, W2LGV, W2JBI, W2MHJ and W2GFW. The chapter station is W2JPK.

W1KQA is a member of the Univ. of Alabama track team. The U.A. Radio Club has a 100-watt 'phone and c.w. transmitter in the new Engineering Building. W9DAH is assistant professor of physics at South Dakota State College; W7EZL is physics professor at Oregon State College. W7HTZ is located in the SAE house at O.S.C. W9VGT holds N.I.P.A. schedules from Ripon College, Wis. Several local amateur radio fraternities are Rho Sigma Tau at Drexel Institute, Sigma Rho Epsilon at Los Angeles City College, and Synton at the Univ. of Ill. In addition to W7GWT, two other stations on the U. of W. campus are W7DHC of the Naval R.O.T.C. Radio Club, and W7FWT of the Engineers Radio Club. W3DL is on 3.9-Mc. 'phone from the Univ. of Va. W3UYA has gone to Randolph Field for training and has a portable on the air. The Cal-Tech Radio Club has recently been organized at Pasadena, Calif. W6RRO is the club station.

B.P.L. or Bust

BY WM. THOMPSON, W6PMV

IT WAS nine-twenty on the evening of the fifteenth and Henry had just sent the last QRU and signed with the gang on the trunk line. It had been a pretty fair evening. Four from Hawaii had been cleared to Denver, twelve deliveries were made, and the hook was as clear as the 7-Mc. band at ten on Monday mornings. Joe and Ed were still chewing on the T.L. frequency. Headphones laid aside, Henry was preparing to start the task of filling out the report to the S.C.M. The month's accumulation of traffic would make a nice total, thought our hero, as he began to sort the sheets into relayed, delivered, extra deliveries, and originated piles. After all, the B.P.L. roster would hardly be complete without Henry's call. Hadn't he made it regularly for the last fourteen months? Hadn't the S.C.M. stated "W6XYZ has the usual fine total" in the last issue of QST? "If all the reporters came through like I do, what a Section we would have!" thought Henry, gazing fondly at the O.R.S. certificate hanging on the shack wall.

It was twenty minutes later before Henry finally began to add the respective totals. No — were his eyes deceiving him — they must be; yet, there were the cold figures — 498!! This was terrible! A second count only succeeded in confirming the awful truth. After thirty days of hard work, was this to be the reward? With two less than the required number and with only thirty-seven deliveries, poor Henry was in mental agony. He wasn't the kind who could merely write 500 or 502 on the report blank and forget about it. Something must be done! There was only one thing to do! It was almost ten, two hours remained before the deadline. Here was a chance to originate that long-contemplated message to the old YL friend in Sawbuck, Ohio. Tearing a sheet from the pad, Henry typed: NR215 W6XYZ CK14 LOSA NFT — Well, there was one, but two were needed. Oh yes, he just remembered about that request to A.R.R.L. for that Red Cross poster. That would do the trick and kill two birds with one stone. In no time at all, NR216 rolled off the mill and Henry began to unwind the receiver dial.

After noting that the T.L. gang had QRT on 3.5 Mc. by this time, the rig and receiver were shifted to 7 Mc. Henry decided a snappy CQ TFC EAST would do the trick. The TZ40's hummed, the plates of the '66's spread a hue of blue upon the baseboard, and Henry waited. Ah, there's an answer — "W6XYZ DE VE5FMG VE5FMG VE5FMG AR." These fellows that disregard directional CQ's!!! On went the dial — ah! a nice loud one — "DE W6XXX AR." This was too much. "Call CQ Ohio and raise Canada and California; maybe I should take up knitting," growled Henry between curses. Still, he heeded those two points. The next fifteen minutes were wasted scanning

(Continued on next left-hand page)

3,527°C v.s. 1,452°C

Taylor Wonder Tubes

T-40 and TZ-40

Built to Take It—AND THEY DO!

Here's Why . . .

The *plus* features built into every Taylor Tube result in greatly increased *safety factors*, longer dependable life and better all 'round performance. COSTLIER TO BUILD, Taylor T-40's and TZ-40's, with their heat resisting, complete molybdenum grids and rugged carbon anodes, represent the utmost in true value.

STANDS 800% to 1,000% OVERLOAD

Taylor's Wonder Tubes, T-40 and TZ-40, with the famous "Processed" Carbon Anodes, are able to withstand tremendous *temporary* overloads without injury. The extremely high melting point of the Taylor Carbon Anodes is 3,527°C as against 1,452°C for a nickel anode. An overload of only 300% will puncture the average nickel anode while the Taylor Carbon Anode will stand an 800% to 1,000% overload without damage. A T-40 or TZ-40 can be operated at 225 watts input in class C telegraphy service and 156 watts input in class C telephony. See pages 5 and 6 of November *QST* for increased ratings. The new ratings can be applied to all T-40's and TZ-40's now in use and in dealers stocks.

OVER 20,000 ALREADY IN SERVICE

Your best proof is heard *on the air*. Satisfied Amateur users take pride in boasting of their T-40's and TZ-40's in all classes of Radio service including operation on 112 MC. The *Wise Amateur* will insist on Taylor's Wonder Tubes thru comparison. Every T-40 and TZ-40 is actually tested at 300 watts plate dissipation before it leaves the factory. Again we say—"They Cost More to Make and They Do More for You"!

Recommended by Leading Parts Distributors

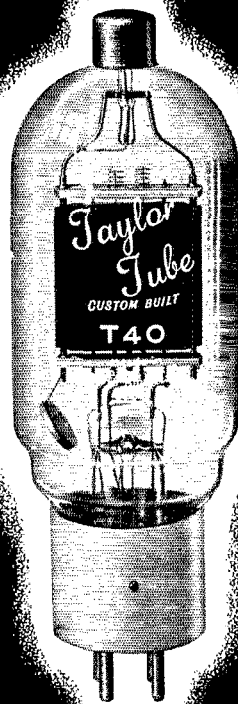

ONLY \$3.50

TAYLOR'S BIG 1940 TUBE MANUAL & CATALOG NOW READY

Send us five cents in stamps or coin and it will be mailed direct from the factory, or at your parts distributor **FREE**. Contains new circuits, technical data, tube uses, building information, etc.—a real up-to-the-minute storehouse of valuable information.

"More Watts Per Dollar"

TAYLOR TUBES, INC., 2341 WABANSIA AVE., CHICAGO, ILLINOIS

OHMITE parts
 specified for
 sure-fire cathode
 modulation



Here, above, is the Ohmite Multivolt multi-tap vitreous-enamelled Resistor specified by Frank C. Jones in his system of Cathode Modulation. It provides the exact control needed in order to secure the proper impedance match of the modulator to the filament or cathode circuit of the final r.f. amplifier.

★

And here, too are other outstanding Ohmite parts used in the circuits for trouble-free dependable operation. ★ *Brown Devil Resistors*. 10 and 20 watt sizes. 1 to 100,000 ohms. ★ *Divid-ohm Adjustable Resistors*. 10 to 200 watts. ★ *Fixed Resistors*. 25 to 200 watts. In all standard resistances. ★ *Center-Tapped Resistors*. 1 watt and 10 watt sizes. 10 to 200 ohms. ★ *Parasitic Suppressor*. To prevent u.h.f. parasitic oscillations.

★

Get them from Your Jobber
 Write Now for Catalog 17

OHMITE MANUFACTURING COMPANY
 4863 Flournoy Street ★ Chicago, Illinois, U. S. A.

OHMITE
 RHEOSTATS RESISTORS TAP SWITCHES

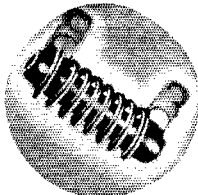
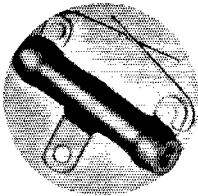
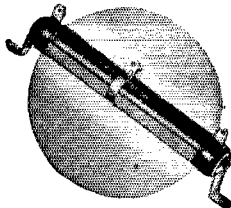
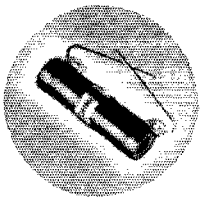

the high end of the band, as there wasn't a single W8, W3, or any station even near Ohio coming through. "Short skip," mused Henry. The dial was resting untouched; Henry was through. Why bother with B.P.L. anyway? Now would be a good time to forget traffic and put the rig on 1.75-Mc. 'phone! — Wait! What was that? "W6XYZ DE W6ZYX/6 QSP LA? AR." One last chance, thought Hank, coming back. "QTH? QTC? BK." rattled off Henry's bug. "BK QTH mountain camp bear lake BT QTC7 LA QRV? BK." came back. Heaven couldn't be any nicer, thought Henry, as he took them solid. That last "TU OB VY 73" was sent with real feeling this time, as our hero typed 505 in the space provided.

"Now to put these all under the table in the filing box and then see what the little woman has in the ice-box," gloated Henry, as he kneeled under the desk. "A fine place to leave old scrap paper," he thought, seeing several sheets of paper over in the dusty corner on the floor. Not really — yes, actually — messages dated this month — seven of them!

O.B.S.

The following is a supplement to the list of A.R.R.L. Official Broadcasting Stations in October *QST* (page 76): W1KKS, W1ZE, W3FJU, W4AZT, W6FZQ, W6MFH, W9FXM.

The "California State" — WTDQ

The training ship *California State*, operated by the California Nautical School, will depart from San Francisco on January 18, 1940, for a cadet training cruise, which will last until May 1st and take the ship through the Panama Canal to Cuba, Puerto Rico, and along the east coast of the U. S. to Washington, then back to San Francisco. The *California State* is authorized to communicate with licensed amateurs, and it is desired to work as many 14- and 7-Mc. amateur stations as circumstances permit. The ship's call is WTDQ and operation is on the 18-, 24-, 27- or 36-meter marine bands. It is contemplated that during the cruise period a couple of hours each evening will be set aside for amateur QSO's. Any operator wanting schedules with WTDQ should write immediately to E. L. Robberson, W6ADH, Communication Officer, T. S. *California State*, Tiburon, Calif.

Ohio amateurs: W8ELC requests immediate return of all petitions filled out as per October *QST*, so these can be used in the move for special auto tags.

See Page 100 for Station Activities

A.R.R.L. HEADQUARTERS OPERATORS

W1AW, A.R.R.L. Headquarters:
 Hal Bubb, "Hal," Stn. Eng. and Chief Opr.
 George Hart, "Geo," 2nd Opr. See others, below.

The following calls and personal signs belong to members of the A.R.R.L. Headquarters gang:

W1BAW, R. T. Beaudin, "rb"
 W1BDI, F. E. Handy, "fh"
 W1CBD, C. B. de Soto, "de"
 W1DF, George Grammer, "gg"
 W1EH, K. B. Warner, "ken"
 W1ES, A. A. Hebert, "ah"
 W1GS, F. C. Beekley, "beek"
 W1INF, A.R.R.L. Headquarters Operators Club
 W1JEQ, Vernon Chambers, "ve"
 W1JFN, A. L. Budlong, "bud"
 W1JMY, Joseph A. Moskey, "joe"
 W1JPE, Byron Goodman, "by"
 W1JTD, Hal Bubb, "hal"
 W1LVQ, L. John Huntton, "jh"
 W1MEC, W. J. Fricke, Jr., "bill"
 W1MFA, Harold K. Isham, "hi"
 W1SZ, C. C. Rodimon, "rod"
 W1TS, Don Mix, "don"
 W1UE, E. L. Battery, "ev"
 W3AMR, George Hart, "geo"

NEW MODULATOR TUBES WILL NOT OBSOLETE *This* SPEECH AMPLIFIER!

A. with C.H.T. Trans-
formers



B. with Regular Type
Thordarson Trans-
formers

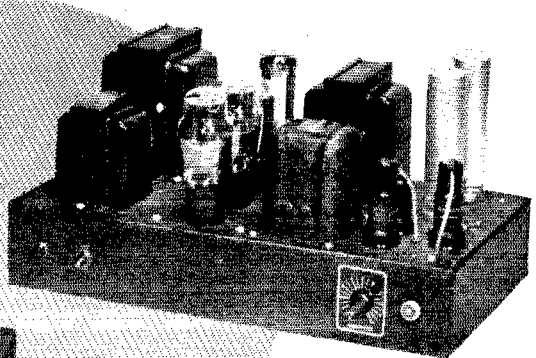

Today, with THORDARSON parts and THORDARSON complete instructions, you can easily build the most efficient and versatile speech amplifier ever offered to amateurs. Note some of its outstanding features:

You may have your choice of three circuits: (1) the popular *over-modulation control circuit*, which not only eliminates over-modulation but also increases the average side band power of the transmitter. Or, (2) a *peak limiting amplifier*, with a self-contained circuit which, with an easy adjustment, makes over-modulation and resultant distortion absolutely impossible. Or, (3) a *conventional type amplifier*, with circuit and full assembly directions on the regular instruction sheet.

Place the equipment on the operating table, with screen cover and a 500 ohm line to the modulator, or mount it with a panel

in one rack, as you prefer. This flexibility also extends to a choice of transformers. For you may have either the C.H.T., or regular THORDARSON transformers. Driver transformers with variable ratios are also available in either of these lines.

Complete drawings, photos, parts lists and instructions for easy assembly of these circuits are offered.

Ask your Parts Jobber or write us for THORDARSON Bulletin SD 389D

Use the Amateur Speech Amplifier with the NEW RCA 811's! Or with any tubes—old, new or as yet undeveloped. New tube types will not obsolete this amplifier!

THORDARSON

ELEC. MFG. CO., CHICAGO

"TRANSFORMER SPECIALISTS

45th Anniversary
SINCE 1895"

QST

YEARLY BINDERS

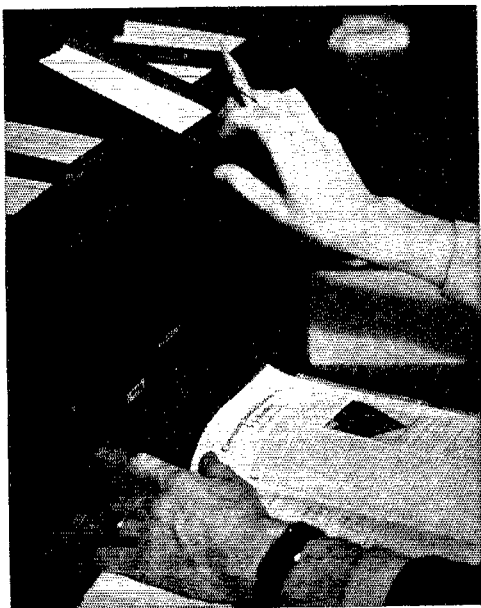

Are We Right?

You should have at least two of them—one for your complete 1939 file of copies, and one for each 1940 issue as published.

With each Binder is furnished a sheet of gold and black gummed labels for years 1922 through 1941. The proper one can be cut from the sheet and pasted in the space provided for it on the back of the binder.

Price **\$1.50** postpaid

Available only in United States and Possessions

THE AMERICAN RADIO RELAY LEAGUE
West Hartford, Conn.

On the Ultra-Highs

(Continued from page 59)

INTERNATIONAL NOTES:

FROM THE *T & R Bulletin* (R.S.G.B.) we learn that, with characteristic British fortitude, our cousins of the Empire are attempting to carry on in the amateur spirit, despite the surrender of their licences and transmitting gear to the "P.M.G." Considerable u.h.f. interest is apparent, with six pages in the September issue devoted to the story of the annual 56-Mc. Field Day. We note that all but two of the stations participating used c.c. rigs, although this type of equipment is not mandatory in England. In their extensive use of c.w. the G's set us a good example.

While interest in u.h.f. receiver work will undoubtedly lag, due to the lack of any signals on these frequencies, it strikes us that if any good can come from the current state of affairs in Europe (from an amateur standpoint) it will be the result of the concentration of effort in work on receivers and antennas on the part of those amateurs who are not called to their country's service. With the most likely season for long-haul DX on 56 Mc. coming up, it is not too much to hope that some of those lonely listeners may hear a sig or two from this side of the Atlantic. We are assured of the cooperation of the ZS stations who, though now silent, are still interested in the possibility of trans-oceanic DX on "5." The ZS-W tests instigated by W3EOH are still being carried on, with the promise of a cablegram from the other U. S. A. if anything is heard.

A new inter-G record was set on August 20th by G2OD and G8KD, distance covered being 187 miles. Several QSO's with I1ZU are reported which sounds like real DX, though it is actually similar to that commonly covered during sporadic E sessions in this country. For the benefit of W9ZJB we report that his "Grand Slam" is credited to "W9XJB" in the *T & R Bulletin*. Vince, who was "W8ZJB" in *Radio* and "W9ZJB" in *QST* is, no doubt, about ready to start himself a magazine!

W6OVK sends along a letter from VK2IQ, who expresses regret at being forced off the air by war conditions. He reports that many stations were active around Sydney, mostly with superhet receivers and c.c. rigs.

112 MC. :

It is obvious from the reports received that much excellent pioneering is being done on 2½ in all sections of the country, but, due to the lack of important facts about individual setups, we find it difficult to record the complete story of the progress being made. Let's hear more about the rigs and antennas used, the distances covered, frequencies and operating schedules, and other points of general interest. This department is for the benefit of the "ultra-ultra-high" enthusiasts, just as much as for those on 56 Mc.

A fine example of a type of work which tends to earn a high place in the estimation of the general public for amateur radio is set forth in a letter from W3VQ, secretary of the Ultra-High Frequency Club of Philadelphia. This enterprising group did a fine job for the committee in charge of "Philadelphia's Premier Air Classic," which took place on October 29th, under the sponsorship of a local American Legion post. With 2½-meter transceivers installed at the pylons and other key points, the U.H.F.C. handled the complex communication problems neatly. Official letters of commendation are proudly displayed, and plans are already underway to do an even better job next year. The U.H.F.C. is to be congratulated on its fine work. A somewhat similar service was performed by the Santa Monica Mike and Key Club, who put 2½ to work at the National Speedboat Races at Balboa, Calif., according to the report of the Los Angeles SCM.

Some real DX on 2½ is reported by W2KYT. He tells of a QSO between W2DAR, West Orange, N. J., and W1BZ, Atlantic, Mass., a distance of nearly 200 miles, but here, again, details are lacking. 2KYT uses two r.f. stages (956's) ahead of a 955-6J5-6F6 lineup in the receiver. The rig is a pair of HK-24's at 100 watts. W2JND, Syosset, N. Y., is on nightly 9 to 11 on 114 Mc. looking for W1 DX. W2BZB keeps an eye peeled for DX every Sunday between 9 and 11 P.M. W2MES/2 worked several stations in the contest with one watt on 2½! W2HGU has HK-54's c.c. and is working up to W1AVV quite well, according to W2AMJ. Some superbets, mostly of the r.c. type, are in evidence.

(Continued on next left-hand page)

BLILEY CRYSTAL UNITS

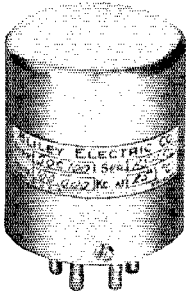

TYPE SOC 100
Standard Frequency Unit.
\$15.50

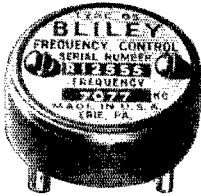

TYPE B5
40 Meters. \$4.80

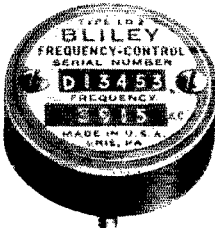

TYPE LD2
80-160 Meters. \$4.80

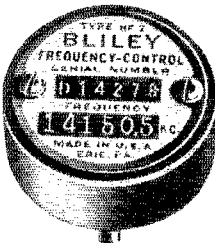

TYPE HF2
10-20 Meters. \$5.75

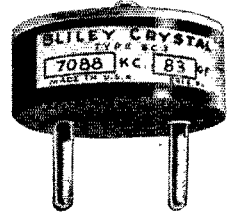

TYPE BC3
40-80-160 Meters. \$3.35

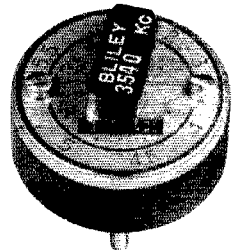

TYPE VF1
40-80 Meters. \$6.60

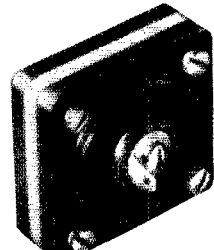

TYPE SMC100
100-1,000 Kc. Calibrator
Unit. \$7.75

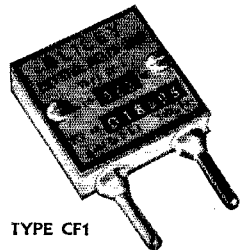

TYPE CF1
Filter Unit. \$5.50

TODAY, more than ever before, amateurs are discriminating in their demands for quality, performance and dependability in radio components. This is as it should be. The cost of even the most simple transmitter is by no means inappreciable—yet money spent for equipment which is not up to latest engineering and manufacturing standards or which is not thoroughly reliable is an unprofitable investment.

Bliley Crystal Units are not necessarily the cheapest in terms of dollars and cents. They are sold, however, at the lowest prices consistent with high quality, thorough engineering, and maintenance of rigid standards throughout every step in production. They are backed by a reputable organization whose aim is to serve the amateur in the best possible manner. In any product, these factors mean best investment for the amateur.

Illustrated on this page are representative types of Bliley precision-made crystal units for amateur applications. For a full description of the complete line ask your Bliley distributor for a copy of circular A-7.

BLILEY ELECTRIC CO.
Erie, Pa.

ACCURATE • DEPENDABLE

WHAT'S IN THE ANTENNA BOOK?

● ● ● In *Chapter 1* we find this or that type of antenna is better than another due to the nature of radio waves and the way in which they travel . . . *Chapter 2* is devoted to an explanation of how the strength of the field radiated from a section of wire carrying radio-frequency current depends upon the length of the wire and the value of the current flowing in it . . . *Chapter 3* clearly explains how the earth acting as a reflector affects the performance of an antenna, particularly with respect to its directive properties and how we must take this into consideration in its design . . . Figures, design and best methods of adjustment for feed systems to transport power from the transmitter to the antenna with a minimum of loss, will be found in *Chapter 4* . . . In *Chapter 5* radiation patterns and feeding systems for our old standby the half-wave antenna are given . . . If interested in long single wire antennas, in *Chapter 6* we find all the necessary charts and tables to design one best suited for our needs . . . *Chapter 7* gives us the data for the antenna that we can operate on several bands . . . Driven arrays and phase systems, their adjustment, with charts for directivity are fully covered in *Chapter 8* . . . Our next *Chapter, 9*, is devoted to parasitic arrays and the necessary dope for the design and adjustment of two-element to four-element beam antennas . . . As in the other chapters, all the necessary charts and tables are given in *Chapter 10* for the design of the long wire "V" antenna . . . The rhombic, or diamond, antenna is so adequately covered in *Chapter 11* that one may gain a thorough understanding as well as the practical information necessary to have such an arrangement . . . The problem of finding space for an antenna for 160 meters is minimized in *Chapter 12* by giving methods for putting up such an antenna in limited space . . . It having been found that directive systems will extend the operating range on 56 Mc. to a remarkable degree, such antenna systems are described in complete detail in *Chapter 13* . . . *Chapter 14* is devoted to special antenna systems. Flat lines for two bands, three feeder antennas, transmitting loops, dummy antennas, etc. . . . To efficiently utilize our directive arrays we need to be able to determine directions and also true north from our own location. Both of these problems are adequately covered in *Chapter 15* . . . Suggestions and details on the construction and support of the antenna and feeder systems will be found in *Chapter 16* . . . *Chapter 17* gives us proven methods of supporting and rotating beam antennas, as well as information on drive mechanisms, feeding and determining the direction that the signal is aimed . . . We find in *Chapter 18* special antennas for receiving, as well as methods for using our transmitting antenna for this purpose.

50 cents, postpaid. (No stamps, please)

A. R. R. L.
WEST HARTFORD, CONNECTICUT

W3FX, Philadelphia, reports W3's EX, GNA, FAA, ARG, GOM, FSM, FWL, AUY, GFZ, and IHI worked recently, with GGH, DJ, and EMJ also heard. To get on 2½, W3FX added an RK-34 push-push doubler with a series-tuned plate circuit to his regular 56-Mc. final. The antenna is an extended double Zepp. For receiving, a converter feeding an SW-3 does a good job on the more stable sigs, but a super-regen is necessary for most. Fisher would like to hear some c.w. from some c.c. stations.

The recent contest saw plenty doing in California on 2½, with the following W6's reported: LQM, RVL, KWH, QUF, NJJ, OJB, OMC, PRQ, NGQ, and PDW. W6OMC plans to take his mobile rig (HK-24 with concentric grid line) to some of the peaks around Oakland on Sundays. Murdock uses a Kraus multi-wire doublet and finds this antenna easy to get going and far-superior to a simple half wave. 6MQLM reports two hidden-station hunts sponsored by the Valley Radio Society. A message from 6RVL tells of ". . . over sixty rigs here on 112 Mc." With all this going on, there should be plenty of interesting dope for the column. What say, gang?

W7HBL, Seattle, reports "The Rover Boys of 2.5," W7's GXP, BDW, GUL, and HBL, working each other, with no out-of-town DX as yet.

Around Chicago W9's LRT, DLP, DYV, UTS, OBW, KUV, SHM, and EDG are going strong, with more coming along. Things are picking up around Milwaukee, according to W9ZGD, who asks us to sponsor the adoption of horizontal antennas. Sorry, OM, but we can't agree there, as yet. All available dope and many tests made on both 5 and 2½ show verticals by far the best for extended local work. More along this line soon.

224 MC.:

AROUND Washington, D. C., W3EIS reports W3's FQB, EJB, AWS, GKP, and FPQ fired up on 1½, mostly using small Gammatrons or W.E. 316-A's. These boys would like to test with DX stations when 56 Mc. is open. They are trying for QSO's with W3GLV, Leesburg, Va., who is reputedly using a c.c. rig on 1½!

W8NOJ is active in Erie, Pa., according to a story in a Canadian paper, covering 30 to 50 miles with moderate power. Activity is promised by W5AJG and W6QLZ in order to make the most of the high multiplier offered for 1½-meter work in the Marathon. Clyde, 6QLZ, already has his 35T down there, and is riding around with a mobile receiver to see how far it can be heard.

The Marathon should provide incentive to many to see what can be done on 224 Mc. Ten points for an over-the-back-fence QSO is not to be sneezed at, and, with high-gain beams such a simple matter, some long-haul work may yet materialize on this band.

And a final word to all. We have high hopes that the Marathon will stimulate consistent activity in all sections of the country. If it does, it will provide an unparalleled opportunity for studying u.h.f. conditions of all kinds. What is the connection, if any, between weather conditions and skip DX? How do temperature inversions affect 2½ and 1½? Can there be skip DX on 2½? Some light may be shed on these and many other similar questions if we keep our eyes and ears open in 1940. Let us never forget that one amateur who was intelligently curious, our own Ross Hull, changed our whole conception of u.h.f. wave propagation by careful and complete observation!

Code Practice Oscillator

(Continued from page 61)

original depth of which has been cut down to 2½ inches to provide room for the batteries at the rear of the case. The two switches, the tube socket and the grid condenser are below the base. The rear-view photograph of the cabinet shows the six pairs of 'phone jacks and the monitor keying terminals. Heavy tinned wire ties the jack in parallel. Throughout the entire assembly, parts are well insulated from the case proper.

The reader will wonder about the RC combination shown "boxed-in" on the diagram. These

(Continued on next left-hand page)

RADIO AT ITS *Best!*

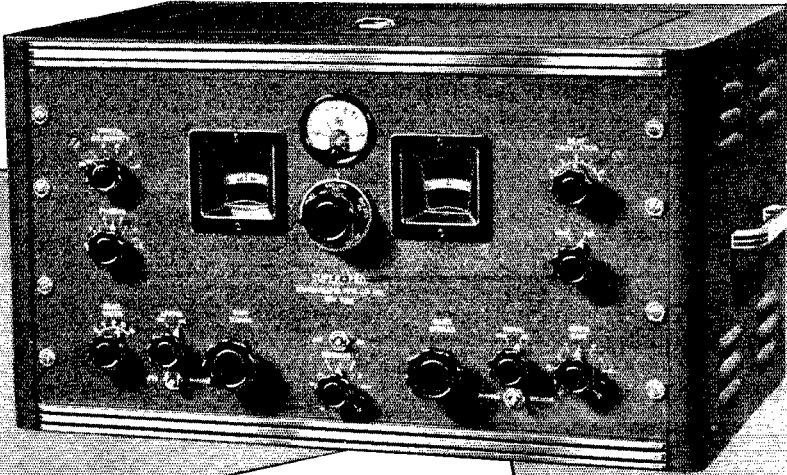

The NEW "Super Pro"

THE Series 200 "Super-Pro" is not just another receiver created in the Sales Department first and then engineered to sell at a price. It is the result of years of research and engineering moulded into a single unit designed to satisfy the demands of the critical communications engineer whose only impasse is explained as "due to conditions beyond our control." Amateurs are more and more demanding commercial performance and the new Series 200 "Super-Pro" is the answer to that demand. The economy in owning a "Super-Pro" lies in the fact that it is built for years of service. As one owner puts it, "it is cheaper to buy one 'Super-Pro' than trade in an ordinary receiver every year." We might add that even trading for a new

receiver every year would still not give him "Super-Pro" performance. Ask your dealer to demonstrate the full-range variable selectivity of the new "Super-Pro" which covers every band width from single signal to nearly 16 kc. for high fidelity. Investigate the adjustable "S" meter, the efficient noise limiter, the variable crystal filter and its many other features and you will agree that it pays to own a "Super-Pro."

SEND FOR BOOKLET

HAMMARLUND MFG. CO., INC.
424-438 W. 33rd St., N. Y. City
Please send New "Super-Pro" Data.

Q-1

Name.....
Address.....
City.....State.....

Canadian Office: 41 West Ave.
No., Hamilton, Ont.



HAMMARLUND

IF IT'S
RCP Test Equipment
 it's a **BETTER PERFORMER**
 for the money



Right down this RCP quality line you get more test equipment service for your money. Greater sensitivity, wider ranges, more measurements. These are typical of the PLUS value in all RCP Test Equipment. It is not unusual to find RCP Test Equipment outperforming instruments costing two, and even three times the money. Do you wonder why each day sees more and more RCP Test Instruments taking over the jobs?



Look at this performance

A pocket size multitester, RCP Model 413, with all the features of "big time" professional testers, and none of the expense! Has a sensitivity of 2500 ohms per volt. Five voltmeter ranges of AC-DC-0/10/50/250/1000/5000. Three range ohmmeter 0/500/100,000/1,000,000. DC Microamps 0/400. DC Milliamps 0/10/100/1000. DC amps 0/10. Output meter same as AC volts. Meter has the same fine Alnico Magnet as used in ultra-sensitive, top-price meters. Attractive appearance in natural finish wood case. Weight only 25 ounces. **Net price..... \$12.90**

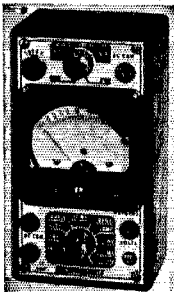

Also available in solid walnut piano finish hinged cover case — Model 409P complete with test prongs. **Net..... \$14.95**

Full details on RCP Multitester Model 413 are contained in new Catalog 121. Send for a copy at once. Get the facts about the features and you'll buy RCP Test Equipment — it costs you less and delivers more. Send today.



RADIO CITY

PRODUCTS CO. INC.
 88 PARK PLACE, N. Y. C.

components are necessary only when crystal 'phones are used. Usually, the condenser can be a 0.1- μ fd. low-voltage job if only one or two sets of 'phones are used. The resistor should be in the neighborhood of 5000 to 10,000 ohms. Both the condenser and the resistor values should be experimented with to assure maximum headphone volume.

In some cases, when using the unit as a keying monitor, there may be some hum modulation of the monitor signal. This happened in our own shack, but we found it far from objectionable — as a matter of fact, we liked it. It was surprising to find that a satisfactory signal could be heard from the speaker even when the operator was wearing headphones. And yet, the signal was not too strong with the 'phones off. And this with only 15 volts on the monitor tube plate.

New Receiving Tubes

(Continued from page 47)

Amplifier — Class A₁

Plate voltage.....	90 max. volts
Screen voltage.....	45 max. volts
Plate dissipation.....	0.2 max. watt
Screen dissipation.....	0.035 max. watt
Grid voltage.....	0 min. volts

Typical operation and characteristics:

Plate voltage.....	45	90 volts
Screen voltage.....	45	45 volts
Grid voltage*.....	0	0 volts
Plate resistance.....	0.25	0.8 megohm
Transconductance.....	700	750 micromhos
Transconductance at -10 volts bias....	10	10 micromhos
Plate current.....	1.9	2 milliamperes
Screen current.....	0.7	0.65 milliamperes

* Referred to negative filament terminal.

Pin Connections

- Pin 1 — Filament (-), suppressor
- Pin 2 — Plate
- Pin 3 — Screen
- Pin 4 — No connection
- Pin 5 — Filament (-), suppressor
- Pin 6 — Grid
- Pin 7 — Filament (+)

A.R.R.L. QSO Party

(Continued from page 59)

ber of different Sections (and continents³ outside field organization territory) in which at least one member has been worked and exchange effected. A convenient way to keep record of new and different Sections as you work them is to circle and number the name of the Section the first time it is written in your list.

A lot of fun assured. See how many members you can work on this January Saturday-Sunday weekend. And if you work anybody not a member, ask him "Why not?" It's one of the big annual events. See you there.

— F. E. H.

³ The multiplier is the sum of the number of Sections and continents outside the field organization territory in which at least one A.R.R.L. member is contacted. But a single multiplier times the sum of points gives the score. Example: W6XXX has completed two-way exchanges with 57 different stations located in 31 different A.R.R.L. Sections and Europe and Oceania. His multiplier is 33. Score? $2 \times 57 = 114$. $114 \times 33 = 3762$.

GAMMATRON

*offers a
Beam Pentode*

TYPE
24

The U.H.F. Tube
PRICE \$3.50

TYPE
54

Easy to Drive
PRICE \$6.75

TYPE
254

Easy to Neutralize
PRICE \$12.50

TYPE
354

Now Greatly
Improved Design
PRICE \$24.50

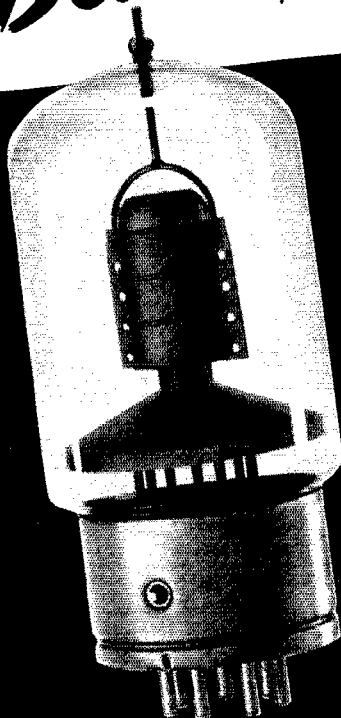

Power Output, watts	225
Plate Dissipation, watts	75
Maximum Plate volts	2000
Maximum Plate M. A.	150
Screen, volts	300
Filament, volts	5.0
Filament, Amps.	7.5

TYPE
257

PRICE \$22.00

Gammatron offers the 257 Beam Pentode, a tube of advanced design using Tantalum elements, eliminating insulators and "getter." It offers high voltage and power capabilities, suppressor grid modulation and requires very low driving power, no neutralization and low screen current.

Other Gammatrons of higher power
to 5 KW. Write for complete data.

HEINTZ AND  KAUFMAN
SOUTH SAN FRANCISCO LTD. CALIFORNIA U.S.A.

NEW V.U. METERS

BY TRIPLET

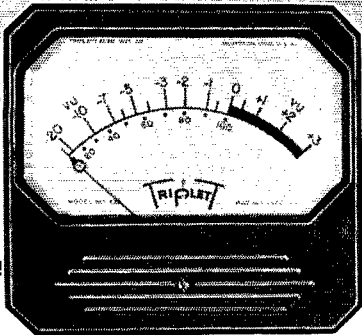

Model 426 . . . Four-inch Square Case

Volume Unit Meters for measurement of sound or noise levels. The dynamic and electrical characteristics are of new design; in accordance with state reference level of 1 Milliwatt. Calibrated for 600 ohm line. Has 0-100% scale. Reads minus 20 V.U. to zero level in black numerals. From zero to plus 3 V.U. in red numerals.

MODEL 1696 . . . Net \$33.00

This Modulation Monitor is usable on all amateur bands . . . permits compliance with Federal Regulations

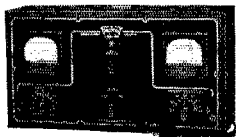

. . . 110 Volt 60 Cycle Operation . . . Two meters, one for Carrier, one for Per Cent Modulation . . . Also Modulation control for neon flasher from 50% to 120% . . . Polarity switch permits checking positive and negative peaks. Tip Jacks for Phone Connection. Uses Vacuum Tube Rectification. RED • DOT Lifetime Guaranteed Meters . . . In Metal Case . . . Dealer Net Price . . . \$33.00. Available also as rack panel mounting unit . . . Dealer Net Price . . . \$33.67.

WRITE for CATALOG
Section 251, Harmon Drive

THE TRIPLETT ELECTRICAL INSTRUMENT CO.
Bluffton, Ohio

Hints and Kinks

(Continued from page 66)

from an old automobile body. The rotor plates can be cut out with a circle cutter if desired. Both stator and rotor plates are also bolted together and filed to final shape in a block. Twelve rotor and ten stator plates are required.

The end-plate tie rods are pieces of $\frac{1}{4}$ - or $\frac{3}{16}$ -inch diameter brass rod threaded for about an inch at each end.

The rotor shaft is probably the most difficult piece to work out. It is made from a piece of soft steel shafting, $\frac{1}{2}$ -inch in diameter, which must be perfectly true. Any one of several methods may be used in fastening the rotor plates on the shaft. Probably the most simple method is to drill $\frac{1}{4}$ -inch holes in the rotor plates and use a collar $\frac{1}{4}$ -inch or so thick pinned to the shaft at the front end of the assembly. The tail end of the shaft may be threaded for a short distance and the assembly clamped up tight with a nut at the end.

Spacers for the rotor plates may be cut off to correct length from a section of brass pipe of proper diameter.

The stator plates are assembled on lengths of $\frac{1}{8}$ -inch diameter brass rods with $\frac{1}{2}$ -inch brass spacers which may be obtained from almost any radio supply house. The rods are threaded for a short distance at each end for clamping and mounting nuts. The isolantite mounting bars may be purchased from the National Company. They are the type which are used in the TMA-type condensers.

The bearings and their fitting in each end plate will be important if the condenser is to run smoothly. Bearings may be taken from an old condenser or a panel bearing with a spring washer may be used for the front bearing and the tail end of the shaft drilled slightly to receive a small ball bearing. The rear end plate may then be drilled and tapped for a $\frac{1}{2}$ -inch screw, the end of which has also been cupped out to fit the ball. A locknut may be used to hold the tension adjustment.

— Arnold Tangen, W9YNX

Wide Band Frequency Modulation

(Continued from page 19)

pass condenser be laid on the socket in such a manner as to form a shield between grid and plate leads. Although the experimental model has a gain control in the cathode circuit of the i.f. amplifier, this could be discarded in favor of a more useful variable control for adjusting the plate and screen voltage on the limiter, which seems to be more important. It is only necessary that the i.f. amplifier have sufficient gain to work the limiter stage successfully — the limiter takes care of various signal levels over a range of 50 db or more.

Tuning of an f.m. receiver is very similar to that with the ordinary a.m. outfit. With no signal, there is the usual background hiss of a somewhat different character than that from a narrow-band a.m. receiver since more high-frequency com-

(Continued on next left-hand page)

"COÖPERATION"

has long been my motto

I HAVE FOUND, from years of experience in the radio business, it always pays dividends to coöperate to the fullest extent with my customers. A satisfied customer is the best advertising obtainable. Accordingly, I keep my customers happy by prompt and fair dealings.

But I cannot give such satisfaction without the coöperation of the manufacturers, so I maintain an unusually close contact with my suppliers. In this way I am able to keep my customers informed of the newest and best apparatus available as it is being developed.

For example, since coöperation has been so very close with the RME Company I am ready at all times to supply you with complete information on their Receivers and Expanders.

RME's DM-36 Band Expander is one of the finest pieces of five meter equipment I have ever seen. Enthusiastic users of it report "5" wide open for DX.

And the RME-70, pictured below, is one of the better communication instruments which I gladly recommend as an outstanding example of craftsmanship.

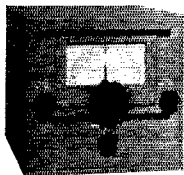

DM-36

Whatever you need in the RME line I have it for you. You can order on my personally financed 6% installment plan. You can trade in your receiver. Prompt shipment from Butler, Mo., in factory sealed carton or shipment direct from RME factory.

I have a complete stock of all receivers, transmitters, parts. I guarantee you can't buy for less or on better terms elsewhere. Your inquiries and orders invited.

Bob Henry
W9ARA

HENRY RADIO SHOP BUTLER MISSOURI

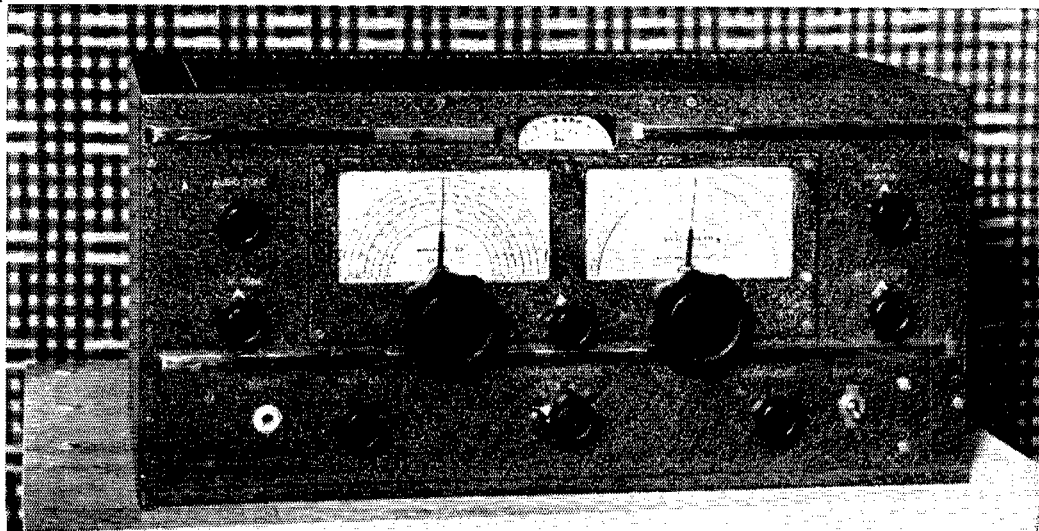

"Smooth Performance" Electro-Voice MICROPHONES

The New No. 630 DYNAMIC

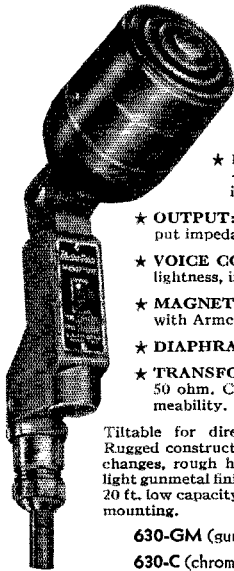

★ **FREQUENCY RESPONSE:**
40-9000 c.p.s. with rising character-
istic on upper end of curve.

- ★ **OUTPUT:** — 56 DB. (open line). Standard out-
put impedances include Hi-Z, direct-to-grid.
- ★ **VOICE COIL:** Hard drawn aluminum wire for
lightness, insulated with Polystyrene.
- ★ **MAGNETIC CIRCUIT:** Large Alnico magnet
with Armco magnetic iron pole pieces.
- ★ **DIAPHRAGM:** Heat treated Durev.
- ★ **TRANSFORMER:** Built-in in all models except
50 ohm. Core material has extremely high per-
meability.

Tiltable for directional or non-directional pick-up
Rugged construction. Impervious to heat, temperature
changes, rough handling and salt air. Chromium and
light gunmetal finishes. Three-contact locking connector,
20 ft. low capacity cable, on-off switch and tilting stand
mounting.

630-GM (gunmetal) net price..... \$15.00
630-C (chromium) net price..... 16.50

Model "75" CARBON

New streamline styling. $\frac{5}{8}$ " —
27 stand coupling. Button cur-
rent (each) 3-5 m.a. for close-
talking or feedback reduction.
10-15 m.a. for normal work.
Finished in gunmetal.

Net Price..... \$4.50

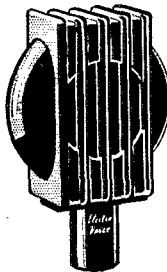

Model "V-1" VELOCITY

Small in size, flexible in operation.
Frequency response from 40-10,000
c.p.s., substantially flat. Output:
— 65 DB. 20' cable, connectors,
shock-absorber, locking cradle and
on-and-off switch.

Net Price..... \$15.00



ELECTRO-VOICE MFG. CO., Inc.

1239 SOUTH BEND AVENUE
SOUTH BEND, INDIANA

Export Division: 100 Varick Street, New York, U. S. A.
Cables: "ARLAB"

ponents are present. Ignition noise and other im-
pulse-type noise from man-made sources will be
very low in amplitude, however, because of the
limiter action. When a carrier somewhat stronger
than the background is tuned in exactly at reso-
nance the hiss changes considerably in character,
now being composed chiefly of high-frequency
components, the lower frequency noise being
highly attenuated. It is advantageous to use some
form of tone control to reduce high-frequency hiss
outside the audio band of the transmissions. When
the carrier is a few times as strong as the back-
ground the hiss entirely disappears, and only
such frequency modulation as may be present
on the transmitted signal or may be introduced
by the h.f. oscillator in the receiver is heard.
Strong man-made noises will be heard only as a
quite weak background accompaniment of the
signal. On very weak signals, the hiss behaves
much in the same way as with an amplitude-
modulated signal, but the improvement in re-
duction of man-made QRN still holds.

If they are not too strong, amplitude-modu-
lated signals can be received on the f.m. receiver
by detuning them slightly. In this position, a sort
of hybrid detection takes place that allows the
signals to be copied. It would be advantageous
here to have a variable control on the limiter, so
that the limiting action could be reduced when
amplitude-modulated signals were being received.
A still better method of receiving a.m. signals
would be to switch the grid circuit of the first
audio tube to the hot end of the limiter grid
resistor, the limiter then becoming an ordinary
diode rectifier for amplitude modulation.

On the other hand, the experimental f.m.
receiver looks like the best receiver we've ever
seen for 112-Mc. self-excited signals. Since any
modulated oscillator in the u.h.f. range has as
much (if not more) frequency modulation as it
does amplitude modulation, the receiver does a
beautiful job on receiving transceivers and the
like. One thing that immediately becomes ap-
parent is that less modulation is required on the
transceiver when using the f.m. receiver to receive
the signal than if a regular superregenerative
receiver is used. The quality seems to be better,
too, probably because the modulator is not being
forced when f.m. is used.

Frequency-modulation should have a definite
place in amateur u.h.f. communication. It has
demonstrated some highly useful characteristics
for our purposes. What is needed now is to get a
number of stations on the air using it, to give us
definite comparisons of the relative merits of f.m.
and a.m. and, as well, the shortcomings of both.
Our u.h.f. bands certainly will accommodate
both systems at the present time and probably
for a long time to come. There are, of course,
problems to be solved in the practical use of
frequency-modulation — as an instance, a simple
form of deviation indicator is needed so that
transmitter performance can be predetermined
to meet the requirements of receivers of various
band-widths. We have opened to us a really new
field in technique, highly interesting in itself and
extremely promising in performance.

FOUR NEW MEISSNER INSTRUMENTS



Deluxe Signal Shifter

Variable Frequency Exciter Unit

The new DeLuxe model Signal Shifter is particularly designed for both CW and Phone operation. Two voltage regulator tubes and high-C temperature compensated oscillator circuit provide stability comparable only to crystal control. New precision dial with full coverage on any selected band. Built-in keying filter assures clean-cut keying action. Completely assembled, wired and laboratory adjusted, ready for use (except for tubes) when you buy it. \$44.95 Net.



Signal Booster

High Gain Preselector

The Signal Booster provides high-gain preselection with complete coverage from 1,600 to 31,000 KC. The average gain of 40 Db. gives weak signals a tremendous boost . . . signals which quite often are inaudible on the receiver alone. A front panel control permits adjustment for maximum signal-to-noise ratio with either standard or doublet type antenna. Designed to match standard receiver impedances. A flip of the antenna change-over switch proves the high gain action of this outstanding communications product. Uses two 1852's and a 5Y4G rectifier. Completely assembled, wired and adjusted for peak performance. Your jobber will supply it, less tubes, for \$38.25 Net.

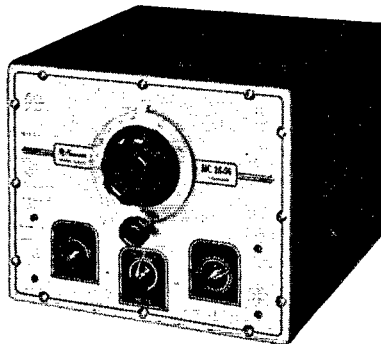

MC 28-56

5 and 10 Meter Converter Unit

A voltage regulated, stabilized frequency Converter unit designed to extend the frequency range of existing receivers to include the popular high frequency bands of 5 and 10 meters and to improve performance of receivers which may have 5 and 10 meter coverage. Three tuned circuits, with tubes having very favorable noise suppression characteristics, are employed to provide high gain output. Tuning is controlled by a precision type dial with auxiliary vernier compensator. Stability and drift-free operation assured by voltage regulated power supply and special high-C oscillator circuit. Unique antenna selector switch permits selection of antenna best suited to conditions and frequency. Completely assembled, wired and laboratory adjusted. \$41.25 Net less tubes.

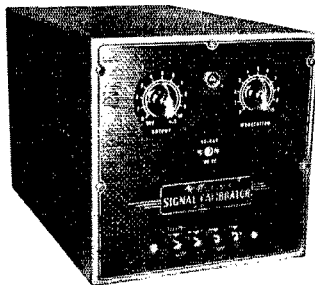

Signal Calibrator

Precision Type Frequency Standard

This precision built instrument belongs in every Amateur station. Enables the operator to comply with government regulations and keep a constant accurate check on transmitter frequency. Makes use of a special silver-plated quartz crystal having very low temperature coefficient and adjustable to exact fundamental frequency of 100 KC. Multivibrators operate at 50 KC. and 10 KC. enabling the operator to identify all Amateur band edges including phone bands. Strong signal output up to 60 MC. Furnishes either unmodulated or modulated signal output, adjustable over wide range. Retains calibration over long periods of time. Complete with tubes and ready to use . . . \$39.90 Net.

PASTE ON 1c POSTCARD

MEISSNER MANUFACTURING CO.,
Mt. Carmel, Ill. Dept. Q-1

Rush data explaining how the Meissner "Big 4" will improve results for me.

Also your 1939-1940 Catalog

Name

Street

City State

Cable Address: "MEISNRCOIL"

Meissner MT. CARMEL, ILLINOIS
A FAMOUS NAME FOR TWO DECADES

QRT?

Not necessary with the PRECISION Series 844-34 Range AC-DC VOLT—OHM—DECIBEL—MILLIAMMETER

Ready for instant action. PRECISION test equipment is most popular with progressive amateur operators.

PROVIDES complete facilities for obtaining all measurement requirements for Amateur, Service, Laboratory, Television and Industrial use.

- Large 4½" Precision square type meter; D'Arsonval type; "bridge type" construction; 400 microamperes full scale sensitivity.
- Precision wire wound shunts and matched molded metallized multipliers of an accuracy within 1%.
- Individually calibrated and sealed against laboratory standards assuring 2% DC and 3% AC overall accuracy.

SPECIFICATIONS

- ★ SIX A.C. and D.C. VOLTAGE RANGES at 1000 ohms per volt: 0-12; 0-60; 0-300; 0-600; 0-1200; 0-6000 volts.
- ★ SIX D.C. CURRENT RANGES: 0-1.2; 0-60; 0-300; 0-1200 MA; and 0-12 Amperes.
- ★ FOUR RESISTANCE RANGES: 0-400; 0-100,000; 0-1 Meg.; and 0-10 Megs.
- ★ Provisions for Mounting Ohmmeter Batteries (4½ and 45 volts) on inside of case.
- ★ SIX DECIBEL RANGES from -12 to 70 DB.
- ★ SIX OUTPUT RANGES: 0-12; 0-60; 0-300; 0-600; 0-1200; 0-6000 volts.

844-L — Housed in walnut finished hardwood case with carrying handle. Compact in size (7 x 8 x 4). Less batteries and test leads. Net \$22.95

844-P — Closed type with removable cover and tool compartment. \$24.95



PRECISION TEST EQUIPMENT

PRECISION APPARATUS COMPANY
 647 Kent Avenue Brooklyn, New York
 Export Division: 458 Broadway, New York City, U. S. A.
 Cable Address: Morhanex

Correspondence Department

(Continued from page 87)

THE ANSWER

15 Lea St., Lawrence, Mass.

Editor, QST:

In answer to W5EGV in the November '39 issue of QST . . . he asked about armatures that had got soaked. . . . Well, here's the answer.

Place armature in oven at 180 degrees and hold to that temperature. If armature has been under water it will take 48 hours or more, depending on size. If windings are just wet from dampness or a little water, usually 24 hours is sufficient. If it is possible to obtain a "Megger" one can get positive readings. When reading is infinity, your armature is completely baked and all ready to go again.

During our last flood, all our motors and generators were completely covered with water for three days. . . . That was the method used, and we did not lose a single motor or generator, big or small. . . .

— Paul Wm. Muller, W1HXE

OFF THE AIR

5, Pollards Hill S., Norbury, London, S. W. 16

Editor, QST:

Popular opinion amongst hams your side of the duck-pond pictures the average English ham a couple of hundred feet underground, flooding his air raid shelter with tears of despair at being off the air. Well, we may be off the ether, but we're certainly not under it. So here's some dope on things over here.

As soon as the show started over here, the government sent out notices ordering us to shut up or down, whichever you prefer. Some of us did.

So to make dead certain inspectors were sent to our shacks to put our rigs off the air. This consisted of confiscating coils and crystals and in my own case one or two connections were opened. I was away at the time and returned to find that the r.f. chokes in my modulator, and the socket for the HK354 final had been disconnected. Since neither were actually in operation and I still had the exciter unit and a 100-watt sub-amplifier running, I didn't know whether to shoot myself or to give myself up at the nearest jail. The problem was solved by the arrival of two more inspectors who announced their intention of removing the entire rig. The main H.T. transformer weighs 150 pounds, then there is a 350-watt modulator complete with power supply, plus a couple of other power supplies for the sub-amplifiers, all bolted firmly to a fairly weighty W.E. rack. The time being ten ack emma Sunday morning, I suggested they join me at bacon and eggs and thought matters over. In the words of Napoleon (or was it Alexander the Great?) they came, they saw, and they had breakfast. An SOS was sent out to local hams, and with their aid the rig was eventually removed. . . .

And so we're off the air, but we're still carrying on. We've still got our receivers to work on, and many of the gang are doing some really good work on u.h.f. supers, so your crowd had better look to your laurels or we'll have you licked in that field.

The South London-Croydon hams are still sticking together. Some of us have been called up, some are away, but those left are still keeping the ball rolling. After all we can imagine just as much DX to brag about without rigs as we could when we had them. It's a pity we're not allowed dummy aerial operation, but we're not, so it's no good grouching. The consoling thought is that when war is over there will be tons of ex-government gear to be picked up for next to nothing, so look out for your ears when we do come on again. I don't know if the rest of the Empire is off the air, but I've heard ZS and ZL so apparently they're still allowed, unless they're pirating.

We're still keeping our local club on the map. . . . The R.S.G.B. Bulletin is still running, but commercial radio mags are feeling the pinch and are publishing small monthly editions at three times the price of their old weekly ones. I have seen QST for October, but don't know if I'll see any more — it's very hard to get dollars owing to the exchange restrictions, and I doubt whether magazine importers will be able to get us copies either for the same reason.

(Continued on next left-hand page)

PROBLEMS

PROBLEM: HOW MANY TURNS ON A 1/2" DIAMETER FORM 1/2" LONG MUST I USE WITH A 25 MMFL CONDENSER TO TUNE TO 4000 KC.?

$$L = \frac{10^9}{(2\pi f)^2 C} \text{ MIC DHENRY'S}$$

$$f = 4 \times 10^3 \quad 6.28 \quad 4$$

$$C = 25 \quad 10^{18} \quad 6.28 \quad 4$$

$$L = \frac{10^9}{[2\pi(4 \times 10^3)]^2 (25)}$$

$$= \frac{10^9}{15776}$$

$$= 63.4 \text{ MICROHENRY'S}$$

$$N = \sqrt{\frac{3A + 9B \times L}{0.2A^2}}$$

$$A = 1.5$$

$$B = 0.5$$

$$L = 63.4$$

$$N = \sqrt{\frac{(3)(1.5) + (9)(0.5) \times 63.4}{(0.2)(1.5)^2}}$$

$$= \sqrt{36 \times 63.4}$$

$$= \sqrt{1268} \quad 1268 \overline{)35}$$

$$65 \overline{)368} \quad 345$$

35 TURNS
ANS.

Handwritten calculations on the right side of the board, including a vertical multiplication of 1.5 by 4000 and other intermediate steps.

This Problem Quickly and Easily Solved with Type A Calculator

EASY

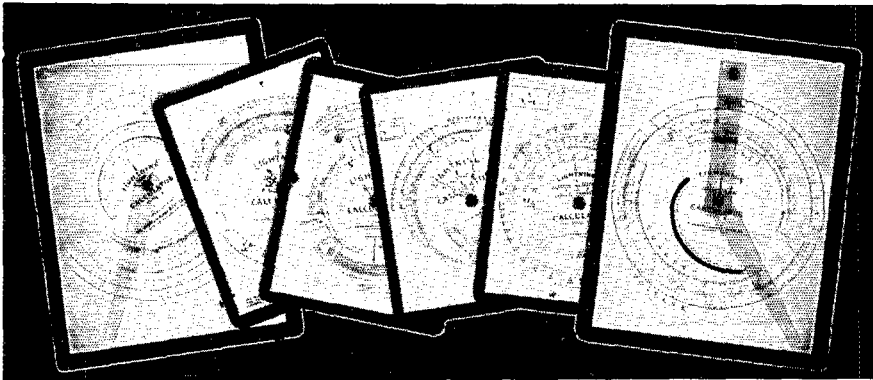

LIGHTNING CALCULATORS

Six Types Solve ALL Problems

TYPE A — For problems involving frequency, inductance and capacity, in design of radio frequency circuits. Direct reading answers for size of coils and condensers for any range between 400 kc. and 150 mc. Price, \$1, postpaid.

TYPE C — More information on electrical conductors than you could find in a book full of tables. Price, 50c, postpaid.

TYPE E — Direct reading total resistance of resistors connected in parallel, and total capacity of condensers connected in series. Price, 50c, postpaid.

TYPE B — Gives direct reading answers to calculations involving current, resistance, voltage and power with scale for resistance of copper wire and scale for calculating decibel gain or loss. Price, \$1, postpaid.

TYPE D — Gives decibel gain or loss when input and output voltages, currents or power are known. Price, 50c, postpaid.

TYPE F — Permits measurement of resistance, from 1 ohm to 1 megohm by use of a voltmeter. Makes an ohm-meter of your voltmeter. Price, 50c, postpaid.

AMERICAN RADIO RELAY LEAGUE, INC., West Hartford, Conn.

A High Quality MOUNTED CRYSTAL



AT THE LOW PRICE OF \$3.25

Monitor now offers you the new "Type E" Crystal unit at the extremely low price of \$3.25! Here, for the first time, is a factory mounted, factory tested and factory guaranteed crystal at a cost well within the reach of everyone!

"Type E" Crystals are of oriented cut, operating within the following bands: 160 Meter (Type E-16), 80 Meter (Type E-8) and 40 Meter (Type E-4). They are available in frequencies within .2% of specification, or choice from dealer's stock. Every "Type E" Crystal is mounted in the Monitor Standard Amateur Mounting, ready for installation. You get the benefits of a complete crystal unit, mounted at the factory, at a price comparable to an unmounted crystal and holder.

Get the assurance of a laboratory tested and guaranteed crystal, correctly mounted for dependable operation—specify Monitor "Type E" on your next installation!

MONITOR STANDARD AMATEUR MOUNTING

The cutaway view shows the Monitor Standard Amateur Mounting, used on all "Type E" units. Notice how pressure is regulated and maintained... how the crystal is completely protected from mechanical shocks... and how the large contact area against the top plate allows better heat radiation. Specially designed monel electrodes provide mechanical ruggedness for mobile operation and black bakelite body construction assures low losses. Remember:—regardless of type or price, Monitor gives you these and many other quality features in every crystal unit you buy—features that guarantee you quality higher than the price!

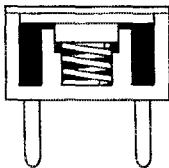

Monitor welcomes inquiries concerning crystal problems. When writing, please give full information on circuit design. There's no obligation, of course!

MONITOR

Piezo  Products Co.

1138 MISSION ST., SOUTH PASADENA, CALIF.

98

Maybe you'd like to know how we are getting on with the present bother running. (If you don't, then skip the rest of this letter.) I can only speak for London as I work in that burg. As a precaution we had sent most of our staff about 150 miles away around August 25th, and just a few of us were left to run things at my office. Ten-thirty on the Friday morning after, news came through of the invasion of Poland. Some said London would be bombed that very day, others said ridiculous, and offered to lay bets against it. But we were really too busy to worry, so after about ten minutes the thing was almost forgotten, and we more or less returned to normal. As I was working pretty late at my office I was staying at an hotel, and as I left my office about ten that night, and was crossing by the Bank of England, all the street lights suddenly went out. That was the last we've seen of them.

Tuesday, September 5th, we had an air-raid warning. I had given my hotel orders to call me at 7:15 that morning, but at 6:45 I was awakened by the air-raid sirens going off. They're rather reminiscent of your police car ones. I slung some clothes on and joined the rest of the visitors in the lounge where we all parked on settees and went to sleep. About 8:30 we got fed up, so a number of us trotted out into the Strand to have a looksee, but there was just nothing doing. Then we heard that the hotel had shut down their boilers in case of trouble, so we all bolted to the bath to grab what little hot water remained. I had just lathered my face when the "All Clear" went. And that was supposed to be an air raid.

Our two moans are about the blackout and the petrol restrictions. After dark no lights whatsoever may be shown from houses; from the outside they must appear unoccupied, and all street lights are extinguished. So once home at night you stay home. To walk out after dark means to fumble along in Stygian blackness the while you bark your shins on sandbags or bash your nose against lamp-posts. Traveling home at night to the suburbs is particularly unpleasant—not enough light to read by, so being English we just sit and glare at our neighbors without uttering a word.

We are allowed enough petrol for 150 miles a month, which makes running costs per mile so high that most of us have laid up our cars for the duration. Still even if we didn't, it's not exactly fun driving in pitch dark streets with just about as much light allowed on the car as a parking light gives, so it really doesn't matter.

Cinemas and theaters are open till ten, so here in London we have plenty of amusement. Life is more or less normal save for the blackout and the fewer private cars on the roads. I still have my bacon and eggs for breakfast, my coffee at eleven, my steak and pint of beer at one, my tea at four, and my dinner when I get home, so what the hell? For centuries the City of London has always stopped for its morning coffee and its afternoon tea, and it's certainly not going to give up ancient habits now—we're far too conservative.

Well, I think that's just about all, except that although I can't talk to you lads over the air, I'd appreciate hearing from you once in awhile.

Keep on the air, U.S.A. We like hearing you.

—Basil Wardman, ex-G6GQ

INANE BABBLING

Delta Sigma Phi House, Michigan State College,
East Lansing, Mich.

Editor, QST:

After a few hours of studying last night, I pushed switches and planned on spending an hour or two QSO'ing before going upstairs to bed. The rig was on "80 meter c.w." and, after a short three-way with a couple of fellows in Brooklyn, I swung the receiver up onto the 'phone band to see if I might stand a chance for a contact on 'phone. Well, I didn't get around to moving the transmitter to the 'phone band, but I did get my ears full of "Let Me Call You Sweetheart," "Girl of My Dreams," "Sweet Adeline," and at least a half dozen more such songs emanating from an "unidentified" station (Heaven forbid their signing a call!) on approximately 3940 kilocycles. . . .

Most of us like to go out and have a good time, and most of us have, at one time or another, violated a "reg" or two. But any person with the intelligence of a seven-year-old child should know that everything has its own time and place. After a ham has taken that extra drink the place for him is, but definitely, any place but in his shack! No one who

(Continued on page 102)

Station Operating Supplies

Designed by A.R.R.L. Communications Department

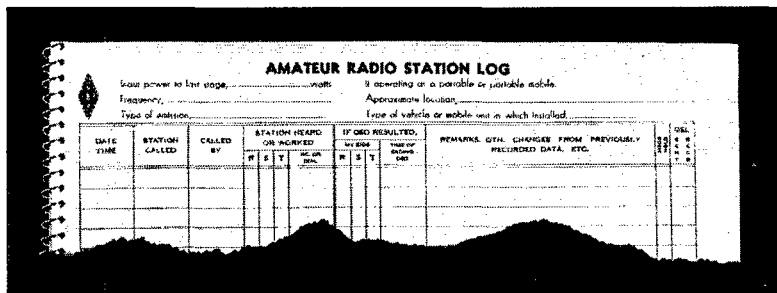

★
**THE
 LOG
 BOOK**
 ★

As can be seen in the illustration, the log page provides space for all facts pertaining to transmission and reception, and is equally as useful for portable or mobile operation as it is for fixed. The 38 log pages with an equal number of blank pages for notes, six pages of general log information (prefixes, etc.) and a sheet of graph paper are spiral bound, permitting the book to be folded back flat at any page, requiring only the page size of $8\frac{1}{2} \times 11$ on the operating table. In addition, a number sheet for traffic handlers is included with each book. The LOG BOOK sells for 35c per book or 3 books for \$1.

OFFICIAL RADIOGRAM PADS

The radiogram blank is now an entirely new form, designed by the Communications Department to comply with the new order of transmission. All blocks for fill-in are properly spaced for use in typewriter. It has a strikingly new heading that you will like. Radiogram blanks, $8\frac{1}{2} \times 7\frac{1}{4}$, lithographed in green ink, and padded 100 blanks to the pad, are now priced at 25c per pad, postpaid.

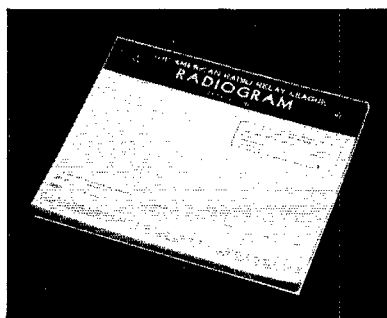

and MESSAGE DELIVERY CARDS

Radiogram delivery cards embody the same design as the radiogram blank and are

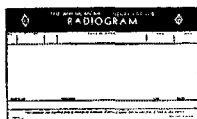

available in two forms — on stamped government postcard, 2c each; unstamped, 1c each.

AMERICAN RADIO RELAY LEAGUE, INC.

West Hartford, Connecticut

Station Activities



ROCKY MOUNTAIN DIVISION

COLORADO — SCM, Carl C. Drumeller, W9EHC — R.M.'s: 9EKQ & 9TDR. P.A.M.: 9IVT. EKQ hit the B.P.L. Jim is Route Manager for Northern Colo. IVT, the well-known Boulder 'phone man, is Phone Activities Manager; Warren has schedules into Honolulu and Manila, in case you have any traffic going that direction. RVW had his O.R.S. re-issued and is getting back into the swing. FKK, a new man at Lamar, throws 20 watts into a 6L6 osc. on 3.5 and 7 Mc. FAT is another new Lamar man. FCE, just licensed at Las Animas, has a Sky Buddy receiver and a Utah Jr. transmitter. WWW gave a talk on radio as a hobby over station KVOR. SAU is handling TDR's schedules while the latter is changing QTH. TFNL came to Denver from North Dakota. BML ground a crystal and got on 3.5-Mc. c.w. MOH is trying to get on 28-Mc. 'phone. QVZ, from Ft. Dodge, is attending college in Denver and is working 7 Mc., using a T-40. VQY is buying parts for a cathode modulator. YFJ moved his crystal frequency on 1.75 Mc. NBQ is new O.R.S. QEC applied for O.R.S. FCJ is new member of Colorado 'Phone Net, A.A.R.S. HFC finds time to handle traffic on a P.L. Traffic Net. FQT is new station at Grand Junction, using about 150 watts on 1.75-Mc. 'phone. MGX is lining up things in Grand Junction for possible emergencies. The Western Slope Radio Club has an emergency rig now. GDC has a new 71½-ft. tower. GKW is still working on his rig. There is a new amateur in Mt. Harris, call unknown, who is running a 100-watt rig. MGX says he is going to put in a pair of 812's and toss up an antenna 600 ft. long. CIN is going to go to higher power for c.w. work. NBK has a 3-element 28-Mc. beam. The following are reports of Colorado Springs stations and, if you think your particular community should be equally well represented, break down and send in some reports. Your S.C.M. is a poor mind reader, and most of Colorado's 600 or so amateurs seem to be frightened to death by the sight of a pencil and a postal card along about the 16th of the month. DZF took a crack at 1.75-Mc. 'phone. EEC is using a 6L6 rig purchased from LFE. EGH joined the A.A.R.S. and schedules TDR, as well as working 1.75-Mc. 'phone. EHC is working 1.75- and 3.9 Mc. 'phone, and putting the finishing touches on the new rig; he has worked out as far as 400 miles on 4 watts input on 'phone. EVT has an HT-6 transmitter and SX-24 receiver; she works 28- and 1.75-Mc. 'phone mostly. FBF, a new man, works 1.75-Mc. c.w. Incidentally, fellows, have you noticed how many c.w. stations there are on 1.75 Mc. now? And all work in the shared 'phone band. Why not try the c.w. band? FXQ has worked both coasts on 3.9-Mc. 'phone with 15 watts input. HDU has really been knocking them off on 28 Mc. Such choice tidbits as J2KN, LU4DJ, LU2AZ, LU2DG, KA1AB, K7ENA, K7GZH. HHD takes time out from college to handle O.R.S. traffic. JAV works from LIU while waiting to get his gas-engine generator going. JVR has been pushing over some choice 28-Mc. DX. JWC bought a house, and is moving his station. KKY joined the A.A.R.S., and is going to get in some c.w. work for a change. LFE is getting out of town with 1-watt input on 1.75-Mc. 'phone. LIU is having a swell time on 1.75-Mc. 'phone. SWM is experimenting with 1.75-Mc. cathode-modulated 'phone and keeping on 7 Mc., too. TFT is planning a rotary beam. YYO casts fond glances at his 808 and dreams of cathode modulation. ZCX is having trouble with his T-55. ZDW is hitting 1.75-Mc. 'phone now and then. ZHM is doing fine work with a 6L6-HY40 rig. Well, gang, let's have a few more reports next month. 73. — Carl, W9EHC.

Traffic: W9EKQ 707 WWB 66 NBQ 38 QEC 27 EGH 23 HFC 25 HHD 5 QDC 2 NBK 1 SAU 41.

UTAH-WYOMING — SCM, Ernest E. Parshall, W7CLG — 6LLH, R.M. Utah. 7GEE, R.M. Wyoming. UTAH: 6LLH is doing extra work for the Southern Pacific Railroad in Los Angeles and does not know just when he will be back in Ogden; he reports that 6PFX and 6KOP are in Cal. Tech. in Pasadena. 6FYR is resuming Trunk Line schedules after working at Los Angeles all summer. 6PGH received card from VK4JF, worked on 7046 kc., Aug. 14th, 6 a.m.. MST. 60WV schedules 7HFG every night. 6JXM has new steel antenna pole and receiver. 6ITW was married re-

cently. 6RV is putting up fine set of antenna arrays at a permanent location. 6NAJ has an 807 Tri-tet on 14 Mc. 6FRN worked OH509. 6QQE has new 809 final. 6QVY got a new bug. The Utah Amateur Radio Club held its first meeting of the season. 6DZX, Chief Operator of Police Radio KGPW, spoke on the police radio system; Mr. C. H. Manning, Assistant Chief Telephone Engineer for the United States Dept. of the Interior, Indian Service, gave a talk on equipment used in the service. 6RIV delivered a message from Montana in the morning and returned the answer in the evening. 6QQK has a two-section 8JK beam 40 feet in the air. 6QWI moved across the street from JXM. 6QOX and QUV moved from Fresno, Cal., to Salt Lake. 6RSX, new ham in Salt Lake, is on 14 Mc. 6RWY is on 28-Mc. 'phone. 6SBK, new Salt Lake ham, is on 28-Mc. 'phone. 6ITW has new beam designed by the PEN. 6PHW moved across the road. The P.P.N. is using spot frequency of 28940 kc. and is in full swing again. 6OQD is leaving on a two years' mission in Jan. and offers his equipment for sale. 6DZX is on 28 Mc. 6OAX left recently for a North-western States Mission. 6SCG is new Salt Lake ham. Petitions are being circulated by the hams in Utah to get their calls on their license plates. WYOMING: 7 GEE has new P.P. HK-24 rig on the air. He reports T.L. "E," "G" and "L" pecking fine business. 7CJR plans to take T.L. "G" soon. 7GZG reports 7HSO of Sheridan attending Univ. at Laramie and is on with pair of 809's in final. 7EVH is rebuilding. 7EUZ and HDS have horizontal "Z" half waves in phase.

Traffic: W6FYR 108 W7GEE 137 GZG 26. (Sept.-Oct.): W6EYS 71 FYR 21 PGH 13 OWV 4 RIV-QQK 3. W7GEE 51 GZG 25.)

NORTHWESTERN DIVISION

ALASKA — SCM, Leo E. Osterman, K7ENA — During July and August K7GNN took a trip down the Yukon River from White Horse, Yukon to Dawson, then to Ft. Yukon and Nenena, and thence via Alaska R.R. to Fairbanks, Anchorage and Seward, back to Juneau by boat, and to Chichagof (his QTH) by plane. He saw many hams on the trip, including K7GOJ, Skagway; VE5VW, Carcross, Yukon; VE5ADC, White Horse; VE5AIO, Selkirk, Yukon; VE5NEF, VE5AGC, VE5AGZ, Dawson; K7EVM, Ft. Yukon; K7HCX, K7FCH, Fairbanks; K7AZS, Anchorage.

IDAHO — SCM, Carl Eichelberger, W7EMT — ASA is QRL Signal Corps, National Guard. AVP moved back to Boise. BDL chased bugs out of rig. CTX is putting pair of 35T's in final. ESM, FZZ, 9AHR and others are operating UQ. FLJ moved back to his former QTH. GLP is active again on 1.75-Mc. 'phone. GYK is working in East for winter. HME is home and on the air again. EJM rebuilt and is putting out fine signals. HPD is new Boise ham. HPF is remodeling. HNQ is building 25-watt job for 1.75-Mc. 'phone. HKK plans on trying 28 Mc. GYY is back on 3.9-Mc. 'phone. GU is moving back to Boise. HOV is building 400-watt rig. PNI, HTR and FDH are at State Normal Campus on 14-, 7-, 3.5-Mc. c.w. and 1.75-Mc. 'phone. DWI plans on operating on trunk line. FQT is organizing A.A.R.S. 'Phone Net in Idaho. HKJ and XYL entertained hams at Twin Falls: DTF, DMZ, CJK and XYL's FQT, BAW, HKX, GAP, DWI, EYU, BDL and others present.

Traffic: W7ASA 56 BDL 19 DWI 12 EMT 30 FQT 12.

MONTANA — SCM, G. A. Woodhouse, W7FL — AOD visited S.F. and Minneapolis. BVI is experimenting with beams. CRU went to San Diego on a visit. GYB is holding down State Net and is outlet for traffic. CKG has 34 states with QSL-40 job. CPY has been busy at new QTH. EQC QSO'ed K7 with 20 watts, and his new 7-Mc. vertical won't let him QSO Montana stations. 6AJR/7 was on in Great Falls for a while. FSP has new e.c.o. and HQ120X, and wants to renew schedules with gang. GDB is opr. at Stryker C.C.C. FYN is at Joe College, but still on 7 Mc. BNL is on 3.9-Mc. 'phone at times. BIS is now BIS/7 at Kerr Dam. BXL is back at Volta for a while. 73.

Traffic: W7CKG 4 EQC 4 FZG 3 FL 5 GLM 10 GYB 28. OREGON — SCM, Harold W. Johnston, W7DXF — CYU made 102 contacts, 40 sections and 3 new states in the SS. HAL promises a bigger total next month.

Traffic: W7EBQ 1779 GPP 45 KV 33 HAL 28 EOY 24 BGM 21 GUA 20 CYU 2.

WASHINGTON — SCM, W. Beale, W7FCG — R.M.'s: 7WY, 7APS, 7FVK. APS consistently leads the traffic gang. WY reports AXA and ZK portable on 28 Mc. in Vancouver QSO with EDK; ZK's car got involved in traffic accident; police arrived in less than a minute, as a result of report to

EDK, who used the land 'phone. GIN purchased rock for R.C.C. Net; also rebuilt rig for 'phone-c.w. LD received appointment in Wn-2, also reports Rho Epsilon Net starting on 3585 kc. HAD has new 8JK 2-section on 14 Mc. CWN schedules GWE on T.L. "E," 7:15 p.m. FGQ reports Spokane Radio Club meeting attended by 30. ANI is working on new e.c.o. GUU has been providing K7EVM contact with his family in Seattle. AXS is rebuilding. The Tacoma Radio Club, on Nov. 13th, had the pleasure of talks by Jim Wallace, chief engineer of KVI, J. C. Picken, chief engineer Tacoma Police Dept., and Don C. Wallace, 6AM who showed motion pictures taken on the Yacht Contender during the race.

Traffic: W7APS 199 WY 178 FPN 135 GVH 63 GBF 52 GIN 47 ETO 39 LD 31 HAD 22 EPB 18 CWN 16 FGQ 12 APR 10 EVW-FLG 8 FNB 5 GRQ 4 FCG-CQK 3 ANI 2 GYA 32. (Sept.-Oct.): W7CMB 105 FPN 80 EPB 13.)

SOUTHWESTERN DIVISION

LOS ANGELES — SCM, Ralph S. Click, W6MQM — Ass't S.C.M.'s: 6PCA, P.A.M.'s: 6BKY, 6MQS, R.M.'s: 6IOX, 6FYW, 6PCP. MA says they are putting up Celotex in the shack to kill the din. 7EUY is operating portable here until he gets W6 call. Welcome to the gang, Dick. The Mike and Key Club of Santa Monica held a contest to see who could work the most states in 12 hours. First prize went to DIO, with NSC runner-up. The boys are happy over their new club house, the old KTM broadcast station near Clover Field; it is to be the A.E.C. headquarters for the Santa Monica-Venice area. The club "2½-meter" gang officiated at the National Speedboat Races at Balboa, as starters and timers. RJK has new Defiant receiver and 6L6 rig. 9TTR is in West Los Angeles now. The University High School Radio Club is started again, with RIU as pres., RCI vice-pres. DH schedules K6QUJ, KA1HQ, KB6OCL, 3GJY and 9EKQ! PCP makes B.P.L. on deliveries; doing nice job as R.M., too. FWY reports the doings of the gang up north. QKN is holding down 1.75-Mc. 'phone. DYQ reports from Santa Maria. Our thanks to LIP for the ACR136, KEI for the 1.75-Mc. rig, and the Radio-Television Supply Co. and the Fred S. Dean Co. for the donations for the Headquarters station of the A.E.C. at the swimming stadium. BHV is to be alternate on Trunk Line "M." Los Angeles Section loses a good man: AR has been transferred to Nevada; he will be up for the U. S. Airways at Las Vegas. 73, Bill. CMN is busy with A.A.R.S. OGM says 3.9 Mc. is opening up for DX. AM uses ¾-inch rope to hold up his beams. PFJ requests O.R.S. JQB ran a high score in the Oct. O.R.S. party with 25 watts; he has 35T now. PMV gets on over week-ends. NGK is building new rig for 28, 14, 7, 1.75 Mc. with 809 in final. 5EHP is an internee at Hollywood Hospital. SAO is new Monrovia ham. HOE received HOD for his home station call; HOE is located at the Fire Dept. OQH reports new Jr. op, a boy. Congrats, Hap. 9AJE is new arrival in Monrovia. My congratulations to A. E. Reese (Pop) of Glendale on getting his ticket; call is SCP. A lot of you 1.75-Mc. ops will remember Pop over various Glendale stations; he is blind but, nevertheless, very happy. IWE appointed GM Ass't Emergency Coordinator for the San Bernardino-Riverside area. RYR will QSP Hawaii traffic. GJP is getting his rig set up on 3.5 Mc., using a 212D in the r.f. final. MYH is on 7 Mc. most of the time. KP in Arizona on location has schedule with CMN. ETI is still on 28 Mc. PSX has one rig on 28 Mc., another on 1.75 Mc., and is building one for 3.5 Mc. All you members of the A.E.C. who are not connected with a local unit, here is a list of the various Coordinators; please contact the one for your area so you can do your part to help them complete their organization: MYH, Burbank; OQX, Santa Barbara; GYU, in Glendale; LIP, Beverly Hills-West Los Angeles; DEP, Long Beach; HGN, Hondo-Downey; AQJ, Santa Monica-Venice; IWE, San Bernardino-Riverside; PCA, Maywood-Bell-Southeast; HOE, Monrovia and San Gabriel Valley; JQB, Covina and Eastern San Gabriel Valley; MLJ, Pomona-Ontario; RLL, Inglewood-Centinel Valley; CAH, Van Nuys-No. Hollywood; NXJ, Ventura-Oxnard; HUX, Los Angeles; also NAT is Coordinator for the 28-Mc. mobile boys. If you have a mobile outfit in your car, please let Nat know; you can get him at 950 So. Broadway. If there is no Coordinator in your area, please let me know, or if you are not sure who you should contact, a card to me will get you the dope. The Emergency Corps is moving fast now with the opening of the headquarters station in the swimming stadium. The place was turned over to us by the Department of Play-

grounds and Recreation of the City of Los Angeles. LDV PGL, KGC, AUO, PNH and RIR joined the A.E.C. The Mike and Key Club of Santa Monica and the Santa Barbara Club got affiliation charters from A.R.R.L. A Very Happy New Year to you all! Let's resolve to make the New Year a bigger and better one for the A.E.C. Let's all get behind it and do our part. 73. — Ralph.

Traffic: W6DH 1182 IOX 448 PCP 355 MQM 169 DYQ 168 CZO 117 LIP 90 MTS 89 MYT 60 AR 40 CMN 37 OGM 15 MQS-AM 9 BHV 8 PFJ 6 JQB 5 PMV 4 NGK 3.

ARIZONA — SCM, Marson B. Hull, W6KMM — R.M.'s: 6KFC, 6NRP-MNH. The Oct.-Nov. period showed activity over the state to be greatly on the increase. The A.A.R.S. Net is in full swing and handling considerable traffic. Anyone interested in this activity and in meeting a fine bunch of operators, contact John K. Oliver, W6KOL, at Nogales, or break in on 8865 kc. JRK is new Phoenix Emergency Coordinator. John Girand, KVL, our new Regional Emergency Coordinator, plans a statewide competition and a QSO party for stations interested in emergency work. Under the supervision of KVL, we hope to provide an incentive for more stations to enter this field and incidentally derive a lot of satisfaction and fun they have been missing. The Phoenix J. C. Club is doing some fine experimental work on 112 Mc. KFC is rebuilding the club transmitter KVE, MVB is working on 56-Mc. rig for model airplane. The Phoenix Club is conducting a membership drive. FZQ is hoisting another new beam. EGR, formerly of San Francisco, is on 14 Mc. in Phoenix. MME, near Tempe, is on 28 Mc. RCT is rebuilding. OFS plans a novel band-switching e.c.o. exciter. JRK is getting FB results with low-power emergency rigs. OPV has new RME70, DB20 and a complete portable rig. CDU is on 3.5 and 7 Mc. after two years off the air; Bob runs 100 watts to an 812. OMD has new end-fed Hertz antenna. OWX runs 250 watts on 1.75-Mc. 'phone. OJK puts his kw. into a 40-foot high half-wave delta matched antenna; George got 89 reports in South Africa on 28 Mc. with this set-up. PGO changed to delta matched antenna with 15 db. gain on 14 Mc. PCB has new antennas, and went to town in SS on 28 Mc. LYU visited in Tucson. Gene is working portable at Morenci. OVK in Tucson, QLZ and KJT in Phoenix are conducting 56-Mc. tests, and hope for a Phoenix-Tucson relay. RKL is working on new rig with cathode modulation. OVK cathode modulates 150 watts to a pair of 809's with a single 6L6G. NRP-MNH is starting code classes on 1.75 Mc. 73. — Mar.

Traffic: W6NRP 411 KOL 127 NXO 51 IYZ 35 GBN 32 OPV 23 LAI 20 RZN 16 KMM 5 OIF 4 CDU 3. (Sept.-Oct.): W6BMC 100.)

SAN DIEGO — SCM, Howard K. Breedlove, W6JRM — Ass't SCM, Barney Boyd W6LYY, R.M.'s: 6AXN and 6GTM. Some of the stations that took part in the SS: MUS, ISG, NIK, GTM, EPZ, LUJ, PGE, AXC, FZH. The gang at Santa Ana High School organized a Radio Club. OUQ has a 211 in the final. RBA is in the Navy now. DHP exchanged radio for an XYL. FCT is getting rig on the air. BKZ is on all 'phone and c.w. bands with 60 watts to a T40. BAM has daily schedule with FEQ. EOP is on 28-Mc. 'phone once in a while. PDH is moving to Washington state. MKW is on 3.5 and 3.9 Mc. with 807 final; Hugh reports a good time at 3.9-Mc. Breakfast Club picnic, Nov. 12th, at Idyllwild. BGL of Escondido was there, too. MMV is back on 3.9-Mc. 'phone after several months of rebuilding. EPW and XYL have a new baby girl. Congrats, Vern and Ruth. The Palomar Radio Club of Escondido entertained the Helix Radio Club and the Escondido High School Radio Club at meeting on Nov. 13th. There were several speakers, a good raffle, good eats, and a good time was had by all. 73. — Howard and Barney.

Traffic: W6LUJ 248 MKW 122 GTM 78 FZH 118 ISG 44 BAM 38 BKZ 22 QUQ 15 DBV 14 EOP 2.

PACIFIC DIVISION

NEVADA — SCM Edward W. Heim, W6BIC — UO reports new ham in Yerington, ATF, operating on 7 Mc. FVO participated in the Reno Annual Fire Prevention Week and had the chief of the Fire Department and the president of the Jr. Chamber of Commerce at his shack, where they enjoyed several pleasant QSO's. He and GSB were in the SS using 14-Mc. 'phone.

Traffic: W6UO 34 FVO 30 BIC 16.

SANTA CLARA VALLEY — SCM, Eibert J. Amar-

(Continued on page 104)

✓ CHECK THESE EXCLUSIVE SPRAGUE KOOLOHM FEATURES BEFORE YOU BUY RESISTORS

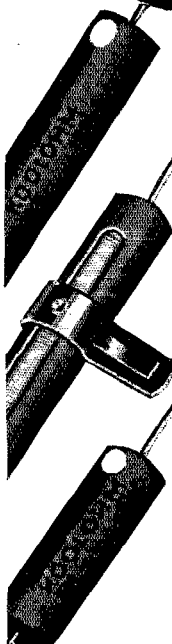

The biggest improvements in power wire wound resistors in 20 years — for no more money you get the latest and the best.

NEW COATING . . . Every bit of wire insulated before winding!

NO SHORTED TURNS . . . Wires touch but don't short!

COOLER OPERATION than any other resistors of equal rating!

LARGER WIRE SIZE . . . Greater safety — interleaved windings — more capacity in smaller sizes!

THE ONLY TRULY INSULATED WIRE WOUNDS . . . No cements or brittle enamels!

NEW TYPE PIGTAIL . . . Stands more twists and turns.

TELEDOT WATTAGE INDICATOR . . . Indicates overloads automatically!

TRULY NON-INDUCTIVE RESISTORS . . . at amazing low prices! Zero inductance at 50 megacycles; distributed capacity only 2 mmfd.

FULL WATTAGE RATING . . . Use all resistance values at full wattage rating!

5% Resistance Accuracy Guaranteed

See Koolohms — test 'em! Now featured by leading jobbers. Catalog free on request.



GONE! → ALL DANGER OF ACCIDENTAL CONTACT

Insist on Sprague Transmitting Condensers with exclusive Life-guard Terminal Protection Caps. Life-guards are FREE with every Sprague High Voltage Condenser, or sold separately at 15¢ per pair. Just the thing for any exposed terminals. Used and approved by A.R.R.L. This year's A.R.R.L. Handbook uses Sprague Life-guards in most of their circuits. And don't forget; All Sprague Xmitting Condensers are both oil-filled and oil-impregnated for double safety — NOT merely oil-filled and wax-impregnated.

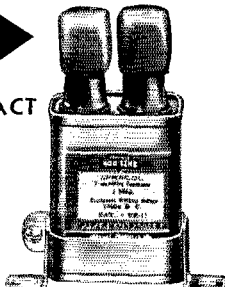

A complete line of round and universal mounting rectangulars — now at lowest prices in Sprague history. Catalog free!

SPRAGUE PRODUCTS COMPANY
NORTH ADAMS, MASS.

Correspondence Department

(Continued from page 98)

is not in absolute control of all his faculties has any business being in a place where death by electrocution is never more than a few feet away. . . . Think about it fellows, and try to remember, regardless of how many you've had, to stay away from your station when you're not cold sober. And for your own sake — yes, and for the sakes of all the amateurs in this country — if you do go into the shack, be mighty careful, and please reach for the key instead of the mike so that the general public won't be subject to your inane babbling.

— Joe Hassett, W8PVB

NOVEL ANTENNA TECHNIQUE

1015 Ilex St., Houston, Texas

Editor, QST:

I have come to the conclusion that now is the time to unburden my overflowing heart. I wish to discuss antennas. For the past twenty years I have been industriously investigating antenna phenomena. I have built the huge 80-foot high and 100-foot long antennas used in the old spark days. . . . I have used verticals, Zepps, off-center-fed, Marconi's — beams of all kinds, sizes and colors. I have spent sleepless nights wondering which was the better antenna. I have learned great quantities of new cuss words trying to tune the things right to the exact point of efficiency. Yeah — I have done all those things even as you have. But — one thing I have never done. I have never built a tuned, untuned, or twisted pair feed line that didn't have standing waves on it.

Most hams, especially the old timers, swear by the Zepp-fed lines. For many years I have pondered this question. I have always maintained that the Zepp-fed system is a classical example of standing waves on feed lines. I don't think that I will get much argument regarding the results obtained using Zepp feeders. We all know how they operate.

I have collected authentic information regarding cases where fellows had their antennas torn off of the Zepp feeders by winds and still were able to operate the station with fair results.

I have made charts, calculated stray superfluous fields, measured electronic flow, and otherwise investigated antenna phenomena, and I have come to a most astounding conclusion.

I have discovered that antennas are utterly useless. I have used one of my feed lines, the common 500-ohm variety, and very carefully cut it at a random length and thereby secured most excellent standing waves; and without the assistance of any antennas at all I have sent signals over tremendous distances. Those of you who work 10 meters will no doubt have heard me doing antenna work via W5CCU. I have developed this most astonishing transmission technique and wish to pass it on to experimenters. I find that the feed line works better if it is transposed every 3 feet. However, twisted feed line functions very well also. I have never had any trouble in securing standing waves along twisted feed lines.

Now, any of the boys desiring to use this most remarkable antenna system, just put up the feed line and leave off the antenna. You should have no trouble at all securing standing waves; I don't. Just turn on the rig and presto! the DX just rolls in.

(P.S. I find that the affair works better if the feed lines are separated so that they are at right angles to each other and in the same plane. Hi!)

— Jim Hunt, W5TG-W5CCU

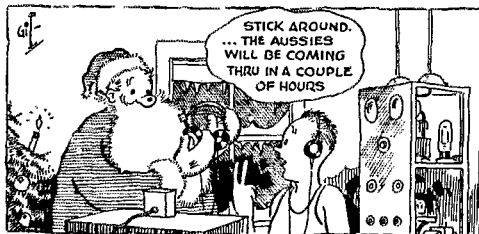

Gil drew this for our Christmas issue — we wish it were true! — Ed.

a NEW RECEIVER for the NEW YEAR — Yours on Newark's Easy Credit

CABINET BARGAIN

Complete with front panel to match **Only \$2**

Black crackle finish heavy gauge metal. Hinged top door. 12 1/2" high, 19" wide, 11 1/2" deep. Just right for an FB table model rig or for that mobile job. Shipping wt. 16 lbs. (No. PX-1) **\$2**

Chassis to fit this cabinet, 10" x 17" x 3" **80c**

YOUR CALL LETTERS IN GOLD! 10c

Big shadowed decalomania letters nearly TWO INCHES high. Put them on your HAM SHACK door, auto window, etc. Send dime for yours today. Be sure to give your call letters.

FREE!

NEWARK'S BIG NEW 84 page Catalog

Thousands of items for the Ham. Sets, parts, accessories, and supplies, fully illustrated and described, with lowest prices. Newark's most complete Amateur Radio Catalog.

SEND FOR IT TODAY!

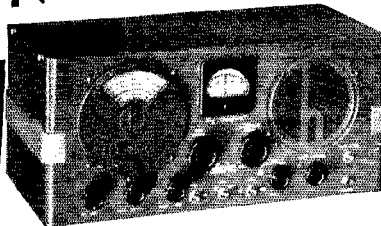

Hallicrafters
S-20-R..... **\$49.50**

Entire Cash Price Complete

HALLICRAFTERS	Cash Price	Down Payment
SX 24.....	\$81.50	\$16.30
SX 23.....	127.50	25.50
Sky Buddy.....	29.50	*
S-20-R.....	49.50	*
Sky Rider S10.....	69.50	13.90
Sky Rider Marine.....	64.50	12.90

*Indicates sets sold for cash only

NEWARK SPECIAL FILTER CONDENSERS

Oil Filled, Oil Impregnated

Order NOW for IMMEDIATE SHIPMENT

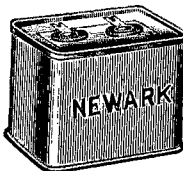

DC Volt	Mfd.	Size	Wt.	Price
2000	2	4 3/4 x 3 1/4 x 1 3/4	1 1/4 lbs.	\$1.50
1250	2	3 1/2 x 3 1/4 x 1 1/4	1 1/4 lbs.	1.25
1500	3	5 x 3 1/4 x 1 3/4	1 1/2 lbs.	1.50
1500 4.4	5	5 x 3 1/4 x 1 3/4	1 1/2 lbs.	1.75
1500	5	3 3/4 x 3 1/4 x 1 1/4	1 1/4 lbs.	1.50
2000	8	5 x 3 1/4 x 3 1/4	2 1/2 lbs.	2.75

\$1.00

1000 v. DC. 2 mfd.
2 3/4 x 1 3/4 x 1.
Weight 1/2 lb.

GUARANTEED
AT RATED
VOLTAGES

NATIONAL NC101X or NC101XA
WITH NEW NOISE LIMITER

Only **\$25.80** Down (Cash Price **\$129.00**)

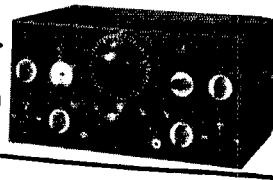

ORDER DIRECT FROM THIS AD TODAY

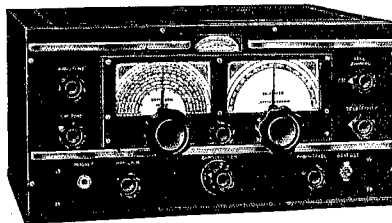

National NC101X, NC101XA, and NC100XA are now equipped with noise limiter at no extra cost!

NATIONAL	Cash Price	Down Payment
NC101X.....	\$129.00	\$25.80
NC101XA.....	129.00	25.80
NC100XA.....	142.50	28.50
NC44.....	49.50	*
NC80-81X.....	99.00	19.80
HRO DeLuxe.....	179.70	35.94

Send down payment with order, add 6% carrying charge to balance, and divide into 12 monthly payments or less. All sets complete, ready to use.

RME 70 **\$27.72** DOWN

	Cash Price	Down Payment
RME 70.....	\$138.60	\$27.72
69.....	152.88	30.58
70DB20.....	181.80	36.36

Combination — All Sets Complete

HAMMARLUND HQ 120X

\$27.60 DOWN (Cash Price **\$138**)>

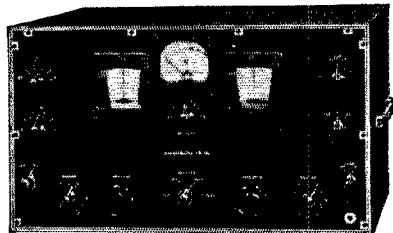

NEWARK

Electric Company

323 W. MADISON ST.
Dept. Q CHICAGO, ILL.

(Continued from page 101)

antes, W6FBW — 6LLW, R.M. 6LXJ, P.A.M. JUQ checks in on the Mission Trail Net. NGC is a new reporter. Welcome, OM. SDF, new San Mateo ham, will be on with P.P. 809's. RTD operates on 3.5, 7 and 14 Mc. LCS got his rig on 14 Mc., and says it's lots of fun. In 30 days PVB had 357 QSO's. The San Mateo Junior College station YU is now on 7 Mc., and the club has a feed every other Friday. CFK has new Wilcox radio and recorder. KG is giving cathode modulation a whirl. NUL is trying to get a 6F6-6L6 to work on all bands, 'phone and c.w. K6DV visited OHC. CRF is building an FB new home for his bride. BYY has been appointed Chief of Police of Carmel. Congratulations, Bob. NAL is slowly recovering from the illness that kept him inactive all summer. JAT is back in town and active in the C.C.N. Well, gang this winds up another year and as we stow it away in the pages of history, the ol' SCM wishes to thank you for the splendid cooperation you have given him in sending in reports, etc. I hope each of you has a most enjoyable holiday season and that there will be lots of luck and DX in store for you in 1940.

Traffic: W6LLW 378 JAT 62 FBW 66 YG 33 JTE 31 JUQ 18 NGC 11 RTD-LCS 5 PBV-BPT 2

EAST BAY — SCM, Horace R. Greer, W6TI — R.M.: 6ZM — P.A.M.: 6ITH — The Section meeting was held at the Hotel Leamington on Nov. 15th with 6WB, Clayton Bane, guest speaker, giving us all a splendid talk on the U.H.F. Those who miss the meetings are truly missing something. Always a good speaker, only a few minutes of business, and no fooling around. Come on down and see what



Horace R. Greer, W6TI, S.C.M., East Bay. In charge of publicity at W6USA, TI has the task of answering and tacking on the walls of the exhibit the thousands of QSL cards received by W6USA — and this in addition to his normal duties as W6QSL Manager!

you have been missing. It looks like TT wins the SS for c.w. in the East Bay with 351 contacts, all but 3 sections, with ITH taking the 'phone SS honors with 451 contacts, 55,800 points. OCH was making a race out of the 'phone contest until company arrived over the last week-end! OMC has new 7-band rig, 1.75 to 112 Mc., and reports that OAO and OBJ have been appointed Asst. Emergency Coordinators. HTE is working from Mt. Hamilton on 112 Mc. and working into the East Bay. FB. OMC had 8 messages and 52 points in the U.H.F. contest, and claims this is a very excellent band, better than 56 Mc. for local work. ONQ has his new big Calif. Kill-a-what on the air. FY, BMZ, JEE, AQN, AOJ, DUA, CUG, NZ and CBF can generally be found with the XYL's one night a month at the RRA get-togethers. The "Champ" EY is working on cathode modulation. IMI ran up a good score in SS. DHS has given up 14-Mc. DX for 7-Mc. rag chewing, IPG is rebuilding. QPT reports the A.C.R.C. had an FB skating party on Nov. 10th, with over 60 attending. OLL was chairman. CDA never misses a Section meeting; best ever, says Andy. LMZ is getting more active these days. PFK picks up a lot of good traffic from the local Y.M.C.A. TI, yours truly, is planning on returning to 7 Mc. The following attended last Section meeting: CDA, IMI, HH, KQQ, KTI, HTY, BMT, AAU, AN, EY, TT, ZM, ZX, RZS, RRU, LGW, QPT, PLC, TI, JEE, WB, ex-6W6LPD and ex-W4DY.

Traffic: W6IMI 201 ZM 165 HH 143 CDA 99 (WLMH 93) KZF 89 EJA 86 PFK 53 ITH 50 OMC 44 FOC 43 EY 31 IPG 13 DHS 5 LMZ 4.

SAN FRANCISCO — SCM, Kenneth E. Hughes, W6CIS — P.A.M.: 6CSX; R.M.'s: 6LMD, 6PGB. LPX received card from Africa, making W.A.C. with 6L6 osc. PGB turns in his usual fine report with plenty of traffic and a bulk of O.O. work plus a real SS Score. GYO is rebuilding the 3.9-Mc. rig. JPW sticks to 14-Mc. 'phone. SAT is planning on 28-Mc. 'phone. SG added KP6 to his list. RBQ schedules 9ILH three times weekly; looks like he was high in

the SS for this Section. NAO is busy with N.C.R. work. ZS is keeping his schedules in fine shape, handling considerable worthwhile traffic. NNW is going after the DX. CWR has a new skywire. LEP is new one up Eureka Way. RYX uses pair of HK24's and a Meissner on 7 and 14 Mc. RNL likes to ragchew on 7 Mc. PTV is getting out in good shape. RSH finds time to gather considerable traffic. MCQ has new Johnson "Q" which puts real signal into the East. GL and HUB can be found occasionally on 3.9-Mc. 'phone. ADM is regularly on 3.9 Mc. CBR is very active in A.A.R.S. BIP handles lots of traffic, and did well in the SS. MZ is giving 7 Mc. a whirl. QL snagged OQ5 and CR9 for two new ones. PQF is playing with homemade hetrofil. NNF was active in the SS. CIS completely rebuilt into rack and panel with new final. PZW spends most of his time at 6TA, N.G. station. KUK is back on 3.9-Mc. 'phone. LMD came through with sizable total resulting from his schedules, which include C.C.N., A.A.R.S. Trunk Line "B," 6MYT, and occasionally Trunk "F." PGF expects to put his 250TH's on 28-Mc. 'phone in place of the 35T's. NGV sticks to 3.9-Mc. 'phone. SDT is new call. Welcome, Vic. IBQ is rebuilding for 809's on 28 and 14 Mc. BFZ redecorated shack and, with the new gear, has nice layout. MRZ is wiring the new shack for "W6 PG & E." QGN is changing GRT, the school station, over to cathode modulation. JTP has 45 watts on 28 Mc. RAK changed over to cathode modulation. BUJ reports the arrival of a new YL opr. Congrats. MFE, top traffic man, is now O.B.S. on 3.5 Mc. PVC is running 150 watts on 28 Mc. MUF completed W.A.C. OKB stays on 28 Mc. ZI is going on 14-Mc. 'phone. IUH finds time on the week-ends for 3.9-Mc. 'phone. FVK is on 7 Mc. with the new HK354 (won at the Marin County Hamfest) running 450 watts. MGB has new rotary and desk control perking FB. New officers of Marin County Club: Pres., FVK; Publicity, JMR; Program, C. Cherry; Prizes, GZE; Traffic, JTP. This Section is now in a position to clear traffic in all directions, including KA, K6, K5 and K7. — 73 — KH.

Traffic: W6MFH 426 PGB 319 LMD 246 NLL 194 (WLV 57) RH 114 BIP 107 RBQ 57 ZS 55 CSX 17 CIS 16 SG 12 OOC 2

SACRAMENTO VALLEY — SCM, Vincent N. Feldhausen, W6MDI — R.M.: 6GAC. P.A.M.: 6KKL. The Yreka Amateur Radio Club meets each Wed. night at one of the member's home. PKR and CBD are the big shots of this FB organization. 7AUQ is now 6RJK and is making YREKA his permanent QTH. 6PBH, who for several years has never run over 5 watts, is going high power with a 35T. RXY is a new ham. RJL is going on 28 and 14 Mc. with a new final. CBD and PWS are putting up poles for new sky hooks. REB is publicity man for Yreka Amateur Radio. RYL moved to Dunsuir from Los Angeles; you will soon hear his FB fist on 3.5 and 7 Mc. 7EUP of Seattle was a visitor at MDI. We were glad to receive EUH's application for O.R.S. BDX sold out to ATQ. NCV was busy on SS. The Sacramento Valley Section Net is now planted on 3725 kc., and meets tri-weekly at 7:30 p.m.; they tie in with C.C.N. and A.A.R.S. Qualifications for membership: Applicant must be O.R.S. Get busy, you fellas, and drop GAC or MDI a card for info. DDC is revamping shack in basement of new QTH. KUN has new cathode-modulated rig. MAF worked SS on 1.75 and 28 Mc. We heard MAF, NCV, MDI, DZW, NHA, PAR, EUH, RMT, NKT, GAC and others in the SS. That's the spirit, gang. Thanks for the FB cooperation. MDI is building new rig with 100TH final. GAC gets on the air for only a couple of hours in O.R.S. Party and runs up a better score than the whole dangd outfit who have been on nearly entire time allowed! KKL is working c.w. for a change. Please send your local or Section news to MDI before the 18th of each month if you would like to see it in this column. Traffic reports also greatly appreciated. Very best of good wishes to all for the holiday season. — VIC: W6MDI, S.C.M.

Traffic: W6MDI 393 GAC 24 HPB 18 CGJ 24 DVD 9 EUH 4 IAP 30 GZY 50 DZW 19 NCV 12 KKL 39 CC 74 PFH 67 BPQ 3 FQU 32 MFD 32 MAF 12.

SAN JOAQUIN VALLEY — SCM, E. A. Address, W6KUT — CFN, MVK: E.C.'s. IWU has Bassett cable in his antenna system; he is on 3.9 and 28 Mc. QDT has a 3-element beam and 150 watts on 28-Mc. 'phone. MIW is now in Modesto. CFN, MYP and NTP recently received bundles from heaven! AV works on 3.5 Mc. EBH has a neat 28-Mc. converter — his brother runs QST auto camp on Highway 99. NDJ works on 7 Mc. MRB, KEV and John Sweeney are constructing a portable gas-engine generator outfit. CUL moved to Los Angeles; he works the high end of

7 Mc. MFV is getting back with a Browning 35 and RK39 for a final — 1.75- and 3.5-Mc. c.w. BXB (Pop) added to his long list of memories those of the S.F. Convention. QFR has an ideal station set-up — separate transmitters for each band and a neat little portable mobile job for the car — Ted is going to keep KG schedules so that the Fresno State College football team can talk to their folks here in town while they are in the Islands. AXI is on 28- and 1.75-Mc. 'phone with 100 watts. Report from SAH indicates a rebuild with a pair of 250TH's in the final, 960 watts — 250TL's modulator with a push-button exciter unit. RQL is a new ham and welcome member of the Basic A.E.C. QYP works 7 Mc. NGT is attending college in S.F. RTL is a newcomer on 1.75 Mc. CSX paid a visit to some of the fellows he has contacted over the air. NGW has a well-built homemade super. EOD is on 3.9- and 14-Mc. 'phone. PLJ is on 14 and 7 Mc. Bakersfield's SWL-1, the second op at BRP, recently produced a little second op — commonly known as SWL-1 prime. One or two more QSL's and MEK will be in the DX C.C. I RSQ has a new Kaar transmitter on 1.75- and 28-Mc. 'phone. JPU has a neat little Guthman rig on 28-Mc. 'phone. PSQ is on 28-Mc. 'phone. GCF will work portable-mobile from his car with his Guthman transmitter. PPO has a shack that is making us green with envy — drop in and see a real *shack!* BPV is using a neat little 28-Mc. transmitter in his car. HS, one of the assistant directors of the Pacific Division, spends a great part of his time around Fresno — he hails from the Bay Region. QLY worked 4 states on 1.75 Mc. with his little rig. LOO is getting "hitched" to the YL. One of the Valley's oldest hams — CVT — is leaving Fresno for Phoenix, Ariz. JCB has a nifty new shack which he constructed himself — upon seeing the job, JPU had John remodel his. PCS along with some of the Bakersfield DX "biggies" worked himself a nice new country with U9AW. KWA is the first local lad to make DX C.C. Some of the Valley boys were certainly surprised when PJ5EE dropped in on them. 73, gang, and let me have the dope on your neighboring hams. — Ed.

Traffic: W6CFN 235 NJQ 81 JPU 89 IWU 30 MVK 19 KUT 4.

WEST GULF DIVISION

NORTHERN TEXAS — SCM, Lee Hughes, W5DXA — ECE is working on 8-element Premax rotary. CV, DUZ, AHX and HIP are new O.P.S. The Dallas Amateur Radio Club exhibited W5LME, the club station, at State Fair of Texas, Oct. 7th-22nd. Message handling rag-chewing headed the list of activities. Licensed members of the Dallas Club include: GZH, ECA, HIP, CMK, GSE, 60GP, 5HOC, POB, IBE, CY, CHJ, CJJ, HHU, FSG, BNQ, IHJ, IJD, IJC, CEV, III, HIR, HSC, DJF, DW, EDB, DLP, EQJ, GPA, GSR, EER, EXW, DAS, FVE, CJE, DAM, JJ and HYK. At the Oct. meeting of the Kilo-cycle Club (Ft. Worth), a committee was nominated to handle the 1940 West Gulf Div. Convention, as follows: GKA, ELC, FJP. The club will handle all B.C.L. complaints against amateurs in the Ft. Worth territory; HCA was nominated chairman of the Complaint Committee; this committee will work closely with the F.C.C. office.

Traffic: W5EOE 295 HFN 50 BAM 70 FMZ 19 DXA 18. **OKLAHOMA** — SCM, Carter L. Simpson, W5CEZ — retires as S.C.M. for Oklahoma and turns reins over to GFT, who has been elected to that office. FOM was selected alternate Net Control for Okla. A.A.R.S., and is assigned special call WLJY. GFH is another new Alt. N.C.S. with call WLJO. ERW is still originating some good traffic. DAK is working hard for advancement in N.C.R. DTU has been appointed Route Manager to take over some of the work carried by EGP. FRB reports his new HQ-120X a swell receiver. BOR went to town in the ES. GZU is a Morse Telegrapher, so don't worry about burning him down. EMD has new R.C.A. 811 in his rig. FRZ is back on at new location in Weleetka. FRW is out of the Army and living near St. Louis, Okla.; he gets all his power from a gas-engine-driven generator. GAQ has been active in helping the club at Bartlesville get organized. GZE is rebuilding to try to get away from harmonic trouble. YJ is located at E.E. Dept. of Okla. A. & M., and is getting under way again with "Hal" EGA as chief op. The OhPeKah Club will hold general get-togethers the 3rd Wednesday night each month at some member's house or shack, for promotion of interest in the club; a Radio Study Club will meet Thurs. each week throughout the winter, covering various subjects of Laws, Rules, Theory, Fundamentals, etc. At meeting of Nov. 1st, at Maire Hotel, under the direction of 5GAE, 16' members

were present and 5 guests from out of town. Talks by 5ATB of Tulsa, on clubs and club activities. Other visitors 9YLY, President of Coffeyville Club; 9TKF, Vice-President of Coffeyville Club, and Wm. Lynn, also of Coffeyville. A Dutch lunch was served, through the courtesy of P. G. Gaddis, and an enjoyable evening had by all. We all congratulate the Muskogee Radio Amateur Club and the OhPeKah Club at Bartlesville which are now A.R.R.L.-affiliated clubs. The gang at Oklahoma City have organized, and are applying for affiliation. The Muskogee Club is publishing a monthly bulletin called the "Bloopers," and its author and editor, EGP, is to be commended on his fine work. The Bartlesville Club is having some very interesting meetings, and visitors are welcome. This is the last report to be prepared by your old S.C.M., W5CEZ, who has been doing it for the past five years. A word of appreciation is hereby given to those who have been so loyal and have given the utmost in cooperation during this time. It is only hoped that you will all give "Russ" Battern, W5GFT, your new S.C.M., that same kind of cooperation. Make your reports promptly on the 16th, and include items of interest about yourself and your station along with your traffic report. It will be a big help to him. Keep Oklahoma Section on the map and in QST. — 73.

Traffic: W5CEZ 620 (WLJC 88) (HESB 55) GFT 227 (WLJE 26) FOM 110 GFH 90 ERW 80 DAK 65 DTU 53 FRB 49 BOR 44 GZU 42 GVV 26 EMD 25 FRZ 24 FRW 21 GAQ 19 GZR 15 YJ 13.

SOUTHERN TEXAS — SCM, Dave H. Calk, W5BHO — CWW reports for El Paso. Majority of El Paso gang are on 28 Mc. CWW, FYU and HEB took part in the SS. EVJ and CWW succeeded in completing a QSO on "2 1/2 meters," best DX being 20 miles. EGI is still trying to get his rig "2 1/2." EWZ enjoyed SS. New O.R.S.: DDJ. We regret to report the death on Nov. 7th of W5BRC, our Alternate Director. 5BRC will be remembered long by all who know him. IIE keeps several schedules on Sat. GLS works Gulf Coast Storm Net on 7 Mc. on Sunday A.M. and spends the rest of the week on 14-Mc. 'phone. BBK is trying to get on 14 Mc. using 7-Mc. doublet and twisted pair linked to the final. HVN reports working some DX. MN works eight schedules every morning, and is on Trunk Line "K." DWN keeps regular schedules on the A.A.R.S. Net.

Traffic: W5OW 2522 FDR 1157 MN 890 DLZ 166 DWN 142 DDJ 116 CVQ 90 CWW 78 EWZ 10 GLS 6 IIE 1.

NEW MEXICO — SCM, Dr. Hilton W. Gillett, W5ENI — ZM again heads the Section in traffic. DGP increased power. HAG heads newly formed U. S. Weather-Bureau Net. HJF maintains many daily schedules. FSP pounds brass between shifts at potash mines. HDN is back from portable location with C.C.C. boys in mountains. BKD and HRB operate police radio at Clovis. DGP recently found an abandoned, apparently stolen automobile. He reported his find by general broadcast to the State Net, and within 10 minutes had located the owner via HAG and Albuquerque Police Dept. The New Mexico Weather Net supplies weather information on spot-frequency schedules. Under supervision of the U. S. Weather Bureau station at Albuquerque, weather, crop and river level information is supplied efficiently from all parts of the state.

Traffic: W5ZM 255 (WLJG 99) DGP 161 HAG 132 HJF 116 FSP 66 HPV 71 EWT 34 GSD 33 HDN 28 ENI 26 HTM-BKD 22 HRB 18 GGO 5.

MIDWEST DIVISION

IOWA — SCM, L. B. Vennard, W9PJR — RMV is operating portable at Arnold Park. MHC has new beam on 28 Mc. FNT and CHA are on 28 Mc. KAH has new 55-ft. tower. REV reports C.B. R.O.C. now affiliated with A.R.R.L. FLR is new E.C. at Ottumwa. DUA reports T.L. "G" going well. GCL is moving to Mo. UNL got emergency power plant working; had fine meeting with Mr. Barry, Oct. 23rd. WTD is rebuilding shack and antenna at new QTH. NLA, TMY and LAC are new O.P.S. WMP and WNL are new O.R.S. QVA joined F.P.S. Net; he is new R.M. LAC is building 1.75-Mc. rig. KYR is on 1.75-Mc. 'phone. CTQ is checking 2nd harmonics. SHY is getting active again. REH is now S.N.C.S. A.A.R.S. PJR's vibrator pack is putting out a good sock. ZQR is busy with A.A.R.S. JIS is on 3.9-Mc. 'phone. Don't forget to nominate your Emergency Coördinator, gang, and be ready. — C.U.L. — Les.

Traffic: W9GCL 4 JAP 40 QVA 17 LAC 2 ZQW 12 DUA 61. (Sept.-Oct. 15: DUA 30.)

GUTHMAN Presents
THIS MONTH'S FEATURE

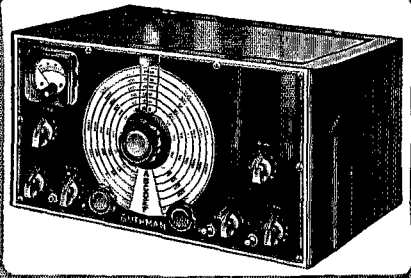

U-50 "SUPER"

HERE'S THE BUY! 11-Tube Communication Receiver, complete with sensational new Gun-Sight Tuning, illuminated and magnified 2½ times; six bands, 225 to 65,000 kc.; Controlled regeneration; R.F. Stage; 3-rang condenser; improved Noise-Silencer; Pre-selection Stage and every other vital control, only \$69.98, amateurs net wired with tubes, or build it yourself. Kit supplied assembled\$49.95

At your jobber's, or order direct, giving jobber's name, if out of stock.

Edwin I. Guthman & Co., Inc.
400 S. PEORIA ST. CHICAGO, U. S. A.
CABLE ADDRESS: GUTHCO-CHICAGO

Be a Champion with a Genuine VIBROPLEX "CHAMPION"

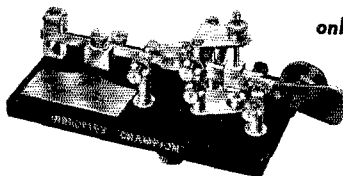

only **\$9.95**

At Your Dealer's

Standard size black base. Chromium finished top parts. Equipped with 3/16" diameter contact points. Furnished without circuit closer, cord and wedge.

[A "STAR" Performer

Like all true champions, this new Vibroplex "CHAMPION" defies competition. Handsome in design, sturdily built and a "STAR" performer... the "CHAMPION" is our answer to the demand for a BUG of established quality, proved sending ability and assured ease of operation at a price within the reach of everyone. Designed primarily for the amateur, professional operators will find the "CHAMPION" amply qualified to give an expert account of itself on any assignment. See the "CHAMPION" at your dealer's to-day. If he cannot supply you, write or order direct from us. Money order or registered mail. Write for illustrated catalog.

THE VIBROPLEX CO., Inc.

832 Broadway

New York, N. Y.



The BUG trade mark identifies the Genuine Vibroplex



**ALWAYS
BE
CAREFUL**



★ ★ ★

(A) Kill all transmitter circuits completely before touching anything behind the panel.

(B) Never wear 'phones while working on the transmitter.

(C) Never pull test arcs from transmitter tank circuits.

(D) Don't shoot trouble in a transmitter when tired or sleepy.

(E) When working on the transmitter, avoid bodily contact with metal racks or frames, radiators, damp floors or other grounded objects.

(F) Keep one hand in your pocket.

(G) Develop your own safety technique. Take time to be careful.

★ ★ ★

Death Is Permanent!

Strays

Try This on Your Piccolo

"I play drum in our local high school band. We have worked up a cadence that sends code. We use one which represents 'HI,' and at other times one representing 'Test.' For special occasions we use one which expresses '88.' More than once we have attracted the attention of hams at football games. When we hear an answering 'CQ' or 'Hi' whistled from the stands, our trumpet player, soon to become a ham, blows my call letters."

—W6PMV

That trumpet player is making an early start at call-bootlegging!

Q Measurements

(Continued from page 51)

the frequency divided by the band-width at 70.7% of the resonant voltage.

This same general method of attack may be used when only one frequency is available. In this case, a calibrated variable condenser is necessary. Referring to Fig. 3, suppose we keep the frequency constant and vary the capacity of the condenser both above and below the value at resonance. A curve similar to that of Fig. 2-A would result if capacity were plotted against the voltage e . From this it appears that the change of capacity necessary to drop the voltage to 0.707 maximum might be used as the change of frequency was used in the last derivation.

The reactance of Fig. 3 is equal to the difference between the inductive and the capacitive reactances, or, when e is equal to 70.7% of E ,

$$2\pi fL - \frac{1}{2\pi fC_2} = \frac{1}{2\pi fC_1} - 2\pi fL = R = X$$

where C_1 and C_2 are the capacities necessary to drop the voltage as indicated. Adding these two equations and combining terms (App. 10)

(Continued on next left-hand page)

IT'S ALL IN THE HANDBOOK

CONTENTS

☆ ☆ ☆
 Frontispiece: HIRAM PERCY MAXIM MEMORIAL STATION, WIAW
 THE AMATEUR — HIS CODE OF ETHICS ☆

	INTRODUCTION	9
Chapter 1	STORY OF AMATEUR RADIO	15
Chapter 2	GETTING STARTED	22
	PRINCIPLES AND DESIGN	48
Chapter 3	ELECTRICAL AND RADIO FUNDAMENTALS	71
Chapter 4	RECEPTION OF RADIO SIGNALS	88
Chapter 5	TRANSMITTER DESIGN	
Chapter 6	MODULATION	
	CONSTRUCTION AND ADJUSTMENT	103
Chapter 7	WORKSHOP PRACTICE	108
Chapter 8	CONSTRUCTION OF RECEIVERS	134
Chapter 9	TUNING AND ADJUSTING RECEIVERS	144
Chapter 10	CONSTRUCTION OF TRANSMITTERS	180
Chapter 11	POWER SUPPLY	202
Chapter 12	MODULATION EQUIPMENT	213
Chapter 13	COMPLETE TRANSMITTERS	221
Chapter 14	KEYING AND B.C.I. ELIMINATION	232
Chapter 15	ADJUSTMENT OF PHONE TRANSMITTERS	243
Chapter 16	MEASUREMENTS AND MEASURING EQUIP- MENT	258
Chapter 17	EMERGENCY AND PORTABLE STATION ASSEMBLY	273
Chapter 18	TUBE CHARACTERISTICS AND MISCELLANE- OUS DATA	286
Chapter 19		294
Chapter 20		
	ANTENNAS	334
Chapter 21	ANTENNA FUNDAMENTALS	341
Chapter 22	R.F. TRANSMISSION LINES	355
Chapter 23	LONG-WIRE ANTENNAS	364
Chapter 24	MULTI-ELEMENT DIRECTIVE SYSTEMS	371
Chapter 25	ANTENNA CONSTRUCTION	
	ULTRA-HIGH FREQUENCIES	378
Chapter 26	INTRODUCTION TO U.H.F.	380
Chapter 27	RECEIVING EQUIPMENT FOR 28- AND 56-MC.	389
Chapter 28	28- AND 56-MC. TRANSMITTERS	400
Chapter 29	112 MC. AND HIGHER	416
Chapter 30	ANTENNAS FOR THE U.H.F.	
	OPERATING AND TRAFFIC HANDLING	422
Chapter 31	OPERATING THE STATION	438
Chapter 32	REGULATIONS AND DATA	449
	INDEX	

Price
 \$1 postpaid in
 Continental U. S. A.
 \$1.25 postpaid elsewhere
 Buckram bound edition, \$2.50

American Radio Relay League
 West Hartford, Conn., U. S. A.

SUPER ACTIVE

HIPOWER

LOW DRIFT CRYSTAL UNITS



LOOK! LOOK!
GENUINE LOW DRIFT
"EMERALDS"
AT "X" CUT PRICES

Now get stability plus higher activation with these new sensational crystal units. The entire ham band is talking about HiPower "Emeralds." Because of large production facilities and exclusive HiPower grinding methods, these low drift cut units meet every test of usage, accuracy and price.

SEND facilities and exclusive HiPower grinding methods, these low drift cut units meet every test of usage, accuracy and price.
FOR
CATALOG 160—80—40 meter bands **\$3.35**
TODAY 20 meter band, 5.50

Ask your parts distributor about HiPower "Rubies." These jewels of crystal craftsmanship — priced reasonably — meet commercial standards at true amateur prices.

Newark, Chicago, Radio Parts, Madison & Milwaukee, Kerrs Radio Shop, El Paso, Tex. Radio Electric Service Co., Baltimore, Md. Walder Radio & Appliance Co., Miami, Florida.

HIPOWER CRYSTAL COMPANY

2035 CHARLESTON ST. CHICAGO, ILL.

$$2R = \frac{C_2 - C_1}{2\pi f C_1 C_2} \quad (13)$$

Since C_1 and C_2 are just slightly different from C_r (one higher and the other lower), it is almost exactly true that $C_1 C_2 = C_r^2$. (13) may now be written

$$2R = \frac{C_2 - C_1}{2\pi f C_r^2} \text{ or } \frac{C_2 - C_1}{2C_r} = R(2\pi f C_r) \quad (14)$$

Since at resonance, $2\pi f C = \frac{1}{2\pi f L}$, it is seen that

$$\frac{C_2 - C_1}{2C_r} = R \left(\frac{1}{2\pi f L} \right) = \frac{1}{Q} \text{ or } Q = \frac{2C_r}{C_2 - C_1} \quad (15)$$

(15) is another one quite commonly used to determine Q .

Before leaving the theory for the practical means of applying these equations, we had better

TABLE II

f_1	f_2	K	$L = \frac{K}{C_2 - C_1}$
912	456	91,365	$f = Kc.$
1200	600	52,770	$L = \mu h.$
2000	1000	18,998	$C = \mu f d.$
4000	2000	4,749	

discuss one more method. This one has recently become one of the most common methods of measuring Q .

The circuit in Fig. 3 has been redrawn in Fig. 4-A. At resonance, the external circuit from A to B has an impedance $Z_{AB} = R$. The circuit represented by the inductance L and its losses R has an impedance $Z_L = \sqrt{X_L^2 + R^2}$. Fig. 4-B shows another configuration of Fig. 4-A, and Fig. 4-C shows the same circuit in terms of impedances. At resonance, the voltage e across the coil is to the total voltage E as the ratio of the respective impedances, or

$$\frac{e}{E} = \frac{Z_L}{Z_{AB}} = \frac{\sqrt{X_L^2 + R^2}}{R}$$

This may also be written in the following forms:

$$\frac{e}{E} = \sqrt{\frac{X_L^2 + R^2}{R^2}} = \sqrt{\frac{R^2 + X_L^2}{R^2}} = \sqrt{1 + Q^2}$$

In the practical case, Q will rarely be less than 10, so that the 1 under the radical may be neglected without introducing too much objectionable error. Then,

$$Q = \frac{e}{E} \quad (16)$$

Practical Applications of These Equations Band-Width Method

From (12),

$$Q = \frac{f_r}{\Delta F} = \frac{f_r}{f_1 - f_2}$$

Equipment:

1. Frequency calibrated oscillator.
2. Voltmeter with band-width calibration.

(Continued on next left-hand page)

THIS EXPERT WILL HELP YOU PASS THE NEW RADIO EXAMS



Newly-written, low-cost, home-study courses under supervision of Arthur R. Nilson, twenty years co-author of technical radio books. Fit yourself for the new license examinations — Radio Telephone Operator 1st or 2nd class and Radio Telegraph Operator's permit, used in the Aeronautical, Forestry and Police services and Broadcasting. Thousands of professional radiomen use Nilson and Hornung textbooks to keep up to date. Now Arthur R. Nilson will give you direct, detailed lessons, step by step.

SEND FOR FREE 16-PAGE BOOKLET "What The Modern Radioman Must Know." Make this step toward your successful radio career ... now!

NILSON RADIO SCHOOL
51 East 42nd St., New York, N. Y.

Please send me without obligation, your booklet "What The Modern Radioman Must Know."



Name _____
Address _____
City _____ State _____ Q-1

THE AMATEUR'S BOOKSHELF

A balanced selection of good technical books, additional to the A.R.R.L. publications, should be on every amateur's bookshelf. We have arranged, for the convenience of our readers, to handle through the A.R.R.L. Book Department those works which we believe to be most useful. Make your selection from the following, add to it from time to time and acquire the habit of study for improvement. Prices quoted include postage. Please remit with order.

RADIO THEORY AND ENGINEERING

FUNDAMENTALS OF RADIO, *Second Edition*, by *R. R. Ramsey*. A modernized revision of the author's work which has been a favorite with amateurs and experimenters since 1929. 426 pages, 439 illustrations. 2nd Edition, 1935. \$3.50

RADIO ENGINEERING, by *F. E. Terman*. A comprehensive treatment covering all phases of radio communication. An all around book for students and engineers, 811 pp., 474 illustrations. 2nd Edition, 1937. \$5.50

ELEMENTS OF RADIO COMMUNICATION, by *Prof. J. H. Morecroft*. This is the 2nd edition of this book by the author of the well-known "Principles." It is about half the size of the larger work, and the subject is treated in more elementary fashion. Simple algebra is sufficient. An excellent book for the "first-year" student. 279 pp., 170 illustrations, 1934. \$3.00

PRINCIPLES OF RADIO, by *Keith Henney*. This book is chock-full of meat for the experimenter. The subjects treated range from the fundamentals of electricity to the modern concepts of modulation and detection. 477 pp., 306 illustrations. 2nd Edition, 1934. \$3.50

COMMUNICATION ENGINEERING, by *W. L. Everitt*. A general text for both first year and advanced courses. Complete treatment of network theory, including mathematical analysis of radio circuits and tube operation. 727 pp., 411 illustrations. 2nd Edition, 1937. \$5.00

PRINCIPLES OF RADIO ENGINEERING, by *R. S. Glasgow*. Mathematical presentation of the fundamentals of radio communication and their application. A large portion of the book is devoted to the theory and use of the vacuum tube in communication systems. 326 pp., 6 x 9, 1936. \$4.00

FUNDAMENTALS OF VACUUM TUBES, by *Austin V. Eastman*. Treats the laws underlying operation of the principal types of tubes—high-vacuum, mercury-vapor, photo and special tubes—with engineering analysis of their more important applications. 438 pages, 6 x 9, 1937. \$4.00

FUNDAMENTALS OF RADIO, by *F. E. Terman*. An elementary version of the author's "Radio Engineering," with simplified treatment and intended for readers of limited mathematical ability. Suitable as a text for an introductory course in radio, and features problems for class-room work. 458 pages, 278 illustrations, 1938. \$3.75

ELECTRON OPTICS IN TELEVISION, by *I. G. Naloff and D. W. Epstein*. Covers the theory of electron optics and practical design problems in constructing cathode-ray tubes for television work. An introductory section outlines the principles of cathode-ray television. 299 pages, 197 illustrations, 1938. \$3.50

ELECTRICAL ENGINEERS' HANDBOOK, VOL. V, ELECTRIC COMMUNICATION AND ELECTRONICS, edited by *H. Pender and K. McIlwain*. A comprehensive handbook covering the field of communication, both wire and radio, and electronics. 1022 pages, 3rd edition, 1936. \$5.00

RADIO EXPERIMENTS AND MEASUREMENTS

MEASUREMENTS IN RADIO ENGINEERING, by *F. E. Terman*. A comprehensive engineering discussion of the measurement problems encountered in engineering practice, with emphasis on basic principles rather than on methods in detail. 400 pages, including an appendix of outlines for laboratory experiments and a comprehensive index. 210 illustrations, 1935. \$4.00

THE CATHODE-RAY TUBE AT WORK, by *John F. Rider*. Devoted to cathode-ray tube theory, sweep circuits, a.c. wave patterns and description of commercial oscilloscope units including actual photographs of screen patterns representing about every condition likely to be encountered in audio- and radio-frequency amplifiers, power supplies, complete receivers and transmitters. 322 pages, 444 illustrations. \$2.50

HIGH-FREQUENCY MEASUREMENTS, by *August Hund*. A thorough, modern book, especially useful in advanced laboratory work. Includes a chapter on piezo-electric determinations. 491 pp., 373 illustrations, 1933. \$5.00

EXPERIMENTAL RADIO ENGINEERING, by *Prof. J. H. Morecroft*. An excellent laboratory text directed specifically to emphasizing the principles involved in the operation of radio apparatus and intended as a companion to the same author's "Principles." Following an introductory chapter on instruments and accessories, 51 choice experiments are outlined. 345 pp., 250 illustrations, 1931. \$3.50

EXPERIMENTAL RADIO, by *Prof. R. R. Ramsey*. Fourth Edition. A splendid book for the experimenter. This is a laboratory manual, describing 152 excellent experiments designed to bring out the principles of radio theory, instruments and measurements. 167 illustrations, 196 pp., 5 1/4 x 7, 1937. \$2.75

RADIO FREQUENCY ELECTRICAL MEASUREMENTS, by *Hugh A. Brown*. A laboratory course in r.f. measurements for communications students. Contains much practical information on methods of measurement. 384 pages, 177 illustrations, 1938. \$4.00

COMMERCIAL EQUIPMENT AND OPERATING

PRACTICAL RADIO COMMUNICATION, by *A. R. Nilson and J. L. Hornung*. A new modern treatment meeting the expanded scope of today's technical requirements in the various commercial fields. The first six chapters are devoted to principles, the remaining nine to latest practice in broadcasting, police system, aviation radio and marine communication. 754 pages, including an appendix of tabulated data and a complete topical index. 434 illustrations, 1935. \$5.00

THE RADIO MANUAL, by *George E. Sterling*. Another excellent practical handbook, especially valuable to the commercial and broadcast operator, and covering the principles, methods and apparatus of all phases of radio activity. Over 900 pp., 1938. \$6.00

RADIO TRAFFIC MANUAL AND OPERATING REGULATIONS, by *Duncan and Drew*. A book for students, amateurs or radio operators who contemplate entering the commercial field; it will enable you to learn quickly and easily all the government and commercial traffic rules and operating regulations. 181 pp. \$2.00

RADIO OPERATING QUESTIONS AND ANSWERS, by *Nilson and Hornung*. A companion volume to "Practical Radio Telegraphy" by the same authors. The latest Revised Edition is very complete, covering Commercial and Broadcasting, Amateur, Aeronautical and Police Radio, Beacons, Airways, Meteorology, and Teletype Operating. 389 pp. 5 1/4 x 8, 1936. \$2.50

HOW TO PASS RADIO LICENSE EXAMINATIONS, by *Charles H. Drew*. Question and answer material on various types of commercial operator examinations. The commercial equivalent of the A.R.R.L. License Manual. 201 pages, 73 illustrations, 1938. \$2.00

RADIO OPERATOR'S MANUAL, by *the Radio Dept., G. E. Co.* Primarily a manual to qualify an applicant for the radiotelephone classes of license (including police), but also provides material of general interest to users of commercial radio equipment. 181 pages, 56 illustrations, 1938. \$1.00

MISCELLANEOUS

THE RADIO AMATEUR CALL BOOK. Lists all U. S. and foreign amateur radio stations, s.w. commercials and broadcasters. \$1.25 (Foreign \$1.35)

MAKING A LIVING IN RADIO, by *Zeh Bouck*. 222 pages, 25 illustrations. A worth-while book for the radio amateur who is considering entering the Commercial Radio field in its many branches; explodes the bunk, points out the pitfalls. \$2.00

RADIO DATA CHARTS, by *R. T. Beatty*. A series of graphic charts for solving, without the use of mathematics, most of the problems involved in receiver design. 82 pp., 8 1/4 x 11. \$1.50

SERVICING RECEIVERS BY MEANS OF RESISTANCE MEASUREMENTS, by *J. F. Rider*. 203 pp., 94 illustrations. An excellent book for the service man and amateur constructor. \$1.00

SERVICING SUPERHETERODYNES, by *John F. Rider*. Theory and practice of superheterodynes, with adjustment and troubleshooting data. 278 pages, 94 illustrations. \$1.00

The following books published by the American Radio Relay League, *The Radio Amateur's Handbook*, *The License Manual*, *Hints & Kinks*, *How to Become a Radio Amateur*, *300 Meters and Down*, *Building an Amateur Radiotelephone Transmitter*, and of course *QST*, comprise the foundation of every Amateur library.

AMERICAN RADIO RELAY LEAGUE, INC., WEST HARTFORD, CONNECTICUT

PINCOR
ROTARY CONVERTERS

Engineered right . . . built right. That is why this complete line of Pincor Rotary Converters can always be depended upon to give thousands of hours of trouble-free service for operation of trouble-address systems, gaseous signs, public amplifiers, radios, A. C. motors, musical instruments and other electrical apparatus, even under the most adverse conditions. Available with or without filter for converting 6, 12, 32, 110 or 220 volts D. C. to 110 or 220 volts A. C. Capacities: 60 and 750 watts. Quiet, smooth lightweight and compact. Send for complete information today. Use coupon below.

PIONEER GEN-E-MOTOR CORP.
CHICAGO, ILL.



PIONEER GEN-E-MOTOR CORP.
 Dept. R-6A, 466 W. Superior St., Chicago, Ill.
 Please send me complete information on Pincor Rotary Converters.

Name.....
 Address.....
 City.....State.....

R-6S PRACTICE SET



WIRELESS PRACTICE SETS

Designed for those who want a well made instrument to learn the code. Set consists of a key and high frequency buzzer mounted on a mahogany finished wood base equipped with binding posts. The code is printed on a plate and fastened to the base between the key and buzzer. Buzzer is adjustable. List \$3.40.

SIGNAL's line of Wireless Keys, Telegraph Instruments and Wireless Practice Sets is complete. Send for bulletin.

SIGNAL ELECTRIC MFG. CO.
 Menominee, Michigan, U. S. A.

SIGNAL
 MANUFACTURERS OF ELECTRICAL PRODUCTS

Fig. 5-A shows the circuit generally employed. A vacuum-tube voltmeter is used to measure the r.f. potential. In Fig. 5-B R_{BC} is 70.7% of R_{AC} . With the switch in the A position, R_S is adjusted to give a convenient deflection of the voltmeter. This will be referred to as the *peak voltage* deflection. This value is recorded and the switch turned to the B position. The deflection obtained will be called the *band width* deflection. By repeating this procedure for different settings of R_S , a series of peak versus band-width deflections will be obtained. These values should be plotted on graph paper, as shown in Fig. 6. The voltmeter deflection corresponding to 70.7% of the voltage necessary to produce any given deflection can then be read from the graph. If the frequency of the supply voltage is 60 cycles, the resistors need not be non-inductive. This frequency is readily available in most locations and is satisfactory for most Q -measurement voltmeter calibrations.

The procedure is as follows:

1. Couple the oscillator to the coil with a one-turn link.
2. Tune the coil to resonance (maximum deflection of the voltmeter) with the capacity.
3. Adjust the coupling so that when tuned exactly to resonance, the circuit will cause a nearly full-scale deflection of the voltmeter.
4. Measure the frequencies above and below resonance at which the voltmeter reads the band-width deflection corresponding to the peak deflection which occurred at resonance.
5. To determine Q , divide the resonant frequency by the difference between the two frequencies determined in step 4.

Capacity Method

From (15)

$$Q = \frac{2C_2}{C_2 - C_1}$$

Equipment:

1. Single-frequency oscillator.
 2. Calibrated variable condenser.
 3. Voltmeter with band-width calibration.
- Fig. 5-A is also applicable to this method. The procedure is:
- 1-3 incl. Same as in previous method.
 4. Measure the capacities above and below resonance at which the voltmeter reads the band-width deflection corresponding to the peak voltage deflection which occurred at resonance.
 5. To determine Q , divide *twice* the capacity at resonance by the difference between the capacities determined in step 4.

The accuracy of this result depends upon the accuracy of the determination of the resonant capacity. If the coil has a high distributed capacity, the resulting error may be appreciable. It is therefore desirable to determine the distributed capacity by applying (5). This makes it necessary to use another frequency, but since this might well be chosen as twice the frequency used in (15), this represents no problem. In applying (15) al-

(Continued on next left-hand page)

Try it in your transmitter

That's the way to tell the true value of any vacuum tube

Eimac tubes are developed in the laboratory—not by the sales department. Regardless of what we say about them when you put them in your transmitter and “pour on the heat”—that’s when you can see the difference—that’s when you can see the value of the more expensive tantalum elements, the extra rugged filament, absence of internal insulators and the complete removal of gas.

Follow the example of the world’s leading radio engineers by adopting Eimac tubes. Why be satisfied with anything but the best.

Eimac
TUBES

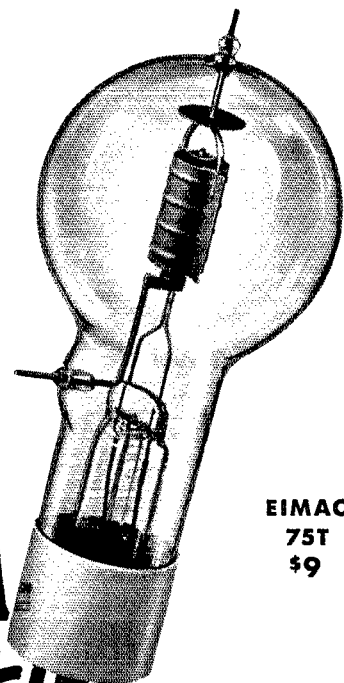

EIMAC
75T
\$9

EITEL-McCULLOUGH, Inc.
San Bruno • California

PRECISION CRYSTALS

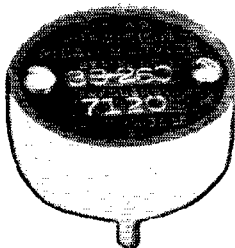

Highest quality crystals carefully prepared for dependable performance.

Low frequency drift Type 4-A unit plugs into tube socket, 40, 80 or 160 meter bands, within 5 kc. of your specified frequency — \$4.00. Calibration 0.03%.

'X' cut in Type 4 holder — \$3.50.

Crystals for commercial requirements quoted on at your request. Now in our Tenth year of business.

PRECISION PIEZO SERVICE

427 Asia Street

Baton Rouge, La.

MICROMETER

FREQUENCY
METER

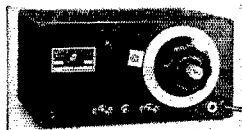

... for police,
aviation, relay-

broadcast units • an accurate and economical means for monitoring several transmitters, up to 56 mc., within 0.01%
• write for data.

LAMPKIN LABORATORIES • BRADENTON
FLA., U. S. A.

A GOOD NAME GOES A LONG WAY

The good name of Ken-Rad Radio Tubes is the result of expert engineering, tested materials and constant checking to maintain the highest standards.



Ken-Rad Radio Tubes
KEN-RAD TUBE & LAMP CORPORATION - OWENSBORO, KY.

Manufacturers of all types of radio tubes and Ken-Rad Electric Lamp Bulbs

For DX!

THE
AMATEUR

RADIO MAP OF THE WORLD

★ On a sheet of heavy map paper 30 x 40 inches Rand McNally, world's premier map-makers, have — to A.R.R.L. specifications — imprinted in six colors and black every single bit of map information useful to the radio amateur.

The special modified equidistant azimuthal projection permits great circle distance measurements in miles or kilometers accurate to better than 2%. Local time in all parts of the world is shown, as well as Greenwich corrections. The official I.A.R.U. WAC continental sub-divisions are given. Principal cities of the world are shown, including, in the U. S., all district inspection offices and examining points.

Perhaps most useful of all is a list of countries of the world, arranged on a basis of geographical and political divisions — clearly shown by color breakdown and the detailed reference index. There are 230 countries shown, 180 prefixes (the prefixes in large open red lettering that you can't miss). More than that, all known national districts and other sub-divisions are shown.

Entirely new in conception and design, large enough to be useful, complete in every detail — here is the map radio amateurs have been waiting for these many years. Make a place for it on your wall now — it'll be the most interesting object in the shack.

PRICE **\$1.25**
POSTPAID

**American
Radio Relay League**
West Hartford, Connecticut

TABLE III

Method	Frequency	Inductance
Single-frequency	600 kc.	171.6 μ h.
Single-frequency	1200 kc.	213.9
Two-frequency	1200-600 kc.	159.9 (correct)

ways be careful that neither the distributed capacity of the coil nor the shunting capacity of the leads is high, or the determination of Q by this method will be badly in error.

Voltage Gain Method

From (16)

$$Q = \frac{e}{E}$$

Equipment:

1. Single-frequency signal generator or oscillator.
2. Calibrated voltmeter.
3. Non-inductive low resistance.

Fig. 7-A shows the circuit normally used. Fig. 7-B shows one method which may be used to calibrate the voltmeter. To obtain the voltage across the vacuum-tube voltmeter, divide the voltage read on the a.c. input meter by the ratio of the total divider resistance to the resistance across the tap.

The voltage is introduced into the resonant circuit by applying it across the low resistance R . This resistance must be low enough so that it is an inappreciable part of the total resistance of the circuit. In practice, it is usually about 0.05 ohm.

The procedure is:

1. Tune the circuit to resonance.
2. Measure the voltage at E .
3. Retune with the voltmeter at e and measure.
4. To determine Q , divide e by E .

(Any of the above methods do not measure the Q of the coil alone but give the Q of the coil in combination with the condenser. Normally the Q of the condenser is so high that the figure ob-

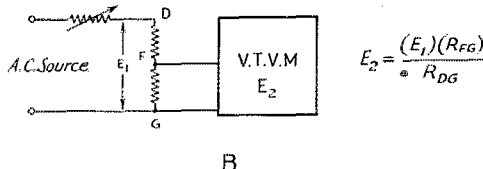
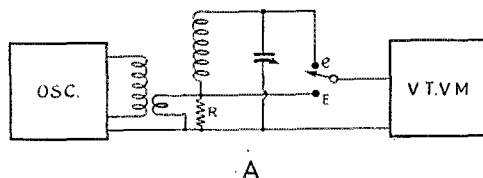
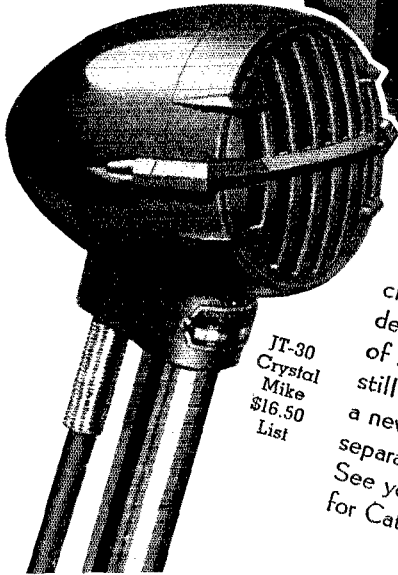

Fig. 7 — The circuit used in measuring Q by the voltage-gain method. The r.f. portions of the oscillator should be shielded if the v.t.v.m. picks up radiated energy. B shows the circuit used to calibrate the v.t.v.m.

(Continued on next left-hand page)

C. G. Allen, G8IG, of Bromley, Kent, England, praises performance of Astatic Crystal Microphones.



JT-30
Crystal
Mike
\$16.50
List



Microphones of Tomorrow

ASTATIC Seven years ago, Astatic Engineers expressed their faith in Crystal Microphones as "The Microphones of Tomorrow." The dependable performance, since then, of many thousands of such microphones, has proven that this faith was and is still more than justified. To Astatic's complete crystal line, a new dynamic microphone was added this year for a separate type of use by Astatic customers. See your Astatic jobber or write for Catalog No. 12.

ASTATIC MICROPHONE LABORATORY, Inc., YOUNGSTOWN, OHIO

Licensed Under Brush Development Co. Patents

LEARN RADIO • TELEVISION

60-page catalog on request. Oldest, largest and best equipped in New England. Write for new catalog.

MASS. RADIO SCHOOL

18 Boylston Street

Boston, Mass.

HOW TO LEARN CODE

Whether you wish to enter radio as a career or as a hobby, the All Electric Master Teleplex Code Teaching Machine will show you how. Teleplex records your sending in visible dots and dashes on a specially prepared waxed paper tape and then sends back to you at any speed you desire. It does not merely show you code. It is code. No experience needed.

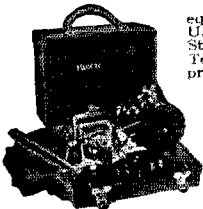

While not designated as standard equipment, Teleplex is used at many U. S. Army Posts, Naval Training Stations as well as by the American Telephone & Telegraph Co. Also by practically every private school in the U. S. teaching code; and many foreign governments.

FREE BOOK

We furnish you complete course, including practice messages, the All Electric Master Teleplex, plus a personal service on a **MONEY BACK GUARANTEE**. Low cost. Easy terms. *Without obligation write for booklet "Q1."*

In Canada write:

CANADIAN ELECTRONIC INST., TORONTO, ONT.
TELEPLEX CO. 67-69 PARK PLACE
NEW YORK, N. Y.

Quality above all
SOLAR

TRANSMITTING CAPACITORS

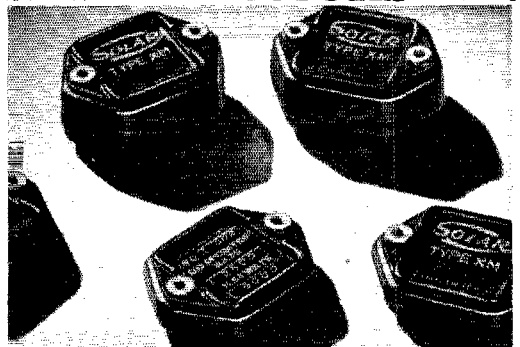

TYPE XM High Voltage Mica Capacitors incorporate mechanical stability which guarantees freedom from drift. Unusually high Q.

Ask for free No. 10 Catalog; buy from your local Jobber

SOLAR MFG. CORP.
Bayonne, New Jersey

Half-Wave Di-Pole

by **PREMAX**

Where two quarter-waves are used as in Fig. 4, you have the condition of the typical half-wave di-pole. In free space where the antenna is not influenced by ground or surrounding objects, the center is thought to have an impedance of approximately 70 ohms.

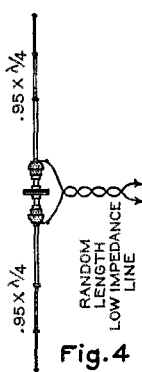

Fig. 4

Premax Vertical Radiators Are Adaptable to Any Antenna System

Where space is limited and efficient antennas are desired, the Premax Telescoping Vertical Radiators are unsurpassed. Write or ask your jobber for Premax Technical Bulletin H-3 which illustrates 22 types of verticals, all of which are easy to erect with Premax standard units.

PREMAX PRODUCTS

Division Chisholm-Ryder Co., Inc.

4020 HIGHLAND AVE. NIAGARA FALLS, N. Y.

EASY TO LEARN CODE

It is easy and pleasant work to learn the modern way — with an **Instructograph Code Teacher**. Ideal for the beginner or advanced student. Many tapes available ranging from alphabetic for beginners to typical messages on all subjects. Speed range 5 to 40 WPM. Always ready, no QRM, beats having someone send to you.

FOR SALE OR RENT

STANDARD with 10 tapes and book of instructions, A. C. motor \$24.50
With spring-wound motor \$18.50
JUNIOR with 5 tapes and book of instructions (not rented) \$12.00

RENTAL Standard with 10 tapes and book of instructions \$3.00 first month, \$2.25 each additional month. References or \$10 deposit required. All rental payments may be applied on the purchase price should you decide to buy the equipment.

Write for details today



INSTRUCTOGRAPH COMPANY

Dept. Q, 912 Lakeside Place, Chicago, Illinois

Representative for Canada:

Radio College of Canada, 863 Bay Street, Toronto

EXPERIMENTAL RADIO

FOURTH EDITION

(196 p. 6 x 9 cloth. 136 experiments, 167 figures.) By Professor R. R. Ramsey, Ind. Univ. A revision of the original book for experimenters and students. Diagrams drawn for power packs and batteries. Many new and original ideas. The earlier editions were the first books to contain new features which are accepted now. Of this edition again it can be said, "Ramsey manages to supply that missing fact which seems to be hidden in other books."



FUNDAMENTALS of RADIO

Second edition. By the same author. A modern text book with a minimum of mathematics giving fundamental theory of radio. Practice may change; Basic principles remain the same. Price, Experimental \$2.75. Fundamentals \$3.50 postpaid.

RAMSEY PUBLISHING CO.
Bloomington, Indiana

tained is practically that of the coil. However, when the condenser is used near minimum capacity, the ratio of the total capacity using air dielectric (low loss) to that using solid dielectric (higher loss) becomes lower and the Q of the condenser is lowered.¹ For this reason, a low-loss condenser set near maximum capacity should be used in Q measurements. — E.d.)

Appendix

$$1. Q = \frac{2 \times 3.1416 \times 60 \times 2}{100} = 7.54$$

$$2. L_{600} = \left(\frac{159,160}{600} \right)^2 \times \frac{1}{410} = 171.6 \mu\text{h.}$$

$$3. L_{1200} = \left(\frac{159,160}{1200} \right)^2 \times \frac{1}{80} = 219.9 \mu\text{h.}$$

$$4. L = \frac{1}{4\pi^2 f^2 (C_d + C_1)} = \frac{1}{4\pi^2 f^2 (C_d + C_2)}$$

$$f^2 C_d + f^2 C_1 = f^2 C_d + f^2 C_2$$

$$C_d = \frac{f^2 C_2 - f^2 C_1}{f^2 - f^2}$$

$$5. L = \frac{1}{4\pi^2 f^2 (C_d + C_1)} = \frac{1}{4\pi^2 f^2 \left(\frac{f^2 C_2 - f^2 C_1}{f^2 - f^2} + C_1 \right)}$$

$$= \frac{1}{4\pi^2 f^2 (f^2 C_2 - f^2 C_1 + f^2 C_1 - f^2 C_1)}$$

$$= \frac{1}{4\pi^2 f^2 f^2 (C_2 - C_1)}$$

$$6. L\mu\text{h} = \frac{(f^2 - f_2^2) (10^3)^2}{4\pi^2 f^2 (10^3)^2 (f_2^2) (10^3)^2} \times \frac{1}{(C_2 - C_1) (10^{-12})}$$

$$= \frac{(f^2 - f_2^2) \times 10^{12}}{4\pi^2 f^2 f_2^2} \times \frac{1}{C_2 - C_1}$$

$$7. L_{1200-600} = \frac{(1200^2 - 600^2) \times 10^{12}}{4\pi^2 (1200)^2 (600)^2 (410-80)}$$

$$= 159.9 \mu\text{h.}$$

$$8. X_L^2 = 2\pi f L \quad X_C = \frac{-1}{2\pi f C}$$

When L is constant,

$$\frac{dX_L}{df} = 2\pi L \quad \frac{dX_C}{df} = \frac{1}{2\pi f^2 C}$$

If these rates of change are equal,

$$2\pi L = \frac{1}{2\pi f^2 C} \text{ or, } 2\pi f L = \frac{1}{2\pi f C}$$

We know, of course, that at resonance the latter is true.

$$9. \begin{cases} 4\pi(f_r - f_2)L = R \\ 4\pi(f_1 - f_r)L = R \\ 4\pi f_r L - 4\pi f_2 L = R \\ 4\pi f_1 L - 4\pi f_r L = R \end{cases}$$

Adding,

$$4\pi f_r L - 4\pi f_r L + 4\pi f_1 L - 4\pi f_2 L = 2R$$

$$2R = 4\pi L(f_1 - f_2)$$

$$f_1 - f_2 = \frac{R}{2\pi L}$$

$$10. 2\pi f L = \frac{1}{2\pi f C_2} = R$$

$$\frac{1}{2\pi f C_1} - 2\pi f L = R$$

Adding,

$$2\pi f L - 2\pi f L + \frac{1}{2\pi f C_1} - \frac{1}{2\pi f C_2} = 2R$$

$$\frac{C_2 - C_1}{2\pi f C_1 C_2} = 2R$$

¹ Michel, "Factor-of-Merit of Short-Wave Coils," G. E. Review, Oct., 1937.

● TELEGRAPHY—TELEVISION—TELEPHONY ●

AVIATION
 TRANSRADIO
 PRESS
 TELETYPE
 TYPEWRITING



PRACTICAL
 EXPERIENCE
 STUDIO —
 TRANSMITTER —
 ANNOUNCING

The major technical training equipment owned by Port Arthur College and in operation on the college campus consists of 1000-Watt High Fidelity RCA Transmitter of latest design, operating on 1220 kc. with a directional antenna system, two-way Television Transmitter and Receiver, Latest Type RCA Marine and Airways transmitter installation complete, SOS Automatic Alarm, Marine Direction Finder, Trans-radio Press Receiving Equipment, and Laboratory complete where students assemble composite transmitters, amplifiers, audio amplifiers, R.F. amplifiers, etc.

Port Arthur College pioneered the teaching of Radio with classes in 1909, and for thirty years has maintained an active Employment Bureau for the placement of its graduates.

If interested in details about Radio Course, write for Bulletin R

PORT ARTHUR COLLEGE ■ PORT ARTHUR (World-Known Port), TEXAS

110 VOLTS AC Katolight Anytime, Anywhere! with Plants

Have special plant for operating radio receivers and transmitters. Close voltage regulation. Full 380 watts AC and 100 watts at 6 volts. Filtered and Shielded.
 Amateur's price—JRA8, 350 watt \$67.50
 Amateur's price—JRS5, 650 watt 97.50
 Other sizes up to 10,000 watts.
 "Ask your jobber"

KATOLIGHT, Mankato, Minn., U.S.A.

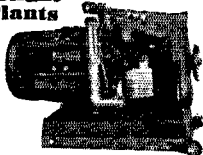

Piezo-Electric Crystals Exclusively

• Quality crystals of all practical frequencies supplied SINCE 1925. Prices quoted upon receipt of your specifications.

Our Pledge: **QUALITY FIRST**
SCIENTIFIC RADIO SERVICE

"The Crystal Specialists Since 1925" University Park, Hyattsville, Md.

SINCE 1923

BIRNBACH

QUALITY
Hamquarters for

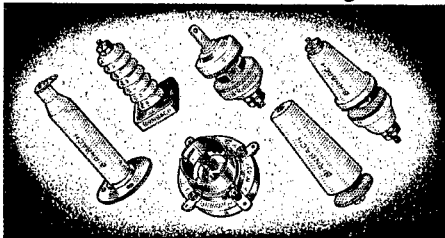

For better ceramics and greater resistance to R.F. loss in high and ultra-high frequency circuits, look to Birnbach! — "hamquarters" for porcelain and steatite insulators of every size and shape and for every purpose.

Birnbach insulators are made of highly vitrified, smoothly-glazed, low absorption porcelain and steatite and are shaped for maximum mechanical and electrical strength. These efficient units defy R.F. loss, voltage breakdown and harmful moisture.

Other Birnbach ham products include transmission line equipment, insulated jacks and plugs, shaft hardware and test leads.

Complete information can be obtained from your jobber or direct from us. Ask for catalog No. 27.

BIRNBACH RADIO CO. INC.
 145 T HUDSON ST. NEW YORK, N. Y.

MEMORANDUM

- ✓ You need a copy of the new 1940 Handbook.
- ✓ You need a binder for your 1939 *QST's* — and another for 1940.

★



Xmas suggestion — give a membership-subscription or a new Handbook.

JANUARY, 1940

Greetings Fellows!

START THE NEW! YEAR RIGHT ♦

By trading with a real HAM Parts House

We Resolve:

- To Give A-1 Service Always
- Lowest Payment Terms
- Fairest Trade-ins
- Be First with Latest Equipment
- Quick Replies to All Mail
- Satisfaction Guaranteed Always

WRITE LEO (W9GFQ) TODAY

FREE

Our New Exclusive 112 Page Ham Bargains Catalog

Most elaborate display of amateur equipment ever shown, chuck full of everything a ham could want at real prices for all. Write Leo (W9GFQ) today.

NO RED TAPE

With Us on Our LOW 6% Payment Plan

Write for Acquaintance Blank. We immediately go into action and within a few days have report. We finance our own paper — so make your own terms and let's get acquainted pronto!

A SAMPLE OF OUR PAYMENTS

Model of Item	Cash Price	Down Payment	12 Monthly Payments
New Sky Buddy	\$29.50	\$5.90	\$2.08
New Howard 430	32.95	6.59	2.32
New Howard 436	39.95	7.99	2.82
New Sky Champion	49.50	9.90	3.49
SX-24	69.50	13.90	4.90
Bretling 6	32.40	6.48	2.28
Bretling 9	54.00	10.80	3.81

Similar terms on any other receiver or xmtr.

BUY YOUR PARTS ON TIME FOR LESS

Amt. of Parts	Cash with Order	Pay Monthly
\$15.00	\$3.00	\$4.24 for 3 Mos.
25.00	5.00	4.24 for 5 Mos.
35.00	7.00	4.24 for 7 Mos.

12 months to pay on any order of \$25.00 or more if you wish

WRITE FOR DETAILS ON ANY AMOUNT

WHOLESALE RADIO LABORATORIES

746 West Broadway

Council Bluffs

Iowa

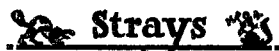

The pages of the log book often get "dog-eared" after use. This can be prevented by placing a paper clip over a dozen or so pages at the corner. — N8FU.

Oklahoma State Convention

ANOTHER Oklahoma State Convention has passed into the historical archives of amateur radio and a "well done" job to the credit of the Tulsa Amateur Radio Club. With an attendance of nearly 200 the sponsoring club seems to have prepared a program for everybody. With early registration Saturday, June 3rd, the program started with a visit to the Spartan Aircraft factory and such a trip enabled the gang to become better acquainted. On the return to the Hotel Tulsa, Director "Bill" Green, W5BKH, took charge of the meeting and discussed fully the 1939 Board of Directors meeting held at San Francisco. Following the discussion a movie of the A.R.R.L. Headquarters, which incidentally had a view of the 1937 board meeting, was shown and gave a good idea how such a meeting is conducted. At the conclusion of the movies everybody adjourned to the Cosmopolitan Club for a buffet supper and what a good time with so many good things to eat and drink. The first day ended with an initiation of the Royal Order of the Wooff Hong, in solemn conclave took place to the satisfaction of many who now belong to the "inner circle" of ham radio.

Sunday morning saw action in good lectures and speeches: Mr. Zimmerman, W5ERS, presented "some refinements on a simple phone monitor." A representative of the Dallas office of the F.C.C. expressed the eagerness of the F.C.C. to cooperate with the amateurs. Mr. Swift W5FDQ, of Tulsa, explained his famous "Double Barrel" antenna. Some sound remarks were made by Jack Dennis, 5ABZ, of the Public Service Co. on safety problems which was followed by a demonstration of the prone method of artificial respiration by W5BOR.

Fred Stromatt, former Muskogean, now with the Hallicrafters, gave the final technical talk on high-frequency receivers.

With the big banquet beginning at 1:30 P.M., enjoyed by all and the drawing of prizes the convention came to an end with the thanks of all to the convention committee for their successful efforts in holding this year's convention.

Wisconsin State Convention

OVER 200 amateurs from 53 cities journeyed to Wausau, Wisconsin, for the first state A.R.R.L. convention, September 2nd and 3rd, 1939. Activities started when Mayor Polster greeted the gang and handed them the keys to the city with instructions on how to handle the local police force. Mr. Murray, from F.C.C.'s Chicago.

office, spoke on "The Amateur and the B.C.L." Saturday afternoon was devoted to technical talks, with Rex Munger, W9LIP, giving the low-down on carbon anodes, and "Beep" Phelps, W9BP, using 1¼-meter scale models of various directive antenna systems to show the advantages and drawbacks of each type. Movies of League headquarters and a few reels of Twin Cities amateurs' ham shacks were shown at the evening party, followed by dancing and refreshments, and climaxed by a midnight conclave of the R.O.W.H., strikingly presented by the Milwaukee Radio Amateurs' Club.

A trip to Rib Mountain, highest point in the state, featured Sunday morning's program, where the Wisconsin Forestry Service and local hams collaborated to demonstrate their 32-Mc. fire tower intercommunication systems. Starting the afternoon program off with a bang, Mr. Kreuger, safety engineer of the local power company, presented a vivid demonstration of artificial respiration and a discussion on safety consciousness. At the A.R.R.L. meeting, SCM Al Kroner, W9UIT, Alternate Director Kreis, W9HRM, Assistant Director (Dakota Division) Emerson, W9ITQ, and Headquarters Representative John Huntton, W1LVQ, spoke on League matters, followed by an open forum meeting. C. E. Smith, W9ZTO, presided over the Sunday evening banquet and introduced W. B. Chilsen, local publisher, who entertained the gang with his Scandinavian stories. Prize drawings concluded the evening. The Wisconsin Valley Radio Association are to be congratulated on their fine handling of Wisconsin's first amateur convention.

— J. H.

West Gulf Division Convention

SOME two hundred and fifty delegates invaded Wichita Falls, Texas, on September 8th and 9th for the thirteenth annual convention, and proceeded to forget war, economics, and all else except ham radio and a good time. That they all succeeded in this was the unanimous opinion.

Sponsored by the Wichita Falls Amateur Radio Club, the convention got under way Friday morning, September 8th, with registration at the Marchman Hotel. The convention officially opened at 1:30 P.M. with a fine welcome address by "hizzoner" Mayor W. E. Fitzgerald, and answered by "Bud" Budlong of the A.R.R.L. staff. The precision with which the program and activities were carried out was indicative of the fine work of the convention committee, headed by W5ARS, David Clark and composed of W5AAM, Champ Smith; W5GTJ, Jess Stanbrough; W5CEE, Ivan Davis; W5GJW, Charles Stokes and W5NIY, Mike Davis. Every member of the Wichita Falls Club contributed his services, suggestions and criticisms, with the result that everyone attending left the convention with a little tinge of regret that "all good things must end."

One of the finest radio equipment shows ever presented in the West Gulf Division was provided

(Continued on page 118)

M
I
C
A

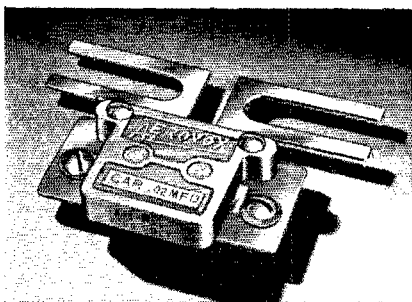

• CAPACITORS

Fifteen different types of bakelite-molded capacitors to choose from.

Silver mica capacitors for extreme accuracy.

Porcelain-case units for ultra-high-frequency applications.

Widest choice of terminals and mountings.

Everything you need for Xmitting and receiving "rigs."

● Bakelite-molded capacitors with meter-mounting brackets permitting r.f. shunting of meter windings, are now available in the remarkably complete AEROVOX line of mica capacitors. Likewise the option of low-loss or mica bakelite (yellow finish) in any type, at slight additional cost. ● To you as a builder of transmitters and receivers, this wider choice is not to be overlooked. ● Ask local jobber for 1939-40 catalog. Or write us direct.



How much are
you worth-
**TO YOURSELF,
YOUR FAMILY,
YOUR BOSS?**



• You can earn more money by training for a better job in

RADIO & TELEVISION ENGINEERING

■ Men who are not satisfied with their progress . . . who feel that they deserve a better job . . . are the very ones who will want to know more about the value of CREI spare-time training. YOU owe it to others as well as yourself to "make good" in a field that needs men with modern technical training. Your basic radio experience qualifies you to prepare for the better job that CREI training makes possible. We can help you as we have helped other ambitious men to ACTUALLY SUCCEED rather than "just thinking about it!"

Write for Free copy of
"The CREI Tested Plan"

48 interesting pages with scores of photographs and complete outline and description of CREI radio and television courses.



Capitol Radio Engineering Institute
Dept. Q-1, 3224 16th Street, N.W., Washington, D. C.

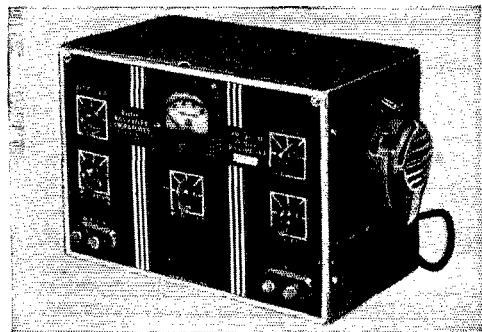

Treat yourself to a 1940 HFM

• There might be more costly equipment, but it would be difficult to select a more useful transmitter for any Amateur. The 1940 TYPE HFM is *small* and *powerful* — interchangeable with DC or AC packs in an instant — radiates phone or CW on six bands with only two crystals and is

Net to Amateurs.....\$57.60

RADIO TRANSCEIVER LABORATORIES
8627 115 STREET RICHMOND HILL, NEW YORK CITY
CABLE ADDRESS: "RATRALAB", NEW YORK

RADIO

ENGINEERING, broadcasting, aviation and radio telegraphy and telephony, police radio, servicing, marine accounting taught thoroughly. 48 weeks' engineering course, equivalent to three years of college radio work. School established 1874. All expenses low. Catalog free.

DODGE'S INSTITUTE, Day Street, Valparaiso, Indiana

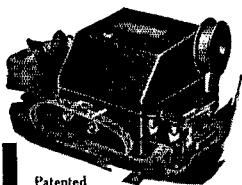

Patented

AUTOMATIC SENDER

Sends up to 70 words a minute. Motor driven. Entirely automatic. Built-in tape perforator. Absolute uniformity in spacing of characters.

Excellent practice medium for beginners when connected with buzzer or oscillator. Practice tape containing alphabet, numerals, word combinations, etc., together with ample supply of blank tape. Speed up your receiving. Accustom yourself to any speed up to 70 W.P.M. Full operating instructions. No extra equipment needed. If your dealer can't supply, write us.

FULLY GUARANTEED

GARDINER-LEVERING CO. Haddon Heights
New Jersey, U. S. A.

The Ideal
"HAM"
Xmas Gift

A Perfected

\$12.50

\$13.50
West of
Denver

Postpaid
in U. S. A.

by the manufacturers and distributors. Everything to gladden the heart or catch the eye of a ham was shown, from transparent spreaders to rotary beam.

Technical talks were made by M. P. Mims of Texarkana, Ark., — the old original "signal squirter" himself; and a discussion of the new Eimac 75-T by "Bill" Eitel of Eitel-McCullough, San Bruno, Calif.

Timely comments by A. L. Budlong, assistant secretary of the League Headquarters, were made. Group meetings or O.R.S., N.C.R., A.A.R.S., etc., brought excellent talks by prominent amateurs such as Carl Nuhn, W5EOE, R.M. of North Texas; W5CEZ, "Cart" Simpson, S.C.M. Oklahoma Section; W5BKH, Ensign "Bill" Green, director of the West Gulf Division, and David Calk, W5BHO, S.C.M. Southern Texas. Lieut.-Commander John J. Pierpont, U.S.N., who was just assigned to the eighth Naval District as communication officer on July 1st, flew over from Pensacola to attend the convention. The lighter side of the convention was amply provided by an open-air "barbecue" (North Texas style), followed by a dance and "hamboree" at one of the city's hot spots. For the ladies a nice program of entertainment was provided by the YF's of the W.F.R.C., including a bridge breakfast at the swanky Wichita Club, and a matinée "moon-pitcher" party which included the showing as a special attraction Pete Smith's specialty "Radio Hams."

As expected, the banquet (on which Wichita Falls' reputation has been built) was the big event of the convention. With "Chas." Stokes, W5GJW, acting as master of ceremonies, the noted guests were introduced, including Lieut.-Commander Pierpont, U.S.N.; A. L. Budlong, A.R.R.L.; Bill Green, Director; "Soupy" Groves, Past Director; "Dick" Hall representing the jobbers and M. F. Klicpera representing the manufacturers.

After awarding the numerous prizes, the "dog-fight" between Fort Worth and Galveston for the 1940 convention waxed hot and heavy, with Fort Worth emerging the victor in a spirited fight, high-lighted by some brilliant wit and horseplay.

The midnight conclave of the R.O.W.H. initiated 20 members.

The convention was a huge success, and the hard-working Wichita Falls amateurs deserve a big vote of thanks for their efforts.

— W5GJW

Atlantic Division Convention

THE population of Pittsburgh was swelled during June 23rd and 24th by 427 amateurs attending the 1939 Atlantic Division Convention at the Fort Pitt Hotel, sponsored by the Pittsburgh Area Radio Club Council.

After going through the necessary routine of registration on Friday morning, the delegates gathered to see motion pictures, under supervision of Mr. Henry Rockwood of the U. S. Weather Bureau, taken during the 1936 flood in and around

Pittsburgh. Following up an apparent keynote of emergency-consciousness, C. G. Landis, W3UA, gave an illustrated talk on the Susquehanna Valley Amateur Emergency Net and Roy Corderman, W3ZD, discussed portable radio stations. A technical discussion of crystal oscillators was given by John Reinartz, WIQP. The evening program began with a humorous dramatization of "BCL Q.R.M." H. F. Webb, Safety Engineer from the West Penn Power Company, gave a talk and demonstration on artificial respiration.

Saturday morning many of the delegates went on a tour of the city of Pittsburgh and its noted points of interest. In the afternoon, Rex Munger, W9LIP, spoke on amateur tube applications; Messrs. Cole and McLaughlin had the crowd guessing at their satirical take-off entitled "Crystals"; and Donald Exner, W8ZU, unraveled the intricacies of grid-modulated 'phone transmitters. President Woodruff presented for the gang's approval another edition of his famous "bag of tricks," and Dr. Philip Thomas, of Westinghouse, delighted the assembly with his demonstration of some unusual and spectacular applications of radio and electricity.

The convention was brought to a close with the banquet Saturday evening under the capable toastmastership of Director Martin, W3QV. Honored guests were Dr. Frank Conrad of W8XK, President Woodruff and A. L. Budlong, W1JFN, Headquarters representative. As a climax, the prizes were distributed to the winners.

Central Division Convention

THE Columbus Amateur Radio Association provided a bang-up program of education and entertainment to 425 amateurs and associates attending the 1939 Central Division convention in their city, September 8th-9th-10th. Since many of those present did not arrive until Friday evening, the afternoon sessions that day, consisting of talks on commercial receivers and microphones, were not well attended. Edward C. Jordan, Ohio State University, spoke on antenna fundamentals and field patterns, featuring the evening technical session.

League matters were discussed at the Saturday morning meeting, with talks by G. L. Dosland, W9TSN, Assistant Director, and John Huntoon, W1LVQ, headquarters representative. An open forum followed, brought to a conclusion only by the call to lunch. Starting off the afternoon sessions, again under the chairmanship of R. C. Higgy, W8LFE, Prof. W. L. Everitt of Ohio State gave the technically-minded much food for thought in his discussion of impedance relationships. Karl Kopetzky held the group's interest with his demonstration of the "diplomatic" rig, while John Kraus, W8JK, drew the largest crowd to witness his practical demonstration of how to trouble-shoot transmission lines. Adjourning preparatory to dinner, the delegates found ample time to look over the many exhibits of amateur equipment on display by manufacturers. At the

(Continued on page 120)

FREE BOOK ON HOW TO LEARN CODE AND BECOME A CODE EXPERT!



It is one of the most interesting books you have ever read. Fifty-two pages telling in T. R. McElroy's own words how he became *World's Champion!* How the Naval Reserve speeds up its operators. How L. R. McDonald, after years away from radio, came back to 75 w.p.m. How to become an operator. How to get the licence you want. How to become a *high speed expert*. How to copy on the "Mill" 2 to 6 words behind . . . easily . . . accurately . . . fast. It completely describes the famous Candler System in detail. Write at once for the "BOOK OF FACTS." It is *FREE!*

CANDLER SYSTEM CO.

Dept. Q-1 ASHEVILLE, N. C.

VOLTAGE REGULATED POWER SUPPLY KIT FOR THE NEW BROWNING EXCITER KIT

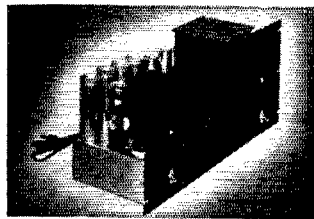

SPONSORED BY
★ AMPHENOL
★ CARDWELL
★ CORNELL
★ DUBILIER
★ KENYON
★ OHMITE
★ PAR-METAL
★ RAYTHEON

Here it is — a worthy companion to the great Browning development which was described in December Radio News. Sponsored by seven famous manufacturers of quality parts. The Power Supply features:

- LOW RIPPLE
- EXTREME ECONOMY
- SUPPLIES FILAMENT & PLATE for SPEECH
- VOLTAGE REGULATION

The Foundation Kit for the Voltage Regulated Power Supply Kit comprises Par-Metal chassis, front panel, 1 Kenyon T-223 Power Transformer and 2 Kenyon T-166 chokes. Complete instructions, data sheets, parts list, etc.; available at your jobber's or write us direct.

IMPORTANT

If you have not yet received data on the Browning Bandswitch Electron Coupled Exciter, get the facts at once. The Foundation Kit is all that is necessary to get you started. FREE Parts List, circuit diagrams, literature, now at your jobber's or write direct to: Browning Laboratories, Inc., Winchester, Mass.

What —

Is the F.C.C. Regulation Re: ?

- Operation in times of emergency
- Measurement of xmitter frequency
- Operation of 'phone transmitters
- Measurement of transmitter power
- Frequencies for ham television
- New ultra-high-frequency bands
- Stability of signals up to 60 Mc.

THE ANSWERS will be found in the current (tenth) edition of

THE RADIO AMATEUR'S LICENSE MANUAL

Going after your first ham "ticket"? You need the manual for its instructions on where to apply, how to go about it in the right way — and, most important of all, for the nearly 200 typical license exam questions and answers.

Already licensed? The manual is still necessary for its dope on renewal and modification procedure, the Class A exam (with typical questions and answers), portable procedure, etc.

ALL the dope on every phase of amateur licensing procedure, and, of course, the complete text of the new regulations and pertinent extracts from the basic radio law.

25¢ postpaid
(No stamps, please)

THE AMERICAN RADIO RELAY LEAGUE
West Hartford, Connecticut

banquet itself, Columbus's reputation for enjoyable entertainment was well upheld, and for two hours local talent kept the gang thoroughly amused. A few introductions of notables present, with an appropriately-short word from each, concluded the evening.

Lt. Col. Hineman presided at the A.A.R.S. group meeting the following morning, while Lt.-Com. Tummonds, N.C.R. W8BAH, took charge of the N.C.R. discussions. The delegates reconvened immediately after lunch for the drawing of prizes, and the 1939 convention became history. During the three-day affair, the ladies were well entertained with shopping trips, theatre and bridge parties.

— J. H.

Massachusetts State Convention

PREPARING a convention program to take care of an attendance of 1000 enthusiastic hams with their XYL's and YL's means real hard work, therefore the joint convention committee of the South Shore Amateur Radio Club and the Eastern Massachusetts Amateur Radio Association, which sponsored this year's State Convention and Boston Hamfest held in Boston, Mass., on October 21st deserve credit. Early Saturday morning the Hotel Bradford began filling up with groups from all over the state, and several delegations from surrounding states, which kept the registration desk busy every minute until banquet time. All formalities being dropped to save time the beginning of contests (both serious and humorous) started promptly under the supervision of W1IYU and W1JCX proving most interesting to the participants and the guests. The U.S. Army gave a demonstration of a "Walkie Talkie" which was followed by a good talk on Frequency Modulation ably presented by Paul DeMars. Then followed meetings for the DX man and Emergency 'Phone Net, W1LZ had a roomful for the DX meeting and it proved so interesting it overlapped the time assigned. Larry Mitchell, W1HIL, the SCM for Eastern Mass. Section, had charge of the A.R.R.L. meeting and the keynote of this meeting was emergency communication and neutrality. Mr. J. M. Henry, Engineering Department of N.E.T. & T. Co., spoke on some interesting phases of long range radio telephony. Illness of Director Perc Noble, prevented his attendance, but the division was well represented by Russ Bennett, W1GTN, Alternate Director, who took charge of the A.A.R.S. meeting and also spoke for the director at the Banquet. Boston is renowned

(Continued on next left-hand page)

RADIO TECHNOLOGY



RCA Institutes offer an intensive course of high standard embracing all phases of Radio and Television. Practical training with modern equipment at New York and Chicago schools. Also specialized courses and Home Study Courses under "No obligation" plan.

Illustrated Catalog on request

RCA INSTITUTES, INC. Dept. ST-40
A Radio Corporation of America Service

75 Varick St., New York 1154 Merchandise Mart, Chicago

Where to buy it

A directory of suppliers who carry in stock the products of these dependable manufacturers.



ALBANY, N. Y. Uncle Dave's Radio Shack 356 Broadway
ATLANTA, GEORGIA 265 Peachtree Street
 Radio Wire Television Inc.
BOSTON, MASS. Radio Shack 167 Washington Street
BOSTON, MASS. 110 Federal Street
 Radio Wire Television Inc.
BRONX, N. Y. 542 East Fordham Rd.
 Radio Wire Television Inc.
BUTLER, MISSOURI 211-215 N. Main Street
 Henry Radio Shop
CHICAGO, ILL. 833 W. Jackson Blvd.
 Allied Radio Corp.
CHICAGO, ILL. 901-911 W. Jackson Blvd.
 Radio Wire Television Inc.
CINCINNATI, OHIO 1103 Vine Street
 United Radio, Inc.
DETROIT, MICH. 325 E. Jefferson Ave.
 Radio Specialties Co.
DETROIT, MICHIGAN 11800 Woodward Ave.
 Radio Specialties Co.
HARTFORD, CONNECTICUT 227 Asylum Street
 Radio Inspection Service Company
HOUSTON, TEXAS 4021 Huey Street
 R. C. Hall & L. F. Hall
JAMAICA, L. I. 90-08 166th Street
 Radio Wire Television Inc.
KANSAS CITY, MO. 1012 McGee Street
 Burstein-Applebee Company
NEW YORK, N. Y. Harrison Radio Co. 12 West Broadway
NEW YORK, N. Y. 100 Sixth Ave.
 Radio Wire Television Inc.
NEWARK, N. J. 24 Central Ave.
 Radio Wire Television Inc.
READING, PENN. 404 Walnut St.
 George D. Barbey Company
SPRINGFIELD, MASS. T. F. Cushing 349 Worthington St.
WASHINGTON, D. C. 938 F Street, N. W.
 Sun Radio & Service Supply Co.

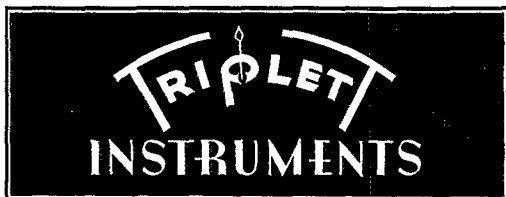

ALBANY, N. Y. Uncle Dave's Radio Shack 356 Broadway
ATLANTA, GEORGIA 265 Peachtree Street
 Radio Wire Television Inc.
BOSTON, MASS. Radio Shack 167 Washington Street
BOSTON, MASS. 110 Federal Street
 Radio Wire Television Inc.
BRONX, N. Y. 542 East Fordham Rd.
 Radio Wire Television Inc.
BUTLER, MISSOURI 211-215 N. Main Street
 Henry Radio Shop
CHICAGO, ILLINOIS 833 W. Jackson Blvd.
 Allied Radio Corp.
CHICAGO, ILLINOIS 25 North Franklin Street
 Electric & Radio Supply Co., Inc.
CHICAGO, ILL. 901-911 W. Jackson Blvd.
 Radio Wire Television Inc.
CINCINNATI, OHIO 1103 Vine Street
 United Radio, Inc.
JAMAICA, L. I. 90-08 166th Street
 Radio Wire Television Inc.
LITTLE ROCK, ARKANSAS 409 W. 3rd St.
 Beam Radio Company
MINNEAPOLIS, MINNESOTA 1124-26 Harmon Place
 Lew Bonn Company
MUSKOGEE, OKLAHOMA 204 No. Twelfth Street
 Home Radio Mart
NEW YORK, N. Y. 100 Sixth Avenue
 Radio Wire Television Inc.
NEWARK, N. J. 24 Central Ave.
 Radio Wire Television Inc.
READING, PENN. George D. Barbey Co. 404 Walnut Street
WASHINGTON, D. C. 938 F Street, N. W.
 Sun Radio & Service Supply Co.

Listings on this page do not necessarily imply endorsement by QST of the dealers or of other equipment sold by them.

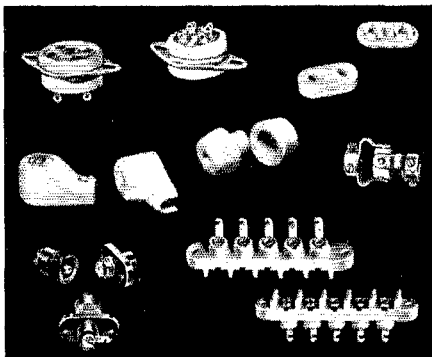

New Parts Designed for Application

Safety Terminals, Insulated Rectifier and Thyatron Connectors, High Voltage Tube Sockets, Iron Core RF Chokes, Quartz Q Polystyrene Insulation, High Frequency Variable Condensers, Meter Type Dials, Cast Aluminum Chassis, etc.

JAMES MILLEN
150 EXCHANGE ST.



MFG. CO. INC.
MALDEN, MASS.

"IT CUTS DOWN CURRENT"

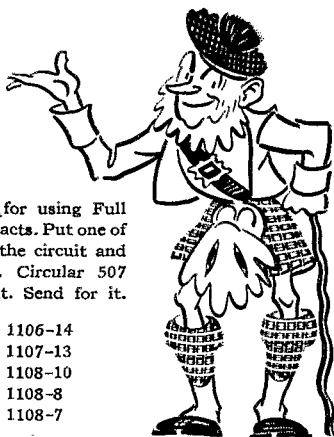
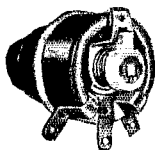

There is no need for using Full Power on local contacts. Put one of these rheostats in the circuit and cut down current. Circular 507 shows this rheostat. Send for it.

50 watt use	1106-14
100 " "	1107-13
250 " "	1108-10
400 " "	1108-8
500 " "	1108-7

WARD LEONARD RADIO SPECIALTIES

WARD LEONARD ELECTRIC COMPANY
41 South St., Mount Vernon, N. Y.

Please send FREE Bulletin 537

Name

Street

City and State

Call Signal

122

for its food and the multitude sat down at the festive board with a good old-fashioned turkey dinner with all the fixings. Of course there are always speeches at banquets, but George Bailey, W1KH, the perennial toastmaster, very ably kept each speaker to two minutes. Don McBeth, W1FSK, the general chairman, extended the greetings of the committee and the clubs sponsoring the affair and then a few words from Dr. Eugene C. Woodruff, W8CMP, President of the A.R.R.L.; Arthur A. Hebert, A.R.R.L. Veteran Treasurer; Charles C. Kolster, the likable Radio Inspector of the First district. The Army and Navy were officially represented. After enjoying the banquet everyone adjourned to the "Prize" room where the drawing for prizes began, and what a lot of worth-while prizes too, and we must not forget the cooperation given the committee by the radio dealers for their fine exhibits. And so came to an end another one of those good conventions.

The Vermont State Convention

THE enthusiasm of the Vermont radio amateurs always makes up for lack of numbers and this was well demonstrated on Saturday, October 14th, when the Green Mountain Radio Club acted as host for the annual convention held in Rutland. Early Saturday hams with their YL's and XYL's began to arrive and by twelve o'clock noon the Hotel Bardwell was buzzing with the greetings of friends old and new. After the ladies started for the theatre party the regular planned meetings got underway. W1AVP, the PAM, took charge of the 'phone meeting, followed by the NCR meeting in charge of W1GYG. The A.A.R.S. was well represented, having as its guest Lieut.-Colonel Huston, Signal Officer, 1st Corps Area. This meeting was in charge of W1FSV, State Radio Aide. Director Noble who is also National Radio Aide, participated in many of the meetings, assisted by F. E. Handy, the A.R.R.L. Communications Manager. The traffic and emergency meeting, under the leadership of Cliff Parker, W1KJG, the SCM for Vermont, was replete with interesting discussions, and when the time came to sit down at the banquet the crowd was ready and enjoyed the good meal served. Attorney Milford K. Smith did the honors as toastmaster and saw to it that everything went smoothly. The skit of W1AAJ was thoroughly enjoyed and with the drawing of the prizes and dancing from 9:00 to midnight everyone was willing to call it a day. The thanks of those present go to Bob Teachout, W1FSV, and his committee for again making it possible to have this annual convention.

RADIO COURSES

New Classes Start in January

RADIO OPERATING • BROADCASTING • CODE
RADIO SERVICING • TELEVISION
• ELECTRONICS — 1 year day course; 2 years eve.
Day and Evening Classes — Booklet upon request

NEW YORK YMCA SCHOOLS
4 West 63rd Street, New York City

HAM-ADS

(1) Advertising shall pertain to radio and shall be of nature of interest to radio amateurs or experimenters in their pursuit of the art.

(2) No display of any character will be accepted, nor can any special typographical arrangement, such as all or part capital letters be used which would tend to make one advertisement stand out from the others.

(3) The Ham-Ad rate is 15¢ per word, except as noted in paragraph (6) below.

(4) Remittance in full must accompany copy. No cash or contract discount or agency commission will be allowed.

(5) Closing date for Ham-Ads is the 25th of the second month preceding publication date.

(6) A special rate of 7¢ per word will apply to advertising which, in our judgment, is obviously non-commercial in nature and is placed and signed by a member of the American Radio Relay League. Thus, advertising of bona fide surplus equipment owned, used and for sale by an individual or apparatus offered for exchange or advertising inquiring for special equipment, if by a member of the American Radio Relay League takes the 7¢ rate. An attempt to deal in apparatus in quantity for profit, even if by an individual, is commercial and all advertising by him takes the 15¢ rate. Provisions of paragraphs (1), (2), (4) and (5) apply to all advertising in this column regardless of which rate may apply.

Having made no investigation of the advertisers in the classified columns, the publishers of *QST* are unable to vouch for their integrity or for the grade or character of the products advertised.

QUARTZ — direct importers from Brazil of best quality pure quartz suitable for making piezo-electric crystals.

Diamond Drill Carbon Co., 719 World Bldg., New York City.

USED receivers. Bargains. Cash only. No trades. Price list 3¢. W3DQ, Wilmington, Del.

QSL's. Free samples. Printer, Corwith, Iowa.

CALLBOOKS — Winter edition now on sale containing complete up-to-date list of radio hams throughout entire world. Also world prefix map, and new time conversion chart. Single copies \$1.25. Canada and foreign \$1.35. Radio Amateur Call Book, 610 S. Dearborn, Chicago.

QSL'S — By W8NOS — 13 Swan St., Buffalo, N. Y.

WHY not get better deal? Used receiver list free. W9RA, Chi-Rad, 415 So. Dearborn St., Chicago.

QSL'S, all colors, cartoons, snappy service. Write for free samples today. W1BEF, 78 Warren, Springfield, Mass.

CRYSTALS: police, marine, aircraft, and amateur frequencies. Descriptive catalog. Ham Crystals, 1104 Lincoln Place, Brooklyn, N. Y.

QSL'S. Samples. W9RUJ, Auburn, Neb.

CRYSTALS in plug-in heat dissipating holders. Guaranteed good oscillators. 160M — 80M, \$1.25. (No Y cuts.) 40X, \$1.65. 80M vari-frequency (5 kilocycle variance) complete, \$2.95. State frequency desired. C.O.D.'s accepted. Pacific Crystals, 1042 S. Hicks, Los Angeles.

QSL'S. Samples. W6HBR Radio Press, P. O. Box 202, Clemenceau, Ariz.

CRYSTALS, mounted, 80-160, \$1.25, V-cut 40, \$2.25. R9 Crystals, 338 Murray Ave., Arnold, Pa.

QSL'S of distinction — samples. W2AEY, 338 Elmora, Elizabeth, N. J.

TELEPLEXES, Instructographs, omnigraphs bought, sold, traded. Ryan's, Hannibal, Mo.

GOVERNMENT contract surplus portable transmitters, direction finders, standard and special parts. Send postcard for special bargain list. Airplane & Marine Direction Finder Corp., Clearfield, Pa.

MACAUTO code machines: low monthly rental 50,000 words practice tapes. Write N. C. Ayers, 711 Boylston St., Boston, Mass. GRANITE 7189-W.

DOUGLAS universal modulation transformers, 50 watts audio, \$4.95 pair, 100 watts audio, \$7.75 pair, postpaid in U. S. One year guarantee. Write W9LXR, Rice Lake, Wis.

QSL'S — samples. Brownie, W3CJI, 523 No. Tenth St., Allentown, Pa.

CRYSTAL ovens adaptable any round holder 2 x 1 inches or less. Specify 8.3 or 2.5 voltage. \$1.50 postpaid. Sodaro Mfg., 1115 N. Lockwood, Chicago.

IFS Rubber crystal, QSY remotely, varies completely 160 to 10 meters. Approximately 20 watts output, \$19.50. All Electric Co., 1522 No. Clark, Chicago, W9LPS.

QSL'S, **QSL's**. Printed same day order received. Samples? W5DED, Holland, Mich. (QST renewals appreciated.)

BARKER and Williamson 100 watt exciter, \$70.; HQ-120-X, \$90. W3HHJ.

SELL: new Gammatron HK154 — \$4. Excellent for grid modulation. W9AKJ.

COMPLETE line Arvin radios at special jobbing prices. Loughnane & Co., Decatur, Ill.

FB7A — powerpack — four sets bandsread coils, \$32.50. W8KJ.

SELL: NC100, \$45; 1 kw. phone, \$150; 100 watt phone, \$50; 3 KVA, 120 v. alternator, \$50; 500 watt, 120 v. alternator, \$15; 350 watt, 1000 or 1500 v. dynamotor, \$10; 1000 v., 250 watt engine-generator, \$25; oscilloscope, \$7.50. Also 16 mm. projector, 9" South Bend metal lathe and arc welding transformer. List or pictures for stamp. W9EWM, Liberal, Kansas.

DUE to lack of time to operate, must sell my HQ-120-X receiver. Best offer takes it. W1LDR.

QSL'S. Latest. Fine quality. Samples. Maleco, 1805 St. Johns Place, Brooklyn, N. Y.

STRETCH those \$\$\$\$\$. Save half on your beam. Link coupled tip-down head steel frame rotator, aluminum elements. Our bulletins, photos show you how. Rotary Array Service, W8ML.

SELL — 14 watt Radio Constructors Labs, Duplex 2½ — 5 — 10 meter transmitter receiver — never been used — \$20. Mattison, 226 S. Kenilworth, Lima, Ohio.

CRYSTALS — police, marine, aircraft, amateur. Catalog on request. C-W Mfg. Co., 1170 Esperanza, Los Angeles.

XMT'R — steel rack mounted National, Cardwell, Thordarson parts. RK25, RK25, 811, pair 150T's. Nine large Triplett meters. Six xtal sockets panel selection. B & W swinging link final. Separate power supplies each stage. Regulated C supply, \$145. Less K.W. final power supply, \$95. W8QAN.

QSL'S — Rainbo effects. Fritz, 455 Mason, Joliet, Ill.

SELL: RME 5-10X, \$17.50. W9ARN.

TWO CW three hundred watt transmitters in handsome cabinet. One eighty, other forty and twenty; completely remote controlled. Write W3DD.

BCL interference eliminated or no charge. Wes Alderson, Wyoming 8167 or 819 N. Fuller, Los Angeles.

SELLING complete 150 watt fone & CW xmt'r, modern 10 to 80 meters. W9DLC, Butler, Mo.

QSL'S. Maps. Cartoons. Free samples. Theodore Porcher, 7708 Navahoe, Philadelphia, Pa.

JUNIOR Instructograph full equipment, \$10. Arthur Lindgren, 2819 Logan Blvd., Chicago, Ill.

WANTED: Decade bridge; omnigraph, tape recorder; books on telephony, acoustics, and sound; field telephone; old QST's; 5-10 receiver. Give price. Longley, Y.M.C.A., Little Falls, N. Y.

SELL: CW transmitter: 6L6GX, 6L6G, pair HK24's, 1000 volt supply, tubes, coils for forty and ten, Triplett meter, B5 crystal. Complete, \$45. W8QMN.

CRYSTALS: There is a definite reason why thousands of leading amateurs buy T9 crystals time and again — high quality and satisfaction with economy. Unbeatable at twice the price. Fully guaranteed. 40 and 80 meter bands \$1.60 approximate frequency, \$2. exact, \$3. exact mounted. T9 ceramic holders, \$1. Prices postpaid. C.O.D.'s accepted. Fine commercial crystals to order, inquire. Sold by these and other reputable dealers: Valley Radio Distributors, Appleton, Wis.; Hieronymus Radio, 88-34 209th, Queens Village, N. Y.; Henry Radio Shop, Butler, Mo.; Radio Doc, 721 S. Main, Los Angeles, Calif.; Penbleton Labs., Ft. Wayne Ind.; Frank Anzalone, 375 W. 46th, N. Y. C.; Casa Edison, Havana, Cuba; and Edison's, Temple, Texas.

QSL'S. Show individuality with photographic QSL post cards, reproduced from original photos, 100 for \$2.25. Samples upon request. Oreajo Photo Art, 303 Keowee St., Dayton, Ohio.

COMPARE prices. All reconitioned. SW3 — \$5; FBX — \$12; Howard 430 — \$15; Sky Buddy — \$12; Breting 9 — \$33. List free. W9KEH, Van Sickle Radio Co., St. Louis, Mo.

SELL Johnson 50CD130 condenser, \$6., 12 to 1000 v. dynamotor, \$12.; 100 w. 110 v. alternator, \$5. W9ERU.

CRYSTAL — grinders blanks, modern cuts. W8OUR, Paul Byers, Indiana, Pa.

RACKS — \$8.25. See December Hamads. Schaaf, 4741 Byron, Chicago.

SELL 2 new RCA 852's, \$5. each. W8GWT.

BEST deal on Hallicrafter receivers and Hytron tubes. Good used SX-9, cheap. Write for prices. W9YCF, Auburn, Ind.

SELL — surplus parts, bargains. W2VG.

QSL'S — SWL's. Colorful, economical. Free samples. Meade, 819 Wyandotte, Kansas City, Mo.

SELL: Transmitter and receiver. W3GVA, 725 Folk St., Easton, Pa.

CALL letters — 20K gold \$1. per 2' letter, sterling silver 75¢, heavy plate, any color background, any mounting — literature. Harold Ramsey, W8TGU, Bethesda Hospital, Zanesville, Ohio.

SELLING W2DII — three 350 watt transmitters — 6 power supplies — 2 FBXA's, SW5, Comet Pro — list.

QSL'S — SWL's, 100, 3 color, 75¢, Lapco, 344 W. 39th, Indianapolis, Ind.

COMPLETE stock of all amateur receivers, transmitters, kits, antennas, tubes, parts. Send to me for anything in any catalog or advertisement. I guarantee you can't buy for less or on better terms elsewhere. Your inquiries and orders invited. W9ARA, Butler, Mo.

RECONDITIONED guaranteed communications receivers and transmitters. Nearly all models cheap. Ten days free trial. Terms. Write for free list. W9ARA, Butler, Mo.

WANTED: Used NC100s, NC100Xs, NC80Xs, Howard 430s. Will pay cash or allow credit on other equipment. Write. W9ARA, Butler, Mo.

HALLICRAFTER SX-24, brand new, \$57.50. Also Hallicrafter SX-23, \$95. W2EXR.

ATTENTION W1's. RME 69 and Utah 500 watt transmitter, complete for 14 mc. Both for \$175, or separately for best offer. Supreme 89D tube tester, \$22. New RK38, \$8. W1CLE, Rockland, Mass.

NATIONAL NTX-30 transmitter with two 4-in-1 xtal holders, fixture for eco connection, \$95; Harvey UHX-10 transmitter and UHX-10P power supply, all hand coils, \$90; NC-100A conversion, \$85; National NSA speech amplifier, \$55; Meissner Signal Shifter with 80 meter coils, \$30; f.o.b. Seattle. W7GXP.

WANTED: relay rack — d.c. SW3. W3FIS.

CRYSTALS: famous P.R., mounted in latest Alsmag 35 holders — 40, 80 meter PR-X, 160 meter PR-Z, \$3; 40, 80 meter PR-Z (low drift), \$3.50; 20-meter PR-20, \$4.50; unconditionally guaranteed. Immediate shipment. Wholesale Radio Labs., Council Bluffs, Iowa, W9GFQ.

EVERYTHING for the amateur at the lowest prices. Write for big new Ham bargain catalog and get acquainted with a real Ham house. Get what you want pronto on your own terms from Leo W9GFQ.

FELLOWS — you needn't look further for real bargains on thoroughly reconditioned receivers. Free trial, too, and you can make your own terms as we finance them ourselves. Get the best buys on new or used parts. Write Leo W9GFQ today. Wholesale Radio Labs., Council Bluffs, Iowa.

CLOSING out — Navy surplus — thousands sold — GE dynamotors 24/750 volt 200 mills, \$15; Westinghouse 6-15 volt 500 watts, \$8; 500 cycle 500 watt with exciters, \$8. List. Henry Kienzie, 215 Hart Blvd., Staten Island, N. Y.

SELL or trade: Esco motor-generator set 1000 v, 300 ma., Esco motor set 500 v, 300 ma., one Esco generator with or without motor 1000 v, 1000 ma. All excellent condition. Need RME-DB preselector and late receiver ten meter up. W5SP.

UTC SX80 — 80 watt CW xmitter, Browning 35 superhet. Vibroxplex, accessories, any offer considered. Leeds, 72-15 37th Ave., Jackson Heights, L. I.

ACR175 like new, 25 — 60 cycle hifreq. antenna, \$65. Pemberton, 250 Meigs St., Rochester, N. Y.

SICKLES COILS

SECURE A COPY OF OUR NO. 939
CATALOG FROM YOUR JOBBER

F. W. SICKLES COMPANY

300 Main Street

Springfield, Mass.

STUMPED by CODE? BAFFLED by THEORY?

HERE IS THE WAY OUT!

We have put hundreds of amateurs on the air and
can do the same for you!

WRITE US TODAY

AMERICAN RADIO INSTITUTE
1123 Broadway, New York, N. Y.



AIR INDUCTOR BEAUTY IS MORE THAN "SKIN DEEP"!

One big reason for the tremendous popularity of AIR INDUCTORS is their neat, business-like appearance. But that's only part of the story. Amateurs in every corner of the globe have learned, by actual experience, that B & W Coils are more accurate, more dependable — deliver better all-round performance at low cost.

The B & W Type BL, illustrated here, is a typical example of AIR INDUCTOR value. They're good-looking and mechanically strong. Try them in your rig; you be the judge!

Type BL (illustrated) is available center or end linked. Type B is the straight coil, center tapped. Both types from 5 to 160 meters; priced from \$1.00 to \$2.50 net.

See them at your jobbers — or write for details

BARKER & WILLIAMSON

Radio Manufacturing Engineers • ARDMORE, PENNSYLVANIA

Get Sure-Fire Operation with

TURNER 99 DYNAMIC

Official Microphone
at W6USA, Cali-
fornia Exposition

Gunmetal Finish,
Professional
Appearance

Won't Blast from
Close Speaking

Absence of Peaks
Eliminates Feedback

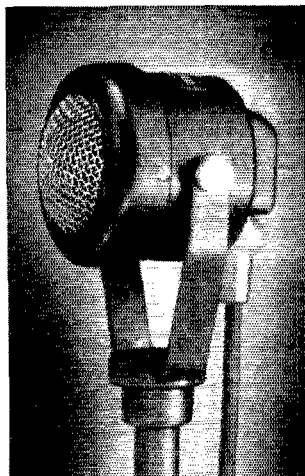

The ideal microphone for the man who insists on crisp, clear signals. Not "boomy." Will not blast from close speaking. Takes abuse and withstands climate and temperature changes without giving up. Step up your equipment with Turner 99. Range 40-9000 cycles. Level — 52DB. Complete with 25 ft. removable cable set. Free wiring diagrams.

Write for New Mike Catalog

HI-IMPEDANCE
\$29.50 List

The TURNER CO.

904 17th St. N. E.
CEDAR RAPIDS, IOWA

Your Nearby Dealer Is Your Best Friend

Your nearby dealer is entitled to your patronage. He is equipped with a knowledge and understanding of amateur radio. He is your logical source of advice and counsel on what equipment you should buy. His stock is complete. He can supply your needs without delay. His prices are fair and consistent with the high quality of the goods he carries. He is responsible to you and interested in you.

One of these dealers is probably in your city—Patronize him!

CHICAGO, ILLINOIS

Allied Radio Corporation
833 West Jackson Blvd.

Complete standard lines always in stock—W9IBC, W9DDM, W9AJK

CHICAGO, ILLINOIS

Chicago Radio Apparatus Company
415 South Dearborn Street (Est. 1921)

W9RA and W9PST — Amateurs since 1909

CHICAGO, ILLINOIS

Radio Wire Television Inc.
901-11 West Jackson Boulevard

"The World's Largest Radio Supply House"

DES MOINES, IOWA

Iowa Radio Corp.
1212 Grand Avenue
Complete amateur stock, W9OCG — W9EMS — W9KAY

DETROIT, MICHIGAN

Radio Specialties Company
325 E. Jefferson Avenue
Ham Supplies — National & Hammarlund Sets and Parts

KANSAS CITY, MISSOURI

Burstein-Applebee Company
1012-14 McGee Street
"Specialists" in supplies for the Amateur and Serviceman

KANSAS CITY, MISSOURI

Radiolab
1515 Grand Avenue
Amateur Headquarters in Kansas City

MILWAUKEE, WISCONSIN

Radio Parts Company, Inc.
538 West State Street
Complete stock Nationally Known products

MINNEAPOLIS, MINNESOTA

Lew Bonn Co.
1124-26 Harmon Place
W9BP — W9TLE — W9ZXV — W9DKL — W9VED

SEATTLE, WASHINGTON

Northern Radio Company
2208 Fourth Avenue
W7AWP, W7MB, W7VP, W7XL, W7XK, and W7CR to serve you

ST. LOUIS, MISSOURI

Van Sickle Radio Company
1113 Pine Street
Owned and operated by W9OWD, W9TCJ, W9KEH

YOU CAN BE SURE
WHEN YOU BUY FROM

QST

ADVERTISERS

“Advertising for *QST* is accepted only from firms who, in the publisher’s opinion, are of established integrity and whose products secure the approval of the technical staff of the American Radio Relay League.”

Quoted from QST’s advertising rate card.

Every conceivable need of a radio amateur can be supplied by the advertisers in QST. And you will know the product has the approval of the League’s technical staff

Index to Advertisers

Aerovox Corporation.....	117
American Radio Institute.....	124
Astatic Microphone Laboratory, Inc.....	113
Barker & Williamson.....	124
Birnbaach Radio Company.....	115
Bliley Electric Company.....	87
Browning Laboratories, Inc.....	119
Candler System Company.....	119
Capitol Radio Engineering Institute.....	117
Cardwell Mfg. Company, Allen D.....	80
Centralab.....	78
Chicago Radio Apparatus Company.....	112
Collins Radio Company.....	Cov. 2
Cornell-Dubilier Electric Corp.....	81
Dodge’s Institute.....	118
Dumont Electric Company, Inc.....	115
Eitel-McCullough, Inc.....	111
Electro-Voice Mfg. Company.....	94
Gardiner-Levering Company.....	118
General Electric Company.....	7, 76
Guthman & Company, Inc., Edwin J.....	106
Hallicrafters, Inc., The.....	1, 2
Hammarlund Mfg. Company, Inc.....	75, 89
Harrison Radio Company.....	109
Harvey Radio Company.....	112
Heintz & Kaufman, Ltd.....	91
Henry Radio Sylvania Schools.....	93
Hipower Crystal Company.....	108
Howard Radio Company.....	4, 5
Instructograph Company.....	114
Kato Engineering Company.....	115
Ken-Rad Tube & Lamp Corp.....	111
Kenyon Transformer Company, Inc.....	77
Lampkin Laboratories.....	111
Mallory & Company, Inc., P. R.....	74
Massachusetts Radio School.....	113
Meissner Mfg. Company, Inc.....	95
Millen Mfg. Company, Inc., James.....	122
Monitor Piezo Products.....	98
National Company, Inc.....	Cov. 3, 73, 79, 82
New York YMCA Schools.....	122
Newark Electric Company.....	103
Nilson Radio School.....	108
Ohmite Mfg. Company.....	84
Pioneer Gen-E-Motor Corp.....	110
Port Arthur College.....	115
Precision Apparatus Corp.....	96
Precision Piezo Service.....	111
Premax Products.....	114
RCA Institutes, Inc.....	120
Radio City Products.....	90
Radio Mfg. Engineers, Inc.....	127
Radio Shack, The.....	97
Radio Transceiver Laboratories.....	118
Ramsey Publishing Company.....	114
Scientific Radio Service.....	115
Shuler Supply Company.....	120
Sickles Company, F. W.....	124
Signal Electric Mfg. Company.....	110
Solar Mfg. Corp.....	113
Southwest Radio Supply.....	97
Sprague Products Company.....	102
Sun Radio Company.....	116
Taylor Tubes, Inc.....	83
Teleplex Company.....	113
Terminal Radio Corp.....	120
Thordarson Electric Mfg. Company.....	85
Triplet Electrical Instrument Company, Inc.....	92
Turner Company.....	124
United Transformer Corp.....	128
Vibroplex Company, Inc., The.....	106
Ward Leonard Electric Company.....	122
Wholesale Radio Laboratories.....	116
Yaxley.....	74

RADIO MFG. ENGINEERS INC. PEORIA ILL.

Precision built RME ultra-high frequency receiving equipment together with a well designed beam antenna system provides a balanced station with unlimited possibilities for 5 & 10 meter communication.

Circular 89 sent on request.

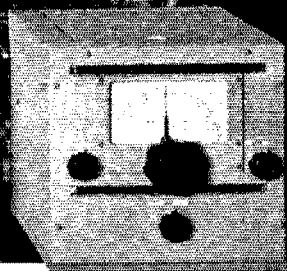

DM-36 EXPANDER

HF-10 RECEIVER



Complete Transformer Line

FOR EVERY PURPOSE



LINEAR STANDARD COMPONENTS

have a guaranteed flat frequency response from 30 to 20,000 cycles with maximum shielding and low insertion loss.



ULTRA-COMPACT TRANSFORMERS

weigh only 5½ ounces, and afford uniform response from 30 to 20,000 cycles . . . ideal for remote pick-up service.



VARIMATCH TRANSFORMERS

are the perfect solution to the wide range of impedance matching combinations encountered in amateur driver, modulation, and cathode modulation service.



UTC SPECIAL SERIES

transformers are attractive units representing unprecedented values . . . every item designed specifically for the amateur.

FOR THE BROADCAST STATION

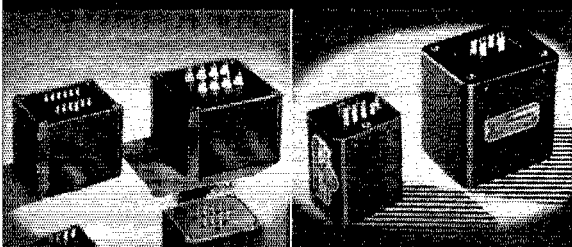

HIPERM ALLOY UNITS

are in high conductivity drawn cases. They have uniform 30 to 20,000 cycle response with medium weight and size.



FOR PORTABLE SERVICE

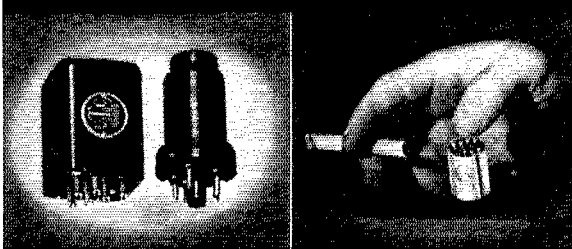

OUNCER TRANSFORMERS

as their name would imply, weigh approximately one ounce, and represent the acme in transformer development for concealed service, hearing aids, etc.



FOR COMMERCIAL AND AMATEUR EQUIPMENT

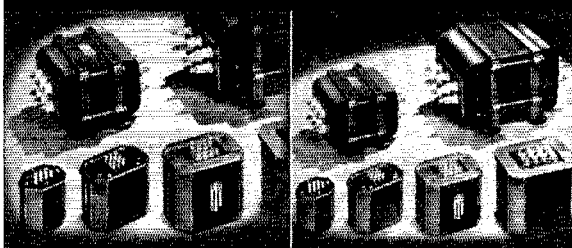

PA POWER COMPONENTS

are designed to commercial and A.I.E.E. standards. They are rugged, dependable units suitable for every type of commercial and amateur service.



FOR THE AMATEUR

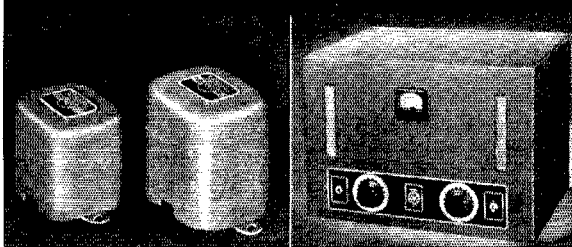

UTC KITS

are available for a wide range of PA and transmitter applications. Complete modulator kits are available for Cathode Modulation.

UNITED TRANSFORMER CORP.

Write: COMMUNICATIONS DIV. ★ 150 VARICK ST. ★ NEW YORK, N. Y.
EXPORT DIVISION: 100 VARICK STREET NEW YORK, N. Y. CABLES: "ARLAB"

QST for January, 1940, WESTERN Edition

PRINTED IN U. S. A.
RUMFORD PRESS
CONCORD, N. H.



"When recently asked if I had a sweetheart, I replied with a very firm negative answer. But, after having thought it over seriously for some time, I decided to make the following statement.

"Yes, I retracted, I have a sweetheart. Her voice is soft, and clearly beautiful as sounding bells. She speaks to me in a thousand tongues. When I am in a quiet mood she sings to me sweetly. She can swing and jive too, if I want her to.

"Sometimes she soothes me with a tale of tropic seas. Then again she may send my blood racing with high adventure or dramatic tragedy.

"Any hour of the day or night she is willing to do my bidding, unflinching and without question. She fits my every mood. She causes no remorse, no heartache. And I am never lonely, because she is always where I can find her.

"She is lovely as she sits there so quietly in her black glossy gown. You see, I explained, she is my National HRO Sr."

JOHN K. YOUNG (W8JHS)

We receive many testimonials, which repose safely in our files, but the lyric quality of Mr. Young's comments make his letter so unique that we thought we would publish it just as it came to us. The picture was our own idea. National Company, Inc., Malden, Mass.

TO ALL
AMATEURS

our sincere wishes

for

A Very

Merry Christmas

and a

Happy New Year

the hallicrafters inc.

