

QST

april, 1940
25 cents

devoted entirely to
**amateur
radio**

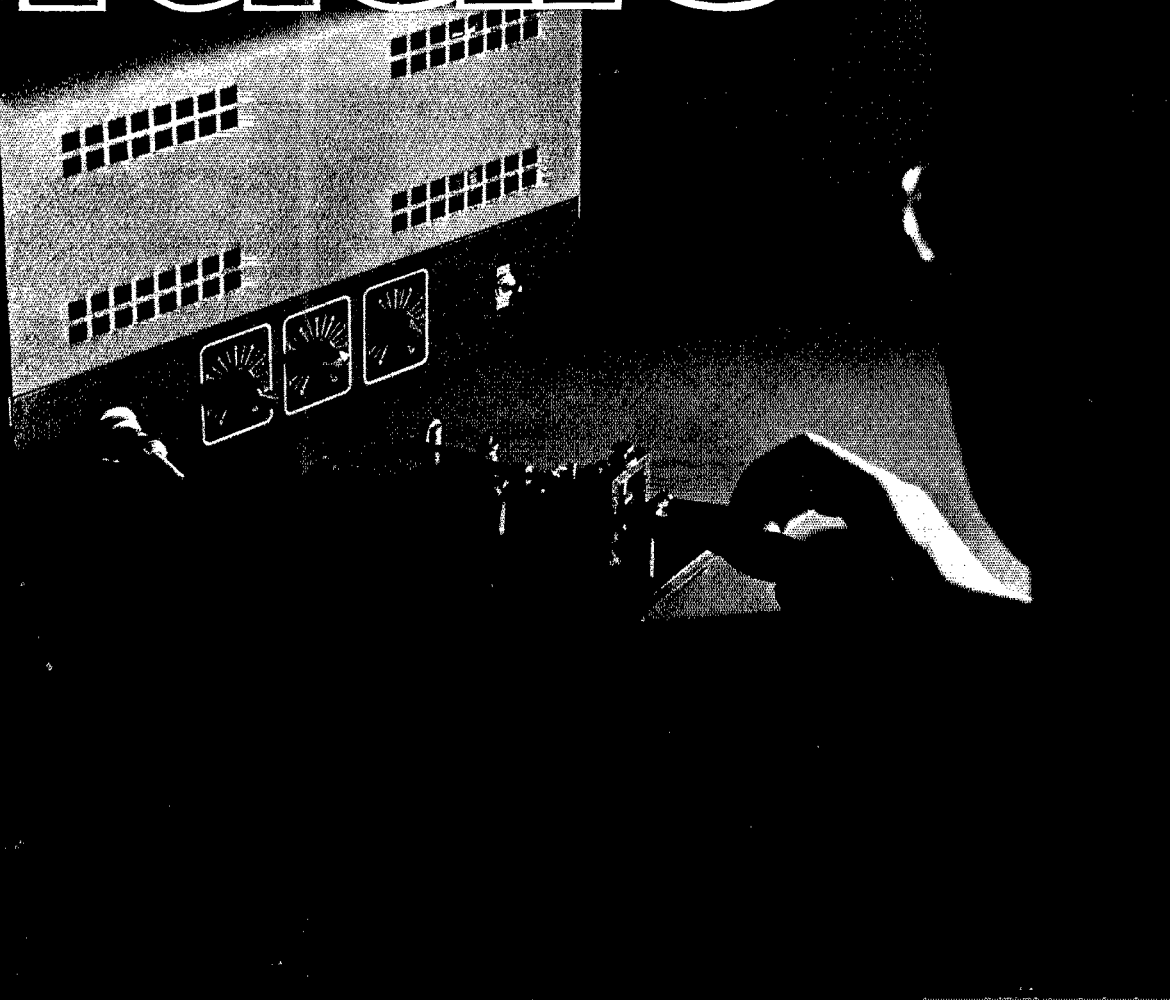

In This Issue—An Electronic Key • British Transmitters

COLLINS 2310 AUTOTUNE TRANSMITTER

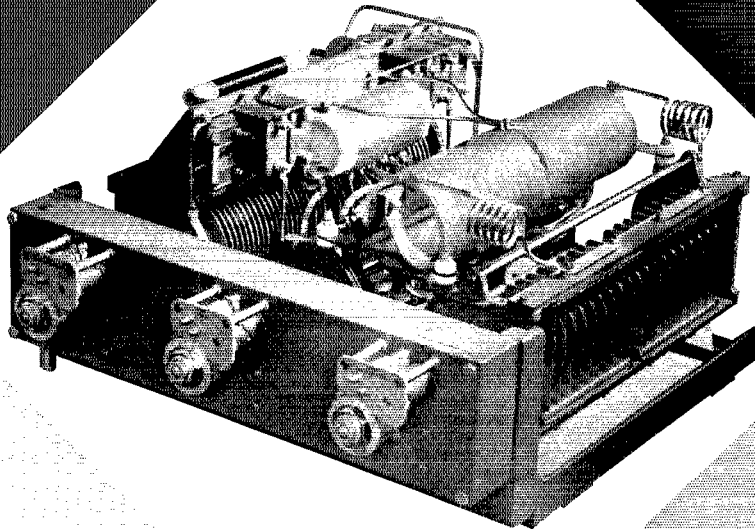

The output network in the 231 Series Transmitters does several things that have never been done so successfully before. It covers the frequency range 2.5 - 20 mc continuously with only 3 controls. No taps or coils are changed for any combination of operating frequencies. It efficiently matches a push-pull amplifier to a balanced or unbalanced antenna load and accommodates a wide range of antenna resistances and impedances. It, of course, embodies the Autotune System of automatic frequency shift.

COLLINS RADIO COMPANY

CEDAR RAPIDS, IOWA NEW YORK, N. Y. 31 WEST 42 STREET

27-145 MEGACYCLE RANGE (11.1-2.07 METERS) AMPLITUDE/FREQUENCY MODULATION

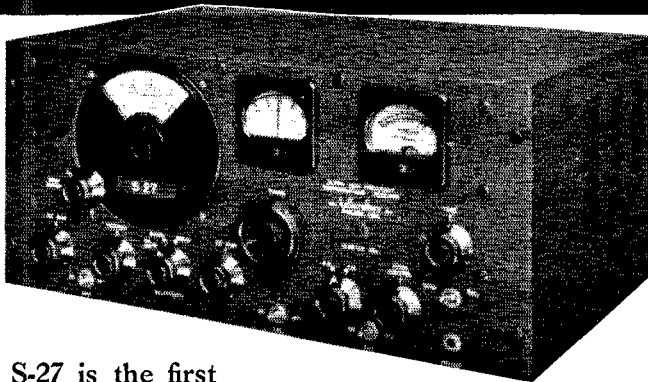

Model S-27 is the first general-coverage U.H.F. communications receiver to incorporate Frequency Modulation reception. Covers 3 bands: 27 to 46mc; 45 to 84mc; 81 to 145mc. Switch changing from FM to AM reception. Acorn tubes in R. F. and newly developed converter system. High gain 1853 tubes in I. F. stages. Beam power tubes and 6C8G phase inverter in A. F. Amplifier. Limiter tube provides full limiter action on signals of approximately 5 to 10 microvolts in F.M. operation. 955 plate-tuned oscillator. I. F. selectivity automatically sharpened to receive amplitude modulated U. H. F. signals or broadened for wide band frequency modulated signals. Image ratio much better than normally found in U. H. F. receivers. Front panel controls: R. F. gain control. Band switch. Antenna trimmer. I. F. selectivity (air tuned iron core) control. Volume control. Pitch control. Tone control. S-meter adjustment (meter calibrated in S and DB units). AVC switch. Beat oscillator switch. Automatic noise limiter switch. Amplitude/Frequency Modulation switch. Send-receive switch. Phone jack.

the hallicrafters inc.
2615 SOUTH INDIANA AVE., CHICAGO, U. S. A.

WORLD'S LARGEST BUILDERS OF AMATEUR COMMUNICATIONS EQUIPMENT

LABORATORY CONSTRUCTION



IN THE **HT-9** **100 WATT TRANSMITTER**

Simplicity, ruggedness and functional design are solidly built into the HT-9 transmitter. It is a 5-frequency phone and CW unit, rated at 100 watts on CW and 75 watts on phone — *carrier output*. Exciter coils for 5 bands can be plugged in, pretuned, and left in the transmitter. Antenna connections are to an adjustable tapped coupling coil wound around the final tank coil. Keying is done in the oscillator to provide break-in operation. The signal is clean and free from chirps and clicks. High level modulation of the plate and screen of the 814 gives 100% modulation with very low distortion. Frequency response is flat within 3db. from 100 to 7000 cycles. Carrier hum is at least 40db. below 100% modulation.

Panel controls: Audio Gain with on-off switch for audio section; P.A. Plate tuning. Meters: P.A. Plate; P.A. Grid; Mod. Plate-exciter plate; P.A. Plate tuning scale. Switches: Filaments; Plate; Transmit-standby; Meter switch; Band switch; Phone-CW switch.

HT-9 sells for \$199.50, less only coils and crystals. Available from your Distributor on Time Payments if you wish.

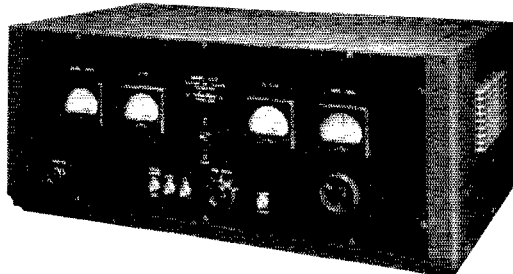

the **hallicrafters** inc.
CHICAGO, U. S. A.

WORLD'S LARGEST BUILDERS OF AMATEUR COMMUNICATIONS EQUIPMENT

APRIL 1940

VOLUME XXIV

NUMBER 4



STAFF

Editorial

KENNETH B. WARNER, W1EH
Editor and Business Manager

CLARK C. RODIMON, W1SZ
Managing Editor

GEORGE GRAMMER, W1DF
Technical Editor

DONALD H. MIX, W1TS
BYRON GOODMAN, W1JPE
Assistant Technical Editors

EDW. P. TILTON, W1HDQ
Contributing Editor, U.H.F.

VERNON CHAMBERS, W1JEQ
Technical Information Service

JAMES J. LAMB, W1AL
Research Engineer, A.R.R.L.

Advertising

F. CHEYNEY BEEBLEY, W1GS
Advertising Manager

CHARLES BRUNELLE
Asst. Advertising Manager

Circulation

DAVID H. HOUGHTON
Circulation Manager

RALPH T. BEAUDIN, W1BAW
Asst. Circulation Manager



OFFICES

38 La Salle Road
West Hartford, Connecticut

Subscription rate in United States and Possessions, \$2.50 per year, postpaid; all other countries, \$3.00 per year, postpaid. Single copies, 25 cents. Foreign remittances should be by international postal or express money order or bank draft negotiable in the U. S. and for an equivalent amount in U. S. funds.

Entered as second-class matter May 29, 1919, at the post office at Hartford, Connecticut, under the Act of March 3, 1879. Acceptance for mailing at special rate of postage provided for in section 1103, Act of October 3, 1917, authorized September 8, 1922. Additional entry at Concord, N. H., authorized February 21, 1929, under the Act of February 28, 1925. Additional second-class entries to cover sectional editions authorized March 20, 1935.

Copyright 1940 by the American Radio Relay League, Inc. Title registered at United States Patent Office.

QST

devoted entirely to

AMATEUR RADIO

PUBLISHED MONTHLY, AS ITS OFFICIAL ORGAN, BY THE AMERICAN RADIO RELAY LEAGUE, INC., AT WEST HARTFORD, CONN., U. S. A.; OFFICIAL ORGAN OF THE INTERNATIONAL AMATEUR RADIO UNION



CONTENTS

Editorials	7
Splatter	8
Electronic Keying	Harry Beecher, W2ILE 9
Twister Strikes Georgia	Leland E. Smith, W4AGI 15
A Complete 56-Mc. I.F. System	Byron Goodman, W1JPE 16
The Chile Conference	A. L. Budlong, W1JFN 20
160 to 2 1/2 Meters in One Transmitter	E. P. Tilton, W1HDQ 23
What the League Is Doing	26
New Transmitting Tubes	152TL, 304TL, HY75 27
A Battery Transceiver for 112 Mc.	Vernon Chambers, W1JEQ 28
Improving the Flying Skywire	Dana A. Griffin, W2AOE 32
A Hundred-Dollar Half-Kilowatt	John G. Osborne, W1DWL 34
New England Division Convention	39
Midwest Division Convention	39
Balloon-Supported Antennas	40
A.R.R.L. QSL Bureau	41
A Simplified Exciter Circuit	W. D. MacGeorge, W3GHR 42
WV Schedules	42
It Did Happen Here	Gene Turney, W2APT 43
A 56-Mc. Crystal-Controlled Transceiver	Frank Jacobs, W2BSL 46
Arizona State Convention	49
The Design of Speech Amplifiers	50
Paul E. Millington, W9KSW and Douglas W. Fath, W9UST	50
On the Ultra Highs	E. P. Tilton, W1HDQ 52
Application of Transverse Phase-Shifts to Amplifier Design Problems	J. K. Bach, W4CCE 54
Ham Shacks	W2ELN, W3EIM, W6MQF, W8KSL, W9ZVO 56
Hints and Kinks	
An Inexpensive 50-Foot Antenna Mast — Notes on Gaseous Tubes as Bias Regulators — More on Homemade Feeder Spreaders — Superhet B.F.O. as Code Practice Oscillator — Meter Switching with Toggle Switches	58
I.A.R.U. News	61
New Receiving Tube	6S6GT 62
Silent Keys	62
Correspondence from Members	63
Operating News	64
January O.R.S.-O.P.S. Parties	66
Brass Pounders' League	67
How's DX?	68
DX Century Club	80
Ham-ads	123
QST's Index of Advertisers	126

Section Communications Managers of the A.R.R.L. Communications Department

All appointments in the League's field organization are made by the proper S.C.M., elected by members in each Section listed. Mail your S.C.M. (on the 16th of each month) a postal covering your radio activities for the previous 30 days. Tell him your DX plans for experimenting, results in 'phone and traffic. He is interested, whether you are an A.R.R.L. member or get your QST at the newsstands; he wants a report from every active ham. If interested and qualified for O.R.S., O.P.S. or other appointments he can tell you about them, too.

ATLANTIC DIVISION			
Eastern Pennsylvania Maryland-Delaware-District of Columbia	W3BES	Jerry Mathis	5132 Haverford Ave. 9701 Monroe St. 9309 Spring P.O.
Southern New Jersey Western New York Western Pennsylvania	W3CIZ W3COO W8PLA W8OFO	Hermann E. Hobbs Lester H. Allen Fred Chichester Kendall Speer, Jr.	704 Quinton Ave. Trenton Sonyea Lowber
CENTRAL DIVISION			
Illinois Indiana Kentucky Michigan Ohio Wisconsin	W9RMN W9OCG W9ARU W8DPE W8AQ W9UIT	Leslie M. Dickson Noble Burkhart Darrel A. Downard Harold F. Bird E. H. Gibbs Aldrich C. Krones	Edellyn Farms R. 4, Box 1 116 N. Longworth Ave. R.F.D. 2 405 Broad St. 2702 So. 46th St.
DAKOTA DIVISION			
North Dakota South Dakota Northern Minnesota Southern Minnesota	W9WWL W9VOD W9IGZ W9Y9Q	Anton C. Theodos Dr. A. L. Russell Edwin L. Wicklund Millard L. Bender	Box 444 R.F.D. 3 608 N. Huron Ave.
DELTA DIVISION			
Arkansas Louisiana Mississippi Tennessee	W5ABI W5DWW W5EWD W4DWS	H. E. Vette W. J. Wilkinson, Jr. Jewell W. Cole William Harold Walker	4415 West 12th St. 1523 Laurel St. c/o City of McComb Water Dept. 1901 Cedar Lane
HUDSON DIVISION			
Eastern New York N. Y. C. & Long Island Northern New Jersey	W2LU W2AZV W2GVZ	Robert E. Haight E. L. Baunach Joseph P. Jessup	511 South Holmes St. 102 Central Ave. 131 California St.
MIDWEST DIVISION			
Iowa Kansas Missouri Nebraska	W9PIR W9IFG W9OUD W9DI	L. E. Varnard Melvin D. Kirby Miss Letha Allendorf William J. Bamer	P. O. Box 304 1015 W. 3rd St.
NEW ENGLAND DIVISION			
Connecticut Maine Eastern Massachusetts* Western Massachusetts New Hampshire Rhode Island Vermont	W1CTI W1HIE W1GAG W1GAS W1BFT W1HRC W1KJG	Frederick Ellis, Jr. H. W. Castner Carroll O. Peacor William J. Barrett Carl B. Evans Clayton C. Gordon Clifton G. Parker	19 Merrill Rd. 147 Church 24 Governor Rd. 639 Columbia St. 163 South Main St. 70 Columbia Ave., Gaspee Box 537
NORTHWESTERN DIVISION			
Alaska* Idaho Montana* Oregon Washington	K7GNN W7EMT W7CPT W7DXF W7FCG	James G. Sherry Carl Eichelberger Rex Roberts Harold W. Johnston W. Beale	Chichagof Kuna Route 2 Box 1088 902 N. W. DeSpain R. 4, School Ave.
PACIFIC DIVISION			
Hawaii Nevada Santa Clara Valley East Bay San Francisco Sacramento Valley Philippines San Joaquin Valley	K6ETF W6BIC W6FBW W6TI W6HIS W6MDI KA1GR W6KUT	Francis T. Blatt Edward W. Heim Elbert Amarantes Horace R. Greer Eugene B. Hughes Vincent N. Feldhausen George L. Rickard Edwin A. Andrews	837 16th Ave. 509 Claremont St. 454 Washington St. 414 Fairmount Ave. 627 4th Ave. 113 South Quincy St. Box 849 2921 North Van Ness Blvd.
ROANOKE DIVISION			
North Carolina South Carolina Virginia* West Virginia	W4CVB W4QBE/ANG W4GVO W8OXO	W. J. Wortman Ted Ferguson Frank S. Anderson, Jr. W. D. Hubler	P. O. Box 566 1213 College St. 4703 New Kent Ave. 338 Watson Ave.
ROCKY MOUNTAIN DIVISION			
Colorado Utah-Wyoming	W9EHC W7CLG	Carl C. Drumeller Ernest E. Parshall	819 East Dale St. Salt Creek Electric Plant
SOUTHEASTERN DIVISION			
Alabama Eastern Florida Western Florida Georgia West Indies (Cuba-Isle-of-Pines- Porto Rico-Virgin Islands)	W4DGS W4PEI W4AXP W4AGI CM2OP	James F. Thompson Carl G. Schaal Oscar Cederstrom Leland W. Smith Mario de la Torre	12 Clanton Ave. Vaucoma Apts. Lakeview Hotel Second St. & Bruce Ave. 2010 Pennsylvania Ave. Escobar 110 (Altos)
SOUTHWESTERN DIVISION			
Los Angeles Arizona San Diego	W6MOM W6MM W6JRM	Ralph S. Chick Merson B. Full Howard K. Breedlove	1038 Milwaukee Ave. 617 North Fourth Ave. R. 2, Box 636
WEST GULF DIVISION			
Northern Texas Oklahoma Southern Texas New Mexico	W5DXA W5GFT W5MN W5ENI	Lee Hughes Russell W. Battern Horace E. Biddy Dr. Hilton W. Gillett	125 N. Main St. 431 North Buchanan 1746 Schley Ave.
MARITIME DIVISION			
Maritime	VE1DQ	A. M. Crowell	69 Dublin St.
ONTARIO DIVISION			
Ontario	VE3SG	F. H. B. Saxon	302 Lee Ave.
QUEBEC DIVISION			
Quebec	VE2CO	Lindsey G. Morris	Apt. 6, 4510 Girouard Ave., N.D.G.
VANALTA DIVISION			
Alberta British Columbia	VE4GE VESDD	C. S. Jamieson C. O. I. Sawyer	581 W. Riverside Drive 2634 West 31st Ave.
PRAIRIE DIVISION			
Manitoba Saskatchewan	VE4AAW VE4SY	A. W. Morley Arthur Chesworth	747 McMillan Ave. 1071 4th Ave., N. W.

* Officials appointed to act until the membership of the Section choose permanent S.C.M.s by nomination and election.

LOW Driving Power—

QUICK Band Change—

... MORE POWER in the antenna with less equipment! Important advantages to many an amateur today. That's why we say "Turn to the new G-E beam power tubes." They cut out intermediate stages, eliminate neutralization difficulties, give your rig more flexibility.

GL-813

... The G-E beam tube for high power. It will produce 150 watts cw as a crystal oscillator, 260 watts cw with only 1 watt driving power. An excellent frequency multiplier. Makes quick band change at high power easy. \$28.50 at your G-E dealer's.

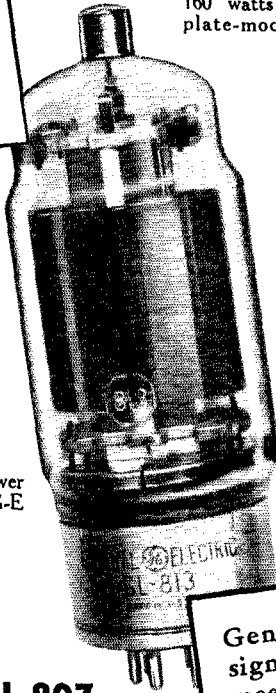

GL-814

... The G-E beam power tube for any medium-power r-f application up to 30 mc. 160 watts cw, 130 watts plate-modulated phone (ICAS) with 1.5 or 3.2 watts driving power respectively. A fb frequency multiplier, too. \$17.50 puts one in your rig.

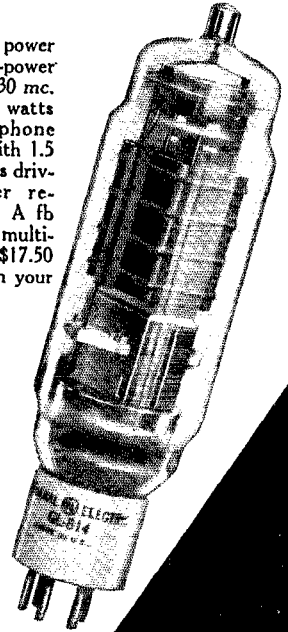

GL-807

... The G-E beam tube for your low-power requirements. Oscillator, amplifier, frequency multiplier or modulator—you can't buy a more versatile performer for \$3.50! Less than half a watt drives two 807's; ICAS cw output: 100 watts!

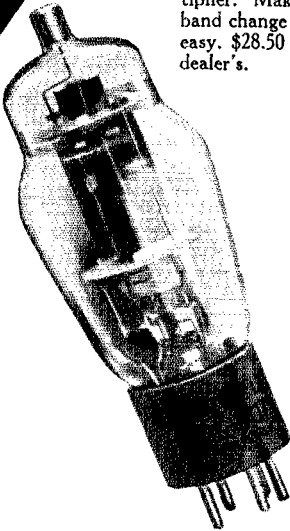

General Electric has designed and built tubes to meet the most exacting requirements on land and sea and in the air for more than 27 years. G.E. on a transmitting tube assures you of long, dependable service at low cost.

Bulletin GEA-3315 lists the complete line of G-E transmitting tubes, together with technical data. Get a copy from your dealer, or write direct to General Electric, Radio and Television Dept., Schenectady, N. Y.

GENERAL ELECTRIC

161-1

THE AMERICAN RADIO RELAY LEAGUE

Directors

President
EUGENE C. WOODRUFF..... W8CMP
234 W. Fairmount Ave., State College, Pa.

Vice-President
GEORGE W. BAILEY..... W1KH
74 Webster Road, Weston, Mass.

Canadian General Manager
ALEX REID..... VE2BE
169 Logan Ave., St. Lambert, P. Q.

Atlantic Division
WALTER BRADLEY MARTIN..... W3QV
Box 612, Roslyn, Pa.

Central Division
R. H. G. MATHEWS..... ex-W9ZN
4534 Dover St., Chicago

Dakota Division
FRED W. YOUNG..... W9MZ
107 Hanover St., Mankato, Minn.

Delta Division
E. RAY ARLEDGE..... W5SI
P.O. Box 286, Pine Bluff, Ark.

Hudson Division
KENNETH T. HILL..... W2AHC
115 Willow St., Douglaston, L. I., N. Y.

Midwest Division
FLOYD E. NORWINE, JR..... W9EFC
7405 Hlawatha Ave., Richmond Heights, Mo.

New England Division
PERCY C. NOBLE..... WIBVR
37 Broad St., Westfield, Mass.

Northwestern Division
RALPH J. GIBBONS..... W7KV
c/o United Air Lines, Portland, Ore.

Pacific Division
J. L. McCARGAR..... W6EY
86 Hamilton Pl., Oakland, Calif.

Ranoke Division
H. L. CAVENESS..... W4DW
State College Station, Raleigh, N. C.

Rocky Mountain Division
GLEN R. GLASSCOCK..... W9FA
2184 So. Corona St., Denver

Southeastern Division
WILLIAM C. SHELTON..... W4ASR
Box 652, Daytona Beach, Fla.

Southwestern Division
CHARLES E. BLALACK..... W6GG
1273 Main St., El Centro, Calif.

West Gulf Division
WILLIAM A. GREEN..... W5BKH
801 Ross St., Abilene, Texas

THE AMERICAN RADIO RELAY LEAGUE, INC., is a non-commercial association of interest in amateur radio communication and experimentation, for the relaying of messages by radio, for the advancement of the radio art and of the public welfare, for the representation of the radio amateur in legislative matters, and for the maintenance of fraternalism and a high standard of conduct.

It is an incorporated association without capital stock, chartered under the laws of Connecticut. Its affairs are governed by a Board of Directors, elected every two years by the general membership. The officers are elected or appointed by the Directors. The League is non-commercial and no one commercially engaged in the manufacture, sale or rental of radio apparatus is eligible to membership on its board.

"Of, by and for the amateur," it numbers within its ranks practically every worth-while amateur in the nation and has a history of glorious achievement as the standard-bearer in amateur affairs.

Inquiries regarding membership are solicited. A bona fide interest in amateur radio is the only essential qualification; ownership of a transmitting station and knowledge of the code are not prerequisite. Correspondence should be addressed to the Secretary.



HIRAM PERCY MAXIM, FIRST PRESIDENT

Officers

President..... EUGENE C. WOODRUFF, W8CMP
State College, Pa.

Vice-President..... GEORGE W. BAILEY, W1KH
Weston, Mass.

Secretary..... KENNETH B. WARNER, W1EH
West Hartford, Connecticut

Treasurer..... ARTHUR A. HEBERT, W1ES
West Hartford, Connecticut

Communications Mgr...... F. EDWARD HANDY, WIBDI
West Hartford, Connecticut

General Counsel..... PAUL M. SEGAL
1026 Woodward Building, Washington, D. C.

Address all general correspondence to the administrative headquarters at West Hartford, Connecticut.

"IT SEEMS TO US—"

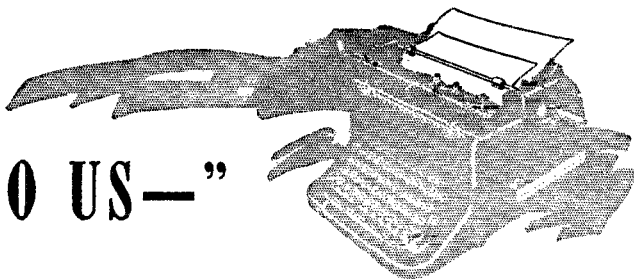

WE HAD luncheon the other day with an amateur who showed us two insurance policies he had taken out. One was on his rotary beam and its tower, covering damage by wind or lightning, and the other covered the fire hazard on his station equipment. They were not expensive. It seems to be a good idea, particularly for the station representing an appreciable investment, so we pass it along.

Speaking of insurance, we have the impression that the average residence fire policy, while of course permitting radio receivers, does not authorize the operation of a transmitting station. Such permission can be had upon request, as an indorsement on the policy, and we recommend to amateurs who own their own homes that they make it a point to obtain such a "rider." Where the circumstances are not already fully known to the agent, it may be necessary to arrange for an inspection by the underwriters organization. The code to-day is a reasonable one, readily complied with, so that if your station doesn't already comply with it, it ought to for safety's sake.

So don't cheat. Don't do as we did years ago, when there was an outlandish code that required huge lead-throughs, huge conductors and huge outdoor switches on both antenna and counterpoise. One of the requirements in those days was that lead-throughs had to protrude at least five inches on each side of the wall. We have some mammoth power-house porcelain tubes that went clear through the house wall, carrying heavy threaded brass rod mounted in sulphur, a favorite insulation of those days. The system would have carried a bolt of lightning but unfortunately the tubes lacked several inches of the necessary length. But were 1MO and 1BHW daunted? Not we — because the tubes would slide in the wall. When the inspector came we showed him first the inside of the station, with the tubes pulled in. When one of us took him around the house to see the outside, the other remained behind to push the tubes out so that they measured a neat six inches on the outboard side. Hi! But because the code to-day is a sensible one, such artifices are highly inadvisable and you'd only be cheating yourself of the necessary protection.

WHAT many of us would like to know is precisely how far away from our own frequency a CQ is worth answering. While the general answer is that "It depends," we could wish that it were lots farther than it generally is.

In the main, there's always a good reason for a crystallized amateur operating habit. It settles down on a basis that experience shows to yield the most results for the effort expended. We suppose it is for this reason that the CQ-er's tuner seems to stick pretty close to his transmitter's frequency — probably it's logical.

But thereby we deprive ourselves of many pleasurable contacts, as anyone can prove for himself by listening to the answers to another station's CQ and observing how many "get left" because they are too far away. We would therefore like to urge once more the covering of the whole band after a CQ, particularly when an acceptable answering station is not immediately picked up.

And we repeat our periodic plea for break-in operation, answering CQs in short bursts with intermittent listening, *shorter* CQs, and CQs that indicate in what part of the band the station is going to listen for replies.

A VERY gratifying token of the bond of interest which exists between the various American countries is to be found in the action of the recent Santiago conference in continuing the right of amateurs to handle messages on behalf of third persons. This policy was originally adopted at the Habana conference with a statement of principles in which it was said that "It is apparent that the community of interest of the peoples of all the Americas would be fostered by encouraging the exchange, by amateur stations, without charge, of friendly messages emanating from our citizens." So well recognized is this principle now that the Santiago conference simplified the language to provide that "The American countries, with the purpose of further improving the close and friendly relations existing between the peoples of America, and when their internal legislation permits, agree that amateur radio stations" may exchange these

messages. As with the Habana language, it is provided that the messages shall be of a character that would not normally be sent by any other service and on which no compensation is paid.

While the Santiago agreements are not effective until July 1st, this traffic provision is the same as in the Habana arrangement which became effective in 1938. It is a practical difficulty that the average amateur has no means of knowing what countries have ratified the agreement and what haven't. And even if he did know which had ratified, he would have no means of knowing whether "their internal legislation permits." In this latter respect he would be dependent upon the amateur of the other country to tell him whether he could handle messages. (Mexico, we remember, re-

gretted at Habana that her domestic laws did not so permit, and it was implied of Argentina; it may be true of other countries.) But our own government is heartily in favor of this arrangement, so far as we are concerned, and it appeals to us that W and K amateurs, after July 1st, may tender traffic of this description to Latin amateur stations and be safe in taking their cues from them. In the meanwhile we should remember that we already have special treaties with Chile and Peru which fully regularize such exchange with those countries.

Outside the Americas no such arrangements exist. It should scarcely be necessary to point out that no such messages should ever be handled by an amateur, particularly at such a time as this, and especially with Europe.

K. B. W.

★ SPLATTER ★

Editors are supposed to gaze into the future, predict trends and provide material to suit the seasons. Material for this issue is of the type to hit the ham touched with spring fever — a far

ery from the weather now present in Concord, N. H., which is the blustering zero variety with snow at car-roof level along the roadsides. But by the time this issue is well circulated we are sure that kite and balloon skywires may appear intriguing; if they don't, there is always that desire to own a transceiver. This issue contains battery jobs for either 2½ or 5 meters.

U.h.f. men and experimenters will be particularly interested in Goodman's windup of the present f.m. series with a wide-band i.f. amplifier.

FEEDBACK

In the circuit diagram of Fig. 4, page 60 of the March issue, the control grid, screen and suppressor of the 89 were shown in incorrect positions. The correct arrangement is shown in the above diagram.

In the circuit diagram of Fig. 2, page 60 of the February issue, R_1 , R_3 and R_4 are the usual grid leaks, while R_2 is the keying resistance.

Diagram on page 17, March issue, shows one side of heater of the 1232 returning to the cathode instead of to ground as is correct.

Our Cover

For a month the Hq. gang has been spending spare moments taking a whack at the electronic key that W2ILE sent up. It has proved to be a most fascinating gadget and a contribution to the art; certainly a worthy addition to any station. And it's no pipe to get the swing of, either. It will take practice, plenty of it, but with mastery the operator will be sending perfect continental.

Like all innovations it arrives in complex form, but work goes on apace at simplification and will be presented as it develops.

On the cover is a profile of Huntoon, W1LVQ, taking his "trick" on the electronic "bug."

~~W~~ **Strays** ~~W~~

Are you a sleep-walker? If you are, take warning from W2HNNH's experience. It seems that he worked one day pulling down iron castings and breaking them up with a sledge hammer. That night his XYL was awakened by a loud crash. HNH had pulled his rack-mounted rig off the table and was just about to break it up with a baseball bat.

The electronic key makes dashes as well as dots, at speeds from 15 to 40 words per minute. Speed is quickly regulated by turning one control.

Electronic Keying

BY HARRY BEECHER,* W2ILE

An Electrical "Bug" Which Makes Both Dots and Dashes

NO DOUBT the desirability of a semi-automatic key which would make dashes as well as dots has occurred to many amateurs. No one, however, seems to have designed a key of this sort which is practicable for home construction.¹ Realizing the need for such a key, the author some time ago started work on one which would do the job electronically. As might be expected, the early attempts were crude and in one way or another did not fulfill all the specifications that such a device as this should. Since the work was done in spare time the whole works would be shelved, sometimes for months, until a new idea would suggest itself.

The final circuits presented here are in our estimation foolproof and simple. The parts necessary are readily obtainable, and cost about what one would have to spend for a good speech amplifier. The heart of the key is the argon gas-filled triode Type 885, used in a modified sweep-oscillator circuit, with the rest of the apparatus to adapt it to practical electronic keying applications. In the hands of a good operator the device is capable of sending perfect code at speeds from 15 to 40 words per minute. Three convenient controls — overall speed, dash length, and dot length — permit the operator to set the characteristic best to suit his style of sending. With the key thrown to either the dot or dash position a characteristic begins immediately, and a train of characters will follow if the key is held down; however, if the key

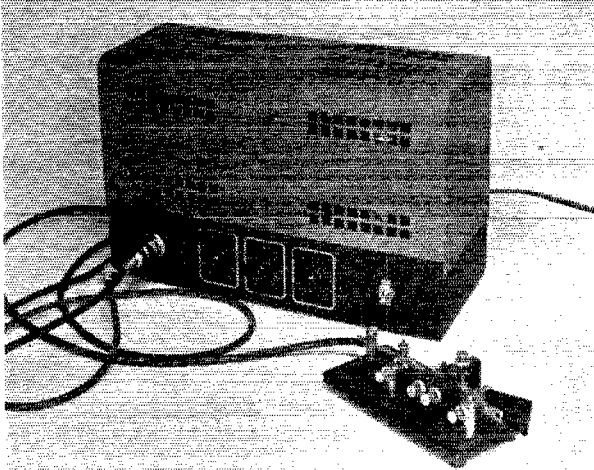

is released the action is immediately to cut off the characteristic. Pressing the key always starts a new characteristic. At any given speed the space between dashes in a train of dashes is exactly the same as the space between dots in a train of dots; this is set automatically by electronic means. All characters in a train are the same length.

How It Works

In the following explanation of the electronic key, it is necessary to keep in mind the characteristics of the 885 gas triode, which is a miniature thyratron. Like all thyratrons, the grid is effective as a control element only in determining the plate voltage at which the gas in the tube will ionize; once ionization occurs the grid loses control and the plate-cathode circuit behaves as though there were no grid in the tube. As is the case with other gas tubes, a certain minimum voltage is necessary to maintain ionization; at a critical voltage known as the extinction potential the ionization ceases and there is no current flow in the cathode-plate circuit. The extinction potential is a constant for the type of tube (in the case of the 885 it is about 15 volts) and is independent of the grid bias. The breakdown or starting potential, however, is determined directly by the grid bias and can be varied over a range of 30 to 300 volts, approximately. The effective plate-cathode resistance is quite low when the tube is ionized, and is extremely high when there is no gaseous conduction; we have, therefore, a tube in which the transition from no plate current to high plate current is extremely abrupt. This is an ideal characteristic for keying applications.

* 56 South Main St., Milltown, N. J.

¹ There is a mechanical key of this type available commercially, but mechanical construction of the necessary elaborateness is well beyond the capabilities of the average amateur. — Ed.

Only those who have had an opportunity to try a key which makes dashes as well as dots can appreciate what a fascinating gadget it is to operate. And what a c.w. Utopia it would be if some of those "speed" artists had to make dashes of length commensurate to the dots which rip-snoort from a flying bug vibrator! This key will not only force your fist into closer resemblance to perfect Continental; it will enable you to send faster, more easily, and improve your timing on regular keys. Here's how it works and how to make it.

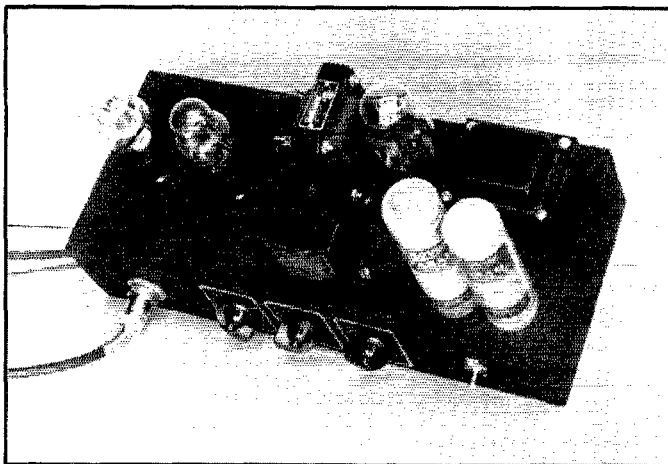

The top of chassis view shows that construction is quite simple. The self-contained power supply occupies the right-hand portion of the chassis.

The operation is best explained in a series of steps. Fig. 1 shows the fundamental circuit. At the instant the "B" voltage is applied, practically the whole voltage appears across R_6R_7 , since condenser C is in effect a short-circuit for the momentary surge. Thus the voltage at the same instant across the plate and cathode of the 885 is nearly zero, since the tube is effectively in parallel with C . After the initial application of voltage, the voltage across C rises as the condenser becomes charged, and if the 885 was not connected across C its terminal voltage would eventually reach the same value as the applied "B" voltage. The time required for this to occur depends upon the time constant of the circuit, which is the product of C times the sum of R_6R_7 .

However, as the voltage across C rises it will at some instant reach the ionization or breakdown potential of the tube. When this happens the plate-cathode resistance suddenly becomes very low, effectively short-circuiting C and thereby discharging it. With R_6R_7 sufficiently high in resistance to prevent instant recharge, the voltage across C will drop below the value sufficient to maintain ionization in the tube, plate current will cease, and C will start to recharge as before. The cycle will repeat indefinitely just so long as "B" voltage is continuously applied. While C is charging, the relay is open and the external keyed circuit is closed; when C discharges, the relay closes and the external keyed circuit is open. Thus the charge period represents a "mark," or character (dot or dash), and the discharge period a "space." The length of a space is determined by the resistance (and inductance) in the relay and tube circuit, and the length of a dot or dash by the resistance at R_6R_7 , assuming a fixed value of C .

Although the train of characters can be started by applying "B" voltage as described above, this method would not be satisfactory in practice be-

cause the back-contact relay would keep the external circuit closed continuously when the key was open, since no current would be flowing in the relay circuit. This can be overcome by using the circuit of Fig. 2, in which an auxiliary relay switches the condenser as shown. With the key open, C is grounded and a continuous non-oscillating current flows through R_6 , R_7 , Ry_1 and the 885, keeping Ry_1 closed and the keyed circuit open. When the key is closed, Ry_2 connects C to the junction of R_6 and Ry_1 , which momentarily short-circuits the voltage between this point and ground, causing the tube to de-ionize, and cutting off the current through Ry_1 . This closes the keyed circuit and starts a character. C then charges and the oscillations continue as previously described. On opening the key, condenser C is discharged to ground and a continuous current again flows through the relay and tube circuit.

The operation is shown graphically in Fig. 3, where the effective 885 plate voltage, which is also the voltage across C (less the drops through the relay and cathode resistor, when present) is plotted against time. At the instant of closing the key the completely-discharged condenser short-circuits the 885 plate voltage. After the voltage has reached the breakdown potential the condenser discharges through the tube, making a space. The voltage does not go completely to zero, but to the extinction potential, and as a result the first character, dot or dash, is longer than the succeeding ones. This can be overcome by the arrangement shown in Fig. 4, where C is not grounded when the key is open, but is returned, through a back contact on Ry_2 , to a point on the "B" voltage divider which keeps it charged to a minimum potential equal to the extinction potential of the tube.² R_{L1} is simply for

² More accurately, the voltage at which the relay drops out. This may be slightly higher than the extinction potential because as the condenser discharges the current decays,

the purpose of preventing sparking at the relay contacts, and C_1 to provide a reservoir from which C can be charged quickly.

As previously mentioned, the discharge time depends upon the time constant of the circuit comprising C , R_{y1} , and the tube. This time is fixed regardless of the resistance used at R_6R_7 , hence the time occupied by a "space" is constant. On the other hand, the charge time is a function of R_6R_7 , and the time occupied by a "mark" or character can be varied by varying R_7 . There are some other considerations, however. The steady plate current of the 885 is limited to 2 or 3 milliamperes by the tube ratings, so that a sensitive relay must be used; the available ones work in the range of 1 to 2 milliamperes. On the basis of a steady current of about 1.5 ma. the total resistance at R_6R_7 cannot be too high, or the "B" voltage will be insufficient to force the requisite plate current to flow. On the other hand, the resistance of R_6R_7 cannot be too low or condenser C will be unable to discharge completely enough to reach the extinction potential of the tube, and the sawtooth oscillations will not occur. This will be especially true if additional resistance is introduced in the tube-relay circuit to lengthen out the discharge time and thus the time of a space; there is, therefore, a limit to the amount of resistance that can be used for this purpose. In practice, it will be found that a circuit of the type shown in Fig. 4 will make satisfactory dashes, but that R_6R_7 cannot be reduced to a low-enough value to make dots, while still maintaining oscillation.

Since nothing much can be done about the "space" time, what is needed is an automatic means to lower the resistance of R_6R_7 during charge and raise it during discharge so that the charge time will be shortened but the discharge will be unaffected. The circuit which accomplishes this is shown in Fig. 5. A triode, with its plate-cathode circuit in series with the relay and the 885, replaces R_6 . Its grid is connected to the previously unused "make" contact on the relay so that when current is flowing through the relay coil the grid is connected to ground. This biases the grid negatively by the voltage drop across the tube and relay; the value of this grid bias is sufficient to cut off the plate current of the 37 so that its plate-cathode resistance is practically infinite. A path for the continuous current is provided by R_{14} , which has high-enough resistance to prevent interference with the discharge of condenser C , but low enough to pass the current necessary to keep the relay closed while the key is open. On closing the key, C is connected in the circuit and

and may reach the drop-out value for the relay before conduction actually ceases. Although for simplicity the charge and discharge of the condenser are shown in Fig. 3 by straight-line curves, the actual curves should be exponential. The shape does not matter here, although it is an important consideration in sweep circuits.

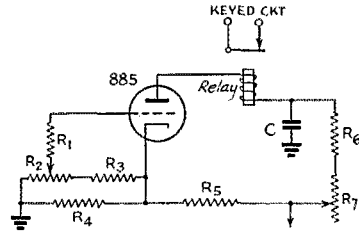

FIG 1

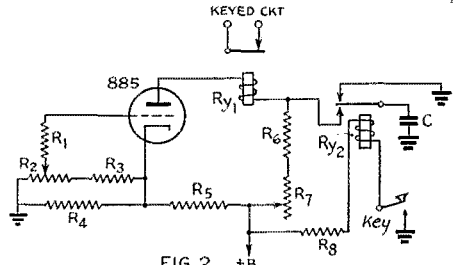

FIG 2

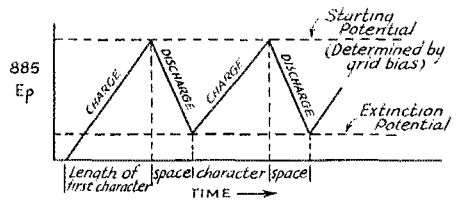

FIG 3

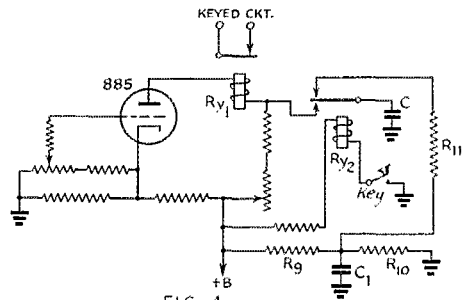

FIG. 4

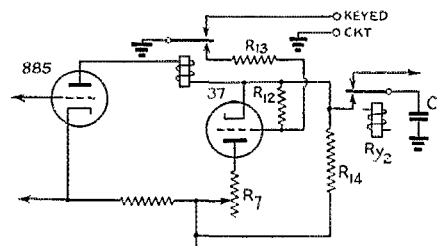

FIG. 5

Ky_1 opens; the grid of the 37 instantaneously returns to the same potential as its cathode, making the plate-cathode resistance low, and C charges quickly through the lowered resistance. As soon as the charge reaches the breakdown potential, Ky_1 closes and the 37 is again biased to cutoff for the period of the discharge.

Resistors R_5 and R_6 constitute a voltage divider to provide grid bias for the 885. Straight cathode bias will not work satisfactorily, since during the charge period no current flows through the tube and hence no bias is developed. R_1 is used to reduce the effects of grid emission, which may cause erratic operation if the tube is used continuously for a period of several hours. This resistor causes a slight decrease in plate current under oscillation conditions, but seems to have no other effect on the operation.

R_2 is the overall speed control, with R_3 providing a fixed minimum bias so that a "band-spread" effect is obtained with R_2 . Since the grid bias affects only the starting or breakdown potential of the tube, and not the extinction potential, the effect of a change in grid bias is to change the "roof" height, or the difference between the breakdown and extinction potentials. With low grid bias C has to charge only to a relatively low potential to reach breakdown, so that the time of the character is shortened. Likewise, the discharge period is shortened in the same ratio, since the difference between the breakdown and extinction potentials is small. Conversely, high grid bias makes both the charge and discharge time longer. R_2 is, therefore, a convenient overall speed control, and may be adjusted independently of R_7 , which regulates the length of a character with respect to the length of a space.

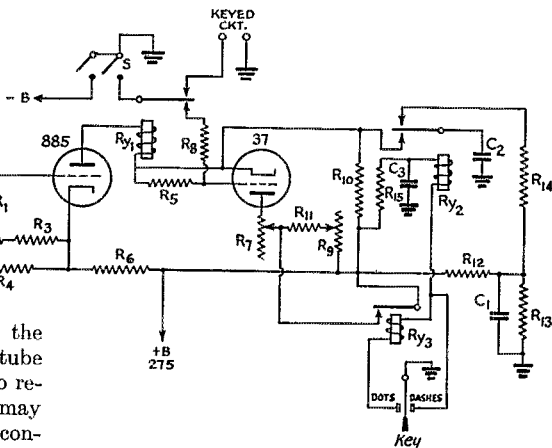
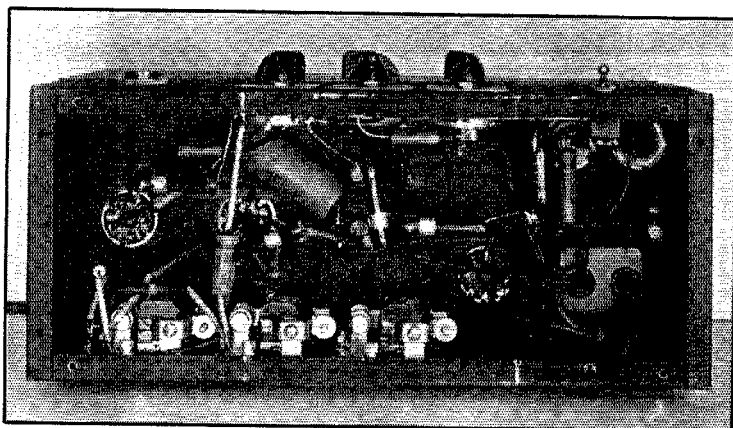

Fig. 6 — Circuit diagram of the electronic key shown in the photographs.

- C_1 — 16- μ fd. 450-volt electrolytic.
- C_2 — 1- μ fd. 400-volt paper.
- C_3 — 0.004- μ fd. paper.
- R_1 — 40,000 ohms, 1-watt.
- R_2, R_7 — 20,000-ohm wire-wound potentiometer (Yaxley A-20MP).
- R_3, R_{11} — 30,000 ohms, 1-watt.
- R_4 — 1000 ohms, 10-watt.
- R_5 — 5 megohms, $\frac{1}{2}$ -watt.
- R_6 — 12,000 ohms, 20-watt.
- R_8 — 2500 ohms, 1-watt.
- R_9 — 250,000-ohm potentiometer (Yaxley Y-250MP).
- R_{10} — 150,000 ohms, 1-watt.
- R_{12} — 25,000 ohms, 10-watt.
- R_{13} — 1500 ohms, 1-watt.
- R_{14} — 100 ohms, 1-watt.
- R_{15} — 500,000 ohms, 1-watt.
- Ry_1 — Sensitive relay (operates on 1.7 ma.). (Ward Leonard 507-543.)
- Ry_2, Ry_3 — Sensitive relay (0.65 ma.). (Ward Leonard 507-545.)
- S — D.p.s.t. toggle switch.

Practical Circuits

All that remains to be done is to include a switching method by which the resistance of R_7 can be changed to give either dots or dashes.



All the wiring is below-chassis. Parts are few and inexpensive, except for the three relays along the lower chassis edge.

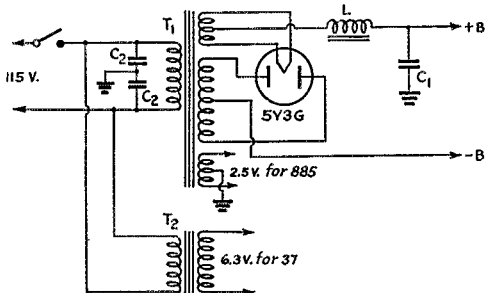

Fig. 7—Power supply wiring diagram for the unit of Fig. 6.

C_1 —16- μ fd. 450-volt electrolytic.

C_2 —0.02- μ fd. 600-volt paper.

L —10 henrys, 65-ma. (Stancor C-1708).

T_1 —650 volts c.t., 40 ma.; with 5- and 2.5-volt windings (Stancor P-6001).

T_2 —6.3-volt filament transformer (Stancor P-6134).

The practical circuit for the purpose is shown in Fig. 6. When the dash switch is closed the total charging time of C_2 is determined by the combination of R_7 , R_9 , R_{10} , R_{11} , and the plate resistance of the 37. Closing the dot switch actuates relays Ry_2 and Ry_3 simultaneously; R_{11} and R_9 are shorted, thereby allowing condenser C_2 to charge in a relatively short time and discharge in about the same period to form a theoretically perfect dot.

The power supply circuit is given in Fig. 7. To prevent the possibility of cathode leakage in the 37, the filament voltage for this tube is taken from a source separate from that of the 885. The center tap on the winding is not grounded.

The arrangement shown in Fig. 8 is essentially the same as that of Fig. 1, except that 6-volt a.c. relays are used at Ry_2 and Ry_3 for sake of economy. An extra pair of contacts on Ry_3 shorts R_9 and R_{11} in the dot position.

The following precautions are necessary if radiation of transients is to be eliminated: Use a metal chassis with a bottom cover, mount the relays on inside, and if a dust cover is not employed place a shield over the 885 tube, as the tube radiates a slight hash when the gas ignites. Use shielded two-wire microphone cable for the lead to the key, with the shield connected to the frame of the key and chassis. A good direct ground is helpful. If interference is radiated into the 115-volt line during keying with the a.c. relay model, add a choke (100 turns of No. 22 d.c.c. on a wooden dowel) in each leg of the primary leads to the transformer supplying the relays, with a pair of 0.02- μ fd. condensers across the line. Use of a commercial line filter with chokes incorporated is also to be recommended. A test to determine if interference is caused by sparking at key contacts is to eliminate the rest of the circuits by removing the 5Y3G rectifier. A shielded cable from the unit to the transmitter can also be used to prevent radiation of 885 ignition hash as well as b.c.l. interference from the transmitter.

The mechanical construction should present no difficulties. Relays should be mounted so that during operation the arm is not opposed by gravity. The 110-volt switch is mounted on the dot length control as it is least used of the three. The switching arrangement is an ordinary bug with the bar connecting the dash and dot terminals removed and the proper wires installed. The dot contact is, of course, rendered non-vibrating. The constructor can also use a simple home-made arrangement similar to a "side-swiper" key. Very close adjustment of the bug contacts can be tolerated with the electronic key.

The constants of the circuits have been carefully chosen and each represents an optimum value; some are critical and others not critical at all. Large changes in line voltage have no undesirable effects, and if good material is used in construction the only parts requiring replacement are tubes. Filament voltages should be applied 30 seconds before the high voltage. The toggle switch has the purpose of breaking the relay contacts when the high voltage is off, and conserving power and tube life during long standby periods.

Relay Adjustment

To obtain satisfactory operation from the key, the relays must be adjusted correctly. Two fundamental rules in making adjustments for fast operation are: Set the contacts as closely as possible, and use just enough current to kick them over firmly. In practice the screws can be set so that a piece of typing paper can just be wedged between the contacts. Since little or no sparking occurs at the contacts of relays Ry_2 or Ry_3 , close spacing is permissible. In adjusting these relays simply set the outside screw (drop-out contact screw) to the proper spacing; factory settings of springs and drop-in screw should be left as is. As a check on these adjustments the power supply with its filter condenser, choke, bleeders and switches can be temporarily assembled. Relays can be connected in series arrangement through R_{15} , and a buzzer, code oscil-

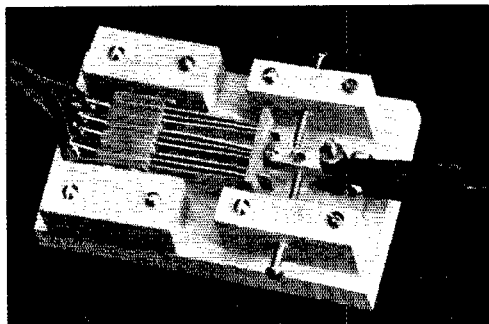

This "key" can be made from a jack-switch in a few minutes, eliminates the need for two relays in the electronic key.

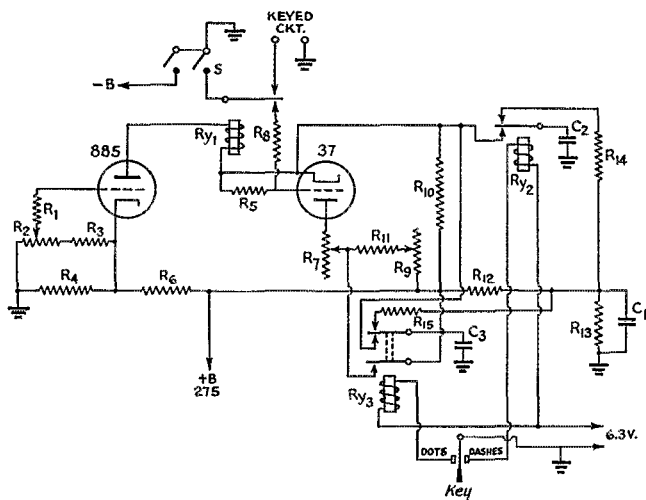

Fig. 8 — Circuit using a.c. relays for dot and dash controls. Values are the same as in Fig. 6 with the following exceptions:
 C₂ — 1- μ f. 400-volt paper.
 R₁₅ — 100 ohms, 1-watt.
 Ry₂, Ry₃ — 6-volt a.c. relay, d.p.d.t. (Ward Leonard 507-505).

lator, or small transmitter connected to the arm of the relay and to the drop-in contact. The operation on "make" should be fast (there should be no delay in starting the action of the buzzer or code oscillator) and at the same time there should be no drag, or tendency for the oscillator to hold longer than the time the key is held closed. A simple test for instantaneous relay action is to give a short sharp blow with the finger nail. If either relay has a tendency to drag, tighten the spring tension. If the relay does not seem to respond immediately, reduce tension and/or reduce contact spacing. In judging tension of actuated relays I use a wooden dowel with an ordinary toothpick held on one end with a rubber band to get the "feel" of the tension. For instance, in the test set-up described above, with the key down and buzzer or oscillator running, the contacts of the relay should be broken when the toothpick bends approximately $\frac{1}{8}$ inch. Actually the setting is not very critical and the value of tension can be varied quite widely with no noticeable change in the operation of the relays. A.c. relays used in the model in Fig. 8 will not require adjustment other than decreasing the spacing between contacts. The spring tension will require tightening if any drag is observed. The a.c. relays can also be actuated with two No. 6 dry cells, if desired.

The idea behind adjustment of Ry₁ is to adjust so that the current flowing through the relay during key-up positions holds the contact arm firmly in the drop-in position, at the same time leaving sufficient contact spacing to provide for sparking at the contacts. Sparking in conven-

tional center-tap or cathode keying can be eliminated to a large degree by the use of a cathode resistor with by-passing done from cathode to ground and no by-pass across the relay contacts.

In ordinary buffer or oscillator circuits using the cathode resistor, spacing equal to the thickness of a sheet of typing paper should be satisfactory. With higher inputs, or where considerable sparking is encountered, the spacing may be doubled. A vacuum-tube keying system would be ideal in eliminating arcing. Actual adjustments can be made by actuating the relay from the high voltage of the power supply in series with R₁₀. The tension of the spring should be left as is, and the sensitivity

will have to be decreased slightly by screwing the drop-in contact screw in, pushing the arm farther from the core. Two turns is sufficient for first trial. It is important that the current flowing through Ry₁ during key-up positions should not hold the arm too firmly, since this may cause a slight delay in starting a character. If the arm is not held firmly enough there will be a drag in breaking a train, or the relay will chatter. With this random setting of the drop-in side, the spacing between the drop-out contacts can be set. With the external oscillator connected to the relay arm and drop-out contact, current flowing through the relay winding will hold the arm against the drop-in contact screw. The contacts may be broken by the toothpick method; when holding the arms against the drop-out contact screw the magnetic attraction should be sufficient to bend the end of the toothpick about $\frac{1}{16}$ or $\frac{3}{32}$ inch. If the attraction is too strong, unscrew the drop-out screw and tighten the drop-in. After checking spacing, recheck the magnetic pull. Fine adjustment can be obtained by a slight change in spring tension, but the spring should not be loosened too much or the spring will not throw the arm rapidly into the dash position. When the key is assembled the tension of the actuated relay can be rechecked under operating conditions. With current flowing through the relay coil, hold the arm open (for this test remove the 37 from its socket and with the external oscillator or buzzer connected to the output terminals of the device the circuit should be open). Pushing the contact arm against the drop-out terminal should require a force equal to that described. While making these adjustments connect a red 110-volt bulb in parallel with the power transformer primary to remind you to turn off power before touching the relay. Once made, the settings can be locked into permanent position with

(Continued on page 110)

Twister Strikes Georgia

BY LELAND W. SMITH,* W4AGI

W4GHU, base station for amateur radio emergency communication following tornado at Albany, Georgia. John Cripps, station licensee, is at the mike. Over a thousand messages were handled on 160-meter 'phone.



NOTHING can be so devastating and death-dealing as a sudden tornado swooping down upon a community of unsuspecting humans. That is just what happened in the little town of Albany, Georgia last February 10th at about 4:30 in the morning. The tornado, according to those who were awakened by its approach, sounded like "a thousand freight trains setting a

scarcely a soul in the downtown district at the early hour in the morning when the cyclone came. Had it been a few hours later, hundreds of persons might have been added to the casualty list.

Only a few minutes after the tornado struck, Johnny Cripps, W4GHU, was on the job and began portable operation on 1.7-Mc. 'phone. With the aid of the other members of the Albany Radio Club — W4BIW, W4ESA, W4DIA, W4GLB, W4GIN and W4FID — almost constant communication was maintained with stations outside the disaster area from early morning of February 10th through Tuesday, the 13th. With power lines down and telegraph and telephone service temporarily paralyzed, W4GHU provided the town's only source of rapid communication until regular facilities could be re-established. But with the unprecedented load of traffic inflicted upon the commercial communication channels, even when the latter were restored W4GHU and the other stations operating portable at Albany added to a noteworthy achievement in the field of emergency communication and service.



W4ARX operated from the heart of the disaster area in tornado-stricken Albany, Georgia. On the job are John Fleming, W. A. Graves and Hood Coker, W4GIN (at the mike).

The operation on 1.7-Mc. 'phone by W4GHU, was soon followed by W4ATO, John C. Davis, who routed considerable traffic on 3.9-Mc. 'phone. Later in the day, Keith Mathis, W4ARX, of Montezuma, Georgia, arrived in Albany, bringing with him a complete portable station powered by a gasoline-driven a.c. supply. By setting up in the very heart of the devastated

runaway pace." Like the Gainesville tornado of four years ago, it struck the business district hardest, destroying some eighty-five per cent of that section. Fortunately, however, there was

*2010 Pennsylvania Ave., Augusta, Ga.

(Continued on page 94)

◆
Wreckage of business house in downtown Albany, Georgia. Almost the entire business district was demolished when the twister struck.
◆



A Complete 56-Mc. I.F. System

An Amplifier for Use with Either F.M. or A.M.

BY BYRON GOODMAN,* WIJPE

WHEN we first started to fool around with amateur f.m. equipment, we had hoped that we might make it so inexpensive and simple that anyone with the inclination — and not much more — could get started in this very fascinating field of communication. However, we have had to change our viewpoint slightly. Although the transmitter¹ and a suitable converter² can be made quite simply, there doesn't seem to be any way, at the present time, greatly to reduce the number of tubes in the i.f. system of the receiver. But, when we look back at it, exactly the same condition prevailed when crystal-controlled transmitters and single-signal receivers were introduced and, as we analyze the reaction, we see that it wasn't so much the *complication* of the equipment as it was the grasping of new conceptions and the resignation to the fact that we were going to have to use more tubes to realize the advantages of the new systems. Exactly the same situation prevails in f.m. technique at the present time. The i.f. amplifier described on these pages may look like a lot of tubes and condensers and resistors, but that's mainly because the gear was assembled on a small chassis. A glance at the circuit diagram shows that it is no more complicated

than the i.f. system of any good receiver, while the photographs show that the wiring is not so complex as that that has appeared in some of the other compact gear described in *QST*. We should hesitate to recommend to a beginner or to one with little or no knowledge of receiver construction the construction of a similar i.f. amplifier, but then we should just as quickly not recommend to him the construction of a 10-tube crystal-filter superheterodyne. We don't say he couldn't build it (we rather think he could) we just shouldn't like the responsibility. We heartily recommend to the serious but inexperienced-in-construction amateur that he build a converter and work it into an f.m. broadcast receiver i.f. amplifier, as described in a previous article.

On the other hand the experienced amateur with several successful construction jobs to his credit should have no trouble at all with an f.m. i.f. amplifier. Anyone who can build — and align — a regular i.f. amplifier can do the same with one designed for f.m. All that is necessary is a general understanding of how the thing works and some of the pitfalls to be avoided. Fully conscious that it may sound like boasting to the uninitiated but also knowing that others will appreciate it for what it's worth, we might say right here that there wasn't the least bit of trouble encountered in building the unit to be described — it worked right off. But then that isn't so strange — the

* Assistant Technical Editor.

¹ Goodman, "A 112-Mc. F.M. Transmitter," *QST*, Feb., 1940.

² Goodman, "A Practical 112-Mc. Converter," *QST*, March, 1940.

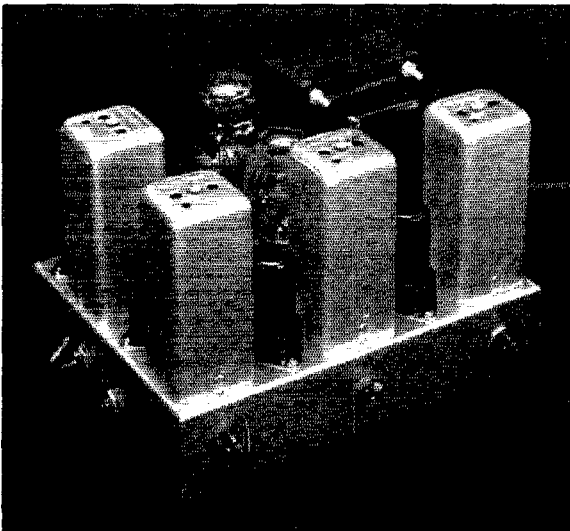

The 5-Mc. f.m./a.m. amplifier is built, complete with power supply, on a 7-inch by 9-inch by 2-inch chassis. Controls on the front, from left to right, are audio volume control, B-plus switch and limiter control. The switch on the side is for changing from f.m. to a.m. and back, and the jack allows a meter to be plugged in to read limiter current.

◆

A view of the top shows the arrangement of parts. Along the rear, from left to right, are the input transformer, first 1852, interstage transformer, second 1852 and interstage transformer. The second row of tubes, from right to left, are the 6SJ7 limiter, 6F6 audio output and VR-150 voltage regulator. The transformer at the right front is the discriminator transformer, the 6H6 detector is in front of it. The tube to the left of the 6H6 is the 6SF5 first audio. Output terminals, converter power supply socket, and 110-volt line cord can be seen.

◆

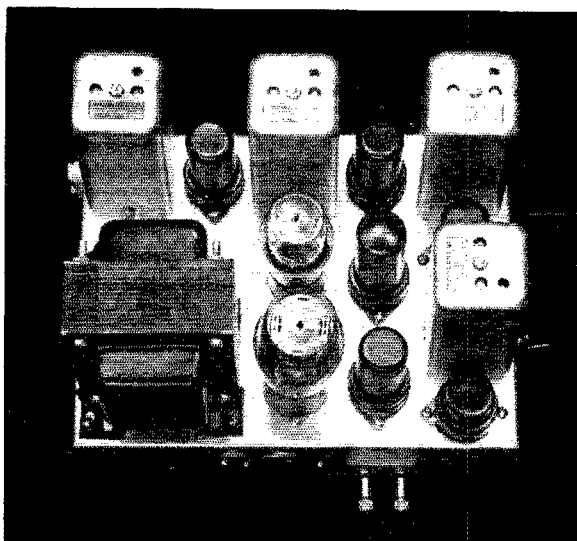

principles involved were all proven ones and, after all, these things are made to work 1-2-3 in commercial production, and amateurs should be able to duplicate the job. So, if you know anything at all about the construction of i.f. amplifiers and the principles involved, don't be afraid to jump in head first and join the gang in this latest and quite fascinating field.

The amplifier to be described is quite similar to the one described in our first story on f.m.,³ with the exception that it is designed to work with either f.m. or a.m. signals. Because a wider-band amplifier is required for f.m. than for a.m., the amplifier is not so selective as it could be on a.m. signals, but this presents no particular difficulty at the present time, with QRM presenting a problem only in rare instances. Used with the converter described (or any converter capable of working into a 5-Mc. amplifier), the system can be used for the reception of a.m. and f.m. signals in the 43-Mc. band, a.m. amateur signals in the 56-Mc. band, and f.m. and stabilized a.m. signals in the 112-Mc. band. If you can get the fellows you work on 112 Mc. who are using modulated oscillators to cut down their modulation (and thus bring their frequency deviation down to a reason-

³ Grammer and Goodman, "F.M. in Amateur Communication," *QST*, Jan., 1940.

We present here the last of a series of constructional articles designed to help the serious experimenter get started on f.m. communication. The amplifier described here, used with a suitable converter, can be used for the reception of either f.m. or a.m. signals.

able range), the system makes a grand receiver for the reception of modulated oscillators, and even the smallest transceiver will sound many times better and save audio power as well.

The Circuit

As can be seen from an examination of Fig. 1, the circuit is no more complex than that of the i.f. of a good communications superhet. Two stages of high-gain amplification using Type 1852 tubes are unconventional only in that resistors are used across the transformer windings, to widen the pass band, and no gain control is included. No control of gain is required because it is always desirable to work the stage following the amplifiers, the limiter, at its highest level. The limiter stage uses a 6SJ7, with provision through R_{15} to control the plate and screen voltage to set the limiting action to meet operating conditions. The use of a grid leak and condenser, R_{16} , and C_7 , and low screen and plate voltage allows the tube to saturate quickly, even at low signal levels, and the tube wipes off any amplitude modulation (including noise) and passes only frequency modulation. For a.m. reception, the audio system is switched, by Sw_1 , on to the grid leak, R_{16} , and the grid and cathode of the tube are used as a diode rectifier to feed the audio system. The jack, J , in series with the grid leak, is used for plugging in a low-range milliammeter so that the limiter current can be read. The limiter current indication is invaluable in aligning the amplifier, and the meter can be used as a tuning meter during operation.

The discriminator circuit is conventional and uses a 6H6 double diode in the regular circuit. Audio from the discriminator (or from the limiter stage, in a.m. reception) is fed through the volume control, R_{25} , into a two-stage audio amplifier

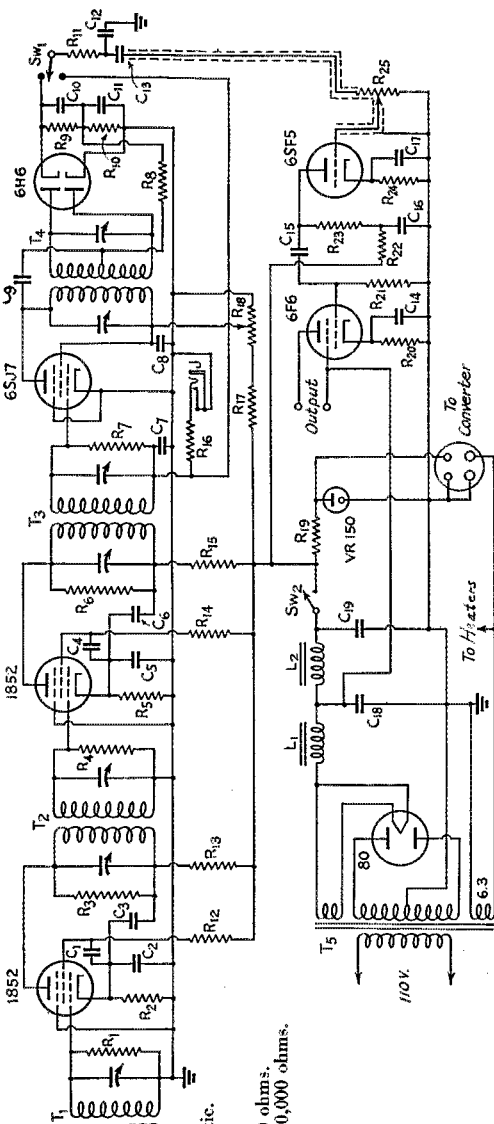

Fig. 1—Wiring diagram of the 5-Mc. f.m./a.m. amplifier. C₁, C₂, C₃, C₄, C₅, C₆, C₈, C₉, C₁₀, C₁₅—0.01- μ fd., 600-volt paper. C₇, C₁₀, C₁₁—100- μ fd. midget mica. C₉—50- μ fd. midget mica. C₁₂—0.001- μ fd. midget mica. C₁₃—0.001- μ fd. midget mica. C₁₄—C₁₇—10- μ fd., 25-volt electrolytic. C₁₈, C₁₉—10- μ fd., 450-volt electrolytic. R₁, R₄—55,000 ohms. R₂—300 ohms. R₃, R₆—50,000 ohms. R₅—300 ohms. R₇—40,000 ohms. R₈, R₁₁, R₂₂—75,000 ohms. R₉, R₁₀, R₁₆—150,000 ohms. R₁₂, R₁₄—60,000 ohms. R₁₃, R₁₈, R₁₉—1,000 ohms. R₁₇—25,000 ohms. R₁₅—10-watt wire-wound (Ohmite). R₁₆—3000-ohm wire-wound potentiometer. R₁₉—5000 ohms, 10-watt wire-wound (Ohmite). R₂₀—500 ohms, 1-watt. R₂₁, R₂₃—250,000 ohms. R₂₄—5000 ohms. R₂₅—500,000-ohm volume control.

- T₁—5-Mc. input transformer, modified. See text (Millen 67503).
- T₂, T₃—5-Mc. interstage transformer (Millen 67503).
- T₄—5-Mc. discriminator transformer (Millen 67504).
- T₅—700-volt, 90-ma. transformer with 6.3- and 5-volt windings. L₁—9-henry, 85-ma. choke (Thordarson T-13C29).
- L₂—10-henry, 65-ma. choke (Thordarson T-13C28).
- SW₁—Selector switch, only two positions used (Xaley 32112J).
- SW₂—On-off switch, s.p.s.t. toggle.
- J—Closed-circuit jack. All condensers are Mallory; all resistors are Centralab of $\frac{1}{2}$ -watt rating unless otherwise noted.

using a 6SF5 and 6F6 output pentode. The resistor R_{11} and the condenser C_{12} in the input of the audio circuit serve as a combined r.f. filter and a compensating network to attenuate the higher audio frequencies. It is necessary to include some sort of compensation when listening to 43-Mc. broadcast stations, since nearly all of them use "pre-distortion" (accented higher frequencies). A 0.01- μ fd paper condenser can be added across the output terminals for further compensation, if it is considered necessary.

The power supply uses a two-section filter, and an outlet socket is provided so that the converter power cable can be plugged in. A VR-150 regulator tube is used to regulate the voltage on the converter, making for additional stability of the converter with changes in line voltage. The addition of the regulator tube adds little in the way of expense to the amplifier and, although not absolutely necessary, is a nice refinement. If desired, it can be left out by simply erasing it from the circuit.

Construction

The amplifier is built on a 7-inch by 9-inch by 2-inch chassis, which seems to be about the optimum size for the equipment used. Reference to the photographs will show the location of the parts on the chassis to be straightforward and follow in logical order. After all of the holes have been drilled for the various components, the sockets and the transformer should be fastened in place on the chassis, leaving off the variable resistors, switches, binding posts, jack and chokes until after most of the wiring has been done.

If the amplifier is to be built to use low-impedance input coupling, the first i.f. transformer must be modified. A link winding is made by first winding a short strip of half-inch wide paper for several turns over the cardboard tubing used as a form in the i.f. transformer. Eleven turns of No. 30 d.s.c. wire are then close-wound flat around the center of the paper ring. Holding the wire in place with a finger, paint the coil with Duco cement has dried, it should be possible to slip the coil off the cardboard form. The plate and B-plus wires are removed from the trimmer condenser in the transformer, and the wires from the plate coil to the trimmer condenser are disconnected.

By unwinding and cutting off a turn or two of paper from the inside of the paper ring, the 11-turn coil can now be slipped easily over the grid coil and fastened in position so that it covers the ground end of the grid coil. A piece of paper should be slipped between the grid coil and the ground lead from the grid coil, to avoid any possibility of this lead shorting against the turns of the coil when the paper ring is slipped in place. The two ends of the link coil are brought out the bottom of the transformer can and later fastened to the input terminals of the set.

It is, of course, possible to use the transformer as is, by running the plate lead of the transformer to the plate of the mixer tube in the converter, but this makes it less convenient to use the converter with sharper i.f. amplifiers, since it would require soldering and unsoldering wires in the converter each time the change was made. Further, the long lead to the mixer tube would increase the chances for stray pickup of signals in the vicinity of 5 Mc.

The usual procedure is followed in wiring the amplifier. One side of the heaters is grounded. By-pass condensers are mounted and grounded as close to the associated tube as possible. The screen by-pass condensers, C_1 , C_4 and C_8 , are mounted across the sockets so that they act as a partial shield between the plate and grid of the tube, as is the custom with single-ended tubes. Tie-points are used wherever they are needed for mounting resistors and condensers. It is recommended that the 1852, 6SJ7 and 6H6 stages be wired first, so that the leads carrying r.f. can be made as short and direct as possible. After that, the rest of the leads can be filled in wherever con-

venient. The wires from the audio volume control, R_{25} , are shielded by running them over in a single piece of flexible copper braid. Whenever convenient, spare pins on sockets were used to support resistors, condensers, etc.

If the parts list is duplicated, it will be found that the two variable resistors mounted on the front of the chassis will not clear the spade bolts projecting down from the i.f. transformers above, and this is easily remedied by cutting off $\frac{1}{8}$ inch of the spade bolts before mounting the transformers in place. Also, in order to make room for the 6SF5 cathode by-pass condenser, C_{17} , some of the binding post strip for the output terminals had to be filed off. A simpler way would be to mount the binding-post strip nearer the bottom of the chassis. The input terminals, a Millen crystal holder, are mounted on the outside of the chassis so that they will clear the limiter control. A handy connector for plugging into this input terminal can be made from an old 5-prong tube base or coil form, by sawing across the base and removing the two correctly-spaced pins and their supporting strip of bakelite.

Aligning the Amplifier

If you have a source of 5-Mc. signal, such as a signal generator, aligning the amplifier is a very easy matter. If you don't already have the source available, a simple e.c.o. can be built with the grid circuit on 2.5 Mc. and the plate on 5 Mc. using an ordinary receiving pentode like the 6K7. Or, if you already have the converter, tune your regular receiver to 5 Mc., couple in the converter and tune in a steady signal, such as a harmonic from

(Continued on page 74)

◆
Underneath the chassis, the parts are arranged for short leads and convenience in wiring. Tie points are used wherever convenient for mounting parts, and spare socket terminals are also used for supports. The choke on the side of the chassis is 12.
◆

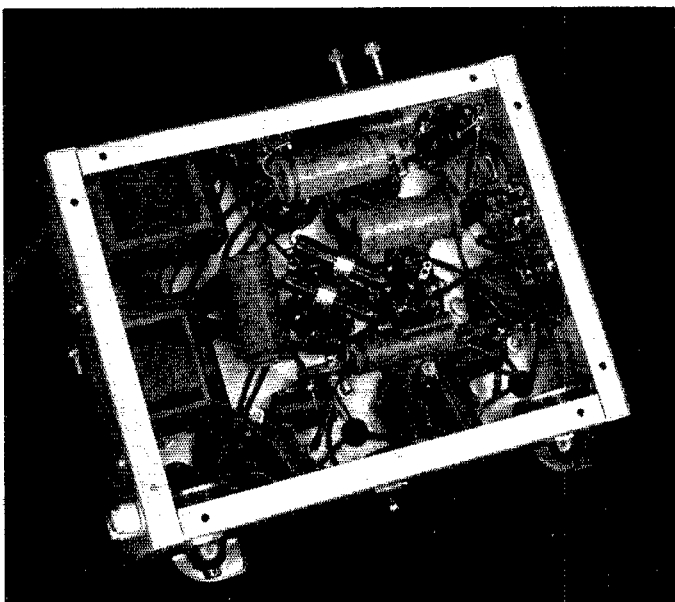

The Chile Conference

Amateur Bands and Privileges Generally Retained Throughout Americas at Second Inter-American Meeting

BY A. L. BUDLONG,* W1JFN

THE Second Inter-American Radio Conference was held during January of this year at Santiago, Chile. It was attended by government delegations from nineteen North and South American countries, as well as by "observers" representing a number of private companies and services, including the A.R.R.L. Whipping through a difficult schedule in the near-record time of nine days, the conference revised the 1937 Habana Arrangement and achieved a new and more generally acceptable set of radio regulations for the American countries.

The conference (a) continued our present bands as exclusively amateur generally throughout the Americas, (b) reiterated the Habana resolution permitting the handling of friendly third-party messages between the amateurs of the two continents, and (c) abandoned for the time being any agreement amongst the Americas on the specification of 'phone sub-band limits.

These were the amateur highlights of a meeting that was notable for the fact that, right up until the opening session, we had very little knowledge of the intentions of the other participants. The A.R.R.L. had, of course, been represented in the preparatory meetings of our own United States government, whose proposals were in all respects in agreement with our desires, but since there was no actual requirement for the advance submission of proposals, few of the other countries had made them.

Such advance information as became available, however, indicated that we might be faced with

* Assistant Secretary, A.R.R.L.

some differences of opinion on amateur matters from our South American neighbors. Colombia, for instance, had proposed that all third-party message handling be prohibited among amateurs, even domestically, and that amateur regulations be standardized, and Cuba indicated her support of both points. There was also a last-minute proposal by Brazil to include all the amateur sections merely as an annex to the new Arrangement; this had the obvious object of thereby rendering these sections ineffective, and is more understandable when it is explained that Brazil had previously expressed dislike for the Habana provisions for the exclusive amateur use of the 3500-4000-kc. band, the third-party message agreement and the 'phone sub-band figures.

Of real interest, however, was the disclosure to me by Chilean amateurs, the day before the opening session, that the Habana 'phone sub-band assignments had apparently never been put into effect in South America and that 'phone there is generally permitted throughout the entire 7-Mc. band as well as in the 300 kc. between 14,000 and 14,300 kc. From the strictly legal standpoint this is quite within their rights, since virtually none of the South American signatories to the Habana documents have as yet ratified them, but we have always hoped that ratification was merely a matter of time and that the Santiago Conference would continue without material alteration the original Habana figures. I now gathered, however, that there was considerable sentiment for the much wider assignments currently being observed there, and this, if true, indicated the

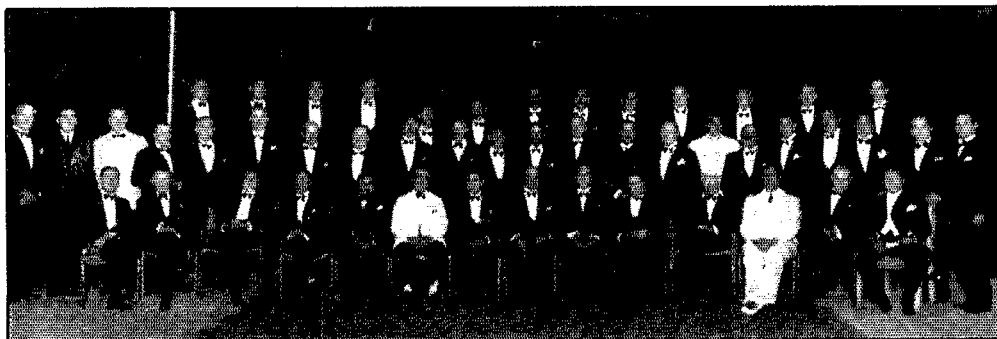

The Second Inter-American Conference assembled at the Santiago Golf Club for a dinner given by the Director-General of the Electrical Service — one of the few social occasions where the stiff program of work permitted everyone to be present.

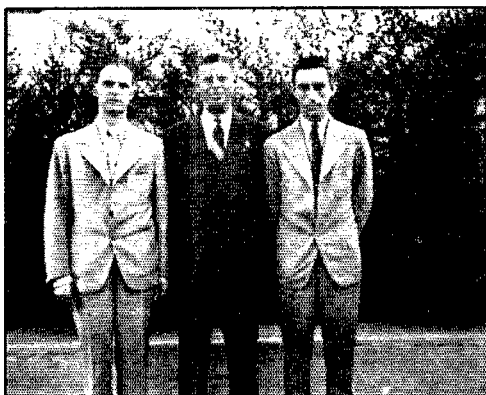

That swell shack at the right is CE3AG's, from which many schedules were kept with W1EH on 20-meter 'phone; at the left, from left to right: Luis M. Desmaras, CE3AG; A. L. Budlong, W1JFN, and J. Bernain, CE3DG, who kept daily c.w. skeds with W1AW during the conference.

likelihood of some real difficulties with respect to this question. Later events indeed proved this to be the case.

However, with this one exception, our amateur matters went through with little or no real difficulty, and the final Santiago document, in its amateur provisions, conforms in all essential particulars to our wishes as put forward by the United States. Primarily, this was due to the capable efforts of those of the U. S. delegation who had our matters in tow. Mr. E. K. Jett, Chief Engineer of the F.C.C., gave flawless handling to our allocations and technical questions, while Mr. Gerald Gross, Chief of the International Division of the Commission, skillfully presented and steered through the third-party message agreement. Too many amateurs do not realize fully the degree of vigorous and wholehearted backing given us United States amateurs by our people at Washington, but it is very apparent indeed at these conferences. It would be a sad day for amateur radio in this country should we lose their confidence and support.

Our principal concern was, of course, the basic amateur allocations, and I am happy to report that these were continued without change on an exclusive basis for North and South America with these exceptions: first, in continuing to designate Appendix 4 of the Cairo treaty as a guide for the allocation of frequencies between 30 and 300 Mc. in the Americas, the 112-Mc. assignment was changed to conform to our present U. S. figure of 112-116 Mc.; and second, there are two minor modifications affecting South America only: In the 1.7-Mc. allocation, the South Americas specify their band as 1715-2000 kc., rather than our own 1750-2050 assignment which is continued for North America (although the change from 1715-2000 has not yet been made), and they further designate the 28-30-Mc. band as shared between the amateur and experimental services.

The explanation of both these modifications lies in the desire of the South Americans to adhere to the Cairo table in these regions of the allocation table, and has no other significance.

As already mentioned, the third-party message agreement was repeated, with some simplification of language but no change in sense or effect. Because of its importance it is here quoted in full:

"The American countries, with the purpose of further improving the close and friendly relations existing between the peoples of America, and when their internal legislation permits, agree that amateur radio stations in their respective countries and possessions may internationally exchange messages emanating from third parties; provided, however, that such messages shall be of a character that would not normally be sent by any other existing means of electrical communications and on which no compensation may be directly or indirectly paid."

Also continued is the recommendation that the signatory administrations require prior amateur experience before permitting 'phone operation in the 14-Mc. band. A new item (suggested by us) is a recommendation to prohibit amateur stations from being used for any type of broadcasting service.

The Habana document contained a paragraph whose object was to encourage the various administrations to discourage amateur use of the 7- and 14-Mc. bands for "short-distance" communications and, instead, to direct their attention to the advantages of the 1.7- and 3.5-Mc. bands for such work. This had been included at Habana only at South American insistence and was more pointless than dangerous, but it might become troublesome and we wanted it eliminated at Santiago. It was.

The only remaining item is that concerning the 'phone sub-bands, and this turned out to be too tough a nut for the conference to crack. While the discussions on it took place variously over a period of several days, during which Mr. Jett and I engaged in lengthy out-of-hours study and con-

sultation in an endeavor to find some way of continuing reasonable assignments in the new agreement, the story is a brief one: We could secure nothing whatsoever in the way of a compromise between our proposals and the widely divergent ones of the South Americans, and so pushed for and secured elimination of the entire section.

Thus, there is no agreement for the next several years on inter-American 'phone sub-bands, and each country is free to assign 'phone anywhere in any of the bands as it wishes. From a practical standpoint the outcome represents no change, of course, in the present South American situation as it has existed for at least the past two years, and so in that respect we are no worse off than now. On the other hand, there is a definite advantage to us in the United States in that it leaves us free to expand our 'phone assignments or change their location, if we wish.

Although any specification of 'phone sub-bands is left out of the new Arrangement, the conference showed that it is very much aware of the desirability of some uniform plan by writing in the following:

"It is recommended that the organizations of amateurs on the American continent reach an agreement among themselves through their respective Governments to establish and propose at the next Inter-American Conference a continental plan for the sub-division of the bands among the various types of emission."

A solution to the 'phone sub-band problem is thus put squarely up to us, the amateurs of the two continents. The matter is one of considerable



Some of the Santiago gang — Top row, left to right: CE3EX, CE3CK, CE3DG, CE3DW-BE, CE4BA, CE3BZ. Bottom row, left to right: CE3BX, CE3AJ, CE3AG, CE3AD, CE3AM.

importance, too, for we cannot now afford to go to the next conference, in 1943, without a showing that the amateurs of the Americas can tackle this problem and work out a solution. The A.R.R.L. expects to initiate correspondence on this subject with the various South and Central American groups in the near future.

The effective date of the Santiago Arrangement is July 1, 1940, but we do not know how many of the signatories will have ratified it by that time. For that matter, it is not possible at this writing to say with what reservations some of them may have signed; only two members of the U. S. dele-

gation remained for the actual signing, the others of us having left some hours before the final ceremonies to take the last train to connect with our ship at Valparaiso. Information on this will undoubtedly be available shortly.

The United States delegation was headed by the Hon. Henry Norweb (a one-time amateur himself), then U. S. Minister to the Dominican Republic but since appointed the new Ambassador to Peru. The other members were F.C.C. Chief Engineer E. K. Jett; Gerald Gross, Chief of the International Division of the Commission; Rear-Admiral Stanford C. Hooper, representing the Navy; Captain W. T. Guest, of the U.S.A. Signal Corps; Lloyd H. Simson, of the C.A.A.; and Joseph T. Keating, of the State Department. Mr. Norweb, a "career" man, is an expert on Latin- and South-American affairs, and made an ideal chairman. With the exception of Mr. Keating, the other members are old hands at radio conferences. The delegation, as usual, was a most capable one.

The next Inter-American Conference is scheduled to be held in 1943, at Rio de Janeiro.

This story would not be complete without an account of my contacts with Chilean hams, particularly those of Santiago. It is most unfortunate that circumstances made it necessary to leave the day the conference ended and that the sessions themselves were so crowded as to leave little time for visiting, for certainly it is difficult to imagine a

more hospitable group of amateurs anywhere than those I was fortunate to meet in Chile. Everything possible was done to make my stay pleasant, and their chief regret seemed to be -- as was mine! -- that I had so little time for the things they had planned.

First contact was with CE1AO and CE1AR, who drove a hundred-odd miles to meet me during the evening our ship put in at Antofagasta; then, farther down the coast, I had the pleasure of meeting CE1BC during an hour's stay at Chanaral. At Valparaiso, the amateurs of the local club

(Continued on page 39)

160 to 2½ in One Transmitter!

Medium-Power Seven-Band Final and Driver

BY E. P. TILTON,* WHDQ

Not so long ago any transmitter which covered the bands from 1.7 to 14 Mc. merited designation as "all-band." The popularity of 28-Mc. 'phone in recent years has given rise to many designs which do a fairly good job on both 1.7 and 28 Mc., this being a useful combination for many 'phone stations.

With the stabilization requirements adopted December 1, 1938, making multi-stage design mandatory for 56-Mc. work, a rig to qualify as "all-band," should be capable of covering the range from 56 to 1.7 Mc. Yet how many are there which will accomplish this without a major "re-building" whenever the change is made from one end of the spectrum to the other? Here is a job which not only operates correctly on 1.7 Mc. but runs at full ratings on "five" — and goes on even further to provide operation on 112 Mc. as well!

Exciter

Before going on to the story of the final and doubler stages shown it might be well to describe the exciter briefly. Not every exciter provides six-band output, and this one does it without the use of plug-in coils. The present exciter is a development of the original model described in *QST* some time ago,¹ with a five-band plate circuit assembly installed in place of the plug-in coils originally used. This band-switch unit pro-

* Contributing Editor, U.H.F., 329 Central St., Springfield, Mass.

¹ Tilton and Browning, "Look for me on --- Kc.," *QST*, July, 1938.

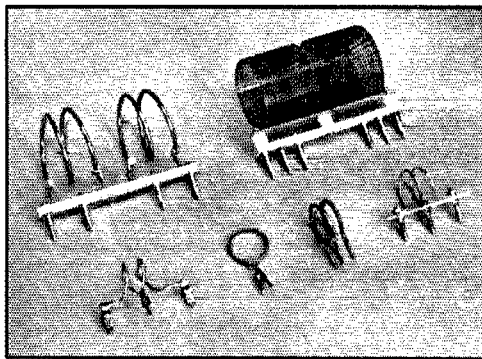

The extremes of tank coils! Upper row, at left, 56-Mc. plate coil; at right, 1.75-Mc. plate coil. Lower row, left to right, 112-Mc. final tank coil, plug-in link on amplifier grid tank, 112-Mc. grid coil, and 112-Mc. driver plate coil. The 112-Mc. grid coil may also be used for 56 Mc. by tuning C₃ for max. capacity.

vides link-coupled output on all bands from 1.7 to 28 Mc.

To provide output on 56 Mc. an additional series-tuned circuit is used. Though the change from the five-band unit to the series-tuned circuit could probably be made with some sort of low-capacity switch, it was thought that the use of separate flexible leads for attachment to the 807 plate cap provided the simplest solution. A double-pole double-throw snap switch connects the link circuit to the band-switch unit or to the series-tuned doubler coil, as shown in Fig. 1

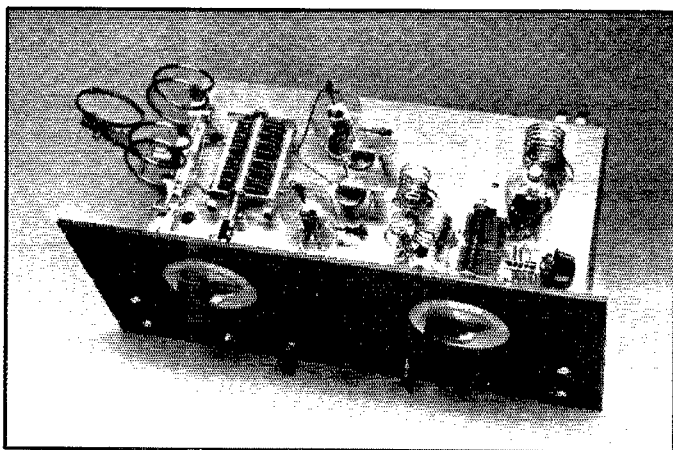

The seven-band push-pull HK54 final, with TZ-40 driver. Coils in place are for 56-Mc. operation, with the TZ-40 doubling from 28 Mc. The tank condenser shown is used alone on the three highest-frequency bands; a larger condenser below the base is paralleled for lower-frequency operation.

A three- or four-band transmitter was once something to be proud of, and even now a six-band rig is out of the ordinary. But here's one which covers seven bands, right through from 1.75 to 112 megacycles! Reasonable care in construction is necessary, but it's not at all tricky.

Due to the relatively high efficiency of the series-tuned circuit, the output obtained from the 807 when doubling to 56 Mc. is practically equal to that obtained on the lower frequencies.

Final Layout

Efficient operation of most low-frequency transmitters on 28 or 56 Mc. is usually well-nigh

impossible, because of the long leads and high minimum capacity present in the average layout. Even when the components are arranged so that the leads are short and the circuit symmetrical, the minimum capacity of most condensers having sufficient capacity for the use of plate modulation on 1.75 Mc. will be high enough to prevent any chance of attaining an efficient tank circuit for 28 Mc., and will eliminate any thought of operating this same final stage on 56 Mc.

This problem is solved neatly and simply by the use of two tuning condensers, one a special u.h.f. job (shown above the base in the top-view photograph) and the other a conventional high-capacity unit which is mounted below the base. At the time that this amplifier was being worked out, no suitable low-minimum-capacity split-stator condenser was available, hence the re-

A below-chassis view, showing the low-frequency tank condenser which is automatically connected in circuit when the appropriate plate coils are plugged in. The other two variable condensers are the grid tank condensers for the final and driver. Filament transformers for both stages are mounted in the chassis.

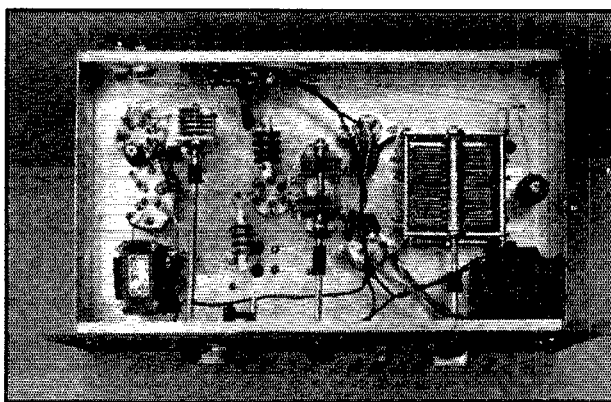

COIL TABLE

	<i>TZ-40 Grid (L₄)</i> ¹	<i>TZ-40 Plate (L₃)</i> ²	<i>HK-54 Grid (L₂)</i> ³	<i>HK-54 Plate (L₁)</i>
112 Mc.		1 turn each side, 1" dia., length 1"	2 turns, No. 8, 1" dia., length ½". Link 2t. flex. wire. No base used	2 turns No. 12, 1" dia. (see photo)
56 Mc.	2 turns No. 12, spaced 1¼", ½" long	3 turns each side, 1" dia., 1¾" long	3 turns each side, 1" dia., No. 12. Base is sawed-off XP-53 6-prong coil form	2 turns each side, 2¼" inside dia., No. 8, ⅞" between turns
28 Mc.	7 turns No. 12, 1¼" dia.; 1½" long	5 turns each side, 1¼" dia., overall length 2¼"	3 turns each side, 1" dia., No. 12. Base is sawed-off XP-53 6-prong coil form	3 turns each side, 2¼" inside dia., No. 8
14 Mc.			17 turns, c.t., No. 20, 1½" total length	6 turns each side, No. 12, ¼" between turns, 2¼" dia.
7 Mc.			36 turns, c.t., No. 22, 1½" total length	11 turns each side, No. 12, ⅝" spacing
3.5 Mc.			80 turns, c.t., No. 28, 1⅞" total length	20 turns each side, No. 16, spaced 1 diameter
1.7 Mc.			90 turns, c.t., No. 26, close-wound	28 turns each side, No. 16, spacing ½ diameter of wire

¹ Bases are round Polystyrene disks, with G.R. plugs with spring portions removed (to fit socket holes).

² Bases are Polystyrene strips ¾" x 3", G.R. plugs.

³ 14-1.7-Mc. Hammarlund XP-53 forms.

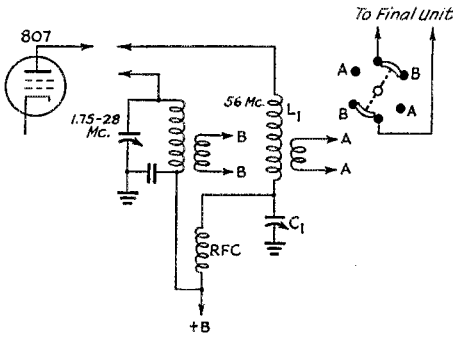

Fig. 1 — Exciter plate circuit for six-band operation. The 1.75- to 28-Mc. tanks are parallel-tuned, using a 5-band switching unit (Browning BL-5PL). The 56-Mc. series tank has a 30- μ fd. variable condenser at C_1 ; L_1 is $10\frac{1}{2}$ turns of No. 12, $\frac{3}{4}$ inch inside diameter, with turns spaced half the wire diameter. Appropriate links are picked up by the switch shown at the right. RFC is a 2.5-mh. choke.

vamped condenser shown. This was originally a Cardwell Type MG-35-NS, a single-section condenser which was converted to split-stator by removing the center stator plate and saving the metal side bars in half. Several suitable low-capacity types are now readily available. Anything of 25 μ fd. per section or less should be satisfactory, provided the plate spacing is adequate. As may be seen from the schematic dia-

gram, the low-capacity unit is in the circuit at all times, while the larger one is connected in by means of an extra set of contact pins and a pair of jumpers which are incorporated in the final plate coils for operation on 14, 7, 3.5, or 1.7 Mc.

When activity on 112 Mc. began to pick up we were seized with the desire to see what could be done on this band if a fairly husky stabilized signal was put to work. The TZ-40 doubler stage, to be described later, provided us with a fair amount of grid drive on 112 Mc., but the problem of getting resonance in the final plate circuit had us stumped for a while. This difficulty was finally overcome by eliminating the use of the regular plug-in jack bar and soldering short pieces of No. 12 tinned wire directly to the stator terminals of the plate tuning condenser, C_1 , and also to the feedthrough lead which carries the high voltage to the center of the final plate coil. A small coil, having for its terminals three of the slip-on clips normally used for plate and grid contacts on the HK-54 and similar tubes, was slipped into place on these contacts and we were quite surprised to find that our final now delivered approximately 100 watts on $2\frac{1}{2}$, with an efficiency of about 50 per cent. Although the grid drive is not sufficient for plate modulation at full ratings, the rig may be run with frequency modulation at inputs up to 275 watts or more without undue strain on the tubes. This qualifies

(Continued on page 98)

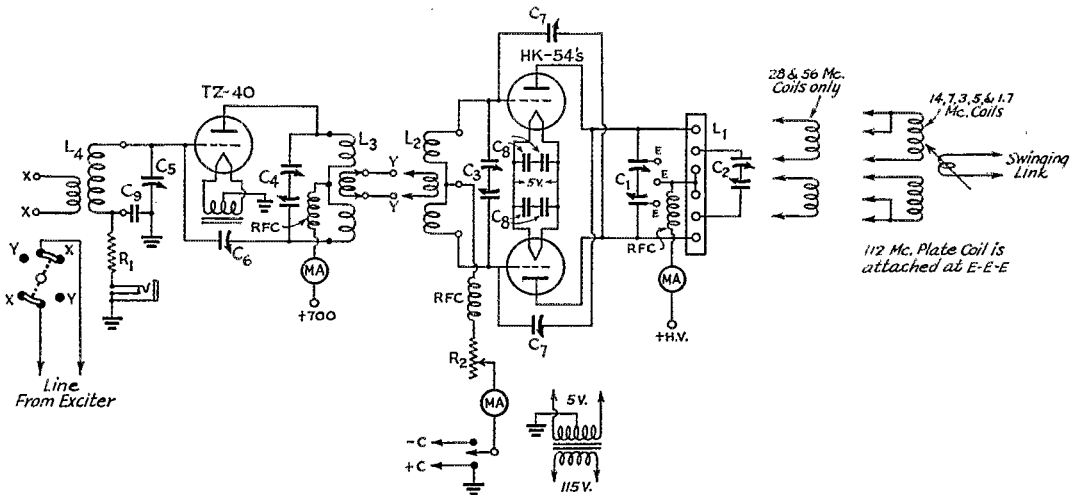

Fig. 2 — Circuit diagram of the unit shown in the photographs. The TZ-40 stage is used only on 28, 56 and 112 Mc.

- C_1 — 15- μ fd. per section split-stator transmitting condenser.
- C_2 — 100- μ fd. per section split-stator transmitting condenser.
- C_3 — 100 μ fd. per section.
- C_4 — 35 μ fd. per section, double-spaced.
- C_5 — 15 μ fd., double-spaced.
- C_6 — 8 μ fd., double-spaced.

- C_7 — Disc-type neutralizing condensers (see photograph).
- C_8 — 0.01- μ fd. mica. Mid-connections of these filament by-pass condensers are grounded to chassis.
- C_9 — 0.002- μ fd. mica.
- R_1 — 5000 ohms, 10-watt.
- R_2 — 5000-ohm adjustable.
- L_1 — Final plate tank coils; see text and photograph.
- L_2, L_3, L_4 — See Coil Table.
- RFC — 2.5-mh. r.f. choke.

★ WHAT THE LEAGUE IS DOING ★

GROWTH

REFLECTING the same growth that we mentioned recently in A.R.R.L. membership, the Federal Communication Commission's report to Congress for the fiscal year ended June 30, 1939, shows an increase in amateur station licenses during the twelve months from 49,911 to 53,558. The report contains a general discussion of amateur activity which is complimentary to us, pointing out that "wherever the flag flies are likely to be found radio amateurs maintaining communication that may become vital in time of emergency or local disaster."

WARNING

RECENTLY a couple of bad cases of "gypping" or attempted gypping by fly-by-night radio schools have come to our attention. This is a word of caution:

The only way to be safe is never to pay any money directly to any salesman or representative. Don't sign up for or pay for any course, either resident or correspondent, without getting a report on the school from your local Better Business Bureau or from the National Better Business Bureau at New York, Chicago or San Francisco, or through your own bank, or from us.

Schools advertised in *QST* have been investigated by us and are reliable. Besides those, there are a number of other good and honestly-run schools. But for every honest one in the country there are probably a dozen or so gypps. Don't get taken in!

ASK HEADQUARTERS

THIS, by the way, is a good place for us to say that A.R.R.L. headquarters makes it its business to keep fully informed on the regulations and interpretations of the F.C.C. concerning amateur operation. We probably centralize more such information in our office than any one desk at the F.C.C. or any one radio inspector's office possesses. When members are confronted by a problem concerning their operating, we would suggest that they write to us rather than direct to F.C.C. or the R.I. It is ten to one that we have the answer on tap and can supply it immediately, and if we don't have it we can always get it with less fuss and feathers and possible disturbance to the smooth administration of amateur radio than direct letters would cause.

FINANCIAL STATEMENT

THE business operations of the League in the last quarter of 1939 showed a nice gain, fol-

lowing the usual rule that the last three months contribute a substantial profit to buck against the operating losses of the duller summer season. By order of the Board of Directors, the operating statement is here published for the information of members:

STATEMENT OF REVENUE AND EXPENSES, EXCLUSIVE OF EXPENDITURES CHARGED TO APPROPRIATIONS, FOR THE THREE MONTHS ENDED DECEMBER 31, 1939

REVENUES		
Membership dues	\$18,119.87	
Advertising sales, <i>QST</i>	23,843.03	
Advertising sales, Handbook	7,588.00	
Newsdealer sales, <i>QST</i>	11,611.17	
Handbook sales	21,773.20	
Spanish edition Handbook revenues	16.75	
Booklet sales	6,139.76	
Calculator sales	386.67	
Membership supplies sales	2,516.53	
Interest earned	399.23	
Cash discounts received	294.39	
Bad debts recovered	21.42	\$92,510.02
<i>Deduct:</i>		
Returns and allowances	\$ 3,261.49	
Exchange and collection charges	48.12	
Cash discounts allowed	602.06	
Increase in reserve for newsdealer returns of <i>QST</i>	218.11	4,129.78
Net Revenues		\$88,380.24
EXPENSES		
Publication expenses, <i>QST</i>	\$17,131.14	
Publication expenses, Handbook	20,372.72	
Publication expenses, booklets	3,120.64	
Publication expenses, calculators	178.01	
Salaries	26,266.27	
Membership supplies expenses	1,722.70	
Postage	1,887.13	
Office supplies and printing	1,644.16	
Travel expenses, business	1,136.31	
Travel expenses, contact	522.20	
<i>QST</i> forwarding expenses	1,091.61	
Telephone and telegraph	698.36	
General expenses	1,505.12	
Insurance	27.69	
Rent, light and heat	1,143.00	
General Counsel expenses	268.11	
Communications Department field expenses	183.60	
Headquarters Station expenses	293.32	
Bad debts charged off	192.37	
Provision for depreciation of:		
Furniture and equipment	298.45	
Headquarters Station	448.89	
Loss on sale of capital assets	2.00	
Total Expenses		\$9,133.80
Net Gain before Expenditures against Appropriations		\$ 8,246.44

OPERATING ON CLASS-A FREQUENCIES

THE current situation of course makes it particularly important that there be no infraction of F.C.C. regulations. There still seems to be some lack of understanding about who can operate a 'phone station in the 4- and 14-Mc. bands.

Since our regs were last revised in late 1938, the rule on the Class A allocation has provided that the station must actually be operated by an amateur operator holding Class A privileges. Only such a person may throw the switches or make calls or sign off the station. (And of course the station must be identified at the end of each transmission unless working break-in in bursts of less than one minute.) In other words, when a station is working on Class A frequencies, the only thing that may be done by a person not also holding Class A operator privileges is to speak over the mike in between the manipulations and pronouncements of the licensed operator in charge. And then all such persons must sign the log in person for each QSO, under some indication that they also spoke over the microphone.

★ NEW ★ TRANSMITTING TUBES

HIGH-POWER DUAL-UNIT TRANSMITTING TRIODE—152TL

A NEW idea in transmitting-tube design is brought out in the recently announced Eimac 152TL. In this tube, the glass envelope contains two sets of triode elements the plates and grids of which are connected in parallel. The filaments are brought out separately so that they may be operated in either series or parallel.

Some of the advantages claimed for this type of construction are small physical size, high-power output at low plate voltages and high thermionic efficiency.

The tube requires a special 4-prong socket to which filament connections only are made. The plate lead is brought out to a terminal on top, while the grid lead is connected to a metal ring on the outside of the envelope.

Tentative ratings and characteristics follow:

Filament voltage.....	5 or 10
Filament current, amp.....	13 or 6.5
Amplification factor.....	10
Grid-plate capacity.....	5 μ fd.

Maximum Ratings

Plate voltage.....	3000
Plate current, ma., telegraphy.....	500
Frequency modulation.....	450
Plate modulation.....	400

Grid current, ma.....	75
Dissipation, watts.....	150

Typical Operating Conditions

Plate voltage.....	1250	1500	2000
Plate current, ma.....	400	450	450
Bias voltage, Class-C.....	300	400	500
Power output, watts.....	325	500	750

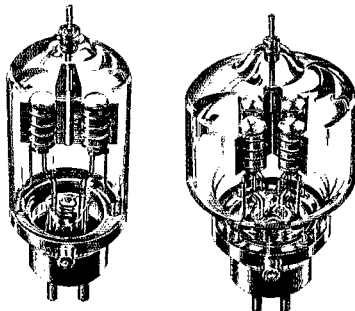

Another tube, the 304TL, is designed along the same lines but contains 4 sets of triode elements in a single envelope. This tube is designed to deliver a power output of 1500 watts at a plate voltage of 2000.

U.H.F. TRANSMITTING TRIODE—HY75

THE HY75 is a medium-power triode just announced by Hytron. It is designed specifically for highly efficient operation at frequencies between 50 and 300 Mc. Ratings and operating characteristics follow:

Filament (directly heated).....	6.3 v., 2.75 a.
Plate dissipation, max. watts.....	15
Amplification factor.....	10

Oscillator and Class-C Amplifier

	Unmod.	Mod.	Plate
Plate voltage, max.....	450	450	450
Plate current, ma. max.....	100	100	100
Plate power input, max. watts:			
224 Mc.....	30	24	
120 Mc.....	35	28	
60 Mc.....	45	36	
Grid current, ma. max.....	20	20	
Grid voltage, max.....	-150	-150	

Typical Operating Data

	224 Mc.		120 Mc.	
Plate voltage.....	300	450	300	450
Plate current, ma.....	93	82	100	68
Grid bias.....	-60	-90	-60	-90
Grid current, ma.....	20	20	15	15
Output, watts.....	16	16	15	15



W5CY sends in a couple QSL cards he found in his collection. They are from W5HIP and W9HIP. Each bears a photograph of the operator in uniform—both are “Highly Intelligent Policemen.”

A Battery Transceiver for 112 Mc.

Compact Self-Contained Unit for Field Work

BY VERNON CHAMBERS,* WJ1EQ

THE change in regulations a year or so ago to extend the low-frequency stability requirements to the 56-Mc. band spelled the end of ultra-simple transceivers on "five." The real place for this type of equipment is now 112 Mc., and with the coming of warmer weather it is to be expected that more and more 2½-meter transceivers will be carried out on field trips. The unit described here was built for just that purpose. It can be assembled for less than twenty dollars, including tubes and batteries, weighs about sixteen pounds, and — something not usually found in transceivers — spreads the 112- to 116-Mc. band over practically the whole tuning-condenser scale.

The tubes used have 6.3-volt heaters, which may seem a bit odd in a unit intended for dry-battery operation. This, however, was a matter of necessity rather than choice — necessity, that is, if sure-fire and non-critical operation was to be expected. Considerable work was done with the comparable 1.4-volt types before we reluctantly decided that they wouldn't meet the requirements. Besides, the 6.3-volt tubes permit the transceiver to be readily adapted to a.c. operation, which will conserve battery life if the outfit is to be used at the fixed station.

As the circuit diagram shows, an HY-615 is used as the oscillator-detector, and a 6G6G as the modulator-audio amplifier. The HY-615 functions well in u.h.f. circuits, and the 6G6G

*Technical Information Service.

makes an excellent audio tube for the purpose, giving high output with small input.

The detector-oscillator tuned circuit consists of C_2 , C_3 and L_1 . The circuit works best with fairly high C , and C_2 provides this capacity. C_3 , tapped across one-half of L_1 , serves as a band-spread tuning condenser. The incoming signal and the d.c. voltage are both fed in at the center-tap on L_1 . This is the best place for connecting the d.c. lead, and connecting the antenna at the same point affects the circuit least while still providing sufficient coupling. Converting from superregeneration to straight oscillation is accomplished by shorting out the larger of the two grid-leak resistances, R_2 , by a set of contacts on the ganged send-receive switch. A second set of contacts connects the HY615 plate to the plate winding of the transceiver transformer, for receiving, or to the 6G6G plate circuit for transmitting. A third set of contacts grounds one side of the microphone jack during the transmission period.

The audio circuit is quite conventional and needs no description. R_5 is the regeneration control as well as the volume control.

Construction

The cabinet which houses the unit measures 6 inches deep, 7 inches wide, and fifteen inches high. If longer battery life is desired, it will be advisable to secure a larger cabinet so that several filament batteries may be paralleled. The

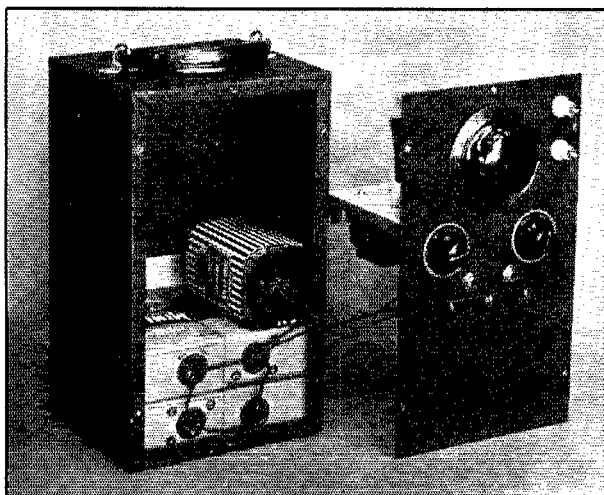

◆
A front view of the transceiver panel layout and the battery compartment. The antenna is a half-wave rod; the upper of the two insulators is only a support.
◆

◆
 Looking down into the r.f. circuit. The band-spread condenser is tipped as shown so that it may be adjusted from the rear after the panel and chassis have been slipped in the case.
 ◆

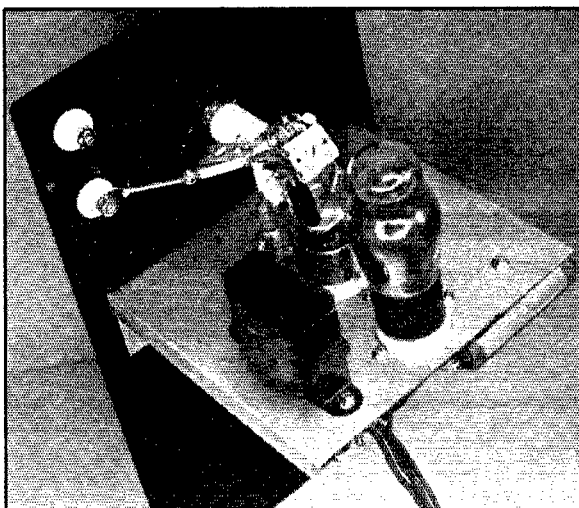

6 by 7 by 15 size will permit at least two batteries to be employed.

A commercial channel-type chassis is used in conjunction with the cabinet. It can be easily duplicated by bending a piece of aluminum sheet. The width is $5\frac{3}{4}$ inches and the depth $5\frac{1}{2}$ inches. A $1\frac{1}{2}$ inch section is bent down along the panel edge for mounting. Side pieces $\frac{1}{2}$ inch wide are bent down along the two short edges to add strength and rigidity.

A view of the panel and battery compartment of the transceiver is shown in one of the photos. The main tuning dial turns a bakelite shaft which runs through a bearing centered on the panel $2\frac{3}{8}$ inches down from the top edge. The two antenna support insulators are to the right, the lower one in line with the shaft bearing and the top one $1\frac{1}{2}$ inches above; both are $\frac{1}{8}$ inch in from the right edge. The volume control, at the left, and the selector switch at the right, are mounted $1\frac{3}{4}$ inches from the edges of the panel and $5\frac{1}{4}$ inches down from the top. After these two holes have been drilled, holes of the same size and spacing should be drilled in the supporting section of the chassis. Later, when the components are mounted, the variable control and the switch are used to fasten the panel and chassis together. Jacks for the headset and microphone are $1\frac{1}{4}$ inches below the controls just mentioned and $2\frac{3}{4}$ inches in from the panel edges.

The HY-615 is mounted at the center of the chassis. The grid-cap of the tube is to the left.

Comes spring and visions of green fields, high hills — and outdoor fun on ultra-high frequencies. This year it's $2\frac{1}{2}$ meters for simple portable equipment. Here's an example.

A socket for the 6G6G is centered 1 inch in from the rear chassis edge and just behind the HY-615. The modulation transformer is to the left of the tubes.

Compactness in the detector-oscillator mechanical layout is the only real objective. This is easily attained by mounting the band-spread condenser on a $1\frac{3}{8}$ -inch stand-off insulator (Millen type 30001) which keeps the condenser clear of the tube. The condenser, with all but three plates removed, is first fastened by running a $\frac{1}{4}$ machine screw up through the inside of the insulator and through the condenser-frame mounting hole. This assembly may be placed quite close to the tube provided the condenser mounting is reversed so that the mounting hole comes under the shaft at the front rather than under the plates at the rear. The insulator may then be placed so that the mounting ring barely touches the tube base. A shaft coupling connects the condenser to the bakelite extension shaft.

Next, C_2 and L_1 are paralleled and one end of the combination is soldered to the left-hand stator terminal of C_3 . This should be a solid connection because it is the main support of C_3 and L_1 . The opposite end of this combination is supported by C_4 , which also connects to the grid cap of the HY-615. C_1 , the antenna coupling condenser, mounts between the rotor terminal of C_3 and the antenna feed-through insulator. A second connection runs from the rotor of C_3 to the center of L_1 to form the band-spread tap. The d.c. voltage, which comes up through the r.f. choke at the right, is also fed in at the tap on L_1 . Another r.f. choke, in series with the grid leaks, connects to the grid of the tube. Both the grid and plate chokes are attached to victron through-point bushings mounted in the chassis to the front of the tube. The plate and grid connections are soldered to the tube caps to

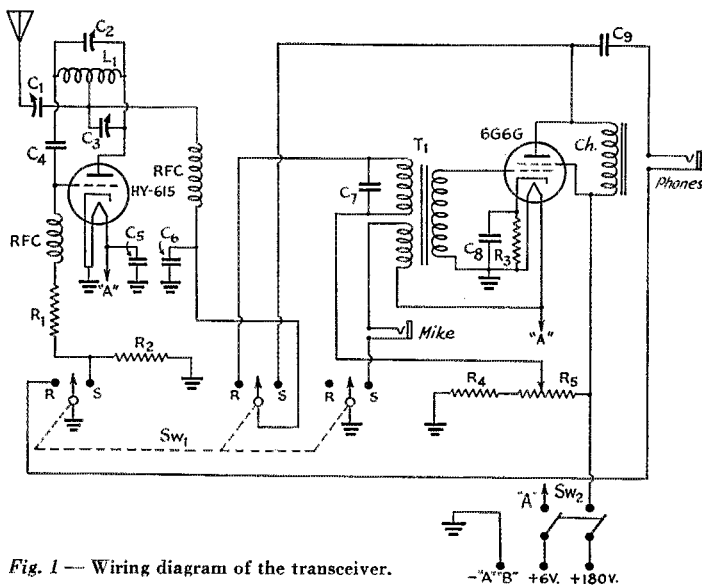

Fig. 1 — Wiring diagram of the transceiver.

- C₁, C₂ — 30- μ fd. mica trimmers (National M30).
- C₃ — 3-plate midget variable (Hammarlund HF-15 with two plates removed).
- C₄ — 100- μ fd. midget mica.
- C₅, C₆ — 0.01- μ fd., 600-volt paper.
- C₇ — 0.002- μ fd. midget mica.
- C₈ — 20- μ fd., 25-volt paper electrolytic.
- C₉ — 0.25- μ fd., 400-volt paper.
- R₁ — 15,000 ohms, $\frac{1}{2}$ -watt.
- R₂ — 125,000 ohms, $\frac{1}{2}$ -watt.
- R₃ — 500 ohms, 1-watt.
- R₄ — 100,000 ohms, $\frac{1}{2}$ -watt.

- R₅ — 100,000-ohm variable.
- RFC — High-frequency r.f. chokes (Ohmite Z-1).
- T₁ — Transceiver transformer (Thoradson T-72A59).
- Ch — 7-henry, 40-ma. filter choke (Thoradson T-13C37).
- Sw₁ — 4-circuit single-gang selector switch (Yaxley 3243J with one set of contacts not used).
- Sw₂ — D.p.s.t. snap switch (Yaxley No. 7 mounted on variable resistor).
- L₁ — 3 turns No. 14 tinned wire, $\frac{1}{2}$ -inch diameter, $\frac{5}{8}$ -inch long.

insure good contact, since the small spring clips are not always reliable.

However, soldering is not absolutely necessary, and is not recommended unless the builder is prepared to be careful to use just enough heat to make the connection. Otherwise the tube may be damaged.

The wiring below the chassis needs no particular care. Of course, r.f. by-pass leads must be as short and direct as possible. Fortunately, there is little opportunity to go wrong, so long as the two 0.01- μ fd. paper capacitors are mounted as shown. The

ground sides connect to a lug held in place by the nut which locks the tube socket in place. The transceiver transformer is at the left, with the grid winding facing the tube sockets. C₈ and R₃ are at the rear of the chassis. C₉ is the large paper condenser at right angles to C₃. R₁ runs between the selector switch and the through-point bushing at the right. R₂ goes from the switch to ground (the soldering lug). Sw₂ is mounted on the potentiometer and connects to the lug strip at the rear of the chassis. Incoming voltage leads are attached to this same strip.

Power Supply

Four of the new Eveready Mimi-Max type 482, 45-volt blocks form the plate supply. These were chosen because of their compactness and relatively long life — fifty-five or sixty hours of intermittent operation. The Burgess type F4P1, 6-volt battery was selected for the filament supply because it offered the same advantages for "A" supply as the Mimi-Max does as a "B"

battery. One of these 6-volt units will permit twenty-two to twenty-five hours of operation. With a larger cabinet, three of these blocks could be paralleled so that sixty or more hours of service could be secured.

A suggested power supply circuit and parts list for a.c. operation is given in Fig. 2.

Adjustment and Operation

To put the transceiver in operation, the battery leads are soldered in place, an antenna (the length is not critical, but it should be around 45 inches)

Fig. 2 — Diagram of suggested a.c. supply.

- T₁ — 300- to 350-volt, 40-ma. plate winding, 6.3-volt, 0.3-ampere (or larger) heater winding, 5-volt, 3-ampere rectifier winding.
- L₁, L₂ — 30-henry, 40-ma. filter chokes.
- C₁ — Dual 8- μ fd., 425-volt filter condenser (electrolytic).
- R₁ — 50,000 ohms, 10-watt.

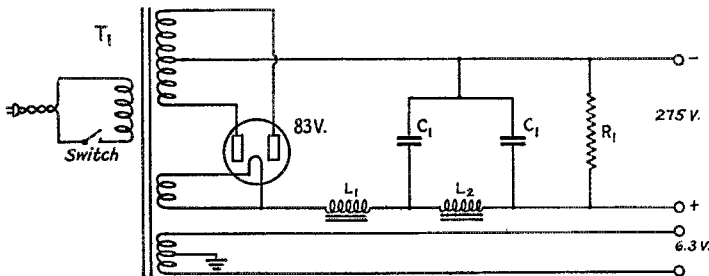

is attached, and the 'phones and microphone are plugged in the appropriate jacks. Resistor R_1 is then rotated in a clock-wise direction to full scale. This snaps on the plate and filament switches and sets the regeneration and volume at maximum. Sw_1 should be thrown to the receive position.

After a second or two of warming up, the superregenerative hiss should become audible. It is probable that the detector will superregenerate properly only at frequencies in and near the $2\frac{1}{2}$ -meter band, which will be found with C_2 , the band-setting condenser, at nearly full capacity. A quarter turn back from maximum capacity should be quite close. Methods of making the frequency check will be discussed later.

The band-spread adjustment is quite easily made because of the construction of the coil. In our model the band could be spread over the entire dial when the band-spread tap was placed at the exact center of the coil. Less spread is obtained with the tap more toward the grid end of the coil and more when the tap is moved back toward the plate end.

It may be well to experiment a bit with the position of the d.c. voltage tap, as sometimes a considerable improvement will result. It is also worthwhile to try different values of grid-leak resistance. A point closer to straight oscillation is reached as the value of the resistance is decreased.

The oscillator is not at all seriously affected by antenna loading, but it is advisable to spend a few minutes trying different adjustments because proper loading does permit the circuit to work at its best. A setting which allows approximately three-quarters of the coupling condenser capacity to be used is about optimum.

Frequency Checking

The problem of finding the band can be solved, at least approximately, by the use of Lecher wires. A set of wires should be made up as described in the *Handbook* (Fig. 1718 in the current edition). To cut down radiation from the wires we used one-inch spacing between them. The measurement procedure is described in the *Handbook*; briefly, it consists of loosely coupling the loop at one end of the wires to the oscillator, then running a shorting bar along the wires and noting the points where the oscillator plate current "kicks" slightly. Keep the coupling loose enough so that the kick is quite small. The distance between two such consecutive points is equal to a half wavelength.

The accuracy of the method depends principally upon the accuracy with which the lengths can be measured and, for calibration purposes, upon the degree of coupling between the oscillator circuit and the wires. The oscillator frequency will be changed by the presence of the coupling loop, so it is well to keep the coupling as loose as possible.

As a matter of interest, we also had available

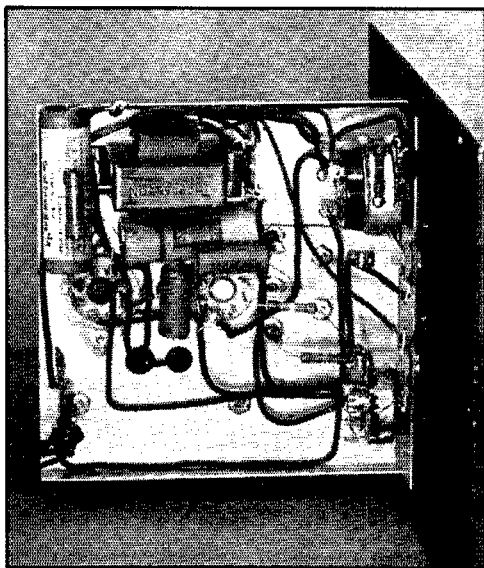

A view of the parts and wiring below the chassis. The grouping of "grounds" is the only important consideration here. See text for details.

a harmonic on 112 Mc. the frequency of which was known to a fairly high degree of accuracy, and checking the Lecher-wire measurement against this harmonic showed that the former was slightly low. The difference was quite small — of the order of 1 per cent — but for higher accuracy it may be desirable to take it into account. The formula:

$$\text{Length, inches} = \frac{5850}{f \text{ (Mc.)}}$$

or

$$f \text{ (Mc.)} = \frac{5850}{\text{Length (in.)}}$$

is probably about right.

Of course, the best method is to use harmonics of accurately-known frequencies for calibrating the unit, with the Lecher wires to make sure that the right harmonic is used. The wires alone, however, will be sufficient if operation is confined to parts of the band a megacycle or so in from either edge.

Strays

Receiving several QSL cards smeared so badly with stamp-cancelling ink that their beauty was nil reminds me that this can be avoided by enclosing cards in an open envelope marked: "Please cancel by hand." Matter marked in this fashion is dated and postmarked by hand instead of being put through a cancelling machine.

— W9PFR.

Improving the Flying Skywire

Details of an All-Wind Kite with A.W.C.

BY DANA A. GRIFFIN,* W2AOE

SOME months ago *QST* carried a story¹ describing the field day of the Tri-County Radio Association, in which kite antennas were used in conjunction with 56-Mc. rigs. It was then intimated that we had much to learn, and that further experiments were required, not only with the kites but also with this type of antenna on the lower frequencies. Experiments with the kite and 56-Mc. gear were conducted during the fall and spring, and the flying skywire was given its first test on the lower frequencies on the A.R.R.L. Field Day. This article is a "log" of these several activities.

At the outset it is safe to say that the kite antenna offers a whole new field of experimentation to those so inclined and, furthermore, offers to those interested in emergency work a highly useful tool with which to increase the range of low-powered equipment on all bands. It is particularly helpful when the regular antennas are not available through accident or a storm. The kite to be described will fly in anything between a

"breath of air" and a wind of gale force. Sleet and a lightning storm directly overhead are the only two things that make flight impossible. Imagine an 8-foot dipole 800 feet high with a single wire feed for 56 Mc. without trouble from surrounding buildings, etc.! How would you like to have a mere 8 half-wave radiator on 80 meters? Work? You bet they work, and if you're interested just follow along.

The first fact that was definitely established was that the larger the kite the more stable the performance, in addition to a greater weight-carrying ability. The second point that was established was that, on five meters, the long wire consisting of a hundred or more half-waves does not work so well as a dipole located in the kite, with single-wire feed. These two points, together with the consideration of the wire to be used as the "string," led to the establishment of a standard dimension of 8 feet 2 inches high by 8 feet 2 inches wide. The type of kite selected and shown in the photograph, was invented by a Mr. Eddy many years ago. It is a consistent performer in light breezes and with some modifications, to be described later, it also behaves nicely in strong winds. The first kites which were built were covered with Kraft paper, which may be secured in any grocery store. For a trial we suggest that this material be used, in order that damage in testing will not prove too costly. Then we recommend oiled silk for a covering, so the kite may be flown in the rain without difficulty. The material is extremely light, tough, and of course waterproof. It is commonly used in women's raincoats and umbrellas. Sufficient material to cover a kite of the size indicated (6 yards) costs approximately \$3.00.

One of the first "inventions" was a method of construction that would permit quick assembly and dismantling of the kite so that it might be transported by car. The solution is in the other photo, where we find a gusset plate of $\frac{1}{4}$ -inch

W2AOE isn't exactly a midget, but he is dwarfed by his 8-foot high silk-covered kite. Note the arrangement of the bridle—a very important point if maximum performance is to be obtained.

* Communications Measurements Laboratory, 136 Liberty Street, New York City.

¹ Griffin, "Tri-County Takes a Holiday," *QST*, June, 1939.

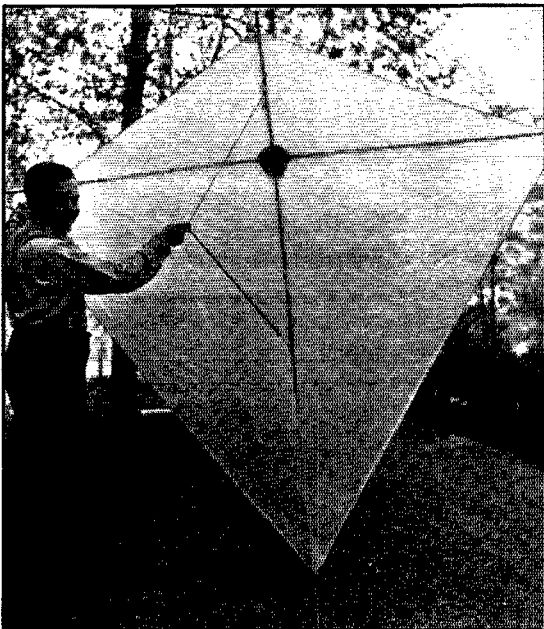

plywood fastened permanently to the 8 foot 2 inches vertical stick. Both the vertical and horizontal sticks are made of $\frac{5}{8}$ -inch clear white pine. The horizontal stick, which is the same length as the vertical member, is clamped in position by means of the movable wooden plate and the two machine screws. It is only a matter of a few minutes to put the cross stick in place and tighten up the screws to complete the frame assembly. Conversely, when the screws are loosened, the cross stick may be swung around parallel to the vertical stick and the "bundle" easily tied to the running board of the car. The gusset plate should be located so that the cross stick is about 18 inches from the top of the vertical member. The most important point of all is that the frame be tested for lateral balance in still air. First the cross stick should be set at exactly right angles to the vertical stick and this position marked on the gusset plate for future use. Then the balance should be tested and adjusted by planing off a few shavings from the heavy side. It is surprising how much difference one shaving can make.

The covering must be removable. This is easily done by drilling holes that will pass No. 18 wire about $1\frac{1}{2}$ inches in from the four ends of the frame. Some heavy fish line, preferably the tarred variety somewhat larger than mason's cord, should be obtained. This should be strung around the outside of the kite frame. First tie one end of the string temporarily to the top of the frame, and then run the string out to one end of the cross stick. Here a knot is tied in the string to form a loop. Some No. 18 wire is run through this loop and made fast permanently. With about six inches of wire projecting beyond the end of the loop, the wire is then put through the hole in the end of the stick and wrapped around the stick. All of this is done so that when the job is finished and the string drawn up tight the outside end of the loop in the string is about $1\frac{1}{2}$ inches "inside" the hole where the wire is fastened. This allows subsequent stretching of the covering which is bound to occur. This same procedure should be followed all around the kite frame. When it is completed we have a pattern by which the material for the cover may be cut. All that is necessary is to lay out the material, place the kite frame over it and cut to leave about one inch of material outside the string. The covering can then be glued on if it is paper, or sewed on (here's

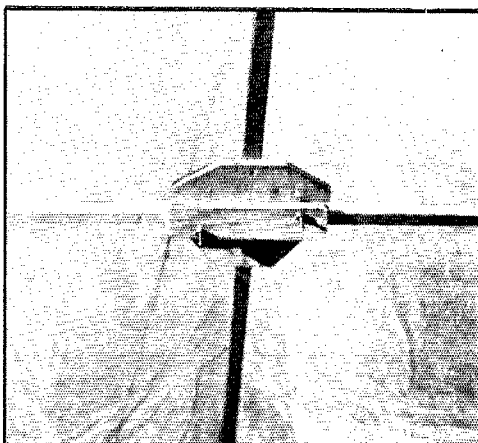

A close-up of the back of the kite shows the arrangement of the gusset plate and the attachment of the cross stick.

where the XYL stars) if cloth is used. All of the corners and the openings for the bridle, etc., should be reinforced by patches. Then, when it is necessary to remove the cover, the wire binders at the ends of the sticks are unwrapped and the cover falls off ready to be folded and stowed away. The entire operation of assembly should not take more than two minutes once some practice has been obtained. The kite should again be balanced laterally with the cover on. If the cover has been cut symmetrically no additional work will be required. The easiest way to achieve balance at this stage is to wrap a small piece of solder around the stick on the light side and slide it out towards the end until balance is obtained.

The next step in the construction is to provide a bow string. First the two ends of the cross stick are notched. Then a loop is tied in the end of a piece of the fish line. This loop is slipped into the notch at one end of the cross stick and the string is then drawn across the back of the kite. This string is tightened so that the distance from the string to the vertical stick is about 8 inches. Another loop is made and slipped into the notch at the other end of the cross stick. This serves to tighten up the covering and makes it possible for the kite to "spill air" uniformly.

If directions have been followed, we now have a kite capable of giving many hours of trouble-free service, provided it is properly adjusted. Once the bridle is constructed, the point at which the string is attached determines the manner in which the kite will fly. If the string is fastened too near to the head, the kite will fly flat and do little useful work. On the other hand, if the string is fastened too low on the bridle, the kite will go into a succession of dives and in strong winds will pull itself apart or break the string. It is obvious that there is an optimum point for every wind speed.

(Continued on page 106)

Kite antennas are a natural for almost any kind of portable operation. Here is the dope on a kite that will fly in any kind of wind and is capable of hauling up a piece of wire to over 1200 feet. It features the first real contribution to kite-flying technique in many a moon — "automatic wind control."

A Hundred-Dollar Half-Kilowatt

Economical C.W. Transmitter Using Push-Pull-Parallel Final Amplifier

BY JOHN G. OSBORNE,* W1DWL

THE new W1DWL transmitter now operating on 10 and 20 meters was designed with the idea of obtaining maximum power for the sum of approximately \$100, yet without shortening the life of tubes and other components by overloading. Investigation disclosed that four medium-power triode type tubes in push-pull parallel in the final amplifier would provide maximum power per dollar, on the basis of continuous-service ratings. And since relatively low plate voltage would give full power input, further savings were indicated in the power supply equipment.

Naturally crystal control is essential, and further to reduce the cost of the transmitter, a crystal having a 14-Mc. fundamental was selected. Oscillator output at either 14 or 28 Mc. can be secured by using a suitable oscillator circuit, and consequently doublers could be eliminated. A single buffer stage is then ample to build up the excitation to the value necessary for the final stage.

The tubes selected for the final amplifier were HY40's, which have continuous-service ratings of 40 watts plate dissipation at 1000 volts. They require about 5 watts driving power each, and double this amount is furnished by the buffer stage, which uses an HY69 tube rated at an r.f. output of 42 watts with 600 volts on the plate. The excess power readily takes care of circuit losses. The buffer tube, a beam tetrode, is easily driven by the crystal oscillator on both 10 and 20 meters, and does not require neutralization. The oscillator is a ceramic-based 6L6GX.

*15 Harris St., Marblehead, Mass.

Since \$100 was the cost limit, it was found expedient to use breadboard construction and a wood type cabinet rack with Presdwood panel. Likewise only one meter, with a circuit selecting switch, is employed.

Circuits

The electrical circuit of the transmitter is outstandingly simple, yet highly efficient as judged by the performance of the completed transmitter. The complete r.f. diagram is given in Fig. 1.

Link-coupling to the final amplifier was discarded in favor of capacity coupling since the transmitter had to be both compact and use no superfluous components. The efficiency of the capacity-coupled circuits is high since there are losses in one tank circuit only. The flexibility in adjusting coupling is somewhat reduced, but in this case tapping the amplifier grids one-third down on the buffer tank coil was found to be entirely satisfactory.

Use of capacity coupling to the final permitted separate r.f. chokes on each side of the push-pull circuit, making it possible to read the d.c. grid currents individually. This was found to be of help in adjusting the grid taps on the coil.

Separate filament windings were used for each pair of paralleled tubes in the push-pull final, thus permitting reading the plate currents of each side separately. This proved of value in loading up the amplifier symmetrically.

Since the HY40 tubes have a medium value of amplification factor, it is necessary to provide bias to limit the static plate current to a safe

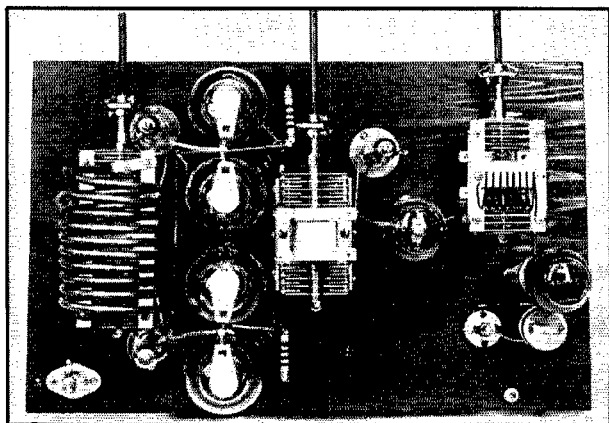

Plan view of the r.f. section. The layout of parts is clearly shown in this photograph.

value. Because of its simplicity, cathode bias was chosen. Adjustable 500-ohm 50-watt resistors are used in the center tap lead of each filament winding. The resistors are adjusted for 35 ma. per tube with 1000 volts on the plate, which gives a static plate dissipation of 35 watts per tube. Naturally, when the amplifier is loaded the bias across the resistors increases because of the increased cathode current. This increased voltage is just about the optimum value of grid bias, making it unnecessary to employ resistors in the grid circuit for additional bias. In this way two birds are killed with one stone: a bias power supply is eliminated and self-bias from grid leaks is not needed.

Furthermore, it is advantageous not to have the plate current cut off to zero with the key up. The 140-ma. total static plate current has a considerable stabilizing effect on the power supply voltage and greatly reduces flickering of electric lights when the transmitter is keyed, since fluctuations in line load are reduced by about 35%.

Cathode bias is also employed with the HY69 tube for the same reasons. However, in this case it is necessary to use a 2-watt 10,000-ohm resistor in the grid circuit to obtain sufficient additional bias for most efficient operation.

The oscillator circuit uses cathode regeneration with a choke in that circuit to pep up the 28-Mc. output when doubling. A grid choke was found to be unnecessary and consequently was omitted. Plate and screen potentials are obtained from a bleeder resistor in the low-voltage power pack. Plate voltage is about 350 and the screen voltage is adjusted for optimum excitation of the HY69 on 10 meters.

Construction

The layout of the r.f. circuits more or less follows conventional ideas. The four tubes in the final stage are arranged in a row with the plate and driver circuits symmetrically placed

on either side. The variable condensers used contribute immensely to the ease of construction and facility with which symmetry is obtained. The final plate tuning condenser has its own mounting feet and the final plate coil is fastened to bolts on the top.

The buffer tank circuit is somewhat unusual in that the buffer coil is placed close to the chassis, thereby reducing the length of the leads to the grids of the final amplifier. The variable condenser is mounted in an inverted position upon ceramic stand-offs, since both the rotor and stator are hot with r.f. The use of long stand-offs makes it possible to mount the grid coil below the condenser. This coil is placed at right angles to the final amplifier tank coil to prevent unwanted coupling. Although not illustrated, a tube shield was finally used with the HY69 to remove traces of circuit instability.

Parasitic suppressors are used in series with each grid lead; 100-ohm 2-watt composition resistors with six turns of wire wound on them were found to be both inexpensive and satisfactory. No plate circuit suppressors are necessary since the paralleled tubes are connected together with a lead approximately two inches long, with the connection to the tank circuit taken from the midpoint. These short leads from plate to plate in conjunction with the grid suppressor make it practically impossible for u.h.f. parasitics to exist. For convenience and protection from absentmindedness, ceramic-insulated grid caps are used.

All r.f. wiring is above the deck and for that reason the statite sockets are mounted on pillars. The "cold" leads, such as filaments, are brought directly through the chassis to the bottom, where they are by-passed for r.f. Most by-passes are inexpensive tubular paper condensers. The final plate by-pass and grid coupling condensers are mica for lowest losses and high voltage breakdown.

Space on the chassis was definitely limited,

◆
Busbar wiring is used underneath the transmitter breadboard. The jack in the upper right corner is for the key.
◆

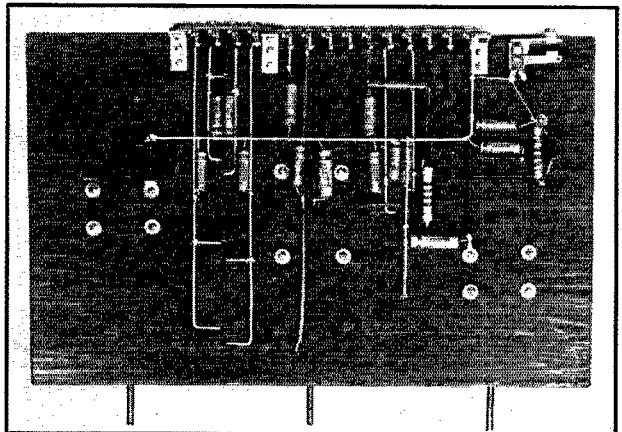
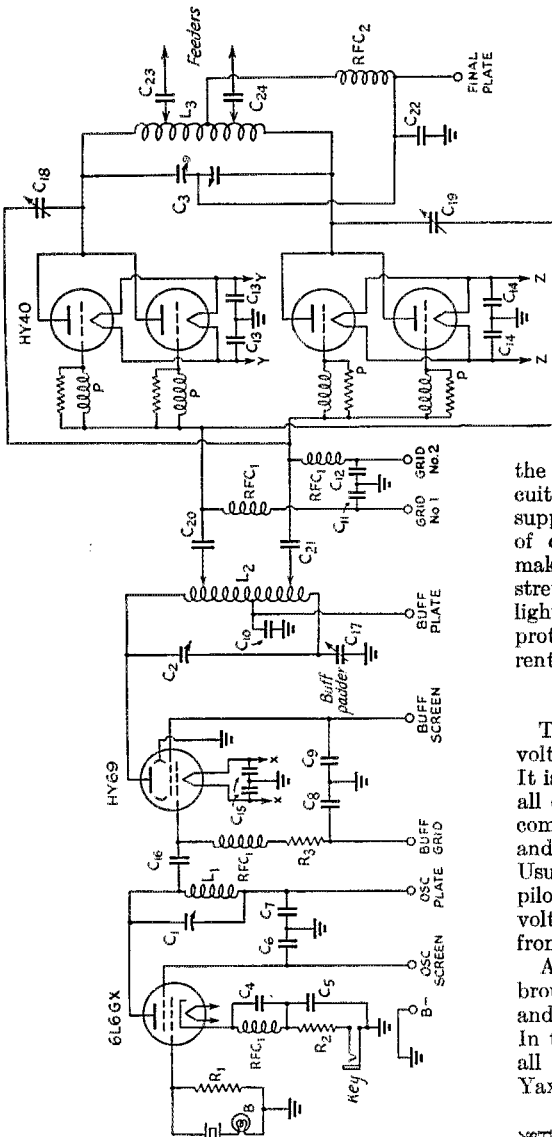

Fig. 1 — Circuit diagram of the r.f. section.

C_1, C_2 — 100- μ fd. variable (condensers used are Millen 13050 with sections parallel).
 C_3 — 70 μ fd. per section, 0.077-inch air gap (Millen 13070).
 C_4 — 0.002- μ fd. mica.
 C_5 — 0.1- μ fd. paper.
 C_6 — C_{16} , incl. — 0.01- μ fd. paper, 600-volt.
 C_{16} — 100- μ fd. mica.
 C_{17}, C_{18}, C_{19} — 12- μ fd. neutralizing (Millen 15003).
 C_{20}, C_{21} — 0.002- μ fd. mica, 1000-volt.
 C_{22}, C_{23}, C_{24} — 0.002- μ fd. mica, 2500-volt.
 R_1 — 100,000 ohms, 1-watt.
 R_2 — 400 ohms, 10-watt.
 R_3 — 10,000 ohms, 2-watt.
 B — 150-ma. pilot bulb.
 P — Parasitic suppressors, 6 turns No. 20, wound on 100-ohm insulated carbon 2-watt resistor.

L_1, L_2 — 7 turns No. 12, diameter $1\frac{1}{2}$ inches, length $1\frac{1}{2}$ inches. Grid taps on L_2 one turn from ends.
 L_3 — 14 Mc.: 10 turns copper tubing, diameter $2\frac{1}{2}$ inches, length 4 inches.
 28 Mc.: 6 turns copper tubing, diameter 2 inches, length $3\frac{1}{4}$ inches.

(Note: Suggested specifications for other bands are as follows: L_1, L_2 , 7-14 Mc., 10 turns, 3.5-7 Mc., 20 turns, $1\frac{1}{2}$ in. diameter and $1\frac{1}{2}$ in. long; L_3 , 7 Mc., 16 turns, $4\frac{1}{2}$ inches long, 3.5 Mc., 28 turns, 5 inches long, diameter $2\frac{1}{2}$ inches in both cases. 150- μ fd. condensers should be used at C_1 and C_2 for 7-14 Mc., and 200 μ fd. for 3.5-7 Mc. For C_3 a condenser of 125 μ fd. per section should be used for 7-14 Mc., and 200 μ fd. per section for 3.5-7 Mc.)
 RFC₁ — 2.5-mh. r.f. choke.
 RFC₂ — Transmitting choke Ohmite Z-2).



which meant that compact neutralizing condensers had to be used. The new Millen tubular units fit perfectly for they are small and yet have the required capacity for neutralizing two tubes, as well as ample voltage rating. A third condenser of the same type was employed across one half of the buffer tank circuit to balance out the capacitive loading on the other half by the plate-to-filament capacitance of the buffer tube.

Although the buffer and oscillator tuning condensers are split-stator types, in this case the two stators are tied together to double the capacitance. Push-pull circuits in the buffer are obtained through the use of a by-passed center tap on the coil rather than a split-stator condenser.

The oscillator plate coil is mounted atop the condenser at right angles to the final tank circuit to prevent inductive coupling. The coil is self-supporting like the others, which saves the cost of coil forms. Furthermore, this construction makes it possible to vary the inductance easily by stretching or compressing the windings. A flashlight bulb is used in series with the crystal to protect it and give an indication of crystal current.

Power Supplies

The center chassis in the rack contains the low-voltage plate-supply and filament transformers. It is the "nerve center" of the transmitter since all circuits are connected to it. The a.c. power comes into the low-voltage chassis, and the plate and filament switches are located at the front. Usual 110-volt home-wiring toggle switches with pilots (costing 45 cents each) are used. The high-voltage power supply gets its primary voltage from this deck.

All electrode returns from the r.f. section are brought back separately to the "nerve center" and pass through the circuit-selecting switch. In this way it is possible to measure current in all grid, screen, and plate circuits. A Mallory-Yaxley 12-circuit switch is employed. For circuit

Fig. 2 — The low-voltage power supply.

C₁, C₂ — 4- μ fd., 1000-volt condenser (Aerovox 1009).

L₁ — Swinging choke, 5/25 henrys, 175 ma. (UTC S-30).

L₂ — Smoothing choke, 10 henrys, 175 ma. (UTC S-29).

T₁ — Filament transformer, 6.3 volts and 7.5 volts (UTC S-69).

T₂ — Filament transformer, 7.5 volts and 2.5 volts (UTC S-66).

T₃ — Plate transformer, 600 volts d.c. at 200 ma. (UTC S-45).

R₁, R₂ — 500-ohm, 50-watt adjustable (IRC Type EPA).

R₃ — 25,000-ohm, 100-watt adjustable (IRC Type HAA).

X — Rotary circuit-opening switch for metering (Yaxley 1400L).

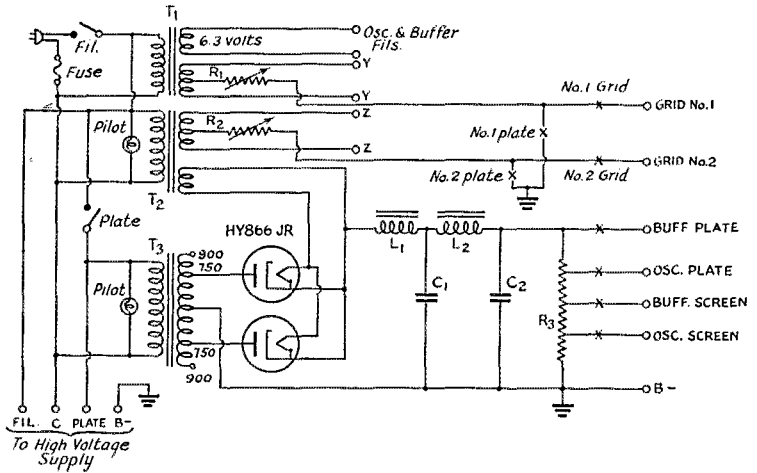

simplification, the cathode-bias resistors for the buffer and final amplifiers are placed on the middle chassis.

The low-voltage power supply, shown in Fig. 2, uses UTC Special Series components, and on the 750-volt tap delivers approximately 600 volts from the filter. Hytron 866 Jr. tubes, having top-cap plate connections, are used since the total current drain from this power supply is less than the 250 milliamperere capacity for a pair of these tubes.

Two 4- μ fd. 1000-volt condensers are used to reduce ripple to a minimum. A two-section filter is employed with swinging-choke input followed by a smoothing choke. This filter is more than ample, in spite of the low capacity employed.

Two filament transformers, each with dual windings, take care of the low-voltage rectifier, the 6.3-volt tubes, and the two 7½-volt filament circuits for the final amplifier tubes.

The bleeder and voltage divider resistor is a 100-watt adjustable unit with several sliders. This and the final amplifier bias resistors have been mounted above the chassis to take advan-

tage of maximum air circulation. Resistors dissipate heat so they should be placed where they will run coolest.

The high-voltage power supply, Fig. 3, contains only the plate transformer, filter choke, rectifier filament transformer, filter condenser and bleeder. Plate voltage outputs of 850, 1000 and 1250 volts d.c. are obtainable at full load. The 850-volt potential is desirable when operating the HY40 tubes as plate-modulated amplifiers, since this is the maximum voltage rating for this class of service. The 1000-volt d.c. output is used for c.w. Actually, the voltage output from the filter is close to 1100 volts. However, it must be remembered that 100 volts are utilized in supplying bias so the net plate voltage is 1000, in accordance with the maximum rating. Shielded 866's are used as rectifiers.

A single-section filter with choke input is employed and on-the-air tests show that this provides ample filtering. The condenser is a 4- μ fd. 1500-volt unit. The 1500-volt rating was chosen so that there would be an ample margin of safety, should the 1250-volt d.c. output from the power supply ever be needed. A 100,000-ohm 50-watt bleeder is used — this high value was selected because the tubes draw 140 ma. without excitation and there is consequently no need of

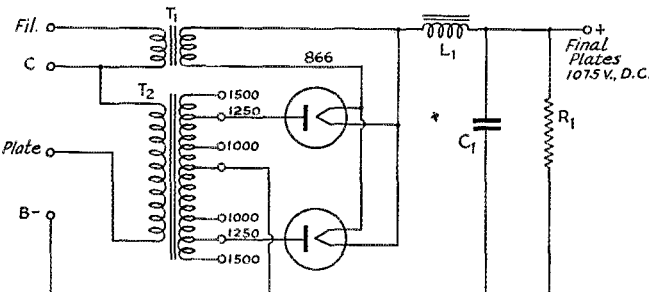

Fig. 3 — High-voltage plate supply diagram.

C₁ — 4- μ fd., 1500-volt (Aerovox 1509).

L₁ — 20-henrys, 550 ma. (UTC S-37).

T₁ — Rectifier filament transformer, 2.5 v. at 10 amp.

T₂ — Plate transformer, 1075 v. at 500 ma. (UTC S-48).

R₁ — 100,000 ohms, 50-watt (IRC Type EP).

a bleeder current in excess of ten milliamperes. By reducing the value of bleeder current, it is possible to use a lower-wattage resistor and reduce costs.

The wooden cabinet, measuring 30 inches high, 20 inches wide and 13½ inches deep, was constructed of cedar which is easy to work. The four corners are glued and screwed together for strength. The sides are neatly perforated with 1-inch holes near the top and bottom of each chassis to obtain good air circulation. The cabinet and the panel were given an overall coating of black lacquer. Ordinary black paint should not be used there or on the chassis since in many cases it contains lampblack, which is a conductor of electricity.

Tuning

Adjusting and operating the transmitter is very simple and no bugs were encountered. The oscillator coil is adjusted so that with all the tuning capacity in, the circuit tunes to 20 meters. Then, with approximately all the capacity out, the circuit should tune to 10 meters. This is likewise true of the buffer plate coil.

The final amplifier cathode bias resistors are adjusted so that the static plate currents of both sets of paralleled tubes are the same, approximately 60 to 75 ma. for each pair. Then excitation is applied on 20 meters and the grid taps on the buffer tank coil are adjusted so the d.c. grid

Low-voltage tubes conservatively operated offer possibilities in getting a good power-to-dollar ratio, power supply and other components considered. Designed primarily for 14 and 28 Mc., the circuit of this transmitter can be adapted to lower frequencies with little difficulty.

currents to each pair of tubes are about equal. The final plate voltage is off during this test. Grid current for each pair of tubes will run from 75 to 100 ma.

Then the final amplifier stage is neutralized by any one of the usual methods. After that, plate voltage is applied to the final. The d.c. grid current will drop to 50 ma. or less per pair of tubes. If the grid current is not the same in both halves of the push-pull circuit, the taps on the coil should be adjusted so that it is. The actual value of grid current should be the maximum, (not over 25 ma. per tube) which can be obtained without causing the buffer tube to draw more than its rated 100-ma. plate current. This permits maximum efficiency in the final amplifier. With this adjustment complete, the final amplifier is balanced on 14 Mc.

Next, the oscillator output and buffer stage are tuned to 28 Mc. (minimum capacity in the tuning condensers) and the 28-Mc. final amplifier plate coil substituted for the 14-Mc. coil. After resonance is obtained in all circuits, the balancing condenser connected from one side of the buffer coil to ground is adjusted so that the final amplifier grid currents are again equal. This last adjustment equalizes the asymmetrical capacity loading caused by the buffer plate-to-filament capacity.

Coupling to the antenna is by adjustable clips which connect, by feed-through insulators, to a non-resonant feeder system. The clips are adjusted so that the final-amplifier plate current is 250 ma. per side. With such an adjustment, loading is the same on both pairs of tubes and a plate power input of 500 watts is obtained.

Measurements and comparisons with two 200-watt load lamps indicate that better than 350 watts power output are obtainable on both 14 and 28 Mc. Since the four tubes have a combined plate dissipation of 160 watts, the plate dissipation actually encountered is below the rated continuous-service value.

Reports from amateurs contacted, plus local monitoring, show that the transmitter puts out a good signal, free from ripple and key clicks. First contact on the transmitter when tried out at W1BVL was a W9 in Colorado who reported S9. While this in itself is no record, it does show that the rig gets out with a wallop.

By careful selection of parts, it is possible to duplicate the transmitter for approximately \$100

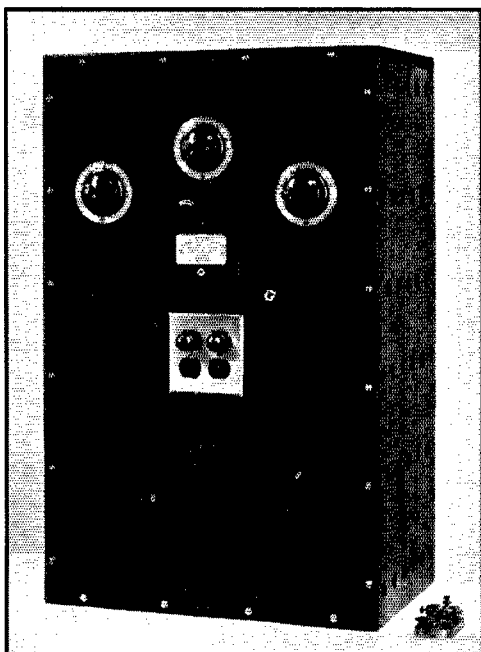

The front panel presents a pleasing appearance. The cabinet is wood, panel of Presdwood.

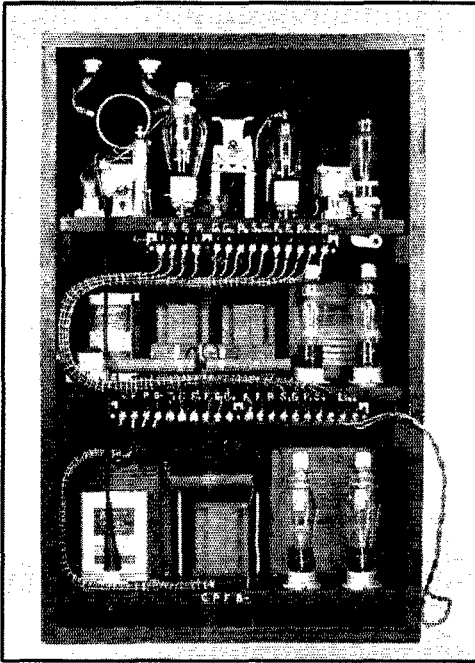

This rear view shows the three decks. R.f. section is at the top, low-voltage power supply and control section in the center, and high-voltage power supply at the bottom.

including tubes, meter, and power supplies. If parts on hand are used, the cost will be so much less. Not only is 1000 volts economical, but it is easier to handle and build a transmitter since no cumbersome high-voltage precautions need be taken. Of course, 1000 volts is dangerous and should be handled with due respect.

All in all, this design has satisfied us that push-pull parallel is practical and the use of medium power tubes at 1000 volts most economical.

New England Division Convention

**Hotel Bancroft, Worcester, Mass.,
April 20th-21st**

THE Worcester Radio Association is planning to give you the time of your life at the 1940 New England Division Convention. If your appetite for conventions has become somewhat jaded in recent years, here is one that will be so new and fresh you'll never forgive yourself if you miss it. One new idea is the "Hamboree," a gala ham party occupying the entire evening of the 20th, with noisemakers, dancing, luncheon, games and a floor show. Another is the unique way in which the 2½- and 5-meter treasure hunt will be

conducted. And in between there will be plenty of solid technical talks by experts on new phases of radio, operating meetings and forums, and other features of general interest. Special arrangements are being made for the ladies attending. For more information write C. A. Sandner, Jr., W1I0R/WL6J, Chairman, 32 Lincoln St., Worcester.

Midwest Division Convention

**Hotel Allis, Wichita,
April 27th-28th**

WICHITA, KANSAS, the Air Capital, will be the rendezvous for hams from all over central U.S.A. when the A.R.R.L. Midwest Division has its annual convention at the Hotel Allis, on April 27th and 28th. From Denver, from Kansas City, from Portage, Wis., from Iowa, Nebraska, Oklahoma and even Tennessee, the registrations have been pouring in. Unusually interesting speakers of national reputation will be on the program, including *QST*'s M.E., "Roddy," W1SZ. Nifty prizes will be given, with a special drawing for sold-in-advance tickets only; these advance registration tickets can be secured from Treasurer Clarence Wallace, W9ABJ, 835 Porter, Wichita. The price is only \$2.50 — and that includes the feed, Saturday evening, and banquet, Sunday. For further particulars on the convention, write A. B. Unruh, secretary, Wichita Amateur Radio Club, 1617 S. Seneca St., Wichita.

The Chile Conference

(Continued from page 22)

under the leadership of CE2BX had planned a welcoming dinner for me, as I later learned on my return when I spent several hours with CE2BX and CE2AW; it is most regrettable that a combination of late arrival and a mixup in the resulting schedule caused us to miss connections.

At Santiago, I was immediately among friends. Although we did not arrive in Santiago until nearly midnight, I was promptly waited on by a delegation consisting of Luis Desmaras, CE3AG; Arnold Siemsen, CE3CZ; J. Bernain, CE3DG; and R. Sinitsky, CE3AD. The next night, these fellows joined with others of the Santiago gang in giving a dinner for Señor Carlos Tudela, OA4Z, the Peruvian delegate, Señor Alberto Lopez, YV5AL, the delegate from Venezuela; Srs. O. N. Carli and F. Dellamulla of the Argentine delegation, and myself. Throughout the conference I was enabled to keep in touch with West Hartford through daily 'phone schedules arranged by CE3AG and CE3CZ with W1EH, while CE3DG maintained daily c.w. skeds with W1AW. To all of these people I am deeply grateful for the many kindnesses shown me.

Balloon-Supported Antennas

Dope on the Use of Real "Sky Hooks" for Radiating Systems

Technical Editor, *QST*
38 LaSalle Road
West Hartford, Conn.

Dear Sir:

In studying the *Antenna Handbook* published by the A.R.R.L., I was intrigued by the fact that apparently no one has done any work on antennas suspended from balloons. Do you know of anyone who has worked along this line, and what the results were, if any?

I am so situated that it would easily be possible for me to put up a balloon to almost any distance under a thousand feet. In your opinion, would it be worth-while pursuing this line of thought, and what results might be anticipated from such an antenna working on 20, 40, 80 and 160 meters?

Very truly yours,

Hugh L. Walker, W8ENF

January 22, 1940

Mr. Hugh L. Walker, W8ENF
Syracuse, New York

Dear Mr. Walker:

Some work has been done with antennas suspended from balloons but not to any great extent. It has been done mostly by the military services and in other emergency applications. The disadvantages, of course, are obvious; the necessity for storage of the gas and other equipment and the difficulty in designing a suitable antenna. For example, a single long wire won't do the trick — an examination of the patterns of long-wire antennas shows that vertical antennas longer than a half-wave length have very little low-angle radiation and this is undesirable on most of the amateur frequencies. However, a balloon-supported half-wave antenna on 160 meters might really put out a signal. On the higher frequencies you would probably run into difficulties with feed systems and the poor radiation patterns mentioned above. However, if you are interested in experimenting with half- or full-wave balloon-supported antennas on the 80- and 160-meter bands, we should be very much interested in your results. From a point of interest, just how does it happen that these balloons afford you no problem? They aren't readily available, are they?

We have had a few articles in the past dealing with kite-suspended antennas — you might like

Syracuse, N. Y.
January 11, 1940

to refer to one of the recent articles on page 30, of the June, 1939, issue of *QST*.

Sincerely yours,

Byron Goodman
Asst. Technical Editor, *QST*

Syracuse, N. Y.
February 5, 1940

Dear Mr. G.:

Thank you for your letter of January 22nd which I delayed answering purposely, inasmuch as I was right in the middle of beginning my experiment. As yet I have no results worth reporting although I have had some communication on 75-meter 'phone with the balloon-supported antenna.

Balloons as a support for antennas are not going to be satisfactory with the balloons which are now available, although I believe that a usable balloon could be designed for the purpose.

Sounding balloons are available from Dewey & Almy Chemical Co., Cambridge B, Mass. The only ones which would be of interest are Nos. 350 and 700. The No. 350 balloon will lift a weight of approximately five pounds when inflated to 6 feet in diameter with hydrogen. The bursting diameter of this balloon is 13 feet, so you will see that it can be inflated larger than 6 feet. However, the wall of the balloon is so thin that the slightest contact with a twig or branch of a tree will cause a large bang and much mending with Scotch tape.

The No. 700 balloon is similar to the smaller one except that its bursting diameter is 18 feet and, of course, it has a correspondingly increased lift. The difficulty with both balloons lies chiefly in the fact that they are spherical in shape, and even a wind of eight to ten miles per hour will cause them to blow down at such an angle that if there are any trees in the vicinity the antenna becomes useless.

I am writing to the Chemical Company and suggesting that they do a little experimenting with different balloons, and I am also at present working on a design of a different type antenna which I hope to experiment with. I doubt if anything startling will come out of this work but at least it has been interesting and I will advise you of the final results.

Very truly yours,

H. L. Walker

P.S. Several interesting by-products:

1. The whole town has been in the shack.
2. Owners of .22 rifles are sorely tempted!

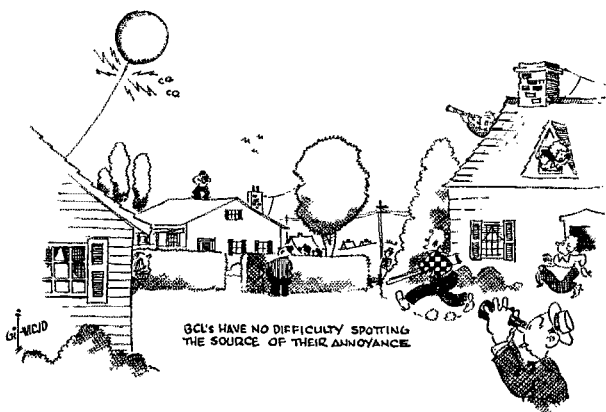

★ A.R.R.L. QSL BUREAU ★

FOR the convenience of its members, the League maintains a QSL-card forwarding system which operates through volunteer "District QSL Managers" in each of the nine United States and five Canadian districts. In order to secure such foreign cards as may be received for you, send your district manager a standard No. 10 stamped envelope. If you have reason to expect a considerable

number of cards, put on an extra stamp so that it has a total of six-cents postage. Your own name and address go in the customary place on the face, and *your station call should be printed prominently in the upper left-hand corner.*

3. The ribbing is awful on the air!
4. B.c.l.'s have no difficulty spotting the source of their annoyance!
5. The ground wave is terrific!

February 8, 1940

Dear Mr. W.:

Many thanks for your response to our inquiry about the balloon-supported antenna. Unfortunately, we have no suggestions or recommendations to make at this point, but we do hope you will continue your experiments and keep us informed about them.

Incidentally, if you have a photograph showing the balloon antenna in actual operation, it might be just the thing to run along with a recital of your experiences to date. We could list those "by-products," mention that you had actually used the thing on the air, and show the photographs.

Byron Goodman

Syracuse, N. Y.
February 13, 1940

Dear Mr. G.:

Re your letter of February 8th, I regret to advise that experiments have ceased. My worst fears are realized. The balloon offered a temptation which the youth of the vicinity found themselves unable to resist. The balloon is gone, the antenna is gone and all insulators are gone. You can readily understand why experiments have ceased.

That is the 6th and final by-product of the experiment.

Hugh L. Walker

P.S. You can also understand why there are no photographs to enclose.

Don't forget the Hudson Division Convention, Kreuger Auditorium, Newark, N. J., May 11th. Full announcement in QST next month.

- W1 — J. T. Steiger, W1BGY, 35 Call Street, Willimansett, Mass.
- W2 — H. W. Yahnel, W2SN, Lake Ave., Helmetta, N. J.
- W3 — Maurice Downs, W3WU, 1311 Sheridan St., N. W., Washington, D. C.
- W4 — G. W. Hoke, W4DYB, 328 Mell Ave., N. E., Atlanta, Ga.
- W5 — James F. Manship, W5ALE, 910 So. Boston, Tulsa, Okla.
- W6 — Horace Greer, W6TI, 414 Fairmount Ave., Oakland, Calif.
- W7 — Frank E. Pratt, W7DXZ, 5023 So. Ferry St., Tacoma, Wash.
- W8 — F. W. Allen, W8GER, 324 Richmond Ave., Dayton, Ohio.
- W9 — Alva A. Smith, W9DMA, 238 East Main St., Caledonia, Minn.
- VE1 — L. J. Fader, VE1FQ, 125 Henry St., Halifax, N. S.
- VE2 — C. W. Skarstedt, VE2DR, 236 Elm Ave., Westmount, P. Q.
- VE3 — Bert Knowles, VE3QB, Lanark, Ont.
- VE4 — George Behrends, VE4RO, 186 Oakdean Blvd., St. James, Winnipeg, Manitoba.
- VE5 — H. R. Hough, VE5HR, 1785 First St., Victoria, B. C.
- K4 — F. McCown, K4RJ, Family Court 7, San-turce, Puerto Rico.
- K5 — Norman F. Miller, K5AF, 15th Air Base Squadron, Albrook Field, Canal Zone.
- K6 — James F. Pa, K6LBH, 1416D Lunalilo St., Honolulu, T. H.
- K7 — Jerry McKinley, K7GSC, Box 1533, Juneau, Alaska.
- KA — George L. Rickard, KA1GR, P. O. Box 849, Manila, P. I.

A Simplified Exciter Circuit

Electrical Variation of Crystal Frequency

BY W. D. MacGEORGE,* W3GHR

THE exciter to be described has been in use for over a year at my station as a driver for a single 6L6 amplifier stage running at 30 watts input. The advantage of the exciter is that it can be operated either pure crystal-controlled or variable-crystal-controlled.

As can be seen from the diagram (Fig. 1), the oscillator circuit is similar to the Pierce circuit except that a tuned circuit L_1C_1 is in series with the crystal. When operating pure crystal controlled the coil L_1 is replaced by a shorting plug. However, with the tuned circuit in, a variation of about 5 kc. can be obtained with a 7-Mc. crystal. When tuning for variable control, the circuit can first be checked by setting C_1 at minimum capacity. The crystal will oscillate in this position, and as the capacity is increased the frequency should start to change. The point at which it starts to change is the nominal crystal frequency, and increasing the capacity further will change the frequency in gradual changes for about 5 kc. Further increase in the capacity will result in a click in the receiver or monitor, indicating that the 5-kc. span has been concluded, and a new frequency will appear from 10 to 15 kc. lower. Approximately four more frequencies can be obtained as the condenser is advanced towards maximum capacity. Only one of these will exist at any one time, but their quality will depend to some extent on the grade of crystal being used. The output on these lower frequencies is about 20 per cent lower than it is over the normal 5-kc. span.

* 78 N. Girard St., Woodbury, N. J.

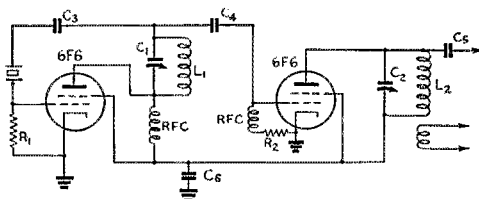

Fig. 1 — Variable frequency exciter.

- C_1, C_2 — 100- μ fd. midget variable (C_1 and C_2 ganged).
- C_3, C_4, C_5 — 50- μ fd. midget mica.
- C_6 — 0.1- μ fd., 400-volt paper.
- L_1 — 13 turns No. 18 enam., close-wound on $1\frac{1}{2}$ " diam. form, for 7 Mc.
- L_2 — Same as L_1 for 7 Mc.
7 turns space-wound for 14 Mc.
- R_1 — 100,000 ohms, 1-watt.
- R_2 — 25,000 ohms, 1-watt.
- RFC — 2.5-mh. r.f. choke.

These lower frequencies are mentioned simply to avoid "discovery" of them by other experimenters, and it is not recommended that they be used for normal operation. The 5-kc. variation gives enough to get out from under QRM.

The second stage is a conventional buffer-doubler stage and operates in the usual fashion. In my set-up, C_1 and C_2 are ganged, for ease in tuning.

Tracking is most easily adjusted by making the oscillator self-excited. This is done by replacing the crystal with a shorting plug. Set C_1 and C_2 at half capacity and adjust the turns on L_2 until maximum output is obtained. The exciter will now track for any crystal that is used.

The exciter is built in a homemade box 10 inches long, 8 inches wide and 9 inches high, although any arrangement should be satisfactory. Short leads and rigid mechanical construction are advisable and, with a good d.c. power supply of 250 volts, no trouble should be experienced.

Either capacity or link coupling may be used, although link coupling seems to be more satisfactory. The stage that is being driven should of course be well-neutralized, to avoid trouble from feed-back.

WWV Schedules

EXCEPT for the special broadcasts of WWV using 20 kw. as described below, WWV is now running a continuous schedule (day and night) on 5000 kc. with a power output of 1 kw. This continuous transmission is modulated with the standard pitch in music, 440 cycles per second.

Each Tuesday, Wednesday and Friday (except legal holidays), the National Bureau of Standards station, WWV, transmits with a power of 20 kw. on three carrier frequencies as follows: 10:00 to 11:30 A.M., E.S.T., on 5000 kc.; noon to 1:30 P.M., E.S.T., on 10,000 kc.; 2:00 to 3:30 P.M., E.S.T., on 20,000 kc. The Tuesday and Friday transmissions are unmodulated c.w. except for 1-second standard-time intervals consisting of short pulses with 1000-cycle modulation. On the Wednesday transmissions, the carrier is modulated 30% with a standard audio frequency of 1000 c.p.s. The accuracy of the frequencies of the WWV transmissions is better than 1 part in 5,000,000.

It Did Happen Here . . .

Hints for Eliminating B.C.L. QRM

BY GENE TURNEY,* W2APT

RUNNING a kilowatt in an eighty-five family apartment house in the heart of New York City presents many interesting problems, to say the least. (For instance — the necessity for moving about thirty b.c.l. antennas so the three-element rotary could make a complete revolution! And the radiator just about clears one of the skywires which could not be moved for lack of space.) But the interference problems were naturally the worst, and it goes without saying that tempers, in many instances, were short. In the end, however, all the difficulties were surmounted. This story deals with the finding, diagnosing, and curing of more than 55 b.c.l. sets which were interfered with by our 14-megacycle 'phone. We shall not attempt to deal with complicated theories, but rather shall confine our description to the causes of b.c.l. interference, running them down (before the F.C.C. offers to help), and, last but not least, effecting a cure.

The reader should let firmly and solidly sink home one important point — *all cases of b.c.l. interference can be cured!* This may be hard to believe, but we covered everything from the old Majestic 90 to the present day "bargain package" variety put out by a local power company on a sales promotion in conjunction with a lamp and toaster. Further to emphasize the point, there were no "deaths" on our list of patients — all recovered. We will take up in order of importance the procedure that should be followed.

First and foremost is what we shall call (to use a salesman's expression) "customer approach". More than one well-meaning ham has put his foot in it by starting off with a chip on his shoulder, and since the b.c.l. has already been swinging his axe, a barrier is automatically created between our hero and the patient. If you will but swallow your pride and set off with that famous old elegy "the customer is always right" you will have licked half your problem. A friendly patient will overlook the fact that he can hear you by putting his ear to the loud-speaker, but to an antagonistic one this QRM is sufficiently annoying to impel him to write his Congressman, the Board of Trade, the F.C.C., the landlord, and what not. Above all, never go into a complainant's home with the idea that if it were not for us amateurs there wouldn't be any such thing as broadcast reception. This is really like throwing gasoline on a smouldering fire, and is apt to do irreparable

* % Kenyon Transformer Corp., 840 Barry St., New York City.

harm to your case. Ham radio to the average b.c.l. is like the old adage of which got there first, the chicken or the egg. I cannot too strongly stress the point, for it is imperative that you attack the situation with your most charming smile and cordial manner. The old days when we were awed by the mere sight of a transmitting antenna are gone, and radio broadcasting is just as much a necessity to the average human being as washing his face or getting his breakfast. The b.c.l. has just as much right to listen to the Smith Family as we have to work DX — maybe a greater right, for while the average broadcast receiver will provide enjoyment to people in all walks of life, a transmitter is for one person's sole pleasure. If you will let your attitude be influenced by the above statement you will not only have made a friend but at the same time gotten a much clearer picture of how the other half of the world lives.

Fundamental Causes

Next down the line is the fundamental cause of the QRM. This depends a good deal on the type of receiver. The old t.r.f. sets (of pre-a.v.c. days) are usually subject to cross-modulation, where the QRM rides in on top of the broadcast signal to which the set is tuned; plain lack of selectivity may also bring the ham signal in over all or a good part of the dial when the local transmitting field is strong. Superhets usually will show "spot" tuning, because some harmonic of the receiver oscillator mixes with the transmitter frequency to give a beat at intermediate frequency which is then amplified and detected in the same way as the desired signal. With all types of receivers the QRM may get in either through the antenna or by direct pickup in some exposed part of the circuit, including the audio end. Further to complicate matters, the interfering voltages may exist in the receiver not only by brute force but

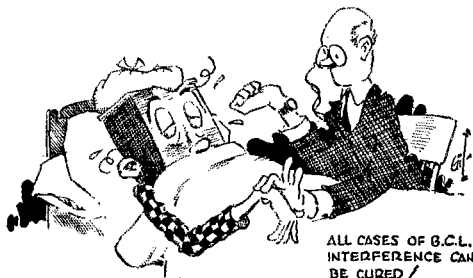

ALL CASES OF B.C.L. INTERFERENCE CAN BE CURED!

in many cases because some combination of circuit elements inadvertently happens to resonate near the operating frequency. For instance, a by-pass condenser-resistor combination may become resonant; this is usually found in screen and cathode circuits. A thousand possible combinations will produce such an effect, and to attempt to list them all would be impossible since no two radio sets are identical so far as troubles are concerned. Once we know that such a condition exists it becomes a matter of routine to find and cure the particular "loop" which is causing the trouble.

Diagnosing the Case

To expedite clearing the trouble it will be necessary to proceed in the following manner: With a licensed amateur operating the transmitter and yourself at the b.c. set, tune in the interfering signal so that it is received at its loudest point. Disconnecting the antenna will show whether the interference is coming in by the front door or not, but in either case it is best first to see if the trouble cannot be cleared up internally. Antenna or line traps work best at only one frequency, and we want to get at the root of things and avoid such expedients if possible. Now, with the signal doing its worst to jam the receiver, start taking out tubes beginning with the first r.f. or that tube which is directly fed by the antenna.

If the receiver is a superhet, especially of the midget variety, the chances are that removing the converter (combined mixer-oscillator) will kill the interference. If so, and if the tube and the grid lead are unshielded, the logical thing to do is to shield completely the tube, grid lead and top cap, making sure that all the shields are grounded to the chassis. An unshielded glass tube may be replaced by a metal tube of the corresponding type, in which case the tube shield will not be needed, although shielding the grid lead and cap is still necessary. When substituting a metal tube for glass, make certain that the shield pin on the tube socket is grounded to the chassis. If this shielding still does not completely remove the QRM, a metal plate should be installed to enclose the bottom of the chassis — making good electrical connection to the chassis, of course.

Most receivers of this type respond quite satisfactorily to this treatment, and no further digging into the receiver is necessary.

On the other hand, if the pickup is somewhere after the first tube and ahead of the rectifier the interference will continue to come in despite the fact that one or more tubes have been removed from their sockets. *There will be one tube which, when removed, will cause the QRM to disappear completely*, and it is here where we should begin to look for trouble. Replace the tube in question and remove the socket connections one by one starting with the grid lead, following with the suppressor, screen, plate and cathode.¹ Replace each before taking off the next. (You may well hesitate before starting this part of the procedure if you haven't had some experience with fixing b.c. sets, because it won't help diplomatic relations with the b.c.l. if his set refuses to work as a result of your ministrations! In case you have any doubts as to your ability to keep the receiver working, better enlist the good offices of a ham who has had service experience.) It will be observed that only one connection is causing the trouble because when it is unsoldered all interference disappears. If it is a plate lead it will be necessary to insert a small parasitic choke such as the type used for a grid suppressor. This consists of about ten turns of number 20 d.c.c. wound around a 100-ohm 1-watt resistor. If it is in the screen circuit it will be necessary to change the screen by-pass or resistance to some other value. Many screen circuits have a load resistance connected from screen to ground equal in value to the dropping resistance which is connected from screen to "B"-plus, and it will only be necessary to change the resistor from screen to "B"-plus to one of slightly higher value. In practice we found it satisfactory to increase this resistance about 20 per cent and to increase the screen by-pass capacity accordingly. If one of the suppressor grids is the guilty party the trouble may be cured by using our parasitic choke, or shielding the suppressor-grid lead. We have yet to find a case where both were necessary, but it is not beyond possibility so we mention it here. The control grid is the source of most evil, especially in the bargain package type of radio receiver for, in order to economize, set manufacturers will not shield a grid lead unless necessary to the broadcast-band

¹ Removing leads in this way may sometimes lead to a false conclusion if the lead in question has an important influence on the operation of the remaining elements. For example, disconnecting the screen lead in an r.f. receiving tube will practically cut off plate current so that in such a case the trouble might be in either the screen or plate circuit. It might be well to have available a few resistors and condensers so that different values could be substituted temporarily for those originally in the receiver, thus permitting the tube to continue working, but under different operating conditions. It is suggested that the cathode be investigated last because disconnecting it will practically "kill" the stage except for resonant effects in the plate circuit which do not depend upon plate-current flow.

— EDITOR.



If, as they say, experience is the best teacher, then W2APT ought to be an expert on curing b.c.l. QRM. Where once his 20-meter kilowatt laid b.c. receivers low right and left, the air is now quiet and serene. Some valuable hints on keeping peace in the neighborhood.

performance of the receiver. Inasmuch as the control grid of a tube is at the same time a factor in getting a signal into the tube, using an unshielded wire produces much the same result as attaching an antenna directly to the grid. In most cases a shielded lead will cure the trouble, but in some instances it was found necessary to use the choke which we have described in conjunction with a tube shield and shielded grid lead. The combination of all three was only found necessary in those receivers having no r.f. stages. In some instances it was only necessary to substitute a metal tube for the existing glass one (again making sure that the shield connection on the socket was grounded).

The above procedure licked all of the problems we encountered where the interference was picked up in the r.f. section of the receiver. Troubles found in the audio-section were of an entirely different nature, so a few generalities will be discussed.

Audio Systems

Audio systems in most radio receivers are relatively "rectification free" so far as amateur signals are concerned, but occasionally one finds all the trouble originating in the first audio or following stages. These cases are relatively simple, since it is only necessary to change the cathode by-pass condensers to a different value or to insert our parasitic choke in either the filament leads or the grid lead. No cases were encountered where the screen was the offender. By-pass condensers of the order of 10, 15, 20, 25 and 30 μ fd. are desirable for audio purposes, the necessary working voltage being about 50 volts maximum. In correcting troubles in audio circuits it is advisable to add the smallest by-pass condenser possible inasmuch as too great a capacity will cause hum. Typical of the cases we encountered were those where the signal was being rectified in the phonograph section only and was not being picked up in any of the r.f. stages. One interesting case had a shielded grid lead of sufficient length so that when used in conjunction with the crystal pickup a complete circuit was set up enabling the signal to be picked up and rectified. Adding two feet of shielded lead and bonding the pickup arm to the motor frame and thence to the audio chassis cured the trouble. All in all, interference because of rectification in the audio circuits was extremely

small, so small in fact, that it does not further require any discussion.

General Hints

A.c.-d.c. midgets are probably the worst offenders, and in these cases we decided that if an antenna trap or line filter would cure the interference we should go no farther. However, this was not effective in all cases, so it became necessary to resort to the previously-outlined methods to effect a cure. For tube substitution purposes it will be necessary to take a 25-volt and a 6.3-volt tube and cut off all but the filament prongs. The tube does not have to be a good one since its only function is to provide continuity, inasmuch as the filaments in these receivers are usually connected in series. Incidentally, the F.C.C. does not consider these receivers as being of modern design, and in many instances a proper explanation together with a copy of the F.C.C. rules will make the complainant realize that he cannot expect too much. At their best the midget a.c.-d.c. receivers are a headache, and if possible they should be brought to the shack to be fixed because here we have conditions at their worst. While on this subject I suggest that if it is possible all the b.c.l. sets should be worked on in the actual room where the transmitter is housed. With the rig connected to a dummy load it is a comparatively simple matter to hook a headset across the voice coil leads and hunt for the cause of trouble. This method saves plenty of chasing and will greatly cut down the time element. We have often threatened to make a portable battery-operated job which we could carry right to the heart of the enemy's camp, and with a load across the output do the whole job right on the premises. As it was, we had so many cases it became necessary to rig up a portable telephone line from receiver to transmitter and 'phone instructions back and forth.

It might be a good idea to be sure that you have done all that is necessary at your own end before leaving for the b.c.l.'s castle. Such details as line filters in the transmitter itself, using transformers with shielding between primary and secondary, proper housing of the transmitter (breadboard construction is *out* so far as crowded apartment houses are concerned), using antenna coupling which discriminates against all except the transmitter output frequency, a good ground, and similar essential points of good practice, will greatly reduce the number of complaints.

The work described consumed about six months' time, and the consensus was that all cases of b.c.l. interference can be cured. All that is needed is that cordial appearance, a cooperative attitude, a little common sense, and someone to operate the transmitter. The author wishes to extend his sincere gratitude to W2BKZ and W2KZT, without whose untiring help this story would not have been possible.

A 56-Mc. Crystal-Controlled Transceiver

A Completely Portable Battery-Operated Station

BY FRANK JACOBS,* W2BSL

MANY radio amateurs remember the fun on five meters when they could run around the country with small battery-operated transceivers. At one time hundreds of these were to be found at almost any outdoor hamfest near densely-populated cities. Many of them covered remarkable distances when taken on high buildings, on mountain tops or in airplanes or gliders.

Those who intend going on $2\frac{1}{2}$ meters may be interested in comparative field strength measurements made through and around buildings in New York City.¹ A wavelength of 7 meters showed an attenuation of 50 per cent every 500 feet whereas 3-meter radiations were reduced the same amount every 225 feet. There are many contributory factors to be considered, but generally speaking 56 Mc. will surpass 112 Mc. point for point, especially in portable operation where absorption is always present.

Regulations requiring more stable transmitters were intended to improve the coverage and general usefulness of the 56-Mc. band. Results have improved remarkably, but sad to relate comparatively few of the old gang have stuck to "five" because of the seeming difficulty of changing over to stable equipment. This is a serious

* Radio Transceiver Laboratories, Richmond Hill, N. Y.

¹ Beverage, Peterson and Hansell, *Proc. I.R.E.*, Vol. 19, pp. 1313-1333, August, 1931. L. F. Jones, *Proc. I.R.E.*, Vol. 21, pp. 349-386, March, 1933. Trevor & Carter, *Proc. I.R.E.*, Vol. 21, pp. 387-426.

accusation and a challenge to the ingenuity of the amateur fraternity.

The following article describes a complete battery-operated portable station that greatly outperforms the older modulated-oscillator models and yet is no larger, nor is it heavier. It is costlier by the price of a meter, a few tubes and some small parts. A careful examination of the circuit diagram (Fig. 1) shows why this transceiver is better. The reasons for superiority are briefly as follows:

1. The transmitter r.f. circuits employ a 1J6G twin triode as a 28-Mc. crystal oscillator (or tuned-grid if preferred) and 56-Mc. doubler. Midget air dielectric condensers are employed for tuning. A 1F5G straight r.f. amplifier having an input of 4 watts follows.

2. The receiving circuit employs a 1D5GP tuned r.f. stage which greatly improves selectivity and prevents radiation. A standard superregenerative detector circuit is used. The two stages have ganged tuning.

3. The common audio channel makes use of a 1H4G first stage for amplifying the output of the detector or of the microphone, and a 1J6G in Class-B delivering 2 watts of audio.

Four tubes only are used at any time. The other two have their filaments opened by the send-receive switch when not in service. This same switch throws the antenna from the trans-

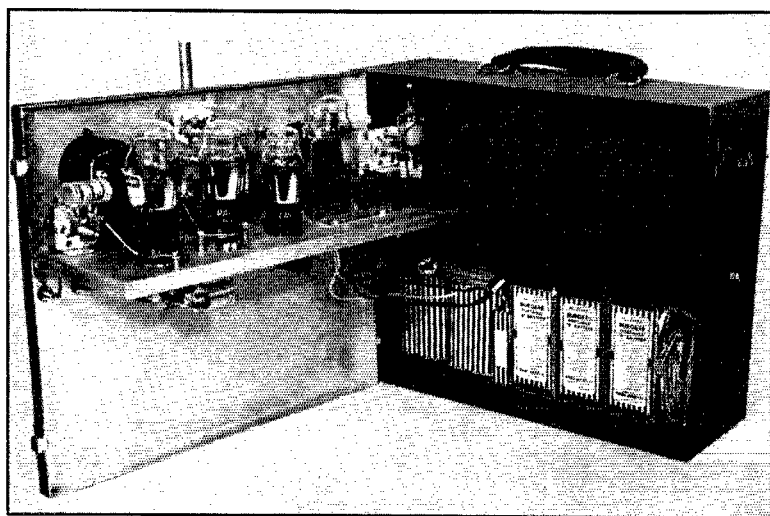

The battery-operated transceiver opened up to show how the space inside the carrying case is utilized. Transmitter and receiver are built on an aluminum shelf running the length of the panel.

mitter to the receiver. As the transmitter filaments take somewhat higher current than do those of the receiving tubes, a small network of $\frac{1}{2}$ -watt resistors is inserted automatically to keep the voltage constant when the send-receive switch is thrown.

4. Users of the old-type battery transceivers will remember that they had several annoying defects. (a) Optimum antenna coupling for transmission was too tight for reception. When coupling was best for reception, transmission was badly hampered. This trouble is obviously elimi-

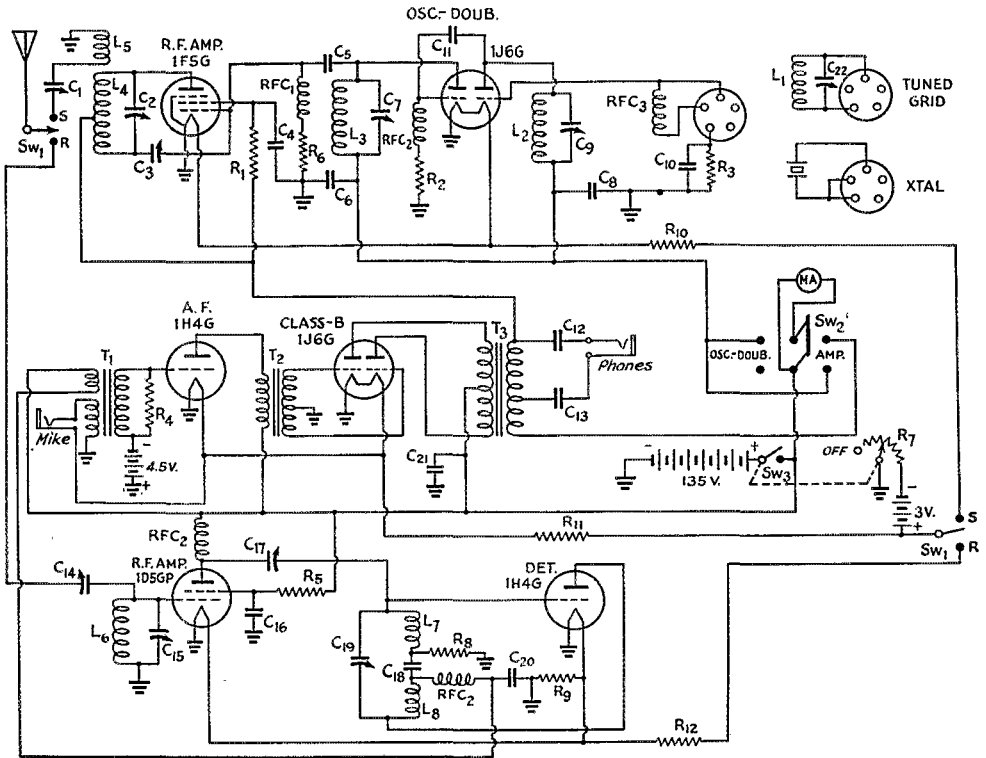
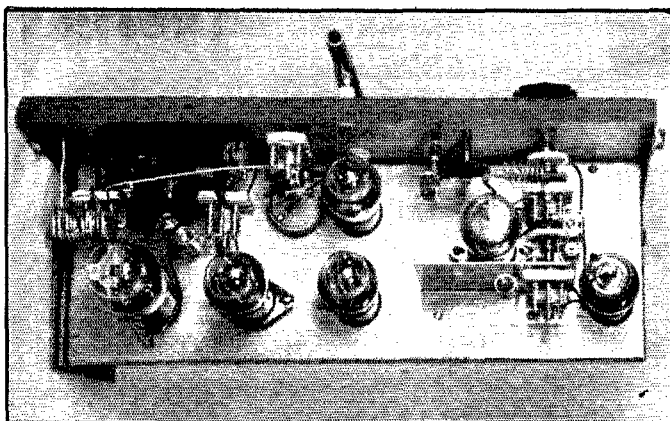

Fig. 1 — Complete wiring diagram of the battery-operated 56-Mc. transceiver.

- C₁ — 25 μ fd. midget.
- C₂, C₇ — 15- μ fd. midget.
- C₈ — Neutralizing condenser (National NC600); not required in some layouts.
- C₄, C₅, C₆, C₈, C₁₅, C₂₀ — 0.004- μ fd. paper.
- C₅, C₁₁ — 100- μ fd. mica.
- C₉ — 35- μ fd. midget.
- C₁₀ — 250- μ fd. mica.
- C₁₂, C₁₃ — 0.1- μ fd. paper.
- C₁₄ — 50- μ fd. mica padder.
- C₁₅, C₁₉ — 10- μ fd. midget.
- C₁₇ — 50- μ fd. mica variable padder.
- C₁₈ — 100- μ fd. mica.
- C₂₁ — 3- μ fd. electrolytic.
- C₂₂ — 50- μ fd. air padder, mounts in L₁ plug-in coil form.
- R₁, R₃ — 5000 ohms, $\frac{1}{2}$ -watt.
- R₂, R₆ — 10,000 ohms, $\frac{1}{2}$ -watt.
- R₄ — 500,000 ohms, $\frac{1}{2}$ -watt.
- R₅ — 30,000 ohms, $\frac{1}{2}$ -watt.
- R₇ — 10-ohm rheostat with off position on wire and snap switch on back.
- R₈ — 100,000 ohms, $\frac{1}{2}$ -watt.
- R₉ — 3 ohms, 1-watt.
- R₁₀, R₁₁, R₁₂ — 1 ohm, $\frac{1}{2}$ -watt.
- T₁ — Mike and plate-to-single-grid transformer (high-ratio type).
- T₂ — Class-B input transformer for 1J6G.

- T₃ — Class B output transformer, 1J6G plates to 3500 and 5000 ohms.
- SW₁ — D.p.d.t. rotary switch.
- SW₂ — D.p.d.t. toggle switch.
- SW₃ — S.p.s.t. snap switch (see text), dashed lines indicate ganging.
- L₁ — Optional 28 Mc. grid coil. 9 turns No. 12 wound on $\frac{5}{8}$ -inch diameter form, spaced with No. 14; inserted in interior of plug-in coil form.
- L₂ — 28-Mc. oscillator tank — same as L₁ but not plug-in.
- L₃ — 56 Mc. doubler tank. 7 turns No. 14 on $\frac{3}{8}$ -inch diameter form, spaced with No. 14.
- L₄ — 56 Mc. amplifier tank. 6 turns No. 12 on $\frac{5}{8}$ -inch diameter form, spaced with No. 14; center tapped.
- L₅ — 4 turns No. 12 on $\frac{3}{8}$ -inch diameter form spaced with No. 14, wound over L₄ or 2 turns at each end.
- L₆ — 7 turns No. 14 on $\frac{3}{8}$ " dowel to occupy 1" — remove dowel.
- L₇, L₈ — 6 turns No. 14 on $\frac{3}{8}$ " dowel to occupy 1". Space between coils should be greater than 1", inductive relation not required.
- RFC₁ — 2.5-mh. r.f. choke.
- RFC₂ — 70 turns No. 30 d.s.c. on $\frac{3}{8}$ " dowel (wood) that has been boiled in paraffine. Paint winding with low-loss coil dope.



◆
 A plan view of the outfit. Transmitter at left, receiver at right. A quarter-wave rod antenna fits into the receptacle mounted by standoff insulators on the front panel.
 ◆

nated when separate optimum coupling is provided for each, with a switch to transfer the antenna. (b) The receiver tuning of the old types directly altered the transmitter frequency, with the result that the operators spent most of their time chasing each other over the band. This difficulty is also entirely eliminated by the use of separately tuned circuits for transmitter and for receiver. An additional refinement in the form of screwdriver-slot tuning of the transmitter circuits prevents accidental detuning that may occur when knobs are used. The insulated tool is clipped to the side of the case, where it is always handy. Plug buttons may be employed to cover the holes, if one wishes the unit to be entirely dust tight. (c) Another bothersome feature of battery transceivers was the open windings of perfectly new and nice-looking standard transformers. The plate currents of these units were not excessive enough to create an open circuit, and no one ever found an open while in operation. The transformer "burn outs" were always discovered after periods of idleness. The reason: formation of electrolysis because the "B" batteries were not disconnected. The remedy: a separate "B" switch on the back of the filament rheostat which automatically removes the high potential from all circuits when the transceiver is turned off.

Construction

The transceiver shown measures $12\frac{1}{2}$ inches high by 15 inches wide by 5 inches deep, holds all batteries, and weighs 15 pounds less batteries. The user has the choice of employing batteries having a combined weight of $11\frac{3}{4}$ or $5\frac{3}{4}$ pounds. The heavier batteries are somewhat cheaper and give slightly greater life than do the lighter-weight batteries. The heavier type 45-volt batteries are Burgess No. 5308 and Eveready 762. The lighter types are Burgess Z-30-NX and Eveready No. 482. Two $1\frac{1}{2}$ -volt portable "A" batteries like the Burgess 4FA or Eveready 724 are recommended for filament supply. Burgess

also makes a 3-volt "A" battery designated as No. 2F2H and another as No. 4F2H. The latter is huskier and exactly equivalent to two No. 4FA mentioned, or to two of the common old style No. 6 dry cells with which everyone is familiar, although lighter and smaller than the Number Sixes.

The 1940 *Handbook* contains a nice listing of available batteries and their service life on page 275. Most of the types mentioned above are included.

The general layout of the unit is shown quite clearly in the various photographs, and needs little description. The receiver section is at the right, with the r.f. amplifier at the rear of the aluminum shelf. A baffle shield separates it from the detector circuit, which is next the panel. The two audio tubes are in the center, while the transmitter occupies the left-hand (from the rear) part of the chassis. The two tubes, oscillator-doubler and amplifier, are along the rear edge of the chassis. The crystal tank circuit is underneath, and the doubler tank circuit on top, of the shelf.

Tuning

Tuning the rig is quite simple, and when completed operation consists simply of turning the send-receive knob.

Connect the proper batteries and rotate the combined filament rheostat, filament and high-voltage switch sufficiently to the right for the superregenerative hiss to be heard in the "receive" position. This usually occurs in the neighborhood of 1.8 to 2.0 volts.

Next turn the switch to the "send" position and the meter switch to the "oscillator-doubler" side. The meter will read about 50 ma. with a tuned grid coil, and by checking the output with a 2-volt pilot lamp and two-turn pickup loop, the current can be reduced to 40 ma. by grid tuning without sacrifice of output as indicated by the pickup loop. When operating with a 10-meter crystal the total current will be about 15 ma. out

The once-popular 5-meter transceiver in modern form. A few more tubes, but greatly stepped-up performance without much additional expense.

of resonance, and will rise to 40 ma. when the crystal frequency is reached by tuning the oscillator plate tank.

When the oscillator is "putting out" nicely, the doubler condenser is rotated for a dip of 10 ma. in the total plate current read on the meter. The oscillator and doubler now take 30 ma. Should these values not be attained when using 135 volts on the plates, tap the lead from C_{11} to L_2 a turn or two from the hot end of the coil, and also tap down the wire from C_5 to L_3 until the doubler dips 10 ma. when C_7 is resonated.

Now throw the meter switch to the amplifier, where it will read 35 ma. out of resonance and 10 ma. when the plate tank condenser C_2 is in tune, and antenna disconnected. Connect the quarter wave antenna and tune the antenna condenser C_1 for maximum rise in plate current. Retune the plate tank condenser for a new dip and repeat the process until the amplifier draws about 30 ma., or a power input of 4 watts.

A 2-volt 60-ma. (No. 48) pink-bead pilot lamp may be connected in the circuit between the "send" side of switch SW_1 and C_1 . When so connected it will be near a current loop as the circuit is really a doublet, with a quarter wave rod working against the metal chassis as a simulated quarter wave. The lamp will light to full brilliancy and may even burn out on voice modulation. If it does it is a sign of good output and the lamp may be replaced with a 6-volt 150-ma. (No. 40) brown-bead bulb. No difference has been observed in the signal by the introduction of the lamps, and as they give a real indication of current flowing in a feederless antenna system they can replace expensive and cumbersome thermo-couple milliammeters in portable gear.

I will not go into detail on the results obtained.

Suffice to say that compared to the old transceiver the range and quality are greatly improved, not only because of stability, freedom from annoying electrical defects, mechanical encumbrances and receiver re-radiation, but also because there are now many fixed and mobile stations with sensitive superheterodyne receivers or converters that will really do things to a stable low-powered signal.

Before jumping to $2\frac{1}{2}$ or $1\frac{1}{4}$ where the coverage is far less than on 5 meters, it might be well to modernize those transceivers that are collecting dust. When you incorporate the features described you will be well repaid for your efforts and will have a job that will be capable of running rings around old-fashioned equipment.

Arizona State Convention

**Adams Hotel, Phoenix,
April 19th-21st**

THE Arizona boys haven't had their annual convention the past couple of years, and they've missed the regular get-together. So this year they plan to make up for lost time. Sponsored by the Radio Club of Arizona, the Arizona State (Southwestern Division) A.R.R.L. Convention is to be held at the Adams Hotel in Phoenix, Friday, Saturday and Sunday, April 19th through 21st. The program promises to be an unusual one, with well-known technical speakers, *QST*'s Managing Editor C. C. Rodimon, W1SZ, and a variety of stunts and features. The total charge for attendance will be \$2.00. Write Chas. E. Spitz, W6FZQ, Box 3804, Phoenix, Ariz., for tickets and reservations.

Strays

Replace the rubber feet of the bug with small vacuum cups. Wet the cups and slap the bug on the operating table. Not only will it not slip, but you'll probably have to pry it up to move it. — K6QPG/6.

◆
Bottom view, showing the wiring. Audio transformers are below the chassis. The speech system is for use with a single-button mike.
◆

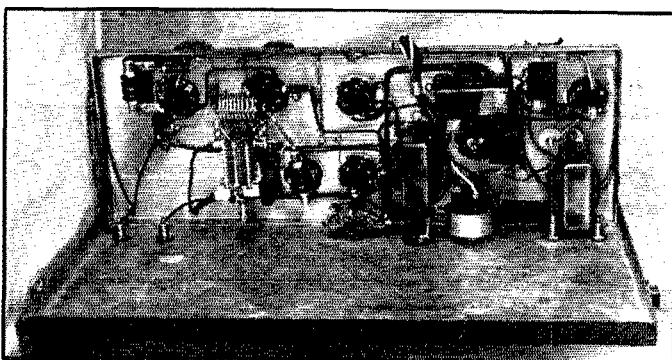

The Design of Speech Amplifiers

BY PAUL E. MILLINGTON,* W9KSW, AND
DOUGLAS W. FATH,** W9UST

THE speech amplifier of the modern amateur radio-telephone transmitter consists of the voltage amplifiers in the audio channel between the microphone and the grid or grids of the driver stage, although many amateurs also include the driver stage within the meaning of the term. With the possible exception of the drivers, which often must deliver considerable power, each of the stages in any such amplifier should operate Class-A, which means that the grids are not usually driven positive and that the plate current remains constant under all conditions. Class-A

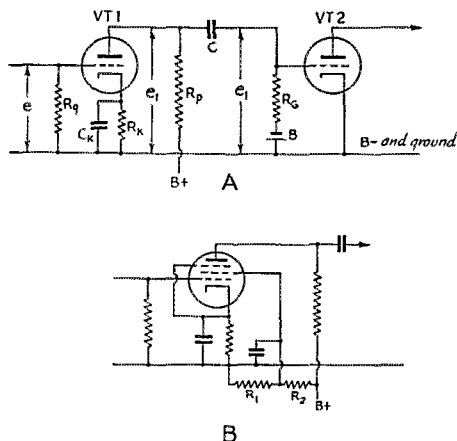

Fig. 1 — The fundamental circuit of a Class-A amplifier using triode tubes is shown at A. The necessary modification for a pentode tube is given at B.

amplifiers give low distortion and high gain but rather poor plate efficiency.

The two most popular methods of connecting Class-A tubes are by means of resistance coupling and transformer coupling. These alone will be considered at this time, in the order named and with particular emphasis upon the first.

Resistance Coupling

The circuit of an audio voltage amplifier, resistance coupled to another, is given in Fig. 1-A, using triodes with indirectly heated cathodes. Tubes such as the 56, 76, 6C5 or 6F5 are of this type. A signal voltage "e" is developed by the microphone between grid and B- of the first tube across R_k . The cathode is maintained posi-

tive with respect to ground by the flow of current through R_k and hence positive with respect to the grid, which is another way of saying that the grid is negative with respect to the cathode. The value of R_k is usually given among the operating data on the tube, or it can be easily calculated from the recommended operating voltages and current. A large cathode by-pass condenser, C_k , provides a low-impedance path from cathode to ground for audio voltages. The plate current of VT1 flows through R_p and causes an appreciable audio voltage to appear between cathode and ground unless the resistor is well by-passed. Since any audio voltage between cathode and ground caused by the plate current flow is, in its effect on the grid, in the opposite direction to the signal voltage, it tends to cancel the effect of the signal and hence the amplification of the stage. If too small a cathode by-pass condenser is used, the amplification will fall off at the lower frequencies. To avoid the use of R_k and C_k , one or more small bias cells, B, may be inserted between R_g and B- or ground to maintain the grid properly negative, as in the case with VT2.

R_p is the series plate load resistor which offers high impedance to the amplified audio voltages, e_1 . The amplified audio output voltages, e_1 , appearing across R_p are fed to the next grid through a coupling condenser C . The function of this condenser is to block off the high d.c. voltage of the plate of the first tube from the grid of the second while simultaneously transferring the alternating audio voltages from the one to the other. R_g is the grid resistor of the second vacuum tube, VT2, across which the voltage e_1 now appears. No flow of direct current occurs through this resistor and hence the resistor in itself has a negligible effect upon the bias of the tube. The constant bias voltage may be secured from bias cells as shown, or by means of the R_k - C_k combination of VT1.

Many suitable triode tubes are available for audio amplifier work, although pentodes are often used as triodes by tying the proper electrodes together. For example, the 57, 58, 6C6, 6D6 and 6J7 pentode tubes readily become medium- μ triodes if the suppressor and screen grids are connected to the plate. The correct connections for triode operation with other multi-grid tubes are usually suggested in their data when the tubes are suitable for this sort of service.

Pentodes are often used in the first stage of speech amplifiers, particularly with low level input, because of their greater voltage gain. They

* University Extension Division, 623 West State St., Milwaukee, Wis.

** 2806 North 54th St., Milwaukee, Wis.

If you're building or trouble-shooting a speech amplifier, it's always well to know the "whys" of Class-A amplifier operation. Here's a non-mathematical explanation of those of most interest and practical use.

are not generally used following high-gain pentode stages because the high amplifications often cause instability in the amplifier. A typical Class-A pentode is given in Fig. 1-B, in which the suppressor is tied to the cathode (or to ground), the screen being maintained at a fairly low positive potential from a tap on the d.c. voltage divider R_1R_2 across the plate supply. Incidentally, to emphasize an oft-repeated point, the screen voltage must never be too high, otherwise the stage may oscillate, rendering it more or less completely inoperative. R_1 is usually 50,000 ohms, R_2 100,000 or 200,000 ohms. The screen is by-passed to B— with an electrolytic condenser to provide a low impedance return for amplified audio voltages. That is, as far as audio voltages are concerned, the screen must be at zero potential.

Bias cells for control-grid bias may be used to particular advantage with pentodes, since usually only one or two cells are necessary.

The amplification of resistance-coupled amplifiers varies with frequency, being greatest with those frequencies in the intermediate ranges, falling off more or less sharply in both the low and high portions of the audio spectrum. Over the intermediate frequencies, the amplification is essentially constant. The maximum amplification that can be expected with a triode-connected resistance-coupled stage is about 7 per cent of the amplification factor, or μ , of the tube. The familiar 56 and 76 will thus each give a maximum practical amplification of only 9 or 10 per stage, corresponding to a gain of about 20 db, while some of the newer tubes, such as the 6C5

and 6F5, are much more effective in this respect. The 58, 6C6, 6D6 and 6J7, acting as medium- μ triodes, have effective amplifications varying from 13 to 14 (23 db) per stage. A pentode, however, may give a maximum amplification of approximately 8 per cent of its μ . Thus the 57, 6C6 and 6J7, connected as suggested in Fig. 1-B, will each yield a rather conservatively estimated voltage gain of 100, corresponding to 40 db.

The overall amplification and the amplification at low and high frequencies vary considerably with the circuit constants. Increasing the value of the grid resistor to one or two megohms increases the maximum amplification, at the same time favorably affecting the low-frequency response from 30 cycles upward. The electrolytic cathode condenser affects favorably the low frequency response if its capacity is large, as previously pointed out. Except for the by-passing of 60-cycle ripple, however, practical results do not justify capacities much beyond 4 μ f., although capacities from 10 to 25 μ f. are often used, since the condensers are not expensive in the low-voltage ranges. Increasing the coupling resistance, R_p , decreases the high-frequency response and increases the gain. The advantages are not particularly marked unless the high values of R_p are accompanied by high plate supply voltages, due to the considerable d.c. voltage drop across the resistor. The practical effect of a change in the desired direction with ordinary power supplies is limited to values of R_p two or three times the plate resistance characteristic of the tube itself, which may be ascertained from the tube data. The capacity of the coupling condenser C has a very direct bearing upon the amplification at low frequencies, where its reactance is greatest. Capacities beyond 0.1 are scarcely necessary, however; usually 0.05 μ f. is ample to extend the frequency response to 40 or 50 cycles, and 0.02 μ f. is often used where extreme low frequency response is not essential. The effect on the intermediate and high frequencies is negligible with

(Continued on page 112)

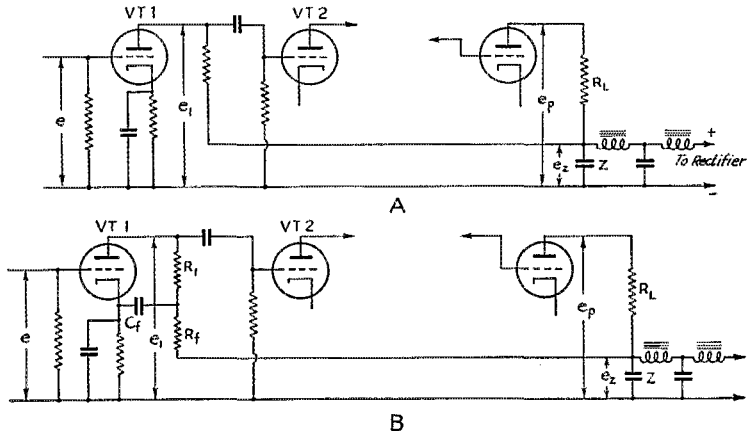

Fig. 2 — The plate supply furnishes the common impedance responsible for feed-back in an amplifier. Addition of the filter shown in B is the usual preventative or cure.



CONDUCTED BY E. P. TILTON*, W1HDQ

THE Third U.H.F. Relay at least served the useful purpose of giving us a chance to find just what the ultra-highs are really capable of in the way of reliable communication, even under the worst possible conditions. From start to finish this contest was run off without the slightest assistance from the weatherman; in fact, he did his worst for those hardy souls who attempted portable operation.

In direct contrast to its predecessors, both of which started off with a bang as the result of fortunate breaks in the form of extended operating range resulting from lower atmospheric bending, the Third Relay started with the operating range at practically its absolute minimum. Before the contest was many hours old the gang accepted their fate and the contest became a traffic-handling bee which saw messages shuttling up and down the eastern part of the country and across the Great Lakes area with a speed and precision which would do credit to established trunk-line routes.

Though the interchange of messages between the East Coast and Middle West stations accomplished in the November relay was not repeated, new territory was added in other directions, with the north-south route extended to cover all the territory from Exeter, N. H., to Richmond, Va. Much credit should go to W3FJ and W3CYW of Richmond and W3DBC of Washington, D. C., for extending the relay to Richmond. Only Maine and North & South Carolina are now needed to complete a Maine-to-Florida 56-Mc. network! Who will volunteer to break the ice in these areas?

Though the scores are not all in at the time this is being written, the lineup of the leaders looks something like this: W3AC/3, High Point Park, N. J., the winner again by a wide margin; W3HOH, Bernardsville, N. J., second; W2MO, Livingston, N. J., third; and W1KLJ and your conductor with little or nothing between them pulling up in fourth and fifth places. What a man

* 329 Central St., Springfield, Mass.

All time mentioned is local time for the station whose work is reported.

is this W3AC! Would he let a little thing like the winter's worst ice storm keep him from making his way to the top of New Jersey's highest mountain? Though the wind bent their antenna into trombone shape a couple of times, Goyne and Millard (official W3AC logkeeper) stuck with it to the bitter end, working 32 different stations and handling a mighty pile of traffic! Another "tough egg" is W1KIK, who negotiated the icy slopes of Mt. Wachusett (2250' elevation, Princeton, Mass.). Bud found the going too poor to justify holding on to the end this time, however.

Some excellent work was turned in by a network of W8's and W9's extending from W8CIR in Alliquippa, Pa., to W9ZHB, Zearing, Ill. Given a halfway decent break by conditions, this combination could have connected up with the east and speeded our west-bound traffic on its way with ease. The next relay is scheduled for May 11th-12th. If past performances mean anything, this one should surely be a wow! With the year's best conditions often coming up about this time, the Fourth U.H.F. Relay should be our golden opportunity for completion of that long-awaited coast-to-coast route.

HERE AND THERE:

Probably the youngest YL ever to modulate a 56-Mc. rig is Nancy Carol Collamore, who at the tender age of *three minutes* announced her arrival at the home of W1LRF of Lowell, Mass., at 11:05 p.m., Feb. 12th. Cal, the proud father, insists that it sounded just like "CQ-Five" to him! W1LTF, Cal's brother-in-law, had been listening on Five for more than twelve hours for the glad news!

If you W4's and W9's miss W1KEE in the group of W1's you work the first time the skip breaks on Five, look for a familiar voice signing W1AZ. Yes, you guessed it, George is another of those old-timers that the ultra-highs brought back to amateur radio. Many years ago he had that call and now has it again. Congrats, George, but it'll take the gang a long time to forget "W1KEE"! As this is being written, W1AZ is just about ready to christen a new rig. With up to 350 watts to a pair of 35T's, a.m.c., and an 8-element rotary beam, W1AZ will put East Longmeadow, Mass., on the map in short order.

Over Albany way, W2FBA seems to be holding forth alone these days. With 500 watts and up to a pair of 100T's, Bob is doing all right. He works W2MO (130 miles, over rough country) quite regularly. Interest in u.h.f. work seems to be picking up over there and Bob may have company on Five

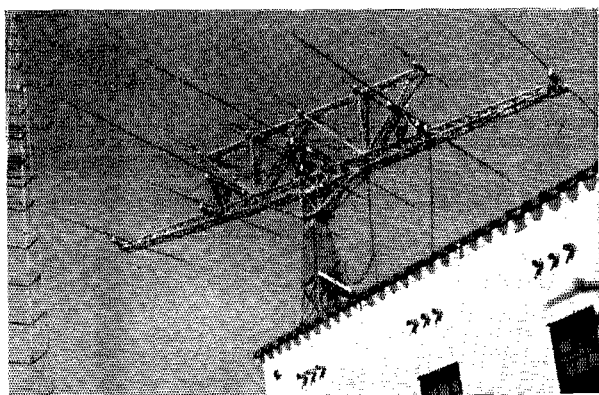

The composite beam at W4EDD. Top section is a 5-element 1/4-wave spaced affair for 56 Mc. The bottom section is a similar type for 28 Mc., while in the center is a 3-element close-spaced array for 14 Mc. The entire structure, complete, weighs only 187 lbs.!

QST for

◆
W4EDD in 1940 dress. Five 66-inch racks contain separate kilowatt rigs for each band from 28 Mc. up. The u.h.f. apparatus is in the two sections on the left side and consists of separate 500-watt transmitters for 56 and 112 Mc. The operating position includes speech amplifier and transmitting 'scope at the left, with recording amplifier and receiver 'scope at the right. Receiver is a DM-36 converter ahead of a DB-20-69 combination.

◆

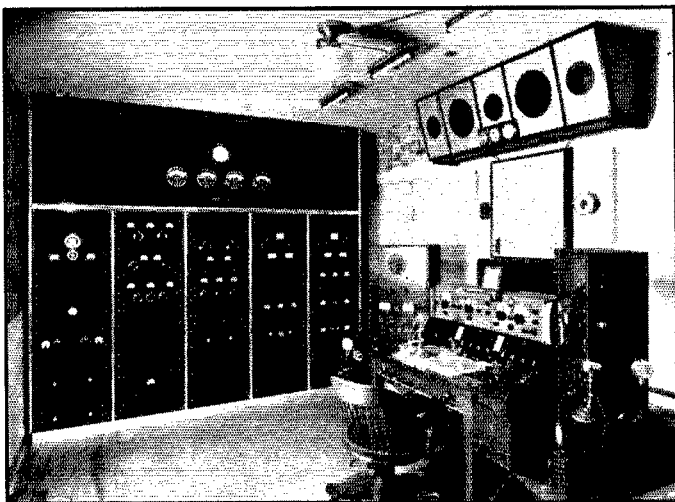

soon. **W2FBA** reports hearing a harmonic of **XDA** on Dec. 17th.

W2MO's nightly skeds with **W1's** **LFS**, **LLL**, and **AZ** have not been going quite so well during February, though on several nights good contacts have been made. In the absence of **W3DBC**, **Earl** is maintaining regular skeds with **W3IIS** of Catonsville, Md., with contacts made on a fair percentage of the attempts. Signals over this path, and those of the **W1's**, have frequently had the familiar "flutter-fade" recently.

Activity in **W3** seems to be picking up all along the line, if the number of new calls appearing in the various Marathon reports is any indication. **W3BYF** sticks by his post valiantly, though with his poor **QTH** (low elevation 100 feet from heavily-traveled Route 22) **Pres** says that when he "works" a station he means just that! The rig is a pair of **T-20's** at 75 watts; while a 954 concentric line r.f. stage working into an 1851 conventional r.f. and **6K8** mixer (with oscillator on 28 Mc.) comprises the "business end" of the receiver. **Pres** wants to try some form of tilted antenna on skip this spring as he is of the impression that some of the sigs of this type must come almost straight down in order to get into the valley at Allentown.

At Alexandria, Va., **W3EIS** hopes that about one more box of cigars for the janitor will turn the trick in overriding the ruling against tenants being allowed on the roof, whereupon the sigs of **W3EIS** may cover a wider area than at present.

We are pleased to note the success of **W3FJ** and **W3CYW** of Richmond, Va., in extending the relay route 100 miles farther south, by establishing contact with Washington, D. C. Keep at it, boys, and try to promote activity still farther south in the hope of ultimately contacting the fellows in Georgia and Florida.

From the appearance of the new **W4EDD**, shown in the accompanying photos, we should be hearing plenty from **Robbie** most any day now. Note that 5-element full-spaced horizontal rotary. **Robbie**, with **W9ZHB**, is definitely against this business of "taking his standing up."

For sheer perseverance we award the medal to **Vance Dewey**, **W5FYF**, who stays with **Five** regularly, signals or signals! Nothing whatever was heard in Oklahoma City during the entire month of January. We hope that February was more promising, **Vance**, though from what we've heard from other sections of the country thus far, there has been little encouragement for the unfortunates who must depend upon skip-DX this month, either. Your day will come, ere long, however — May is not far off!

Most of the u.h.f. reports from the sixth call area tell of goings-on on 112 Mc., with little mention of 5-meter work. **W6BPT**, Santa Clara, Cal., reports that **W6QLP** (**HK-54's**

and converter-**SX-24**), **W6LZL** (807 and r.c. super), and **W6LNS** (**HK-54's** and **SX-16**) are active each Thursday evening between 7:30 and 9:30 p.m. local time. They stand by each quarter-hour to listen for other stations. Thus far **W6LZL** is the only one of the group who has succeeded in working other than locals, having contacted **W6RZC** in San Francisco from San Jose on **Five**.

W6OVK, Tucson, Ariz., talks up **Five** to everyone he contacts on other bands, and counts **W5VV** as one of his best prospects to date. **Wilmer** has a **DM-36** and promises to be on **Five** some time soon.

In East Bloomfield, N. Y., **W8PK** heard **W8QDU**, Detroit, during the contest from 6:58 to 7:30 Saturday night. This is a 300-mile jump and would have looked pretty nice in the Marathon box score. Better luck next time!

W8QQS tells us that **W8QDU** got up from a sick bed to take part in the relay and fill an important gap. He says of **Fred**: "His voice wouldn't work, but he sure cuffed the key to beat the band!" **W8QDU** maintained skeds with **W8NYD**, Kent, Ohio, and **W8CVQ**, Kalamazoo, Mich., both long hops, throughout the contest.

W8RFW, Grand Rapids, Mich., lost his beam in a high wind just a few days before the contest. By some heavy night work he got a new 4-element horizontal array up and set to go by Saturday afternoon. Sigs all seemed to be 'way down until one feeder was disconnected. This brought them well up, so he promptly re-erected the beam in a vertical position. This move brought all signals up above any previous experience. **Victor** has definitely joined the ranks of those who "take theirs standing up." The new array at **W8RFW** uses tenth-wave spacing, with one reflector and two directors. The feeders are inductively coupled to the radiator. This array replaces a 4-section "8JK," with improved results.

From the "horizontal champion" (**W9ZHB**, not **Phil Scott**) comes a breezy story that we'd like to print in its entirety if space permitted, but with the large amount of dope on hand this month a few quotes will have to suffice. "In the East you have your **Horsestraders**, **Minutemen**, and other networks. Here in Illinois we have our 'Pink Network' — not red or communistic in any form — just slightly 'pink' towards accepted (?) theory we can't take. Having our own peculiar problem to lick in working over the flat land which is characteristic of the Middle West, we went to work with a will and have seemingly had a fair measure of success." The success of the "Pink Network" (**W9's** **ARN**, **RGH**, **WOQ**, **CBJ**, **WIV**, **ZEB**, and others) in working out with horizontal antennas is well known. Their daily skeds have helped greatly to maintain year-round interest in the area around the Great Lakes.

(Continued on page 80)

Application of Transverse Phase-Shifts to Amplifier Design Problems Involving Fortuitous Feedback Paths

BY J. K. BACH,* W4CCE

THE employment of neutralizing voltages to solve certain adhesive problems incident to vacuum-tube applications ranging from magic

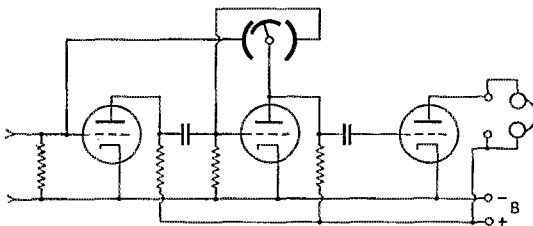

Fig. 1 — Phase-shifting bridge network for neutralization of grant feedback.

eye indicators to pin-ball machines according to the formula:

$$E / \phi \div e \phi / - 180^\circ = 0$$

where E is the interfering electromotive force and e the opposing voltage, is of a comfortable antiquity, comparatively speaking.

When the present writer was but a child it was quite the accepted practice to eliminate oscillation in resistance-capacity coupled amplifiers by means of a phase-shifting bridge network, the special variable-condenser element of which, in fact, closely resembled one used in a bridge circuit in a modern receiver. See Fig. 1.

Additionally, C. D. Tuska's "Superdyne" circuit, the revolutionary labyrinths of Messrs. Rice and Hazeltine, as well as the experience of thousands and thousands of constructors who got their ticklers backwards, emphasizes the efficacy of this classic technique.

At some slight risk of becoming redundant, the direct-coupled audio-frequency amplifier due to Loftin and White employs the same principle. In fact, if you want to give credit where credit is due, Wheatstone is to be thanked for the peeka-booo method of keeping stray voltages put.

Hughes, of "induction balance" fame, comes in for his share of credit also, but let us take up the work of contemporary scientists, notably Black, of the Bell Telephone Laboratories, who took a

distinctly miscellaneous aggregation of components and produced an amplifier so flat in frequency-gain characteristics that no one believes it even at this late date.

Quite obviously, this principle, but 67.3% less generally applicable than that of gravitation, can be used over and over again for invention purposes, and there is no very good reason why the writer — and indeed, the Public At Large, cannot invent it also.

The selection of something to invent is simplicity itself — two minutes listening to any frequency in the radio spectrum all but forces the selection of selectivity as the problem to embark upon. That is to say, instead of the flat frequency response obtained by Black, we desire quite the opposite effect. Positive re-

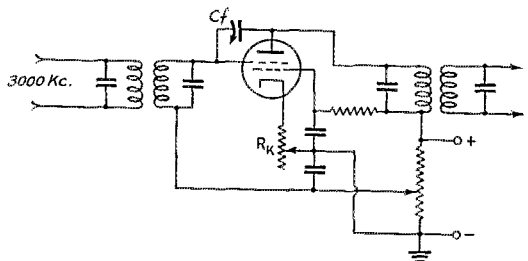

Fig. 2 — An amplifier of great flexibility is provided by incorporating both positive and negative feedback as shown above. The various types of circuit response obtainable are shown in Fig. 3.

generation is commonly employed to make tuned circuits sharper. However, tube conductances and connecting circuit losses as well as resonant-circuit resistance losses prevent the sides of the frequency-response curve being quite as precipitous as we might wish.

There is, however, another line of attack: If we cannot increase the peak voltage at resonance beyond a given point, we can increase the losses at a range of frequencies either side of the resonance point; which, in fact, amounts to the same thing in the end, discounting the lesser gain obtained, which is of little practical importance. Naturally, on each side of resonance there is one

* P. O. Box 2902, Miami, Fla.

Despite the formidable-sounding title and the rather "technical" appearance of the circuits and graphs, the author's unusually lucid style will make this article just as clear to the raw beginner as to the most advanced engineer. The results are astonishing.

definite point where the algebraic sums of regenerative and degenerative voltages is equal to zero. This corresponds to a feedback phase of 90 degrees with its implication of so-called "wattless power," or zero power factor: At this point, the resonant circuit voltage is solely that due to the input to the circuit. This point should, of course, be as near resonance as possible, in the interest of selectivity.

The simplest method of reverse-feedback having sufficiently flat frequency characteristics is the un-by-passed cathode-resistor method, and this we may employ. In order to use standard parts in our amplifier, which might best be an intermediate-frequency one of, say, 5,000 kc. for use in a communications-type superheterodyne, we shall also use the so-called tuned-plate-tuned-grid circuit for the positive feedback, together with an auxiliary variable air-condenser between control-grid and plate of the tube. In accordance with the above, an experimental amplifier was built up using the circuit shown in Fig. 2, curves for which are given in Fig. 3.

Note that the negative-regeneration cathode resistor R_k is un-by-passed, and that the inclusion of a voltage divider to provide a positive bucking potential for the grid, permits increasing R_k to all but fantastic levels without allowing the input grid to reach the cut-off point; this results in so much degeneration, with the grid at the rated bias, that as much as 13 $\mu\text{fd.}$ may be necessary at C_f to secure oscillation.

Actual tests gave rather startling results. Whenever R_k was increased beyond about 522 ohms, even when C_f was increased to the oscillation point, nothing whatever was received. After much retuning, it was discovered that the carrier

frequency used in the test had to be left on the exact resonant frequency of the amplifier for at least nine seconds before the sidebands due to switching the test frequency on an off (even at the slowest possible rate) would permit the carrier to get through. Calculations too abstruse to include here indicated that the sideband width of the amplifier was but 0.000000037 cycle under these conditions. Less feedback, with consequently wider sideband response, will probably obtain in actual commercial practice.

* * *

(Editor's Note: It is noteworthy that, for some occult reason, revolutionary developments of this type are frequently — in fact, almost invariably — disclosed in the month of April. Perhaps some of our readers can fathom this mystery.)

Strays

W1AIZ, W1IIM, W1IBS and W1IXL, vacationing in New Hampshire with a 500-watt rig as company, rose to meet the emergency created when their Zepp tank condenser failed. With the aid of two tin pie plates, two glass plates from picture frames and a pint of water, the problem was quickly solved. The first pie plate was placed on the table upside down; the two glass sheets served as the dielectric and the second pie plate rested on top and was filled with water to provide cooling to compensate for heating of the iron pie plates.

This condenser served as part of the 500-watt, 75-meter 'phone rig for the two weeks' vacation during which 200 contacts in 32 states were made.

W1LDD, who is an undertaker, uses his embalming tools to work in tight corners of his u.h.f. gear — W1LAQ.

VE2CN points out that tickler-type beat-frequency oscillator units for battery-tube circuits, sometimes difficult to find, can easily be made from the e.c.o. type by scramble-winding a feedback coil of 15 or 20 turns on the same core near the regular winding.

Fig. 3 — Experimental response curves with the amplifier of Fig. 2. (A) no regeneration or degeneration; (B) regeneration only; (C) critical combination of regeneration and degeneration. Reproduction difficulties make it impossible to do justice to the actual (C) curve, since a graphic line has to have some thickness.

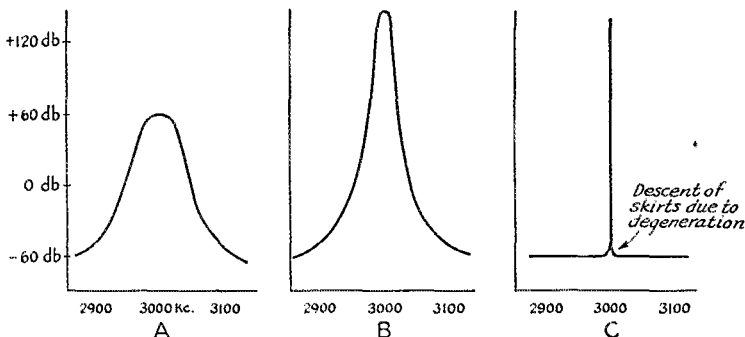

☆ HAM SHACKS ☆

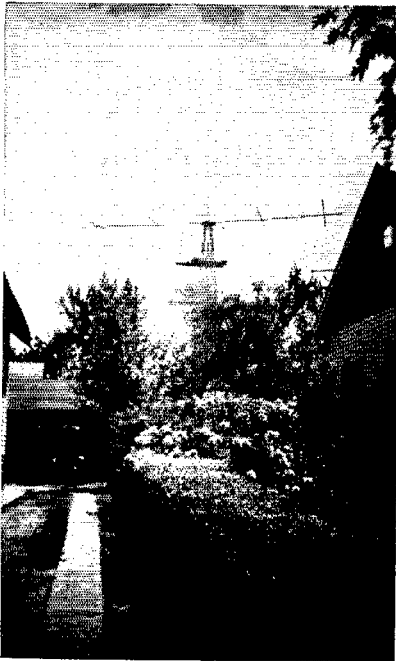

← W8KSL'S Rotary Antenna

↘ W2ELN, Jamaica, N. Y.



W9ZVO, Chippewa Falls, Wis. →

W3EIM, Baltimore, Md. ↘

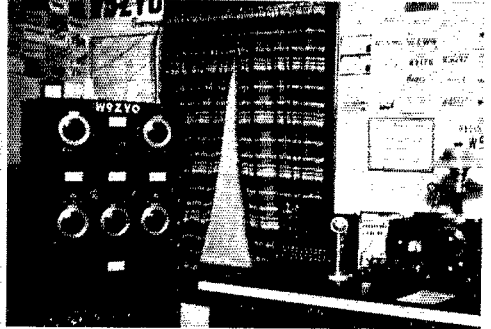
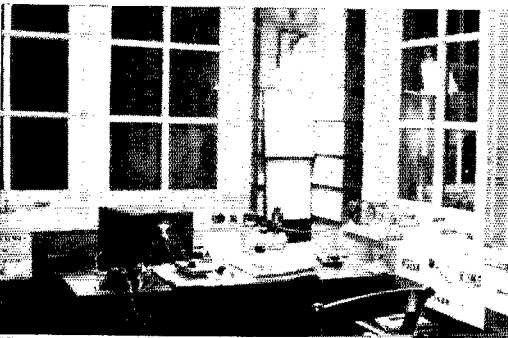

Lower Left — W6MQF, Santa Ana, Calif.

Lower Right — W8KSL, Hazel Park, Mich.

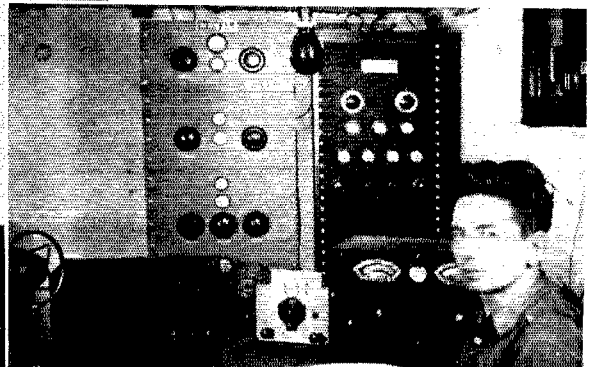
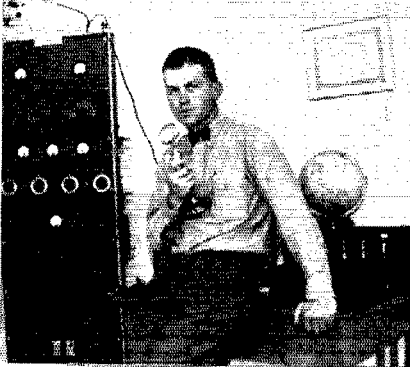

W2ELN

NORWOOD BRADSHAW, pre-war IESP, now operates W2ELN at Jamaica, N. Y.

The transmitter is built into an old army transmitter panel and frame which was picked up several years ago. A 6L6G is used in the crystal grid-plate oscillator circuit. This is capacitively coupled to a pair of 10's in parallel, running at 100 watts input, which may be modulated by Class-B 46's. A single 57 triode speech amplifier provides enough gain for the single-button carbon mike to swing the Type 10 driver.

A single-ended pi-section antenna coupler is used. This is coupled to the final tank with a link line, one link at the center of the final tank and the other link wound around the input end of the antenna coupler coil. This arrangement has worked out very satisfactorily with several single-wire antennas.

The receiver is a seven-tube Hallicrafters to which several improvements have been added. A control system has gradually been worked out which permits smooth and convenient operation of the station with the least amount of effort.

While he frequently works 160 'phone, W2ELN spends most of his time on 80 and 40 c.w.

W3EIM

JOHAN CANN, W3EIM, is a newcomer to the ranks of ham radio. Nevertheless, since receiving his license less than a year ago, he has done quite well for himself with his low-power rig. He has worked 43 states with confirmations from 41 as well as CM, K4 and K6.

The station is located in a convenient corner of the sun parlor. The transmitter is the "QSL 40," described in *QST*, with a single 6L6G. It is link-coupled to the antenna tuner near the window at the right. The antenna is a 66-foot end-fed Zepp. The receiver is the SW-3 with Brush 'phones.

Only two operating frequencies are used at the present time — 3717 and 7185, the former being used most of the time.

John is planning to build a new all-band rig soon with a 200-watt final.

W6MQF

W6MQF at Santa Ana, Calif., is owned and operated by Earle Kent who is employed in the Postal Service.

The transmitter is a neat rack-and-panel job. The r.f. line-up consists of a 6A6 crystal oscillator, T20 buffer and a pair of 35T's in the final which usually operates at 300 watts input. The modulator starts with a crystal mike and 57-56-56 speech amplifier and ends up with Class-B TZ40's. A pair of Class AB 45's is used as the driver for the modulator. The speech amplifier is on the operating desk and is connected to the driver through a 500-ohm line running over to the modulator in the rack.

The receiver is a Philco 11-tube superhet with a built-in beat oscillator. The antennas include a 2-element 14-Mc. rotary.

The 7-Mc. and 14-Mc. bands are his favorites, although he works 3.5 quite frequently. Although WAC has been made several times, W6MQF likes a good old rag-chew with anyone who can shoot the breeze interestingly.

W8KSL

ARTHUR CLARKSON has built his station in the basement where it's warm in winter and cool in summer.

The transmitter is in the rack to the left. A 6A6 crystal oscillator drives a push-push 6L6 doubler which is followed by a push-pull HY25 driver. Push-pull HK54's are used in the final which is operated at 500 watts input. All stages are link coupled. The final is modulated by a pair of Class-B T55's driven by push-pull 6L6's. The Shure 70S mike feeds a two-stage speech amplifier employing a 57 and 56.

The speech amplifier is on the operating table beside the Patterson PR10 receiver and regenerative preselector.

The two-element rotating antenna is shown in the photograph to the left. The elements are made of $\frac{3}{8}$ -inch diameter copper tubing. The antenna is fed with a 600-ohm line and delta-matched.

The rack to the left contains the rig of W8PAA who occupied the same shack for a time.

W9ZVO

EARL STRUVE's transmitter is built up in an enclosed rack. It covers all bands from 23 to 3.5 Mc. The push-pull HY40 final amplifier is operated at 200 watts input on 'phone or c.w. It is modulated by Class-B HY 40Z's. A Turner crystal mike is used.

The receiver is an NC101X which was won as first prize at last year's A.R.R.L. Dakota Division Convention.

Operation is confined chiefly to 'phone work in the 14- and 28-Mc. bands. On these bands vertical half-wave antennas of pipe are used.

Strays

In a splendid story of the fascinations of amateur radio appearing recently in a non-radio magazine, the editor (not the author) captions one of the illustrations: "The antenna towers for the station are suspended 110 feet above the ground." Quite an idea if you can work it!

—••••—

In low-power transmitter stages or in receivers, short lengths of glass tubing, fire-polished at the ends, make a good-looking form of insulation for wires passing through metal sub-bases.

— W7TQ



HINTS AND KINKS FOR THE EXPERIMENTER



AN INEXPENSIVE 50-FOOT ANTENNA MAST

A LITTLE over three years ago, I built a 50-foot mast which has withstood weather so well that I feel that constructional details would be of interest to others. The type of construction shown in Fig. 1 has the advantage that the mast is extremely strong, although light enough in weight to make erection easy. Material for the

mast should be obtainable for about \$10, plus or minus, depending upon where you happen to live in respect to lumber country.

The bottom section is a 26-foot "6 by 6" of selected Douglas fir. The center section is the part which differs from the usual types of construction. Four 22-foot strips of 1 1/4-by-3-inch spruce stock are used to form a martingale structure. The four strips are spread at the center by an octagonal piece (or square piece if you don't want to bother to cut off the corners) 2 inches thick and measuring 10 inches across. The strips are fastened to this piece with lag screws.

The top section is made up of two pieces of 1 1/4-by-3-inch spruce bolted together with 3/4-inch bolts. Eye bolts should be used at the top for fastening guy wires and pulleys.

Before assembling, the pieces should each be given three or four coats of good lead and oil paint. The center section is bolted to the bottom section with 3/4-inch carriage bolts 9 inches long with large malleable iron washers at each end. The sections should overlap 4 feet.

The top section is fastened to the center section in a similar manner with an overlap of 4 feet. Here, also, some of the bolts should be eye bolts for fastening guy wires.

Although it has not been found necessary, weakening of the joints by the drilling of bolt holes could be avoided by the use of clamps made up from heavy iron strap as shown in the detail drawing. Two of these clamps could be used at the top and bottom of each joint, the open end of each clamp facing in a different direction. Similar clamps could be used for fastening the guy wires and pulley.

The mast is sufficiently rigid and light so that it may be assembled on the ground and raised into position in one piece. The easiest way is to use a 20-foot gin pole and pull the mast up into position with block and tackle. After raising, the mast is plumbed up and the bottom braces set in place.

The mast was used for over two years with no guy wires at all and stood up well under severe winds which took down two "A-frame" towers with three sets of guy wires. Guys were finally used to prevent

the top swaying in heavy winds. I believe it would be practical to extend the height of the mast to 70 feet by the addition of a

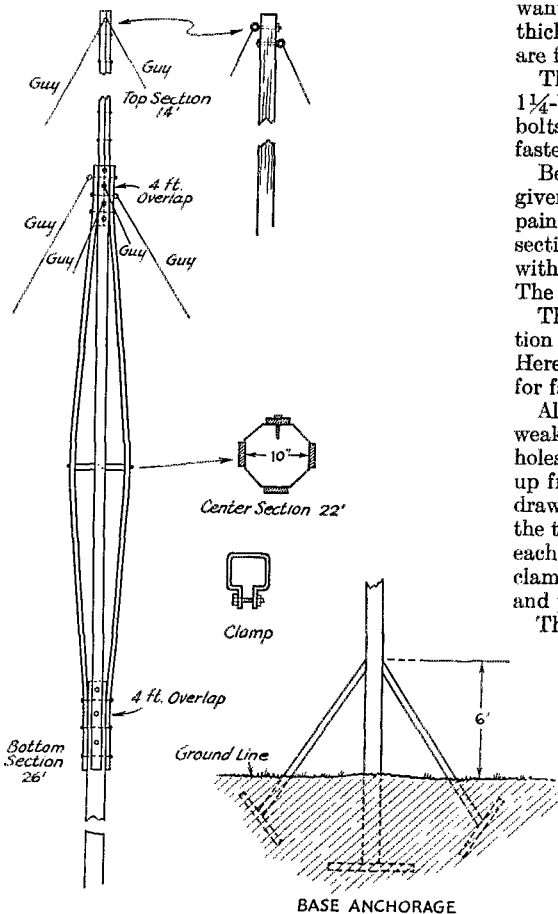

Fig. 1 — W6PGB's 50-foot mast which may be built for about \$10. The martingale section at the center combines strength and light weight.

second martingale section, if desired. The added length would, however, increase the raising difficulties and require an additional set of guys.

— Rex Reinhart, W6PGB.

NOTES ON GASEOUS TUBES AS BIAS REGULATORS

I NOTICED one thing in connection with McCullough's article on page 54 of the February issue of *QST* that might be worth checking in case trouble is experienced with one of the details of the transmitter. In order to simplify the bias problem, McCullough indicated that type VR-105 and type VR-150 voltage regulator tubes might be used and advantage taken of the constancy of drop across these tubes. I have tried similar arrangements using gas tubes for providing bias and find that they work out very nicely provided the current through the tubes is fairly high, that is, close to the current limit for the tubes. At very low currents, such as are indicated as satisfactory in the article, the tubes are inclined to oscillate and would, under oscillation, modulate the transmitter.

Another use to which gas tubes have been put, has been fixed bias in 6L6 amplifier work. The OZ4 tube has a constant drop of about 23 or 24 volts and if the current for a 6L6 stage is passed from cathode to ground through an OZ4, a constant bias voltage is developed. This looks perfect on paper and in some tests that I have seen in amplifiers, works perfectly for about an hour with this arrangement and then breaks out in noise produced by oscillation in the gas tubes. The use of gas tubes for these purposes simplifies construction a great deal but the user should bear in mind that he may get into oscillation trouble which will be eliminated only by some rather tricky filtering and on the whole the arrangement looks better on paper than it actually works. — R. M. Purinton, W2ICU.

MORE ON HOMEMADE FEEDER SPREADERS

THE article on homemade feeder spreaders by W8QZP which appeared in the *Hints and Kinks* section of *QST* for December has prompted W7DES and W7KKK to describe variations in the idea which each has found satisfactory.

W7DES uses 9-mm. neon-sign tubing cut in 6½-inch lengths. Rather than to use sealing wax to tie the feeders down, he heats the end of the tubing in a gas flame until a quarter-inch at the end is red. Before it has a chance to cool, he presses it against a flat surface, making a bulge on one end. Then, heating the end again, he makes a V-shaped notch across the end by pressing against a small bar. The bulge allows a wire or cord to be tied behind it and the wire running through the notch may be securely tied down. The finished spreader is shown in Fig. 2A.

W7KKK cuts his glass tubing in lengths of about

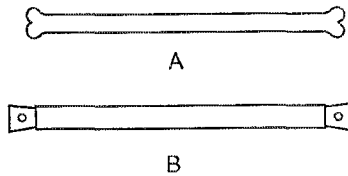

Fig. 2 — Homemade feeder spreaders made from glass tubing by W7DES (A) and W7KKK (B).

5½ inches. He then obtains rubber corks to fit the tubing and drills wire holes in the corks to fit the feeders. After the corks have been threaded onto the feeders like beads, he inserts them in the ends of the glass-tubing sections as shown in Fig. 2B, and seals the tubes with waterproof cement. Usually the corks will stay on the wire in place without tying.

SUPERHET B.F.O. AS CODE PRACTICE OSCILLATOR

I've discovered a little kink for my Sky Buddy, S19R which doubtless may be applied to other superhets. I wanted some means for code practice, so I changed the b.f.o. circuit as shown in Fig. 3. As may be seen, the only changes made were to disconnect the ground connection from the cathode of the b.f.o. tube and connect the cathode to the ground through a variable 50,000-ohm resistor and a closed circuit jack. To reduce key clicks, a condenser of 0.02 μfd. is put across the jack.

This set-up gives four possibilities:

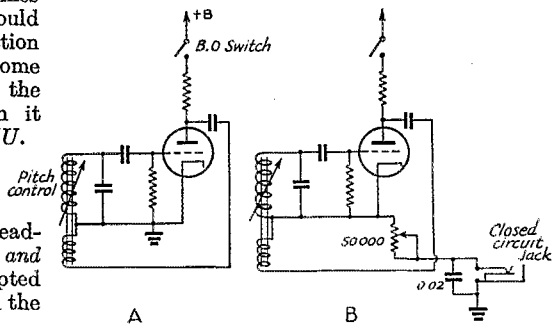

Fig. 3 — Simple method of converting superhet beat oscillator for code-practice use.

(1) With the key out of the jack and the auxiliary pitch control at its lowest resistance, the set is unchanged from its original performance.

(2) With the b.f.o. switch on, the auxiliary pitch control at lowest resistance and the key in the jack, the set is tuned until the b.f.o. heterodynes with any unkeyed c.w. signal, and the key can be used for code practice. The pitch of the note is varied with the regular pitch control. This gives a musical note.

(3) With the same set-up as in (2) the b.f.o. can be heterodyned with a broadcast carrier, and the program can be enjoyed while the code practice is going on.

(4) The set is tuned to a dead spot on the dial, and at a spot where there is a minimum of static. With the key in the jack, the auxiliary pitch control is advanced until it increases the grid to ground resistance of the b.f.o. tube, to the point that the circuit goes into self-modulation. The note, which is more of a buzz than a musical note, is varied in pitch with this control.

This makes a very handy arrangement for code practice. Most hams have the necessary parts in the junk box and the only change made in the panel is the addition of a key jack and a small knob. This change could probably be easily made on almost any set having a separate b.f.o. circuit.

— Calvin B. Simmons, 1st Lt., Air-Res.

METER SWITCHING WITH TOGGLE SWITCHES

FIG. 4 shows various circuits of a simple and safe meter-switching system which requires nothing more than a s.p.d.t. toggle switch to make a single milliammeter serve for checking two circuits.

In A, the meter and switch are connected so that either grid current or plate current of the same stage may be checked. When the switch is thrown to the left, the meter reads grid current; when thrown to the right, it reads plate current.

Circuit B shows connections for two meters. The first reads grid current of either doubler or final, while the second reads plate current of either stage. As the circuit is shown, both doubler and final tubes may be operated from the same filament transformer, but separate high-voltage supplies are required. In the arrangement at C, separate filament transformers are required but both stages may be operated from the same plate supply. In each stage, grid return should be made to filament center-tap rather than to ground. It will be noticed that neither the meter nor the

switch is at high potential above ground in any of these circuits.

The meter-shunting resistances should be 10 to 25 ohms each if no scale multiplication is desired. If a change in the meter range is desired, when switching from one range to another, the shunting resistances may be adjusted to give the desired multiplication. If the resistance of the meter is known, the shunting resistance required to give the desired multiplication may be calculated by the following formula:

$$R = \frac{R_m}{n - 1}$$

where R is the shunt resistance, R_m the resistance of the meter and n the scale multiplication factor. The required resistance may also be determined experimentally by connecting the meter in series with a low-voltage battery and rheostat and adjusting the rheostat so that the meter reads full scale. Various shunt resistances then may be tried across the meter terminals until one is found which will cause the meter reading to fall to that fraction of full-scale deflection which is the reciprocal of the multiplication factor desired. The meter reading should fall to $\frac{1}{10}$ for a multiplication of 10, to $\frac{1}{5}$ for a multiplication of 5, to $\frac{1}{2}$ for a multiplication of 2, etc. In all cases the resistances should be of adequate current rating to prevent any possibility of burning out under heavy overload. In most cases, it will be practicable to make multiplying resistances from copper wire.

— Howard E. Gullberg, W5GGS

Strays

The insides of old automobile (Chevy) steering posts make good material for a self-supporting antenna. These are the tubes used to control the spark, throttle and horn. The ones I got had three telescoping sections totaling 12 feet.

— W9EVD

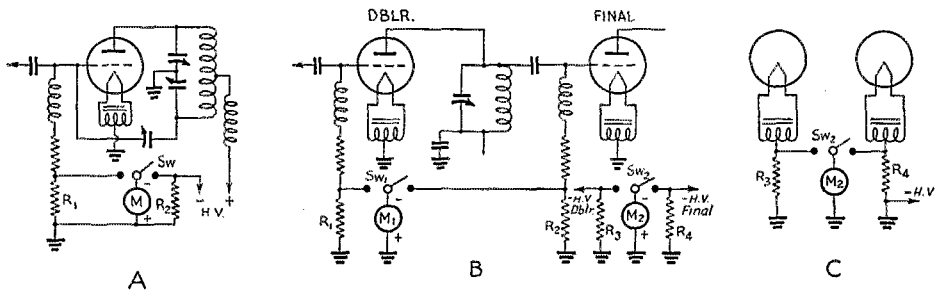

Fig. 4 — Toggle-switch meter switching. A — Circuit for switching meter from grid to plate circuit of same stage. B — Circuit for switching grid meter between two stages and plate meter between two stages. C — Alternative circuit similar to B in which separate filament transformers permit common plate supply. R_1 and R_2 are grid shunts, while R_3 and R_4 are plate-circuit shunts.

★ I. A. R. U. NEWS ★

Devoted to the interests and activities of the

INTERNATIONAL AMATEUR RADIO UNION

Headquarters Society: THE AMERICAN RADIO RELAY LEAGUE, West Hartford, Conn.

MEMBER SOCIETIES

American Radio Relay League
Asociatia Amatorilor Romani de Unde
Scurte
Associazione Radiotecnica Italiana
Burma Amateur Radio Society
Canadian Section A.R.R.L.
Ceskoslovenski Amatérni Vysilac
Deutscher Amateur Sende-und-Empfangs
Dienst
Festl Raadio Amatooride Uning
Experimental Radio Society of Egypt
Experimenterende Danske Radioamatorer
Federation des Emetteurs Belges
Irish Radio Transmitters Society

日本アマチュア無線聯盟 Japan
Lietuvos Trumpuju Bangu Radio Megeju
Draugija
Liga Colombiana de Radio Aficionados
Liga Mexicana de Radio Experimentadores
Magyar Róvidhullámú Amatőrök Országos
Egyesülete
Nederlandsche Vereeniging voor Interna-
tionaal Radioamateurisme
Niederlandsch-Indische Vereeniging Voor
Internationaal Radioamateurisme
Newfoundland Amateur Radio Association
New Zealand Association of Radio Trans-
mitters
Norsk Radio Relæ Liga

Polski Zwiasek Krotkofalowcow
Radio Club de Cuba
Radio Club Venezolano
Radio Society of Great Britain
Rede dos Emissores Portugueses
Reseau des Emetteurs Français
Reseau Luxembourgeois des Ama-
teurs d'Ondes Courtes
South African Radio Relay League
Suomen Radioamatöörlitto r.y.
Sveriges Sändareamatörer
Unión de Radioamsores Españoles
Union Schweiz Kurzwellen Amateurs
Wireless Institute of Australia

WAC

THE I.A.R.U. issued during 1939 a total of 762 WAC certificates, compared to 958 the previous year. Of these, 571 were for c.w. work and 191 for 'phone, the same ratio as in 1938. It is perhaps worthy of note that in 1938 there were 46 endorsements showing all contacts made on 2S Mc., but only half that number this past year.

We recently had occasion to check back into the early files of the WAC club, and spent an interesting few minutes reading the names of those pioneers of DX — in the days when the WAC certificate adorned the walls of but a few mighty stations in the world. Recipients of certificates numbers one and two, issued in April, 1926, were Brandon Wentworth, nu6OI, and the late Clair Foster, nu6HM. Among early WACers, those who still hold the same calls (or their equivalents after prefix changes) are: Don Wallace, nu9ZT and nu6AM; Jefferson Borden, nu1CMX; John Grinan, nj5PZ; 12th Signal Company, op1HR; Hilton O'Heffernan, eg5BY; H. Cooley, nu1AAO; Neville Shrimpton, oz4AO; F. McKeever, nu9DNG, and Jack Berliant, nu2APV.

By the way, a couple of months ago we mentally prophesied that with disrupted international conditions the issuance of WAC certificates would drop off to almost nothing — but we were somewhat wrong. True, that has happened in the case of applications, from affected countries, but not so much with those from the Americas. It seems that many amateurs here have already worked and received cards from five continents — the elusive one, as always, being Asia. Since that continental division is still well represented on the air and since DX enthusiasts can concentrate more than ever before on that objective, many

of them are achieving the award. But the total number of applications is now about one-third that of a year ago.

GERMANY

WE excerpt the following from information received from Chris Schmelzer, D4BIU:

"There seems to be a widespread misunderstanding concerning the activities of German amateur stations to-day. According to a statement made by our government, all sport activities, etc., will be continued during the war to as large an extent as possible. Due to this, amateur stations D4ACF, D4ADF, D4BIU, D4BUF, D4RGF, D4TRV, D4WYF, D4HCF and D4DKN have been relicensed recently. More licenses will follow shortly. The stations are

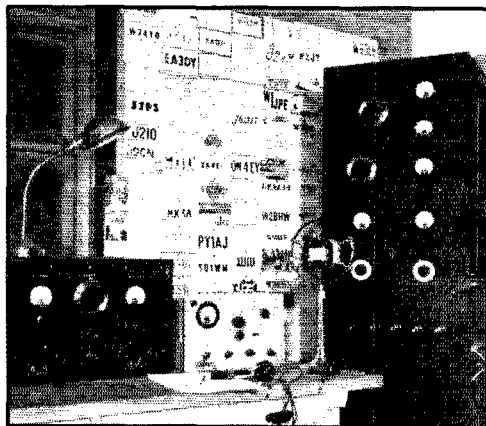

MX3H, station of Sakae Tamogami, Manchoukuoan QSL Manager. The two superheterodyne receivers and 6L6-807-803 transmitter are home-built.

supposed to carry on strictly in the usual manner. Please notify all interested."

QSL BUREAUS

THE following addition and change should be noted by all societies:

Cuba: James D. Bourne, CM2AZ, Arbol Seco No. 102, Havana.

Manchoukuo: Sakae Tamogami, MX3H, P. O. Box 30, Shinkyo.

NEWS AND NOTES

Australia: The *Wireless Association of Australia* is taking a census of its amateurs to ascertain the degree of national effort of which they are capable and to gain knowledge of amateur participation in the armed services. Government authorities declined the association's plea for the issuance of licenses to operate on the u.h.f. bands, but officials say another petition will be made shortly. They are also asking permission for an official amateur station for each state, to operate in the 7200-7300 kc. territory and transmit headquarters news, etc., to the membership.

Cuba: CO2WL tells us that their government intends to delete the amateur 'phone prefix "CO" sometime in June, and apply the prefix "CM" to all Cuban stations, c.w. and 'phone alike.

Great Britain: An order issued by the PMG department, designed to prevent assembly of radio transmitters by unauthorized persons, makes it an offense for a person to have in his possession without a permit, "wireless components capable of being assembled into a transmitter." British amateur gear seized by the government has been carefully stored, for return to its owners upon cessation of hostilities.

Mexico: Mexican nationality is a requirement for amateur licenses with the exception of those wishing to operate on the u.h.f. bands, 10 meters and below; these are considered experimental bands and residents of Mexico, not necessarily citizens, can secure permits to operate.

South Africa: The S.A.R.R.L. is still operating its official headquarters station with Sunday morning broadcasts of news items, headquarters notes, etc. Amateur licenses are being cancelled as they expire, since for the most part they are joint licenses authorizing both an amateur station and ownership of broadcast receiving sets. Duly authorized officers have the right to seal radio apparatus, the use of which has been suspended or in respect of which a permit has been disallowed.

U. S. A.: We are skeptical about the statement appearing in an American contemporary stating that all PK stations have been closed down — especially when it says the action was taken by the *British* government!

★ New Receiving Tube ★

6S6GT

SYLVANIA announces the addition of another tube to the bantam series. The 6S6GT is a remote cut-off r.f. pentode featuring high mutual conductance and low output capacity. The control grid is brought out to a cap at the top of the tube. Ratings and characteristics follow:

Heater voltage.....	6.3
Heater current.....	0.45 a.
Plate voltage.....	250 max.
Screen voltage.....	100 max.
Grid voltage.....	—2 min.
Plate current, ma.....	13
Screen current, ma.....	3
Mutual conductance, μ mos.....	4000
Amplification factor.....	1400
Plate resistance.....	350,000 ohms
Control-grid voltage for S_m of 20 μ mos.....	—30
Interelectrode capacities:	
G1 — Plate.....	0.01 μ fd.
Input.....	7 μ fd.
Output with tight-fitting shield.....	6.4 μ fd.
Output without shield.....	4.6 μ fd.

Silent Keys

IT is with deep regret that we record the passing of these amateurs:

Orville O. Benbow, W9DUK, Muncie, Indiana

Elmer R. Gabel, W3CHG, Kennett Square, Penna.

J. W. Hamilton, G5JH, Hardwicke, Glos., England

Frank Herbert, VP4TF, Port of Spain, Trinidad

L. V. Jolliffe, W3DQD, Winchester, Virginia

Les. M. Mellars, ZL1AR, Auckland, New Zealand

Arnold K. Neilsen, W2BSE, Perth Amboy, N. J.

Ramon F. Parrott, Sr., W5GEH, Abilene, Texas

R. E. Powell, W8GWF, North East, Pennsylvania

Charles H. Robinson, W9WLL, Winnetka, Illinois

Marvin L. Roy, W5BJG, Sulphur, Oklahoma

F. E. Royal, Jr., W3HGK, Newport News, Virginia

Warren R. Rudd, W9QGX, Sidney, Nebraska

Dorothea Stoops Taylor, W6QPT, Oakland, Calif.

George Thorson, W3NL, Dover, N. J.



CORRESPONDENCE FROM MEMBERS

The Publishers of *QST* assume no responsibility for statements made herein by correspondents.

A LETTER TO CANADIAN AMATEURS:

169 Logan Ave., St. Lambert, P. Q.

Editor, *QST*:

Although I have had the privilege and honour of representing the Canadian members of the American Radio Relay League for a good number of years, it has never before been necessary for me to seek their attention exclusively through the medium of a letter to *QST* and, while the sentiments to be expressed in the following are directed particularly to the Canadian amateur radio fraternity, they apply to all "Hamdom," and it is my sincere hope that the message will be taken to heart by all and sundry.

In Canada, as in several other countries, ham radio licenses have been suspended due to the current fracas in Europe, and it goes without saying that we appreciate the necessity of our Government's taking this step. I am pleased to say that immediately upon receipt of the notices to pull the big switch for the last time, a goodly proportion of Canadian amateurs expressed their appreciation in writing to their Government for past privileges received and offered their ham equipment and experience for any useful purpose. Many of the gang from Halifax to Victoria are already in some branch of the fighting services — highly self-trained specialists due almost entirely to their ham radio hobby — and letters are filtering back from the absent members of the fold requesting that they be kept informed of ham activities in the home town.

Despite the severe blow and the handicap of being unable to communicate over the air with each other, Canadian radio clubs, in most cases, are continuing as in the past and, strangely enough, larger turnouts to meetings are the order of the day. We still swap tales of the DX we hear (but can't work) and plenty of plans are being laid for the new rigs to be put on the air in the future — which brings me to the point of the epistle.

Many of the old-timers will remember the efforts of the A.R.R.L. at the close of the last war to put ham radio back on its feet again after a similar suspension of radio transmitting privileges, and, without the weight of numbers which the League represented, their efforts might not have borne such sweet fruit.

The League has spared no effort in furthering the cause of amateur radio in Canada and, representing, as they have always done, the largest organized group of Canadian amateurs, it has always been possible to present a more or less complete opinion of Canadian radio problems to the Canadian Government whenever necessary. Now that we are off the air, the League's publication, *QST*, is the sole remaining means we have of keeping in touch with each other, exchanging views and finding out what the other fellow is doing.

From time to time in the past, various interests have looked with longing eyes upon the frequencies held by the amateurs and, in many cases, the League has had to put up a tough fight to retain our rights. It is beyond my powers to predict just what changes the war will bring about, but I do know that when we have finished it, we shall be looking forward to trundling "Old Betsy" out of the attic and having our p.d.c. R9 chirp split the ether once again down in dear old Dogpatch. If for any reason difficulties are experienced in resuming just where we left off, I also know that we shall look to the Canadian section of our League organization for assistance in ironing out the troubles. You understand, of course, that our Canadian section is entirely self-governing in its operating activities and its relations with our Government.

May I suggest, therefore, fellows, that the fact that we can no longer transmit is no reason for you to discontinue

your League support. In the League we have a democratic organization of which we can be justly proud. It has always pulled for the Ham and will continue to do so without consideration of race or creed, and, if only for past performances, we owe it our allegiance.

So don't forget, OM, when the time comes to renew that membership and *QST* subscription, to signify your appreciation of all that the League stands for and make sure that your membership is continued by renewing promptly.

73.

— Alex. Reid, VE2BE
Canadian General Manager

LIGHT BEAMS FOR VE'S?

Rouleau Siding, Abitibi, P. Q.

Editor, *QST*:

Don't you believe W8RWP merits congratulations for his page on "Light-beam" transmission (*QST*, p. 60, March, 1940)?

This is really a discovery that may bring lots of fun and may become important. I'm sure it will not be long before someone finds an important use for this system.

Why should not every VE jump on the dope of W8RWP and try to find a way for the "light-beam" to replace, partly, their radio waves?

— J. J. Rouleau, VE8CN

CODE-PRACTICE STATIONS

Old Forge, N. Y.

Editor, *QST*:

Your article in the front of March issue, and in front is about as far as I usually read, regarding "the public spirited amateurs that send code practice in the 160-meter 'phone band" and their difficulty with the "deliberately organized" band of 'phone men that operate on the same frequency, I believe if I were in your place and knew that the 'phone men did not approve of your sponsorship of this practice, I would quit.

I don't work 160 very much and I don't know who sends the practice or who are organized to gum it up. I can see through your reason for wanting to help the would-be amateur as it is evident from your financial reports you could stand to sell a few more copies, but don't let the ones down that already take the book.

I wouldn't say that the 'phone bands are too crowded for 'phones, and can't forget that some twenty-five years ago I was a beginner and had to learn the hard way, and I am in favor of more and new amateurs. I am not however in favor of code in a 'phone band whether for practice or just for fun and inasmuch as there are others that think the same way, I suggest you put the practice on the c.w. band and you won't have any complaint from the 'phone men.

If you want further discussion on the subject, put this in your book.

— Riley Parsons, W8BXV

EDITOR'S NOTE.— Since code-practice stations are 'phone stations who give voice instruction as well as code transmission at varying speeds, they obviously cannot operate in c.w. bands.

(Continued on page 102)



F. E. HANDY, W1BDI, Communications Mgr.

E. L. BATTEY, W1UE, Asst. Communications Mgr.

Announcing two changes in word count: The land line or text-only check was adopted by A.R.R.L. some years ago to simplify the checking of message traffic, as well as the transfer of messages to and from wire circuits. Detailed checking practices are explained in *The Radio Amateur's Handbook*, 1940 edition, pages 432 and 433, and given in the publication *Operating an Amateur Radio Station*.

In the regular policy adopted for word count there have been two ways of sending and counting radio calls of amateurs. W1AW could be counted (as mixed letters and figures always count), each character as one word, and sent together as a group the count was "four." Or it might be sent W ONE AW and counted as "three." Effective with this issue of *QST*, to simplify handling and counting amateur call signals that appear in the text of messages, all call signals except those sent as three groups (W ONE AW) will, when sent in close formation count as *one word* only. Sending call signals as one word is an exception to the mixed count rule.

Another change in word counting practice also will be now regarded as officially accepted in A.R.R.L. word count. In counting figures, a group of five digits or less will count as *one word*. Bars of division and decimal points may constitute one or more of the digits in such a group. While the telegraph companies have revised their practices primarily to make it seem possible to give the public more words for its dollar, our action in adding these things to A.R.R.L. count is primarily taken in the interest of simplified counting, and uniformity with other communications services.

Examples:

Transmission	Former Word Count	New Accepted A.R.R.L. Count
W1BDI	5	1
12345	5	1
67.9	4	1
123456	6	2
45½	5	1
64A2	4	4
64 A 2	4	3

The A.R.R.L. Emergency Corps received re-registration blanks at the year end and one third of the members of the Corps have (March 1) returned the blanks. Emergency Coördinators are working hard to build up new registrations and organization in their respective communities. Those A.E.C. members who did not return the blanks are now urged and requested to do so at once, if at all possible for them to remain identi-

fied with the Corps. Those whose work has required giving up amateur activity, or who for other reasons did not reply, have necessarily had to be dropped from the rosters. But we urge every A.E.C. member who can do so to return the re-registration form so we can reinstate that call and registration in the file. We need to know the equipment changes; we need to have new addresses; we need to have as large a part of the amateur fraternity identified with preparedness for communications emergencies as possible. Register at once, OM, if you haven't — and all licensees that have never identified themselves with the Corps are invited to drop a postal or a message for Emergency Corps blanks right now!

Coming Events. The dates of May 11th and 12th have been set for the next Ultra High Frequency Contest. With the spring all the u.h.f.'s will be looking up. The February activity, in the face of adverse conditions, had practically the participation of the U.H.F. Contest of last November — so need we say more about May. A new high in reports and relay success is anticipated. Announcement is scheduled for next issue.

It is not too early to talk about the Field Day. For a month advance inquiries have asked for tentative dates. Certain preparations are being made. Some vacations are being arranged for the time of the F.D. June 22nd and 23rd have been picked for the A.R.R.L. Field Day. Start your emergency power supply building contests now — for as usual the emphasis will be on the availability of independently powered stations to do a job.

Wishful Thinking and Neutrality Recommendations. We wish that there was no such thing as the war. We wish we could talk freely with all amateurs of all nations with impunity. We have the legal right to talk about the belligerents or to talk with amateurs in belligerent countries if we insist upon it . . . but we know it is unwise to insist upon legalities when to do so invites surveillance and suspicion, and when so doing builds up the case for restriction of some of the privileges we amateurs enjoy. It was good policy in the DX Competition to prohibit any work with the European theater of war. It is good policy for A.R.R.L. to give no credit now or in the future for any contacts now made with amateurs in belligerent territory, or in countries that may be neutral but where amateurs have been shut down as a precautionary measure. It is good policy for the individual to steer clear of things that invite suspicion and inquiry, and possible restriction.

Up to this time, we United States amateurs have been fortunate in having practically no activity in our frequencies to tempt us to violate our self-imposed A.R.R.L. Neutrality Code and the policy of avoiding all contact with European and especially *belligerent nations' amateurs*. It is just wishful thinking to try to make one's self believe that because he wants to talk about the war, or work a station in or near the theater of war, that it is all right to do it. It is not doing right by either ourselves or brother amateurs to do what is tantamount to inviting the necessity for increased monitoring, or what is simpler for Uncle Sam, more restrictive rules. We wish only well to the amateurs of all countries; but we are obliged in the same breath to point out that an increase in the number of belligerent countries' amateurs on the air *working internationally* is just so much increase in the risks of further necessities in the line of surveillance or restriction. So we repeat the previous advice. Steer clear of calls or contacts with even legitimate stations in belligerent territory — whichever side they are on! Have no contacts with the theater of war at all. What was good policy at contest time, is good policy for every day.

Warning on international message handling. It is contrary to the international regulations to handle an international message to or from outside the Americas on behalf of a third party. (*Domestically* only the test of whether direct or indirect compensation is involved must be made, of course.) The United States has ratified the Cairo treaty, and Article 8 applies, limiting amateur international contact to "messages relating to experiments and personal remarks of such unimportance that recourse to the public telegraph service would be out of question. . . ." Excepting only when treaty arrangements exist between the U. S. A. and other countries (and then only to the extent agreed upon) may third party messages be handled. This is just to warn that it is illegal to take any third party messages from (for example) British Honduras, Germany, the Belgian Congo, or others outside the American countries that have treaty provisions. Just because a message seems unimportant or in the interest of amateur radio will not excuse one's taking or sending it in contact with any foreign station, and very serious trouble is ahead for the amateur who goes contrary to the international regulations and gets hauled on the carpet therefor.

— F. E. H.

Unlicensed Operators Apprehended

A visit by the Radio Inspector to Bridgeport, Conn., on March 4th resulted in the apprehension of two unlicensed operators, posing as radio amateurs in the 112-Mc. band. These individuals, Frank Mayo Sanchioni of 53 Amsterdam Ave., and Jules Kish of Lesco Court, were released on \$500 bail and ordered to appear in the District Court, New Haven, to answer charges of operating without licenses.

ARTICLE CONTEST

The contribution by Miss Frances V. Rice, W3AKB, is the second winner in the new article contest announced in February *QST*. Miss Rice presents her case for "Eighty-Meters" as the "Most Interesting Band."

For the next several months we are inviting articles for the C.D. contest based on various individuals' ideas of "the most interesting frequency band." Practically every operating amateur has a "favorite" band, one that he would swear by to the bitter end. What is *your* favorite?

Send in your article on why such-and-such-a-band is, in your opinion, the best available. Each month we will print the most interesting and valuable article received on this subject. Please mark your contributions "for the C.D. contest." Prize winners may select a 1940 bound *Handbook, QST* Binder and League Emblem, six logs, eight pads radiogram blanks, DX Map and three pads, or any other combination of A.R.R.L. supplies of equivalent value. Try your luck.

The Most Interesting Band

BY FRANCES V. RICE, W3AKB*

We have quite a wide selection from the waves at our command,

But the gem of the collection is the Eighty-Meter band, Where you spend each passing hour in the maximum of ways Without need for higher power or directional arrays.

Other bands we have aplenty, we all hope to try each one. We enjoy a crack at Twenty, work on Forty's lots of fun. When you tune in your receiver, if you hear that faint DX. You can catch a fatal fever that is turning hams to wrecks.

Yes indeed, it's very thrilling to contact the great unknown, But those waits between are chilling, time and hopes too soon have flown.

Of the stations that one raises, most have not been heard before,

You exchange some formal phrases — and then part forevermore.

On Ten Meters it's erratic, and on Five it's so confined, And One Sixty's full of static (although no one seems to mind).

But our Eighty's comprehensive, you can reach out far enough

To make contacts quite extensive and so demonstrate your stuff.

A—one type of operation suits the hams who haunt this freq Where the art of conversation is developed to its peak. DX still has its allure, with from coast-to-coast the aim. The miles may be much fewer, but the thrill is just the same.

When you're pressed for time you're going to want a sure bet For continued QSOing with some schedules or a net. QRM can't spoil your pleasure, you're not likely to despair. Who won't dig for buried treasure when he *knows* that it is there?

There's enthusiasm hearty, for an FB traffic score, For contest and for party, and for our Emergency Corps; For the Army and the Navy, and the A.R.R.L. trunks, Since this band attracts the gravy — is avoided by the punks.

Here's a wish that none will swerve us from the band on which depends

Our major public service and the making of real friends. Sure, Twenty is the berries — oh, yes, Ten no doubt is grand But for hamming minus worries, take the Eighty-Meter band!

* R.M., O.R.S., Eastern Pennsylvania, 202 E. Gorgas Lane, Mt. Airy, Philadelphia, Pa.

ADDITIONS, DIRECTORY OF A.R.R.L. NETS

Name of Net	Frequency	Operating Hours	Net Members
SAN FRANCISCO SECTION NET.....	3827-kc.		W6RH RBQ BUJ CIS
SOUTHEASTERN KANSAS EMERGENCY NET SUSQUEHANNA EMERGENCY NET.....	1970-ko. 3910-ko.	9:30 A.M. CST, Sun. 8:00 A.M. EST, 2nd Sun. ea. mo.	Twenty-six stations W8CNA DHO AVD CHU RRS MFD PUZ QPU EKG AYG TIZ/UDE EA HBG AVK PIK QJP HHK DEC GGE VI CHR NEZ BKT W3WX UR GKM UA AVX ZD. Relief oprs: W8KQ SOZ IGT TDB BFF PTE SNB FNV RSX MEH ITS RJL SEL CIA TIW ASE QYE RAQ OIZ 2GG/8 Supporting members: W2LV W3FJU QV QQR ADM BEI EOG W4ANU DU W8FER BQ HLM
VIRGINIA PHONE NET.....	3980-ko.	9:30-10:30 A.M. EST, Sunday	W3FCU GWQ AJA HWJ IBS FGJ DPV AHQ IAM FTC EGU BTM BIG FHO ELB EPK IFZ DWE FBR DBY FQP CHE FHF FN

Corrections and Additions to March QST listings: The following participate in the Vermont Traffic Net — W1AD BNS CBW CGX EJK PPS KJG KOO KTB KVB KWB LWC MJU. The Wisconsin State Net meets from 6:00 to 6:30 p.m. CST. The Washington Regulars Section Net meets from 6:30 to 7:30 p.m. EST daily. W8KWA is the Pennsylvania station on Trunk Line "A," rather than W8LHR, who is in Michigan.

O.B.S.

The following is a supplement to the list of A.R.R.L. Official Broadcasting Stations in October QST (page 76): W1IBR, W1IIE, W1IQZ, W1LHA, W1VY, W2IOP, W4ACZ, W4EAY, W4FAZ, W4FWD, W4FYB, W4PB, W5FAR, W5GWL, W5HIF, W5JC, W6FUO, W6HOE, W6RYL, W8PQQ, W8TJY, W9BPC, W9BYV, W9DKF, W9SCE, W9ZVO.

— —

VE/W Contest Awards

In addition to certificates of merit to the leaders in each A.R.R.L. Section, additional awards have been made to high scorers in the 1939 Canada-U.S.A. Contact Contest. The Canadian Marconi Company Silver Cup Trophy to the leading VE was presented to VE3SF, W. E. Smith of Toronto. W2IOP, Larry LeKashman, won the Montreal Amateur Radio Club Trophy for the highest W score. This trophy is to be used as the award to the highest scoring W station in each following VE/W contest. Special awards also went to the several highest scoring VE's, as follows: VE2FG, T40 tube; VE2EE, T40; VE3APD, 807; VE5ZM, 809; VE3GT, 809; VE3ES, variable condenser; VE3AJX, crystal; VE5VO, condenser; VE4AGA, variable transmitting condenser; VE4SO, six r.f. chokes; VE4ZC, 300-volt item; VE3KE, two-power rheostats. These awards were made possible by the cooperation of the Canadian G.E., Hammond Mfg. Co., Blevis Crystal Labs., Aerovox Canada Ltd., Hammarlund Mfg. Co. and International Resistor Corp.



Presentation at a Montreal Amateur Radio Club meeting of the Canadian Marconi Company Trophy for the highest scoring VE in the 1939 VE/W Contest. J. V. Argyle (at right) of the C.M.C. is presenting the trophy to A.R.R.L. Canadian General Manager Reid, VE2BE, to be passed along to the winner, VE3SF. Also identified in the photo, seated at end of table, left to right, VE2CO, VE2IE, VE2EW and VE2IO; standing, left to right, VE2HF, VE2EE, VE2CR and VE2DU.

A.E.C. Emergency Drill

To test the equipment on hand and familiarize the operators with correct message-handling technique, an emergency drill was held in Cumberland, Md., Sunday, Feb. 4th. Seven stations and ten operators participated: 1.75-Mc. 'phone was used, with one station on 3.9-Mc. 'phone and one on 3.5-Mc. c.w.

W3OL, assisted by W3ON, moved into the local Red Cross office and operated from there during the entire drill. W3FRV, with W3FQH assisting, set up his equipment in the City Engineer's office in the City Hall building. W3BHE, the only self-powered station available, operated from his automobile for half the drill while it was parked near the State Armory. Later he moved to the highway bridge over the Potomac River connecting Cumberland and Ridgeley, W. Va. He had W3FQL as assisting operator. W3AQV, W3GME, W3ANL and W3GUT operated from their homes. W3AQV, the Emergency Coördinator for Cumberland and vicinity, acted as drill-master control. By previous arrangement and with the help of W3ZD, Regional Emergency Coördinator, a message from the Disaster Relief Chairman of the National Red Cross Headquarters was relayed through W3HQU in Washington, D. C., to W3GME in Cumberland, and then relayed to W3OL in the Cumberland office of the Red Cross. W3GME handled the message from the local Disaster Relief Chairman and the message from Washington at 9:30 a.m. The drill proper started at 12:45 p.m.

Over 20 messages were handled, and at the close of the drill we were only 18 minutes behind the schedule that had been laid out for the fellows to follow. A good time was had by all those participating — it being something new for a change. The City Engineer of Cumberland was loud in his praise of the way the operators handled the entire affair. A drill worked around the relaying of stream gauge readings for the City Engineer is planned for the next test.

— *Wilfred A. Thompson, W3AQV, E.C.*

— —

W6PGB sent us the basis for this one: When a GOOD-MAN goes BATTEY over ham radio and gets HANDY with a bug, his XYL comes HUNTOON for him in his CHAMBERS and in no uncertain GRAMMER tells him to stop and have a HART, should he take it on the LAMB? Perhaps it would be wise to WARNER to let you alone or take her for a drive in your DESOTO and avoid a MIX-up. Then love can BUDLONG after it should be dead.

— —

January '40 O.R.S.-O.P.S. Parties

WOW! We tried to think up a sentence that would fully describe those January get-togethers of League officials and O.R.S.-O.P.S. appointees, but the more we studied the results, the more we wished we had one of those "pictures that take the place of ten thousand words." Failing in that,

we'll sum up in one brief word that seems to fit the occasion — WOW! The January affairs were the most outstanding O.R.S. and O.P.S. Parties of all time! Just "look at the record." In the O.R.S. group, W3BES hit 32 million points. In the O.P.S. group, W2HXQ hit 12 thousand. Both are all-time-highs. For exercising the best in operating technique, try an O.R.S. or O.P.S. Party. If you can fulfill the qualifications, your S.C.M. would welcome your application for either appointment. Once appointed and living up to the requirements, you would be eligible to get in on the quarterly parties, the next of which is on April 27th—28th.

Official Relay Station Scores (Jan.)

Station	Score	Dist. Stns.	Dist. Sects.	Heard	Power (Watts Input)	Operating Time
W3BES	32,940,950	295	55	17	600	20 h.
W4EV	24,935,537	260	57	11	400	19 h.
W1TS	22,358,280	248	53	—	350	19 h., 45 m.
W8NDS	17,689,100	235	51	—	100/400	19 h., 40 m.
W9BYH	17,221,050	221	54	22	90	19 h., 51 m.
W1BFT	14,507,534	214	52	24	100/150	19 h., 53 m.
W9VES	14,395,836	221	52	32	—	15 h., 46 m.
W3DGM	14,336,442	227	44	27	80	20 h.
W4AGI	14,323,060	204	50	—	—	19 h., 20 m.
W8TNC	13,832,936	205	51	31	600	19 h., 45 m.

(W2CCT, opr.)

Station	Score	Stns.	Sects.	Station	Score	Stns.	Sects.
W4DWB	13,566,960	211	53	W4NC (sev'l oprs.)	4,582,116	135	39
W9BPU	11,881,248	200	48	W9VOQ	4,435,620	131	46
W5KC	11,384,800	174	50	W8ROX	4,426,488	144	40
W5DEJ	10,864,792	179	53	W8KXF	3,902,548	134	35
W1EOB	10,570,525	200	45	W7GPP	3,857,176	104	44
W3GEM	10,380,240	196	44	W5FZD	3,852,800	116	44
W1UE	10,216,038	202	42	W9VQE	3,539,250	121	44
W1KQY	9,966,778	192	47	W2IOP	3,525,606	125	37
W9VDY	8,831,025	173	52	W9KBL	3,492,000	121	39
W3AGV	7,341,195	168	49	W8LVH	3,434,300	113	40
W9ENH	7,146,569	146	51	W9QMD	3,416,427	101	46
W6RBQ	6,820,240	109	43	W2LXI	3,319,920	122	37
W3GYQ	6,297,720	156	39	W3EML	3,316,440	135	39
W3HXA	6,256,575	153	42	W8SFV	3,300,696	134	43
W2DYO	6,229,468	155	41	W2GVZ	3,272,160	128	42
W8NAB	5,881,150	137	50	W1JSM	3,095,802	121	32
W8RMH	5,533,785	140	39	W2LZR	3,095,802	117	34
W2JKH	4,373,500	148	42	W6BAM	3,043,705	94	41

Official Phone Station Scores (Jan.)

Station	Score	QSO's	Sects.	Heard	Power (Watts Input)	Operating Time
W2HXQ	12064	74	29	23	200/600	7 h., 54 m.
W4DCQ	10220	69	23	10	800	7 h., 3 m.
W3FJD	10179	71	27	11	1000	7 h., 55 m.
W8MOL	7722	51	26	21	500	7 h., 3 m.
W1ATE	7050	50	25	16	650	7 h., 50 m.
W8VZ	6118	48	23	13	650	5 h., 53 m.
W9WXL	5405	41	23	15	250	7 h., 59 m.
W2CET	5280	48	22	—	400	5 h., 7 m.
W8KNF	5082	42	21	16	300	5 h., 56 m.
W8BQA	5020	41	20	23	140	5 h., 2 m.

Station	Score	QSO's	Sects.	Station	Score	QSO's	Sects.
W8NNJ	5253	45	17	W8BOZ	3059	29	19
W2JME	4700	43	20	W3EQK	2952	29	18
W8JTI	4032	34	18	W1ERH	2912	32	16
W2GRG	3990	36	19	W9VCO	2250	28	15
W1KTE	3942	33	18	W2CHK	2119	25	13
W8BFB	3781	33	19	W6CHEV	2016	20	18
W1DWP	3723	43	17	W3RFC	2010	24	15
W1EAO	3667	33	19	W2DVC	1918	21	14
W4QI	3492	30	18	W9WVQ	1911	17	13
W8RYC	3477	31	19	W8BTQ	1890	25	14
W3DRQ	3315	33	17	W9TRN	1876	24	14
W1GC	3202	35	18	W8AQ	1816	17	12

BRASS POUNDERS' LEAGUE

(January 16th-February 15th)

Call	Orig.	Del.	Rel.	Extra Del. Credit	Total
W4PL	9	49	3114	38	3210
W9OIL	103	235	1679	200	2217
W3EML	59	238	1012	228	1537
W3BWT	63	156	1125	141	1485
W4FDT	12	14	1272	14	1312
W3CIZ	41	185	849	180	1255
W7EBQ	27	84	984	60	1155
W9ILH	13	39	1070	23	1145
W9YXH	43	107	938	34	1122
W6IMI	37	419	176	411	1043
W5FDR	70	148	638	113	1019
W9NFL	7	23	968	14	1018
W8SFF	7	24	964	13	1008
W4PFI	2	7	975	2	986
W4AOB	4	122	734	72	932
W6LUJ	122	398	4	397	921
W6IOX	30	59	772	59	920
W5CEZ	38	167	680	31	916
W6DHI	96	61	656	46	861
W3BZX	5	4	802	0	811
W5FDM	194	233	143	233	803
W2ITK	85	79	551	64	779
W8OAN	121	65	512	45	743
W4DVO	1	13	684	13	711
W4DXH	5	13	670	13	701
W3BKZ	7	30	658	0	695
W1I0R*	33	261	138	229	661
W4JCR	4	11	620	11	646
W4FCU	16	8	607	7	638
W8OKO	21	25	559	18	623
W1UE	94	73	399	45	611
W8BJO	75	66	398	34	573
W9FAM	6	9	552	6	573
W5MNM	28	118	330	92	568
W4PFR*	61	79	372	56	568
W4KPC	20	14	522	11	567
W3GJL	3	41	476	36	556
W8DAQ	12	9	522	8	551
W1IKS	33	36	468	9	546
W8SAY	43	30	442	27	542
W1EOB	40	39	442	20	541
W8JQE	49	59	402	30	540
W9GTM	7	140	286	105	538
W8IXJ	13	8	498	0	519
W3GKO	29	53	386	50	518
W1INU	44	35	432	0	511
W2GVZ	29	82	330	69	510
W6NRP	58	101	274	77	510
W5GPV	55	157	194	103	509
W5FSK/4	273	153	8	70	504
W6FTR	9	30	440	24	503

MORE-THAN-ONE-OPERATOR STATIONS

Call	Orig.	Del.	Rel.	Extra Del. Credit	Total
W4DUG/4	3515	17	0	0	3532
KAIHR	898	745	216	709	2568
W5OW	149	185	1452	112	1898
KAIHQ	336	299	744	235	1664
W4GHU	0	0	1026	0	1026
W1AW	85	157	550	151	943
W9THS	34	14	674	10	732
W9BNT	39	125	523	23	710

These stations "make" the B.P.L. with total of 500 or over. One hundred deliveries+ Ex. Del. Credits also rate B.P.L. standing. The following one-operator stations make the B.P.L. on deliveries. Deliveries count.

W2SC, 273	W4DNA, 150	W8ASW, 119
W6MQM, 246	W6KOL, 150	W3EFH, 110
W2KI, 243	W9UN, 150	W5EOE, 107
W6PCP, 232	W7APS, 148	W5CDU, 106
W3GTS, 229	W9ZFC, 139	W2LR, 104
W8QOK, 194	W2MT, 138	W4DQW, 102
W5HAG, 188	W1I0R, 135	W8RYP, 102
W8KWA, 163		
W6CMN, 155	W1KCT, 134	W1GTM, 100
W6PGB, 154	W6ZX, 123	More-than-one-opr.
W3ELN, 152	W1LPR, 123	W1GOJ/4, 176
W2LZR, 151	W8HR, 123	

A.A.R.S. MORE-THAN-ONE-OPERATOR STATION

Call	Orig.	Del.	Rel.	Extra Del. Credit	Total
WLM (W3CXL)	142	229	3447	79	3897

A total of 500 or more or 100 deliveries Ex. D. Cr. will put you in line for a place in the B.P.L.

* December-January.



How's DX?

HOW:

We're regaining the old faith a bit now, seeing that the boys have buckled down to their job and are really digging the stuff out from under. Perhaps the past several years of good conditions have spoiled some of the less hearty DX-ers, leaving them disgusted when things take a turn for the worse. Call it weeding out the weaklings or what you will, the evidence is that no matter what happens, the born DX men are going to find DX to work. That, by the way, is the kind of spirit we like to see.

Some of the fellows applying for 'phone DXCC and WAS may not realize it, but they jeopardize their position plenty when they go over the cards they submit, strengthening (and sometimes writing in) the 'phone report, so the judges will make no mistake that the card was for a 'phone contact. A timely word should be sufficient, and we say, "Leave it to the judges" — the unmarked card has a much better chance of getting by than the — let us say — "strengthened" one. A card that shows any sign of tampering, even though there was no intent to defraud, immediately points the finger at the one who submitted it.

Speaking of cards, this might be a time to get a few ideas off our chest, or wherever one keeps ideas. Since cards nowadays are used for claiming various awards like DXCC and WAS, for both 'phone and c.w., the cards should show certain facts quite plainly. Many of the DX cards fall down in this respect, and so do a lot of domestic ones. The important things to show are: a two-way QSO actually took place, whether the recipient of the QSL was using 'phone or c.w., date and signal report. There should be no room for doubt about any of these items, and particularly the first two. Another thing, by way of a suggestion, is that the name of the month be spelled out on the date line, instead of using the number system. Why? Well, as an example, G2MI tells us that ZB2B didn't acknowledge some of the cards he received because the date was written in a la the U. S. system of using three numbers (month, day and year), which he interpreted in the European way: day, month and year. Reading it the European way, ZB2B found no record of such a QSO in his log, decided the W was pulling a fast one, and filed the card in the w.b. A small matter, perhaps, but some fellows are out cards from a country they could use because of it. In the future, therefore, be sure there is nothing of an ambiguous nature on your card, and you'll save yourself and the other fellow some grief. The ZB2B case is just one example — there are dozens of them. If spelling out the month instead of using a number wears out your pen — that's another point: use ink or a typewriter — let us know and we'll send you a special high-test, wear-ever, rust-resisting, super QSL-ing pen point for only \$27.50, f.o.b. Andorra.

WHERE:

Nicest bit of DX-ing we heard about this month was two QSO's W2AIW had. One, with XU8MI on 7 Mc. one morning, is good DX for any east coaster, but the other is a real honey because it was with none other than our old but elusive friend, AC4YN (14,266). Charlie worked him at 7:45 a.m., and the QSO has been confirmed by radio via KB6RWZ, which makes W2AIW No. 4 in North America to work a certain Mr. Fox of Lhasa, Tibet Next best piece of DX is, of course, the Snow Cruiser, KC4UGL. A number of fellows have worked him, including W6GRL, W2IXY, W5BB, W1AKY ('phone sked), W8MOCB, W3QV, W2ZA, W2GRG, W9PFR and W4CCG, on both 'phone and c.w. He shows up almost anywhere: 14,370, 14,330, 14,160 and 7000. He is already pretty well fed up with the e.c.o.'s climbing all over him, and refuses to work anyone who pulls the old wolf trick. He will be sending in a QSO list shortly, according to the dope we have, and the more polite — and smart — lads that worked him will get their DXCC credit.

The wise way to raise him is to call him from 15 to 50 kc. away from his own frequency, and not on the frequency of the fellow he's working W3ELG worked EA5A (14,400 T7) the other afternoon We don't put much stock in the PX1B and PX1C that have been floating around and, no, we can't forward cards to them because we don't know where they are W8SNA worked HRIKC on 80 little after midnight and, from what the HR told Joe, the perfect DX station has been discovered. The HR said he would QSL but didn't want any card in return because he travels around and cards would only be a burden!

WHEN:

W6SN, recalling the good old days on 40, has been up there renewing old friendships and is surprised to find, he says, many DXperts rediscovering Hamerica. Besides the old-timer W gang, he ran into LU7AZ (7000), HK3GL (7100 T6), D4BIU (7050) and the usual Pacific bunch W3ATR backs up the viewpoint with HI3F (7180 T8), LU7AZ (7240), XE3Y (7140), K7ZZK (7265), HC1PC (7260), PY5CG (7210 T8), HK5ED (7100) and HK4DD (7100) all between 10 and 12 p.m. W9LEZ adds to that with KAIHR (7100), KAIHQ (7090 T7), J2OV (7075 T9), HK2BD (7070), K7ENA (7270) and K7BOE (7270) W8JSU and W9YXO pool their report and submit J8CL (7180 T8), XU6HW (7030 T8), PY1UJ (7170 T6), NY2AA (7020 T8), CP1CF (7030 T9), J3FJ (7100 T9), PY1MK (7280 T7), KB4AAN (7298 T9), and HA8C (7110 T8). Around 7-8:30 a.m. for the Asians and 8 to 11 p.m. for the South Americans W8NAF clinches the deal with HH1DO (7160), J2KN (7240), XU8MI (7150), HJ1KH (7130), HK2PF (7010), K7GOR (7100), YV4AX (7250), K7GTB (7130), KF6ROV (7150) and KA9CG (7090).

Not much on 10 c.w., although W8JIW reports hearing OA5AB, K4FCV, K4EZR and K6OQV, presumably warming up for the Contest.

W5BB says KB6RVN (14,380 T9) showed up one morning, and W8QJE grabbed J2IX (14,385 T9), J2NF (14,390 T9), J2KQ (14,385 T9), PK1XZ (14,260 T9), KF6JEG (14,320 T9) and KB6RWZ (14,380 T9) W6MVL says stuff on the coast looks like HA2N (14,400), HA6K (14,400), HA9U (14,325), HA9Q (14,390), HA7E (14,385), OK3ID (14,390), D4BIU (14,400) and OQ5EM (14,375) W4FLW has KAI1B (14,310 T9), LU2FO (14,340 T9) and K7ENA (14,325 T9), while W9INR adds LU5BL, K6RNU, K6NZC, PY2LV and K6SCB, all in the 20 kc. at the high end TI2EA gets on 14,050 once in a while.

'PHONE:

W5BB lists HC1JB (28,350), CE2BX (28,050) and KA1GC (28,300), while W6ITH has a flock of stuff which includes CE3DW (28,225), LUIDA (28,375), HK3CK (28,110), PY4EJ (28,225), TIAV (28,290), YN3DG (28,130), HP1A (28,145), CE3CZ (28,255) and PY2AC (28,190).

There seems to be considerable stuff on 20 'phone for those willing to dig. For example, W2JT worked ZP3AC (14,000) and KB6RWZ and some XU's in the evening, and heard ZP6AB (14,200), while W8AAJ knocked off CP2AC (14,070), Carlos Godoy Chiappe, Casilla 268, La Paz, Bolivia: ZP3AA (14,070), IJ1KV (14,060) and EK1AF (14,065) Besides KA's and XU's, W1ZI scared up a good one in PK4DA (14,260), worked at 14 GT W6MVL grabbed CP3AB (14,120) and W6ITH knocked off KA1ME (14,140), J2XA (14,160), XU8RJ (14,120), KA1BB (14,275), KA1FH (14,145), KA1CS (14,110), KA1LB (14,140), KA1AF (14,260), KATEF (14,260), KA1AR (14,145), KA1CW (14,120), KA1ME

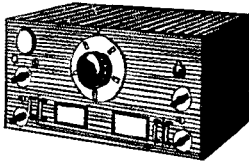

THE prize contest which we announced in *QST* last February is going places. Entries are coming in steadily, and they look excellent. W8REC's offering was the first received, and such excessive promptness seemed to deserve some special reward, so we have decided to give him a thousand QSL cards. This is not one of the regular prizes of course, for they will be saved until

the judges make their decision next July.

We are tempted to urge you to send in your entry early because we are finding them so interesting that we do not like to have to wait several months. However, rules are rules, and all entries have an equal chance of winning until July first, so do not be discouraged by the early birds.

★ ★ ★ ★ ★

So many of the letters that we receive from amateurs ask us whether we can install Noise Limiters on HROs that it seems worth while to give the answer, and the reasons, on this page. The answer is "Not yet!" The fact is that any change on a receiver like the HRO requires very careful engineering and painstaking testing. Also there are various special difficulties in the case of the HRO, such as lack of space. All of which adds up to the fact that we cannot undertake any rebuilding for some time. When we can, we will let you know.

Fortunately it is not as urgent as it would be with another receiver, because the HRO already has a certain amount of noise suppression. This is not due to any special noise limiting device, but is the result of divers tricks that we used in the circuit. We are not going to go into details here, but a competitive test under actual operating conditions (comparing the HRO with another receiver) will show how low the normal noise level in the HRO really is.

Space really is a problem. There is no place for a limiter on the chassis, and there is no easy way to make a place. Of course, we might put the limiter in a separate box and stick it on the outside of the cabinet like a wart on a dill pickle, but any such arrangement does not appeal to us very much, and we do not think it would appeal to you. Not on an HRO.

The fact is that the HRO was designed for *maximum performance*, which makes it much more difficult for us to make changes. The design is so nicely balanced that it is difficult to make even minor changes without a loss in performance. Furthermore, our customers have come to expect so much of the HRO that make-shifts are out of the question, even if we wanted to use them. We would not wish our customers to be otherwise. We take a lot of pride in selling the hardest-boiled buyers in the world, and still greater pride in getting back a wire for "a hundred more HROs." It shows they have what it takes.

EUGENE SIMMS



ANNOUNCING!

NEW

P. R. MALLORY & CO. Inc.
MALLORY

VF-223 FILTER UNIT

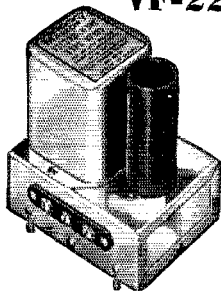

A new audio or hum filter unit, the Mallyory VF-223, is now available for use with all single unit Vibrapacks. Designed especially for applications

where voltage regulation is important, as in Class "B" Audio Amplification; or where the utmost in hum suppression is required as in high gain audio amplifiers, the VF-223 provides a truly de luxe filtering system.

The filter condenser is a three-section Mallyory FPT-390, of 15-15-10 mfd. capacity, 450 working volts. The two 15 mfd. sections are used with the choke to form a conventional pi-section filter, while the third 10 mfd. section connects to a separate terminal so that, if desired, a filtered intermediate output voltage may be obtained. The filter choke is rated at 100 m.a. and has a d.c. resistance of only 90 ohms, resulting in a minimum of voltage drop.

Here is the quality filter unit to use with receivers, transmitters, high gain amplifiers and scientific apparatus. See the Mallyory VF-223 Filter Unit at your Mallyory-Yaxley Distributors.

Be sure you have your copy of Form E-555-B which gives detailed technical data on Mallyory Vibrapacks.* Invaluable to all interested in battery-operated apparatus. Available without charge from your distributor, or write . . .

P. R. MALLORY & CO., Inc.
3029 East Washington Street
Indianapolis, Indiana

*TRADE MARK REG. U. S. PAT. OFF.

Use
P. R. MALLORY & CO. Inc.
MALLORY
APPROVED RADIO
PRECISION PRODUCTS

Use
YAXLEY
APPROVED RADIO
PRECISION PRODUCTS

(14,140), **J2NG** (14,130), **J2NF** (14,070), **J2NJ** (14,040), **J7CB** (14,060), **J5CW** (14,080), **HC2CC** (14,260), **CE1BC** (14,050), **CE2BX** (14,070), **LUIQA** (14,085), **YV1AV** (14,000), **LU4PB** (14,110), **KB6ILT** (14,160), **J2NQ** (14,050, 14,270) and **CX2CO** (14,060). **KB4FTU** (14,152) was heard.

WHO:

W3EMM and W3FQP worked AC4JS the other evening Speaking of AC4JS, last month we inadvertently, through poor choice of language, cast what was interpreted by some as an aspersion on XU4XA when we mentioned that he had printed the cards of AC4JS. Some of the lads thought we were trying to imply that XU4XA was running a racket or a frame or something, which was farthest from our intent. As a matter of fact, we should have enlarged on the subject and mentioned that no cards would have come from AC4JS at all if it hadn't been for the efforts of 4XA, and he deserves a vote of thanks from the gang. (You sure get yourself in trouble over 4XA, don't you? First you peg him a phoney because his signal's too good and then you don't explain yourself fully. Tsk, tsk. — Jeeves) Although off the air as an amateur, **VP5PZ** (4800) is on the air as a broadcast station for the government of Jamaica, using the same call. Reports of the broadcasts would be appreciated — the time is Friday from 5:30 to 6:30 p.m., EST **W1KHE** has a jolly time of it for himself. Designated as QSL-forwarder for ZB4UC, VU2XX and CR6XX, he doesn't yet know their identity. Stu worked **PK1XZ** (14,375) at 8:45 a.m. and heard **XU8MI** (7140) at 7 a.m. **W2IOP** says Henry Grimes, **EL2M**, is in this country studying electrical engineering, and Larry can probably wangle a card for you if you didn't get one — **2M** brought his log along **W2EQS** uses the old reliable 210 TNT and an end-fed antenna, but has 60 countries and WAC and WAS. Charlie adds that **HA8S** has a new QTH: Peter Somssich, Budapest XI, Horthy Miklos-Ut 39 IV.5, Hungary **K4FCV** is rapidly becoming an outstanding K4 DX man, if he isn't top one already. He recently received B.E.R.T.A. No. 86, the first in Puerto Rico Nice letter from ex-HB9J — he's still with the military service over there And John Shirley, ex-ZL2JQ, writes from N. Z. to say that he's enjoying a short furlough. From newspaper items we've seen, John had quite an exciting time as radio operator on the boat going back, just missing real trouble on several occasions The old grapevine has it that **W8CRA** is on 'phone, of all things This is really the worst month to knock out a column — the DX Contest is about two weeks off, and everyone has that cat-that-swallowed-the-canary look about him because of the smart ways he has cooked up to win the Contest. By the time you read this, you'll know just how smart some of them were. Anyhow, we hope everybody had a DXciting time.

— W1JPE

Operating News

(Continued on page 80)

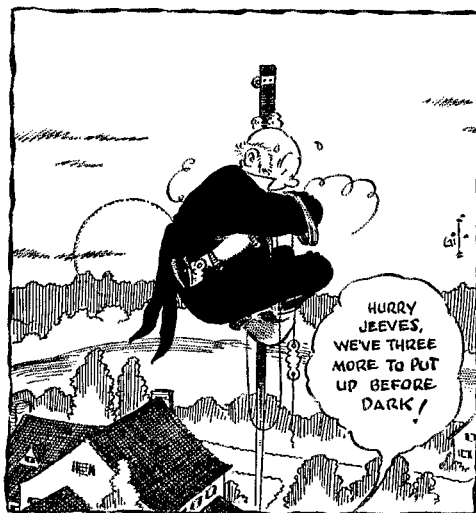

JEEVES

A

2-WAY SAVING

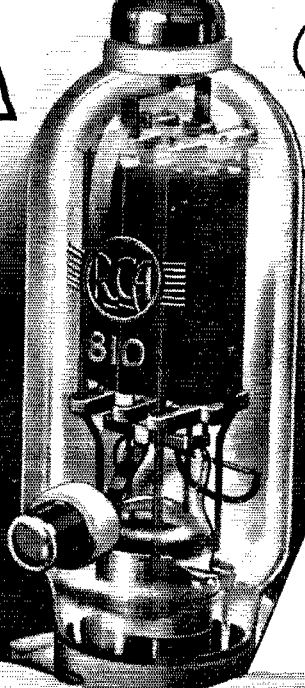

**CATHODE-MODULATED 810'S
CARRIER OUTPUT 320 WATTS***

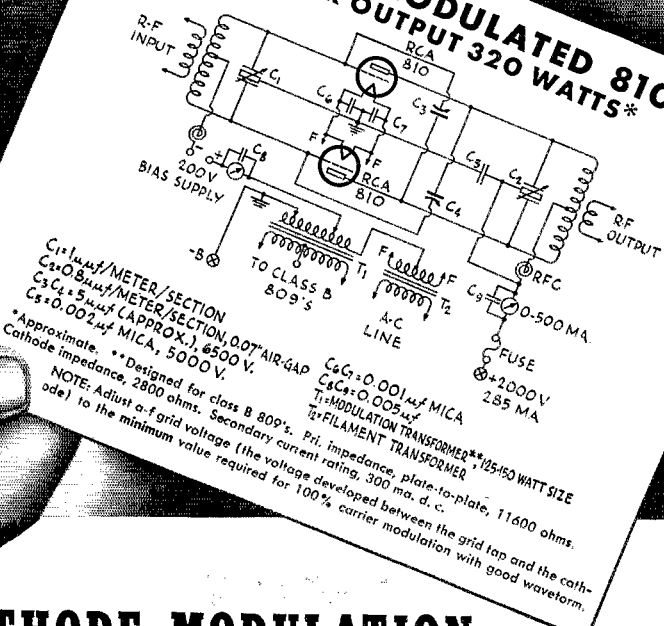

$C_1 = 1 \mu\text{mf}/\text{METER}/\text{SECTION}$
 $C_2 = 0.05 \mu\text{mf}/\text{METER}/\text{SECTION}, 0.07 \text{ AIR-GAP}$
 $C_3 = 0.5 \mu\text{mf}$ (APPROX.), 6500 V.
 $C_4 = 0.002 \mu\text{f}$ MICA, 5000 V.
 $C_5 = 0.001 \mu\text{f}$ MICA
 $C_6 = 0.005 \mu\text{f}$ MICA
 $C_7 = 0.001 \mu\text{f}$ MICA
 $C_8 = 0.005 \mu\text{f}$ MICA
 $T_1 = \text{MODULATION TRANSFORMER} ** 25-150 \text{ WATT SIZE}$
 $T_2 = \text{FILAMENT TRANSFORMER}$
 $F_1 = \text{FUSE}$
 $RFC = 0-500 \text{ MA}$
 $FUSE = +2000 \text{ V}, 2.85 \text{ MA}$

*Approximate. **Designed for class B 809's. Pri. impedance, plate-to-plate, 11600 ohms.
 Cathode impedance, 2800 ohms. Secondary current rating, 300 ma. d. c.

NOTE: Adjust a-f grid voltage (the voltage developed between the grid tap and the cathode) to the minimum value required for 100% carrier modulation with good waveform.

**CATHODE MODULATION
plus RCA HIGH-PERVEANCE TUBES**

Following are ICAS (Intermittent Commercial and Amateur Service) Class C Telegraphy Ratings on several popular RCA Tubes.

RCA-806—Tantalum-plate triode
 Max. plate voltage 3300 V.
 Max. plate input 1000 W.
 \$22.00 Amateur Net

RCA-809—High-mu triode
 Max. plate voltage 1000 V.
 Max. plate input 100 W.
 \$2.50 Amateur Net

RCA-810—High-mu triode
 Max. plate voltage 2250 V.
 Max. plate input 620 W.
 \$13.50 Amateur Net

RCA-811—High-mu triode
RCA-812—Medium-mu triode
 Max. plate voltage 1500 V.
 Max. plate input 225 W.
 \$3.50 each, Amateur Net

When you start out with Cathode Modulation for economical radiotelephony, go all the way! Get double economy plus extra efficiency by using RCA high-perveance transmitting tubes. RCA Tubes last longer. They give you greater power output with less driving power for a given plate voltage. You can get not only 100% modulation, but also relatively high plate-circuit efficiency and high carrier output with the push-pull 810's shown in the circuit above.

The high-perveance of the 810's permits you to obtain optimum results with a low-power, inexpensive modulator such as the class B 809's shown in this circuit. And remember! A cw transmitter using RCA-810's can be changed over to 'phone cheaply and easily. Grid drive requirements are no greater, and a large, high-power modulation transformer is unnecessary.

In short, RCA's are not only economical in themselves but they pave the way for economies throughout your rig—and assure you of ample power to put your signals "where you want them when you want them!"

See *RCA HAM TIPS* (Jan.-Feb., 1940) for further data on Cathode Modulation. Ask your jobber for a copy—free.



Radio Tubes

RCA MANUFACTURING CO., INC., CAMDEN, N. J.
 A Service of the Radio Corporation of America

FIRST IN METAL — FOREMOST IN GLASS — FINEST IN PERFORMANCE

WHY *the* HQ-120-X has SIX BANDS!

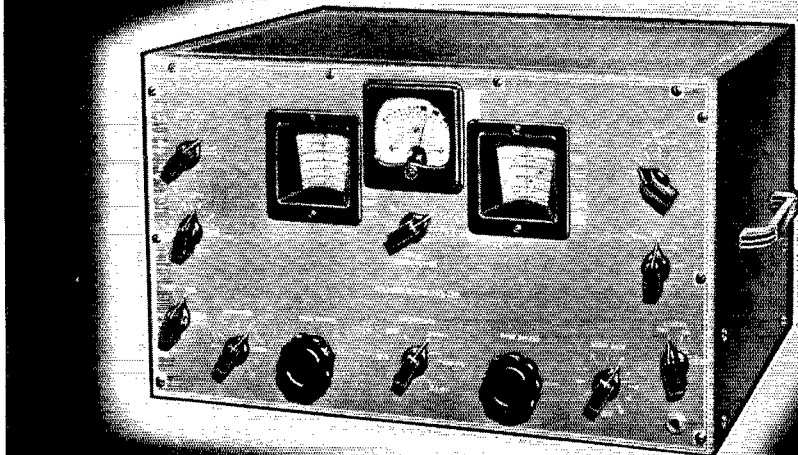

THE "HQ-120-X" range of 31-54 mc. is divided into SIX bands, resulting in better L/C ratio — more uniform gain — and a less cramped dial, making tuning much easier. In the short wave bands, the condenser has 118 mmf. capacity as against over 400 mmf. if the range was crowded into four bands. True, this costs more, but that is why the "HQ-120-X" is better. It wasn't built the cheap way. Ask your jobber to demonstrate the smooth, precise tuning of the "HQ." Then you will realize why we use six bands and a precision tuning condenser. "HQ-120-X" receivers will be found on demonstration at jobbers listed on the opposite page.

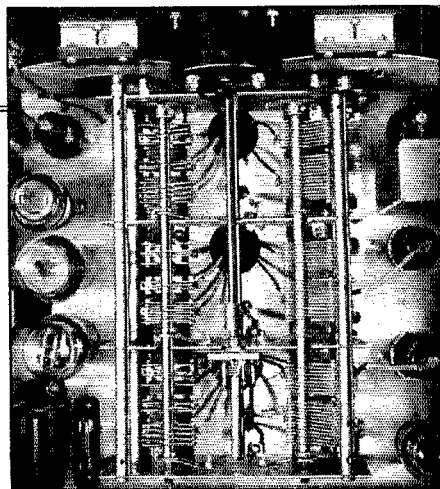

The Hammarlund Mfg. Co., Inc. Q-4
424 W. 33 St., N. Y. City
Please send 16-page "HQ" Booklet
Name.....
Address.....
City..... State.....

CANADIAN OFFICE: 41 WEST AVE. NO., HAMILTON, ONT.

HAMMARLUND

Where to SEE and HEAR.. the HQ-120-X and SERIES-200! SUPER PRO!

ALL of the jobbers listed on this page have "HQ-120-X" receivers in stock. Many also are prepared to demonstrate "Super-Pro" receivers. Visit your nearest Hammarlund jobber for a demonstration. He will also tell you how you can own a Hammarlund for a few dollars a month.

ALABAMA

Forbes & Sons Piano Co.
403 N. 20 St., Birmingham

ARKANSAS

Beem Radio Co.
409 W. 3 St., Little Rock
Williams Hardware
Fort Smith

ARIZONA

Radio Supply Co.
443 W. Washington, Phoenix
Radio Equipment Co.
329 E. 6th St., Tucson

CALIFORNIA

B. J. DeJarnatt
1260 Van Ness Av., Fresno
Pacific Radio Exchange
Ltd.
729 S. Main St., Los Angeles
Radio Specialties Co.
20th & Figueroa, Los Ang.
Radio Television Supply
1701 S. Grand Av., Los Ang.
E. C. Wenger Co.
15th & Harrison, Oakland
Offenbach Electric Co.
Market St., San Francisco
Zack Radio Supply
Market St., San Francisco

COLORADO

Auto Equipment Co.
14th at Lawrence, Denver
Interstate Radio Supply
1639 Tremont Pl., Denver

CONNECTICUT

Radio Inspection Service
227 Asylum St., Hartford
Congress Radio Co.
207 Congress, New Haven
Haty & Young
203 Ann St., Hartford

DELAWARE

Wilmington Elec. Spec.
405 Del. Av., Wilmington

FLORIDA

Glover Weiss Co.
219 W. Adams, Jacksonville

Electric Radio Eng. & Sup.
200 N. E. 2nd Av., Miami

Thurow Radio Dist. Inc.
23 N. W. 12th Av., Miami

ILLINOIS

Allied Radio Corp.
W. Jackson Blvd., Chicago
Chicago Radio Apparatus
So. Dearborn St., Chicago
Montgomery Ward
Chicago
Newark Electric Co.
W. Madison St., Chicago

Klaus Radio & Elec. Co.
707 Main St., Peoria

INDIANA

Van Sickle Radio Supply
W. Ohio St., Indianapolis

KENTUCKY

P. I. Burks & Co., Inc.
911 W. Bway, Louisville

MARYLAND

Radio Elec. Service Co.
3 N. Howard St., Baltimore
Wholesale Radio Parts
312 W. Redwood St., Balto.

MASSACHUSETTS

The Eastern Company
46 Cornhill, Boston
The Radio Shack Corp.
167 Washington, Boston
Sager Elec. Supply Co.
201 Congress St., Boston
Ware Radio Supply Co.
913 Center St., Brockton

MICHIGAN

Radio Specialties Co.
325 E. Jefferson, Detroit
Shand Radio Spec. Co.
203 W. Kearsley St., Flint
Knight Electric Co.
220 N. Wash. Av., Lansing

Fitzpatrick Elec. Supply
42 Concord Av., Muskegon

MINNESOTA

Northwest Radio
109 E. 1st St., Duluth
Lew Bonn Co.
1124 N. Harmon Pl., Minnpls.

MISSOURI

Henry Radio Shop
Butler
Walter Ashe Radio Co.
1100 Pine St., St. Louis

NEW JERSEY

Nidisco
682 Newark Av., Jersey City
Aaron Lippmann
246 Central Av., Newark

NEW YORK

Ft. Orange Radio Dist. Co.
356 Bway, Albany
Dymac Radio
1531 Main St., Buffalo
Davega-City Radio, Inc.
63 Cortlandt, N. Y. City
Harrison Radio Co.
12 W. Broadway, N. Y. City
Harvey Radio Co.
103 W. 43 St., N. Y. City
Sun Radio Co.
212 Fulton St., N. Y. City
Terminal Radio Corp.
80 Cortlandt, N. Y. City
Beaucaire, Inc.
228 Broadway, Rochester

OHIO

Radio Supply Co.
15 E. Central Pkwy, Cinn.
Steinbergs
633 Walnut St., Cinn.
Progress Radio Supply
413 Huron Rd., Cleveland
Standard Radio Parts Co.
135 E. 2nd St., Dayton

OKLAHOMA

Radio, Inc.
1000 S. Main St., Tulsa

OREGON

United Radio Supply Inc.
205 S. W. 9 Av., Portland

PENNSYLVANIA

M & H Sportings Goods
Co.
512 Market St., Phila.
Radio Electric Serv. Co.
7th & Arch Sts., Phila.
Mrs. Wile
10 S. 10 St., Phila.
Cameradio Co.
963 Liberty Av., Pitts.
George D. Barbey Co.
434 Walnut St., Reading

TENNESSEE

Bluff City Distr. Co.
905 Union Av., Memphis

TEXAS

Frank Mayer Co., Inc.
Corpus Christi
Southwest Radio Supply
1905 Commerce St., Dallas
Straus Frank Co.
Houston

UTAH

Radio Supply Inc.
46 Exchange Pl., Salt Lake

VIRGINIA

Five Forks Battery Co.
764 Loyal St., Danville

WEST VIRGINIA

Cameradio Co.
30 12th St., Wheeling

WASHINGTON

Northern Radio Co.
2208 4th Av., Seattle
Seattle Radio Supply
2117 Second Av., Seattle
Wedel Co., Inc.
520 2nd Av., Seattle
Spokane Radio Co.
611 First Av., Spokane

HAMMARLUND MFG. CO., INC.

424 WEST 33RD STREET, NEW YORK CITY

MIMS NEWS

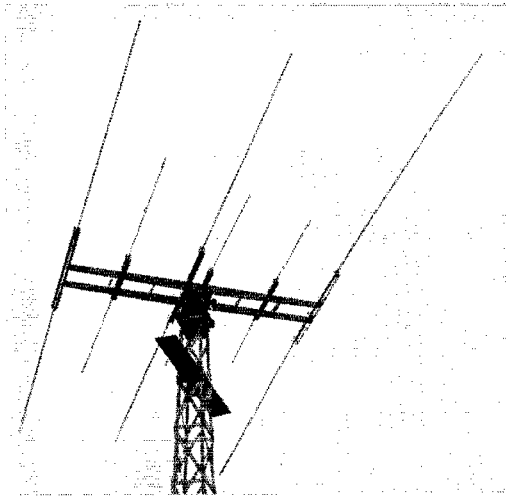

De Luxe Dual Three—10 and 20

TWO-BAND OPERATION

- Full efficiency 10 and 20
- Real unidirectional pattern
- Two separate arrays in one
- Uses two Inductostubs
- Instant changeover — no tuning

Dear OM:

The thrill of drawing a long RF arc seems to be pretty well universally enjoyed. Recently in installing a Dual Three at W5AKZ here in Texarkana, some of the assistants could hardly believe their eyes when some rather "hefty" arcs were pulled from the 10-meter parasitic elements.

The performance of the Three Element MIMS beams offer many greater thrills in their ability to put the signal to the desired spot—and in bringing in the signal from the other end with greatest punch and least QRM.

This is the time of the year to get outside and get yours going too—see your distributor.

73,

M. P. MIMS, W5BDB

See Your Distributor

MIMS RADIO CO.
SIGNAL SQUIRTER
PRODUCTS
TEXARKANA ARK. TEX.

A Complete 56-Mc. I.F. System

(Continued from page 19)

your transmitter or some other strong signal. The converter output can now be transferred to the f.m./a.m. i.f. and the transformers aligned. This is done by plugging in a 0-1 ma. meter in the jack, *J*, and tuning the trimmers of the transformers for maximum current. You may have to hunt around a bit before the meter shows any indication, but once it starts to read the rest is easy. With a variable-frequency signal source, the signal is swung back and forth until some indication is obtained and then the amplifier alignment is completed. The exact frequency of alignment is unimportant as long as every stage can be tuned *through* resonance, which means that each trimmer can be adjusted through a maximum reading of the tuning meter. With the resistors across the circuits, it will be found that the transformers tune a little broader than normal, and the correct setting is in the midpoint of the broad point. Now that transformers T_1 , T_2 and T_3 are aligned, it should be possible to switch Sw_1 to a.m. reception and hear signals, or at least noise if the converter is on 56 or 43 Mc. There isn't much noise on 112 Mc.

The alignment procedure can be carried on with a speaker connected to the output terminals through an output transformer or, if no speaker is used at this point, the terminals should be shorted with a jumper of wire, otherwise the 6F6 may be injured. The meter for alignment is a necessity, and no attempt should be made to line up the amplifier by ear except for very rough initial alignment.

If you live within the range of an f.m. broadcast station, adjustment of the transformer T_4 is a simple matter. Switch the amplifier on a.m., plug in the proper coils in the converter and tune in the f.m. station. It will sound pretty awful but don't worry about that. Switch the amplifier to f.m. and tune around with the trimmers on T_4 until you start to hear the signal again. This is best done with the audio gain almost wide open and the limiter control set at about half scale. The trimmers are best adjusted with an insulated tool, to reduce body capacity effects, and they should be adjusted until the b.c. signal is clearest and loudest. It will be found that one of the trimmers (plate circuit) will affect the volume mostly, while the trimmer in the grid circuit will have the greatest effect on the quality. During this period of adjustment, the receiver is kept tuned to the signal as indicated by maximum limiter current. If one is available, an audio output meter can be used to determine maximum audio output, although it is not an essential.

In the event that there is no local f.m. broadcast station, the only alternative is to line up the discriminator on an f.m. signal from an amateur station or, as a last resort, from a $2\frac{1}{2}$ -meter modulated oscillator. The disadvantage with the modulated u.h.f. oscillator is that it is usually modulated too heavily and it doesn't stay on one frequency long enough to allow the amplifier to be aligned.

(Continued on next left-hand page)

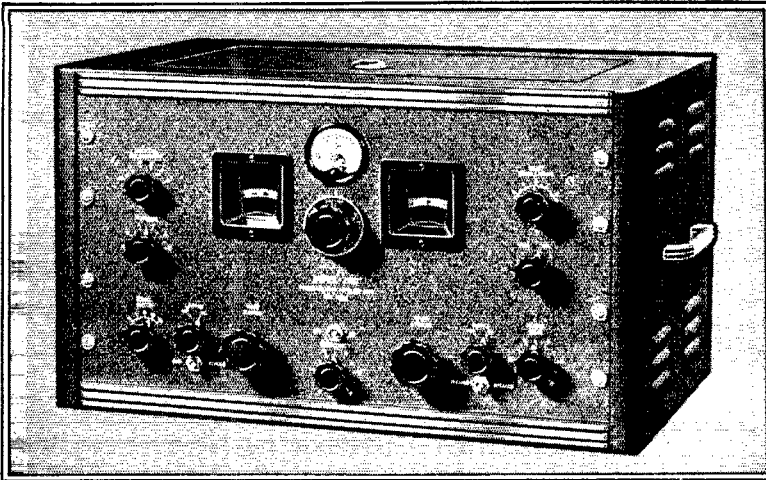

SUPER PRO

"Follow Stations..
THRU
EAR-JAMMING"
QRM...

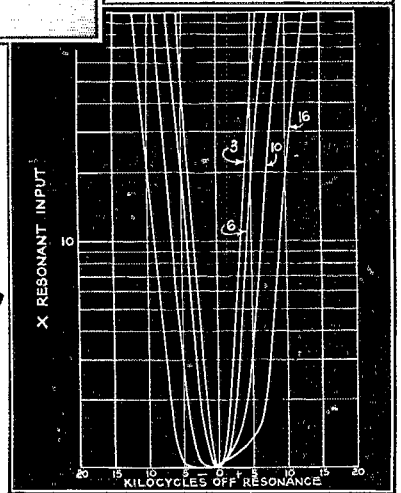

Complete set of selectivity curves

W2IVW SAYS . . . "When the new Super-Pro was placed on the market, I was not the least bit interested, until I heard a salesman in one of the radio stores demonstrate it to a prospective customer. I was intrigued by the noise limiter and before I knew it, I owned one. Its operation was absolutely a revelation to me. I received signals with the noise limiter on, that could not be heard with the limiter off. The variable selectivity of the receiver enabled me to follow stations through the most ear jamming Q.R.M. The operation of the variable crystal filter was beyond belief in eliminating interfering signals." . . . This is typical of the many favorable reports we have received from "Super-Pro" owners. The new Series 200 is going over big with amateurs who want the best that money can buy. Ask your jobber for complete technical information or write direct to the factory.

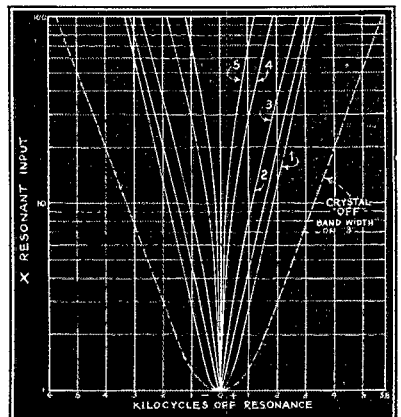

Send for 16-page "Super-Pro" booklet



HAMMARLUND MFG. CO., INC.
424-438 WEST 33rd ST., NEW YORK

CANADIAN OFFICE: 41 WEST AVE. NO., HAMILTON, ONTARIO



YEARS AHEAD

TRIPLET

1941 Model 1696-A

MODULATION MONITOR

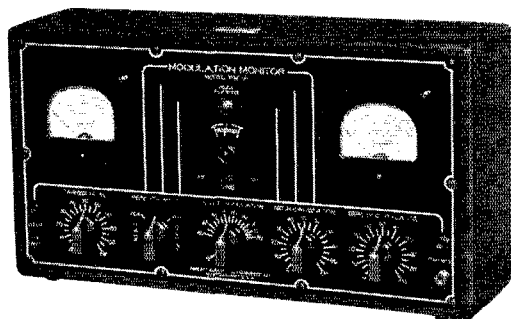

YOU'VE solved your problem of getting maximum efficiency from your transmitter when you invest in a Model 1696-A Modulation Monitor.

And . . . better yet . . . it saves you money by increasing your range without the added expense of remodeling your transmitter. (Amateur experience has shown that a properly modulated 10-watt rig can be as efficient as a 50% modulated 40-watt transmitter.) The Model 1696-A is easy to use. Plug it into your A.C. line — make simple coupling to the transmitter output and the monitor shows:

- **CARRIER REFERENCE LEVEL**
- **PER CENT OF MODULATION**
- **INSTANTANEOUS NEON FLASHER** (no inertia) indicates when per cent of modulation has exceeded your predetermined setting. Setting can be from 40 to 120 per cent.

Use of the monitor permits compliance with FCC regulations. Two RED•DOT Lifetime Guaranteed Triplett instruments. . . Modernistic metal case, 14½" x 7⅝" x 4½", with black suede electro enamel finish. Black and white panel.

Modulation Monitor Booklet — regular purchase price \$1.00 — Furnished FREE with each Model 1696-A. Tells you what you want to know about this monitor, and includes details, including diagrams, for operation of Model 1696-A.

Model 1696-A. Dealer Net Price (U.S.A.) **\$34.84**

For Rack Panel Mounting

Also available as a rack panel mounting unit. Monitor is mounted in heavy steel panel, 19" x 10½", with wrinkle finish. Dealer Net Price (U.S.A.) **\$35.51**

For More Information—Write Section 254 Harmon Drive

THE TRIPLETT ELECTRICAL INSTRUMENT CO.
Bluffton, Ohio

The final adjustment of the discriminator tuning can be checked by tuning in an a.m. signal. If the discriminator is properly tuned, the audio output (signal and noise) should practically disappear at the point that the signal as indicated by limiter current is a maximum. This is an indication that the discriminator characteristic⁴ crosses the axis at the mid-resonance point of the amplifier. Tuning the signal (by tuning the converter), it should be possible to understand the audio output at points either side of this minimum-volume setting. These points should appear symmetrically on either side of the minimum-volume point and should have about the same volume. Slight readjustment of the discriminator-transformer settings will bring this about.

On the f.m. signals around Hartford, the limiter current runs about 0.15 ma., on broadcast signals 5 miles away. The limiter control is moved to reduce the limiter voltage only to the point where effective noise elimination is obtained, which is usually somewhere between half and three-quarters scale, full scale representing zero voltage.

When using the amplifier, it will be noted that the a.m. signals appear to give louder signals than those from f.m. stations, comparing audio-volume-control settings on stations showing equal limiter current. This doesn't indicate that the amplifier isn't working properly nor does it indicate that more audio is obtained from an a.m. signal than from an f.m. signal of similar strength. It is, however, an indication that the discriminator characteristic could have more slope to it and not have its peaks so far apart. We mention this simply to forestall any inquiries on the part of amateurs experimenting with f.m. amplifiers. As discriminator-transformer construction is improved, this apparent shortcoming will disappear.

The performance of the amplifier on a.m. reception could be improved somewhat by the inclusion of a.v.c. on the two 1852 tubes, taking the a.v.c. voltage from the limiter grid leak through the usual filter circuit. However, this was considered an unnecessary refinement because the amplifier will be used primarily on f.m. reception and the provision for a.m. reception was considered of secondary importance. The amplifier should run "wide open" on f.m. reception.

⁴ Fig. 6, page 15, *QST*, Jan., 1940.

Strays

The Drake Electric Works, 3654-56 Lincoln Ave., Chicago, familiar to many amateurs as producers of a line of electric soldering irons, now supplies, free of charge with certain models, a new type of holder. This holder is fitted with a cup filled with steel wool which will be found much more practical than the trousers for keeping the tip of the iron free from oxidization.

Now! FREQUENCY flexibility
with FULL CRYSTAL stability

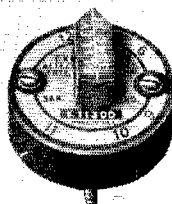

Bliley Vari-X

VARIABLE CRYSTAL OSCILLATOR

The Bliley Vari-X, with VF2 Crystal Unit, combines full quartz crystal stability with the frequency flexibility of a self-excited variable oscillator. Engineered for operating convenience, this crystal controlled variable frequency exciter is easily placed in service. Set the Vari-X beside your receiver, couple it to your present oscillator stage by means of the concentric cable supplied, plug in the a. c. power cord, insert two crystal units and you're all set for action.

Output is obtained on 40 or 80 meters simply by rotating the tuning knob and watching the electric eye for resonance. Either crystal is instantly chosen by a convenient selector switch. To vary the transmitter frequency, simply rotate the knob on the VF2 Crystal Unit in use. If you now have 40 or 80-meter crystal units, of any type, so much the better—they'll work in the Vari-X.

See your Bliley Distributor at once for full details—ask for Circular D-2.

with VF-2 CRYSTAL UNIT

Developed especially for the Vari-X, the VF2 80-meter Variable Frequency Crystal Unit is another outstanding development by Bliley engineers. Mechanically, the VF2 Unit is the same as the well-known VF1 Variable Crystal Unit but, through the application of a special crystal cut, the frequency variation is doubled to approximately 1.2kc. When frequency multiplying, the variation approaches 24kc. at 40 meters and 48kc. at 20 meters.

The VF2 Crystal Unit is intended for use only in low-power oscillators, such as the Vari-X, where crystal heating is negligible. Properly excited, the VF2 Unit provides new wide-range variable frequency crystal control.

BLILEY Vari-X

PAT. APPL'D FOR

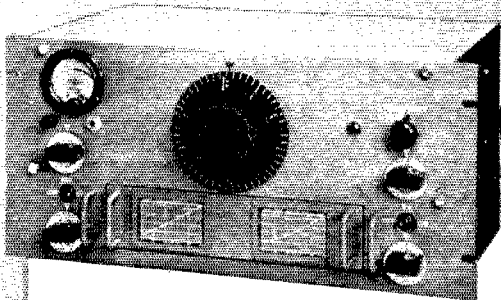

MAXIMUM PERFORMANCE

HRO
\$320.00
List

the standard HRO coils includes two amateur bands and the spectrum between. A switch reconnects them to bandspread the 10, 20, 40 and 80 meter bands over 400 dial divisions.

The Standard HRO, relay rack model, less speaker and power supply has a List Price of \$320.00. A table model is available at \$299.50.

The special Combination Unit illustrated at the right, consisting of power supply, speaker, coil rack and HRO receiver has a List Price of \$432.50.

For those who require the high performance of the Standard HRO but do not need its extreme versatility, the HRO Junior is offered. The circuit and mechanical details of both receivers are identical in every respect, but the lower priced model has been greatly simplified by omitting the crystal filter, the meter, and by designing the coils for continuous bandspread only. The HRO Junior, table model, less speaker and power supply, with one set of coils, has a List Price of \$180.00.

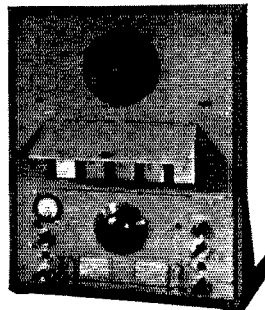

NC-100XA
\$237.50
List

SELF CONTAINED

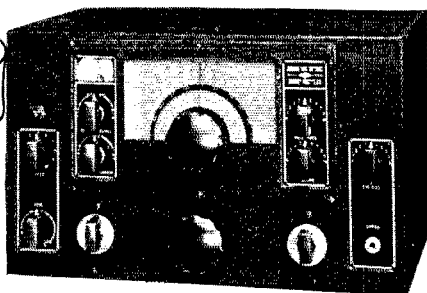

These 11 tube superheterodyne receivers are self-contained (except for the speaker) in a table model cabinet that is readily adapted to relay rack mounting. One stage of R.F. and two stages of I.F. are used. Low loss insulation and high-Q coils give ample sensitivity and selectivity. Separate R.F. and Audio Gain Controls and a signal strength meter

are mounted on the panel. Other controls are tone, CW Oscillator, AVC with amplified and delayed action, a B+ switch, and a phone jack. A self-contained power supply provides all necessary voltages including speaker field excitation. The range changing system is unique in that it combines the mechanical convenience of a coil switch with the electrical efficiency of plug-in coils.

The NC-100XA, illustrated above, covers the range from 540 KC to 30 MC, and is equipped with a crystal filter. The large full vision dial is calibrated directly in megacycles and a separate high speed vernier scale provides high precision in logging. List Price, with tubes and 12" speaker, \$237.50.

The NC-100A is similar, but without the crystal filter. List Price, with 10" speaker in cabinet, \$200.00.

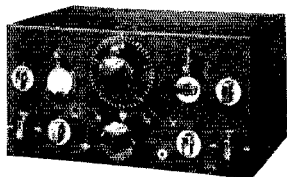

NC-101-X
\$215.00
List

AMATEUR MODEL

The NC-101X, illustrated above, is built strictly for the amateur bands and covers only the following ranges: 1.7-2.05 MC, 3.5-4.0 MC, 7.0-7.3 MC, 14.0-14.4 MC, and 28.0-30.0 MC. The NC-101X is equipped with a crystal filter, S-meter, and the PW type instrument dial. List Price, with tubes and 10" speaker in cabinet, AC Model, \$215.00.

The NC-101XA has the same features as the NC-101X, except for the direct reading dial and the cabinet, which are similar to the NC-100XA. Prices are the same as for the NC-101X.

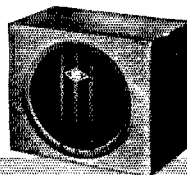

NATIONAL



COMPANY

MODERATE IN PRICE

The new NC-44 Communication Receiver combines capable performance with low price. It employs seven tubes in a superheterodyne circuit.

A straight-line-frequency condenser is used in conjunction with a separate band spread condenser. This combination plus the full vision dial calibrated

NC-44

\$82.50

List

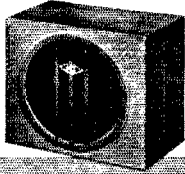
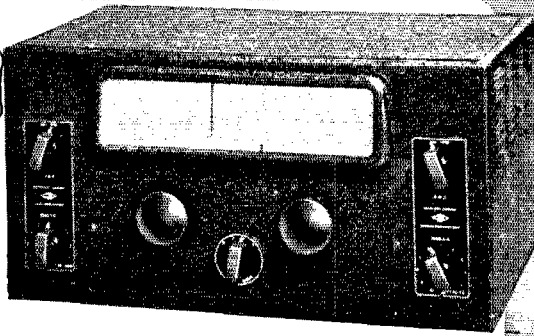

in frequency for each range covered and a separate linear scale for the band spread condenser, makes accurate tuning easy. Both condensers have an inertia-type drive. A coil switch with silver plated contacts selects the four ranges from 550 KC to 30 MC. Provision is made for either head phone or speaker operation.

Like all receivers which have no preselector stage, the NC-44 is not free from images. However, where price is an important consideration, the NC-44 will be found a satisfactory receiver.

The NC-44 is available in three models, for 115 V. AC or DC, for 115 V. AC and for battery operation. Each of the three models lists at **\$82.50**, including speaker in separate cabinet.

FOR THE ULTRA-HIGH FREQUENCIES

NHU

\$275.00

List

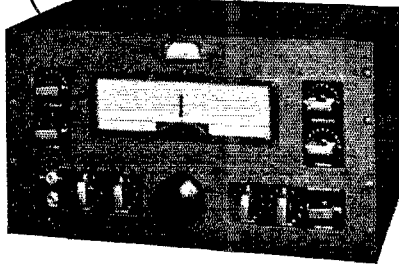

The new National NHU Communication Receiver brings outstanding performance to the range from 27 to 62 megacycles. All features commonly found in the finest communication receivers are provided in the NHU, including a wide range crystal filter.

Many details of the NHU are unique. The RF circuit and tubes are built completely inside the frame of the condenser. The coils are mounted radially in a cast aluminum turret which is easily rotated to position by a knob on the front panel. Inertia-type tuning is used, with a ratio of approximately 70 to 1. The dial pointer is positively driven by rack and pinion, and moves vertically when the coil range is changed, so that it always points to the right frequency.

TYPE NHU, table model, with tubes, and 8" speaker in cabinet but without power supply. **LIST PRICE, \$275.00**

Designed chiefly for the experimenter, the One-Ten Receiver fulfills the need of the experimenter for an adequate receiver to cover the field between one and ten meters.

A four tube circuit is used, composed of one tuned R.F. stage, a self-quenching super-regenerative detector, transformer coupled to a first stage of audio which is resistance coupled to the power output stage. Tubes required: 954-R.F.; 955-Detector; 6C5-1st Audio, 6F6-2nd Audio.

TYPE 110 Receiver and 6 sets of coils, without tubes, speaker or power supply. **LIST PRICE, \$85.00**

ONE-TEN

\$85.00

List

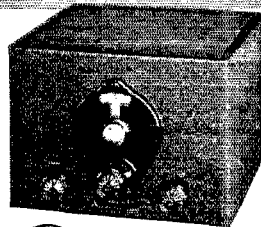
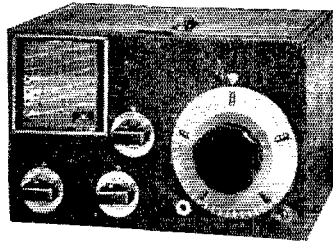

SW-3

\$35.00

List

The SW-3 Receivers employ a circuit consisting of one R.F. stage transformer coupled to a regenerative detector and one stage of impedance coupled audio. This circuit provides maximum sensitivity and flexibility with the smallest number of tubes and the least auxiliary equipment. The single tuning dial operates a precisely adjusted two gang condenser; the regeneration control is smooth and noiseless, with no backlash or fringe howl; the volume control is calibrated from one to nine in steps corresponding to the R scale.

Available in three models, for AC operation or DC operation with 6 volt or 9 volt heaters. **SW-3**, any model, without coils, phones, tubes or power supply. **LIST PRICE, \$35.00**

SIMPLICITY

MALDEN



MASSACHUSETTS

CARDWELL CONDENSERS

For Commercial Application

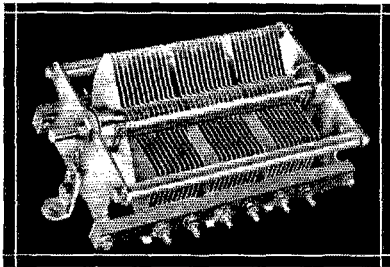

XR
500
PT

★ Ball Bearing CARDWELLS

It should be more generally known that for special LOW TORQUE applications, almost any CARDWELL "X" (Standard) or "M" (Midway) or "N" (U.H.F.) variable capacitor can be supplied on special order, with full ball bearings, at front and rear — or with the standard CARDWELL single ball thrust bearing at rear and a full ball race bearing at the front or shaft end.

When applied to stock items, it is generally necessary to use the next longer standard frame length. Quantity requirements, permit reduction in required increase of frame length, to approximately one half inch.

And the cost for special ball bearings is very reasonable.

Submit your commercial requirements—we will gladly quote

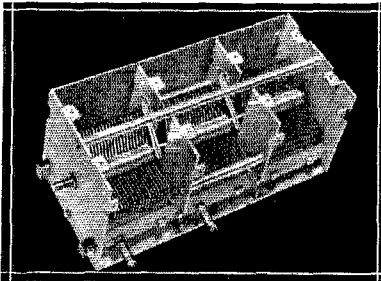

(Top &
Side
Removed)

★ SHIELDED CAPACITOR 870-30 mmfd. per section

For Marine Radio Equipment and other industrial applications requiring shielded, sectional capacitors, CARDWELL offers both "x" type Standard and "Midway Featherweight" elements completely enclosed with dust-proof aluminum shielding. Any side, top or bottom is removable. Between-section baffles with individual rotor contacts are provided. Special end plates are of stamped aluminum and either type can be supplied with ball bearings or standard type.

Straight line capacity or modified S.L.W.

Midway size is 3 1/4" square and the Standard size is 4 1/8" square.

Both above are non-stock items, built on special order only

**THE ALLEN D. CARDWELL
MANUFACTURING CORPORATION**
83 PROSPECT STREET, BROOKLYN, NEW YORK

DX CENTURY CLUB AWARDS

These have been made to the first-listed amateurs, based on contacts with 100 or more countries, the credits all certified by examination of written evidence under the award rules.

W6GRL.....	147	W9KA.....	114	W3ZX.....	105
W2GT.....	147	G5RV.....	114	E1F5.....	104
W8CRA.....	145	W8BK.....	114	W1ZB.....	104
G6WY.....	145	W2DC.....	114	W4AJX.....	104
W2GW.....	144	W1CH.....	114	F8RR.....	104
W2GTZ.....	142	G2DH.....	114	W3BEN.....	104
W1TW.....	141	G5BY.....	114	W1GDY.....	104
G2ZQ.....	141	W1IAS.....	114	W1GCX.....	104
W9JT.....	141	G6CL.....	113	W8DOD.....	104
W6KIP.....	140	W2CJM.....	113	W2BMX.....	104
W1BUX.....	139	W4DRD.....	113	G6KP.....	103
W8DFH.....	139	W2DSB.....	113	W8KKG.....	103
ON4AU.....	139	W3BES.....	113	J2JJ.....	103
W1SZ.....	137	W8MTY.....	113	W5CUJ.....	103
W3EMM.....	137	W2GRG.....	113	W9RCQ.....	103
W6CXW.....	135	W9GDH.....	112	W3KT.....	103
W1TS.....	134	W6GAL.....	112	W9NNZ.....	103
W2BHW.....	134	W3EVT.....	112	W410.....	103
W1LZ.....	133	W3GAU.....	112	W3AGV.....	103
W5VY.....	133	W8QXT.....	112	W4C8Y.....	102
W8DHC.....	132	W6PZL.....	111	W8AU.....	102
G6RH.....	132	W2AAL.....	111	W8OXO.....	102
W8BTI.....	132	W1DUK.....	111	W1FTR.....	102
W4BPD.....	132	VE2AX.....	111	VE2EE.....	102
W2CMT.....	131	ON4AU.....	110	W2BXA.....	102
W8OSL.....	130	PA0XF.....	110	W1GNE.....	102
W8OQF.....	130	W9UM.....	110	W4BVD.....	102
W5BB.....	130	W2AER.....	110	W8JAH.....	102
W8ADG.....	130	W81WI.....	110	L8UN.....	102
W3CHE.....	130	W3FPQ.....	110	F8RJ.....	101
H89J.....	129	W5QL.....	110	W3KXK.....	101
W1PH.....	129	W21YO.....	110	W6DOB.....	101
W3EPV.....	128	W3DDM.....	109	SU1WM.....	101
W8LEC.....	127	W6FZY.....	109	W1CC.....	101
W2UK.....	127	W6HX.....	108	SU1SG.....	101
W2HFF.....	127	Z5ZX.....	108	G6MK.....	101
W2JT.....	127	H89BG.....	108	W4MR.....	101
W9KG.....	126	H89CE.....	108	W6CHU.....	101
W2ZA.....	126	VK3QK.....	108	W6BAM.....	101
W9ARL.....	125	W1BCK.....	108	W8HGW.....	101
W1DF.....	124	W2ARB.....	108	W6KWA.....	101
W8DWW.....	123	W2CBO.....	107	W4EQK.....	101
W4CEN.....	123	G5BJ.....	107	VK6SA.....	101
D4AFF.....	123	W3AG.....	107	W9VDY.....	101
W3EDP.....	122	VK2DG.....	107	LUTAZ.....	101
W8NJP.....	122	W1BGY.....	107	W8AAJ.....	101
W9TB.....	122	G2MI.....	107	W1AB.....	101
W9FS.....	121	VE3QJ.....	107	G6NF.....	100
W5KC.....	121	W9CWW.....	107	W6KRI.....	100
W8JMP.....	120	W7DL.....	107	W9UQ.....	100
J5CC.....	120	W6MVK.....	107	VK2ADE.....	100
W2CZ.....	120	W6AHZ.....	107	ZL1GX.....	100
W3PKY.....	120	G2TR.....	106	H89X.....	100
W1JPE.....	119	W8EUY.....	106	ZL1MR.....	100
W1AXA.....	119	W6TJ.....	106	PA6QF.....	100
ZL1LY.....	118	W9RBI.....	106	W8BSF.....	100
W9ADN.....	118	W1RY.....	106	D3BMP.....	100
W7AMX.....	117	W2VY.....	106	W8JTW.....	100
W9PST.....	117	W3GEH.....	106	W9JBB.....	100
VK5VR.....	117	W8LFE.....	106	W4CCH.....	100
W3EWW.....	116	W2QA.....	105	W8K7W.....	100
W2EP.....	116	G5QY.....	105	W5ASG.....	100
W6ADP.....	115	VK3CX.....	105	W8JIN.....	100
W9EF.....	115	W1ICA.....	105	W8QDU.....	100
W2CYS.....	115	W21OP.....	105	G6GH.....	100
W1WV.....	115	W1ZI.....	105	Radiotelephone	
W4CYU.....	115	W4TO.....	105	W2AZ.....	104
W1ADM.....	115	W2GNQ.....	105	W2GW.....	103
W1HX.....	115	W8LYQ.....	105	W6OCH.....	100
G5BD.....	115	W2AV.....	105		

The following have submitted proof of contact with 75-or-more countries: W11OZ, W2BJ, W9AJA 99; LY1J, W1AVK, W1CBZ, W2ALO, W3A00, W6ADT, W310Q 89; W2JMB, W4TJ, W8AV, W8JG 97; G8G1, W2CTG, W4DMB, W8B0X 96; F8LX, F8BA, G6XL, W3A1U, W3EMA, W4TZ, W8IQE 95; W3FLH, W3GHD, W6TL, W8CJJ, W9BEZ 94; G6ZO, ON4KG, PA0CZ, W2WC, W3OP, W6PKZ, W6MEK, W9JDP 93; SP1LE, W4EJZ 92; W1DOW, W9GBJ 91; D3C8C, W31Z, ON4EB, SP1AR, W3LAU, W6C0V 90; VK3BG, W1KHE, W2CJQ, W8AAT, W9VKF 89; G2DZ, W2E2B, W3JM, W9PGS 88; PY2DN, W6PPE, W6LDJ, W8JFC, W9AEH 87; W1BGC, W6NLZ, W8DAE, W9FLH 86; VK2TL, W4AHP, W4CFD, W6KE, W8GMH, W80FK 85; S16WL, W1BFT, W2AJ, W6AM, W8BWB 84; E4J, OZTCC, VE2GA, W2AWE, W2FLG, W6DTR, W6KUT, W8B1B, W8BWC 83; W1EWD, W3AYS 82; J2LL, W9GY 81; G8RS, LA2X, W1BPN, W2BNX, W2HTV, W3BVN, W3EPR, W3FUF, W40G, W6MHE, W8CED, W8DGP, W8TK, W9JHR, W9CKS, W9GMY 80; W3EJL, W9MRV 79; W3DRD, W3BEV, W4EPE, W4FJN, W9YUN 78; W9HUV 77; PA0JMW, W1EH, W3BSB, ZL1JI 76; W1NI, W3FHY, W6QAP 75.

Radiotelephone: W4CYU 95; W2IXY 91; G5RV, W3EMM 89; W8LFE 87; W1ADM, W1AKY 81; W2KVK 80; W1BLO 77; W2GRG, W9TIZ 75.

"Champ" for Two Years and Still on Top!

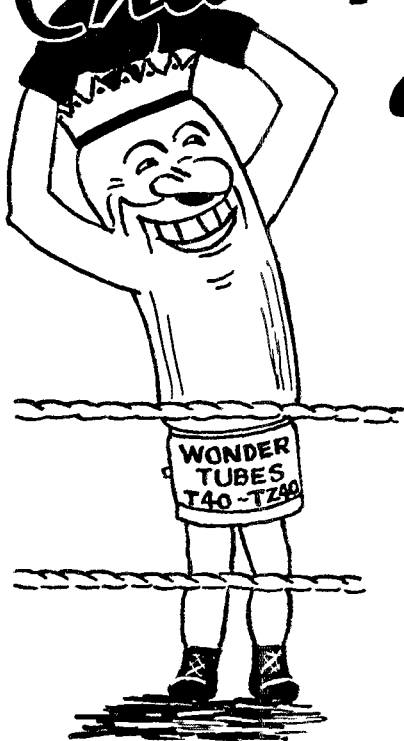

Taylor's

T-40 and TZ-40

TAYLOR WONDER TUBES — T-40 and TZ-40, because of their outstanding performance and value, assumed immediate Sales Leadership upon their announcement 27 months ago. Many "Challengers" have appeared in the \$3.50 price class but the T-40's and TZ-40's still lead. Your parts distributor will testify to this.

The *thinking amateur* insists on the popular Taylor Wonder Tubes because of the greater SAFETY FACTOR made possible by the use of Processed Carbon Anodes. He *knows* that thousands of amateurs recommend T-40's and TZ-40's. *Proof* of this is heard continuously ON THE AIR.

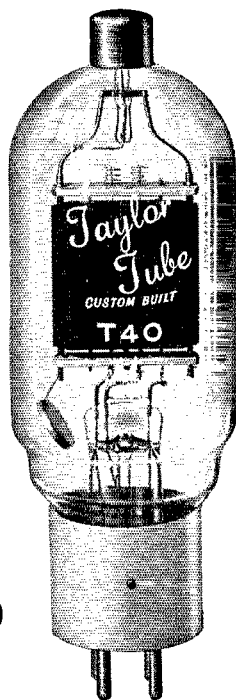

yes — the WONDER TUBES are Champs by ACTUAL FACTS — not by mere claims! 23,000 SOLD TO DATE

DID YOU GET YOUR MANUAL

Send five cents in stamps or coin direct to us or get one FREE from your distributor. All new material. See T-40 and TZ-40 dual ratings . . . 1,500 V. at 150 MA.

All distributors now have TW-75's in stock and are reporting great interest, enthusiasm and sales. The TW-75 is Taylor's newest streamlined beauty in Thin-Wall-Carbon Anode Tubes. Rated at 350 watts input . . . only \$8.00.

\$3.50

"More Watts Per Dollar"

Taylor HEAVY **CUSTOM BUILT** DUTY **Tubes**

TAYLOR TUBES, INC., 2341 WABANSIA AVE., CHICAGO, ILLINOIS

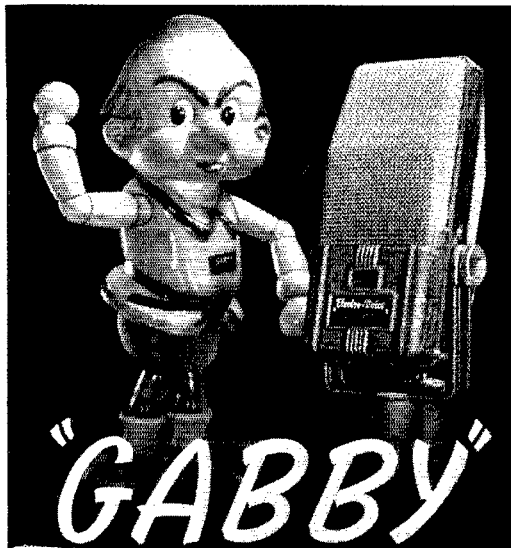

© 1939 Ideal Novelty & Toy Co.

© 1939 Paramount Pictures, Inc.



This colorful, laughable, lovable town crier of Paramount's full length, technicolor cartoon motion picture romance, "GULLIVER'S TRAVELS," is a vibrant personality.

Electro-Voice MICROPHONES

may not, in themselves, be "alive" . . . but they possess clean, crisp highs . . . real vibrant lows . . . true reproduction qualities for precise inflections that convey easy-to-listen-to, pleasing personalities over the air waves.

Have you tried one?

FREE An original 8x10 inch photograph of Gabby (without advertising) will be mailed to amateurs who write for it this month.

ELECTRO-VOICE MFG. CO., Inc.
1239 SOUTH BEND AVENUE
SOUTH BEND, INDIANA

Export Division: 100 Varick St., New York, N. Y.—Cables: "ArLab"

Hamfest Schedule

March 30th, at Baltimore, Md.: The big annual Tri-State Hamfest will be held at the Emerson Hotel, Baltimore, on Saturday, March 30th, under the auspices of the Baltimore Amateur Radio Association (formerly the Mike and Key Club). The usual PB time. Ask anyone who has attended in the past! Valuable prizes. For complete information contact the club secretary, R. W. Rock, W3EKZ, 1621 E. 32 St., Baltimore, Md.

April 6th, at Buffalo, N. Y.: The Kenmore-Buffalo-Tonawanda Radio Club will sponsor the Buffalo Hamfest to be held under the auspices of the Western New York Radio Council on April 6th. The place: Hotel Buffalo. The time: Registration, 2:00 to 5:00 P.M.; Banquet, 7:00 P.M.; Dancing, 11:30 P.M. to 2:00 A.M. Be sure to bring the YL or XYL. Prizes galore, including 150T door prize. Tickets: \$2.00. Guest speaker: John Kraus, W8JK, with an illustrated talk and demonstration on Antennas. A cordial invitation is extended to all.

April 6th, at Framingham, Mass.: The eighth annual hamfest of the Framingham Radio Club will be held Saturday, April 6th, at the Kendall Hotel, Framingham, Mass. Registration at 2:00 P.M., Banquet at 7:00 P.M. Fee, \$2.00. Treasure hunts (56 and 112 Mc.), afternoon speakers and demonstrations, code contests, evening entertainment, plenty of eats (turkey dinner), prizes, fun — a full program for all. Bring your YL or XYL, and Jr. ops. Registration limited to 200. Chairman of Committees: W. W. Fairbanks, W1LPM, Hartford, Garyville, Mass.

April 28th, at Ypsilanti, Mich.: The twelfth annual Michigan Hamfest, sponsored by the Detroit Amateur Radio Association, will be held Sunday, April 28th, 10:00 A.M. to 6:00 P.M., at the National Guard Armory, Ypsilanti, Mich. Speakers include Dr. Woodruff, W8CMP, A.R.R.L. President; L. R. McDonald, W8CW, code speed exhibition. Bigger and better prizes. Entertainment. Plan to be there!

— — —

1.75-Mc. W.A.S. Party "Highs"

WERE you on 160-meters on the week-end of February 17th-18th? If so, you know there was a W.A.S. party under way on those dates!! The reports now reaching us indicate that it was an overwhelming success from every standpoint. There was considerably greater activity than in the first such party, held one year earlier, and the enthusiasm of the participants matched the increased interest. Many operators made contacts with states they never had worked before, placing them that much nearer a W.A.S. certificate award! From the reports so far received, it appears that W9JYW may lead in number of states worked — 41, with W9KOH checking up contacts with 40, and W9YCF and W9WXL 39 each . . . all of which represents some nice stepping on 160. The highest score claimed so far is W8HGW's — 7056, followed closely by W1TS' 7004. It appears that W1BFT heads the list in number of contacts — 221, and W1TS also hit 200. All of this is tentative, subject to checking and additional reports yet to come in, but we're listing some of the high claimed scores. The figures shown below are, in order, score, contacts, and states, in each case. A complete report on the activity will appear in a future issue of QST.

W8HGW	7056-196-36	W8JTH (2 oprs.)	4060-145-28
W1TS	7004-206-34	W9YCF	4056-104-39
W1BFT	6851-221-31	W9TKX	3927-119-33
W3DQ	6685-191-35	W3HXV	3900-130-30
W9KOH	6640-166-40	W9WXL	3900-100-39
W3FDY	6536-172-38	W3BTQ	3660-122-30
W9JYW	5781-141-41	W3DGM	3640-130-28
W1ZK	5070-169-30	W2KVE	3627-117-31
W9OCF	4983-151-33	W4FLS	3434-93-38
W5GYR	4598-121-38	W3CWG	3390-113-30
W5FUA	4572-127-36	W9ENH	3300-100-33
W6AM	4536-168-27	W8OQN	3050-122-25
W1ATE	4526-146-31	W5LVCN	2835-105-27
W8DOD	4495-145-31	W3EUK	2820-94-30
W1ME	4379-151-29	W5HAT	2736-76-36
W1ERX	4257-129-33		
W9UTL	4143-122-34		

(Continued on next left-hand page)



TRANSMITTING TUBES

AMATEUR, BROADCAST, COMMERCIAL, DIATHERMY, ELECTRONICS, FILM—SOUND

AND SO ON THROUGH THE ALPHABET OF POWER TUBE APPLICATIONS—

THIS TUBE IS THE ANSWER

UNITED VERSATILE 70-D

Increase your power with minimum cost and effort if you have been using the lower power types of this general constructor.

This heavy duty V70-D has same base style, and filament voltage. It drives easily, and its similar inter-electrode capacities makes neutralizing simple when used in place of these smaller tubes.

★ **NONEX** means non-expansion and high melting point. To be sure a tube is made of NONEX glass, look for tungsten seal wires, rather than copper clad which is used with soft glass.

\$7.25



VALUING COMPARISONS, V70-D

70 watts plate dissipation
★ Hard glass (nonex) envelope and stem
Heavy gauge tungsten seal wires
SPEER graphite anode
300 watts plate input

MAXIMUM RATINGS PER TUBE

	R. F. Amplifier Class C Telephony	R. F. Amplifier Class C Telephony
	*CCS \ddagger CAS	*CCS \ddagger CAS
Eb	1000 1500 volts	1250 1500 volts
Ec	—260 —260 volts	—260 —260 volts
Ib	165 170 mils	200 200 mils
Ic	40 40 mils	40 40 mils
Input	165 255 watts	250 300 watts

*CCS — Continuous commercial service.
 \ddagger CAS — Intermittent commercial and amateur service.
 Filament: 7.5 volts — 3.2 amperes.
 Amplification factor 20; Rp — 7500 ohms; GM — 2560 umhos.
 Interelectrode capacitance (MMF) G-P 4.5; G-K 4.5; P-K 1.75.

WORLD FAMOUS UNITED MERCURY RECTIFIERS HIGH FREQUENCY AND REGULAR COMMERCIAL TRIODES



HV-18
A very widely used United Tube. Interchangeable with T-200 and HF-200.
See A.R.R.L. Handbook for ratings.
PRICE.....\$22.50

972
This member of the illustrious UNITED rectifier family. Interchangeable with type 872.
Filament volts.....5
Filament current......10
Filament mounting.....exposed
Plate volts (max. inv. peak).....7500
Plate (max. peak) amps......5
NET PRICE.....\$9.00

BW-11
United Electronics is supplying Civil Aeronautics Authority with this type of tube this year. Interchangeable with 834 or 304B.
PRICE.....\$12.00

972-A
Used widely by U. S. Government and important commercial transmitters — interchangeable with 872-A.
Filament volts......5
Filament current......6.75 amps.
Filament mounting.....shielded
Plate volts (max. peak).....10,000
Plate (max. peak) amps......5
NET PRICE.....\$11.00

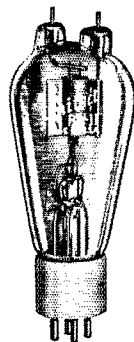

966
The much praised rectifier you hear so much about. Only 5 seconds preheating. Measured minimum mercury avoids amalgams and flash-overs. Interchangeable with 866.
Fil. Volts......2.5
Fil. Amps......5

Exposed Filament
Max. Inv. Volts..7500
Max. Peak Amps...1
NET PRICE.....\$1.50

966-A
Meeting U. S. Government requirements for ample shielding and breakdown test, this mercury rectifier is a world-wide professional favorite. Interchangeable with 866-A.
Fil. Volts......2.5
Fil. Amps......5
Shielded Filament
Max. Inv. Volts.....10,000
Max. Peak Amps...1
NET PRICE.....\$2.50



(Cable "UNELCO")

UNITED ELECTRONICS COMPANY

42 SPRING ST., NEWARK, N. J.

Again it's KENYON

PRESENTING A BRAND NEW FILAMENT TRANSFORMER

With Voltage Dropping Compensator

Designed
Especially for
THE NEW
RCA
811 and 812

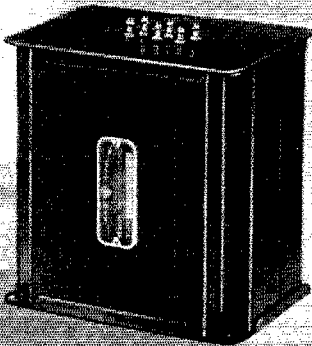

● Here is the latest from KENYON. A brand new transformer with an **EXCLUSIVE FEATURE** built right around two of the most popular tubes to ever hit the amateur market. Fully shielded, fully poured and vacuum impregnated. Constructed in our famous T-line 3-A case.

To compensate for the drop in voltage which usually takes place when the filament transformer is mounted away from the tube sockets, we have provided this unit with a tapped primary* to give the following secondary voltages: 6.3 volts, 6.45 volts and 6.6 volts at 8 amps.

KENYON Number T-387
Amateur Net Price **\$2.40**

*An exclusive feature.

MORE HOT NEWS!

A new Cath-O-Drive transformer designed to handle 120 watts of audio with variable primary and secondary impedances. Just right for the new R.C.A. COMBINATION RIG using p.p. 810's cathode modulated by p.p. 809's. See back cover of this issue for further details.

Kenyon T-474, Amateur Net . . . **\$7.20**

See your jobber at once for all the dope on this transmitter or write us direct for latest information on Cathode Modulation!



KENYON TRANSFORMER CO., Inc.
440 Barry Street, New York, N. Y.

BRIEFS

The Dallas Amateur Radio Club specified Jan. 14th as the date for a Club Field Day at White Rock Lake, near the city of Dallas, Texas. Quite an assortment of portable transmitters and receivers were on hand. A good bit of work was done on 112, 56, 28 and 1.75 Mcs. The highlight of the day was successful two-way communication from sailboat to motor boat, with a shore station acting as control station. The shore station was operating on 1.75 Mc., while the boats were each equipped with 112- and 28-Mc. transmitters and receivers as well as a 1.75-Mc. receiver. Those taking an active part in the proceedings were W5ECA, W5DAS, W5GZH, W5HIP, W5CY, W5III, W5CKH, W5GSE, W5HCS, W5GSR, W5HXA, W5AJG, W5JJ and W5HJX.

WGAN Amateur Radio Dramatizations

Station WGAN (640 kc.), Portland, Maine, is dramatizing the story of amateur radio in a broadcast program series based on Clinton B. DeSoto's book, "Two Hundred Meters and Down." The series started on March 13th and will continue at 7:30 p.m. EST each Wednesday thereafter for ten weeks. Technical advisor for the series is Kenneth B. Woodbury, W1TE, station engineer WGAN. The Portland Amateur Wireless Association is also cooperating in the presentations. Reports on reception of these Wednesday evening programs will be appreciated by WGAN.

Cruise of the "Director II"

The 137-foot three-masted schooner *Director II* left New York on February 1st for a two-year cruise, which will take the party of seventeen to such places as Islas Perlas, Galapagos, Marquesas, Paumotu, Tahiti, Bora Bora, Mangarongoro, Pago Pago, Fiji Islands, New Caledonia, Great Barrier Reef, Solomon Islands, Dutch East Indies, the Celebes, Zamboanga and the Philippines. Director of the expedition is Adam Bruce Fahnestock, Frank O. Chesus, W9ZHC, is radio operator, using the following calls: WDFI (R.C.A.), KFAH (N.B.C.) and W9ZHC (amateur). W1AVB reports their operating time as 4 to 6 p.m., local time wherever the ship may be. Frequencies are not known at this writing. Broadcasts from the expedition are expected to be made via the N.B.C. Blue Network. A.R.R.L. HQ's will appreciate any information regarding amateur contacts with the *Director II*, or data relative to frequencies used.

The Older Hams

CHARLES F. LOUD, WIJIS, and S. H. DOWELL, W5ERV, are cooperating in compiling a list of the "older hams." They want to hear from all hams who are fifty years of age or older and invite them to join their group, which they call "The Old Man Radio Club." We have always maintained that a man never grows old in amateur radio (hi), but it is interesting to note the list already available of the older lads. The most elderly member of the O.M.R.C. is W9CAB, whose photo you saw in February *QST* (page 10). In honor of his birthday on August 11, 1939, the O.M.R.C. showered W9CAB with birthday cards, which came to him as a complete surprise. One card came from as far away as New Zealand. The club is for purely social purposes and for banding together the operators who have reached or passed the half-century mark. Here is the present O.M.R.C. membership, with ages indicated: W9CAB 82; W9CNS 79; XU8MA 78; W8NA 74; W2RT 73; W2GAN 72; W5WN 70; W1ICI 69; W6QBW 69; HI7G W4FLP W5ERV W8QWB 68; LU1DA W7UE 67; W6BKT W8BTO W9EFE 66; W1AWQ W1FA W6BXB W6CEH W6IHH W9VLN 65; W5BSC 64; WIJIS W7FSH W9SXI 63; W6KDX 62; W6PJM W7AXG W7FWD W8TCP 61; W6UO W8MIJ 60; W1AUK W3EQ W6PSF W7FRU W9BXU 59; W7GVH W6PHH 58; W5BEF W8RRC 57; VE4AIX W2MB W2RS 56; W5FMZ W6FMZ W6MZF W6PBD W9MQR 54; W1FZU W3AQM W5CQV W6PLB W9IXN W9NWN 53; W1HK W1HXV W1JPM W1KH W1LYK W1SS W1WV W2KZJ W4EMB W5MR W8CVZ 52; W1DJ W1LE W1JAS W6HKO W6SAH W7FWR 51; W2ATG W2GUW W7ABK W8DK W9CWQ 50.

If you're eligible for listing with the above "older hams," send your date of birth to Charles F. Loud, WIJIS, 46 Beals Court, Rockland, Mass.

(Continued on next left-hand page)

"I bought Eimac tubes because I thought they were OK but after using them I KNOW they are..."



F.F. Priest Jr.—another member of radio amateurs hall of fame who uses Eimac tubes.

W3EMM

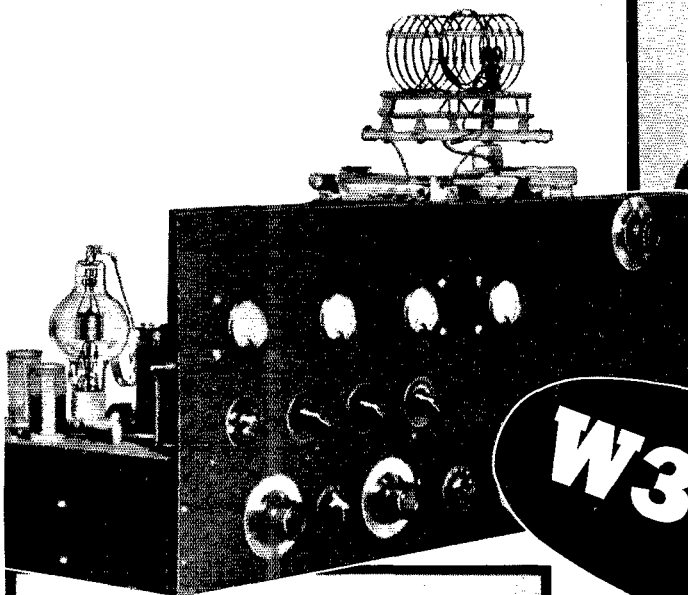

F.F. Priest Jr., owner of amateur station W3EMM, uses a pair of Eimac 250TH's in the final and a 100TH as the driver. His transmitter is a de luxe bread board type ... RF section built on a home made metal chassis ... all stages on the same sub-panel. It runs at 1 KW input "fone" and CW on 10, 20, 40 and 80 meters. Eimac tubes operate efficiently on all bands.

The performance record established by station W3EMM, is not pure luck. Sound judgment in the selection of equipment contributed a great deal to Mr. Priest's success. Neither is it mere chance that most all the leaders among amateur DX stations are users of Eimac tubes.

Follow the lead of these experts and take advantage of the superior capabilities of Eimac tubes. See your dealer for complete data—if he cannot supply you write direct to Eitel-McCullough, Inc. San Bruno, Calif.

250TH
100TH
EIMAC

Eimac
TUBES

**FOR THOSE WHO
WANT THE BEST**

**50% MORE
R. F. OUTPUT*
on 'PHONE!**

at no extra cost by using
the HY69 BEAM tetrode
in your final amplifier

Increased power output with the Hytron HY69 is possible for it has a 40-watt* plate dissipation compared with 25 watts for the equivalent cathode types. When plate modulated it is not necessary to reduce the plate input power to the HY69 for the additional audio power input is safely dissipated by the 40-watt anode.

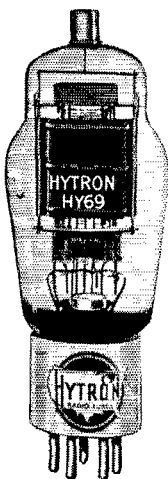

HY69 \$3.50 net

PHONE RATINGS*

Plate and Screen Modulation

Filament.....6.3 volts @ 1.5 amperes
Plate input (max.) ..600 volts @ 100 ma.
Screen input..... 225 volts @ 10 ma.
D.C. grid current (approx.)......4 ma.
R.F. driving power (approx.)..0.25 watt
R.F. carrier power output......36 watts

**Above ratings are for continuous-service operation providing most-watt-hours output per dollar. Full ratings up to 60 megacycles (5 meters). Fully shielded for R.F. —no neutralizing required.*

Truly a universal tube, the HY69 is highly efficient as an oscillator, power doubler, buffer, final amplifier, Class A and B audio amplifier-modulator. As a modulated doubler 27 watts R.F. carrier can be obtained — 30 watts unmodulated.

Use the HY69 in your main transmitter — swap to your portable for summer uses — design the emergency rig for it.

Complete details
from your jobber
or factory.



On sale at all
leading radio distri-
butors.

A DIVISION OF THE
HYTRON CORP.

23 DERBY ST.
SALEM, MASS.

**HYTRON
LABORATORIES**

MANUFACTURERS OF RADIO TUBES SINCE 1921

"Now It Can Be Told"

AT THE office one morning last May I was introduced to a special investigator from Chicago who asked if I could help in an extortion note apprehension by communicating via shortwave radiophone between an aeroplane and a ground station. He explained that a certain local elderly couple had been threatened with death if they did not drop a certain large sum of money from an aeroplane which was to start from over Independence and circle the city in enlarging circles, watching for a smoke signal on the ground, at which point the box of money was to be dropped. We had a little more than 24 hours to prepare before the time set for the flight.

The special investigator, Chief of Police of the city, and myself drove 100 miles to Tulsa, Okla., to engage a plane equipped with a two-way radiophone and make arrangements for the flight and radio link. I was given a special low-frequency crystal and told the frequency on which the plane would transmit. Back home again, I worked until after midnight tuning the rig for the new frequency.

The morning of the big day was used in testing several cars equipped with regular broadcast car radio sets adjusted to tune to my frequency. Several township maps were divided into numbered zones and the plane and each car, as well as the radio station, provided with these identical maps. A car was placed in each of these zones. The special investigator, two state highway patrolmen, the sheriff of the county, the sheriff of the adjoining county, their deputies, and later the F.B.I. and several deputies joined the set-up. There were seven cars used, manned by two or more deputies with machine guns, etc.

The Chief of Police, pilot and radioman flew from Tulsa and were in contact with W9WGW all during the flight. The plane making the circles around the city would report when over each zone and the ground station would move each patrol car accordingly. After the two different flights the cars were maintained and directed for 24 hours by the F.B.I. agent. W9WGW was made the headquarters and the city telephone was put on a secret number known only to a small group. The station was guarded and patrolled during the entire time of the activity. There being no police radio here, amateur radio was called upon by the law-enforcing bodies to assist. Amateur radio worked 100% without a break. The F.B.I. agent offered to take care of necessary correspondence in getting any special F.C.C. authorizations for frequency and call used.

— Ralph W. Elliott, W9WGW, Independence, Kansas

The XYL Club of Phoenix, Ariz., is planning an active spring season under the leadership of Mrs. G. E. Evans, president, Mrs. I. W. Brayer, secretary, and Mrs. Art Thomas, treasurer. This club was organized in 1939 as an auxiliary of the Phoenix Radio Experimental Society. Meetings are held on the second and fourth Tuesdays each month. On February 15th a bridge and bunco party was held to raise funds for the coming Arizona Hamfest, of which they are hostesses. Many other successful parties have been held. If any other XYL clubs want to organize with the view to showing the men how it's done, they are invited to write the Phoenix group for suggestions and help. If interested, communicate with Mrs. G. S. Evans, 2801 S. Culver St., Phoenix, Ariz.

It is a long time between QSO's — sometimes. On July 22, 1924, W2AEY and W3DK had their first contact. On February 14, 1940 — seventeen years later — they had their second contact. Both stations are still in original cities, Elizabeth, N. J., and Washington, D. C., and have the original QSL cards for the first QSO.

April 20th, at Fresno, Calif.: The San Joaquin Valley Radio Club will hold its fourth annual hamfest on April 20th in the Fresno New Memorial Auditorium. Elaborate plans are being made to entertain some five hundred amateurs and their friends. Activities during the afternoon will feature outstanding events for the ladies and hams alike. In the evening a colorful banquet, flower show, vaudeville and prize awards will be followed by visits to many of the local ham shacks. Registration fee of \$1.50 covers the entire program. Those desiring further information should correspond with Erwin S. Martin, W6HYR, 172 Echo Ave., Fresno, Calif.

(Continued on next left-hand page)



A UNIQUE "Switch Board" TRANSFORMER DESIGNED ESPECIALLY for AMATEUR PURPOSES

The THORDARSON MULTI-MATCH is the only modulator transformer built with the plug-in-jack terminal board. It allows quick

and accurate matching of tube loads without soldering — simplifying experimental circuit changes. Check these types listed below.

Type No.	Net Price	Cap. Watts	Pri. M.A. Per Side	Sec. M.A.		Mtg. Fig.	Dimensions			Wt. Lbs.
				Series	Par.		W.	D.	H.	
T-11M74	\$ 5.40	40	100	80	160	3G	4	4½	4¾	7¾
T-11M75	7.50	75	145	145	290	3G	4	4½	4¾	9
T-11M76	11.70	125	210	160	320	3G	5½	5½	6	18
T-11M77	18.00	300	250	250	500	3G	6	7½	7½	30
T-11M78	36.00	500	320	320	640	3G	7	8¾	7½	51

ASK YOUR PARTS DISTRIBUTOR FOR CATALOG NO. 400-D.

THORDARSON
Elec. Mfg. Co., Chicago

45th Anniversary

TRANSFORMER SPECIALISTS SINCE 1895

Type A-21 ATTENUATOR

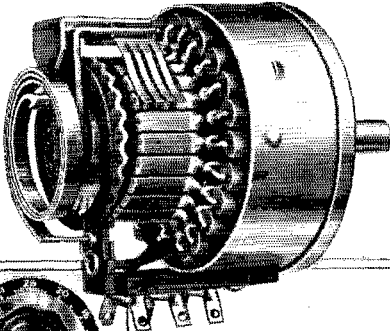

20 STEPS

SNUG DUST COVER

BERYLLIUM COPPER CONTACTORS

CLOCK SPRING CONNECTOR

IRC INSULATED RESISTORS

- Ladder pad or Potentiometer types, 2" diameter by 2" deep.



Type	Impedance	Network	NET
A-21L50	50 ohms	Ladder	\$7.00
A-21L200	200 "	Ladder	7.00
A-21L250	250 "	Ladder	7.00
A-21L500	500 "	Ladder	7.00
A-21-250M	250,000 "	Potent	6.75

Write for catalog giving full details on above — also listing 30-step (Type B-31) and bridged-T types

INTERNATIONAL RESISTANCE COMPANY

401 NORTH BROAD STREET
PHILADELPHIA, PA.

ELECTION NOTICES

To all A.R.R.L. Members residing in the Sections listed below: (The list gives the Sections, closing date for receipt of nominating petitions for Section Manager, the name of the present incumbent and the date of expiration of his term of office.) This notice supersedes previous notices.

In cases where no valid nominating petitions have been received from A.R.R.L. members residing in the different Sections in response to our previous notices, the closing dates for receipt of nominating petitions are set ahead to the dates given here-with. In the absence of nominating petitions from Members of a Section, the incumbent continues to hold his official position and carry on the work of the Section subject, of course, to the filing of proper nominating petitions and the holding of an election by ballot or as may be necessary. Petitions must be in West Hartford on or before noon of the dates specified.

Due to resignations in the Alaska and Montana Sections, nominating petitions are hereby solicited for the office of Section Communications Manager in these Sections, and the closing date for receipt of nominations at A.R.R.L. Headquarters is herewith specified as noon, Monday, April 15, 1940.

Section	Closing Date	Present SCM	Present Term of Office Ends
Kentucky	Apr. 1, 1940	Darrell A. Downard	Apr. 15, 1940
Alabama	Apr. 1, 1940	James F. Thompson	Apr. 15, 1940
Alaska	Apr. 15, 1940	Leo E. Osterman (resigned)
Montana	Apr. 15, 1940	G. A. Woodhouse (resigned)
Philippines	Apr. 15, 1940	George L. Rickard	Oct. 15, 1938
Indiana	Apr. 15, 1940	Noble Burkhardt	Apr. 15, 1939
Idaho	Apr. 15, 1940	Carl Eichelberger	June 15, 1939
San Diego	Apr. 15, 1940	Howard K. Breedlove	Dec. 16, 1939
Virginia	Apr. 15, 1940	Charles M. Waff, Jr.	Jan. 17, 1940
Alberta*	Apr. 15, 1940	C. S. Jamieson	Feb. 18, 1940
South Dakota	May 1, 1940	Dr. A. L. Russell	May 18, 1940
Maritime*	June 3, 1940	Arthur M. Crowell	June 15, 1940

* In Canadian sections nominating petitions for Section Managers must be addressed to Canadian General Manager, Alex Reid, 169 Logan Ave., St. Lambert, Quebec. To be valid such petitions must be filed with him on or before the closing dates named.

1. You are hereby notified that an election for an A.R.R.L. Section Communications Manager for the next two-year term of office is about to be held in each of these Sections in accordance with the provisions of the By-Laws.

2. The elections will take place in the different Sections immediately after the closing date for receipt of nominating petitions as given opposite the different Sections. The Ballots mailed from Headquarters will list in alphabetical sequence the names of all eligible candidates nominated for the position by A.R.R.L. members residing in the Sections concerned. Ballots will be mailed to members as of the closing dates specified above, for receipt of nominating petitions.

3. Nominating petitions from the Sections named are hereby solicited. Five or more A.R.R.L. members residing in any Section have the privilege of nominating any member of the League as candidate for Section Manager. The following form for nomination is suggested:

(Place and date)

Communications Manager, A.R.R.L.,
38 La Salle Road, West Hartford, Conn.

We, the undersigned members of the A.R.R.L. residing in the Section of the Division hereby nominate as candidate for Section Communications Manager for this Section for the next two-year term of office.

(Five or more signatures of A.R.R.L. members are required.) The candidates and five or more signers must be League members in good standing or the petition will be thrown out as invalid. Each candidate must have been a licensed amateur operator for at least two years and similarly, a member of the League for at least one continuous year, immediately prior to his nomination or the petition will likewise be invalidated. The complete name, address, and station call of the candidate should be included. All such petitions must be filed at the headquarters office of the League in West Hartford, Conn., by noon of the closing date given for receipt of nominating petitions. There is no limit to the number of petitions that may be filed, but no member shall sign more than one.

4. Members are urged to take initiative immediately, filing petitions for the officials for each Section listed above. This is your opportunity to put the man of your choice in office to carry on the work of the organization in your Section.

— F. B. Handy, Communications Manager

ELECTION RESULTS

Valid petitions nominating a single candidate as Section Manager were filed in a number of Sections, as provided in our Constitution and By-Laws, electing the following official, the term of office starting on the date given.

British Columbia	C. O. I. Sawyer, VE5DD	Feb. 15, 1940
------------------	------------------------	---------------

Add Code Practice Stations

Station	Frequency	Days	Hours
W8FU W. N. Y.	1761 kc.	Tuesdays	7:00-7:30 P.M. EST
W5ARS Texas	1838 kc.	Mon. through Sat.	7:00-7:30 P.M. CST
W9EBT Ill.	1935 kc.	Tues. and Thurs. Sundays	6:30-7:30 P.M. CST 9:00-10:00 A.M. CST

RAYTHEON RK

TRANSMITTING TUBES

KIT FOR FEB. QST

2 1/2 METER

FREQ. MOD. TRANSMITTER

RK-34.....\$3.50

2 RK-49's2.50

TOTAL \$6⁰⁰



RK-34 IDEAL FOR 2 1/2

EP 300 VOLTS
EF 6.3 VOLTS
PLATE DISSIPATION
10 WATTS \$3⁵⁰

RK-49

ORIGINAL 21 WATT
CERAMIC BASE
BEAM TUBE

NOW \$1²⁵



New
ICAS
Rating

10,000 Volts

Inv.
Peak

866
\$1⁵⁰

3200 VOLTS DC
FROM A PAIR IN CHOKE
INPUT CIRCUIT

New rating made
possible by improv-
ed manufacturing
technique

NEW TETRODE

500 Watts C.C.S. Output
60 Megacycles 4-7 watts drive

NO NEUTRALIZING

Reduced output at 120 mega-
cycles

70 Watt Filament

100% Tantalum and Tungsten
internal construction

Heavy Direct Grid Leads

LOW CAPACITIES

C output 4.75 mmf

C input 10.5 mmf

Cgp .36 mmf

RK-65

STANDARD 50 WATT BASE

Ef = 5 volts

If = 14 amps

Ep = 3,000 volts max.

Ip = 250 ma. max.

Plate Dissipation 215 watts
max.

\$34⁵⁰

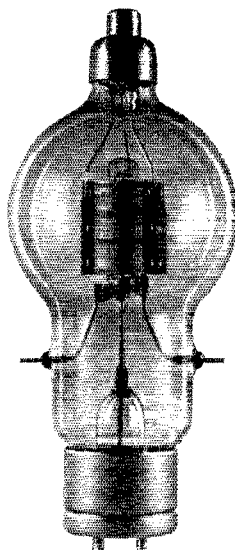

RAYTHEON PRODUCTION CORP.

NEWTON, MASS ■ NEW YORK ■ CHICAGO
SAN FRANCISCO ■ ATLANTA

(Continued from page 53)

QST BACK COPIES

The back copies of QST contain the record of development of modern amateur technique. They are invaluable as technical references. Our supply of earlier issues is already exhausted, but many since 1925 are still available.

1925 copies — (except Jan., Mar., May and July).....	\$2.00
1926 copies — complete	2.50
1927 copies — (except Jan., Feb., Mar., Aug., Sept.).....	1.75
1928 copies — (except Jan., Feb., Mar., Aug., Sept.).....	1.75
1929 copies — complete	2.50
1930 copies — (except Jan., Feb., Apr. and July).....	2.00
1931 copies — (except November) ..	2.50
1932 copies — (except Feb., July, Aug., Sept., Oct.).....	1.75
1933 copies — (except January and February).....	2.50
1934 copies — complete	2.50
1935 copies — complete	2.50
1936 copies — complete	2.50
1937 copies — complete	2.50
1938 copies — complete	2.50
1939 copies — complete	2.50

Single copies, 25¢ each, and Yearly Sets at Price Indicated, Postpaid

Foreign, add 50¢ for Yearly Sets

American Radio Relay League
West Hartford, Conn.

"Nothing of importance, other than the relay, happened from Jan. 25th until Feb. 14th. During this evening the five-meter band was very much alive for work into the fourth and fifth call areas, as evidenced by very strong harmonics from ten-meter stations in these areas; but, again, no contacts were made because no one seemed to be on Five down there. During the winter months conditions are often right to provide good contacts with W4 and W5 from the ninth area, but activity in the fourth and fifth nearly always seems to be lacking — so we beseech, entreat, and bawl you fellows out — all in the same breath — to get on and give us more contacts with W4 and W5! . . . Last minute news: W9RGH has just eased 500 watts into a pair of 100TH's — it makes a swell signal! So be on the lookout for the W9's. You can depend on it — when the band opens up we'll be on the job!"

If only this sort of enthusiasm for u.h.f. work were in evidence in a few other sections of the country! There'd be far fewer "dead nights" on Five for fellows like W5AJG, W6FYF, W6QLZ, W6OVK, W9ZJB, W9VWU, and many other die-hards who keep their u.h.f. gear hot the year round, whether any other sigs are heard or not!

W9ZJB reports hearing W7AXS on 28,050, calling "CQ UHF Relay" every five minutes starting at 3:30 p.m., Sunday. Vince listened vainly on Five for some sign of the signal, and kept calling him on Five but without success. We have had no reports recently from W7. How about it, W7AXS, are you a "voice crying in the wilderness" or have you got 56-Mc. company out there in Washington? Vince heard plenty on Valentine's Day, Feb. 14th, but had the misfortune to blow a transformer just as things were opening up. He reports hearing some W1's, a fellow on 56,050 located near Camden, some of the boys in Atlanta, and the harmonic of a ten-meter W5. The band seemed to be as hot as summer conditions, DX lasting from 6:30 to around 9 p.m.

INTERNATIONAL NOTES:

There are still some u.h.f. enthusiasts in Great Britain, despite the fact that they have no signals of any description to listen to. G8LY, who conducts the u.h.f. column in the "T & R Bulletin" tells us that if we could definitely have some stations active during weekends between 1330 and 2200 G.T., a few G's would be able to listen. Though there seems to be little chance of transatlantic work by means of F₂ Layer reflection, it does seem that a fortunate combination of sporadic-E in the right places might turn the trick. We suggest that it might be a good stunt to make a practice of calling CQ on c.w. on the hour during these periods. In any case, the more frequent use of c.w. would certainly help to extend our range considerably. We think the idea of using c.w. during Sunday morning workouts would work wonders. Conditions are frequently better for extended-local work during the morning hours than in the evening, and we all know how often the band has opened up for skip around noon or shortly before. And who knows — with no QRM of any sort, some of the G's might hear us. It's worth a try, in any case.

112 MC.:

Frequency modulation seems to be taking hold gradually among the 112-Mc. enthusiasts. In New England, W1KH, Weston, Mass., and W1ELP, located at Harvard University, completed what is believed to be the first two-way contact on 112 Mc. in which controlled f.m. was used at both ends. The rig at W1KH is a duplicate of the RK-34 job described in February QST, while W1ELP has 100 watts input to a pair of HK-24's tripling. Sigs are much stronger than with self-controlled oscillator jobs of similar power, yet they occupy less space on the average receiver.

W1HDF, Elmwood, Conn., has a pair of HK-54's tripling to 112 Mc. and will have f.m. shortly. W1LFS, Bristol, is a new recruit. Len has crystal control and is getting set for f.m. at this writing. W1EYM has an f.m. superhet and a rig all set to go when he returns from Florida. At Wilbraham we will have to forego f.m. until we can arrange to triple to 2½ instead of doubling in our TZ-40 driver stage, as we do now. We get a slight transfer of energy into our antennas for Five from the doubler grid, and with a location like ours,

(Continued on next left-hand page)

The "Traffic Master" has it!

530 KC
to
32.4 MC

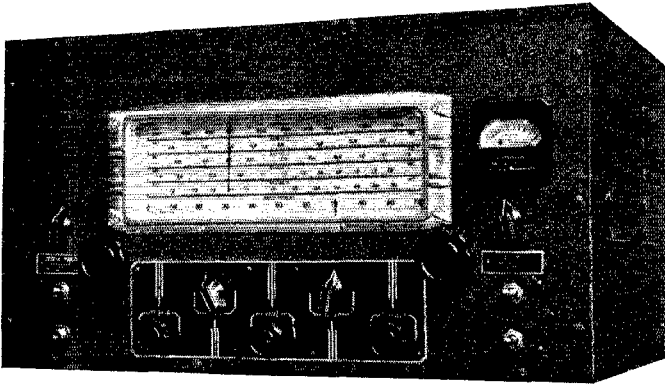

Only
\$88~~00~~
Net

Features You've Always Wanted —



AIR-TRIMMED R-F COILS

Each individually-wound R-F, Mixer and Oscillator coil is provided with its own Align-Aire trimmer. The use of air-dielectric trimmers instead of the mica-compression type greatly improves frequency stability.

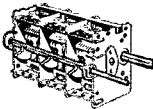

ELECTRICAL BANDSPREAD

The special, three-gang, ceramic-insulated tuning condenser has separate tuning and bandspread rotors. Extremely accurate and easy to tune in crowded bands when used with the large dual-drum dial.

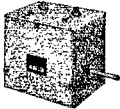

MONO-UNIT CRYSTAL FILTER

The Crystal Filter is a complete factory-wired and aligned unit containing input and output crystal I.F. transformers, 456-kc crystal, phasing condenser and cut-out switch. Air-dielectric trimmers.



ALIGN-AIRE I-F TRANSFORMERS

The finest I-F Transformers made by Meissner; super-efficient, High-Q windings in large shields, bus-bar lead connections and Align-Aire air-dielectric trimmers for maximum stability and permanence of adjustment.



MONO-UNIT B-F OSCILLATOR

Another complete factory-wired and adjusted unit; includes beat-oscillator coils, air-trimmer, pitch adjustment, oscillator tube socket and associated resistors and condensers. Only three connections.

— AND MANY OTHER UNIQUE FEATURES!

TIME PAYMENT PLAN

The Meissner Traffic Master as well as many other Meissner products, may be easily purchased on the Meissner Time Payment Plan. Ask your parts Jobber for details or write direct to the address below.

Haven't you often dreamed of the kind of a "ham" set you'd like to have—the many helpful features you would like to include in its design—all based on your own operating experience?

We have designed just that kind of a receiver for you—not from your individual experience but from that of hundreds of hams all over the world who have told us what they would like to have. The Traffic Master is a big, 14-tube Communications receiver, especially designed to provide maximum operating performance under the severest conditions.

It simply "HAS EVERYTHING!" Pre-aligned Tuner assembly, Crystal-Filter, two-stage I-F, B-F Oscillator, "R" Meter, AVC switch, Stand-by switch, Phone jack, RF Gain control, Audio Gain control, Tone control, Noise Silencer, Phase-Inverter and push-pull 6V6 output tubes. Most important of all, is the unusual frequency stability designed into the entire receiver.

VOLTAGE REGULATED power supply using a VR-150 tube is incorporated.

The best part of this news is the fact that this remarkable receiver is sold as a complete kit—ready for you to build, with a big saving in cost! All the hard work has been done—chassis is all punched—parts are all ready to be mounted. Complete printed instructions are supplied, with schematic and pictorial wiring diagrams. A few interesting hours with soldering iron, screwdriver and pliers will easily finish the job.

See your jobber at once or write for further details!

WRITE FOR FREE CATALOG

Dozens of other products of interest to the Amateur who values equipment performance are described in the big 48-page Meissner catalog. Send a postal for your free copy today—just address Dept. Q-4.

 **Meissner** MT. CARMEL ILLINOIS

"A FAMOUS NAME FOR TWO DECADES"

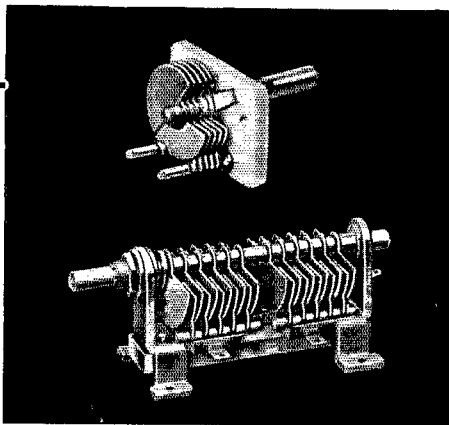

Designed for Application

● The new MILLEN line of MODERN PARTS for MODERN CIRCUITS includes: transmitting condensers, receiving condensers, sockets, Quartz Q coil forms, standoffs, dials, IF transformers, RF chokes, safety terminals, etc., etc.

Catalogue Upon Request

JAMES MILLEN MFG. CO. INC.
150 EXCHANGE ST. MALDEN, MASS.

NOISE-FREE RECEPTION

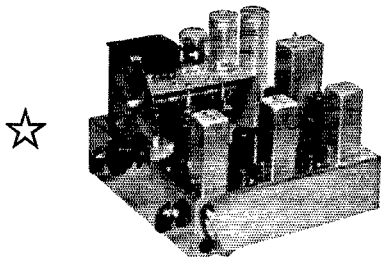

● Major Armstrong's wide-band frequency-modulation system is the latest development in radio reception and transmission. Famous for its freedom from static, it is equally remarkable for its ability to transmit the full dynamic and frequency range of the original program.

● The Browning Frequency-Modulation Adapter offers an outstanding opportunity to progressive service men. It may readily be connected to the audio system of an existing receiver and placed within the console. Or, with the addition of an audio amplifier and speaker it becomes a complete radio in itself. High quality components provide superior performance and thorough engineering makes installation easy. Write for Bulletin 105.

BROWNING LABORATORIES
WINCHESTER, MASS.

U.H.F. MARATHON W2MO Wins First Month Certificate

COMPLETE JANUARY REPORT -- EARLY REPORTS FOR FEBRUARY

Call	January Contacts 86 112 224	January Score	February Report ¹	States in 1940
W1ATY	12	1	33	2
W1CLH	10	—	16	2
W1DJ	45	66	16	4
W1EHT	18	21	22	2
W1EKT	24	30	20	2
W1GJZ	18	40	40	4
W1JP	—	—	13	1
W1HDF	20	1	39	3
W1HDQ	22	5	78	6
W1JAX	14	27	—	3
W1JK	21	43	32	2
W1JTG	—	—	86	1
W1KJC	14	43	18	3
W1KLJ	47	127	—	6
W1LCC	7	—	6	2
W1LFS	28	53	—	3
W1LIL	23	37	19	4
W1LFF	19	29	—	3
W2BZB	5	40	95	3
W2COT	15	2	18	4
W2ENY	2	25	—	3
W2IND	—	—	—	2
W2IAL	15	15	18	2
W2LEN	3	6	—	2
W2MO	95	3	241	8
W3AWM	12	—	18	3
W3AWS	—	—	12	2
W3BYF	9	—	19	2
W3BZJ	54	6	123	8
W3CGV	10	—	20	3
W3CYW	2	—	2	1
W3DI	22	—	31	4
W3EIS	7	—	8	2
W3EJ	2	—	2	1
W3FSM	—	—	—	1
W3FX	6	11	28	2
W3GMZ	10	—	13	2
W3FOH	79	—	158	6
W3HS	16	—	42	5
W3RL	10	—	17	3
W5AJG	1	—	10	1
W6KYT	15	—	32	1
W6NCP	2	—	4	1
W6OVK	1	—	1	1
W6OWX	1	—	1	1
W6RVL	26	—	71	1
W8AGU	16	6	29	1
W8BJG	8	—	8	1
W8QDU	—	—	—	5
W8QQS	4	—	10	1
W8RUE	12	1	29	2
W8MFM	—	—	—	7
W9USI	1	—	2	1
W9ARN	3	—	7	1
W9BJV	1	—	2	1
W9VHG	16	—	27	3
W9VWU	2	—	4	1
W9ZJB	3	—	4	2

¹ Reports received up to March 7th only.

² Not eligible for award.

³ Claimed score and distances not included in report.

that means an S9 sig on Five for thirty miles or more. In the meantime, we shall be on 112,008 kc. each Thursday night with amplitude modulation. Tests at W1HDF indicate that, by tripling to 2 1/2 and thus avoiding the use of any circuits tuned to 56 Mc., the signal on Five, which so many of the gang who are using crystal control have noticed, is completely eliminated.

If you are situated behind a hill and have not tried 112 Mc. because you figured you'd not be able to work out, take heart from the story of W3EBC of Somerville, N. J. He reports that in order to work W2HGU in Ridgewood, N. J. (about 40 miles to the northeast), he points his beam at Plainfield, which is practically due east. It looks as though the signals were being bounced off a range of hills which rises between Somerville and Plainfield. W9WYX reported some time ago that similar observations had been made in the mountainous country near Denver.

W3EBC says that contacts are being made between several members of the Tri-County Radio Association who were never able to hook up on Five. He lays this to the use of more efficient antennas, as most of the contacts can be

(Continued on next left-hand page)

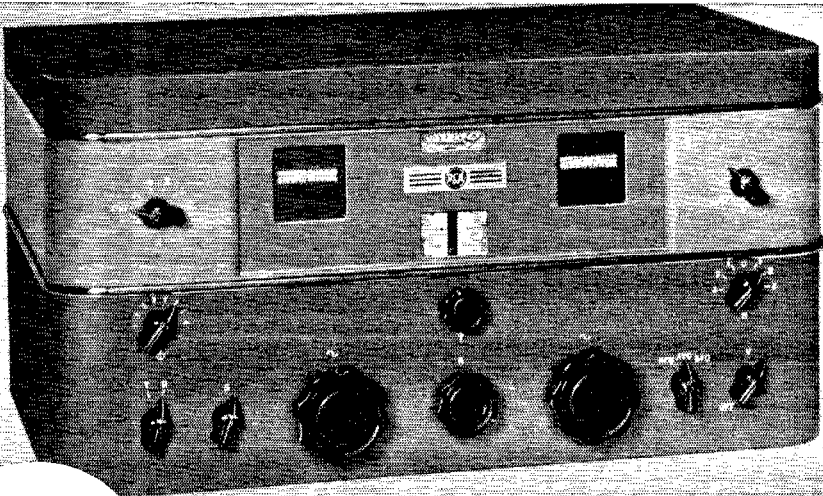

\$139⁵⁰

F. O. B. FACTORY
SPEAKER
\$800
EXTRA

AR-77 A NEW GENERAL PURPOSE
COMMUNICATION RECEIVER
BY RCA

...designed expressly for amateur use

Only RCA
offers
all these
features
...with
exceptional
performance

Dual R-F Alignment...air-dielectric trimmers *plus* inductance adjustment assures stable alignment and complete "tracking" of r-f circuits for uniform sensitivity.

Poly-Styrene Insulation... used for high efficiency 10 and 20 meter coil forms. High grade Ceramic insulation on range switch, r-f tube sockets, tuning and trimmer condensers.

Lower Circuit Noise... through circuit design that gives greater *usable* sensitivity for weak signals.

Negative Feedback... employed in the audio amplifier gives improved fidelity enabling operator to pass accurate judgment on quality of 'phone signals and to enjoy better entertainment reception.

Stay-Put Tuning... through use of temperature compensation and voltage regulation for r-f oscillator.

Uni-View Dial... slide shutter blanks everything except the calibration for the range in use. No confusion in reading dials.

Calibrated Band Spread... for 10, 20, 40 and 80 meter amateur bands.

Accurate Signal Reset... you can reset "logged" stations and check frequency closely with vernier index scale on both dials.

Variable Selectivity... in six steps through use of crystal filter. A real advantage for C-W telegraph and 'phone reception.

Improved Image Rejection... by use of high Q circuits and optimum L-C ratio.

Improved Noise Limiter... adjustable to meet local interference conditions.

Diversity Reception... by terminals provided for connecting two AR-77's together.

PLUS STANDARD SPECIFICATIONS

Antenna Trimmer, Pre-Selector Stage, 540-31,000 KC, 10 Tubes, Carrier Level Meter, Sensitivity Control, C-W Oscillator, Magnetite Core I-F Transformers, Audio Output 3 Watts, Headphone Jack, Standby Switch with Terminals for Relay, Modern Styling, Power Supply 105-125 V., 50-60 cycle—Special Power Supplies and Panel to Rack-Mount available on quotation.



for Amateur Radio

RCA MANUFACTURING COMPANY, INC., CAMDEN, N. J. • A Service of the Radio Corporation of America

DEPENDABLE



Grade A materials; experienced workmanship; conservative ratings . . . that spells dependable Xmitting condensers in AEROVOX terms.

Type -09 Hyvols are the No. 1 choice of many "hams." Also with builders of commercial equipment.

Oil impregnated and oil filled. Sturdy metal can. Pillar terminals. Adjustable mounting bracket, upright or inverted.

600 to 5000 v. D.C.W. 1 to 4 mfd. Popular prices.

Ask for
CATALOG . . .

Latest edition, yours for the asking — from jobber or from us.

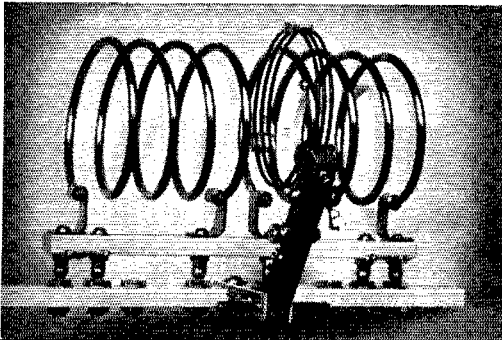

SETTING NEW HIGHS IN 500-WATT PERFORMANCE!

THE new B&W Type TVH 500-watt Variable Link Coils are designed for optimum L/C ratios from 10 to 160 meters with condensers of the Cardwell XE-160-70-XQ or FEX types; or by combining 50-50 split stator condensers in conjunction with 25 and 50 mmfd. fixed air or vacuum condensers for all-band operation.

The 10-meter TVH and the TVH Base Assembly are illustrated above. 20, 40, 80 and 160-meter TVH's are also available. All feature a novel plug and jack arrangement which makes proper capacity selection automatic. They're the "hottest" arrangements for those 500-watt rigs you've ever seen — and the price is only **\$3.75** for the Base Unit; the Coils, **\$2.85** each. Send for details — or see them at your jobber's.

BARKER & WILLIAMSON

Radio Manufacturing Engineers • ARDMORE, PENNSYLVANIA

made only when high-gain beams are used. Bill reports that several of the gang are using the loktal-based 7A4 as a 112-Mc. detector. They remove the metal ring from the tube, thereby reducing the capacity to ground. Most of the receivers are separately quenched. In this connection, it has been our experience that the value of a separate quench oscillator goes up with frequency. The separate quench tube seems to offer little improvement on Five. On 2½ it seems to be an aid to smooth operation; while on 1¼ it is practically a necessity, if any control over super-regeneration is to be maintained.

W3EIS at Alexandria, Va., uses an HK-24 to double to 2½ with his regular exciter. With W3RL at Herndon and W3GLV. at Leesburg operating on 2½ occasionally, and with the growth of interest in 112 Mc. in the area around Philadelphia, we may have some long-distance relays on 2½ and perhaps some DX, too. Remember, there's a 500-watt rig at W4EDD waiting to see service on 2½, too.

Out on the West Coast several of the boys got in some nice work during the Relay on 2½, with W6RVL apparently leading the pack with 19 stations worked and a flock of messages handled for a total of 85 points. Nice work, Bup! The rig at W6RVL (ex-6UP) is a 75T oscillator, cathode-modulated. Receivers are a National 1-10 and an r.c. superhet with 954 r.f.

Several operators report that 2½ works out much better for portable and mobile use than 56-Mc. equipment used under similar conditions. W6NCP has a 76-42 transceiver permanently installed in his car and has had many fine contacts; without, in most cases, searching for special locations, but merely using the rig frequently in the course of business trips. The rig was made with plug-in coils and was changed to 2½ when the regulations required that its use on Five be discontinued. We think that the difference in favor of 2½ for this sort of work lies in the use of more efficient antennas for the higher frequency.

Around Buffalo, N. Y., W8's RV, NOR, QZN, SUI, SBI, UDD, TZC, SXZ, PMC/S, RTC, and NWH, are heard frequently on 2½. Activity is being sponsored by the Greater Buffalo Five-Meter Club and the Kenmore-Buffalo-Tonawanda Radio Club, according to information furnished by the Western New York S.C.M.

In Denver, Bob Swanlund, W9WYX, works W9VTK, W9VGC, and others almost nightly. Bob has also been on 58,000 with 100 watts to a pair of 809's, but no DX contacts have been made. Stick with it, Bob — plenty of the brothers will be looking for Colorado when skip breaks! WYX plans to have those HK-24's up on Grand Mesa, 10,281-foot elevation, during the Rocky Mountain Division Convention for another try for a new 112-Mc. DX record.

224 MC.:

W1AH and W1AIY earned themselves a nice bunch of points in the Relay by working each other on 1¼. W1AIY passed along several messages to your conductor by this means, also. The weekly 5-1¼ cross-band QSO's between W1AIY and W1HDQ have served to awaken interest in 224-Mc. work in several places. W1GUY, Ludlow, Mass., has an acorn receiver working and will be transmitting on 1¼ by the time this appears in print, as will W1HDF.

WISS, Arlington, Mass., is listening for W1BBM on Cape Cod on regular skeds, without success to date; though contacts have been made over this path on 2½ in the past. It is thought that, with the coming of improved conditions in the next few months, this hop will be made on 1¼ also. It will be interesting to see just how much 2½ and 1¼ improve when the range of operation begins to stretch out on Five with the coming of warmer weather.

Twister Strikes Georgia

(Continued from page 16)

area, he was able to relay to W4GHU, W4ATO, and the outside stations "on-the-scene" messages and information.

Three members of the Tallahassee (Fla.) Amateur Radio Club (W4FVJ, W4EIC and W4CJE) took portable equipment to Albany on the 10th and arranged to assist in providing communication from the stricken city. Clarence H. Ratliff, W4CJE, operated W4FVJ's portable

(Continued on next left-hand page)

HOWARD Progressive Series Plan

Provides This Entire IDEAL RECEIVING LAYOUT

for Only **\$138³⁵**

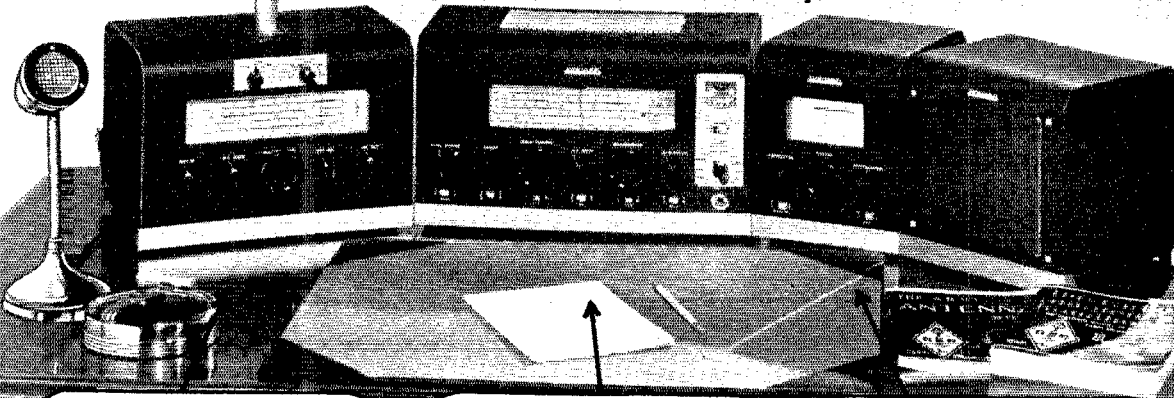

650 PRESELECTOR

The performance of this high gain two stage R.F. pre-amplifier, using 1853 tubes, is truly remarkable in increasing DX and in reducing signal interference. Self powered, with exclusive loop arrangement reading directly in degrees of the compass, this important unit of the HOWARD Progressive Series can be effectively used with any type or make of receiver. The master selecting system provides operation with loop or external antenna or cuts out pre-selector for regular operation of receiver. Price complete, but without loop.

\$29⁹⁵

(Loop Antennas—\$7.50)

437 RECEIVER

Extremely sensitive and selective—is an outstanding performer on all bands. It features: 9 tubes, R.F. stage on all 4 bands, two iron core I.F. stages, Noise Limiter, Crystal Filter, BFO, Electrical Band Spread, exclusive HOWARD Inertia Knobs, and all other desirable refinements. Exact Carrier Level Meter shown, an entirely new device for measuring input signal strength in microvolts, can be installed on any HOWARD Progressive model for \$12.00.

\$54⁵⁰

(With Crystal—\$62.00)

660 FREQUENCY MONITOR

Enables you to read directly in frequency, any unknown signal in the amateur bands. Ceramic insulated precision built variable condenser carries an extremely accurate frequency scale. Frequency can be read within one kilocycle on the lower frequency bands and within five kilocycles on the 10 meter band. Highly stabilized, has built in power supply and will operate with any receiver. Complete price

\$18⁹⁵

Pacific Coast and Export Prices Slightly Higher

You Can Start It With A **\$29⁹⁵** PROTECTED INVESTMENT!

The new HOWARD PROGRESSIVE SERIES PLAN enables you to build up the Ideal Receiving Layout as finances permit—it means more and better equipment as you go along WITHOUT KEEPING YOUR MONEY "TIED UP" in "first models". Factory conversions from any model, including the basic \$29.95 model 435, end "TRADE-IN" losses and assure you of always owning the best receiving layout your money can buy. This most flexible and advantageous purchase plan marks a new milestone in communication history. See the complete layout at your distributor or write the factory.

Start with the HOWARD Progressive Series Plan NOW!

Laboratory Manual
Now Ready!

The Progressive Series Plan incorporates so many interesting and desirable features that we've decided to put the complete story in manual form. Contains circuits, detailed engineering specifications, photographs, operation data, etc. We hadn't planned to give this manual away but if you want a copy and will write us a letter we'll send it along without charge.

HOWARD RADIO COMPANY

1731-35 Belmont Ave., Chicago, Ill. Cable Address: HOWARDCO., U.S.A.

America's Oldest Radio Manufacturer

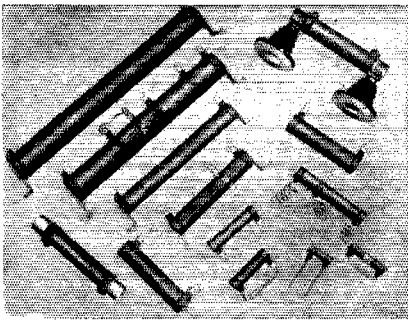

Sure tough!

★ That's what users say about GREENOHMS — those green-colored cement-coated power resistors made by Clarostat. And that's why you'll find them in better grade transmitting rigs, power amplifiers, oscillographs, lab instruments, etc. 10 to 200 watts. All popular resistance values. Fixed and adjustable. Simply brutes for punishment. ★ Ask local supplier for Greenohms. Ask for other Clarostat products — controls, ballasts, etc. Ask for our data. ★ Or write direct to Clarostat Mfg. Co., Inc., 285-7 N. 6th St., Brooklyn, N. Y.



AT LAST! BAND SWITCHING WITH THE PUSH OF A BUTTON

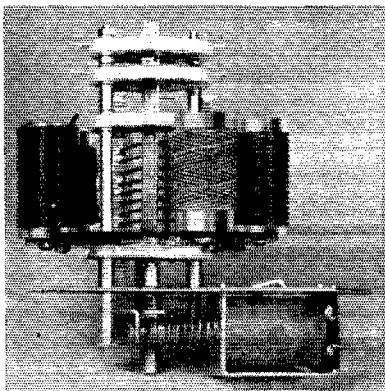

SOLENOID OPERATED 5-BAND OSCILLATOR UNIT
Polystyrene and ceramic insulation.
Larger units for all stages.
Band indicator and interlock sections provide assurance of correct switching sequence in all stages.

Write for Bulletin 800. Full data on push-button xtal selector, switches for a 1000 uses and manually operated band switches.

RADIO
PROVIDENCE



PRODUCTS
RHODE ISLAND

transmitter from a point within the city, relaying messages to Clayton W. Maples, W4EIC, who set up outside of town, using an emergency power supply and 50-watt rig supplied by W4SC.

Stations who participated in clearing W4GHU, W4ATO, and W4ARX included W4FDJ, W4RM, W4DU, W4PG, W4FPU, W4FJM, W4GAA, W4DIJ, W4BB, W4FWD, W4GEO, W4COS, W4CYC, W4EMC, W4FYB, W4CJE, W4EIC/SC, W4FVJ, W4FRQ, W4CUS/PG, W4ARS, W4GHW, W4FCN, W4EJK, W4FVM, W4FXN, W4EFD, W4FCW, W4EVT, W4BUW, W4DPX, W4CDU and W4FNA. These stations, along with others whose calls are not available at this writing, either handled traffic directly with the Albany emergency stations or aided in clearing the channels and standing by for service if needed. Stations as far away as Rhode Island, Michigan and Illinois were heard lending a helping hand in clearing the channels for the emergency stations.

Special commendation for their work in assisting in the emergency goes to Ernest L. Morgan, W4FDJ, who probably relayed more traffic than any other station, and Dr. Charles R. McArthur, W4FCW, who served in the dual capacity of relay station while at his home in Cordele and as first-aid surgeon to the hundreds of injured persons during the time he spent in Albany.

In rendering such an immeasurable service to the city officials, the Red Cross, and the friends and relatives of the Albany citizenry, it is interesting to note that several of the most active assistants in the work were newcomers to amateur radio. The would-be amateurs did their part, too, serving as messengers in delivering and collecting traffic. W4GHU operating in the 1.7-Mc. band once again proved the worthiness of this always-dependable amateur allocation. By actual count, over one thousand messages were handled by this station on that band!

Once again it has been emphasized that too much time cannot be spent in emergency preparation. Whether you are a member of the A.R.R.L. or not, register your facilities in the League's Emergency Corps and be prepared to serve your community when disaster strikes.

The Vermont Section held its Second Vermont QSO Party, February 10th-12th. Stations were required to exchange information as to tube line-up of final r.f. stages in their respective transmitters; 100 points were allowed for each completed contact with exchange of required information and contacts on all authorized bands permitted. The final score was multiplied by the number of different townships and cities within the Vermont Section worked. From the outset the party was a grand success. Old-timers who had not been heard for months and years were on hand, together with the newer lads. The Section, in a spirit of competition, was divided into East and West sides. The East Side amassed the overwhelming score of 272,900 points. The West Side showed general participation, but came a short second with 93,400. In the East W1CBW and W1BNS ran neck and neck, the final count showing BNS 65,100, CBW 62,000. On the West Side W1MJU, one of our newest amateurs, bagged by far the highest score, 36,800, using his FB e.c.o. unit. W1KJG made 20,800. W1MCQ was high in both sides for 'phone operation with 6000 points. Our YL operator, W1LZJ, came in high for YL's with 4200 points. Scores by individual stations were KXL 9900; JRU 8100; BJP 23,800; AD 3000; KVB 8800; LRL 3000; KJG 20,800; KWB 18,000; CBW 62,000; KOQ 20,400; KTB 49,400; FPS 8800; LJZ 4200; BNS 65,100; MCQ 6000; MJU 36,800; MMV 1000; CGV 12,000.

— W1KJG, S.C.M. Vt.

QST YEARLY BINDERS

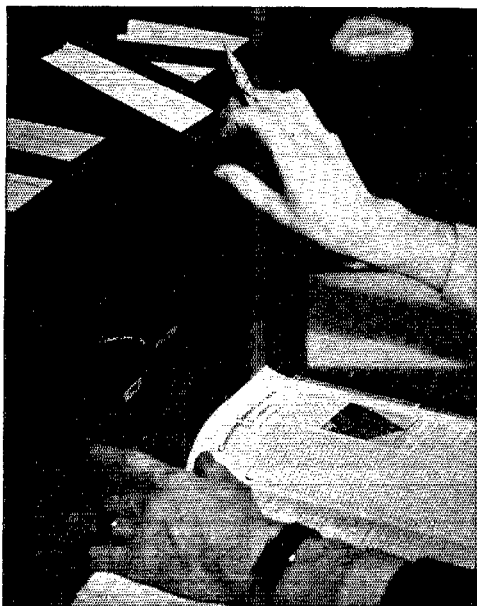

Are We Right?

You should have at least two of them—one for your complete 1939 file of copies, and one for each 1940 issue as published.

With each Binder is furnished a sheet of gold and black gummed labels for years 1922 through 1941. The proper one can be cut from the sheet and pasted in the space provided for it on the back of the binder.

Price **\$1.50** postpaid

Available only in United States and Possessions

THE AMERICAN RADIO RELAY LEAGUE
West Hartford, Conn.

Everything for the "Ham"

No idle chatter in these words, as hundreds of our customers and friends will testify. Leo — W9GFQ — always on the job to give you fellows the best deals and satisfaction guaranteed.

• • • • •

Trade In — your receiver or XMTR today for the maximum allowance. Use your present equipment as a down payment and get our easy payments on the balance. **Free Trial** of receivers extended for your convenience.

DON'T FORGET —

WE OFFER YOU THE LOWEST 6% PLAN AVAILABLE

On any nationally known part, receiver or XMTR shown in any catalog or advertisement at the lowest price shown, **FOR QUICK SERVICE — WITH NO RED TAPE — WRITE (LEO) W9GFQ.**

TAKE YOUR CHOICE FOR QUICK SERVICE

Send down payment with at least two references and we will do the rest **pronto**. Write for credit blank.

PAYMENTS ALSO ARRANGED TO SUIT YOU!

Model No.	Cash Price	Down Payment	12 Monthly Payments
Sky Buddy.....	\$99.50	\$5.90	\$2.08
Sky Champion.....	\$49.50	\$9.90	\$3.49
Defiant — 24.....	\$69.50	\$13.90	\$4.91
Super Defiant.....	\$99.50	\$19.90	\$7.03
Howard 435.....	\$29.95	\$5.99	\$2.11
Howard 436.....	\$39.95	\$7.99	\$2.82
Howard 437.....	\$54.50	\$10.90	\$3.85
Howard Preselector	\$99.95	\$5.99	\$2.11
Bretling 6.....	\$32.40	\$6.48	\$2.29
Bretling 9.....	\$54.00	\$10.80	\$3.81
Bretling 40.....	\$99.00	\$19.80	\$6.99
HQ120-X.....	\$138.00	\$37.60	\$8.86

All National, RME sets stocked at similar prices. Latest Stancor Kits on hand. Wired at low cost.

BUY YOUR PARTS ON TIME FOR LESS

Amt. of Parts	Cash with Order	Pay Monthly
\$15.00	\$3.00	\$4.24 for 3 Mos.
\$25.00	5.00	4.24 for 5 Mos.
\$35.00	7.00	4.24 for 7 Mos.

12 months to pay on any order of \$25.00 or more if you wish

WRITE FOR DETAILS ON ANY AMOUNT

FREE — OUR NEW BARGAIN 112-PAGE CATALOG

Chuck-full of real ham values. The fellows are all talking about this genuine ham catalog so get your copy today sure.

WHOLESALE RADIO LABORATORIES

Everything for the "Ham"

COUNCIL BLUFFS, IOWA

OHMITE

Close-Control

RHEOSTATS

This is the Model "J" 50 watt Rheostat specified for variable cathode bias circuits. And it's also one of many Ohmite Rheostats used by amateurs everywhere for close, accurate tube filament control. Ohmite all-ceramic vitreous-enameled construction, metal graphite contact and other features insure permanently smooth, trouble-free close-control. Sizes from 25 to 1000 watts in many resistances.

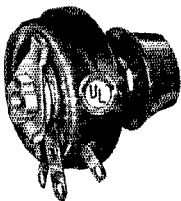

Ask Your Jobber or Write Today for Free Catalog 17

OHMITE MANUFACTURING CO.
4865 Flounoy Street, Chicago, Ill., U.S.A.

Be Right with OHMITE
RHEOSTATS • RESISTORS • TAP SWITCHES

DOES FAST CODE GET YOU DOWN?

Write for CANDLER'S
FREE Book of Facts!

THERE'S no need to let fast code lick you! If you are having trouble learning code, if you can't develop the speed you need, if you can't get your license — call on Candler! He has trained thousands of operators with the unique Candler System, fellows who were stuck, who couldn't get over the "hump."



In a few weeks with Candler, learning sound-consciousness, getting the proper mental training, you will be able to read code as easily as you read print, without strain or effort. Ask any skilled operator!

Learn about the Candler System! Send for Candler's FREE "Book of Facts" today!

CANDLER SYSTEM CO.

DEPT. Q-4

ASHEVILLE, NO. CAROLINA

160 to 2 1/2 in One Transmitter!

(Continued from page 26)

as "high power" on 112 Mc., and the efficiency attained is considerably better than might be expected from the same tubes used as a push-pull oscillator.

The plate coils and plug-in mounting for the regular six bands are special versions of the Barker and Williamson "Swinging Link" design, being similar to their standard "TVL" types except for the extra plugs and jumper in the low-frequency units. The special base and coils incorporating these features are designated as Type "TVX."

Driver Stage

The TZ-40 stage shown at the left of the unit is conventional in every way. In our set-up the exciter delivers sufficient output to drive the final direct on the low-frequency bands; so this stage is used only when operating on 23, 56 or 112 Mc. A link switch similar to that used in the exciter is used to permit running the exciter output to either the doubler or final grid coils. The final grid circuit is tuned with a fairly large split-stator condenser (100 μ fd. per section) and adjacent bands can be covered with one coil. Thus 112 and 56 Mc. or 56 and 28 Mc. can be covered by merely changing the TZ-40 plate coil and the final plate coil, as plenty of drive for the final is available from the TZ-40 whether doubling or running "straight-through." In our set-up the plate voltage on the TZ-40 is maintained at approximately 700 volts. At this figure there is little chance of exceeding the tube's plate dissipation rating, even when doubling to 112 Mc.

"99"

JEEPERS! I'm supposed to be an Old Timer, and just now have I discovered how to get rid of QRM! Here's the dope: I took my 100-watt transmitter which was on 3.5 Mc., wound some coils with 65 turns of No. 24 wire, and plugged 'em in. Hot dog, when I tuned it up she had output on the 1.75-Mc. c.w. band! When I say output I mean output! A 3000-volt condenser in the antenna tank spit fire in the best approved manner. So I hooked a quarter-wave wire, 132 feet long, on one side of the antenna coil. Plate current remained the same and no sign of any soup in the antenna. Signal didn't seem any louder in receiver, and antenna condenser still arched over. So I cut down the excitation, so she didn't arc so much. Stuck neon bulb on antenna and nothing happened. Stuck cat's nose on antenna and nothing happened. Finally held a fishpole with neon bulb tied on the end of it up on the middle of the antenna, and the neighbors started looking up the 'phone number of the local bughouse. Well, not knowing anything else to do, I went on the air and "tested" for couple minutes and signed my call. I'll be horns-wiggled if half the band didn't come back to me. Yes sir, four stations! Reports ranged from RST 589X 35 miles away to 459X 400 miles away. No QRM! They were all ready for traffic or a chew, and three of them had just made the same famous discovery, and their antennas wouldn't tune up either. HI. The fourth one was 250 miles away and had 3 watts input.

Now this report is titled "99," and that's just what I mean — "Keep Out," fellows! The band is FB and I don't need any more QRM. This is a plea for you misguided guys on other bands to stay where you are with the rest of the QRM and let us guys "in the know" have some real fun on "one-sixty c.w."

— W1BNS, O.R.S., R.M., VI.

★ ★ ★ ★ ★
Only 10% DOWN on purchase of \$50 or more.

Only 20% DOWN on purchases of \$25 to \$50. Add 6% carrying charge to balance and divide into monthly payments as desired up to 12 months and providing no monthly payment is less than \$5.00.

IMMEDIATE SHIPMENT as soon as credit is approved. Entire transaction complete in one week. **FIGURE YOUR OWN DOWN PAYMENT AND EASY TERMS** from prices listed below. Include all the sets and parts you need and **ORDER TODAY DIRECT FROM THIS AD**, enclosing only the small down payment.

OWN THE NEWEST AND BEST RECEIVER—PAY FOR IT ON NEWARK'S EASY TERMS

	Cash Price
NATIONAL	
NC101X	\$129.00
NC101XA	129.00
NC100XA	142.50
NC44	49.50
NC80-81X	99.00
HRO De Luxe	179.70
RME 70	138.60
69	152.88
70 DB Combination	181.80
HAMMARLUND	
HQ120X	138.00
RCA — AR-77	147.50
HALLICRAFTERS	
New Super Defiant	99.50
Sky Rider Defiant SX 24	81.50
SX 23	127.50
Sky Buddy S-19-R	29.50
Sky Champ S-20-R	49.50
Sky Rider, 510	69.50
Sky Rider Marine	64.50

NEW RCA
AR-77 \$147.50
 Complete with Speaker
Only \$14.75 DOWN

ALL SETS COMPLETE. ready to use. Shipped in brand new original unopened factory cartons, 4-hour service. Order direct from this ad. Include sets and parts in same order on Newark's Time Payment Plan.

Oil Filled, Oil Impregnated FILTER CONDENSERS

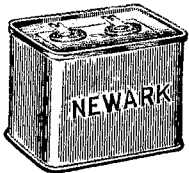

These are well-known makes and only a few left of each.

Now only \$1.00
 1000 v. DC, 3 mfd. $2\frac{3}{4}$ x $1\frac{1}{2}$ x 1. Weight $\frac{1}{2}$ lb.

DC Volt	Mfd.	Size	Wt.	Price
2000	2	$4\frac{1}{2}$ x $3\frac{1}{2}$ x $1\frac{1}{2}$	$1\frac{1}{2}$ lbs.	\$1.50
1250	3	$3\frac{1}{2}$ x $3\frac{1}{2}$ x $1\frac{1}{2}$	$1\frac{1}{2}$ lbs.	1.25
1500	3	5 x $3\frac{1}{2}$ x $1\frac{1}{2}$	$1\frac{1}{2}$ lbs.	1.50
1500	4.4	5 x $3\frac{1}{2}$ x $1\frac{1}{2}$	$1\frac{1}{2}$ lbs.	1.75
1500	5	$3\frac{1}{2}$ x $3\frac{1}{2}$ x $1\frac{1}{2}$	$1\frac{1}{2}$ lbs.	1.90
2000	8	5 x $3\frac{1}{2}$ x $3\frac{1}{2}$	$2\frac{1}{2}$ lbs.	2.75

Guaranteed at rated voltages

FREE — YOUR CALL LETTERS IN GOLD

Big shadowed decalcomania letters nearly TWO INCHES high. Put them on your ham shack door, auto window, etc. Send stamped, self-addressed envelope. Be sure to give your call letters.

FREE!

NEWARK'S BIG NEW
84 page Catalog

Thousands of items for the Ham. Sets, parts, accessories and supplies fully illustrated and described, with lowest prices.

Tune Up Your Rig with OHMITE Parts from NEWARK

★ Get the newest from Newark — especially these Ohmite parts that do so much for your rig! *Order Today Direct From This Ad.* Prompt 4-hour service! Or, include with other parts and sets you need on Newark's New Liberalized Credit Plan!

100 and 250 Watt Dummy Antennas

Check R.F. Power and tune up to peak efficiency.
Model D-100. 100 watts. Specify 18, 34, 73, 146, 400 or 600 ohms.
 Each.....\$3.23
Model D-250. 250 watts. Specify 73 or 600 ohms.
 Each.....\$6.47

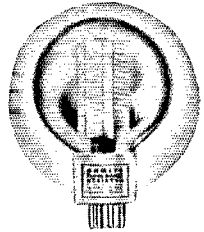

Ohmite Close-Control Model "J" Rheostat

For variable cathode bias, as specified in Glenn Browning's E.C.O. Exciter. $2\frac{3}{16}$ " dia. x $1\frac{3}{8}$ " deep.
 No. 0330. 5000 ohms. \$2.94

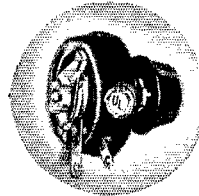

Ohmite Model 212 Tap Switch

10 Amps — 240 Volts A.C. Compact, all enclosed ceramic construction. $2\frac{3}{4}$ " dia. x $1\frac{1}{2}$ " deep.
 No. 212-5 — 5 Contacts.
 Each.....\$3.38

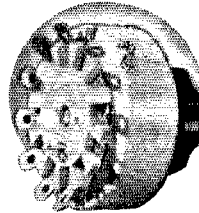

Ohmite 50 Watt Multivolt Resistors

Specified by Frank C. Jones in his Cathode Modulation system. 10 equal sections. 50 watts.

Stock No.	Ohms	Price
1206	10,000	\$1.26
1209	25,000	\$1.47

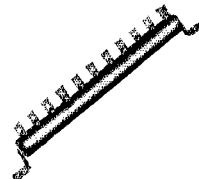

NEWARK Electric Company
 323 W. MADISON ST.
 Dept. Q CHICAGO, ILL.

Station Activities



DAKOTA DIVISION

NORTH DAKOTA—SCM, Anton C. Theodos, W9WVL—Please notice my change of QTH and don't forget to send in your renewal to the A.E.C. O.O.'s—RZA, YVF, O.R.S.; DM-(T.L. "A"), RZA (T.L. "H"), NBX, O.P.S.—YVF, ERR, WVL, O.B.S.: YVF, WVL
Traffic: W9NBX 101 DM 95 RZA 57 ERR 28 VSK 12 WWL 8 NCL 7.

SOUTH DAKOTA—SCM, A. L. Russell, W9VOD—SEB; R.M. USH clicked for 1508 points to lead South Dakota in the QSO Party. ADJ is deserting 14- for 28-Mc. 'phone. YOB visited Minneapolis, dropping in on QAK en route. YKY is building portable with 6A6-6F6-pair 6L6's. HYH is new Rapid City ham, recruited and sponsored by GLA. The R.C. gang wonder how all QSL's submitted by APT in contest were red (they counted double). SWV likes his Stancor 10-P. GCP is handling traffic already and asks how to get O.R.S. DZD is building new super. HKX is on with 6L6 osc. and SW3. DKL took Cardwell condenser in Huron Club contest. WUU really works all bands, reporting successive QSOs in one day on 28,600, 14,300, 7150, 3676, 3717.5 and 1904 kc. ZZX and DNV are doing fine with e.c.o.'s. WZH has new 600-watt final. HFS worked the east coast with 5 watts on 1.75-Mc. 'phone. IQD signs for another stretch as E.C. for Huron. New officers at Watertown: URD, pres.; NWP, secy.-treas. BJV and USI continue that daily 55-mc 56-Mc. schedule. URQ finished rebuilding and is on 3.9-Mc. 'phone. PVP is operating on 1.75 Mc. while rebuilding for 28 Mc. URD is mixing 7-Mc. c.w. and 1.75-Mc. 'phone. QLE is on 7 Mc. NWP built swell all-band rig. VQN gets on late in evening.

Traffic: W9SEB 312 GLA 38 QAK 21 GCP 16 FOQ 15 VOD 12 ILL 9 EYK-KNV 2 ZCC 140.

NORTHERN MINNESOTA—SCM, Edwin Wicklund, W9IGZ—Howdy, Gang. The results of the Dakota Division QSO Party are as follows: The highest score of Division and winner of S.M.A.R.A. silver cup is Jack Burke, W9UVA, Stillwater, Minn. Score per Section: No. Minn.—9UVA 1660, IZG 960, BVM 929, UKW 764, YCR 696, YAP 640, EUR 600, NUI 405, LIH 376, AZJ 324; So. Minn.—9TKX 1300, OWU 728, NCS 628; South Dakota—9UJSH 1508, ZWL 340, SEB 340; North Dakota—9VJH 660, IEZ 608, LIH 592, ZTL 408. The winner in each Section receives 1940 A.R.R.L. *Handbook* from A.R.R.L. HQ's. DNY is doing nice job as control station for MN Net. HEN is active on Trunk Line "A." OPA runs 100 watts on 1.8-Mc. 'phone. ZVW, OPA and HZV conducted practice emergency set-ups. RIL reports the Mike and Key Club progressing nicely. CUE has rack for his rig and is getting out nicely with low power on 1.8-Mc. 'phone. CWB gets out FB with his Stancor IOP. AZJ built a modulator for his rig and is trying 1.8-Mc. 'phone. GKO and KFF visited KQA. UVA, new O.P.S. and O.R.S., has T55 final. UDK is back on 1.8-Mc. 'phone. OGR is trying 1.8-Mc. 'phone with low power. OZ is getting out FB on 14-Mc. 'phone. EKT is pounding brass on 7 Mc. ORE is using his 'phone rig. EUR has had at least one QSO every day since he received his ticket in Oct. HEO has an 822 for final in his 3.9-Mc. 'phone rig. LZT is trying out flea-power 'phone on 1.8 Mc. WVD is trying 3.9-Mc. 'phone. RGN says March 3rd is the big day, his marriage date. Congrats. Remember to send me a report the 16th of the month. It will be greatly appreciated. 73.—Ed.

Traffic: W9DNY 169 HEN 74 RIL 12 OPA 26.

SOUTHERN MINNESOTA—SCM, M. L. Bender, W9YNQ—First off, these have been trying days here. Mrs. Bender has been very ill and required hospitalization at Rochester. So if the correspondence has been answered slowly, please excuse it. BQJ rebuilt last two stages putting in T55 and 250TH. BHV broke into the MSN Net and conducted an emergency drill. Let's have more, Swanny. FUZ is ready to go on 3.9-Mc. 'phone. AIR, former S.C.M. for this Section, renewed his licenses. He has held that call since 1924 and still takes pride in the Section activities. NIJ reports IKR as new Minneapolis ham who has an 812 in the final cathode-modulated. DOB worked K6QUS and K6DFE; no doubt his new SX25 had a lot to do with it. CGK has a pair of RK11's in the final. CJZ gets '19X re-

ports with his homemade e.c.o. Our Director has, of all things, taken up flying, soloed on Feb. 11th. He visited the St. Paul and Tracy Club meetings. NYH got his W.A.S. ZAD has designed about as clever an e.c.o. unit as you would care to see or own. He works his rig either crystal or e.c.o. and changes while you listen. It is mounted on a plug-in base and has all the parts on this unit. The thing is so small you could carry it in your vest pocket. GMD worked a three-way schedule for several days between Big Fork, Minn. (W9FNK), and Grand Rapids, Minn. (W9WND), where FNE's wife was in the hospital. It was an eight-pound boy! Congratulations to you and your wife, Harold, from the old gang. OMC has e.c.o. which works FB for traffic. FAJ stepped up his power with a new 812. UYZ gets around in nice style on 1.75-Mc. 'phone. DCM leaves March 16th for Fort Monmouth, N. J., for three months' training with the Signal Corps. He has several 14-Mc. 'phone friends at Asbury Park, N. J., and hopes to keep in touch with the home folks through them. DEI has rotating mechanism built for his 14-Mc. beam. OMC sent his thirteenth consecutive report; hasn't missed one since he was appointed O.R.S. UVA won the cup in the Division QSO party with a score of 1660 points. TKX won in Southern Minn., with 1300. The gang at Red Wing organized the Red Wing Radio Club. OEY is pres. and BQJ secy.-treas. FWN is building a car rig. ESZ is building 400 watts using a pair of '52's. TUW is giving 28 Mc. a whirl. At QXL's birthday the club gave him an A.R.R.L. *Handbook*. CSU has plans for a nice tower for his antenna in the backyard. FWN erected a "V" beam and anticipates plenty of South American DX. OEY hopes 28 Mc. settles down soon so he can try the new rig. The Red Wing Club is going to hold a c.w. night so the 'phone hams can learn to copy 10 w.p.m. again. IPJ is Jr. radio operator for C.A.A. at Ft. Wayne, Ind. CRO continues to keep that schedule with K6QMC. YNQ has a new bug and has a lot of fun with it. During January the membership grew 130% in the Minnesota State Net. The net has been engaged in handling a considerable amount of traffic and has been setting up schedules with contacts outside the net so as to have traffic sources and outlets. It is hoped that more of the boys in the Emergency Net who use our frequency will see fit to join the MSN so they can receive training in message handling. The net operates daily, starting at 7:00 p.m. on 3795 kc., and amateurs in Minnesota and surrounding states are invited to listen to these sessions. The net manager, W9CRO, is particularly anxious to find new as well as old members who will be reliable and will stay in the net during the summer season.

Traffic: W9BQJ 5 BHV 62 AIR 8 NIJ 3 DOB 1 OMC 131 CVH 4 CGK 54 MZN 18 GMD 2 LCT 110 ITQ 86 DCM 18 CRO 237 YNQ 35 NCS 186 BN 6 TKX 28.

MIDWEST DIVISION

IOWA—SCM, L. B. Vennard, W9PJR—IBH and HQO are new Burlington hams. HIM is new Fort Madison ham. FSH moved to new QTH with swell antenna, poles already up. KYR has new Howard receiver. WMP and CQG mostly rag-chew. DUA is on T.L. "L." ZYS needs Asia for W.A.C. on 28-Mc. 'phone with 25 watts. KAH and KSS have new SX25 receivers. HMI rebuilt rig for cathode modulation. YQY invites Soo City hams to help organize club there. OIK is going well on 28-Mc. 'phone. ZLD and UGT built e.c.o.'s. VJF bought Signal Shifter. SFO is on 'phone with a pair of 812's. GPB has 6L6 on 7 Mc. QED states they had 60 at last meeting. QVA reports only 3 logs for all-Iowa contest! Guess nothing will pep up the gang here. ZQI finally made O.P.S. Congrats, Erma. REH is S.N.C.S. Iowa A.A.R.S. More E.C.'s are needed here in Iowa. Send in your nominations. CUL—Les.

Traffic: W9WNL 12 WMP-CQG 1 ZQW 10 DUA 219 REH 224. (Nov.-Dec.: W9WNL 18.)

KANSAS—SCM, Melvin D. Kirby, W9UEG—AWC has new Sky Buddy. BEZ is now located in Pueblo, Colo. ZVP has new Super Defiant SX25. IGJ is new Wichita call. Wichita amateurs are organizing to cooperate with the Red Cross Emergency Communications Corps. Please keep in mind the W.A.R.C. Mid-West Division Convention to be held in Wichita, Kansas, April 27th-28th. Tickets will be \$2.50 each. VQG is building a new e.c.o. for traffic use. ZHH now is 82c, radio operator of NRCJ, U.S.S. *Icarus*, C. C. The Topeka Amateur Radio Operators Club received its A.R.R.L. Charter. GRA is handling traffic in F.T.S. Net. ZIU is on 1.75-Mc. 'phone. MKU worked California on 1.75 Mc. with 35 watts. WIN made the Navy Day Honor Roll. FB, OM. VQG is our new R.M. See him for schedules,

nets and traffic. BYV is new O.B.S. CHJ is active on 1.75 and 7 Mc. A.E.Y. joined the A.E.C. OZNR's new QTH is Udall. YVW worked a K6 on 1.75-Mc. 'phone. WGW, our E.C. for Kansas, reports some very excellent work, which will be recounted elsewhere in this or an early issue of QST.

Traffic: W9AHH 2 GRA 3 WIN 27 VQG 235 UEG 116. (Dec.-Jan.: W9GRA 5 WIN 66 VQG 219.)

MISSOURI — SCM, Letha Allendorf, W9OUD — R.M. QSO has been off the air, under doctor's orders, and PYF is rather snowed under with extra R.M. work and his regular A.A.R.S. job. NSU beat his former traffic high, and his new Zepp is working swell. QMD made his bug into a left-hander to see if it would really work. DMR, FBI, RNK and BNB are new A.A.R.S. JKI is new O.R.S. and has enlisted AAB, AEJ and TBU in the F.T.S. TBU is trying modulating an 830 on 3.9-Mc. 'phone. QOB has new 600-watt all-band transmitter. NIP has new receiver. C.M.A.R.C. is moving to new quarters. GBJ finally finished his new transmitter. GCL is back in Mo. after various QTH's, and is on 3.5 Mc. in Springfield. KJL is operating from St. Jo. KJK is a never-failing source of good traffic, and gives PB service to St. Louis. ZGS has made new schedules with the Mo. Net. WIS still keeps morning schedules. EFC is still "foney." PUS has a schedule with XE2AC on 14-Mc. 'phone. GHD, a student at Washington U., worked 21 states in a month with 10 watts on a 6L6. YLB has 150 to 200 watts to a TZ40 for 28-, 14-, 7- and 3.5-Mc. 'phone and c.w. ARA is putting up a vertical antenna for 3.9 Mc., and is now on 14-Mc. 'phone. ZXX and DLC are on 14-Mc. 'phone. BRN works 14-, 3.9- and 1.75-Mc. 'phone. KOH is the latest O.P.S. and has a daily schedule with RHC and IIS, using 500 watts and e.c.o. on 1.75-Mc. 'phone. IFR has a new 1.75-Mc. rig. APY is operating on 7 Mc. IDD moved to Centralia, Mo., from Illinois, and is active on 1.75 Mc. EIT is newly located in Kirksville and works 1.75 Mc. The morning and evening Mo. nets are handling lots of traffic. OUD will have 1.75-Mc. c.w. rig going to clear some of the traffic that is now being mailed. Thanks for the swell reports. See you all next month, 73.

Traffic: W9OUD 465 PYF 453 QMD 314 NSU 202 QXO 191 AEJ 98 DMR 90 TBU 57 KJK 55 YLB 28 KOH 24 QUY 22 ZGS 20 WIS-EFC 10 JKI 9 PUS 4 CHD 2.

NEBRASKA — SCM, William J. Bamer, W9DI — ARE qualified as a frequency measuring Official Observer. BBS has new 65-ft. tower with new 14-28 Mc. beam, and an ingenious arrangement of motor drive with direction indicator. BIW has a pair of T-40's in which the Taylor company put new glands. ZFC made B.P.L. on deliveries and extra delivery points. KPA is doing a consistent job on Trunk Line "B." WKP is now control station for Nebraska in the A.A.R.S. Phone Net. DXY is active on different bands with c.w. and 'phone. CDL bought new bug. ZRP is new O.R.S. in Omaha. MHA is putting rig on 1.75 and 3.5 Mc. with RK20 final. HUL at C.C.C. camp, Winside, is operating on 1.8-Mc. 'phone and 7-Mc. c.w. MPY has 6-volt portable on 1.8 Mc.; he and GHM are using 28-Mc. crystals in Pierce oscillators. DHO is having his receiver repaired, in the meantime using a receiver borrowed from JED. APS has new Howard 435 receiver. JUJ resumed activity. BXH has been rebuilding. GBO, unable to make trip to South America due to attack of appendicitis, is back in York. GDB made good score in the 1.75-Mc. W.A.S. party. MLB is rebuilding for higher power and greater efficiency. SDL is back on with new rig using 14 Mc. KQX is organizing hidden transmitter hunt. INR has been contacting some good DX on 14 Mc. RGK has new speech amplifier employing peak compression. Construction of new rig at LWS is nearing completion. IAB, new station at Minatare, is using 1.8-Mc. 'phone. AZT is switching from 'phone to c.w. VRT is using new e.c.o. on 28-Mc. 'phone. UCI has been working portable from the 6th call area. QQS divides operating time between 1.8 and 28 Mc. MTI is using 14 and 28 Mc. with both 'phone and c.w. LOD is new A.A.R.S. member. QOA increased power to 16 watts! YDZ is active mostly in the A.A.R.S. VAS is new Columbus station. HYR is moving to new address in Lincoln. GNN, new Lincoln station, is on 1.8-Mc. 'phone. TQD worked KC4USC on 7 Mc., being one of the first to contact the Byrd expedition. HTU gets on occasionally. The Western Nebraska Radio Amateurs are actively interested in emergency work. They held their February meeting at AZT at Scottsbluff. The speaker of the evening was the president of the KGKY Broadcasting Co. The last meeting of the Northeast Nebraska Radio Club was held at WGL. A junk-box exchange was inaugurated. Eastern Nebraska Radio Club is the name of the new club

at Lincoln. At recent meeting technicolor movies were shown of the W.A.S. network. The club sponsored an exhibit of amateur radio at the Lincoln Hobby Show, Feb. 10th and 11th, at the Y.M.C.A. Building. The old Platte Valley Radio Club at North Platte is being reorganized. The Central Nebraska Radio Club is conducting a QSL contest. They have changed their meetings to the first and third Wednesdays of each month. They would like to include outside speakers on their regular programs.

Traffic: W9BNT 710 (WLU 235) FAM 573 ZFC 156 KPA 145 ZAR 125 UHT 111 DI 41 FWV 25 WKP-ZOO 18 GDB 16 POB 15 YDZ-TQD 12 OGN 11 EHW-QOA 10 ZRP 6 BXH 5 VAS 4 CDL 3 JUJ 2 MLB 1.

CENTRAL DIVISION

ILLINOIS — SCM, Leslie M. Dickson, W9RMN — P.A.M. Comments: Some of the fellers on 1.75 Mc. have sorta given DUX, "Sarge," a rub about the Illinois Section write-up in Feb. QST interpreting the comments re tuning up on various net frequencies during activity hours to be directed at him. Well, fellers, I've done it now and then, but it so happens the shoe fits several others as well and was not especially designed for me, although that interpretation could be given the article if punctuation were ignored. All of us should give more attention to trying to help ourselves and brother amateurs by dropping them a card, or contacting them on the air, informing them of such things as harmonics, etc. Many fellows do not know about the unlawful spurious frequencies and other defects in their signals, and get all of us in bad by continuing to operate with this condition existing. On Feb. 4th, between 6:30 and 8 p.m. CST, while listening on 3.5-Mc. c.w., seven S9 harmonics were heard from 1.75-Mc. 'phone stations. Occasional 14-Mc. harmonics have been heard on 28 Mc., and 3.5-Mc. harmonics on 7 Mc. JGH is now on 28 Mc. ROQ is heard on 1.75 Mc. occasionally, after a long time on higher frequencies. ZHB is doing great things on 56 Mc. KP is sporting a signal generated by new HT-9. FOC has a nice signal on 1.75 Mc.; another good c.w. man that finds 'phone an interesting diversion. WTT reports that he represents half of the ham population at Brownstown. HUK and HTI are chasing harmonics along with HVL and NDE. WDH does mighty well with his ten watts working schedules on 1.75 Mc. into Chicago. HRV is active occasionally on 1.75 Mc. LLX has set-up in Midlothian, raising the ham population there to three, RRX and NTS being the other two. Members of "Hamfesters" find 1.75 Mc. ideal for carrying on discussion of club affairs during the evenings, and several of them keep regular schedules with other members. 9AGF is now located at Love Field, Dallas, Texas, where he is employed by the U. S. Army Air Corps.

Traffic: W9QLL 2217 (WLTW 15) ILH 1145 NFL 1012 (WLTG 136) GMT 538 UN 264 YZE 231 (WLTE 18) PTQ 188 WFS 179 JZY 174 QKJ 160 DUX 144 DOH 124 DDO 101 CHD 95 TUV 66 HPG 53 (WLTJ 18) ETZ 51 RWS-YTV 44 FTU 38 ZMG 17 MRQ-IMB-ZYL-YZN 12 KMN 10 BRY-QLZ 7 QGT 6 PNV 4 ACU 3 SKR-RT 2 YDJ 1 OQZ 16.

KENTUCKY — SCM, Darrell A. Downard, W9ARU — BOZ and JEG are on 3.9-Mc. 'phone. BAZ and BOF are, believe it or not, on 28 Mc. MWR puts a nice signal down here on 3.9-Mc. 'phone. MGT, on 28 Mc., is getting along. Likewise CEZ. The Lexington gang is contemplating activity on 56 Mc. ERV succeeded in forming a radio club at Lexington — the Central Kentucky Amateur Radio Club. Officers: MGT, pres.; MWR, vice-pres.; FWT, secy.-treas.; ERV, activities mgr. They will celebrate their organizing by holding a hamfest. BEW sent us a picture of his 14-Mc. rotary beam. It's a honey. GRQ is another new call down at Ft. Knox. THS is active on "KYN" and Trunk Line "E," and represents that trunk in the National Trunk Line Net. ARU finally finished his half-kw. GIO took exam for 1st class commercial. ARZ is on 3.5 Mc. most of the time. FVF is trying for W.A.S. Paducah's hams are working on a radio club for the city. NEP, while buying tobacco around the state, keeps in touch with home via GIO. Will the 28-Mc. guys drop the S.C.M. some dope around the 19th of the month for this column? We want to know what you are doing. A.R.T.S. meetings are the second Monday each month. Come around and argue with the gang. 8AWX/9 worked Howard Hughes' plane, Feb. 24th, during flight from east to west coast.

Traffic: W9BAZ 128 ARU 38 OHA 37 EDQ 291 CDA 5 ERV 24 BEW 21 JIT 22 THS 732.

(Continued on page 104)

TOPS in MULTI-TESTER VALUES

PRECISION No. 844 — 34 Range
AC-DC VOLT-OHM-DECIBEL-MILLIAMMETER
6000 Volts AC-DC; 10 Megohms; 12 Amperes

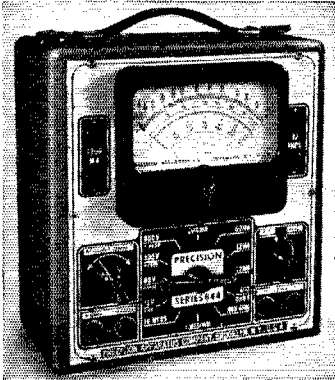

- Six AC Voltage Ranges at 1000 ohms per volt, from 0 to 6,000 volts.
 - Six DC Voltage Ranges at 1000 ohms per volt, from 0 to 6,000 volts.
 - Four Resistance Ranges from 0 to 10 Megs.
 - Six Decibel Ranges from -12 to 70 DB.
 - Six Output Ranges from 0 to 6,000 volts.
- 844-L in walnut finished case (7 x 8 x 4). Less batteries and test leads.
Net. \$22.95
- 844-P closed portable type with tool compartment.
Net. \$24.95

Ask for the PRECISION TEST EQUIPMENT 1940 CATALOG

PRECISION TEST EQUIPMENT

Standard of Accuracy SEE THEM AT YOUR JOBBER

PRECISION APPARATUS COMPANY
647 Kent Avenue Brooklyn, New York
Export Div: 458 Broadway, New York, U. S. A. — Cables: Morhanex

THIS EXPERT WILL HELP YOU PASS THE NEW RADIO EXAMS



Newly-written, low-cost, home-study courses under supervision of Arthur R. Nilson, twenty years co-author of technical radio books. Fit yourself for the new license examinations — Radio Telephone Operator 1st or 2nd class and Radio Telegraph Operator's permit, used in the Aeronautical, Forestry and Police services and Broadcasting. Thousands of professional radiomen use Nilson and Horning textbooks to keep up to date. Now Arthur R. Nilson will give you direct, detailed lessons, step by step.

SEND FOR FREE 16-PAGE BOOKLET "What The Modern Radioman Must Know." Make this step toward your successful radio career . . . now!

NILSON RADIO SCHOOL
51 East 42nd St., New York, N. Y.

Please send me without obligation, your booklet "What The Modern Radioman Must Know."

Name _____
Address _____
City _____ State _____ Q-4



Correspondence Department

(Continued from page 68)

Damariscotta, Maine

Editor, QST:

LUSTY BRAVO YOUR EDITORIAL MARCH QST
STOP ALTOGETHER TOO MUCH OF THIS WIDE-
SPREAD SELFISHNESS

— H. W. Castner, W1IE

"NO-CODE" AND "F.M."

742 Central St., Plainfield, N. J.

Editor, QST:

I have read with much interest your editorial in the February issue, about f.m. on the u.h.f. . . . Our primary problem is one of occupancy. . . . We have cultivated, through the years, a particular type of individual who is chiefly interested in c.w. on the lower frequencies. Anyone with zero interest in code operation but a *bona fide* interest in u.h.f. 'phone has been forced to learn the code or drop out. Almost every hobby does everything it can to make it easy for the beginner, but amateur radio makes it most difficult at the start. I am not necessarily in favor of abolishing the code test. But can't we, in the interest of adding as many u.h.f. experimenters as possible, give them a year's license after only a technical exam, and then have them later pass a low-speed code test? Amateur radio needs thousands of amateurs on the u.h.f. bands and I am convinced we are never going to get them by the "conversion method" in any quantity. . . .

As one of the first advocates and users of a stabilized rig on 56 Mc., yet as one of the most violent objectors to the new reg on stabilized operation, I can now with very little satisfaction say, "I told you so." The new regs reduced the population of this band to approximately 10% its former strength in the New York area. To make it worse, we would now like to try F.M. and can't do so on this most logical band of all. Let's have these regs modified so that we can have a really worthwhile population on 56. To the purists who cry QRM: Pish-tush, sez I. Amateurs like QRM, as can easily be proved by the occupancy of the other bands. . . .

With this thought in mind and with a desire to see amateur radio really do something worth while in the F.M. field, why not F.M. on the frequencies 29 Mc. to 30 Mc.? The occupancy there is relatively insignificant now and the QRM that would be created would be just the thing to test these possibilities mentioned in your editorial. The advantages of noise suppression and elimination of selective fading would be appreciated by every 10-meter fan. What is most important, we have a large 10-meter population all ready, a portion of which would undoubtedly like to try F.M. under these circumstances. And, what is also important, a little-used bit of territory would become the scene of some highly important and interesting work. . . .

— Dana A. Griffin, W2AOE

CAN IT BE TRUE?

1074 West Fifth St., Santa Ana, Calif.

Editor, QST:

Don't be fooled, fellows. There is a c.w. band at 28.0-28.5 Mc.!

— S. T. McNeal, W6LDJ

CARRIER CURRENT CAUTIONS

P. O. Box 167, La Canada, Calif.

Editor, QST:

Recent articles in several publications have pointed out the advantages of using carrier current or "wired wireless" equipment in connection with local power lines for control of amateur radio station equipment and for other private remote control purposes. The last issue of QST contained a description of a carrier current transmitter and receiver combination for such use.

It should be pointed out that power companies are using a large number of carrier current installations and their

(Continued on page 110)

SEVENTEEN EDITIONS OF EXPERIENCE ARE IN THE 1940 HANDBOOK

***GREATER THAN
ANY OF ITS
PREDECESSORS
THE 1940 HANDBOOK
TELLS EVERYTHING
ANY ONE NEEDS TO
KNOW TO BE A SKILL-
FUL RADIO AMATEUR***

PRICE
\$1 postpaid in
CONTINENTAL U.S.A.
\$1.25 postpaid elsewhere
Buckram bound edition \$2.50

**AMERICAN RADIO RELAY LEAGUE
WEST HARTFORD, CONN., U.S.A.**

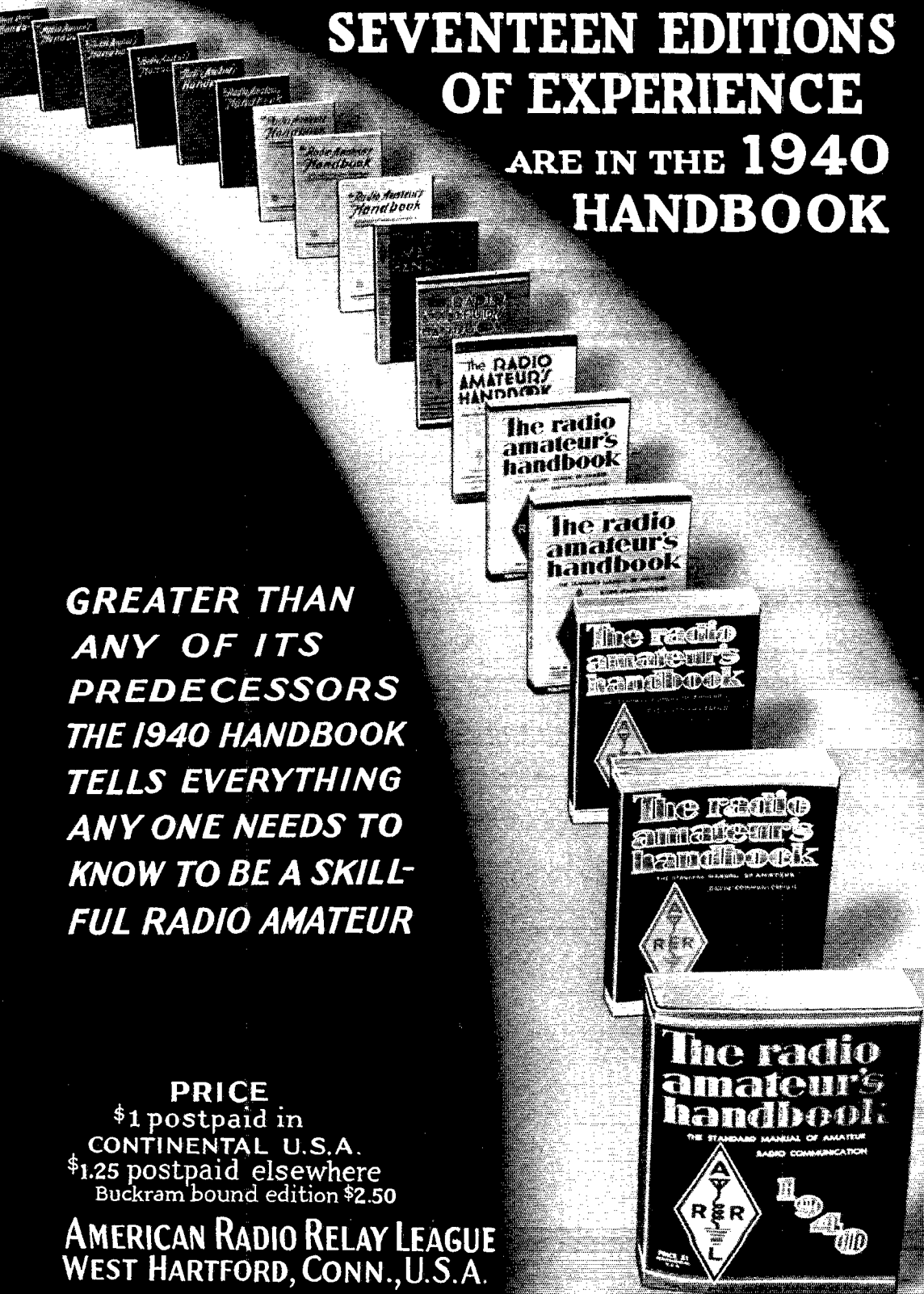

(Continued from page 101)

MICHIGAN — SCM, Harold C. Bird, W8DPE — Michigan Eight; The boys in the U.P. consisting of 9DOJ, LFM, GQF, WZP, CUC and others are organizing to affiliate themselves with QMN Net. Luck, fellows. QMN Net frequency: 3663 kc. IHR is trying his hand on T.L. "A." NUV reported lots of fun in A.R.R.L. Party and SS. LHH is still working 14 Mc. WO is doing missionary work on 112 Mc., reports OJG doing same. KPL is trying for W.A.S. RLF reports lots of activity on 1.75 Mc. with low power. PVK is rebuilding, QGD is working 28-Mc. 'phone. PSY has moved again. JAH is working 1.75 Mc. SAY made the B.P.L., and says he's going to show the boys up if they don't get going. TBP says activity on QMN is picking up. SKO operated from 8EDR in last O.P.S. party. OHI is coming on c.w. on 3.5 Mc. SCW hooked Mexico for W.A.S. on 7 Mc. DSQ is back on 7 Mc. SWF is being heard in New Zealand these days, on 28 Mc. TJQ is doing nice job on QMN. QZV says gang is still active around Bay City. RJC is working F.T.S. during day, and QMN nights. RMH is sure handling the traffic, and doing nice job on QMN. QQK is still plugging for that trophy. Nice going, OM. DYH sent flash on hamfest date. SFA got his modulator working, and is on QMN and 1.75 and 3.9 Mc. OCC is trying to improve his signal by improving his e.c.o. FX is working on 56-Mc rack. DPE can be found on QMN any day from noon to around 2 P.M. PPQ will be on QMN in his spare time. SCS expects to be on QMN more often. RYP is trying hard for B.P.L. SHI, PLC, CE sent reports via radio. DAQ made B.P.L. Congrats, OM! He is going to be R.M. in his area. IXJ also hit the B.P.L. FB! UES is new reporter. JUJ is doing his hamming with emergency rig. EGI reports OCQ of Jackson moved to Rochester, N. Y. Michigan Nines: YYA is getting new HQ120X. YNY is working on U.P. Net. FB, OM. Luck! DVC is going to get on QMN regularly. GQF reports 9HYZ new station up state. EQV does some traffic handling along with crystal grinding. FLASH — Hamfest being held at Ypsilanti National Guard Armory, April 28th. Be sure and be there. Meet your old friends of the air. Hear your A.R.R.L. President talk and meet him in person. Don't forget the date — April 28th. Note that it is on Sunday. Mark your calendar now. Your S.C.M. would like ALL E.C.'s and R.M.'s to be present if possible. Big time for all. BCNU — 73 — Hal.

Traffic: W8DAQ 551 SAY 542 RYP 434 SCW 182 IHR 160 QGD 137 RMH 115 QZH 100 FTW 77 (WLTJ 34) QKQ 239 AXZ-OCC-CEU 63 TBP 62 PLC 45 SFA 44 MQT 41 DPE 40 JUQ 38 RJC 27 TJQ-SQQ 26 FWU 19 SCS 19 ONK 20 SHI 10 JVI 7 AHV 5 TFPV-PPQ 4 MCV-NUV 2 WO-NXT 1 KPL 3 IXJ 519. W9DVC 108 UCD 36 YNY 29 EQV 17 GQF 4 YYA 3 YTU 72.

OHIO — SCM, E. H. Gibbs, W8AQ — SJF and CJL made the B.P.L. again. Nice work. Glad and Red! CJL built freq. standard, and has 'scope under construction. GZ and RFF continue to pile up nice totals. FJN joined Regulars Net and is in line for O.R.S. FFK, Cleveland Heights and TGU, Zanesville, are new O.R.S. Sorry to hear of illness of HCS' father. ROX stayed in O.R.S. party even when temperature in shack fell to 2 below zero! UDN had 1800 QSO's in first 3 months on the air. RNV is back from school in Kansas. Code classes from CBI are discontinued temporarily while he rebuilds for higher power. OOH joined Regulars Net. RVK reports new net on 3565 kc., at 9 P.M., called "TLX." Officers of Toledo A.R.A. were re-elected: pres., RXR; vice-pres., RRV; secy., NXN; treas., GJS; sgt.-at-arms, HBR. LCV has new e.c.o., and expects to get the remaining 3 states any day now. TGU has spent past 4 years in hospital bed, but active with two separate rigs on 3730, 7192 and 1938 kc. TYH works both coasts with the Portable Five shown in last Dec. QST. GVX hooked Mont. and Wyo. towards W.A.S. PIH worked CM6AC on 3.5 Mc. PCW at U. of Cinci. is new O.R.S., transferred from W.N.Y. Section. Lucky BAH is spending part of winter in Fla. QBF is rebuilding to pair of 805's in final. JFC has been appointed Emergency Coordinator for Cincinnati and NPZ for Springfield. KNF put pair 1552's in receiver, and is very pleased with improvement. PUN has new field strength meter. Greater Cincinnati A.R.A. has scheduled a boat ride on the river for April 20th. Ft. Hamilton R.C. at Hamilton has been reorganized. PNJ is on 7 Mc. looking for slow c.w. stations — hi! FB. Congrats to Corky. IAI, who is proud daddy of Patricia Ann, born February 1st. SXU and SXV worked W6 on 1.8-Mc. 'phone. DSZ needs only 3 states for 1.8-Mc. 'phone W.A.S. PPF has new band-switching exciter. JDJ built 28-Mc. beam. LWT has new 450-watt 'phone rig

on 14-, 3.9- and 1.8-Mc. bands. VZ eas new e.c.o. for big rig, and worked new state in W.A.S. party, leaving three to go. FNX, Elyria, has been reinstated as O.P.S. Fostoria Wireless Ass'n has local Emergency Net on 1830 kc. ESN, Toledo, is back in his old haunts and active on all bands. The Toledo Radio Club puts out a very new and interesting Bulletin each month. ULE is new Cleveland ham. TAA got Class A ticket. SQL is going back on 7 Mc.

Traffic: W8SJJF 1008 CJL 556 TTX 405 GZ 367 RFF 265 (WLHR 106) KGI 177 FJN 152 FFK 148 NAB 146 HCS 142 IET 127 KZO 126 LZE 111 RN 108 HMH 79 ROX 77 CBI 71 RMA 71 CUF 62 PST 60 WE 57 LAU 52 AQ-NAL-OFN 51 OOH 46 BEW 36 EQN 33 RVK 30 NXN 24 LCV 20 TGU-QBF 18 QLO 16 TYH 16 UW 14 (WLHI 187) NQZ-RLR 12 JFC 10 HZJ 9 GVX 6 PIH 5 KHM-APC 4 PZA-SQE 3 KNF-DDM-NKU-JLF 2 SCT-PUN 1. (Dec.-Jan.: W8RLR 67 NAL 22.)

WISCONSIN — SCM, Aldrich C. Kroner, W9UIT — State Net frequency: 3775 kc. The new State Net time is 6 to 6:30 P.M., daily except Sun. (General call: QWS). This gives the state an hour for traffic instead of a half hour as heretofore, as the A.A.R.S. Net follows from 6:30 to 7:00. All members of A.E.C. are urged to get their equipment going on 3775 kc. so that in case of emergency they can contact other Wisconsin stations with the minimum of delay. Don't let the antenna problem worry you, as a 14-Mc. vertical works very well on 3.5 Mc. Reporting regularly into the QWS Net will get you acquainted with other Wisconsin stations and improve operating ability. Through the combined efforts of BZU, QCN and RKT of Manitowoc and YYL of New London, an important emergency message was handed to Green Bay, Jan. 14th. Nice going, 'fellows. NOQ, station of the Chippewa QRR Club, will be housed in a new house trailer. ZVO, new O.B.S., is on 14-, 3.9- and 1.75-Mc. 'phone and 3.5-Mc. c.w. PRM has been getting out well with his portable-emergency rig. BNB is on 14 and 28 Mc. with new 805 P.P. final. YCV joined the Army Signal Corp and is located at Fort Sheridan, Ill. QJG is being transferred from C.C.C. at Menominee to Sparta. VVS has new Sky Buddy. SKX is operating portable at Oak Park, Ill.; he formerly was at Eau Claire. MEE is operating 3.5 Mc. from a vibrator supply. BIT is experimenting with portable rig and vertical antenna with ground screen for emergency. DKH, old timer at Manitowoc, is active again, and going bigger and better than ever. SZL and XYL visited UIT. The S.C.M. thanks SZL, YXH and DKH for their many helpful suggestions regarding the State Net and traffic problems in general. HSK is still basking in the sunny Florida climate around Miami. VDY while active in traffic work still finds time to fish for a little DX. RNX was on 14 Mc. during last O.R.S.-O.P.S. party. DCU was appointed State Net Control for A.A.R.S. 3955-kc. Net; GAH, District Net Control, District C; VNJ, 1st State Alternate; HKE, 2nd State Alternate; and MLJ, Corps Area Net Control for 3.9-Mc. 'phone. HMU has new rig on 3.5 and 7 Mc. ILJ worked KAR, both using dummy antennas. QKN has been doing fine with 18 watts to an 807. AFL is on 28 and 1.75 Mc. with low-power cathode-modulated rig. TJI's rotary is taking a beating from wind; now out of use. VGT reports regularly into the A.A.R.S. EMO is active on 3.5 Mc. DDD is active operator of WRPA, Washington County Police. CUW has new HQ120-X and will be on with 75 watts on 7 Mc. The Milwaukee Club is getting the ball rolling for the Wisconsin State Convention, June 15th and 16th.

Traffic: W9YXH 1122 (WLTA 19) DKH 275 SZL 104 (ARRS 12) VDY 92 EYH 74 MLJ 50 CRK 46 AKT 44 BGT 42 UIT 26 RSR 7 HMU 6 ILJ 2.

WEST GULF DIVISION

NORTHERN TEXAS — SCM Lee Hughes, W5DXA — FMZ is experimenting with e.c.o. HTH traded his receiver for NC8IX. AZB is working with TLM. AHX worked in 1.75-Mc. W.A.S. Party. DUZ works 6 bands with one rig, one antenna. HVQ and GFN work 1.75- and 28-Mc. 'phone. ECB is operating portable in Waco. Fellows, when you report include some news — if I try to put some in about you it may be the wrong thing. Hi! "How about your A.E.C.?" The Engineering Show of Texas Technological College had an amateur station as part of the program. Amateurs enrolled in the college helping to make this program a success were: FZU, GMC, GDS, FMQ, EDU, IIB, GDH, FYZ, GWX, HFF, IEB, IEM, INS, IDR. Other amateurs not in college but lending a hand in relaying messages were: HDU, HQD, DV, GBS, HKB, BA, GPJ, HVZ, FQP, CV, DUW, FSU. DXA has worked K4, K6,

K7 on 3.5 Mc. and heard XE1 and K5. 9AGF is now located at Love Field, Dallas, where he is employed by the U. S. Army Air Corps as a ground school instructor.

Traffic: W8CDU 138 BAW 87 FMZ 44 DXA 32 HTH 30 EOE 298 AZB 28 CHJ 17 HFN 12.

OKLAHOMA — SCM, Russell W. Battern, W5GFT — CEZ is still high traffic man for Section, with FOM running close second. FOM made B.P.L. again this month. Nice work, Deav. FSK-4 is operating portable from Camp Jackson, S. C. GFT is rebuilding exciter. FOJ is doing a swell job with the Muskogee Club bulletin, the "Bloopier." ERW has been experimenting with different types of oscillators. DTU with HQU is organizing a 1.75-Mc. 'Phone Net. Anyone interested in joining the net, please get in touch with either of them. AAJ received O.R.S. appointment. EMD has the 8th C.A. Cipher Busting Club going strong. GER is enjoying work with the c.w. gang in the State Net. GAG is a member of the S.E. Kansas 1.75-Mc. 'Phone Net as well as the Okla. Section Net. GVV is rebuilding rig. GZR is practicing Morse Code. ASV received Emergency Coördinator appointment for Ponca City. CPC received O.B.S. appointment. HQU is acting as net control station for 1.75-Mc. 'Phone Net operating on 1932 kc. at 7 p.m. daily. AIR is moving transmitter to new QTH.

Traffic: W5CEZ 916 (HE8C 100) (WLJC 58) FOM 803 FSK/4 504 GFT 335 (WLJE 22) EIO 135 GFH 116 GZU 98 FOJ 89 ERW 68 FRB 61 DTU 52 AAJ 46 EMD 29 BOR 26 DAK 23 GER 19 GAG 18 GVV 13 BYC-YJ 9 GZR 8.

SOUTHERN TEXAS — SCM, Horace E. Biddy, W5MN — BEO and EEX worked all districts on 28-Mc. mobile. DPA has regular 7- and 1.75-Mc. schedules on Sun. and Wed. HNF reports 39 locals active on 1.75-Mc. 'phone. also emergency program work being carried out by the club. FAR wants O.P.S. HME and DBR want O.R.S. IGX using 20 watts and J antenna on 28-Mc. 'phone, worked 29 states. LJZ is active on 1.75-, 7- and 28-Mc. 'phone and c.w., and has worked 33 states on 28 Mc. with vertical. IHD is using 110 watts with Marconi on 1.75 Mc. IBV moved to Houston from Caldwell. 9FSO moved to Houston. HSX, using 40 watts on 1.75-Mc. 'phone, works regular schedule with old QTH in Iowa. AMX is experimenting with antennas on 14 Mc., and also has brand-new daughter. BVH is very active on 28 and 14 Mc. with 200 watts and beams. FQQ is using 600 watts on 28- and 1.75-Mc. 'phone. HVN has 1.75-Mc. portable and also uses 300 watts c.w. on 14 Mc. with vertical half wave. GLS is on 14-Mc. 'phone with 300 watts and doublet. HAQ is busy building. DOM is again active on 7 Mc. GQC is active on 7 and 14 Mc. BKW with 400 watts has regular schedules on 1.75-Mc. 'phone. FWC is active on 28 Mc. with 75 watts and rotary. IGJ works 7 Mc. IHY shows some 1.75-Mc. 'phone activity. IIE likes 7 and 14 Mc. AKN has portable 1.75 Mc. and mobile 28 Mc. HPJ using 100 watts is ready for 1.75- and 28-Mc. 'phone and 7-Mc. c.w. EIB and EUG have Halli-crafter rigs and use long wire antenna. FDR has many schedules and much traffic. CVQ, N.C.S. for A.A.R.S., managed to keep schedules, even though down with flu. GWL moved to new QTH, has private shack and is now O.B.S. EWZ has a Hetrofil for his SW-3. EPB is using Signal Shifter to a kw. on all bands and is prepared to handle traffic to KC4USC. JC and FAR are O.B.S. CAP has new NC44A.

Traffic: W5OW 1898 FDR 1019 MN 568 DWN 145 CVQ 121 HNF 54 DLZ 49 GBF 38 BEF 29 EWZ 11 EPB-GWL 6.

NEW MEXICO — SCM, Dr. Hilton V. Gillett, W5ENI — GPB honors this Section by making B.P.L. two ways. HAG reports the Weather Bureau Net functioning perfectly. Weather Bureau officials at Albuquerque are immensely pleased with amateur coöperation. ZM has the A.A.R.S. Net working better than ever before. ENI, the S.C.M., is keeping regular schedules on N.T.L. Net. T.L. M and N. Mex. State Net. HPV has several good early morning traffic schedules. HJF has been playing much chess by radio; beats his S.C.M. consistently. ND, though in Ft. Worth, is part of New Mexico Net. CHU is currently operating from El Paso, Tex. FSP is busy in potash mines, but finds time to work in net. GGO is now "regular" in N. Mexico Net. GSD is another chess player. ETM is now using 'phone as well as c.w. HDN uses 130 watts on all bands, 1.75 to 28 Mc.; he does not have a kw. on all bands with band switching as previously reported in error.

Traffic: W5GPV 509 HAG 302 ZM 250 (WLJG 63)

ENI 229 HPV 123 (WLJB 18) HJF 70 ND 39 CHU 36 FSP 35 GGO 28 GSD 23 ETM 15.

ROCKY MOUNTAIN DIVISION

COLORADO — SCM, Carl C. Drumeller, W0EHC — R.M.'s: 9EKQ, 9FDR, P.A.M.: 9IVT. HFC tops the traffic list this month. ZDZ is busy with E.C. work. PPU and GZA are lining up with the A.E.C. SAX, LLP, GHY, IVT and FXQ get together on 3.9 Mc. at noon for a round-table. EII is teaching radio and moved his rig to the Western State College. HGK has trouble getting into Denver on 3.5; will we have to shift over to 1.75 Mc. for around-state traffic work? EHP at La Junta has a new HT-9 transmitter. NDM, E.C. for La Junta, has an A.E.C. Net organized, including TVV, YQA, SXI and 5FU-A. NKR is Greeley's most active station, using 29-, 14- and 3.9-Mc. 'phone. NEY gets on Sundays and odd evenings with a T125 rig. HWH, new amateur, is on 7 Mc. with a T21. FQK has swell results on 14-Mc. 'phone using an 807 final. PO tosses 135 watts into a T55 on 29-, 14- and 3.9-Mc. 'phone. OQL is off, owing to getting married. OGG works 29 Mc. Sundays. VGC spends 90% of his time ragchewing. WVZ runs a whole stack of schedules; his new QTH is Antonito. FKK gets on every day. NBK is putting in a pair of 812's. CBE is on 29-Mc. 'phone. FCJ worked a KA on 29-Mc. 'phone. BQO has worked all but the 4th dist. on 1.9-Mc. 'phone with a Marconi antenna only 20 ft. high. CAA, IDB, TFP and BQO took part in the Telephone Company Hobby Show. WYX and VTK schedule WRO on 112 Mc. IDB has a vertical doublet on 112 Mc. BJN puts out a fine signal on 29-Mc. 'phone with a vertical antenna. QDC is interested in O.R.S. TOC has his ticket back. HXZ has a new Halli-crafter receiver. KGR and BJK got back on 1.9-Mc. 'phone. ZNH is operating at Boulder while in college. YFJ got a card from a KF6. HBU is on 1.9-Mc. 'phone. MOH is cathode-modulating a pair of '10's. YDS is heard on 'phone for schedule with ZNH. YXH has a 35T on all bands. UPI and ADV are working DX on 3.5 Mc. ZJM and DDI are planning to use a pair of 812's in the final. YFM got married. OUI is making frequency checks preparatory to becoming an O.O. We all offer our condolences to MIKG in the loss of his infant son. GKW got a Class "A" ticket and has his P.P. T55 rig almost done. SBJ is an old-timer at Montrose on 1.9-Mc. 'phone. GMB has been handling a stack of traffic. FQT is busy promoting the coming convention, and it looks like it will be a honey; so start saving your dimes. OM's and YL's. GZA has a new SX25. WJJ has a new exciter based on an XEC. HHD has daily schedules with MKU and HWE. USP worked a K6 on 3.9-Mc. 'phone and is gunning for a 3.9-Mc. 'phone W.A.S. 9AMQ/5 craves contacts on 3600 and 3840 kc. ERQ is building an osc. Ice broke a 46-ft. stick that held the apex of GBQ's V beam! USI is building a new antenna and laying in wait for KC4USC. TMA has a 6L6 rig on. IVT knocked off KC4USC and KF6JEG. HIR is on again. DKK works 1.9 and 3.9 Mc. UEL visited EVT and EHC. QEC has a good traffic total, most of it from the Hobby Show. RX and RTQ are on 3.9-Mc. 'phone at Grand Junction. HWR is on 14-Mc. 'phone. CYM is using a cathode-modulated transmitter on 1.9 Mc. EEC is sticking close to 1.9 Mc. and is playing with a P.A. system. EGH is busy handling traffic on the A.A.R.S., building to higher power, and working the local 1.9-Mc. 'Phone Net. EHC is working all bands from 1.9 to 29-Mc. 'phone and c.w. EVT has a new transmitter, but the same model as the old one. FBF is rebuilding. GBX is thinking of adding a pair of 812's to the present transmitter. FXQ has a new cathode-modulated transmitter on 3.9 Mc. GKJ is running 200 watts into a T55 final on 1.9-Mc. 'phone. HHD is alternate net control station on the local A.A.R.S. 'Phone Net. KKY is still hitting 3.5-Mc. 'phone and c.w. LFE traded for another rig and now is on 29 Mc. LIU is the proud papa of a baby girl. NWQ is net control for Division "M" A.A.R.S. OAR is working 1.9-Mc. 'phone, using a T20 cathode-modulated. YLT is oiling his gun for the "skunk" who is bootlegging his call. WZI, UEL, SAU, TDR, WTN, ZJQ and WWB are on 1.9-Mc. Flea-Power 'Phone Net in Pueblo. HFC is a member of the A1 Opr. Club. FB, Tom. WVZ has a Howard 435 receiver and a Hetrofil; says they are FB for high altitude work; he has 51 inches of snow. Denver A.E.C. is planning contest preliminary to Field Day. YKP has a new c.w. rig that is a wow! Thanks, gang, for the many reports this month; keep up the good work. 73. — Carl, EHC.

DEPENDABLE

Crystal-Control

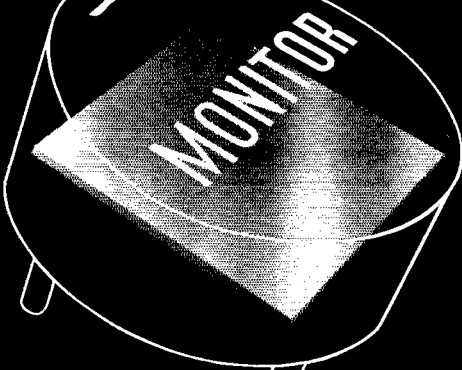

Superior Frequency Control Units available for all purposes. It will pay you to inquire! * * *

MONITOR

Radio-Products Co.

1138 MISSION ST., SOUTH PASADENA, CALIF.

FROM CHASSIS TO COMPLETE SYSTEM USE PAR-METAL

It's only logical that when building a P.A. Amplifier or complete P.A. System, you should consider PAR-METAL first when it comes to Chassis, Racks, Panels and Cabinets. There's a reason! Par-Metal Products are of modern, streamlined design, attractively finished, accurately machined and designed for rapid assembly. No wonder they are the choice of so many engineers and editorial writers.

BUILDING A NEW RIG?

Then be sure to get the latest PAR-METAL Catalog which illustrates and describes the complete PAR-METAL line of chassis, cabinets, racks and panels for amplifiers, transmitters, receivers and other radio equipment. If your jobber is out of catalogs, write us direct.

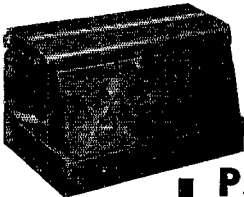

New DeLuxe Amplifier Chassis and cover.

PAR-METAL PRODUCTS CORP.

3266 49th STREET
LONG ISLAND CITY, N. Y.

Improving the Flying Skywire

(Continued from page 53)

It is also apparent that while some adjustment can be made before flight is attempted, one cannot change the position of the string on the bridle while the kite is in flight. Often with gusty winds the velocity goes through a considerable range. This is the reason for the inclusion of A.W.C. or "automatic wind control" in the kite bridle. Simply by making the lower half of the bridle out of rubber bands, it is possible to change effectively the position of the string on the bridle by the lengthening of the lower part of the bridle due to the stretch in the rubber band. The stronger the wind, the greater the stretch, and the kite consequently flies flatter and offers less wind resistance. When the wind drops, the kite comes back into the wind again. This device helps to a remarkable degree in providing trouble-free flight so that the radio man can tend to his radio and doesn't have to nurse the kite all of the time. However, there is still some latitude of adjustment in the actual point to which the string is attached to the bridle. In very strong winds the string should be fastened nearer the head of the kite. Experience is the best teacher, and we recommend that a number of test flights be made using heavy string instead of wire. Generally speaking, it is not necessary to put a tail on the kite. A tail adds to the weight that must be carried and is a visible admission that the bridle is improperly adjusted.

A piece of fish line about two feet long should be used for the top half of the bridle. This should be knotted about every two inches both for reference and to insure against slippage of the string on the bridle in flight. A loop should be made in the top end of the bridle cord so that it may be slipped through the slit in the covering and pulled up and over the top of the vertical stick. The latter should be notched half way between the cross stick and the top so that the loop can be held in place. The bottom end of the fish line fastens to two parallel pieces of $\frac{1}{4}$ -inch square rubber band 18 inches long. The bottom end of the rubber band in turn fastens to a small piece of fish line about 6 inches long which is looped around the vertical stick halfway between the foot of the kite and the cross stick. Generally the "flying" string will fasten on to the bridle a short distance above the junction of the rubber band and the upper piece of fish line comprising the bridle.

As pointed out above, experience will do more than volumes of printed instructions, but the main highlights are listed herewith: First, a tendency to fly to one side all of the time indicates lateral unbalance. Second, the placement of the string on the bridle is all important, as described above. Third, do not attempt to judge performance while the kite is near the ground. The air currents are extremely variable until you reach an altitude of better than 100 feet. Fourth, the wind tends to drop at sundown in many places, making it difficult to put up a kite at that

(Continued on next left-hand page)



*Buy Hallicrafters, the World's
Largest Selling Communications Receiver
from
Bob Henry W9ARA*

THIS IS A PHOTO OF HALLICRAFTER SETS CARRIED IN STOCK

Write me about type of receiver you want. I will help you get the right receiver and will cooperate with you to see that you are 100% satisfied. Ask for technical information about any receivers.

YOU get ten days free trial — you don't buy unless you are satisfied.

YOU buy on 6% terms financed by myself with less cost — more convenience — quicker delivery. Transaction is entirely between us.

YOU get big trade-in for your receiver — describe it and I will tell you its value — you can pay the balance on my 6% terms. Don't trade until you get my offer.

YOU get prompt shipment from the world's most complete stock of amateur receivers. Or shipment from the factory if you wish.

I have a complete stock of all receivers, transmitters, kits, antennas, tubes, parts. Send to me for any equipment. I guarantee you can't buy for less or on better terms elsewhere. Your inquiries and orders invited.

Bob Henry
W9ARA

HENRY RADIO SHOP

What —

Is the F.C.C. Regulation Re: ?

- Operation in times of emergency
- Measurement of xmitter frequency
- Operation of 'phone transmitters
- Measurement of transmitter power
- Frequencies for ham television
- New ultra-high-frequency bands
- Stability of signals up to 60 Mc.

*THE ANSWERS will be found in
the current (tenth) edition of*

THE RADIO AMATEUR'S LICENSE MANUAL

Going after your first ham "ticket"? You need the manual for its instructions on where to apply, how to go about it in the right way — and, most important of all, for the nearly 200 typical license exam questions and answers.

Already licensed? The manual is still necessary for its dope on renewal and modification procedure, the Class A exam (with typical questions and answers), portable procedure, etc.

ALL the dope on every phase of amateur licensing procedure, and, of course, the complete text of the new regulations and pertinent extracts from the basic radio law.

25¢ postpaid
(No stamps, please)

THE AMERICAN RADIO RELAY LEAGUE
West Hartford, Connecticut

time. However, once a kite is up 1000 feet the chances are that it will stay there for a long period of time. In perfectly still air on the ground there is likely to be a current up 200 feet or so. Fifth, play safe in strong winds by starting the string on the bridle nearer the head of the kite than is customary. Sixth, do not pay out a long length of line to start the kite in a strong wind. The kite is likely to break due to the unusual strain before it can get up into the wind. Ordinarily, unless the breeze is extremely light, the kite will fly right out of the operator's hand.

With the kite completely under the control of an experienced "airman," we are now ready to get back to the subject of radio once more. We do not have a particularly good answer to the subject of antenna wire. The resistance of any of the alloys of copper mounts so rapidly that their use is prohibited. The best material that we have found is No. 18 hard-drawn copper wire, which runs 200 feet to the pound. A kite as described above will easily lift 1500 feet of this wire unless the breeze is extremely light. If considerable flying in strong winds is expected, it would be advisable to have a length of No. 16 hard-drawn wire available, as the No. 18 wire is likely to break in winds of 30 m.p.h. or more despite care in adjustment of the bridle. The reel on which the wire is wound should not have too great a diameter. Six inches seems about the maximum, since a greater diameter gives the kite an unpleasant mechanical advantage that must be felt to be appreciated. We should like to inject a word of caution at this point. Under no circumstances fly the kite with wire when there is any possibility of its making contact with high tension wires. While you may escape, remember that a fallen copper wire will be extremely attractive to children who won't know it is loaded until it is too late. You can't patrol a 1000 foot wire in the city or suburbs. Another note of caution when flying with wire is to remember that Ben Franklin was right — there is "juice" up there. Often it is present when you would least expect it, such as on clear days. It can give a substantial kick if the wire is left ungrounded for a few minutes. The cure is simple — a short iron stake is driven into the ground and a flexible wire about 20 feet long is attached to it. A clip on the end of this wire is clipped over the kite wire so that the wire may easily run through it. This keeps the static charge down to zero.

With an actual input to the antenna of not more than three watts, we have consistently worked 25 miles on 56 Mc., with the kite approximately 800 feet above the earth. These results were obtained in flat country, and with an additional 600-foot boost from a hilltop the rig has worked over 50 miles with no difficulty. Signals from the high powered 56-Mc. boys that are inaudible on regular antennas come in consistently from 75 and 100 miles away.

As mentioned above, the first tests that were made on the lower frequencies with the kite antenna was on the A.R.R.L. Field Day, at the

(Continued on next left-hand page)



THE *Final Addition*
TO THE AMATEUR SHACK

TRUE HIGH FIDELITY REPRODUCERS

Model AT-9 is one of a family of Jensen High Fidelity Reproducers built primarily for broadcast monitoring and recording work. It incorporates the well known Paradyne and Rex Bell principles. These energy density acoustic treatments conducted in an average listening room show a good frequency response characteristic from 20 to 20,000 c.p.s. It represents the final perfection in the high fidelity superior broadcast cabinet. Cabinet dimensions are 24" x 17 1/2" x 1 1/2" deep. Complete with heavy duty permanent magnet driver. **Model AT-9 - \$29.00. At your Jensen Distributor.**

Jensen

6601 SOUTH LARAMIE AVE., CHICAGO

S P E A K E R S

Covers the Entire 360° PREMAX ROTOMOUNT

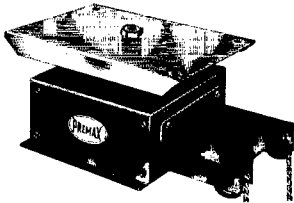

Latest improvement in mounting rotary antennas. The Premax Rotomount is made of heavy gauge steel throughout; reinforced platform mounted on welded one-piece steel shaft revolving 360° on a 44 steel ball-bearing raceway. Hollow shaft permits passage of lead-in. Equipped with stranded copper lead cables.

Send for Bulletin HR-399 describing this and the new Worm-Drive Rotomounts and Motor Transmissions.

PREMAX PRODUCTS

Division Chisholm-Ryder Co., Inc.

4020 HIGHLAND AVE. NIAGARA FALLS, N. Y.

PINCOR

SIZE
FOR
ANY
JOB



DYNAMOTORS

Pincor Dynamotors are as much "at home" on tough jobs as on ordinary ones. No wonder they are specified by governmental and commercial users universally for aircraft, marine and broadcast service, police units, sound systems, auto radios, etc. Available in a wide variety of types and frames for any requirement. Highest efficiency and regulation. Capacities: 10 to 850 watts. Input, 6 to 110 volts; output, up to 1750 volts.

Specify "Pincor" — and be sure of thousands of hours of dependable, quiet service. Mail coupon for complete information.

PIONEER GEN-E-MOTOR CORP.
CHICAGO, ILLINOIS

Export Department: 25 Warren St., New York, New York
Cable Address: SIMONTRUCK, New York

Pioneer Gen-E-Motor Corp.

Dept. R-6D, 466 W. Superior St., Chicago Ill.

Please send information on Pincor Dynamotors, Motor Generators and special power supply units.

Name

Address

City.....State.....

Tri-County station W2GW-3 at Somerville, N. J. As one of five positions, the unit was a complete washout on Saturday night due to a local thunderstorm that made it imperative that the kite be taken down before we got a real shot of Ben Franklin's elixir. Sunday came along more or less calm and peaceful, and the kite proceeded to justify itself all day long. With 1100 feet of wire at a 60-degree angle, working against ground, the push-pull crystal oscillator on 40 and 80 meters poked out all day long. Inasmuch as reports ranged from S7 upwards and the input was around 15 watts to a relatively inefficient rig, we feel confident that the kite antenna deserves full credit for the successful operation of this particular rig. Five meters also supplied a couple of contacts 35 miles away behind a mountain range, although the kite was "over the top" as far as the hill was concerned.

In conclusion, we believe that every ham interested in portable work and emergency work will find the kite a helpful adjunct to his station. No one has ever successfully refuted the argument that a long wire antenna works fine. The kite makes possible the erection of many sizes of antennas in the best place discovered — free space.

Electronic Keying

(Continued from page 14)

the fingers, as large knurled lock nuts are provided. Adjustments are permanent and no further attention should be necessary.

A slight sideward swaying action of wrist is all that is necessary to send at say 30 or 35 words per minute. Besides making operating more of a pleasure the perfect spacing of characters improves the operator's straight-key sending ability. Once you have learned to use the automatic dash, you'll have a tendency, in attempting to use a regular bug, just to hold the dash lever waiting for a dash or dashes to "pop out!"

The electronic key is a new and practical application for the thyatron. It is not within scope of this article to describe all of the technical considerations. The constructor should have no difficulty in duplicating results. The technical man can study the circuits and glean the data that are not included. If you have a better method, let it be known. It's yours, what can you do with it?

* * *

EDITOR'S NOTE: A key of this type has great possibilities in improving the quality of hand sending, but its general application will naturally depend considerably upon cost. It has perhaps occurred to some readers, as it did to us, that mechanical switching could be substituted for the two auxiliary relays. A three-pole double-throw switch is required, and the Yaxley jack-switch seems to be almost made to order for the job. One of the photographs shows a haywire model of such a "key," which, crude as it is, proved thoroughly practical. Under construction is a more pretentious model which can be built by any amateur who has a few ordinary metal-working tools. We hope to describe it in next QST.

All you could wish for . . .

IN 40 METER CRYSTAL PERFORMANCE

HIGH ACTIVITY

Uniformly high activity. Easily excited, starts instantly and accurately follows keying.

LOW DRIFT

Stable and accurate. Drift less than ± 4 cycles/mc./ $^{\circ}$ C. and frequency in your transmitter guaranteed to be within $\pm .03\%$ of the frequency stamped on the nameplate.

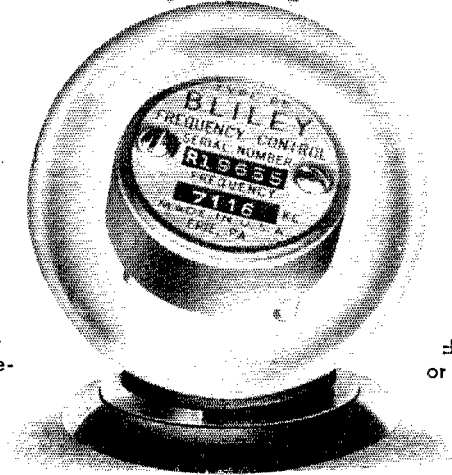

DEPENDABILITY

Reliable characteristics assured through correct engineering, accurate cutting, precision lapping, rigid manufacturing standards and exacting testing.

ECONOMY

Economical, not cheap. For sale at all Bliley Distributors for \$4.80 (within ± 5 kc. of desired frequency or choice from stock).

BLILEY B5 40-METER UNIT

GAMMATRON

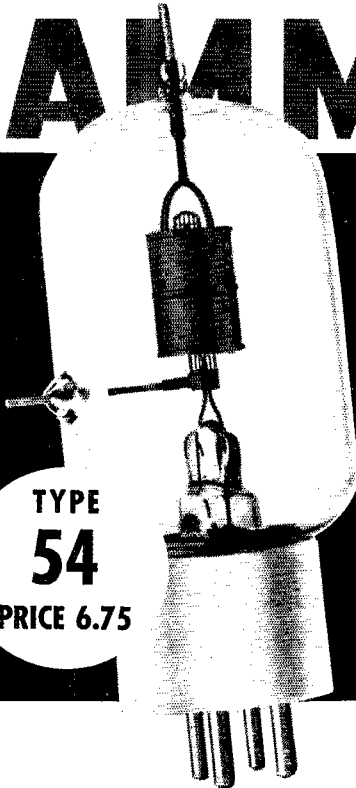

TYPE

54

PRICE 6.75

FOR IMPROVED TRANSMITTER PERFORMANCE try Gammatron tubes. Note their large power gain per stage due to a high mutual conductance, and their ability to "take it" due to their gas-free construction. This means that a Gammatron rig is trouble free and inexpensive. WRITE FOR DATA

HEINTZ AND  KAUFMAN
SOUTH SAN FRANCISCO CALIFORNIA U.S.A.

The Design of Speech Amplifiers

(Continued from page 61)

condensers of these capacities. The very best paper condenser is required for this purpose, leakage of d.c. through C often placing an unsuspected positive bias on the grid of the following tube, a condition fatal to Class-A operation with resistance coupling. Mica insulation is preferable but high capacity condensers with this dielectric are expensive and bulky.

To minimize bass response, to say nothing of transformer hum picked up by the microphone, a small mica condenser of about 0.004 or 0.006- μ fd. capacity may be placed in series with C , offering fairly low reactance to intermediate and high frequencies but, in a sense, rejecting the extreme lows. It may be shorted by a small switch when full bass response is desired. A 2-megohm resistor in parallel with the switch will avoid switching clicks.

The high-frequency response cannot be affected materially except by choice of tube and care in wiring to reduce stray capacities. As a general thing, the combined grid-to-cathode, plate-to-grid and plate-to-cathode capacities, which effectively by-pass the grid and plate coupling resistances to ground, are less with low- μ triodes and screen-grid tubes than with high- μ triodes. Hence, use of the former materially extends the range of the amplifier into the higher registers.

To reduce high audio frequency gain, a series variable resistor and a condenser may be placed between the plate or grid of a later stage and $B-$, the condenser being chosen so as to offer low reactance to the intermediate and low frequencies. Usually 0.001 or 0.002 μ fd. will be satisfactory. The variable resistor should have a range at least comparable to R_p or R_g , whichever it parallels. When all the resistance is in, the high frequencies are saved; when full out, they are by-passed to ground. This combination is the usual "tone control" included in broadcast receivers. In conjunction with the bass control described above, a more or less narrow band of audio frequencies may be passed through the amplifier, concentrating the valuable modulator power into readily intelligible, if not high fidelity, speech components of the transmitted signal.

Transformer Coupling

Transformer coupling is a common method now applied only to medium- or high-level stages, usually with the lower- μ triodes, where the effect of stray magnetic fields of power transformers and chokes may be made negligible and where it is desired to transfer some power. The input and output of the power stage are almost always transformer coupled. The method has the distinct advantage of permitting, if desired, a voltage step-up within the transformer itself and allowing, in many cases, the practical overall voltage gain of a stage to exceed the amplification factor

(Continued on next left-hand page)

THE A.R.R.L. ANTENNA BOOK HAS WHATEVER YOU WANT!

Chapters:

1. Wave Propagation
2. Antenna Fundamentals
3. Ground Effects
4. Feeder Systems
5. Half-Wave Antennas
6. Long Single Wires
7. Multiband Antennas
8. Driven Arrays
9. Parasitic Arrays
10. "V" Antennas
11. Rhombic Antennas
12. Antennas for 160 Meters
13. U.H.F. Antennas
14. Special Antenna Systems
15. Finding Directions
16. Supports and Construction
17. Rotating Mechanisms
18. Receiving Antennas

144 pages, in "QST" format.

50 cents, postpaid. No stamps, please!

A.R.R.L.

WEST HARTFORD

CONN.

Veteran Amateurs

*Enjoy Their Hobby
With Astatic Mikes*

Great numbers of experienced amateurs are happy in the possession and performance of Astatic Microphones . . . a satisfaction based upon range and clarity of transmission even under most adverse conditions. "You'll be enthusiastic with Astatic."

See Your Astatic Jobber or Write for Catalog



Astatic Microphone Laboratory, Inc.
YOUNGSTOWN, OHIO

*In Canada: Canadian Astatic, Ltd., Toronto, Ontario
Crystal Products Licensed Under Brush Development Co. Patents*



JT-Series
Crystal
Microphone
List, \$16.50

M. B. ANDREWS W5GIK
Engineer Ground Radio, American Airlines, Inc., Chicago, Ill. and his 3 weeks old, junior operator.

WANTED — Used GORTON ENGRAVING MACHINE. Give full details as to condition, serial number and price. Write Box 74, c/o Advertising Department, *QST*, West Hartford, Conn.

*P*iezo-Electric Crystals Exclusively

- Quality crystals of all practical frequencies supplied SINCE 1925. Prices quoted upon receipt of your specifications.

Our Pledge: **QUALITY FIRST
SCIENTIFIC RADIO SERVICE**

"The Crystal Specialists Since 1925" University Park, Hyattsville, Md.

● TELEGRAPHY—TELEVISION—TELEPHONY ●

AVIATION

TRANSRADIO
PRESS

TELETYPE

TYPEWRITING



PRACTICAL

EXPERIENCE

STUDIO —

TRANSMITTER —

ANNOUNCING

The major technical training equipment owned by Port Arthur College and in operation on the college campus consists of 1000-Watt High Fidelity RCA Transmitter of latest design, operating on 1220 kc. with a directional antenna system, two-way Television Transmitter and Receiver, Latest Type RCA Marine and Airways transmitter installation complete; SOS Automatic Alarm; Marine Direction Finder; Trans-radio Press Receiving Equipment, and Laboratory complete where students assemble composite transmitters, amplifiers, audio amplifiers, R.F. amplifiers, etc.

Port Arthur College pioneered the teaching of Radio with classes in 1909, and for thirty-one years has maintained an active Employment Bureau for the placement of its graduates.

If interested in details about Radio Course, write for Bulletin R

PORT ARTHUR COLLEGE ■ PORT ARTHUR (World-Known Port), TEXAS

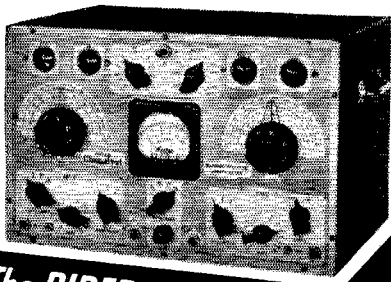

The RIDER CHANALYST *Is tops*

The Rider Chanalyst established signal tracing. It was the first instrument of its kind and still is the top instrument! Dollar for dollar the RCA Rider Chanalyst offers the most for the money. It offers the greatest utility, flexibility, and stability, together with freedom from complicated circuits . . . \$107.50 net.

Over 335 million RCA Radio Tubes have been purchased by radio users. In tubes, as in parts and test equipment, it pays to go RCA All the Way.



Test Equipment

RCA Manufacturing Co., Inc., Camden, N. J.
A Service of Radio Corporation of America

STOP NOISE PICK-UP Use a SHURE "UNIPLEX"

What a difference in 'phone communication when you use a Shure Uniplex Cardioid Crystal Microphone! This true uni-directional microphone is sensitive at the front, but dead at the rear. It cuts down the pick-up of room noise, eliminates echoes, cleans up voice transmission, assures clearer, more intelligible speech. And the "dead spot" at the rear makes break-in 'phone easy. Enjoy these advantages in your 'phone communication, too.

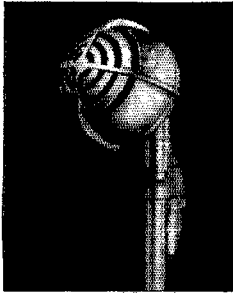

Model 730A "Uniplex" Crystal Microphone, complete with 25 ft. Super-Shielded cable with plug attached.
List Price \$32.50

Ask Your Jobber or Write Now for
Free Catalog 152Q

SHURE BROTHERS
Microphone Headquarters

225 WEST HURON STREET • CHICAGO • U.S.A.
TELEPHONE DELAWARE 8383 • CABLE: SHUREMICRO

of the tube. Disadvantages exist, largely in the matter of non-uniformity of frequency response, unless the transformer is of good quality and the step-up not more than 1:3. Even then, a more or less pronounced accentuation of some portion of the audio spectrum will usually appear. High primary inductance, however, extends the low-frequency response well into the regions obtained with properly-designed resistance coupling. Tubes with moderate internal plate resistances under operating conditions are preferred, since accentuation of medium high frequencies amounting almost to distortion occurs with transformer coupling and low values of plate resistance. But, unfortunately, moderate plate resistances are associated with moderately high μ tubes, hence the tube chosen must be a compromise in any event. High- μ tubes should never be used with transformer coupling. A resistance of 0.1 to 0.25 megohm across the secondary decreases the amplification but affords a more uniform frequency response. Use of this expedient is more or less a tacit admission of a poor transformer.

Transformer coupling in early stages often results in hum being picked up from nearby transformers or chokes, unless inverse feed-back or the expensive shielded hum-bucking type of transformer is used. Since modern tubes have a great deal of gain anyway, use of transformers for their mere voltage gain is scarcely necessary now except in special applications.

Regeneration

One of the most annoying "bugs" of high-gain amplifiers is unwanted regeneration, caused by feed-back of a signal from the high-level output to the low-level input of the first or second tube. If the voltage applied to the input grid by the feed-back is of the order of the voltage required to excite the tube, the amplifier will be regenerative. The gain in amplification may be considerable, which might at first be thought advantageous. Unfortunately the regeneration is not uniform over the desired portion of the audio spectrum and, if too marked, will cause distortion. If the regeneration reaches too high a value, the amplifier will oscillate, resulting in the familiar howls and squeals.

Occasionally an exceptionally high incoming signal voltage, or a current surge in some stage, will feed back a sudden high amplitude signal to the input. Grids all along the line then may be driven off the linear portion of their characteristics, and even positive, and plate currents will surge upward. The final amplified signal again is fed back to the input, and so on, and the amplifier finally becomes uncontrollable. A "putt-putt" sound, considerably like the sound of a single-cylinder motor boat, may emerge from the output; hence the term "motor boating." The cure for unwanted regeneration and for motor boating is normally as complete electrical isolation of the plate supply of the last stage from that of the earlier stages as possible. If a common plate supply is used, its impedance common to all

(Continued on next left-hand page)

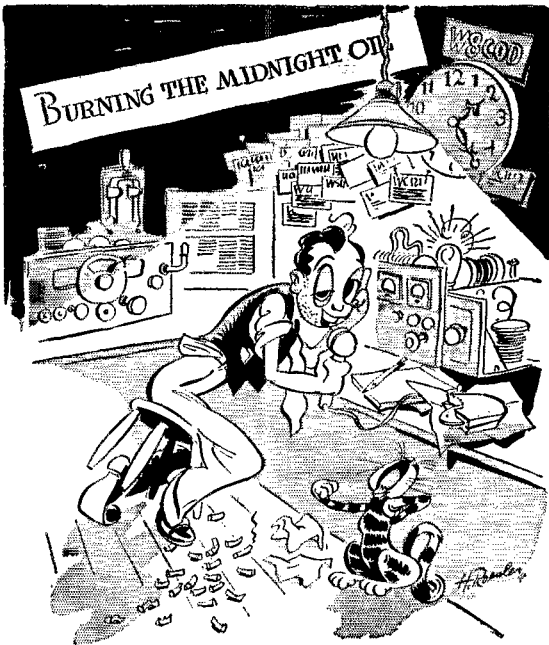

VOLUME CONTROLS — FIXED
RESISTORS — CERAMIC CAPACITORS
WAVE BAND SWITCHES

CENTRALAB

Stays Awake



The C. Q.'s have died down . . . too tired to Q.S.L. . . . but Old Man Centralab never bats an eye. Day in and day out this old owl is "wising up" to new developments in the business. In ham shacks . . . on service benches . . . and in the laboratories . . . the word "CENTRALAB" continues to stand for dependability . . . quality . . . and performance. Day or night . . . play safe with Centralab!

Centralab

Div. of Globe Union, Inc.

Milwaukee, Wisconsin

FREQUENCY MODULATION Simplified

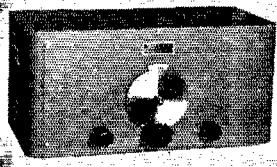

TYPE FM-1 TUNER

Wired, tested, complete
with tubes \$46.50

Just connect the CML Type FM-1 Tuner to the phono input terminals of any high quality audio system. The CML FM-1 Tuner can also be used with By. Goodman's Converter for Amateur 112 Mc. work.

IF YOUR DEALER
CANNOT SUPPLY
YOU, WRITE US.
GET OUR BULLETIN.

COMMUNICATION
MEASUREMENTS LABORATORY

136 LIBERTY STREET

NEW YORK CITY

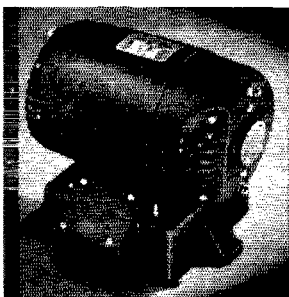

Write Today for Data

EICOR INC.

EICOR ROTARY CONVERTERS

Change DC to AC for radio transmitters and receivers, for amplifiers, projectors, phonographs, etc. Available for operation on any DC voltage. Standard AC output. With or without filter. Highest efficiency, quiet operation, long life.

513 SOUTH LAFLIN ST.
CHICAGO, U. S. A.

A GOOD NAME GOES A LONG WAY

The good name of Ken-Rad Radio Tubes is due to the high standards of their manufacture.



Ken-Rad Radio Tubes

KEN-RAD TUBE & LAMP CORPORATION - OWENSBORO, KY.
Manufacturers of all types of radio tubes and Ken-Rad Electric Lamp Bulbs

THE A.R.R.L. EMBLEM.

Insignia of the Radio Amateur



IN the January, 1920, issue of *QST* there appeared an editorial requesting suggestions for the design of an A.R.R.L. emblem — a device whereby every amateur could know his brother amateur when they met, an insignia he could wear proudly wherever he went. There was need for such a device. The post-war boom of amateur radio brought thousands of new amateurs on the air, many of whom were neighbors but did not know each other. In the July, 1920, issue the design was announced — the familiar diamond that greets you at the top of this page — adopted by the Board of Directors at its annual meeting. It met with universal acceptance and use. For years it has been the unchallenged emblem of amateur radio, found wherever amateurs gathered, a symbol of the traditional greatness of that thing which we call Amateur Spirit — treasured, revered, idealized.

Do You Wear the A.R.R.L. PIN?

THE LEAGUE EMBLEM, in heavy rolled-gold and black enamel, is available in either pin or button type.

In addition, there are three special colors for Communications Department appointees.

- Red background for the *SCM*
- Blue background for the *ORS*
- Green background for the *RM* and *P.M.*

(Red and green available in pin type only. Blue may be had in either pin or button style.)

THE EMBLEM CUT: A mounted printing electrotype, $\frac{5}{8}$ " high, for use by members on amateur printed matter, letterheads, cards, etc.

ALL EMBLEMS PRICED THE SAME

Fifty Cents Postpaid

(No Stamps, Please)

**AMERICAN
RADIO RELAY LEAGUE**

West Hartford, Connecticut

of the plates provides the means for feed-back, Fig. 2-A. The final tube develops an alternating audio voltage e_2 to B- or to ground, actually across the combined load resistor R_2 and the impedance of the power supply, Z . Even with large filter condensers, the power-supply impedance is usually quite appreciable, and a portion of the voltage, e_2 , appears across the plate supply of VT1, Fig. 2-A, and is then transferred in the usual manner through C to the grid of the second tube as part of the signal e_1 . Since the impedance of the power supply cannot be made low enough when the final amplified signal is large and the frequency of oscillation low, resort is made to another expedient to eliminate the feed-back. A second resistor of 25,000 to 100,000 ohms, R_t , is placed between the plate resistor, R_1 , of each of the earlier stages and the plate supply, respectively, and each junction is by-passed to B- or to the cathode through an 8 to 10 μ d. electrolytic condenser C_t , Fig. 2-B. The greater portion of the signal voltage output of each stage is now developed between the respective plates and cathodes or B-, across their coupling resistances or impedances. Thus the unwanted signal voltage e_2 appearing across the plate supply and applied to the grids is so small that it is negligible compared to the desired signal voltages. Any single surge which might start motor boating will first be subjected to a voltage drop in R_t and then its energy expended, in a manner of speaking, in increasing the charge on C_t . If this additional charge can be dissipated through the power supply load before another surge occurs, the effects of the disturbance will not be noticeable.

The condenser-resistor combination on each stage is known as a filter circuit. The values used must be high enough to accomplish the purpose, but the filter resistances at least should not be too great because of the reduction of the d.c. voltages applied to the plates. Decreasing the capacity of C assists the filtering action somewhat in stubborn cases of motor boating.

Miscellaneous Suggestions

Shielding of at least the first two stages of a speech amplifier is quite essential if the amplifier is to be used within the field of even a low-power transmitter. Usually the problem can be solved once and for all by completely enclosing these stages in a grounded metal compartment and providing adequate r.f. filtering of all incoming leads. A shielded r.f. choke should be located at or very close to the grid of the first tube in series with the "hot" microphone lead, and the grid by-passed to ground through a shielded mica condenser of 0.00005 to 0.0001- μ d. capacity. The incoming microphone lead should be well shielded and the shielding connected firmly to ground through the microphone jack. The incoming B+ may also require an r.f. choke and a mica by-pass condenser. Because of their construction, electrolytic condensers cannot usually be depended upon to furnish low-impedance paths for r.f. Normally all audio leads, coupling condensers

(Continued on next left-hand page)

2 POINTS

to REMEMBER WHEN YOU BUY TUBES

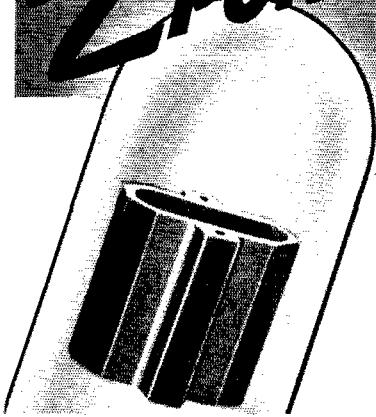

① Graphite (processed carbon) has higher thermal conductivity than any other available anode material. This means that tubes with SPEER Graphite Anodes radiate heat faster, therefore prevent hot spots, warping and fusing of anodes. In turn this permits use of smaller elements in the tubes, reducing interelectrode capacities, promoting successful operation at higher frequencies.

② SPEER Graphite Anodes will not even soften, warp or distort at temperatures that melt metal anodes. This enables tube manufacturers to degas tubes with SPEER Graphite Anodes at higher temperatures than when metal anodes are used. The result is greater assurance of a gas free tube. This result is further insured by the fact that graphite absorbs gases that may be given off by other tube elements.

For tubes that "can take it," live long and preserve their original characteristics, buy the products of manufacturers who give you SPEER Graphite Anodes in their tubes.



SPEER CARBON COMPANY

ST. MARYS, PA. CHICAGO CLEVELAND DETROIT MILWAUKEE NEW YORK PITTSBURGH

Ⓢ 212

RADIO

ENGINEERING, broadcasting, aviation and police radio, servicing, marine radio telegraphy and telephony, Morse telegraphy and railway accounting taught thoroughly. 48 weeks' engineering course, equivalent to three years of college radio work. School established 1874. All expenses low. Catalog free.

DODGE'S INSTITUTE, Day Street, Valparaiso, Indiana

ONAN ELECTRIC PLANTS COMPLETE—READY TO OPERATE

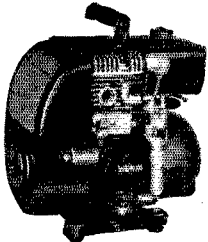

ONAN A.C. ELECTRIC PLANTS are powering AMATEURS' TRANSMITTERS and RECEIVERS all over the world. Used as EMERGENCY power supply when main lines fail.

ACCURATE VOLTAGE CONTROL, NO INTERFERENCE, PORTABLE, RUGGED, DEPENDABLE — thousands in operation.

OVER 40 STOCK MODELS
350 to 10,000 WATTS

Write for Complete Information

D. W. ONAN & SONS

346 ROYALSTON AVENUE MINNEAPOLIS, MINN.

FASTEST WAY TO LEARN CODE

Easy, Fascinating—LEARN BY EAR to be a GOOD OP.

The New All Electric Master Teleplex Code Teaching Machine is exactly what thousands are looking for. No experience needed. Excellent for beginners — steps up WPM for ALL Ops. There is no guesswork with Master Teleplex, because it records your sending in visible dots and dashes. You SEE and HEAR exactly how you are making your signals. You learn code the way you'll be using it — by SOUND. *That's why schools teaching code use TELEPLEX.* Complete course included at no extra charge. Used by many schools and several governments for teaching code. Low cost, easy terms. MONEY BACK GUARANTEE. Send now for booklet Q-4, no obligation. Post card will do.

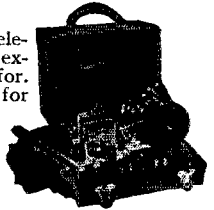

The "Ham" Special TELEPLEX CO. Standard Teleplex — a highly efficient code teacher using heavy specially prepared waxed paper tape, having two rows of perforations. Write for Free folder QT-4 67-69 PARK PLACE NEW YORK, N. Y.

In Canada write CANADIAN ELECTRONIC INSTITUTE, TORONTO, ONT.

GENERAL COMMUNICATIONS CRYSTALS HOLDERS AND OVENS

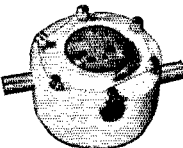
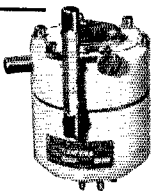

Precision Made by **Biley**

WRITE FOR CATALOG G-11

BILEY ELECTRIC CO., ERIE, PA.



For the Man
Who Wants the
Most for His Cash

TURNER 22X Crystal

Complete with Diagrams, 7 Ft. Cable sety, Chamoisette Mike Pouchy, 90° Tilting Head.

\$16.50 List

Handsome, efficient, rugged and dependable. No blast from close speaking. Smooth for voice. Change cable without opening mike. Level—52FB. Range 30-7000 cycles. Full satin chrome finish; advanced engineering style. Adds class to your rig, and sounds grand over the air.

Switch permits finger-tip "off and on" control, regardless of distance from amplifier. Shorts line quietly. Permits use of mike as "push-to-talk" unit.

Write for Free Mike Catalog

THE TURNER CO. 904 17th St. N. E.
Cedar Rapids, Iowa
Licensed Under Patents of The Brush Development Co.

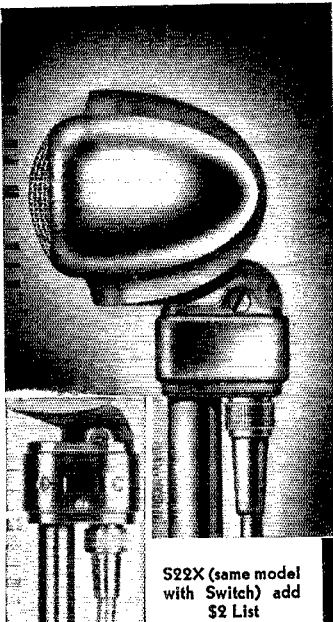

S22X (same model with Switch) add \$2 List

AMATEUR RADIO LICENSES

Day and Evening Classes in Code and Theory
HOME STUDY COURSES

Reasonable, Efficient and Thorough, Hundreds of
Licensed Students Now on the Air

American Radio Institute, 1123 Broadway, New York, N. Y.

See the **NEW VIBROPLEX**
AT YOUR "CHAMPION"
DEALER'S

only **\$9.95**

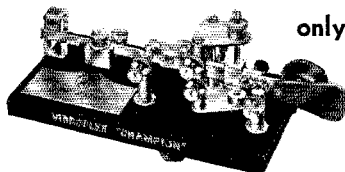

Standard size black base. Chromium finished top parts. Equipped with 3/16" contacts. Furnished without circuit closer, cord and wedge.

Left-hand machines \$1 extra.

Easy to Learn... Easy to Use

Like all true champions, this new genuine Vibroplex "Champion" defies competition. Amazingly easy to learn, professionally fast and easy to operate and made to last for years. Imagine a genuine full-sized Vibroplex key with up-to-date exclusive Vibroplex features for only \$9.95. If you can use the Standard key — you can send better, faster and with less effort with the "Champion" Vibroplex. Simply press lever — Vibroplex does the rest. Ideal for "Ham" or professional. See the "Champion" at your dealer's today. If he cannot supply you, write or order direct from us. Remit by money order or registered mail. Write to-day for descriptive literature of other Vibroplex models including the sensational 1940 De Luxe models.



The **BUG** trade mark identifies the Genuine Vibroplex

THE VIBROPLEX CO., Inc.

832 Broadway

New York, N. Y.

118

and the tubes should be shielded as well as enclosed in the compartment. A little extra thought and care here will pay dividends in trouble-free operation later on.

The speech amplifier is easily disabled during stand-by periods merely by shorting, with switch or relay, the grids of the driver stage if they be of the low impedance type as is usually the case. Opening the B- or B- to any of the stages usually introduces considerable current surge and, in sensitive amplifiers, may cause motor boating in spite of filters.

So many excellent tried and proved circuits are available, utilizing the principles suggested above, that it is unnecessary to continue further. In general, the amateur who is approaching the problems of 'phone operation for the first time will be wiser to select a simple straightforward circuit with inexpensive tubes and a minimum of tricks, and study it carefully before starting to build, until he is familiar with the function of every part and its value. Inclusion of a good method of automatic gain control^{1,2} should be given consideration, to minimize the possibility of interference caused by overmodulation.

¹ MacFarland, "Peak Limiting Amplifier for Amateur Use," *QST*, April, 1939.

² Lamb, W. C., "Volume Compression Simplified," *QST* May, 1939.

Correspondence Department

(Continued from page 108)

use of carrier equipment is being extended and enlarged rapidly. In a great many instances carrier current is now being used for relay protection and alarm circuits on low-voltage distribution lines, particularly between substations operating on 11- and 16-kv. loop systems. Therefore, it is possible that amateurs attempting to place carrier current equipment in operation on power circuits may seriously interfere with the correct operation of the very important relaying and remote alarm systems already in use by local power companies.

It would be advisable, before placing such equipment in service, for the amateur to consult his local power company on the matter in order to make sure he will not cause interference to carrier circuits already in operation. The results of such interference might well be disastrous and a check-up beforehand may save the ham considerable grief.

— K. S. Williams, W8DTY

(Continued on next left-hand page)

Tok Fone

REG. U.S. PAT. OFF.

SOLVES EVERY PROBLEM OF INTERCOMMUNICATION

TOKFONE makes the most complete line of intercommunication systems in the world. A system for every need from simple two-unit installations to 10-unit systems providing 5 simultaneous conversations. Standard systems for the specific needs of police, banks, restaurants, offices, factories, professional and home use. Also custom-designed systems. Let us solve your intercommunication problems for you! Amateurs can make money installing TOKFONE systems. Prices, discounts, literature on request.

REGAL AMPLIFIER Mfg. Corp.
Dept. Q-4—14 W. 17th St., N. Y.

How you can TURN YOUR HOBBY INTO A CAREER

and head for a good paying radio job with a future

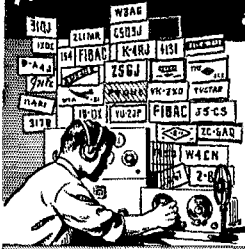

WRITE FOR COPY OF



"A Tested Plan for a Future in Radio"

Read all the facts for yourself. This interesting booklet may hold the answer to your future success. Sent without obligation. Write today!

Amateur Experience Backed by Technical Training Prepares You for a Career in Radio and Television Engineering

Your job can be as pleasant as your hobby. Your experience as a ham can prove a valuable asset in qualifying for a good radio job, if properly supplemented by an adequate course of training. C.R.E.I. courses are practical and thorough — prepared for serious-minded men who realize the value of training and the handicaps without it. C.R.E.I. training develops confidence in your own ability which enables you to go after the better jobs and get them. Many former amateurs credit C.R.E.I. for the training that made it possible for them to step ahead of others into good paying broadcasting, airways and manufacturing jobs. Send for the facts and see what we can do for you!

Your Choice of HOME STUDY or RESIDENCE Training in PRACTICAL RADIO and TELEVISION ENGINEERING

● **THE HOME STUDY WAY**—A spare-time study plan covering every important phase of Radio and Television Engineering. Personalized instruction service and helpful guidance. A modern course for men in the radio industry.

● **THE RESIDENCE COURSE**—A thorough one-year course at the school in Washington, D. C. Combines theory with practice on modern, working equipment. 95% of graduates during past 3 years stepped into good jobs.

—To help us intelligently answer your inquiry, please state briefly your background, education, present position — and whether you are interested in Home Study or Residence training.

DEPT. Q-4 3224 SIXTEENTH STREET, N. W. WASHINGTON, D. C.

CAPITOL RADIO ENGINEERING INSTITUTE

QUALITY ABOVE ALL

SOLAR

CAPACITORS

Write for Catalog
SOLAR MFG. CORP.
BAYONNE, N. J.

PRECISION CRYSTALS

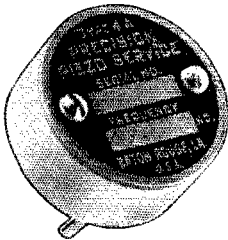

Highest quality crystals carefully prepared for dependable performance.

Low frequency drift Type 4-A unit plugs into tube socket. 40, 80 or 160 meter bands, within 5 kc. of your specified frequency — \$4.00. Calibration 0.03%.

'X' cut in Type 4 holder — \$3.50.

Crystals for commercial requirements quoted on at your request. Now in our Tenth year of business.

PRECISION PIEZO SERVICE

427 Asia Street Baton Rouge, La.

SICKLES COILS

ALL TYPES OF RF AND IF WINDINGS

Manufactured by

F. W. SICKLES COMPANY

300 Main Street Springfield, Mass.

ABBOTT • DK2 •

2½ METER TRANSCIVER

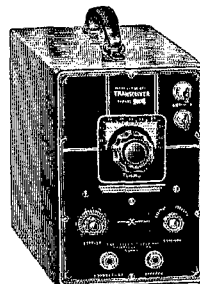

Use it for simple, convenient portable operation
List Price \$27.50

Less Tubes and Batteries
40% Discount to Amateurs

GENERAL: The DK2 is a completely self-contained 112 mc radiophone transmitter and receiver, for use in your car, plane, boat, or while being carried, for portable work. It is very simple to operate. The working range is between 2 to 30 miles depending on the location. Astonishing results have been obtained.

SPECIFICATIONS

CASE: Size 11½" long x 9½" high x 6½" wide, grey wrinkle finish metal, heavy leather handle. All batteries are self-contained in case. Removable side panel for easy access to the batteries and tubes.

FREQUENCY: Will cover 112 mc to 118 mc (amateur 2.5 meter band).

BATTERY REQUIREMENTS: Three 45 volt B batteries like Burgess 530B, and four No. 6 dry cells, or two Burgess 2F2H batteries.

TUBES USED: One type 6J5GT_x, one type 6G6G.

SHIPPING WEIGHT: 12 pounds.

Order from your nearest distributor — if not yet stocked we will temporarily fill orders direct

BULLETIN ON REQUEST

ABBOTT INSTRUMENT, INC.

51 Vesey Street

New York City

HARRISON

"Tnx for the
vy FB Service"

That's what more and more of the boys are writing me — every day! They like the exactness with which their wishes are carried out. They like the completeness of stock, the unusual promptness of delivery, the friendly helpfulness. In short — they like Harrison Service!

I know you'll like my service, too, and I want you to depend upon what I sincerely believe is the most complete Amateur Equipment stock in the country, for everything you need.

As an extra inducement to start you off in this right direction I offer you a

SURPRISE GIFT!

To get yours, simply mail me an order for \$5.00 or more of standard Amateur Equipment (my "Specials" don't count). Mark your order "Surprise Gift" and send it to me before the end of April.

You'll really be surprised — and it won't cost you a penny more for my better service because I guarantee my prices to be the lowest!

Yours for SERVICE,

Bill Harrison, W2AVA

New! Antenna Relay

Heavy, quarter-inch contacts. Real Lucite insulation. Double pole, double throw. Coil for 6, 12, or 125 volts, DC or AC. (Specify when ordering.) A well made R.F. relay at an exceptionally low price. **\$3.18**

"HARRISON HAS IT!" — The new Kenyon T-474 transformer for the improved Cathode Modulation. Will handle 120 watts of audio. Universal windings. Net. **\$7.20**

RCA AR-77. Come in and hear this new receiver. **\$139.50**

TAYLOR TW-75 — \$8.00. Taylor Manual — free!

New RTL 2½ meter rig. Send for literature.

HAMMARLUND HQ-120X. An FB receiver for only. **\$138.00**

(The new Series 200 SUPER PRO's certainly are HOT!)

HALLCRAFTERS Super Defiant SX-25. **\$99.50**, and worth it!

TIME PAYMENTS?

Certainly! I've been selling Receivers, kits, parts, etc. on the Harrison Easy Payment Plan for years!

10% down brings you anything. True 6% on balance finance cost. Lowest prices, easiest terms, highest trade-in allowances — and no red tape.

Send me your order with down payment (or deposit)
and I'll do the rest!

If you usually purchase by mail — and if you live within 150 miles of New York — you'll be mighty interested in the good news on page 164 of my new **AMATEUR BUYING GUIDE**.

SEND FOR IT — TODAY!

No matter where you live — you'll find it worth your while to buy your Receiver or Transmitter from me! Write for my listing of new and reconditioned equipment. No obligation.

12 WEST BROADWAY
NEW YORK CITY

HARRISON

RADIO COMPANY

MORE "S"-SCALE COMMENT

Culver Military Academy, Culver, Ind.

Editor, QST:

The correspondence in the January and March issues of QST in regard to conventional signal reports has inspired me to contribute my bit. I have worried a good deal about these little numbers and hope that we can arouse enough discussion to make them more honest and useful.

According to the reports of psychologists in the field of educational testing it is useless to have as many as nine units in a scale determined subjectively. If, for example, students are asked to explain briefly the theory of an oscillating vacuum tube, an instructor can probably separate the answers into five groups or grades with a reasonable degree of reliability. Reliability refers to the consistency with which the same answer would get the same grade at different times. (I am assuming that the answer is not expected to include a specific number of facts each affecting the rating.) Any more than five grades in rating one answer leads to the same difficulty we have in really using nine units to report strength and tone. I have often thought of this when trying to give an RST report. The "Q" signals give QSA a rating of 1-5 and the army reports both readability and strength on a basis of 1-5. Let's follow the suggestions of W1LAU, W600U and W1LNN and make "5" the maximum "S" and "T."

I would prefer to keep the "R" scale as is. Perhaps "readable with some difficulty" and "readable with no difficulty" are sufficient for a casual ragchew but it seems to me that scheduled traffic handling requires more. When sending traffic I would like to know whether the other fellow is hearing every dot and dash with no difficulty or is having to work a little hard to get me "solid." In the first case he should give me "R5" and in the second "R4." If he misses occasional letters it would be "R3" and if he misses whole words "R2." Then "R1" would be left for the scheduled contact when you can hear the other fellow enough to know he is there but cannot read him. I think that at present we overwork "R5," using it to include both "4" and "5," and we say "4" when we mean "3." Probably most of our reports should be "R4" which means (A.R.R.L.), "readable with practically no difficulty," and (Army), "good, readable, plain language or code once."

I am afraid that I disagree with W1LAU and the others in the suggestion to make the "S" scale dependent upon the condition of the band. What shall be the report when we work 160 meters at noon and can hear only one station? Surely a report of "fair signal strength" when the band is nearly dead is nothing to be ashamed of. When based on 1-5 rather than 1-9, it should be easy to report signal strength which is what "S" is supposed to stand for. Sometimes I think we take "S" unconsciously as a personal rating of our ability to adjust and operate our transmitter. How many of us have had the experience of being a little generous with the "S" report only to find that the other fellow is running 6 watts to a single receiving tube? He is either unduly elated or loses faith in the rest of your report. A report is worse than useless unless it is given as honestly as possible. Of course it is perfectly legitimate to call "S5" the strongest signal on the band at the time and to base our other ratings on it. But I am afraid that we would run into the trouble mentioned above and that we would have further difficulties when a band is changing rapidly or a lot of stations are just coming on the air as happens about supper time. Furthermore, if I receive the maximum report on the "S" scale I would like to know that I am pounding in, and not have to wonder what the band is like in the other fellow's receiver.

While on the subject, I would like to question the use of "x," meaning "crystal characteristic noticed." At the present time there are not many signals which could not have been emitted by a crystal oscillator. The only difference between a chirpy crystal and many e.c.o.'s is that the crystal begins to chirp on the same frequency each time. Why not a symbol here, perhaps "C," to indicate the presence of a definite chirp? Thus "RST 444" would mean that you had good readability, were moderately strong, had a slight ripple (not unusual), and that you were practically chirpless.

Whatever reporting scale is used, the ratings must have specific meanings understood by both sender and receiver. There will always be borderline cases but their number is directly proportional to the number of border-lines. In emergency operation it may be important that we inform another station briefly and intelligently of receiving conditions. "R" and "S" reports plus QRM and QRN can make

(Continued on next left-hand page)

Where to buy it

A directory of suppliers who carry in stock the products of these dependable manufacturers.



ALBANY, N. Y. Uncle Dave's Radio Shack 356 Broadway
ATLANTA, GEORGIA 265 Peachtree Street
 Radio Wire Television Inc.
BOSTON, MASS. Radio Shack 167 Washington Street
BOSTON, MASS. 110 Federal Street
 Radio Wire Television Inc.
BRONX, N. Y. 542 East Fordham Rd.
 Radio Wire Television Inc.
BUTLER, MISSOURI 211-215 N. Main Street
 Henry Radio Shop
CHICAGO, ILL. 833 W. Jackson Blvd.
 Allied Radio Corp.
CHICAGO, ILL. 901-911 W. Jackson Blvd.
 Radio Wire Television Inc.
CINCINNATI, OHIO 1103 Vine Street
 United Radio, Inc.
DETROIT, MICH. 325 E. Jefferson Ave.
 Radio Specialties Co.
DETROIT, MICHIGAN 11800 Woodward Ave.
 Radio Specialties Co.
HARTFORD, CONNECTICUT 227 Asylum Street
 Radio Inspection Service Company
HOUSTON, TEXAS 4021 Huey Street
 R. C. & L. F. Hall
INDIANAPOLIS, INDIANA 34 West Ohio Street
 Van Sickle Radio Supply Co.
JAMAICA, L. I. 90-08 166th Street
 Radio Wire Television Inc.
KANSAS CITY, MO. 1012 McGee Street
 Burstein-Applebee Company
NEW YORK, N. Y. Harrison Radio Co. 12 West Broadway
NEW YORK, N. Y. 100 Sixth Ave.
 Radio Wire Television Inc.
NEWARK, N. J. 24 Central Ave.
 Radio Wire Television Inc.
READING, PENN. 404 Walnut St.
 George D. Barbey Company
SPRINGFIELD, MASS. T. F. Cushing 349 Worthington St.
WASHINGTON, D. C. 938 F Street, N. W.
 Sun Radio & Service Supply Co.

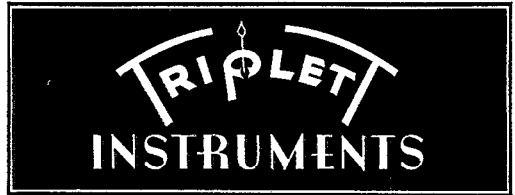

ALBANY, N. Y. Uncle Dave's Radio Shack 356 Broadway
ATLANTA, GEORGIA 265 Peachtree Street
 Radio Wire Television Inc.
BOSTON, MASS. Radio Shack 167 Washington Street
BOSTON, MASS. 110 Federal Street
 Radio Wire Television Inc.
BRONX, N. Y. 542 East Fordham Rd.
 Radio Wire Television Inc.
BUTLER, MISSOURI 211-215 N. Main Street
 Henry Radio Shop
CHICAGO, ILLINOIS 833 W. Jackson Blvd.
 Allied Radio Corp.
CHICAGO, ILL. 901-911 W. Jackson Blvd.
 Radio Wire Television Inc.
CINCINNATI, OHIO 1103 Vine Street
 United Radio, Inc.
JAMAICA, L. I. 90-08 166th Street
 Radio Wire Television Inc.
LITTLE ROCK, ARKANSAS 409 W. 3rd St.
 Beam Radio Company
MINNEAPOLIS, MINNESOTA 1124-26 Harmon Place
 Lew Bonn Company
MUSKOGEE, OKLAHOMA 204 No. Twelfth Street
 Home Radio Mart
NEW YORK, N. Y. 100 Sixth Avenue
 Radio Wire Television Inc.
NEWARK, N. J. 24 Central Ave.
 Radio Wire Television Inc.
READING, PENN. George D. Barbey Co. 404 Walnut Street
WASHINGTON, D. C. 938 F Street, N. W.
 Sun Radio & Service Supply Co.

Listings on this page do not necessarily imply endorsement by QST of the dealers or of other equipment sold by them.

Amateurs! Look!

An Accurate Measuring Instrument Designed ESPECIALLY FOR YOU



Model 334

22 Ranges

Commercial Accuracy
3000 Volts.
A.C.-D.C. 1 Meg-ohm — 300 M.A.

See Your Jobber

ONLY
\$13⁹⁵
COMPLETE
With
Battery

3" Meter

10-day Free Trial
Money Back Guar-
antee. Write for
Free 1940 "Ham"
Instrument
Catalog

TRIUMPH MFG. CO.
4017-19 W. LAKE ST. CHICAGO, ILL.

RADIO TECHNOLOGY



RCA Institutes offer an intensive course of high standard embracing all phases of Radio and Television. Practical training with modern equipment at New York and Chicago schools. Also specialized courses and Home Study Courses under "No obligation" plan.

Illustrated Catalog on request

RCA INSTITUTES, INC. Dept. ST-40
A Radio Corporation of America Service

75 Varick St., New York 1154 Merchandise Mart, Chicago

EASY TO LEARN CODE

It is easy and pleasant to learn the modern way — with an **Instructograph Code Teacher**. Ideal for the beginner or advanced student. ■ Many tapes available ranging from alphabet for beginners to typical messages on all subjects. Speed range 5 to 40 WPM. ■ Always ready, no QRM, beats having someone send to you.

FOR SALE OR RENT

STANDARD with 10 tapes and book of instructions, A.C. motor \$24.50

With spring-wound motor \$18.50

JUNIOR with 5 tapes and book of instructions (not rented) \$12.00

RENTAL Standard with 10 tapes and book of instructions \$3.00 first month, \$2.25 each additional month. References or \$10 deposit required. All rental payments may be applied on the purchase price should you decide to buy the equipment.

Write for details today



INSTRUCTOGRAPH COMPANY

Dept. Q, 912 Lakeside Place, Chicago, Illinois

Representative for Canada:

Radio College of Canada, 54 Bloor St. West, Toronto

W2JST

YOUR CALL LETTERS on gleaming black PYRALIN. White inlaid letters 1 3/8" high on 2 1/4" x 6" plate. 75 cents each, 2 for \$1.25 postpaid. R. A. WATERS, W2JST, 240 Valley Road, Montclair, N. J. Also special sizes and wordings. Send layout for price.

a pretty complete picture. It might even be worth while to adopt I-5 scales for QRM and QRN, similar to the Army procedure. The numbers would have the same meanings as for the "S" scale so there would be nothing new to learn except to recognize such a report when given.

— Harold M. Baker, W9MDJ/W9EZ

THE OTHER SIDE

10304 Glory Ave., Tujunga, Calif.

Editor, QST:

There has been a fresh deluge in the Correspondence section of QST recently concerning the encouragement of rag-chews, long-winded QSO's and the like, and a goodly share of it has been flavored with tendencies to belittle or criticize the fellow who desires only a short QSO.

Let's take a look at the viewpoint of this fellow and his kind, to whom one writer referred as the "73, cul" boys. In the first place, this fellow may be pressed for time. He may be just home for lunch, and a short five or ten minutes at the rig. He has a perfectly ethical and moral right to get on the air for a brief greeting, an exchange of reports, a "73 cul," and back to the office again. What's wrong with that? Absolutely nothing, of course, but a certain group of hams immediately look down their noses at him because he wouldn't stick around for an hour and a half and discuss the weather, his habits of living, and the facts of life in general.

In the second place, those of the "long-rag-chew-or-nothing" school should remember that this fine hobby of ours embraces a wide variety of special interests, all worthy, including DX, traffic-handling, experimentation and many others, in some of which a long-winded, endless rag-chew is not always in order. To illustrate, suppose Johnny Q. Ham is making an intensive study of directive antenna arrays. He has just put up a nice, fixed beam in preparation for some contest or other, has maybe an hour's time to spend on the air and is anxious to know whether or not his new beam is really "beaming." This calls for a number of contacts in different directions and localities so that a study can be made of reports received. But no, if he is to be a good fellow, he will devote at least an hour to the first contact he makes and have fun talking about last winter's blizzard and what he likes to eat for breakfast, and to — with that data he wanted to gather on this new antenna array. Phooey!

This may sound like I am dead against rag-chewing, but that is definitely not the case. I like rag-chewing. I love it — particularly when there is someone interesting on the other end of the line. But I do not take the stand, as many seem to do, that anyone who refuses to indulge in a long rag-chew is a plain vanilla lug. If you hook a guy who doesn't go in for two-hour QSO's, let him go, and throw out your bait again. There are thousands of potential rag-chews on the bands just around the corner — any corner. Go ahead and enjoy them, and try not to condemn the other fellow if he's in a hurry. Who knows? He may be about to catch a train.

— Roy G. Walters, Jr., W6PNO

A.E.C. Well Organized in Los Angeles

The A.R.R.L. Emergency Corps in the Los Angeles Section is making rapid strides toward complete organization under the leadership of S.C.M. Click, W6MQM, and his Emergency Coördinators. An A.E.C. headquarters station has recently been issued the call W6SKO. All work in the Corps centers around this station, which has been equipped through the cooperation of and efforts of Los Angeles A.E.C. members. An important feature of the Los Angeles organization is a "Flying Squadron," which is composed of all available mobile transmitting and receiving units. An arrangement has been made with Standard Stations, Inc., for the loan of batteries to this Squadron during periods of disaster. Each member will be furnished with a letter of introduction which will provide the necessary authorization for him to secure the batteries. An A.E.C. monthly bulletin is being started by S.C.M. Click to further the excellent work that is already under way.

—

Fun with kite antennas! Doc Meeker, WSADV, and Ed Pettingill, W8PQX, got to discussing them recently, assembled a kite from sticks and paper at 9 p.m. and got the six-footer in the air at South Mountain (Elmira, N. Y.) around 11 p.m. WSRTW, Johnnie Mulligan, produced a portable 3.5-1.8-Mc. station and some good QSO's on those bands followed. Try it, gang.

HAM-ADS

(1) Advertising shall pertain to radio and shall be of nature of interest to radio amateurs or experimenters in their pursuit of the art.

(2) No display of any character will be accepted, nor can any special typographical arrangement, such as all or part capital letters be used which would tend to make one advertisement stand out from the others.

(3) The Ham-Ad rate is 15¢ per word, except as noted in paragraph (6) below.

(4) Remittance in full must accompany copy. No cash or contract discount or agency commission will be allowed.

(5) Closing date for Ham-Ads is the 25th of the second month preceding publication date.

(6) A special rate of 7¢ per word will apply to advertising which, in our judgment, is obviously non-commercial in nature and is placed and signed by a member of the American Radio Relay League. Thus, advertising of bona fide surplus equipment owned, used and for sale by an individual or apparatus offered for exchange or advertising inquiring for special equipment, if by a member of the American Radio Relay League takes the 7¢ rate. An attempt to deal in apparatus in quantity for profit, even if by an individual, is commercial and all advertising by him takes the 15¢ rate. Provisions of paragraphs (1), (2), (4) and (5) apply to all advertising in this column regardless of which rate may apply.

Having made no investigation of the advertisers in the classified columns, the publishers of *QST* are unable to vouch for their integrity or for the grade or character of the products advertised

QUARTZ—direct importers from Brazil of best quality pure quartz suitable for making piezo-electric crystals.

Diamond Drill Carbon Co., 719 World Bldg., New York City.

QSL'S—samples. Brownie, W3CJL, 523 No. Tenth St., Allentown, Pa.

CALLBOOKS—Spring edition now on sale containing complete up-to-date list of radio hams throughout entire world. Also world prefix map, and new time conversion chart. Single copies \$1.25. Canada and foreign \$1.35. Radio Amateur Call Book, 610 S. Dearborn, Chicago.

QSL'S—By W8NOS—13 Swan St., Buffalo, N. Y.

CRYSTALS, mounted, 80-160, \$1.25, V-cut 40, \$2.25. R9 Crystals, 338 Murray Ave., Arnold, Pa.

QSL'S, all colors, cartoons, snappy service. Write for free samples today. WIBEF, 78 Warrenton, Springfield, Mass.

TELEPLEXES, Instructographs bought, sold. Ryan's, Hannibal, Mo.

MACAUTO code machines: low monthly rental 50,000 words practice tapes. Write N. C. Ayers, 711 Boylston St., Boston, Mass. GRANite 7189-W.

CRYSTALS in plug-in heat dissipating holders. Guaranteed good oscillators. 160M—80M, \$1.25. (No Y cuts.) 40X, \$1.65. 80M vari-frequency (5 kilocycle variance) complete, \$2.95. State frequency desired. C.O.D.'s accepted. Pacific Crystals, 1042 S. Hicks, Los Angeles.

QSL'S, Maps, Cartoons. Free samples. Theodore Porcher, 7708 Navahoe, Philadelphia, Pa.

USED receivers. Bargains. Cash only. No trades. Price list 3¢. W3DQ, Wilmington, Del.

QSL'S. Free samples. Printer, Corwith, Iowa.

CRYSTALS: famous P.R., mounted in latest Alsimag 35 holders—40, 80 meter PR-X, 160 meter PR-Z, \$3; 40, 80 meter PR-Z (low drift), \$3.50; 20-meter PR-20, \$4.50; unconditionally guaranteed. Immediate shipment. Wholesale Radio Labs., Council Bluffs, Iowa, W9GFQ.

1000 watt G.E. transformers 1100-2200-4400 volts each side c.t. Guaranteed. \$13.50. Dawson, 5740 Woodrow, Detroit, Mich.

QSL'S. Fritz, 455 Mason, Joliet, Ill.

CRYSTALS—police, marine, aircraft, amateur. Catalog on request. C-W Mfg. Co., 1170 Esperanza, Los Angeles.

QSL'S—SWL's. 100, 3 color, 75¢. Lapco, 344 W. 39th, Indianapolis, Ind.

CRYSTALS: police, marine, aircraft, and amateur frequencies. Descriptive catalog, Ham Crystals, 1104 Lincoln Place, Brooklyn, N. Y.

RADIO control for models by RCH—the only complete line, lightweight, inexpensive, guaranteed. Send stamp for circular. Radio Control Headquarters, Granby, Conn.

MEISSNER Signal Shifter with 10—20—40 & 80 coils (cost \$47.45), practically brand new, \$35.—moving.—W2BNX.

SELL: Hammariund 120X, \$90. cash. Stancor 100 MB with tubes, meter, coils 10, 20, 80—\$50. cash. J. W. McDonald, Craig, Colo.

SELL: RME-69 recvr, LS-1 noise silencer and spker, \$100.; factory built xmtr, fone & CW, xtal mike, 10 & 20 coils, D104 xtal mike, cost \$200., cost \$89. Marshall R. Sherrill, W9POP, Arlington Heights, Ill.

QSL'S? QSL's? SWL's? No cheap trash. Samples? W8DED, Holland, Mich. (Request crystal price list, free.)

W3BFH must sell one kilowatt 14 megacycle phone CW transmitter, \$300. f.o.b. Merchantville, N. J. Write Thomas Dix, 2601 Chelsea Terrace, Baltimore, Md., for details.

REMOTE controlled de luxe 1 kw. commercial CW. Portable 100 watt 10 meter fone. Shown by appointment. Fone Columbus 1026. W9NRB.

110 volt, DC 400 watt, gas-driven Delco generator with Briggs-Stratton 1 or 2 H.P. motors. With automatic starter, \$60. Manual, \$50. Brand new, factory guaranteed. W8RSK.

SELL—complete files QST 1928 to 1932. H. S. Belove, 2223 E. 23, Kansas City, Mo.

RME-69—complete with speaker. Excellent condition—\$85. cash. W8TXE, Route 1, Box 227, Belleville, Mich.

QSL'S—SWL's. Colorful, economical. W9QKS Print (Meade), 819 Wyandotte, Kansas City, Mo.

WANTED: National HRO broadcast coils—reasonable. W6QNW, Tarzana, Calif.

CRYSTALS: Zero cut. New low drift mounted units. Exact freq. 160—80—40 meters, \$2.50 postpaid. Rough blanks, 50¢. Fisher Lab., 4522 Norwood St., San Diego, Calif.

SELL—trade: meters, soldering irons. Robert Owens, 5427 Kenmore, Chicago.

QSL'S. Finest—lowest prices. Samples. Maleco, 1805 St. Johns Place, Brooklyn, N. Y.

ALERT amateurs: Your equipment merits our fine economical racks. Investigate. F. B. Meinikheim, 614 Main, Toms River, N. J.

SWAP: Kodak Senior 620 F4.5 new; want SW revr. Parre, Municipal Airport, Joliet, Ill.

CONTEST winners K6BNR, W9TB take first using our 3, 4 element rotary beams. DX booster beams, steel rotators, alummoly elements, selsynchronous indicators. Lowest cost, highest performance. Save half at Rotary Array Service, W8ML.

YOUR rig blueprinted, for framing. To five stages, \$1.98. C.O.D.'s accepted. Send rough drawing. W4ATE, Old Hickory, Tenn.

GIL cartoon QSL's. Samples. W1CJD, Gildersleeve, Conn.

BALTIMORE hams: for sale—de luxe 250 watt phone—CW rig; six meters; P.P. 35T's final; TZ-40's modulators. Also have Johnson 100CD110, \$6.; 2 brand new 100TH's, \$10. each; 2 used RCA 814's, \$8. each. Local hams visit any evening—Joseph DiPietro, Jr., 1517 Mt. Royal Ave., Baltimore, Md.

CUSTOM ground 40 M X-cut crystals in ceramic holders, \$2.50, 160—80 M crystal, \$1. Koradio, Mendota, Ill.

TRANSMITTER and receiver headquarters new and used. 70 watt rigs complete, \$35.; modulators complete handle 75 watt final, \$25. All kits wired lowest prices. Everything for ham at own terms. Write to Leo, W9GFQ, for satisfaction guaranteed. Wholesale Radio Labs., Council Bluffs, Iowa.

TRANSMITTER, 150 watts CW—100 watts phone, volume compression, 809's final, self-contained in Parmetal cabinet, 20—40—80 meter coils; also Hallicrafter SX-16 excellent condition. Complete station, \$165. Request booklet for complete description. W9ALL.

QSL'S. Samples. W5FGE, Hattiesburg, Miss.

GUARANTEED reconditioned receivers all types, lowest terms as we finance own paper. Ask for exclusive ham catalog and write Leo, W9GFQ, today for best deal. Council Bluffs, Iowa.

HAVE transmitters, receiver, surplus parts, tubes, meters, Perflex 44 camera, Argus, enlarger, etc., to trade or sell. Want Leica or Contax or similar camera. Pay part cash if necessary. Morgan Gravlee, W4AG, Kennedy, Ala.

BEST offer takes Bruno VR-HP microphone—new. W1HJI

CALLS—2½ inch auto, \$1.50.; desk plaque, 1 inch letters, 75¢—both, \$1.75. Hold fast antenna grip 15¢—pair, 25¢. E. Bailey, West Newton, Pa.

CRYSTALS: T9 crystals are built to take it and deliver the goods in dependable style—nufl sed. Fracture resisting, fully guaranteed: 40, 80, and 160 meter bands, \$1.60 postpaid. T9 ceramic holder, dust proof enclosed type, \$1. C.O.D.'s accepted. Fine commercial frequency crystals to order, send for folder. Sold by: Pemberton Labs., Ft. Wayne, Ind.; O'Laughlin's Radio Supply, Salt Lake City, Utah; Frank Anzalone, 375 W. 46th St., N. Y. C.; Henry Radio Shop, Butler, Mo.; Radio Doc, 721 S. Main, Los Angeles, Calif.; Valley Radio Distributors, Appleton, Wis.; and Eidson's, Temple, Texas.

TUBE bargains — New RCA, etc., 210's, 801's, 841's — \$1. each. 211's, \$3.50 each. New RCA, Arcturus, Raytheon 32's, 33's, 34's, 36's, 37's, 38's, 39-44's, 1A6's, 112A's, 48's, 57's, 58's, 75's, 77's, 78's, 85's; metal or glass 6A7's, 6A8's, 6F6's, 6J7's, 6K7's, 6L7's, 6R7's — all 35¢ each postpaid. Amdico, Clearfield, Pa.

DOUGLAS modulation transformers. Match all tubes in Class B or AB. 50 watts audio, \$4.95 pair; 100 watts audio, \$7.75 pair. Postpaid in U. S. One year guarantee. Write W9IXR, Rice Lake, Wis.

BARGAIN 400 watt and 60 watt transmitters 125 watt phone. Two modulators 150 and 40 watts. Must sell. W5EXC, Blackwell, Okla.

SELLING station. Offer — NC-101X, UTC-VM4, NC-TMA200D, Supreme 535 oscilloscope, Triplett 1200-C. List. W8SBL.

GOVERNMENT contract and standard parts at big bargains. Direction finders, loop, receivers, portable transmitters, etc., etc. Send for list. Amdico, Clearfield, Pa.

BARGAINS: RME-69, grey panel, PB — \$65. QSL 40, coil meter tube all new, \$7.50. New meters Jewell — many others — selling out. R. Ekholm, W1AAX, 125 W. 7th, S. Boston, Mass.

BARGAINS: Again WICPI builds a brand new layout — This means plenty of bargains in good, used parts. Write now for complete list at give-away prices. For example, a new Harvey UHX-25 all-band CW and phone transmitter with power supply, \$80.; also a Meissner Signal Shifter going for \$25. Address 84 Kenyon Ave., Wakefield, R. I.

SPECIAL: New transformers. 3000 vac center-tapped @ 250 mila. \$6. Full line — all types. Precision Transformer Co., Muskegon, Mich.

SELL: kw. CW built for plate modulation, in black crystalline cabinet, 66 1/2" h., 21" w., 17" d. 59, 807, HF100, T200 P.P. new. Complete 10 — 20 meters. Also 30 watt speech, Electro-Voice V2Hi-Z mike, kw. plate transformer. Everything \$150. at W2LXT.

WANTED: 1914 and 1915 editions "A.R.R.L. list of Stations"; "Maps of Member Stations"; and "Story of A.R.R.L." Handbooks: first eight editions. Franklin F. Wingard, Rock Island, Ill.

CUSTOM-built RME-69 with DB20 preselector, OA1 oscilloscope amplifier, LS-1 noise silencer, 3 inch RCA oscilloscope, additional push pull 6L6 audio with variable impedance output for 4 speakers or recording head. All built into beautiful 5 foot enclosed rack, aluminum panels, gray crackle finish. Plenty of room for transmitter to be built in same rack. Scope gives modulated envelope or trapezoid pattern. Cost over \$400. Must sell and will sacrifice for \$250. f.o.b. Redlands, Calif. W6CV.

SELL complete 150 watt phone transmitter. Al Specht, Newton, Mass. W1APF.

TRADE: Posts No. 1075 drawing set, K.E. polyphase slide rule. Want bug, A.C. preselector. Speirn, 13565 Northlawn, Detroit.

SELL RME-69 and DB20 — excellent condition — 105 dollars. Write W8LUQ.

BEST place to buy amateur receivers is W9ARA. You get best price, best trades, best terms (financed by myself), ten day free trial. Prompt shipment from world's largest stock. Shipment from factory if you prefer. Write me about your wishes. I will send full information and help you get the right receiver. W9ARA, Butler, Mo.

RECONDITIONED guaranteed receivers and transmitters. Practically all models cheap. Save as much as half. Ten day free trial. Terms, List free. New SX-23's, \$89. (regular new price is \$115.50.) W9ARA, Butler, Mo.

SACRIFICE — Panel 300 watt output, phone, CW, complete — \$165. Photos. Hallicrafter SX16, \$60. All guaranteed. W3ARA, A. Adamo, 236 Landis Ave., Vineland, N. J.

QST'S wanted prior to 1923. Floyd Norwine, W9EFC.

MUST sell my Meissner Signal Shifter, voltage regulator, coils for 20, 40, 160. \$33. W6PEV.

WANTED: modern high frequency equipment. W9BZC, 716 W. 17th Pl., Chicago, Ill.

PAIR T-200's, age two, \$20. W1LVQ.

LEARN RADIO • TELEVISION

60-page catalog on request. Oldest, largest and best equipped in New England. Write for new catalog.

MASS. RADIO SCHOOL

18 Boylston Street

Boston, Mass.

LOW COST STEEL ANTENNA TOWER

Used and Endorsed by
FEDERAL, STATE, COUNTY, CITY GOV'TS.,
FORESTRY, HIGHWAY PATROLS
and HAMS everywhere!

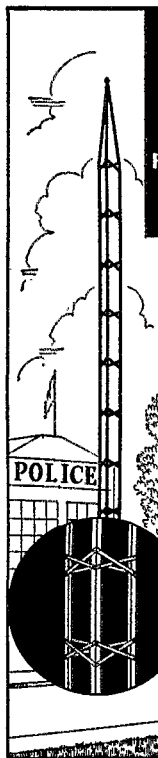

ONLY 60¢ PER FOOT Complete!

This remarkable low price is possible only because we produce many thousands of these towers each year for use with our Wincharger. Price includes necessary guy wires and tower sections of 10 or 20 ft. lengths with 5 footer stub top.

LIGHT, STURDY, RIGID

Thousands in use as vertical radiators and horizontal antenna supports. Scientifically braced. No points of undue strain. Both vertical angles and cross braces now hot dip galvanized. Quickly and easily erected, to heights of from 25 ft. to 200 ft.

READ U. S. FORESTRY LETTER!

"Your tower was installed on Signal Peak, a Lookout Station on the Yakima Indian Reservation, at an elevation of 3,111 ft. above sea level. We have found the Wincharger tower 100% satisfactory and it has stood up under 70 mile winds, snow and ice which are severe at almost a mile up from sea level." Thomas L. Carter, Forest Supervisor, Office of Indian Affairs, U. S. Department of the Interior, Tappanish, Wash.

COMMERCIAL BROADCASTERS:
Write for complete information on new type heavy towers designed for heights up to 300 feet.

WINCHARGER CORPORATION
Sioux City, Iowa

RADIO COURSES

RADIO OPERATING • BROADCASTING • CODE
RADIO SERVICING • TELEVISION
• ELECTRONICS — 1 year day course; 2 years eve.
Day and Evening Classes — *Booklet upon request*

NEW YORK YMCA SCHOOLS
4 West 63rd Street, New York City

??????????

HOW IS YOUR SUPPLY OF

LOG BOOKS? 35 cents each
Three for \$7.00

AMERICAN RADIO RELAY LEAGUE
West Hartford, Connecticut

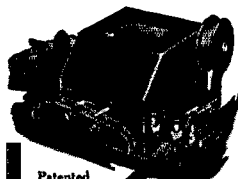

A Perfected AUTOMATIC SENDER

Patented
Postpaid in U.S.A. **\$12.50**

Sends up to 70 words a minute. Motor driven. Built-in tape perforator. Uniform spacing. Excellent practice medium for beginners. Complete with practice tape covering Alphabet, Numerals, Word combinations and ample supply of blank tape. Speed up your receiving. Full operating instructions. If your dealer can't supply, write us.

\$13.50
West of
Denver

FULLY GUARANTEED

GARDINER-LEVERING CO. Haddon Heights
New Jersey, U. S. A.

Your Nearby Dealer Is Your Best Friend

Your nearby dealer is entitled to your patronage. He is equipped with a knowledge and understanding of amateur radio. He is your logical source of advice and counsel on what equipment you should buy. His stock is complete. He can supply your needs without delay. His prices are fair and consistent with the high quality of the goods he carries. He is responsible to you and interested in you.

One of these dealers is probably in your city—Patronize him!

CHICAGO, ILLINOIS

Allied Radio Corporation
833 West Jackson Blvd.

Complete standard lines always in stock—W9IBC, W9DDM, W9ALIK

CHICAGO, ILLINOIS

Chicago Radio Apparatus Company
415 South Dearborn Street (Est. 1921)

W9RA and W9PST — Amateurs since 1909

CHICAGO, ILLINOIS

Radio Wire Television Inc.
901-11 West Jackson Boulevard

"The World's Largest Radio Supply House"

DES MOINES, IOWA

Iowa Radio Corp.
1212 Grand Avenue
Complete amateur stock, W9OCG — W9EMS — W9KAY

DETROIT, MICHIGAN

Radio Specialties Company
325 E. Jefferson Avenue
Ham Supplies — National & Hammarlund Sets and Parts

KANSAS CITY, MISSOURI

Burstein-Applebee Company
1012-14 McGee Street
"Specialists" in supplies for the Amateur and Serviceman

KANSAS CITY, MISSOURI

Radiolab
1515 Grand Avenue
Amateur Headquarters in Kansas City

MILWAUKEE, WISCONSIN

Radio Parts Company, Inc.
538 West State Street
Complete stock Nationally Known products

MINNEAPOLIS, MINNESOTA

Lew Bonn Co.
1124-26 Harmon Place
W9BP — W9TLE — W9ZXV — W9DKL — W9VED

SEATTLE, WASHINGTON

Northern Radio Company
2208 Fourth Avenue
W7AWP, W7MB, W7VP, W7XL, W7XK, and W7CR to serve you

ST. LOUIS, MISSOURI

Van Sickle Radio Company
1113 Pine Street
Owned and operated by W9OWD, W9TCJ, W9KEH

YOU CAN BE SURE
WHEN YOU BUY FROM

QST

ADVERTISERS

“Advertising for *QST* is accepted only from firms who, in the publisher’s opinion, are of established integrity and whose products secure the approval of the technical staff of the American Radio Relay League.”

Quoted from QST’s advertising rate card.

Every conceivable need of a radio amateur can be supplied by the advertisers in QST. And you will know the product has the approval of the League’s technical staff

Index to Advertisers

Abbott Instrument, Inc.	119
Aerovox Corp.	94
American Radio Institute	114
Astatic Microphone Laboratory, Inc.	113
Barker & Williamson	94
Biley Electric Company	77, 111, 117
Browning Laboratories, Inc.	92
Candler System Company	98
Capitol Radio Engineering Institute	119
Cardwell Mfg. Corp., Allen D.	80
Centralab	115
Clarostat Mfg. Company, Inc.	96
Collins Radio Company	Cov. 2
Communication Measurements Laboratory	115
Coto-Coil Company, Inc.	96
Dodge’s Institute	117
Elicor, Inc.	115
Eitel-McCullough, Inc.	85
Electro-Voice Mfg. Company, Inc.	82
Gardiner-Levering Company	124
General Electric Company	5
Hallicrafters, Inc., The	1, 2
Hammarlund Mfg. Company, Inc.	72, 73, 75
Harrison Radio Company	120
Harvey Radio Company	112
Heintz & Kaufman, Ltd.	111
Henry Radio Shop	107
Howard Radio Company	95
Hytronic Laboratories	86
Instructograph Company	122
International Resistance Company	88
Jensen Radio Mfg. Company	109
Ken-Rad Tube & Lamp Corp.	115
Kenyon Transformer Company, Inc.	84
Mallory & Company, Inc., P. R.	70
Massachusetts Radio School	124
Meissner Mfg. Company, Inc.	91
Milten Mfg. Company, Inc., James	92
Mims Radio Company	74
Monitor Piezo Products Company	106
National Company, Inc.	Cov. 3, 69, 78, 79
New York YMCA Schools	124
Newark Electric Company	99
Nilson Radio School	102
Ohmite Mfg. Company	98
Onan & Sons, D. W.	117
Par-Metal Products Corp.	106
Pioneer Gen-E-Motor Corp.	110
Port Arthur College	113
Precision Apparatus Corp.	102
Precision Piezo Service	119
Premax Products	110
RCA Institutes, Inc.	Cov. 4, 71, 93, 122
RCA Mfg. Company, Inc.	114
Radio Mfg. Engineers, Inc.	127
Radio Shack, The	97
Raytheon Production Corp.	89
Regal Amplifier Mfg. Corp.	118
Scientific Radio Service	113
Shuler Supply Company	116
Shure Brothers	114
Sickles Company, F. W.	119
Solar Mfg. Corp.	119
Southwest Radio Supply	108
Speer Carbon Company	117
Sun Radio Company	108
Taylor Tubes, Inc.	81
Teleplex Company	117
Terminal Radio Corp.	116
Thordarson Electric Mfg. Company	87
Triplet Elec. Instrument Company, Inc.	76
Turner Company	118
Triumph Mfg. Company	122
United Electronics Company	83
United Transformer Corp.	128
Vitroplex Company, Inc., The	118
Waters, R. A.	122
Wholesale Radio Laboratories	97
Wincharger Corp.	124
Vaxley	70

The Performance Record of an RME

THE OWNER OF AN RME MAY REST ASSURED THAT HE IS NOT THE OWNER OF A "FORGOTTEN CHILD"

1936

Our extensive permanent filing system for every RME ever built, adequately dispels this idea.

Every detail in a new RME, from circuit continuity to dial lighting, is carefully checked and recorded. Here is a typical example, chosen at random from our files, of serial No. 1308, 69 type receiver.

Accurate records such as these aid us greatly in helping our customers make alterations, modernizations, and repairs to their RME equipment.

Also, this lifetime service offered on each and every RME unit, assures the RME owner of continued high resale value on his RME receiver.

There is a reason for RME's continued favor. May we send you catalog No. 89?



1939

1936 Stock

DATE TEST STARTED: 7/18/36
TIME: 1:45

TEST FINDINGS OF ASSEMBLY WORK AND MATERIAL: Ready for Cabinet

MODEL: RME-69
TYPE: Standard
SERIAL: #1308
DATE COMPLETED: 7/18/36

1939 Repair

DATE TEST STARTED: 12-5-39
TIME: 3:45

TEST FINDINGS OF ASSEMBLY WORK AND MATERIAL: Install LS-1, new brushes & clean-up, pilot bulb, manual gain replaced, Install break in

MODEL: RME-69
TYPE: Standard
SERIAL: #1308
DATE COMPLETED: 12/6/39

SPECIAL FEATURES: LS-1

TIME FOR ROUTINE TEST: 30
TOTAL TIME: 45:30

2 hrs

RME
TIME WILL TELL

RADIO MFG. ENGINEERS

INCORPORATED

111 HARRISON STREET

PEORIA

ILLINOIS

And Now GRID-CATHODE MODULATION

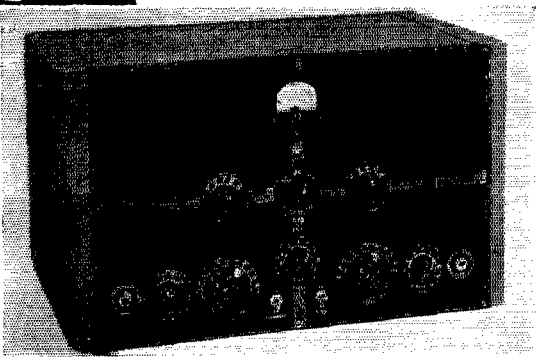

NEW De Luxe GRID-CATHODE TRANSMITTER KITS

SC-101

GCM PHONE — C.W.
TRANSMITTER KIT

The UTC Type SC-101 kit is a complete, crystal controlled, 'phone C.W. unit of modern design. This transmitter is capable of 50* watts 'phone, 100* watts C.W. operation on all bands (10-160 meters). Band changing is effected through standard plug-in coils. Keying is accomplished in the cathode circuit, thus permitting break-in operation. A rugged power supply with a multi-section filter system furnishes power to the RF and audio stages.

The entire transmitter is mounted on a single chassis, and is housed in a modern cabinet provided with a safety interlock switch to prevent injury to operator. The output circuit consists of a link terminated to two Isolantite feed-through insulators at the rear of the chassis.

The Type SC-101 kit includes chassis, cabinet, panel, condensers, coil assemblies, resistors, 3" METER, etc., all completely mounted ready to wire. Crystals and tubes not included. Tubes: 1-807, 1-812, 1-6SJ7, 1-6C5, 3-6F6, 1-5Z3, 2-866. Size: 12" x 12" x 20"; Weight: 80 lbs.

Amateur net price **\$57.00**

SC-100

BAND SWITCHING GCM
PHONE — C.W. TRANSMITTER KIT

The UTC Type SC-100 transmitter kit is a complete 'phone and C.W. transmitter of modern design capable of a carrier output of 50* watts 'phone, 100* watts C.W. Operation on all bands (10-160 meters) is obtained by means of **BAND SWITCHING** coil assemblies (and crystal switch for four [4] crystals). Keying is accomplished in the oscillator cathode circuit, thus permitting break-in operation. A rugged power supply with multi-section filter system furnishes power to the RF and audio amplifiers. The entire transmitter including RF, speech amplifier, Cathode-Modulator, and power supply is mounted on a single chassis.

The output circuit of the SC-100 consists of a link terminated at two Isolantite feed-through insulators at the rear of the chassis for connection to a low impedance feeder system.

The SC-100 kit includes chassis, cabinet, panel, condensers, coil assemblies, resistors, 3" METER, etc. all completely mounted ready to wire. Crystals and tubes not included. Tubes: 1-807, 1-812, 1-6SJ7, 1-6C5, 3-6F6, 1-5Z3, 2-866. Size: 12" x 12" x 20"; Weight: 88 lbs.

Amateur net price **\$96.00**

* ACTUAL CARRIER OUTPUT UTC ratings are conservative and based on antenna output, not the customary class C input. For example, on C.W., the class C input of these units is 160 watts.

First in Cathode Modulation — UTC now presents 5 new Universal Transformers for GRID-CATHODE MODULATION

- Primary designed to match all popular tubes.
- Secondary provides a wide range of impedances for GCM applications (1000 to 10,000 ohms).
- Separate tapped tertiary grid winding to facilitate exact grid matching.

<p>GCM-1 200 or 500 ohm line to match tubes for GCM service. 30 watts audio output Net \$ 4.80</p> <p>GCM-2 15 watts audio output, from all popular tubes to grid and cathode. Net \$ 3.00</p> <p>GCM-3 30 watts audio output, from all popular tubes to grid and cathode. Net \$ 4.50</p>	<p>GCM-4 60 watts audio output, from all popular tubes to grid and cathode. Net \$ 6.90</p> <p>GCM-5 200 watts audio output, from all popular tubes to grid and cathode. Net \$13.50</p>
--	--

UNITED TRANSFORMER CORP.

Write: COMMUNICATIONS DIV. ★ 150 VARICK ST. ★ NEW YORK, N. Y.
EXPORT DIVISION: 100 VARICK STREET NEW YORK, N. Y. CABLES: "ARLAB"

QST for April, 1940, CENTRAL Edition

PRINTED IN U. S. A.
HUMFORD PRESS
CONCORD, N. H.



The numbered parts shown below are as follows:

1. CHT and CHV Crystal Holders
2. R-100 RF Choke
3. HRO Dial, Type 10-0
4. UM and ST Condensers
5. XR-6 Coil Form with Socket
6. BM Dial
7. 6-prong Socket
8. FXT Fixed Tuned Exciter Tank
9. O Dial, Type 0-100
10. XM-10 Transmitting Socket
11. TMSA-50 Condenser
12. UR-13 Buffer Coil Form Assembly

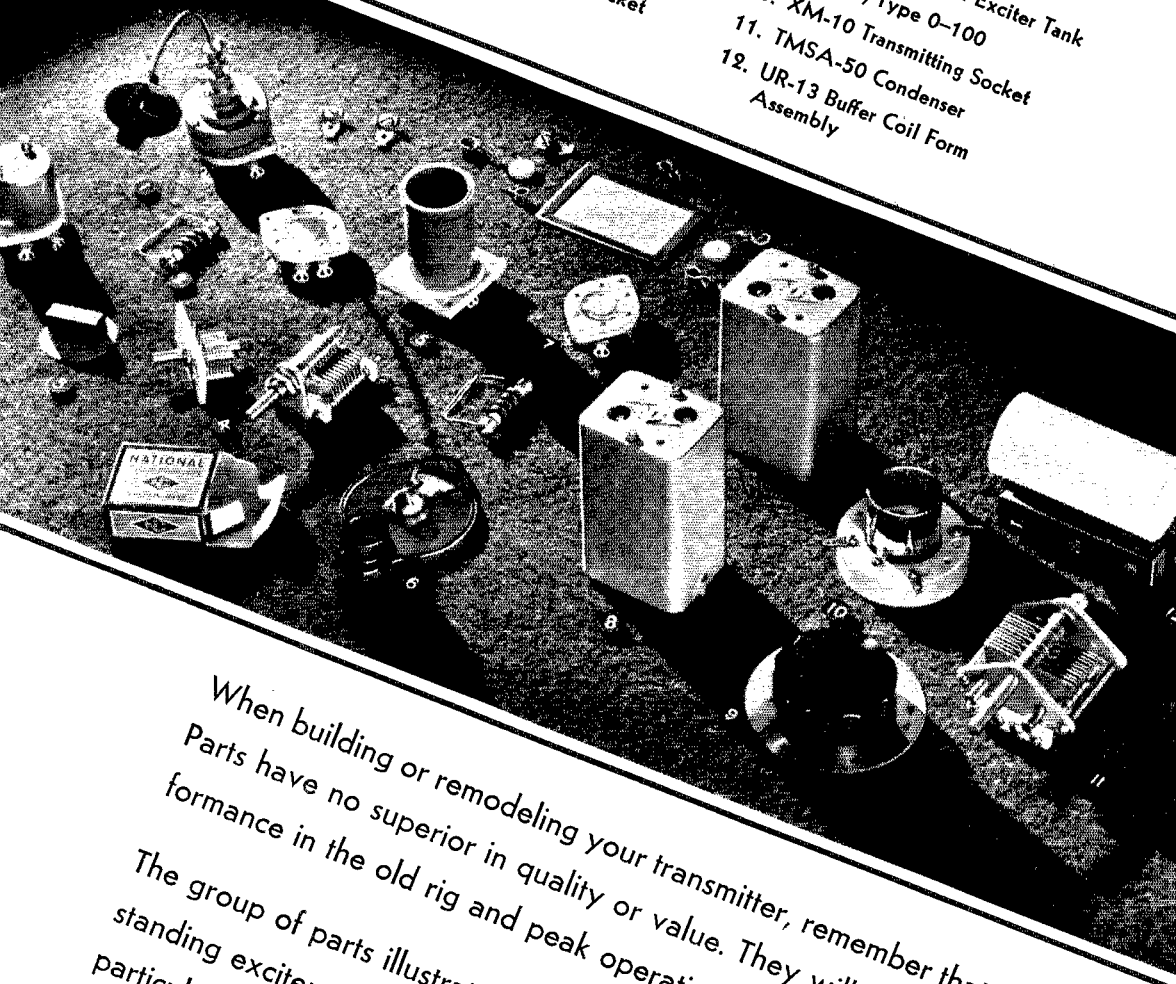

When building or remodeling your transmitter, remember that National Parts have no superior in quality or value. They will insure better performance in the old rig and peak operating efficiency in the new.

The group of parts illustrated above would combine to make an outstanding exciter. From crystal holder to buffer coil form, each unit is particularly suited to its job. It is parts like these that make the NTE Exciter such a fine performer.

NATIONAL COMPANY, INC.
MALDEN, MASS., U. S. A.



"Planned in the Interests of Everybody in Radio"

RCA Preferred Type Tubes Program wins approval of Hallicrafters

**W. J. HALLIGAN, President of the
Hallicrafters Inc. of Chicago**

"Manufacturers, distributor, dealer, and consumer... everybody concerned with radio... will benefit through a reduction of the number of tube types used in receivers. We at Hallicrafters believe that RCA has shown us a sound way to effect our desired reduction. Their Preferred Types Program is a boon to radio."

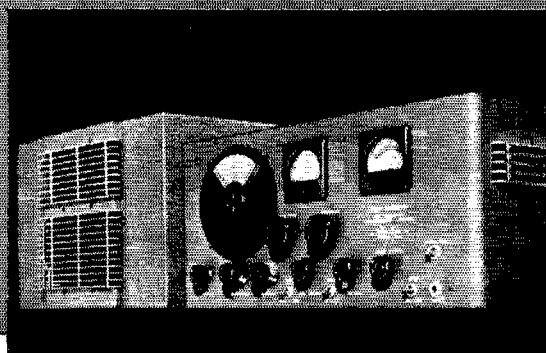

Super Defiant High Frequency Communications Receiver!
Brilliant new development in Communications Science. Has the essentials of the popular Super Skyrider but sells for far less. It employs RCA Preferred Type Tubes.

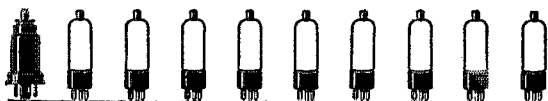

LESS THAN ONE TYPE IN TEN of the 470 types of radio receiver tubes now on the market is actually needed to design practically every type of radio receiver at the lowest ultimate cost. RCA has outlined a list of 36 RCA Preferred Type Tubes which adequately cover every function for any type of receiving set circuit.

MR. HALLIGAN'S comment on the RCA Preferred Type Tubes Program is highly significant because of his wide knowledge of radio and its problems. He agrees with the many other leaders in all phases of radio who have expressed approval of this plan to simplify the radio tube situation. This program was "planned in the interests of everybody in radio." And we at RCA are bending every effort to see that it is carried out in the same spirit with which it was conceived.



Hallicrafters Laboratory Scene. Sound engineering and extensive research backs every piece of Hallicrafters equipment.



RCA Manufacturing Co., Inc., Camden, N. J. • A Service of the Radio Corporation of America