

# QST

July, 1940  
25 cents  
30c in Canada

devoted entirely to

# amateur radio

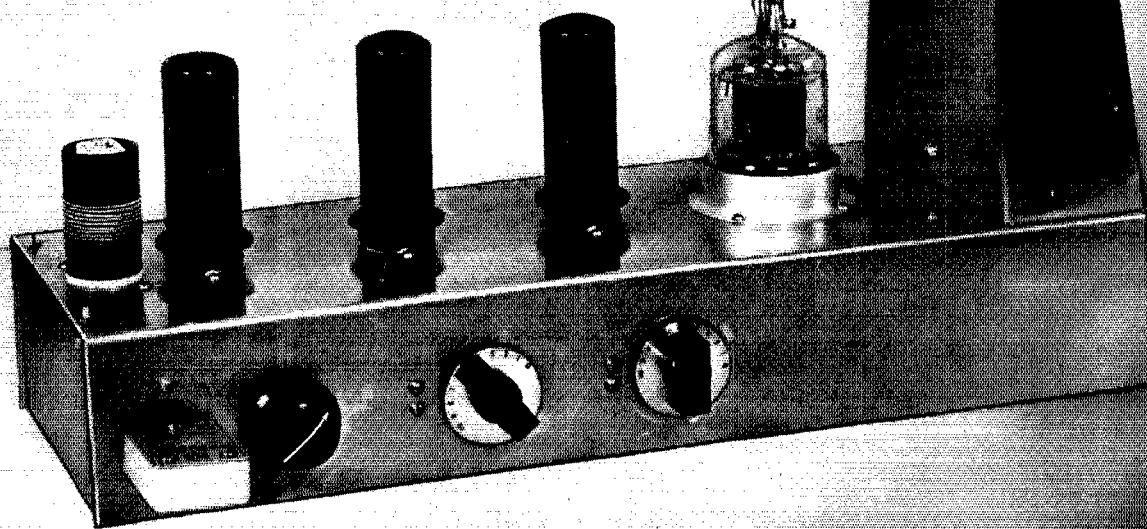

In This Issue—New Gear for Portables and V. H. F. Work

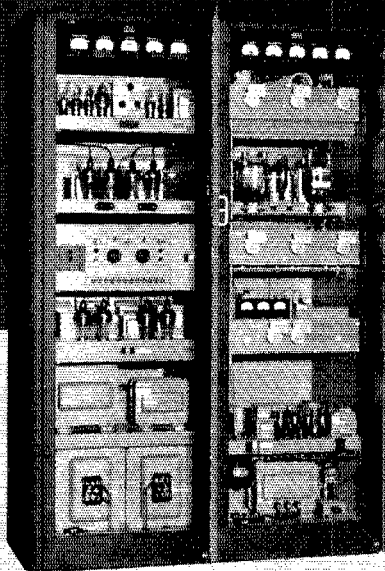

# COLLINS 231C Control Facilities

Certain applications of the 231C occasionally require that the transmitter be attended remotely.

Full provision has been made in the design of the 231C for a variety of remote control facilities.

The arrangement here illustrated employs a telephone dial for remote selection of the ten available frequencies and for selecting the type of emission, as well as for switching the transmitter on and off the air. Complete control and transmission is effected over a single telephone pair.

Four other basic remote control arrangements, each suited to different types of installation, are shown in the 231C Bulletin which is free for the asking.



# COLLINS RADIO COMPANY

## DESIGNED TO GOVERNMENT SPECIFICATIONS

This latest addition to the Hallicrafters family of communications receivers was mechanically and electrically designed by the twelve engineers in our own laboratories. But the specifications and performance characteristics were the result of exhaustive analysis of more than 600 requested reports and voluntary recommendations including specifications of government engineers.

Specific requirements for the best operation in the tropics and Sub-Arctic were included, as were military and marine requisites, broadcast monitoring necessities, professional communications requirements, DX needs and, of course, regional and general amateur requirements.

We sincerely believe the SUPER SKYRIDER has every performance characteristic accepted or demanded by leading engineers in each branch of radio communications. It could, we feel, easily sell for \$250.00, but the Hallicrafters have only one way of arriving at the selling price of a model. It can be, and is, figured on a slide-rule. That method showed the SUPER SKYRIDER could sell, complete with crystal and 14 tubes, less only speaker, for \$159.50 net.

THE NEW 341  
SUPER

*Skyrider*

THE NEW 1941  
SUPER

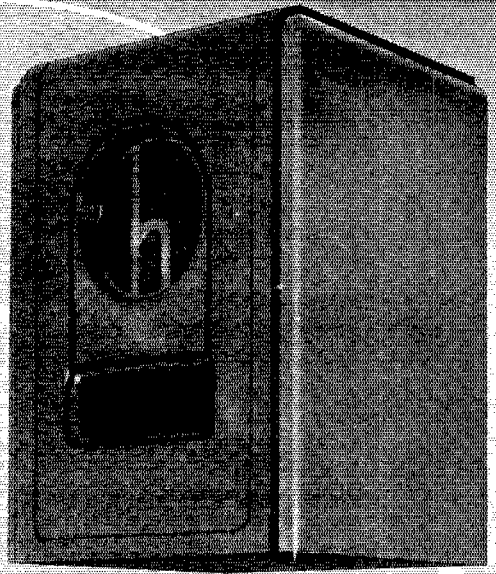

*Skyrider*

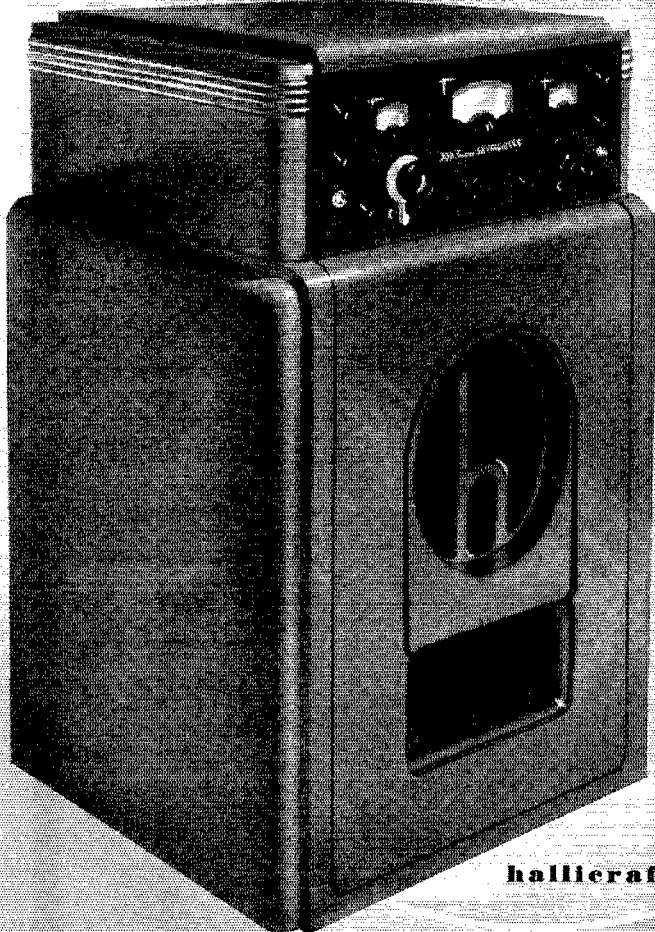

For the first time in communications history, the Hallcrafters present, as regulation accessories, reproducers of the famous *Bass Reflex* type. Especially designed by Hallcrafters-Jensen engineers, these are, we believe, the finest single-speaker enclosures made. Model R-8 (above) is  $23\frac{1}{2} \times 17\frac{1}{2} \times 10\frac{1}{4}$ , complete with special PM Jensen speaker, \$19.50 net. Model R-12 is  $30 \times 22\frac{1}{2} \times 16$ , with special PM Jensen speaker, \$29.50. Both are handsome wooden cabinets finished in Gunmetal gray, providing a pleasing color match with the finish on the 1941 SUPER SKYRIDER.

hallcrafters used by 33 governments



JULY 1940

VOLUME XXIV

NUMBER 7



STAFF

Editorial

KENNETH B. WARNER, W1KH  
Editor and Business Manager

CLARK C. RODDMON, W1SZ  
Managing Editor

GEORGE GRAMMER, W1DF  
Technical Editor

DONALD H. MIX, W1TS  
BYRON GOODMAN, W1JF  
Assistant Technical Editors

EDW. P. TILTON, W1HDQ  
Contributing Editor, U.H.F.

VERNON CHAMBERS, W1JEQ  
Technical Information Service

JAMES J. LAMB, W1AL  
Research Engineer, A.R.R.L.

Advertising

F. CHEYNEY BEEKLEY, W1GS  
Advertising Manager

CHARLES BRUNELLE  
Asst. Advertising Manager

Circulation

DAVID H. HOUGHTON  
Circulation Manager

RALPH T. BEAUDIN, W1BAP  
Asst. Circulation Manager



OFFICES

38 La Salle Road

West Hartford, Connecticut

Subscription rate in United States and Possessions, \$2.50 per year, postpaid; all other countries, \$3.00 per year, postpaid. Single copies, 25 cents. Foreign remittances should be by international postal or express money order or bank draft negotiable in the U. S. and for an equivalent amount in U. S. funds.

Entered as second-class matter May 29, 1919, at the post office at Hartford, Connecticut, under the Act of March 3, 1879. Acceptance for mailing at special rate of postage provided for in section 1103, Act of October 3, 1917, authorized September 9, 1922. Additional entry at Concord, N. H., authorized February 21, 1929, under the Act of February 28, 1925. Additional second-class entries to cover sectional editions authorized March 20, 1935.

Copyright 1940 by the American Radio Relay League, Inc. Title registered at United States Patent Office.

# QST

devoted entirely to

# AMATEUR RADIO

PUBLISHED, MONTHLY, AS ITS OFFICIAL ORGAN, BY THE AMERICAN RADIO RELAY LEAGUE, INC., AT WEST HARTFORD, CONN., U. S. A.; OFFICIAL ORGAN OF THE INTERNATIONAL AMATEUR RADIO UNION



## CONTENTS

Editorials . . . . .	11
A Stabilized Variable-Frequency Oscillator	
<i>G. M. Brown, W2CVV</i>	13
Portable Kinks . . . . .	18
<i>Harry W. Dreyer, W1ANC</i>	18
What the League Is Doing . . . . .	22
Silent Keys . . . . .	29
Counting Words per Minute Electrically . . . . .	30
<i>M. J. Larsen</i>	30
An Efficient U.H.F. Unit for the Amateur Television Transmitter	
<i>L. C. Waller, W2BRO</i>	32
A Different Portable-Emergency Transmitter	
<i>R. P. Austin, W3EVA</i>	36
Roanoke Division Convention . . . . .	37
A Heterodyne Exciter	
<i>W. Roderic Bliss, W1FMZ &amp; Philip A. Bailey, W1BKO</i>	38
An Acorn-Tube 112-Mc. Converter . . . . .	41
<i>M. P. Rehm, W2HNY</i>	41
A Portable Transmitter-Receiver . . . . .	42
<i>Lon M. Hildebrand, W6QUE</i>	42
On the Ultra Highs . . . . .	45
<i>E. P. Tilton, W1HDQ</i>	45
I.A.R.U. News . . . . .	48
1940 A.R.R.L. QSO Party Results . . . . .	49
<i>E. L. Battey, W1UE</i>	49
Hints and Kinks	
<i>Starting Tool for Drills—Low-Cost 14-Mc. Vertical—</i>	
<i>Eliminating 'Phone Interference with Line Telephone—</i>	
<i>Neutralizing R.F. Stages with a Modulating Monitor—'Scope</i>	
<i>Coupling—Improving the Usefulness of a Globe—Note on</i>	
<i>Tube Keying Systems . . . . .</i>	50
Our Cover . . . . .	52
Correspondence . . . . .	53
Operating News . . . . .	54
Brass Pounders' League . . . . .	55
W1AW Summer Schedule . . . . .	57
How's DX? . . . . .	58
New Receiving Tubes . . . . .	66
New Apparatus . . . . .	68
Rocky Mountain Division Convention . . . . .	78
Book Review . . . . .	86
A.R.R.L. QSL Bureau . . . . .	98
WVW Schedules . . . . .	100
Hamads . . . . .	107
QST's Index of Advertisers . . . . .	110

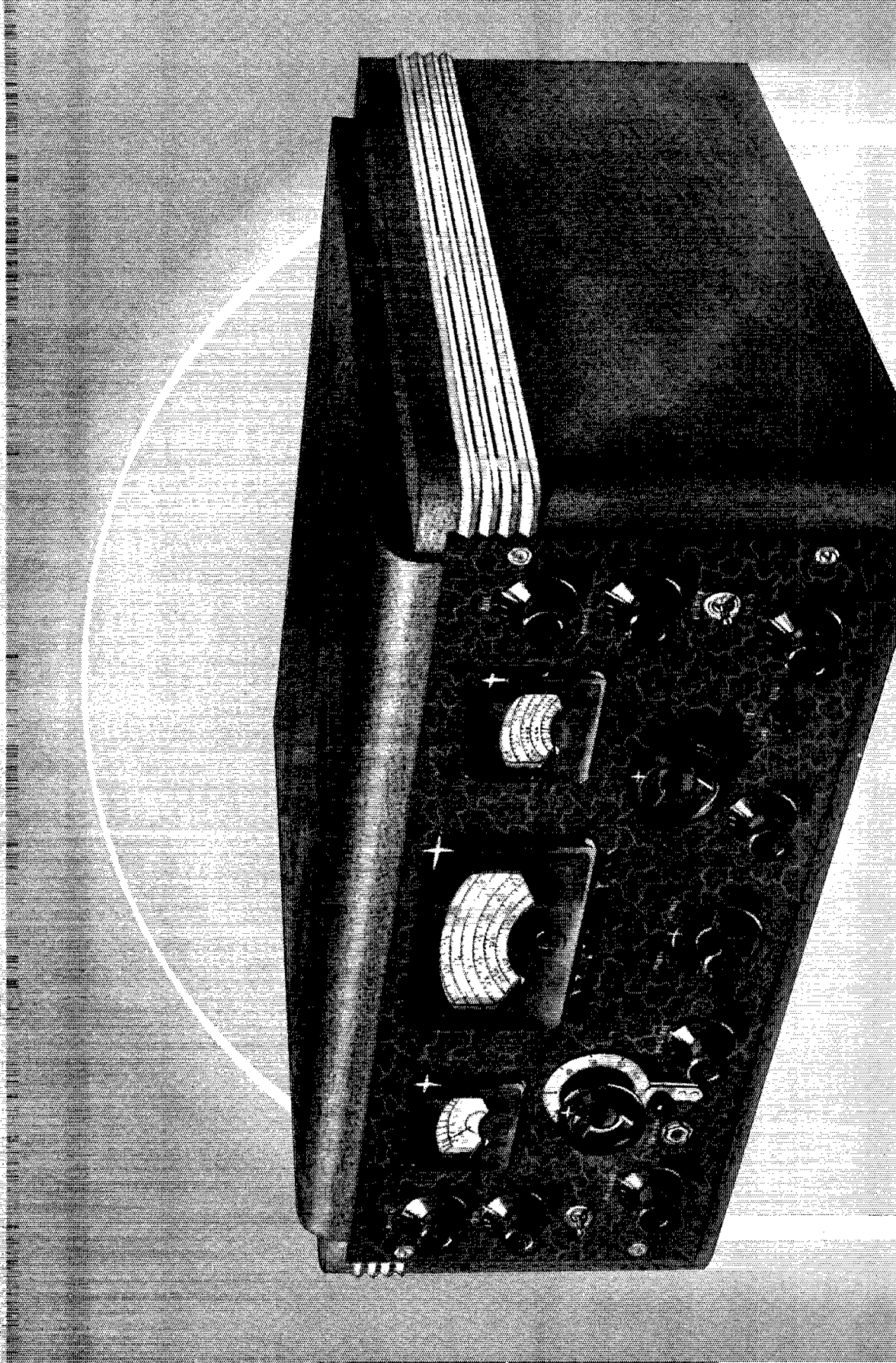

# NEW STANDARDS

## FOR RECEIVER PERFORMANCE

A few fundamentals of the new SUPER SKYRIDER are 6 bands covering 540kc to 43mc—2 stages of preselection—high fidelity, push pull audio—band pass audio filter—a new and highly efficient crystal filter circuit—an additional and completely effective noise limiter—cadmium plated steel chassis—standard relay rack panel  $\frac{1}{4}$  inch thick—machine tool, gray wrinkle, well ventilated steel cabinet.

THE NEW 641  
SUPER

*Skyrider*

by Hallierafers

THE NEW 1941  
SUPER

# Skyride

POINTS O

Price was not a factor in the design of this model. It has details of construction as costly as skilled engineering necessitated. Nine features of construction are listed below. Additional features include provision for plugging in phonograph record player, also added facility for feeding recording heads through use of proper microphone.

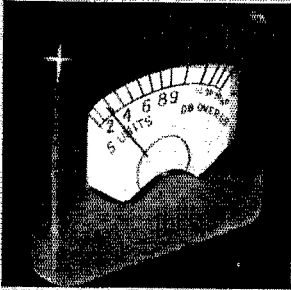

Wide angle reading "S" meter operated on the vacuum tube voltmeter principle. Meter scale calibrated directly in "S" units and DB's over S9.

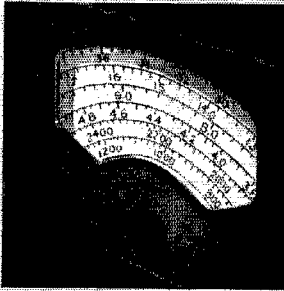

Latest design in escutcheons to provide maximum visibility of dials and meter. Indirectly lighted dials have direct reading band indicator.

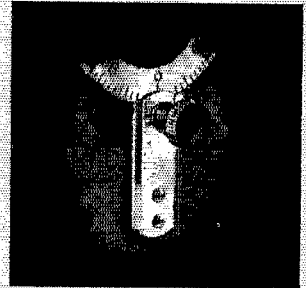

Logging dial permits accurate resetting of main dial to a known frequency control; can be locked in position for permanence of dial setting.

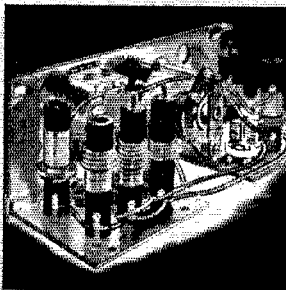

Air trimmers—heavy coil-form construction—inductance and capacity trimming for accurate tracking—laid out for lowest losses—rigid mounting brackets—each coil assembly isolated by suitable shielding.

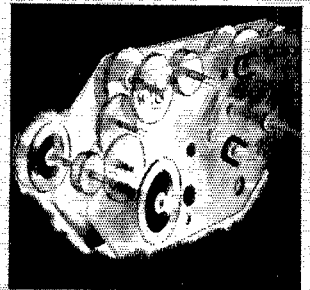

New type inertia-controlled back-lash-free dial mechanism on both main tuning and bandsread dials. This mechanism is preloaded and the main shafts are supported at both ends with ball bearings.

USED BY 33 GOVERNMENTS



# TECHNICAL INTEREST

Controls on the front panel are: Micrometer scale main tuning inertia controlled. Calibrated band spread. Tone and AC ON-OFF. Beat Frequency Oscillator. A.F. Gain. R.F. Gain. 6 position band switch. Antenna Trimmer. 6 position selectivity control. Crystal phasing. Adjustable noise limiter. Send-Receive Switch. A.V.C.-B.F.O. Switch. Bass boost switch. Phone jack.

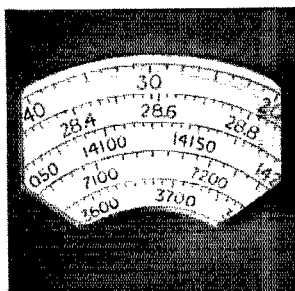

Accurate long scale calibrated band spread on amateur bands of 10, 20, 40 and 80 meters provides effective frequency meter tuning.

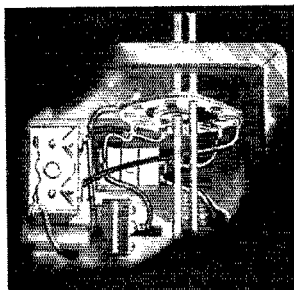

Design of crystal circuit enables crystal gain to be predetermined and greater gain realized. Maximum selectivity with no reduction in sensitivity.

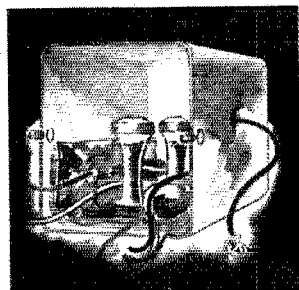

Air-permeability tuned IF transformers operating at 455kc provides highest gain obtainable with higher signal-to-noise ratio.

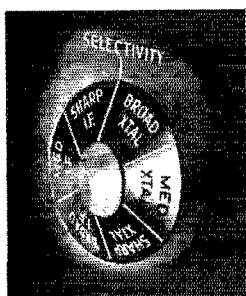

6 step selectivity from broad high fidelity to extremely sharp CW crystal by a combination of expanding IF amplifier and variable crystal circuit. Every selectivity requirement fulfilled.

*the hallicrafters inc.*  
*chicago, illinois, U.S.A.*

# hallicrafters

*Designed to Government Specifications*

**SOLD TO 39 COUNTRIES**

## Section Communications Managers of the A.R.R.L. Communications Department

All appointments in the League's field organization are made by the proper S.C.M., elected by members in each Section listed. Mail your S.C.M. (on the 10th of each month) a postal covering your radio activities for the previous 30 days. Tell him your DX, plans for experimenting, results in 'phone and traffic. He is interested, whether you are an A.R.R.L. member or get your QST from the newstands; he wants a report from every active ham. If interested and qualified for O.R.S., O.P.S. or other appointments he can tell you about them, too.

ATLANTIC DIVISION			
Eastern Pennsylvania Maryland-Delaware-District of Columbia Southern New Jersey Western New York Western Pennsylvania	W3BES W3CIZ W3CCO W8PLA W8OFO	Jerry Mathis Hermann E. Hobbs Lester H. Allen Fred Chichester Kendall Speer, Jr.	6042 Master St. 9701 Monroe St. Silver Spring P.O. 704 Quinton Ave. Philadelphia Linden, Maryland Trenton Sonyea Lower
CENTRAL DIVISION			
Illinois * Indiana Kentucky Michigan Ohio Wisconsin	W9LLH W9AB W9ARU W8DPE W8AQ W9UJT	Mrs. Carrie Jones Harry B. Miller Darrell A. Downard Harold C. Bird E. H. Gibbs Aldrich C. Kronos	2407 Central Ave. 729 E. Lowell Ave. 116 N. Longworth Ave. R. F. D. 2 405 Broad St. 2702 So. 46th St. Alton Milwaukee Louisville Pontiac Wadsworth Milwaukee
DAKOTA DIVISION			
North Dakota South Dakota Northern Minnesota Southern Minnesota	W9WWL W9ADJ W9IGZ W9VNG	Anton C. Theodos E. C. Mobley Edwin L. Wicklund Millard L. Bender	Box 444 Box 149 R. F. D. 3 608 N. Huron Ave. Williston Rapid City Kensington Spring Valley
DELTA DIVISION			
Arkansas Louisiana Mississippi Tennessee	W5ABL W5DWW W5EWD W4DWS	H. E. Veltz W. J. Wilkinson, Jr. Jewell W. Cole William Harold Walker	4415 West 12th St. 1523 Laurel St. c/o City of McComb Water Dept. 1901 Cedar Lane Little Rock Shreveport McComb City Nashville
HUDSON DIVISION			
Eastern New York N. Y. C. & Long Island Northern New Jersey	W2LU W2AZV W2GVZ	Robert E. Haight E. L. Baughach Joseph P. Jessup	511 South Holmes St. 102 Central Ave. 131 California St. Scotia Massapequa, L. I. Ridgewood
MIDWEST DIVISION			
Iowa Kansas Missouri Nebraska	W9PIR W9UEG W9OUD W9DI	L. B. Vennard Melvin D. Kirby Miss Letha Allendorf William J. Bamer	P. O. Box 304 1015 W. 3rd St. West Burlington Arlington Joplin Tobias
NEW ENGLAND DIVISION			
Connecticut Maine Eastern Massachusetts Western Massachusetts New Hampshire Rhode Island Vermont	W1CTI W1IIE W1ALP W1IAH W1BFT W1HRC W1KJG	Frederick E. Jr. H. W. Castner Frank L. Baker, Jr. William J. Barrett Carl B. Evans Clayton C. Gordon Clifton G. Parker	19 Merrill Rd. 147 Church 21 Colby Road 239 Columbia St. 163 South Main St. 70 Columbia Ave., Gaspee Box 337 Norwalk Damariscotta North Quincy Adams Concord Plateau, Warwick Morriville
NORTHWESTERN DIVISION			
Alaska * Idaho Montana Oregon Washington	K7GNN W7EMT W7CPY W7DXF W7FCG	James G. Sherry Carl Eichelberger Rex Roberts Harold W. Johnston W. Beale	Route 2 Box 1088 902 N. W. DeSpain R. 4, School Ave. Chichagof Kuna Glendive Pendleton Walla Walla
PACIFIC DIVISION			
Hawaii Nevada Santa Clara Valley East Bay San Francisco Sacramento Valley Philippines San Joaquin Valley	K6EIF W6BIC W6FBW W6TI W6CIS W6MDF KA1GR W6KUT	Francis T. Blatt Edward W. Heim Elbert Amarantes Horace R. Greer Kenneth E. Hughes Vincent N. Feldhausen George L. Rickard Edwin A. Andrews	837 16th Ave. 509 Claremont St. 454 Washington St. 414 Fairmount Ave. 622-36th Ave. 113 South Quincy St. Box 849 2921 North Van Ness Blvd. Honolulu Reno San Jose Oakland San Francisco McCloud Manila Fresno
ROANOKE DIVISION			
North Carolina South Carolina Virginia West Virginia	W4CYB W4BOE/ANG W3GWQ W8OXO	W. J. Wortman Ted Ferguson Frank S. Anderson, Jr. W. D. Tabler	P. O. Box 566 1213 College St. 4703 New Kent Ave. 238 Watson Ave. Morganton Columbia Richmond Fairmont
ROCKY MOUNTAIN DIVISION			
Colorado Utah-Wyoming	W9EHC W7CLG	Carl C. Drumeller Ernest E. Parshall	819 East Dale St. Salt Creek Electric Plant Colorado Springs Midwest, Wyoming
SOUTHEASTERN DIVISION			
Alabama Eastern Florida Western Florida Georgia West Indies (Cuba-Isle-of-Pines- Porto Rico-Virgin Islands)	W4DGS W4PEI W4AXP W4AGI CM2OP	James F. Thompson Carl G. Schaal Oscar Cederstrom Leland W. Smith Mario de la Torre	12 Clanton Ave. Waucoma Apts. Lakeview Hotel Second St. & Bruce Ave. 2010 Pennsylvania Ave. Escobar 110 (Altos) Montgomery Clermont De Funiak Springs Augusta Habana, Cuba
SOUTHWESTERN DIVISION			
Los Angeles Arizona San Diego	W6MQM W6KMM W6BKZ	Ralph S. Click Marson B. Hull Louis A. Cartwright	1038 Milwaukee Ave. 617 North Fourth Ave. 370 Nautilus Los Angeles Phoenix La Jolla
WEST GULF DIVISION			
Northern Texas Oklahoma Southern Texas New Mexico	W5DXA W5GFT W5MNI W5ENI	Lee Hughes Russell W. Battern Horace E. Bidy Dr. Hilton W. Gillett	125 N. Main St. 431 South Buchanan 1746 Sclay Ave. Childress Enid San Antonio Lovington
MARITIME DIVISION			
Maritime	VE1DQ	A. M. Crowell	69 Dublin St. Halifax, N. S.
ONTARIO DIVISION			
Ontario	VE3SG	F. H. B. Saxon	302 Lee Ave. Toronto, Ont.
QUEBEC DIVISION			
Quebec	VE2CO	Lindsey G. Morris	Apt. 6, 4510 Girouard Ave., N. D. G. Montreal, P. Q.
VANALTA DIVISION			
Alberta British Columbia	VE4GE VE5DD	C. S. Jamieson C. O. I. Sawyer	581 W. Riverside Drive 2634 West 31st Ave. Drumheller, Alta. Vancouver
PRAIRIE DIVISION			
Manitoba Saskatchewan	VE4AAW VE4SY	A. W. Morley Arthur Chesworth	747 McMillan Ave. 1071 4th Ave., N. W. Winnipeg Moose Jaw

\* Officials appointed to act until the membership of the Section choose permanent S.C.M.s by nomination and election.

# "MICHEVO" (WHO CARES)

**T**HAT'S how Rruditchka Rubinski feels about it. A change in his power supply put nearly 2200 volts on his 2000-volt G-E Pyranol capacitors, but it doesn't phase Rruditchka. He knows Pyranol capacitors can take it—that they can be operated continuously at 10% above rated voltage with complete safety. Pyranol makes them extra compact, too, and they are available in either round or rectangular shapes for both upright and inverted mounting.

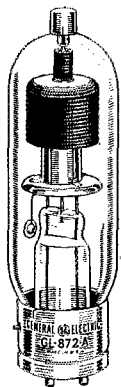

- GL-872.....\$9**  
 Plate Current  
 1.25 amp  
 Max. Peak Inverse  
 Volts 7500
- GL-872-A.....\$11**  
 Plate Current  
 1.25 amp  
 Max. Peak Inverse  
 Volts 10,000

The G-E distributor near you handles our complete line of transmitting tubes and Pyranol capacitors. He has full information, plus bulletins GEA-3315A (G-E Transmitting Tubes) and GEA-2021B (G-E Pyranol Capacitors). If you don't know where he's located, use the convenient coupon.

**S**PEAKING of power-supply changes, should you be changing yours? If you have a high-power rig, you may be loading your rectifier tubes pretty heavily. If so, you can get greater dependability and longer tube life by changing to GL-872's or GL-872-A's. Commercial operators in all parts of the country have made that change, and they're money ahead for it. That's reason enough, we believe, for you to consider doing the same.

General Electric Co. Sec. Q-161-4  
 Schenectady, N. Y.

Please send names of near-by G-E dealers,  
 and also

- GEA-3315A (G-E Transmitting Tubes)  
 GEA-2021B (G-E Pyranol Capacitors)

Name.....

Address.....

# GENERAL ELECTRIC

161-1

# THE AMERICAN RADIO RELAY LEAGUE

## Directors

<i>President</i>	
GEORGE W. BAILEY.....W1KH	74 Webster Road, Weston, Mass.
<i>Vice-President</i>	
CHARLES E. BLALACK.....W6GG	1273 Main St., El Centro, Calif.
<i>Canadian General Manager</i>	
ALEX REID.....VE2BE	169 Logan Ave., St. Lambert, P. Q.
<i>Atlantic Division</i>	
WALTER BRADLEY MARTIN.....W3QV	Box 612, Roslyn, Pa.
<i>Central Division</i>	
R. H. G. MATHEWS.....ex-W0ZN	4534 Dover St., Chicago
<i>Dakota Division</i>	
FRED W. YOUNG.....W9MZN	107 Hanover St., Mankato, Minn.
<i>Delta Division</i>	
E. RAY ARLEDGE.....W581	P.O. Box 286, Pine Bluff, Ark.
<i>Hudson Division</i>	
KENNETH T. HILL.....W2AHC	115 Willow St., Douglaston, L. I. N. Y.
<i>Midwest Division</i>	
FLOYD E. NORWINE, JR.....W9EFC	7405 Hlawatha Ave., Richmond Heights, Mo.
<i>New England Division</i>	
PERCY C. NOBLE.....W1BVR	37 Broad St., Westfield, Mass.
<i>Northwestern Division</i>	
RALPH J. GIBBONS.....W7KV	c/o United Air Lines, Portland, Ore.
<i>Pacific Division</i>	
J. L. McCARGAR.....W6EY	66 Hamilton Pl., Oakland, Calif.
<i>Roanoke Division</i>	
H. L. CAVENESS.....W4DW	State College Station, Raleigh, N. C.
<i>Rocky Mountain Division</i>	
GLEN R. GLASSCOCK.....W9FA	2164 So. Corona St., Denver
<i>Southeastern Division</i>	
WILLIAM C. SHELTON.....W4ASR	Box 652, Daytona Beach, Fla.
<i>Southwestern Division</i>	
<i>West Gulf Division</i>	
WILLIAM A. GREEN.....W5BKH	801 Ross St., Abilene, Texas

THE AMERICAN RADIO RELAY LEAGUE, INC., is a non-commercial association of radio amateurs, bonded for the promotion of interest in amateur radio communication and experimentation, for the relaying of messages by radio, for the advancement of the radio art and of the public welfare, for the representation of the radio amateur in legislative matters, and for the maintenance of fraternalism and a high standard of conduct.

It is an incorporated association without capital stock, chartered under the laws of Connecticut. Its affairs are governed by a Board of Directors, elected every two years by the general membership. The officers are elected or appointed by the Directors. The League is non-commercial and no one commercially engaged in the manufacture, sale or rental of radio apparatus is eligible to membership on its board.

"Of, by and for the amateur," it numbers within its ranks practically every worth-while amateur in the nation and has a history of glorious achievement as the standard-bearer in amateur affairs.

Inquiries regarding membership are solicited. A bona fide interest in amateur radio is the only essential qualification; ownership of a transmitting station and knowledge of the code are not prerequisite. Correspondence should be addressed to the Secretary.



## Past Presidents

HIRAM PERCY MAXIM, 1914-1936  
EUGENE C. WOODRUFF, 1936-1940

## Officers

<i>President</i> .....	GEORGE W. BAILEY, W1KH
	Weston, Mass.
<i>Vice-President</i> .....	CHARLES E. BLALACK, W6GG
	El Centro, Calif.
<i>Secretary</i> .....	KENNETH B. WARNER, W1EH
	West Hartford, Connecticut
<i>Treasurer</i> .....	ARTHUR A. HEBERT, W1ES
	West Hartford, Connecticut
<i>Communications Mgr.</i> .....	F. EDWARD HANDY, W1BDI
	West Hartford, Connecticut
<i>General Counsel</i> .....	PAUL M. SEGAL
	1026 Woodward Building, Washington, D. C.
<i>Address all general correspondence to the administrative headquarters at West Hartford, Connecticut.</i>	



# "IT SEEMS TO US—"

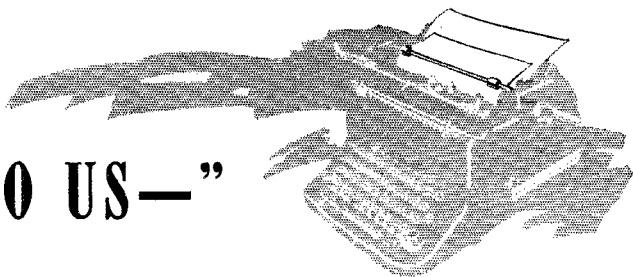

**I**N THE few short weeks since we last addressed you on this page, the great European tragedy has flamed to new dimensions, has become a threat to all the world, and has made profound changes in the attitude of our own people and our own government. Inescapably this situation brings us new problems.

When we got up the A.R.R.L. Neutrality Code at the outbreak of the war, we did not include in it a self-imposed prohibition against working amateurs in belligerent countries and colonies, for the excellent reason that we did not for a moment expect that there would be any. From time to time there have been some, and it seems that the situation requires discussion. There are some foreign amateur stations that seem more than willing to give American amateurs information concerning the military situation, and one can only gather that they are being encouraged to do this for the purpose of cultivating us. It would be questionable neutrality for us to lend ourselves to such a situation. Our citizens and ships are obliged to keep out of belligerent territory, and no great extension of that thought would preclude our direct exchange of views with belligerents during these difficult days.

But the problem goes beyond that. The mad race in Europe unhappily seems likely to spread to still more countries so that there is no telling whether there will be any countries left untouched on that unfortunate continent. Moreover, in the few remaining countries not yet aflame, and where there are on the air at the most a few dozen amateurs, it seems probable that the stations are not operating with the full consent of their governments, which again is a hazardous condition for us.

League headquarters therefore has reluctantly come to the opinion that we ought not to work any European amateurs whomsoever, even for the barest routine exchange of signal reports. It just doesn't any longer become us in anyone else's eyes, regardless of our own knowledge of the utter unimportance of the contact. We are impelled to this conclusion by every broad-gauge consideration of the interests of our art. It is difficult to come to this decision. We are immensely sorry to have to

make this recommendation because amateur radio on this side is truly neutral and is well capable of continuing to deal with the amateur of every nation, neutral or not, as a brother. By concerning ourselves strictly with technical matters, we could avoid entanglement and embarrassment. Yet we know that other people will not think so, and the safety of United States amateur radio compels us to give heed. After all, what is the value of the pleasure in a few fleeting DX contacts when these activities lay the individual amateur open to suspicion and prejudice the standing of our whole fraternity?

Put it down, then, as part of the A.R.R.L. Neutrality Code that we pledge ourselves to work no Europeans until the conflagration there subsides.

No law or regulation compels us to do this. No law or regulation is responsible for any part of our Neutrality Code. In fact, if such things had been dictated to us by the government at the outbreak of the war, we might well have been aroused to resentment at such a curb on traditional and constitutional rights. Our code is self-imposed. But, being voluntary, we are indeed the more strongly bound by it. It is another demonstration of the cooperative ability of the United States amateur to conduct himself in a temperate way and to police himself. Our position with our government is not the result of happenstance: we have earned their trust by demonstration down through the years of our sanity and foresight and our respect for the best interests of our country. We can take pride in this code of ours. It enabled us to demonstrate, in the early weeks of the trouble, that we could again be counted upon to take care of ourselves, and that the government need not worry about our violating neutrality or serving as dangerous channels of communication, even unwittingly. It was that showing alone that prevented the unnecessary closing down of ham radio during those weeks when everybody had the down-yonders and anything could happen. Official Washington was frankly amazed at the speed with which we amateurs ourselves spread this code around amongst our brethren, and our rigid

observance of it tremendously enhanced our prestige. This demonstration of trustworthiness again stood us excellently when the war spread with amazing suddenness in May. We must be able to count upon its doing so as the situation grows more tense with every passing day.

It is therefore to this code of conduct that we owe our security to-day. It must continue to be absolutely respected by us all. The government cannot police 50,000 amateurs; if they believed we required constant monitoring, it would be easier to suspend us. Therefore nothing is of greater importance than that every last one of us so conduct himself that his operations are above suspicion. This is not a job that headquarters can do for you; it depends upon what you fellows do in your individual shacks.

Let's summarize it: We do not work amateurs anywhere in Europe, belligerent or otherwise. We keep all our international contacts with other continents strictly on the basis of experiment and small talk. We relay no intelligence of any sort from one country to a third country. We talk only in plain language, and we always sign our call at the end of each transmission. Even amongst ourselves we do not discuss on the air anything about the war or any topic that might have a military significance for an interceptor. In other words, we make an absolutely rigid separation between this war and our interest in amateur radio, that the

## **FLASH!**

### ***Foreign Communications Prohibited!***

Our printer had just got that much of our editorial set up in type when, about noon of June 5th, the F.C.C. issued an order, effective at once, suspending communication between amateurs licensed by F.C.C. and those in any foreign country. Thus a great deal of what we were talking about is removed from a discretionary basis, made mandatory. Let the Commission's order speak for itself:

#### ***Order No. 72***

At a meeting of the Federal Communications Commission held at its office in Washington on the fourth day of June, 1940,

Pursuant to authority contained in Sec. 303 of the Communications Act of 1934, and in accordance with Article 8, Sec. 1, of the General Radio Regulations (Cairo Revision, 1938) annexed to the International Telecommunications Convention (Madrid, 1934):

**IT IS ORDERED**, that amateur radio operators and amateur radio stations licensed by the Federal Communications Commission shall not exchange communications with operators or radio stations of any foreign government or located in any foreign country; provided, however, that this order is not intended to prohibit the exchange of communications between licensed amateur operators and licensed amateur stations in the continental United States and licensed amateur operators and licensed amateur stations in the several territories and possessions of the United States, or between licensed amateur operators and licensed amateur stations in the continental United States and United States citizens authorized to operate amateur radio stations in the Philippine Islands or the Canal Zone, or between licensed amateur operators and licensed amateur stations in the several territories and possessions of the United States.

**IT IS FURTHER ORDERED**, that all rules and regulations of the Commission inconsistent with this order be, and the same are hereby, suspended, pending the further order of the Commission.

This order shall become effective immediately.

By the Commission:  
*T. J. Slowie, Secretary*

This order washes out all foreign DX. K4 (and KC4), all the varieties of K6, and K7 of course are still OK — these are U. S. K5 and NY are OK, as are all the KA stations operated at military or naval bases. Also approved is communication with any other KA station licensed to a United States citizen; otherwise it is not.

Inevitably there will be some hardships under these restrictions. If you are connected with any cases in which these requirements prevent communication with a distant United States citizen who desperately needs it, communicate the facts *to your division director* — it may be possible to do something about it.

A monthly magazine cannot keep up with this fast-moving international situation. The best possible service of information is being given over W1AW and the A.R.R.L. Official Broadcasting system. Further news, interpretations of this regulation, etc., will go out daily over W1AW. Keep yourself informed by making it a practice to listen daily for the fast developments that come between the issues of *QST*.

K. B. W.

# A Stabilized Variable-Frequency Oscillator

## Design Considerations for High-Stability Transmitter Frequency Control

BY G. M. BROWN,\* W2CVV

SOME two years ago, when the owner and operator of W2CVV got tired of trying to dodge the QRM on the 4-Mc. 'phone band with a few moth-eaten crystals, the obvious expedient was to build some sort of continuously variable oscillator for controlling the transmitter frequency.

After perusal of various articles on e.c.o.'s and inspection of some such oscillators in service, none of which seemed to be the entire answer to the problem, it was decided to start with fundamentals and see what could be done.

The stabilized variable-frequency oscillator which resulted, as well as others of essentially the same design built by W2ACB, W2HZL, W2VO, W2GFH, W1JLT and others, has been so uniformly successful on all bands from 10 to 160 that this article has been prepared. It is not intended to cover complete constructional details, although all components, constants, and circuits together with photographs of the original model are given, but rather is to be used as a guide in designing an oscillator to fit the needs of the individual builder. To this end the reasons for all design decisions of a major nature, and suggested design variations which may better fit individual needs, are included.

### The Requirements

No design problem can be successfully attacked without a rather accurate outline of the desired features of the contemplated equipment. When boiled down, these features for a variable oscillator, in their approximate order of importance, are outlined below.

#### 1. Frequency Stability

Although there is plenty of room for argument as to the relative importance of various requirements, there can be little doubt that a high order of frequency stability, under any and all conditions, belongs at the top of the list. We all like to get close to the edge of the band now and then, and Grand Island QSL's are uniformly un-welcome.

#### 2. Reset Accuracy

Reset accuracy is very nearly as important as frequency stability — neither can be fully utilized without the other.

#### 3. Convenience of Operation

Setting of the frequency must be accomplished by means of a single control.

\* General Electric Co., Schenectady, N. Y.

The necessary switches must be provided to permit the oscillator to be turned on alone, without the rest of the transmitter being energized, thus avoiding the cardinal sin of e.c.o. operators of swishing carriers up and down the band.

Means must be provided for automatically energizing the oscillator with the transmitter during normal operation, without requiring manipulation of additional send-receive switches.

#### 4. Economy

Inexpensive receiver-type components must be used wherever possible without sacrificing necessary operational requirements.

### Frequency Stability

Since the achievement of exceptional frequency stability is of major importance, that problem was taken up first. An analysis of the various factors tending to cause frequency variations resulted in a list of the most important as follows:

1. Temperature variations.
2. Humidity variations.
3. Oscillator plate voltage variations.
4. Oscillator loading variations.
5. Mechanical shifting of parts.

Temperature variations affect frequency by

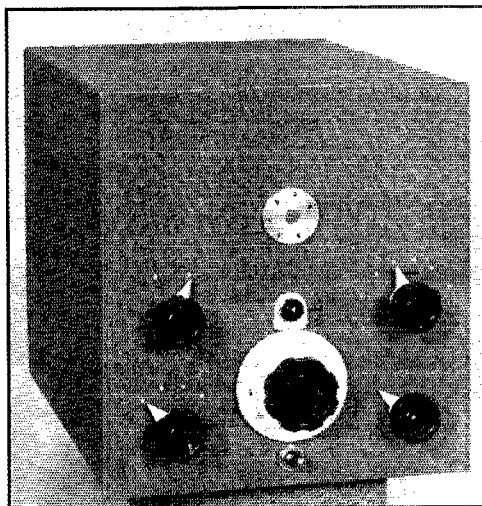

The stabilized variable-frequency oscillator built by W2CVV. The lower dial makes six revolutions for complete band coverage, the smaller dial above indicating the number of tuning dial revolutions.

Maybe you have an e.c.o. that satisfies you right down to the ground, or maybe you're just on the verge of making your first stab at variable-frequency control. In either case you'll do well to read this article with care, because it not only sets out the problems in clear-cut fashion, but also provides practical solutions to them. And perhaps some of the suggestions will make that good e.c.o. even better.

changing the mechanical size and thus the electrical characteristics of the frequency-determining circuits. With increasing temperature, coils become larger and have more inductance, and ordinary air condensers become larger and have more capacity. Both these effects tend to lower the resonant frequency. They may both be quite well compensated for over a reasonably small frequency range, such as a single amateur band, by a fixed condenser so constructed as to have a negative temperature coefficient. Fortunately the development of small, cheap titanium-dioxide capacitors having such a coefficient makes the use of a bulky bimetallic compensator unnecessary.

The final selection of the amount of temperature compensation required can best be determined by cut-and-try methods, since there will be considerable variation in individual circuit components and mechanical arrangements. A rough calculation, however, will at least provide a starting point. Since titanium dioxide compensators have a negative temperature coefficient of 0.06 per cent per degree C, approximately ten to twenty times the positive coefficient of the normal coil and condenser combination, the use of five to ten per cent titanium dioxide capacity in the total tank capacity will be a good place to start. If the completed oscillator has a tendency to drift down in frequency as it warms up, it means that more compensation is needed, and vice versa. The results of tests on the first model indicate that the 20- $\mu$ fd. Erie Ceramicon compensator is about right with 240 to 340  $\mu$ fd. total tuning capacity. Of course, it is entirely possible to obtain satisfactory compensation with compensators having coefficients lower than 0.06 per cent—in fact, if the proper negative coefficient is available, the entire fixed padder,  $C_3$  (Fig. 1), may be used to compensate the coil and variable capacitor, and no other compensation used. Another possibility is to use a zero-coefficient capacitor for  $C_3$ , and make  $C_6$  only large enough to compensate for the other circuit components.

Although such compensation is quite effective in compensating for frequency drift caused by ambient temperature changes and general heating of the oscillator unit during operation, changes

from tube heating cannot be disposed of so easily. It was, therefore, deemed advisable not to make any attempt to compensate for tube changes, but rather to minimize their effect by using a small, low capacity, lightly loaded oscillator tube of the type ordinarily employed for the heterodyning oscillator of receivers, and a high-C oscillator tank circuit.

The effects of humidity on oscillator frequency are not entirely understood, and can be completely eliminated only by hermetically sealed compartments. The use of wax-sealed high-stability fixed padding condensers for a major portion of the tank circuit was found to provide adequate freedom from humidity effects under normal operating conditions.

The frequency of the conventional electron-coupled, or Dow, oscillator can be so designed and adjusted that its frequency is relatively

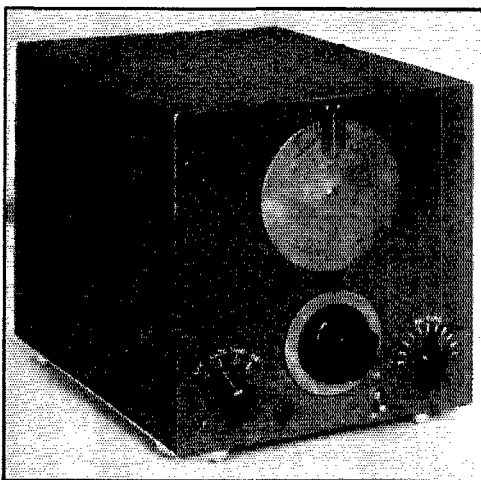

The frequency-control unit using the same principles, built by Lyle Peer, W2ACB, has a somewhat different mechanical arrangement and directly-calibrated dial. The inner scale of the upper dial indicates the number of revolutions of the lower dial.

independent of minor changes in supply voltage and output coupling. Careful measurements have shown, however, that the optimum adjustment of such things as screen to plate voltage ratio is dependent on  $L/C$  ratio, and consequently is not uniform over a frequency band.

To avoid the necessity for critical adjustments to obtain freedom from supply voltage and loading effects on the frequency, it was decided to eliminate the causes rather than to attempt to compensate for them. The supply voltage variations were easily disposed of by the use of a modification of the voltage-regulated power supply described in August, 1937, *QST*.<sup>1</sup> Variations in

<sup>1</sup> Grammer, "Battery Performance from the R.A.C. Power Supply," *QST*, August, 1937.



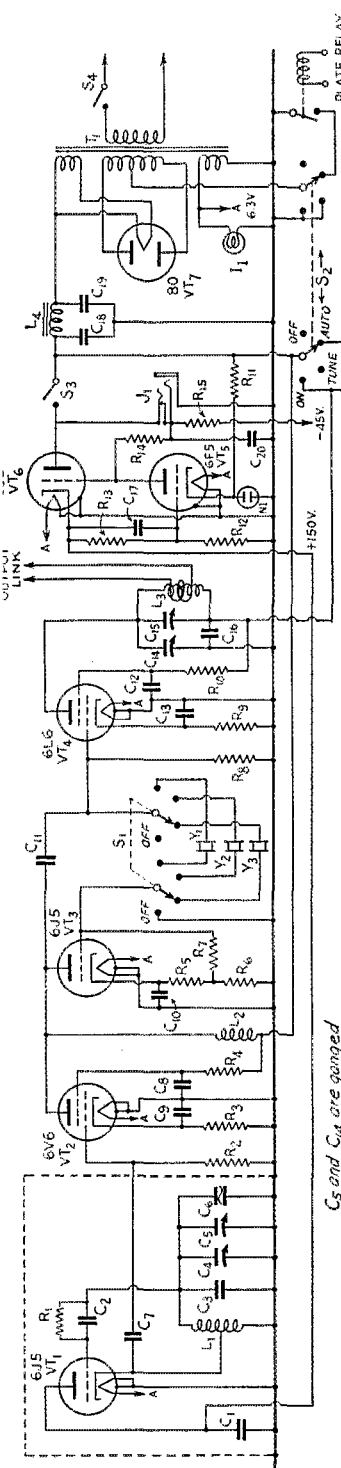

*C<sub>3</sub> and C<sub>14</sub> are ganged*

Fig. 1 — Circuit diagram of the variable-frequency exciter.

- C<sub>1</sub> — 0.005- $\mu$ fd. mica.
- C<sub>2</sub> — 500- $\mu$ fd. mica.
- C<sub>3</sub> — 200- $\mu$ fd. silvered mica.
- C<sub>4</sub> — 25- $\mu$ fd. air trimmer.
- C<sub>5</sub> — 100- $\mu$ fd. midjet variable (tuning).
- C<sub>6</sub> — 20- $\mu$ fd. compensator (see text).
- C<sub>7</sub>, C<sub>8</sub> — 500- $\mu$ fd. mica.
- C<sub>9</sub>, C<sub>10</sub>, C<sub>12</sub>, C<sub>13</sub>, C<sub>16</sub> — 0.0005- $\mu$ fd. mica.
- C<sub>14</sub> — 25- $\mu$ fd. midjet variable.
- C<sub>15</sub> — 100- $\mu$ fd. air padder.
- C<sub>17</sub> — 0.05- $\mu$ fd. paper.
- C<sub>18</sub>, C<sub>19</sub> — 8- $\mu$ fd. electrolytic, 450-volt.
- C<sub>20</sub> — 0-0.05  $\mu$ fd. (see text).
- R<sub>1</sub>, R<sub>2</sub>, R<sub>3</sub>, R<sub>4</sub>, R<sub>5</sub> — 0.1 megohm,  $\frac{1}{2}$ -watt.
- R<sub>6</sub>, R<sub>7</sub>, R<sub>8</sub>, R<sub>9</sub>, R<sub>10</sub> — 50,000 ohms,  $\frac{1}{2}$ -watt.
- R<sub>3</sub> — 500 ohms,  $\frac{1}{2}$ -watt.
- R<sub>5</sub>, R<sub>6</sub> — 1000 ohms,  $\frac{1}{2}$ -watt.
- R<sub>9</sub> — 200 ohms, 1-watt.
- R<sub>10</sub> — 10,000 ohms, 1-watt.
- R<sub>11</sub>, R<sub>14</sub> — 2 megohms,  $\frac{1}{2}$ -watt.
- R<sub>15</sub> — 10,000 ohms, 5-watt.
- L<sub>1</sub> — 45 turns No. 22 enamelled, tapped 15 turns from ground; length  $1\frac{1}{2}$  inches, diameter  $\frac{1}{8}$  inch.
- L<sub>2</sub> — 2.5-mh. r.f. choke.
- L<sub>3</sub> — (3.5-4 Mc.) 34 turns No. 18 d.c.c., length  $1\frac{1}{2}$  inches, diameter  $1\frac{1}{4}$  inches; 4-turn link.
- L<sub>4</sub> — 15 henrys, 60-ma.
- N<sub>1</sub> —  $\frac{1}{4}$  to  $\frac{1}{2}$  watt neon bulb with resistor removed.
- Y<sub>1</sub>, Y<sub>2</sub>, Y<sub>3</sub> — Crystals.
- I<sub>1</sub> — Pilot light.
- J<sub>1</sub> — Closed-circuit jack (keying).
- S<sub>1</sub>, S<sub>2</sub> — D.p. 4-throw rotary switch.
- S<sub>3</sub> — S.p.s.t. toggle.
- S<sub>4</sub> — S.p.s.t. toggle.
- T<sub>1</sub> — Power transformer, 350 volts each side c.t., 100 ma.; with 5- and 6.3-volt windings.

loading on the oscillator were eliminated by using an untuned buffer amplifier lightly coupled to the oscillator circuit. These two expedients, together with complete shielding of the oscillator circuit, have the additional advantage of almost entirely eliminating any effect on the frequency by tuning of subsequent transmitter circuits.

So long as no loading or supply voltage variations are to be permitted, there is no need for tolerating the complications of an electron-coupled oscillator. Accordingly, the 6J5 tube was selected, since it has the lowest inter-electrode capacities of any of the suitable conventional tubes. The metal variety was used, and so mounted that its base pins project into the oscillator compartment, thereby achieving very complete shielding.

Some oscillators are so sensitive to vibration that the family cat tiptoeing across a feather bed will sound like a hammer shop. This condition is caused by poor selection of components, or poor mechanical design. Contrary to popular belief, the answer is not to use large coils, massive condensers and copper tubing connections. Rather, the frequency-determining components should be small and light, and, of course, of good quality. They should be sturdily mounted as compactly as possible, with all leads as short as

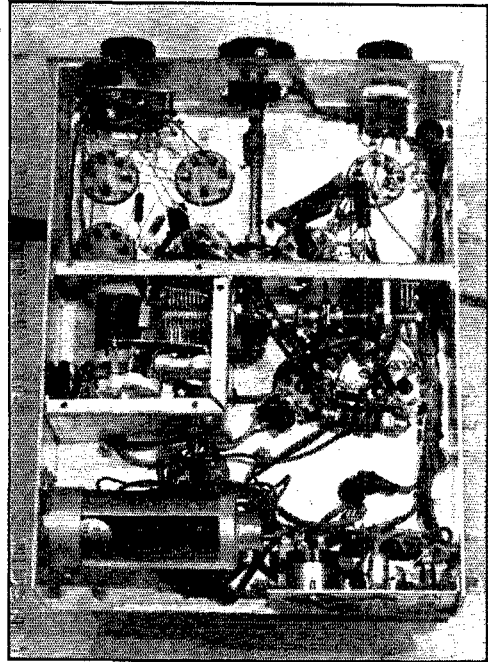

The oscillator circuit is in the small compartment at left center. The oscillator tuning condenser and that of the output stage are ganged together and driven by a worm gear taken from an old b.c. dial unit. Stiff wiring has been intentionally avoided to reduce vibration troubles.

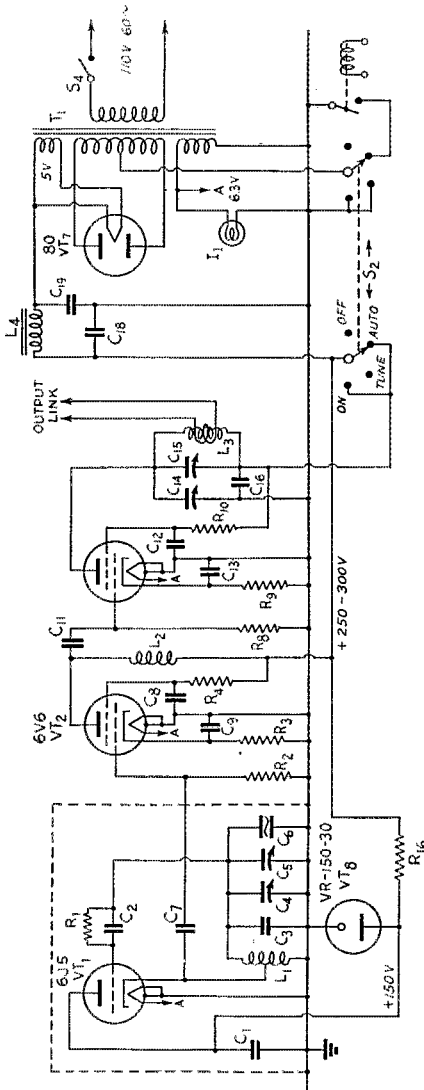
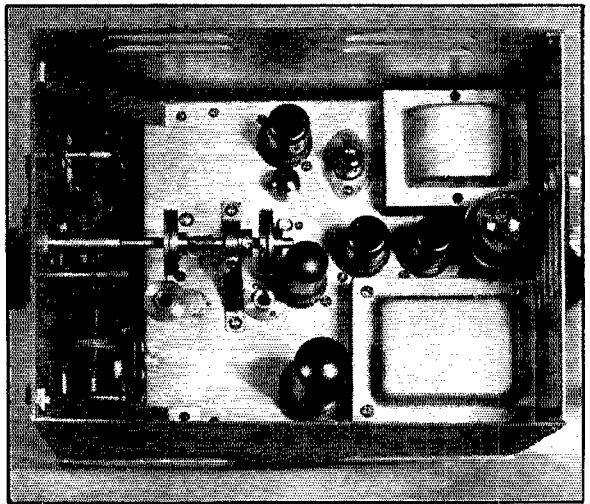

Fig. 2 — Simplified circuit, without crystal oscillator, using gas-tube voltage regulator.

Inside view of W2ACB's unit. Note the spring-loaded drive mechanism which controls the frequency-calibrated dial. The cables connect to a worm shaft below the chassis. No crystal oscillator is included in this unit.



practicable. Bus wire connections with right-angle bends and straight runs like the highways in Kansas look nice, but are susceptible to vibration.

The new wax-treated silver-plated mica fixed condensers, such as Siekles "Silver Caps" and Cornell Dubilier "Silver Mikes" possess about the same electrical stability as air dielectric condensers, and are much easier to mount mechanically. Either may be used for the fixed padders. Large air condensers with thin plates, such as broadcast tuning condensers, are particularly to be avoided because of their large size and poor mechanical stability. The variable condensers in the oscillator circuit should have small, light, stiff plates, wide air gap, and — of course — good bearings.

Plug-in coils and coil-switching devices have never contributed to stability, and should be avoided. With modern tubes, doubler and quadrupler stages are so simple and cheap that there is seldom any need for operating the frequency determining circuit on more than one band.

### Circuit Considerations

With these points in mind, the stabilized oscillator unit shown in the photographs was developed. Referring to the schematic diagram, Fig. 1, the variable oscillator, which covers a frequency range from 1750 to 2050 kc., uses a conventional modified Hartley circuit, with the plate of the tube ( $VT_1$ ) at r.f. ground potential, and the cathode tapped up on the tank coil. The condenser  $C_3$  is the 200- $\mu$ fd. fixed padder,  $C_4$  a 25- $\mu$ fd. variable padder for band setting,  $C_5$  the 100- $\mu$ fd. tuning capacitor, and  $C_6$  the 20- $\mu$ fd. titanium dioxide temperature compensator. Although not shown on the schematic, an additional condenser having a variation of 2 or 3  $\mu$ fd., and readily accessible, is desirable for

◆

A view of the chassis, with the cabinet removed. The power supply is along the rear edge, the regulator tube being beside the 80 rectifier. The tube near the far edge, in front of the power transformer, is the control tube for the regulated supply. The oscillator tube and 6V6 buffer are spaced on either side of the band-setting control, just in front of the power supply. The crystal oscillator and output amplifier are near the front panel.

◆

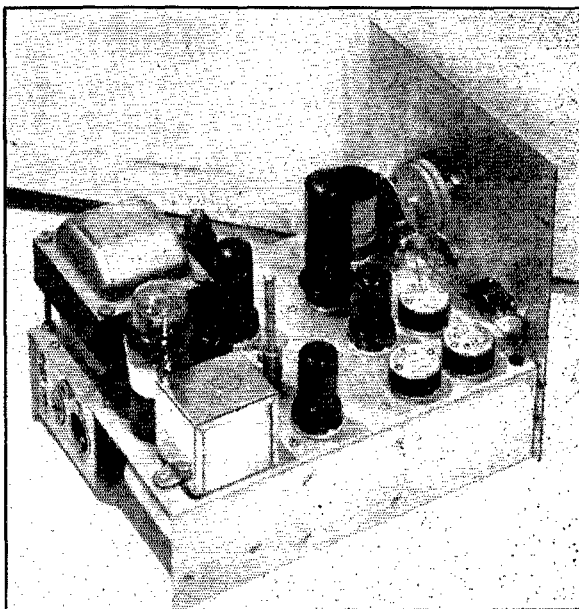

bringing the oscillator back on calibration in case of ageing of components. It can consist of a two-plate double-spaced Hammarlund APC, or can be constructed as shown in Fig. 3.

The coil  $L_1$  must be tightly wound on any available low-loss form (preferably ceramic) of suitable size and must, of course, be mounted rigidly. The size given in the parts list was determined by the form available and was found to be about right.

These oscillator components, together with  $C_1$ ,  $C_2$ ,  $R_1$  and the bottom side of the socket for  $VT_1$ , must be in a shielded compartment. This compartment should be no larger than required to provide space for the components with reasonable clearance, and must be sturdily constructed of at least  $\frac{1}{16}$  inch material.

The oscillator must be lightly loaded for high stability, and it was found that using the oscillator cathode tap as the loading tap provided adequate excitation without too much loading.

$VT_2$  the buffer amplifier, should be so located that its excitation lead can be as short as possible after leaving the oscillator compartment.

There is nothing particularly critical about the remaining circuits. Good practice should of course be followed, but the stability has already been determined when the oscillator section is complete.

The tetrode buffer,  $VT_2$ , is impedance coupled to the grid of  $VT_4$  by means of the untuned choke  $L_2$ , the capacitor  $C_{11}$  and the grid leak  $R_3$ .

The Pierce crystal oscillator  $VT_3$  uses these same coupling components, and is provided with a switch  $S_1$  for selecting any one of three crystals.

A fourth position on the switch disconnects all crystals and grounds the grid. Normal operating cathode bias for the crystal oscillator tube is produced by the voltage drop in  $R_5$ . When the grid is grounded, the voltage drops in both  $R_5$  and  $R_6$  are applied as bias, reducing the plate current to a very low value.

The output tube  $VT_4$  receives its excitation from either the buffer  $VT_2$  or the crystal oscillator  $VT_3$ , and can operate as an amplifier on 1750–2050 kc., or as a doubler with 3500–4000 kc. output. Since its tank circuit has negligible effect on frequency, plug-in coils are used for  $L_3$  to cover these two bands.

The 25- $\mu$ fd. output tuning condenser  $C_{14}$  is ganged with the oscillator tuning condenser  $C_5$  for single-dial control. Those who may have experienced trouble attempting to line up ganged condensers in a receiver may be reluctant to attempt ganging these condensers, but it will be found to be a much simpler proposition, mainly because of the heavy loading on the output tube and the fact that a relatively narrow band is to be covered. As a matter of fact, the coils for the original model were designed with a *Lightning Calculator*, and found to track adequately with no changes. In addition, the 100- $\mu$ fd. padding condenser  $C_{15}$  is brought out to the front panel, making compensation convenient for any mis-tracking or output loading.

Note that the output tuning capacitor  $C_{14}$  has 25- $\mu$ fd. maximum capacity, while the oscillator condenser,  $C_5$ , which is ganged with it, has 100  $\mu$ fd. This does not complicate tracking, with the

(Continued on page 90)

# Portable Kinks

## Useful Circuit and Antenna Ideas

BY HARRY W. DREYER,\* WIANC

**T**HE writer has lived—and operated ham rigs—in about seventeen different locations, principally in New England, Long Island and Chicago, in the past too many years, so that a change of QTH is no longer a thrill. The structures housing the ham equipment have varied from penthouses to one-room cabins in the Maine woods, with excursions into 12-foot row boats and the engine room, 100 feet underground, of a large

as the whole radiating system, and more often than not, if a c.w. man, does not even connect a wire to a “ground” because the rig works FB without it.

Actually the radiating system may be a far-flung network, including everything that has r.f. in it (said r.f. originating somewhere in the rig). We are all familiar with the weird and unwanted lighting up of lamp bulbs on the front porch or even as far removed as on the neighbor's premises. These are examples of extended radiating systems where current maxima happen to come at or near lamps. That they put out our signals to other states, countries and even continents is not questioned, but obviously they are not the most efficient radiating systems that can be devised. And they are usually the finest producers of key clicks and 'phone QRM. So what to do?

Every ham who has done b.c. service work knows that almost any 110-volt b.c. set will bring in husky signals if its “ANT” post is connected to the nearest “ground”—steam radiator, water pipe or sometimes a BX line or gas pipe. In the joy of discovering this cheap antenna it is usually not noticed that such a connection also is most efficient in bringing in all forms of man-made static, clicks, dial-'phone QRM, etc. Look at Fig. 1 and you will see that the chassis is not grounded, and that reception is possible in a way that the designer never intended.

Now this may seem to have little bearing on a ham transmitter installation, but consider Willie Jones who has just moved his 40-watt rig into a new QTH and hitches it to an abandoned b.c.l. antenna about 50 feet long, loads up his final and proceeds to contact the 80-meter c.w. band with good average efficiency and better than good

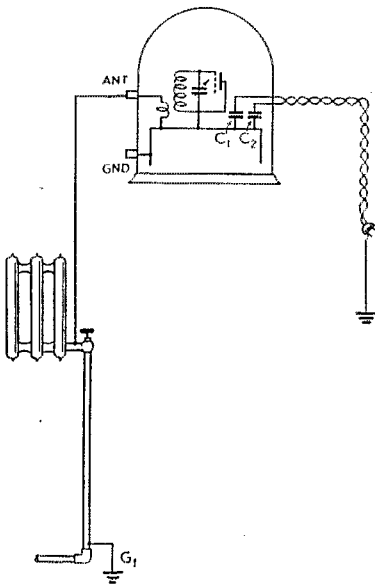

Fig. 1—The traced-out antenna system when the antenna post on a b.c. receiver is connected to a “ground.”  $C_1$  and  $C_2$  are capacities from the primary of the power transformer to core and chassis. Man-made static comes in through the power line and develops a voltage across the antenna coil between chassis and the pipe ground,  $G_1$ .

hotel near Grand Central Station, New York (the antenna was down there, too). Ham radio worked at all these places—some better, some worse, but all better than no hamming at all. The following remarks are the story of a series of things learned in meeting unusual problems offered at various locations.

Probably the first thing that worries the average ham who moves into a new and unusual QTH is the antenna. He usually thinks of the antenna

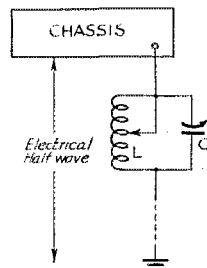

Fig. 2—Tuned ground lead for use where the set is located some distance from the actual ground.

\* 34 Prospect St., Terryville, Conn.



enthusiasm. Let us ask ourselves (but not Willie), what is his radiating system? Well, something less than a quarter wave of it may be on the 50-foot b.c. antenna. Where is the other quarter wave? You can find it if you go looking for it with a sensitive r.f. meter, and if Willie happens to have 400 watts instead of 40 you will find the current maxima lighting up lamps in curious places.

We do not pretend to have a cure-all for all of these troubles, especially those where the radiating portion of the antenna passes over and close to the house, but we have cured some bad ones. Generally the nearest thing to a good ground in any house is the cold water pipe, right where it comes through the cellar wall from the street. As a ground for low frequencies, audio units, power packs and such, a wire run to it will generally be o.k. no matter what its length. But if your antenna feed system is such that the chassis of the final wants to be "hot," a wire to this water pipe will not work if it is more than a couple of feet long. In most cases, just don't ground the chassis, or else ground it through an r.f. choke so it will be an audio ground only. However, one or two cases we have found yielded to the treatment shown in Fig. 2. This is, in effect, a ground wire  $\frac{1}{2}$  wave long and it is a part of the radiating system, but

Almost any title we might pick for this article would fail to give a complete idea of its contents. We'll sum it up by saying that it contains a lot of useful suggestions, chiefly in connection with portable operation under conditions where good antennas cannot be secured, but with other ideas suitable for fixed-station operation as well. You'll be tempted to try them.

perfect, though it may be near enough so that no serious trouble will occur. Few commercial rigs will pass this test.

We want to put the major portion of our r.f. into a radiating system as high and as clear of surrounding objects as possible. But compromises are a part of our daily life, and only experience teaches what violent compromises frequently will work quite well. Often the ham whose family leases a shore cottage for one or two months in the summer leaves all his gear home because the cottage is only one story high — 15 feet, maybe — with no trees near. So he says, "What's the use?" This is an appalling mistake. A QTH near

Fig. 3 — Shore location and antenna of WIANC/1 at Grove Beach Point, 1938 B.H. (before hurricane).

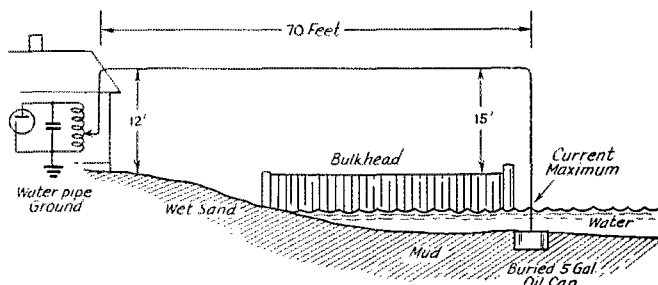

it won't light the neighbor's Mazdas because both ends of it are at zero potential and it transfers no energy into 110-volt mains provided it does not run close to and parallel to an open wire. LC looks like a wave trap but is not. L and C are not the correct values to produce resonance for the signal frequency; they simply combine to form some value of reactance, either inductive or capacitive, which we select by varying them.

When the radiator is fed by a non-resonant transmission line or center-fed by a tuned line these troubles rarely occur. End-fed Zepp jobs often are bad offenders. Single-wire fed doublets also give some trouble. Or any sort of improperly-adjusted antenna and feeder system can do it.

If the radiator is one-half wave or more long, an r.f. ground should not be needed. A good test is to observe whether connecting a ground wire to the chassis of the final changes the r.f. current or voltage materially at any point in the radiating or feeding system. If it does, all is not 100%

salt water is one where great height above ground is distinctly not needed. Look at Fig. 3, a sketch of WIANC/1 on Long Island Sound, one of the best locations we have ever had. The antenna is unorthodox, being grounded at its far end in the waters of the Sound. In addition to working FB, it gave continuous lightning protection and didn't spill any of our precious 20 watts around the surrounding 110-volt lines. With a rig consisting of a 42 e.c.o. and a single 6L6 final at 400 volts, we were able to contact Europe about a half hour before the high-power New York and Long Island boys on 40-meter c.w. On 80 c.w. our reports within sensible distances were S8 and S9. On a sked to Norfolk, Va., at noon on 40-meter c.w. we were always S7.

A different sort of trouble was encountered in a one-room shack in the woods near Ellsworth, Maine. Both transmitter and receiver were operating from a Vibrapack and 6-volt battery, and it seemed impossible to get rid of the vibrator

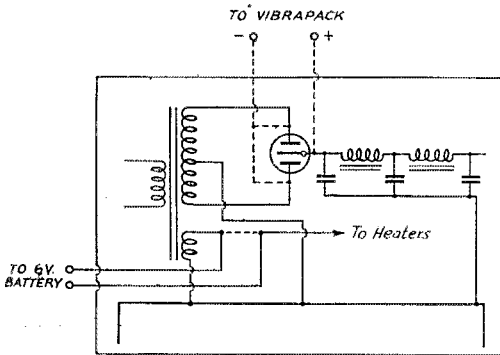

Fig. 4 — Converting a receiver using 6.3-volt tubes to 6-volt battery-vibrator pack operation.

hash because no ground connection was available. You couldn't drive a pointed drill rod into the ground anywhere within shooting distance of the cabin; there was no well, no buried metal pipes, and it was winter so we couldn't bury anything if we had had it. Purely by accident it was found that about 200 feet of antenna wire laid at random on top of the ground, over brush and stumps, gave a ground that removed most of the hash from the pack and also reduced most of the ignition QRM from the gas-driven charger which was our only source of power and light.

The antenna at this location was hung high up in a spruce tree without climbing it. About 175 feet of mason's cord with a 2-pound fishing sinker was laid carefully out on a hard road so that it would not snarl. A couple of husky over-hand swings and a heave put the sinker over a branch about 70 feet from the ground. Some judicious jiggling of the line was needed to get the sinker back down to the ground. Then a length of No. 16 enamelled copper-steel wire was pulled up over the branch, an insulator spliced in, and pulled up to a convenient height. The excess wire coming down from the branch was coiled and fastened at a height and concealed from the local small fry. Many antennas have been put up this way by the writer, who is at the half-century mark in years and not as active in climbing as formerly.

### Receivers and Transmitters

A word now about receivers at portable locations may not be amiss. Many have been described in these pages — good ones all, no doubt — but the author has always wanted his own pet communications receiver to use. It is very easy to do if you have a good 6-volt battery and reliable means of charging it, also a vibrator power-pack — the same one you will use on the transmitter. We happen to have a Hammarlund HQ120, but believe the same remarks apply to all modern communication receivers using 6.3-volt tubes. As shown in Fig. 4, the wiring changes

are amazingly simple, and to change back and forth between 6-volt and 110-volt operation is a matter of seconds. Break in on the heater circuit near the transformer and bring out a pair of wires to two binding posts. Provide a removable jumper (or a switch) to return to 110-volt operation. Next, make up a 4-wire cable, with two of the wires terminating in a tube base of the type that will plug in the rectifier socket in your set (5Z4 in the HQ120). These two wires carry plate voltage to the filter in the receiver, and the other two carry 6-volt current to the heaters. The former two are connected to the prongs going to the two plates (negative) and the heater or filament of the rectifier (positive). No additional filter was necessary on the HQ120. Hash could be heard in the presence of no signal, but did not register on the "S" meter. A signal of even  $\frac{1}{2}$ S was enough to squelch all of the hash. A curious result of this extremely low noise level was noticed in b.c. reception. Good reception during all daylight hours was had from WSB, Atlanta,

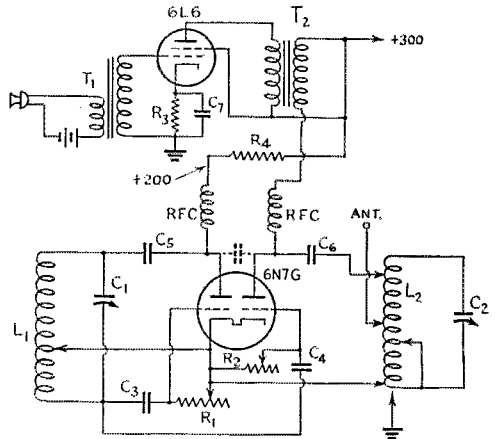

Fig. 5 — A simple portable 160-meter 'phone outfit, using a 6N7G m.o.p.a. and 6L6 modulator. The Hartley oscillator provides neutralizing voltage for the amplifier, using the plate-to-plate capacity of the double triode as a neutralizing condenser. Neutralization is accomplished by adjusting the oscillator cathode tap. C<sub>1</sub>, C<sub>2</sub> — 700- $\mu$ fd. variable (two sections of 350- $\mu$ fd. per section b.c. gang paralleled).

C<sub>3</sub>, C<sub>4</sub> — 250- $\mu$ fd. mica.

C<sub>5</sub>, C<sub>6</sub> — 0.01- $\mu$ fd. mica.

C<sub>7</sub> — 10- $\mu$ fd. electrolytic.

R<sub>1</sub>, R<sub>2</sub> — 50,000-ohm compression-type carbon variable resistors. Fixed resistors may be substituted, after experiment to determine optimum values.

R<sub>3</sub> — 200 ohms, 2-watt.

R<sub>4</sub> — 25,000-ohm variable (adjust for 200 volts on oscillator plate).

L<sub>1</sub> — 25 turns No. 14 enamelled, diameter 1  $\frac{1}{2}$  inches, length 2  $\frac{1}{4}$  inches, with adjustable tap.

L<sub>2</sub> — 30 turns No. 14 bare, diameter 2  $\frac{1}{2}$  inches, length 4 inches, Tappable every turn.

T<sub>1</sub> — S. b. microphone transformer.

T<sub>2</sub> — Output transformer, 1:1 or 1.5:1.

NC — Capacity between plates of 6N7G.

RFC — 2.5-mh. r.f. choke.

whose signal stayed at a constant S2. At night, fading and heterodynes spoiled it badly. Signals on the 28-Mc. amateur band were present 24 hours a day, although after dark only the 4th and 5th districts were heard. Any signal S1 or better was QSA5. No serious attempt was made to log extreme DX sigs because it was during the period of World War No. 2.

Reams have been written about portable transmitters, and ours were not worthy of additional description except as to the output circuit used. Just one transmitter was made, using a 6N7G tube as two triodes in a neutralized m.o.p.a. circuit, with a single 6L6 driven by a carbon mike for the modulator. It is thought that this circuit realizes nearly the maximum stable output on 160-meter 'phone that can be had from one 6-volt battery and vibrator pack. Its circuit is shown in Fig. 5. It will be noticed that the fixed capacity between the two 6N7G plates is used as a fixed neutralizing capacity, adjustment being made by varying the tap on the Hartley oscillator. It worked FB.

#### — And a Flexible Output Circuit

Our only other contribution is a rather unusual and very flexible output circuit which really goes back to the days of spark. But like old Limberger, it is still good. A variation of it is still in use at permanent W1ANC in Terryville, Conn., and is a constant source of amazement to the many visiting hams who are more thoroughly grounded in the more conventional circuits. Fig. 6 is about it. The final is a TZ40 on 160, 80, 40 and as a doubler, weakly, on 20 (60 watts). The tuned circuit is  $L_1$  and the combination of  $C_1$  and the

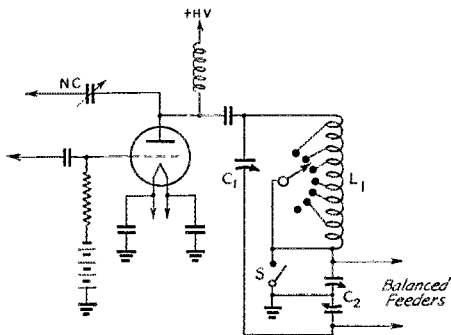

Fig. 6 — Band-switching output circuit for matching a wide range of impedances. The amplifier is grid neutralized, thus avoiding plate-tank complications. Condensers  $C_1$  and  $C_2$  are described in the text. The diagram shows the method of connecting to a two-wire feeder system. For a grounded antenna or single-wire feed, switch S is closed and the antenna or feeder connected to the lower side of  $C_2$ . Loading is adjusted by varying  $C_2$ , the tank being re-resonated by  $C_1$  after each change in  $C_2$ . With tuned feeders, avoid exact multiples of a quarter wave in line length, since these represent points of very high or very low impedance, which are difficult to match. Intermediate lengths can be matched without difficulty.

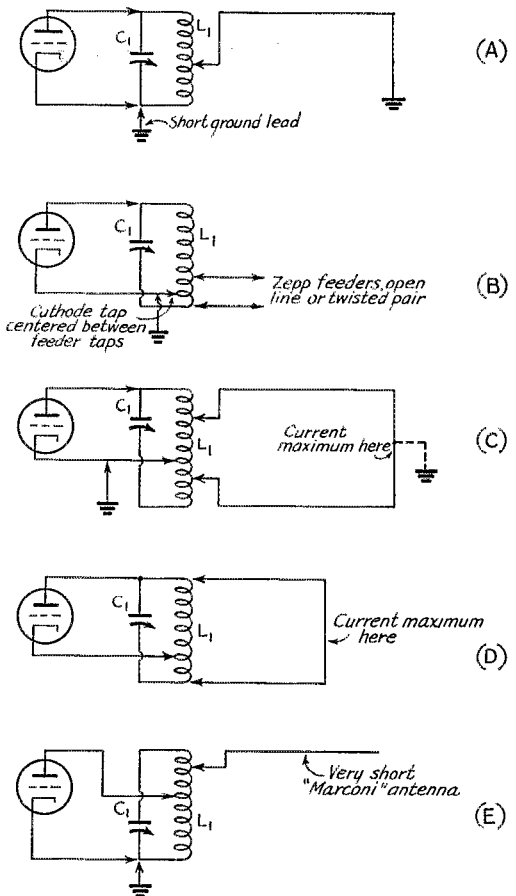

Fig. 7 — Simplified output circuit connected to various types of antennas, mostly unorthodox arrangements used in portable work or where space is quite limited. The tank coil is described in the text. Sufficient tuning condenser capacity should be provided to give about  $2 \mu\text{fd.}$  per meter, since there is no additional selectivity between tank and antenna to suppress harmonics. A  $350\text{-}\mu\text{fd.}$  condenser will serve for 160, 80 and 40 meters. The coil should be wound of bare wire so every turn can be tapped; the smallest Mueller phosphor-bronze test clips are quite satisfactory for the purpose.

When the total length of wire in the loop arrangement, Fig. 7-C, is less than  $\frac{1}{10}$  wavelength, the circuit at 7-D should be used. Fig. 7-E is for extremely short wires, such as a 10-foot antenna used on 1.75 Mc.

two sections of  $C_2$  all in series.  $C_1$  is made from two old Cardwell  $0.001\text{-}\mu\text{fd.}$  (43-plate) b.c. condensers which have been double spaced, ganged and their stators connected in parallel. This results in a good high-voltage condenser of about  $400\text{-}\mu\text{fd.}$  capacity. (Needless to say, this combination has seen service in almost as many other final stages as there are prongs in a rake.)

$C_2$  is a large, wide-spaced 4-gang b.c. con-

(Continued on page 80)

---

# ★ WHAT THE LEAGUE IS DOING ★

---

## SPECIAL ELECTION NOTICE

To all A.R.R.L. members of the Southwestern Division:

You are hereby notified that a special election is about to be held in the Southwestern Division to elect a director to fill the vacancy left by the resignation of Chas. E. Blalack, W6GG, to become vice-president of the League. The election will be for the unexpired remainder of the 1939-1940 term, plus the next regular term of two years, 1941-1942, as provided in By-Law 24.

If more than one eligible candidate is named, voting will take place during the month of September, 1940, on ballots that will be mailed from the headquarters office in late August.

Nomination is by petition. Nominating petitions are hereby solicited. Your attention is invited to the pertinent portions of the Constitution and By-Laws of the League, a copy of which will be mailed any member upon request. Ten or more A.R.R.L. members residing in the Southwestern Division may join in nominating any eligible West Gulf member of the League as a candidate. The following form is suggested:

### Executive Committee

The American Radio Relay League  
West Hartford, Conn.

We the undersigned members of the Southwestern Division, hereby nominate . . . . ., W6 . . . . ., of . . . . ., as a candidate for director from this division for the remainder of 1940 and for the next following full term of 1941-1942.

(Signatures and addresses)

The signers must be League members in good standing. The nominee must have been both a member of the League and a licensed radio amateur operator for a continuous term of at least four years immediately preceding receipt by the Secretary of his petition of nomination, except that a lapse of not to exceed ninety days in the renewal of the operator's license and a lapse of not to exceed thirty days in the renewal of membership in the League, at any expiration of either during the four-year period, will not disqualify the candidate. He must be without commercial radio connections: he may not be commercially engaged in the manufacture, selling or renting of radio apparatus normally capable of being used in radio communication or experimentation, nor commercially engaged in the publication of radio literature intended, in whole or part, for con-

sumption by licensed radio amateurs. Further details concerning eligibility are given in By-Law 12. His complete name and address, and call, should be stated. All petitions must be filed at the headquarters office of the League in West Hartford, Conn., by noon E.S.T. of the 20th day of August, 1940. No member shall append his signature to more than one petition. To be valid, a petition must have the signatures of at least ten members in good standing. Petitioners are urged to have an ample number of signatures, since nominators are frequently found not to be members in good standing.

Balloting will close at noon, October 1, 1940, and the successful candidate will take office as soon as the result can be determined.

This election constitutes an important part of the machinery of self-government in A.R.R.L., and members are urged to take the initiative and file nominating petitions immediately.

For the Board of Directors:

K. B. WARNER,  
*Secretary*

June 4, 1940

## THE 1940 BOARD MEETING

The Board of Directors of the A.R.R.L. came back to Hartford for their 1940 two-day annual session at the end of May. Most of the directors coming in a day early on the Memorial Day holiday, there was time to inspect the headquarters station and the headquarters offices, to pound brass at W1AW, and to play with some of the new gadgets in the QST lab. Then for two days the Board was in executive session, with every director present. Their reports showed continued growth in League membership and activity, a general feeling of satisfaction on the part of amateurs with the way the League has been handling their affairs, and a spirit of unity that we need for the trying days ahead. The minutes of the meeting are here reproduced for your information. A great many things of importance happened and you owe it to yourself to read the minutes carefully because we have space and time here to summarize them but briefly.

The sad state in which the world finds itself these days naturally was reflected in our affairs at this meeting by the Board. The full coöperation of amateur radio is being offered our Government in any way in which it may be needed. All through the Board meeting the feeling kept cropping out that amateur code proficiency was one of the most important things these days, and

the officers of the League were directed to take certain steps that will help amateurs to build up their code proficiency and make them conscious of its great importance. Realizing that things can move very fast at such a time as this, and that multi-men committees and boards might be too slow to deal with an emergency concerning our frequency bands, the Board made a very large grant of powers to the President to act as a committee of one in such a crisis, following a unanimous recommendation to this effect by the Committee on Amateur Frequency Assignments. We hope it will never come to that, but we are ready. Steps were also ordered taken to unite amateur opinion in the two Americas, in keeping with the fact that of major countries it is now only Latin America and ourselves who remain on the air. We need members, too, and every active amateur ought to be a member of the League, that we may move in concert — and so the Board appointed a new Membership Committee to build up League membership.

As usual at Board meetings, the question of 'phone allocation came in for a long consideration. At the end, it was decided to print a proposition in *QST* and take a poll of amateur sentiment on it. It will be printed next month. Briefly, the plan is to see whether you approve widening the 'phone allocation to 3800–4000 kc. and also, separately, whether you approve widening and shifting the 20-meter allocation to 14,000–14,200 kc. If you do, and if the Commission is willing, the Board is disposed to go ahead with the proposals. If you turn them down they will die there — at least for another year.

On the business side, you will remember that the Board last year appointed a committee to engage a firm of business engineers to make a survey of the League headquarters establishment. This job was finished this spring and the report made to the directors. It is only natural that they should have found room for improvement, but in general they found the headquarters highly satisfying and so advised the Board in a report of 67 pages and many tables and charts. This report the Board examined in considerable detail. The pertinent portions of it will be published soon by the Board, probably next issue, for your information. Acting upon a major recommendation of the report, the Board formed a Finance Committee to advise in the establishment of budgets, in approving investments, etc. This committee consists of Mr. Reid, chairman, and Messrs. Blalack and Hill. . . . Also on the business side, the Board again examined proposals for setting up a social security or retirement plan for League employees, who are not covered by the Social Security Act, but again rejected all proposals. . . . Appropriations totaled \$7825, being \$3200 for the cost of the meeting, \$3625 for director expenses in 1941, \$500 for the Finance Committee and \$500 available for sending

SCM's and QSL Managers to their division conventions.

The Chicago gang was again authorized to throw a national convention in the autumn of 1941, subject to some contractual relations yet to be worked out.

The only requests to be made immediately of the F.C.C. are for the repeal of the "nuisance regulation" about every mike-user having to sign the log, and a plea for more examining points, particularly with a view to having one in each state. . . . The Board shelved propositions to ask F.C.C. to open part of the five-meter band for television and part of the ten-meter for f.m.

On the administrative side, the Board examined and rejected a proposal that two of the division directors be selected to double as president and vice-president, but did adopt a provision excluding the president and vice-president from voting on changes of by-laws. They similarly declined to relax eligibility requirements, to authorize official delegates to conventions, and to expand the Royal Order of the Wouff Hong. A few changes in by-laws were made for administrative convenience. For the particular information of our Canadian members we should like to explain that the changes in by-laws concerning Canada are purely for convenience and that they are absolutely without change of effect or intention; in fact, the important two last by-laws are repeated in precisely the former language.

Amateur radio's liaison with the Red Cross was improved by the adoption of an expression of League aims and policies toward the Red Cross, a mutual recognition of the needs and capabilities of both organizations in time of community distress.

In the officers' elections held at the close of its annual meeting, the Board elected George W. Bailey, W1KH, as president of the League, succeeding Dr. E. C. Woodruff, W8CMP. Charles A. Blalack, W6GG, was elected vice-president, assuming the post relinquished by Mr. Bailey.

W1KH, well-known throughout the country because of his frequent appearances at hamfests and conventions, brings to his new post a thorough familiarity with amateur problems resulting from a long and active career on the air, as well as a business background and a personality well-fitted for leadership.

W6GG becomes the first Pacific Coast officer the League has had, and his election is expected to improve East-West liaison in A.R.R.L. affairs. He, too, has a long background of amateur experience and has been active in the Board as director of the Southwestern Division.

Dr. Woodruff, W8CMP, retiring as president after two terms in the chair, was elected to succeed the late Hiram Percy Maxim upon his death in 1936. The second president the League has had in all its quarter-century of existence, Dr. Wood-

ruff has held high the torch of lofty idealism, of unquenchable devotion to the principles of public service and national responsibility, bequeathed him by his predecessor. Handed a hard job made harder by the stature of the man who came before him, he succeeded in it to a degree that only history will reveal. His wisdom and humility, his sincere love for amateur radio and his untiring labors in its behalf, have made him well-loved and long to be remembered.

The minutes follow:

#### MINUTES OF 1940 ANNUAL MEETING OF THE BOARD OF DIRECTORS AMERICAN RADIO RELAY LEAGUE

May 31-June 1, 1940

In compliance with the Constitution and responsive to due notice, the Board of Directors of the American Radio Relay League, Inc., convened in regular annual meeting at The Hartford Club, Hartford, Conn., on May 31, 1940, with Dr. Eugene C. Woodruff, President, in the Chair. The meeting was called to order at 10:03 A.M., Eastern Daylight Saving Time, and the opening roll call showed the following directors present:

Eugene C. Woodruff, President  
George W. Bailey, Vice-President  
Alexander Reid, Canadian General Manager  
E. Ray Arledge, Delta Division  
Charles E. Blalack, Southwestern Division  
Hugh L. Caveness, Roanoke Division  
Ralph J. Gibbons, Northwestern Division  
Glen R. Glasscock, Rocky Mountain Division  
William A. Green, West Gulf Division  
Kenneth T. Hill, Hudson Division  
W. Bradley Martin, Atlantic Division  
J. L. McCargar, Pacific Division  
Percy C. Noble, New England Division  
Floyd E. Norwine, Jr., Midwest Division  
William C. Shelton, Southeastern Division  
Fred W. Young, Dakota Division

Absent, R. H. G. Mathews, Central Division. There were also present Secretary K. B. Warner, Communications Manager F. E. Handy, Assistant Secretary A. L. Budlong and, as technical advisor to the Board, J. J. Lamb, A.R.R.L. Research Engineer. At the invitation of the Board, there was also in attendance as a non-participating observer, Alternate Director Russell Bennett, New England Division. The Chairman read a letter from Treasurer A. A. Hebert, sending his greetings to the Board and regretting his inability to be present because of illness.

On motion of Mr. Caveness, unanimously VOTED that the minutes of the 1939 annual meeting of the Board of Directors are approved in the form in which they were issued by the Secretary.

On motion of Mr. Green, unanimously VOTED that the annual reports of the officers to the Board of Directors are accepted and the same placed on file.

On motion of Mr. Caveness, after discussion, VOTED that all acts performed and all things done by the Executive Committee since the last meeting of the Board, and by it reported to the Board, are ratified and confirmed by the Board as the actions of the Board.

On motion of Mr. Blalack, after discussion, VOTED that the Board, having considered its mail action in which it decided not to call for new elections in the Central, Roanoke and Southwestern Divisions, pursuant to the 1939 revision of By-Law 21, now ratifies the action taken and decides to take this position as of September 18, 1939. Mr. Young requested to be recorded as voting opposed.

On motion of Mr. Green, unanimously VOTED that the Board, having considered its mail action in which it decided to refrain from requesting the Federal Communications Commission to open the frequencies 7200-7300 kc. to A-3 emission, now ratifies the action taken and decides to take this position as of September 29, 1939.

On motion of Mr. McCargar, unanimously VOTED that

the Board, having considered its mail action in which it decided that it had no objection to the opening of 59-60 Mc. to frequency-modulated voice transmission, now ratifies the action taken and decides to adopt this position as of February 19, 1940.

Mr. Bailey reported as chairman of the committee to arrange a business survey of the headquarters organization of the League, making reference to the survey report which had been rendered direct to the directors by Messrs. Booz, Fry, Allen & Hamilton, of Chicago. After extended discussion, on motion of Mr. Green, unanimously VOTED to accept the report of the survey and to discharge the committee with the thanks of the Board.

On the question of the report of the Committee on Amateur Frequency Assignments, on motion of Mr. Caveness, unanimously VOTED that at Chairman Noble's request the receipt of the report goes over until the morrow.

Mr. Martin presented a report as chairman of the Committee on the Royal Order of the Wouff Hong, and Mr. Blalack presented a dissenting report as a member of that committee. On motion of Mr. Green, unanimously VOTED to retain the committee and defer discussion of the subject until General Counsel Segal is present. Mr. Blalack then to have opportunity to present his views anew.

Mr. Reid made an oral report as Canadian General Manager. On motion of Mr. Caveness, unanimously VOTED that in view of the circumstances Mr. Reid's oral report is accepted. During the submission of director reports, Mr. Mathews, delayed en route, joined the meeting, at 11:35 A.M. In turn, every division director read and submitted a written report on conditions in his division.

The Board recessed for luncheon at 12:28 P.M., reconvening at 1:53 P.M. with all directors in attendance except Mr. Norwine, and with all other persons hereinbefore mentioned present.

Proceeding to a consideration of subjects raised by individual directors at their own initiative:

Moved, by Mr. Noble, that the regulations governing the affiliation of clubs with the League be revised to provide that 51% or more of the club members must be licensed amateurs, in addition to the present regulation requiring that 51% of the licensed members be members of the League. But, after discussion, the motion was rejected.

During the foregoing discussion, Mr. Norwine and General Counsel Paul M. Segal joined the meeting, at 1:59 P.M.

Moved, by Mr. Noble, that, in view of the fact that amateur radio in the United States gets a good deal of support from the War and Navy Departments (and that largely because of the amateurs' ability to handle code), and in view of the present action of this government in the matter of national defense, both the Secretary and the Communications Manager be instructed to put on a campaign through the pages of *QST* stressing the importance of the ability to handle fast code, and suggesting that amateurs send as fast, or a trifle faster, than the receiving operator can comfortably copy, for the purpose of increasing his code speed, and that radio clubs cooperate in giving their members the opportunity of increasing their code speed. On motion of Mr. Young, unanimously VOTED to amend the pending motion by substituting the words "code proficiency" for the expression "the ability to handle fast code." After further discussion, the question being on the amended motion, the same was unanimously ADOPTED.

Moved, by Mr. Norwine, that the Federal Communications Commission be requested to expand the 75-meter 'phone allocation to read 3800 to 4000 kc. The Board then engaged in a general discussion of the 'phone allocations in all bands, following which it was moved by Mr. Blalack that the motion be amended by striking out its entire text and substituting the following: "That a poll be taken by including in each copy of *QST* in the August, 1940, issue, a postcard with the return address of the League and the proper questions thereon, covering separately the matter of increasing 'phone frequency to read from 3800 to 4000 kc., and increasing 'phone allocations to read from 14,000 to 14,200 kc. Only votes of U. S. A. licensed amateurs are to be tabulated, and must be received at headquarters by October 1, 1940. If 40% or more of the expressions received are in favor of either or both propositions, the Secretary shall



ascertain how the Federal Communications Commission would regard a formal request from the League on the said subjects. He shall then advise the Board the results both of the poll and of his solicitation of F.C.C. sentiment, and shall seek the further instructions of the Board. That the Secretary is instructed to print in the issue of *QST* carrying the poll an article showing the reasons and justifications for the poll." After further discussion, the yeas and nays being ordered, the said question was decided in the affirmative: Whole number of votes cast, 14; necessary for adoption, 8; yeas, 13; nays, 1. Those who voted in the affirmative are Messrs. Arledge, Blalack, Caveness, Gibbons, Glasscock, Green, Hill, Martin, Mathews, McCargar, Norwine, Shelton and Young. Mr. Noble voted opposed. Messrs. Woodruff, Bailey and Reid abstained. So the motion was amended. The question then being on the adoption of the amended motion, and the yeas and nays again being ordered, the said question was decided in the affirmative: Whole number of votes cast, 14; necessary for adoption, 8; yeas, 8; nays, 6. Those who voted in the affirmative are Messrs. Arledge, Blalack, Hill, Mathews, McCargar, Norwine, Shelton and Young. Those who voted opposed are Messrs. Caveness, Gibbons, Glasscock, Green, Martin and Noble. Abstentions: Messrs. Woodruff, Bailey and Reid. So the poll was ordered in the language proposed.

At the instance of Mr. Gibbons, the Board proceeded to an examination of the report of the survey of the headquarters organization. On motion of Mr. Gibbons, ORDERED that Messrs. Handy, Budlong, and Lamb retire from the meeting. After discussion, on motion of Mr. Mathews, VOTED that the Board of Directors shall appoint a Finance Committee, in accordance with the recommendations of the survey, page 61, to act in an advisory capacity in the establishment of expense budgets and the results obtained in comparison to those budgets, and to approve investments and otherwise provide a check on the responsibilities of the Treasurer and of the Secretary; the committee to consist of three members elected by the directors from amongst their

own number, and to serve for one year. On motion of Mr. Gibbons, the Board proceeded to the selection of a committee by ballot. Mr. Mathews nominated Messrs. Blalack, Caveness and Reid. Mr. Caveness withdrew his name. Mr. Noble nominated Mr. Bailey. Mr. McCargar nominated Mr. Hill. The Chairman appointed Mr. Segal as teller to canvass the balloting. The result was the selection of the following committee: Mr. Reid, chairman; Mr. Blalack; Mr. Hill.

On motion of Mr. Noble, after discussion, VOTED that A. A. Hebert having retired as office manager and manager of credits & collections on the Secretary's staff, his salary as Treasurer of the League is fixed at \$2000 per year, effective June 1, 1940. Mr. Gibbons requested to be recorded as voting opposed.

The Board was in recess from 5:05 P.M. to 5:16 P.M.

After further extended discussion of the survey report, on motion of Mr. Gibbons, unanimously VOTED that the members of the Board are authorized to make this report available to any member of the League upon request.

At this point Messrs. Handy, Budlong and Lamb rejoined the meeting at the request of the Board.

Moved, by Mr. McCargar, to amend certain portions of the Constitution & By-Laws to read respectively as follows:

Section 2, Article III, Constitution: The President and Vice-President shall be elected by the Board of Directors from among their number and shall hold office for two years, or until their successors are elected and qualified, provided they continue to be members of the Board of Directors. The Secretary, The Communications Manager and the Treasurer shall be appointed by the Board of Directors.

Section 1, Article IV, Constitution: The affairs of the League shall be managed by a Board of Directors under the Constitution & By-Laws and the general provisions of the laws under which it is incorporated. The Board of Directors shall consist of one Director from



*The A.R.R.L. Board of Directors at Hartford, June 1, 1940*

The retiring president, Dr. Eugene C. Woodruff, W8CMP, stands in the front center.

each of the several territorial divisions of the League in the United States and Possessions, elected by the members of the League thereof, and a Canadian General Manager.

By-Law 25: The President and Vice-President of the League shall be elected by the Board of Directors at their annual session in presidential election year.

By-Law 26: The President and Vice-President shall be elected at the annual session of the Board of Directors held in each even-numbered year. Their terms of office shall begin at the conclusion of the meeting at which they are elected and shall continue for two years, or until their successors are duly elected and qualified, provided they continue to be members of the Board of Directors.

After discussion, the yeas and nays being ordered, the said question was decided in the negative: Whole number of votes cast, 15; necessary for adoption, 12; yeas, 2; nays, 13. Messrs. McCargar and Reid voted in the affirmative. Those who voted opposed are Messrs. Arledge, Blalack, Caveness, Gibbons, Glasscock, Green, Hill, Martin, Mathews, Noble, Norwine, Shelton and Young. Messrs. Woodruff and Bailey abstained. So the motion was lost.

Moved, by Mr. McCargar, that each A.R.R.L. affiliated club and/or A.R.R.L. section be authorized to send to its division convention one delegate for each twenty-five club or League members or fraction thereof, such delegation to carry to the convention any resolutions or other matters for consideration by the convention, and to speak for the club during discussions on resolutions. But, after discussion, the said motion was rejected.

Moved, by Mr. McCargar, that By-Law 12 be amended to provide that, amongst those declared to be eligible for directors, are "Persons conducting small service businesses that repair and service broadcast-listener receivers, or employees of such servicing businesses, provided they do not service or handle amateur equipment." After discussion, the yeas and nays being ordered, the said question was decided in the negative: Whole number of votes cast, 15; necessary for adoption, 12; yeas, 2; nays, 13. Messrs. Arledge and McCargar voted in favor. Those who voted opposed are Messrs. Blalack, Caveness, Gibbons, Glasscock, Green, Hill, Martin, Mathews, Noble, Norwine, Reid, Shelton and Young. Messrs. Woodruff and Bailey abstained. So the motion was lost.

The Board recessed for dinner at 6:42 P.M., reconvening at 8:05 P.M., with all directors and other persons hereinbefore mentioned in attendance.

Moved, by Mr. McCargar, that By-Law 54 be amended to read as follows:

54. These By-Laws may be amended in any part by a two-thirds vote, to be determined by yeas and nays, of the entire membership of the Board of Directors, excepting the President and Vice-President, at any meeting; or, provided due notice of such proposed amendment shall have been submitted every Director at least sixty days in advance, they may be amended by a two-thirds vote, to be determined by yeas and nays, of the Directors present at any meeting, excepting the President and Vice-President, a quorum being present and voting. They may not be suspended except in the particular cases provided for in the By-Laws themselves.

The yeas and nays being ordered, the said question was decided in the affirmative: Whole number of votes cast, 15; necessary for adoption, 12; yeas, 12; nays, 3. Those who voted in the affirmative are Messrs. Arledge, Blalack, Caveness, Gibbons, Martin, Mathews, McCargar, Noble, Norwine, Reid, Shelton and Young. Those who voted opposed are Messrs. Glasscock, Green and Hill. Messrs. Woodruff and Bailey abstained. So the by-law was amended as proposed. Mr. McCargar requested the Secretary to make record of his proposal to amend Article VII of the Constitution in the same manner at the next meeting of the Board.

On motion of Mr. Glasscock, unanimously VOTED that the Communications Manager is directed to provide the directors a summary of the results of the frequency-measuring tests of Official Observers after each test.

On motion of Mr. Glasscock, unanimously VOTED that the President is directed to appoint a committee of three members of the Board as a Membership Committee, to increase League membership.

Moved, by Mr. Glasscock, that there be included in the poll of amateur sentiment hereinbefore provided, the question of moving the 14-Mc. phone allocation to the high-frequency end of the band instead of the low-frequency end. But, after discussion, the motion was rejected.

Moved, by Mr. Shelton, that the Federal Communications Commission be requested to open part of the five-meter band to television. At the request of the Board, Mr. Lamb discussed the technical implications. But, after further discussion, the motion was rejected.

On motion of Mr. Shelton, unanimously VOTED that the League, through its Secretary, shall work towards the establishment of a F.C.C. examining point in every state, the objective being the eliminating of the large numbers of Class C licenses now existing.

Moved, by Mr. Shelton, that the Section Communications Manager be allowed to meet with the director in joint meeting at the expense of the League, in lieu of attendance at state or division conventions, this meeting to be held directly before the Board meeting. But, after discussion, the said motion was rejected, 5 votes in favor to 9 opposed.

Moved, by Mr. Blalack, that that section of the By-Laws appearing under the heading "Canada" and now comprising By-Laws 28 to 36, inclusive, be simplified to read as follows:

#### CANADA

28. A Canadian General Manager and an alternate shall be elected in each odd-numbered year. All the provisions of these By-Laws affecting or governing directors and alternate directors from the divisions of the League in the United States and Possessions shall apply to the Canadian General Manager and his alternate; provided, however, that the holders of these offices, and their nominators, and any petitioners for a witness to the counting of the ballots, and any such witness, and any petitioners for removal, and any committee members or assistants appointed by the Canadian General Manager, must be Canadian members of the League.

29. The Canadian General Manager shall be a member of the Board of Directors. He shall be the liaison officer of the League between the Board of Directors and its Canadian members. He shall have general supervision of League activities in Canada and shall be responsible to the Board of Directors for League welfare in all matters in Canada. He shall keep himself informed on conditions and activities in Canada and on the needs and desires of League members therein, that he may faithfully and intelligently represent them in the Board of Directors. He shall, so far as able, attend all meetings of the Board of Directors. At each annual meeting of the Board, he shall present a written report on the status of the affairs of the League in Canada.

30. The policy of the League in Canada shall be that of a friendly hand for the amateurs of a sister country pending their growth to such numbers and strength that their ability to form and conduct a self-governing non-commercial amateur organization throughout the Dominion is evident. The activities of the League in Canada shall be regarded as a temporary stewardship undertaken at the request of Canadian amateurs. Whenever Canadian amateurs shall petition for their own organization, and it is manifest to a majority of the entire Board of Directors that the success of a separate Dominion organization is assured, the Board of Directors shall aid in establishing and proclaiming a separate all-Canadian organization to be known as the Canadian Radio Relay League to operate under a constitution similar in tenor to that of this League; and this League shall thenceforth relinquish all direct activity in Canada.

The yeas and nays being ordered, the said question was decided in the affirmative: Whole number of votes cast, 15; necessary for adoption (in view of the amendment of By-Law 54), 10; yeas, 15; nays, 0. Every director voted in the

affirmative, except the President and Vice-President. So the by-laws were amended as proposed.

Moved, by Mr. Blalack, that in the two places each in By-Laws 21 and 31 where there is reference to a period of two months, the word "two" be changed to "three." The yeas and nays being ordered, the said question was decided in the affirmative: Whole number of votes cast, 15; necessary for adoption, 10; yeas, 15; nays, 0. Every director voted in the affirmative, except the President and Vice-President. So the by-laws were amended as proposed.

Moved, by Mr. Blalack, that the Board approve a tryout in the Southwestern Division of the plan submitted for the expansion of the Royal Order of the Wouff Hong as a more active function of the League; that the sum of \$250 be appropriated for the tryout under the terms and conditions set forth in the plan; that the Treasurer of the League be appointed as the executive secretary-treasurer; that Directors McCargar, Norwine and Blalack be appointed a committee to make such minor changes in the plan as they deem necessary before the same is put into operation. But, after discussion, the said motion was rejected.

The Board adjourned at 9:02 P.M. under order to reconvene at the same place at 9 A.M. on the morrow. The Board did reassemble at the same location on June 1, 1940, and was called to order at 9:20 A.M. with all directors in attendance except Mr. Arledge, and all other persons hereinbefore mentioned except Mr. Segal.

Continuing in a consideration of matters raised by individual directors at their own initiative:

On motion of Mr. Green, after discussion, unanimously VOTED that the Board of Directors shall publish in *QST* the substance of the findings of the recent survey of headquarters, for the information of the membership.

On motion of Mr. Green, unanimously VOTED that, as a matter of A.R.R.L. policy, the General Manager shall offer to our Government the full cooperation of amateur radio in any national emergency, in whatever manner they deem best.

On motion of Mr. Green, unanimously VOTED that the sum of five hundred dollars (\$500) is hereby appropriated from the surplus of the League, as of this date, for the use of the Finance Committee, any unexpended remainder of this sum on the date of the next annual Board meeting to be returned to surplus.

On motion of Mr. Green, VOTED that the General Manager is instructed to have some one of his staff concentrate very strongly on the Latin-American amateur situation, in order to unite amateur opinion in the two Americas.

Director Arledge and Mr. Segal joined the meeting at 9:58 A.M.

Moved, by Mr. Green, that the Board set up a committee to study the advisability of streamlining our organization, speeding up its actions, possibly eliminating the Executive Committee; and to draw up legislation to that effect and to see that it is presented sixty days prior to the next Board meeting. But, after discussion, the said motion was rejected.

At the request of Mr. Green, unanimous consent was given Mr. Handy to outline recent relations with the American Red Cross. After discussion, on motion of Mr. Green, unanimously VOTED that the following statement of an understanding negotiated by Mr. Handy with the Red Cross is adopted as an expression of League aims and official policy towards the American Red Cross:

The purpose of this understanding between the American Red Cross and the American Radio Relay League is to secure maximum cooperation in time of disaster.

The Board of Directors of the American Radio Relay League at its meeting June 1, 1940, considered the relationships of the American amateur radio fraternity with the American Red Cross in time of disasters involving disruption of communication.

The American Radio Relay League recognizes the American Red Cross as the agency chartered by Congress to represent the American people in carrying on disaster relief and therefore as the primary agency.

The American Red Cross recognizes that amateur radio service, because of its excellent geographical station coverage, and especially the available stations

possessing emergency power supply, can render valuable aid in reestablishing communication when other facilities have been disrupted.

The American Red Cross welcomes the cooperation of the American Radio Relay League with local Red Cross chapters to extend radio planning into chapter jurisdictions and to correlate radio amateur operations to assure the best possible communications by such facilities. The cooperation with American Red Cross chapters may be furthered by individual chapters' designation of an American Radio Relay League Emergency Coördinator to serve as a member of the Red Cross Chapter Sub-Committee on Transportation & Communication as recommended in the Chapter Disaster Preparedness & Relief Manual, ARC 209.

On motion of Mr. Mathews, after discussion unanimously VOTED that the Secretary is instructed to recommend to the Federal Communications Commission the striking out of that part of paragraph b of F.C.C. Rule 152.45 which relates to the signing of the log of an amateur 'phone station by all persons using the microphone.

On motion of Mr. Mathews, after discussion, unanimously VOTED that the Board of Directors authorizes the Chicago Area Radio Club Council to hold an A.R.R.L. national convention in Chicago in the fall of 1941, subject to the terms of a satisfactory contract to be executed between the Council and the League, similar in tenor to that for the 1938 national convention.

On motion of Mr. Mathews, VOTED that the Secretary is instructed to give serious consideration to the many detailed recommendations of the organization survey and particularly to the matter of inefficient layout of office space, looking forward to the possibility of rearrangement at the time of lease renewal.

On motion of Mr. Young, affiliation was granted the following societies, whose applications had been investigated and approved by the respective division directors:

Amateur Radio Club of Savannah . . . . .	Savannah, Ga.
Cahokia Amateur Radio Club . . . . .	East St. Louis, Ill.
Toledo Radio Club . . . . .	Toledo, Ohio
Nashville Society of Licensed Radio Amateurs . . . . .	Nashville, Tenn.
Freehold Amateur Radio Club . . . . .	Freehold, N. J.
Western Maryland Amateur Radio Club . . . . .	Cumberland, Md.
Clayton Radio Club . . . . .	Clayton, N. Y.
Central Nebraska Radio Club . . . . .	Grand Island, Nebr.
Muskingum Amateur Radio Association . . . . .	Zanesville, Ohio
Kenosha Kilocycle Club . . . . .	Kenosha, Wis.
The Amateur Radio Researchers . . . . .	Los Angeles, Calif.
Young Ladies' Radio League . . . . .	Bowbells, N. Dak.
Glendale Amateur Radio Society . . . . .	Glendale, Calif.
Wall Street Radio Club . . . . .	New York City

Moved, by Mr. Arledge, that a permanent advertising committee of three members elected from members of the Board by the members of the Board be elected each year and to serve until the following Board meeting for the purpose of passing on the eligibility of advertisers to the columns of *QST* when and before any advertiser is rejected by the Secretary or advertising manager; a vote of two to one being final. Extended discussion ensued, after which, the yeas and nays being demanded, the said question was decided in the negative: Whole number of votes cast, 15; necessary for adoption, 8; yeas, 6; nays, 9. Those who voted in the affirmative are Messrs. Arledge, Blalack, Mathews, McCargar, Shelton and Young. Those who voted opposed are Messrs. Caveness, Gibbons, Glascock, Green, Hill, Martin, Noble, Norwine and Reid. So the motion was lost.

Moved, by Mr. Arledge, that the sum of five hundred dollars (\$500) be hereby appropriated from the surplus of the League, as of this date, for the purpose of defraying the traveling expenses of the Section Communications Managers of the League, within the continental limits of the United States, to attend one official A.R.R.L. convention within their respective divisions in the period between this date and the date of the next annual meeting of the Board; and for the further purpose of defraying traveling expenses of the



A.R.R.L. President  
George W. Bailey  
W1KH

QSL Managers of the League, within the continental limits of the United States, to attend one official A.R.R.L. convention within the call areas for which they are the respective QSL Managers during the time between this date and the date of the holding of the next annual meeting of the Board, provided that such convention be within a radius of 500 miles from the QSL Manager's place of residence; reimbursement to be made at the rate of two cents per mile via the shortest commonly-traveled route, plus one night's hotel accommodation at \$2.50, and an allowance of \$2.00 for convention registration fee; allowance of these expenses to be subject to approval by the Communications Manager upon examination of detailed report of the activities of the Section Communications Manager or QSL Manager at each such convention, to be submitted with his expense account; and any unexpended remainder of this appropriation at the date of the holding of the next annual meeting of the Board to be restored to surplus. Moved, by Mr. Young, to amend the motion by striking out the provision for QSL Managers; but the said motion was rejected, 5 votes in favor to 9 opposed. On motion of Mr. Martin, unanimously VOTED to amend the motion to substitute the word "the" for the words "\$2.00 for," so that the full amount of the convention registration fee is allowed. Moved, by Mr. Martin, further to amend the motion to provide an allowance of the railroad coach fare instead of two cents per mile; but the said motion was rejected. The question then being upon the adoption of the motion as amended in respect of the convention registration fee, the same was thereupon ADOPTED.

Moved, by Mr. Gibbons, that there be hereby appropriated from the surplus of the League, as of this date, the sum of three thousand two hundred dollars (\$3200) for the purpose of defraying the expenses of holding this meeting of the Board of Directors, any unexpended remainder of the sum to be restored to surplus. Moved, by Mr. Young, to amend the motion to provide that the Secretary be instructed to report to the directors the expenses of each director. Ruled, by the Chair, that the proposal for amendment is out of order but would be entertained later as a separate motion. Whereupon, the question being upon Mr. Gibbons' motion, the same was unanimously ADOPTED.

The Board recessed for luncheon at 12:25 P.M., reconvening at 1:50 P.M. with all directors and other persons hereinbefore mentioned in attendance.

Mr. Noble presented a unanimous report of the Committee on Amateur Frequency Assignments. On motion of Mr. Norwine, unanimously VOTED to accept the report as read and place the same on file.

Pursuant to the foregoing report, on motion of Mr. Noble, after discussion of the problem of preserving amateur rights in the present situation, unanimously VOTED (1) that the Board of Directors makes an open authorization of ten thousand dollars (\$10,000) for the defense of amateur frequencies; and (2) that the President of the League is appointed as a committee of one with full power to act at his own discretion and without supervision in the expenditure of this fund, without liability as to anything except misappropriation; and (3) that the President is requested, but not bound, to use the services of Messrs. Warner and Segal at any stage he may think necessary; and (4) if, in the judg-

ment of the President, anything needs to be done, he is fully authorized by the Board—without consultation with it—to speak for and on behalf of the Board in all aspects of protecting amateur operation.

On motion of Mr. Caveness, after discussion, unanimously VOTED that the sum of three thousand six hundred and twenty-five dollars (\$3625) is hereby appropriated from the surplus of the League, as of January 1, 1941, for the legitimate administrative expenses of directors in the calendar year 1941, said amount allocated to the Canadian General Manager and to the division directors as follows:

Canadian General Manager . . . . .	\$ 250
Atlantic Division Director . . . . .	200
Central Division Director . . . . .	450
Dakota Division Director . . . . .	225
Delta Division Director . . . . .	250
Hudson Division Director . . . . .	200
Midwest Division Director . . . . .	225
New England Division Director . . . . .	175
Northwestern Division Director . . . . .	250
Pacific Division Director . . . . .	250
Roanoke Division Director . . . . .	200
Rocky Mountain Division Director . . . . .	200
Southeastern Division Director . . . . .	200
Southwestern Division Director . . . . .	250
West Gulf Division Director . . . . .	300
	\$3625

any unexpended remainders of these funds at the end of the year 1941 to be restored to surplus.

On the question of the desirability of requesting that a portion of the 10-meter band be opened to frequency-modulated transmission, on motion of Mr. Caveness the subject was laid on the table.

On motion of Mr. Green, after discussion, unanimously VOTED that the Planning Committee is continued, with a vote of thanks from the Board to its present members.

On motion of Mr. Hill, unanimously VOTED that consent is given the Secretary to present data on a retirement plan for headquarters employees. The Secretary recalled his discussion of this question in his annual report, and presented a plan based upon an arrangement with an insurance company, the annual cost of which to the League would be approximately \$2400. Moved by Mr. Norwine, that the Board authorize the institution of the plan as submitted. But, after discussion, unanimous consent being given, Mr. Norwine withdrew the motion and moved that the sum of not to exceed three thousand dollars (\$3000) per year be placed at the disposal of the Executive Committee for the effectuation of a suitable retirement plan. But, after further discussion, the motion was rejected, 5 votes in favor to 10 opposed.

Moved, by Mr. Blalack, that directors' annual reports be submitted to headquarters four weeks before the annual meeting; that headquarters make copies of same and mail to each director copies of all reports, so that the same shall be received by the individual directors at least two weeks before the annual meeting. But, after discussion, the motion was rejected, 7 votes in favor to 8 opposed.



A.R.R.L.  
Vice-President  
Charles E. Blalack  
W6GG

## OFFICERS' REPORTS AVAILABLE TO MEMBERS

In April of each year the officers of the League make comprehensive written reports to the Board of Directors. The Board of Directors has made these reports available to the membership of the League. Interested members may obtain copies post-paid at the cost price of 50¢ per copy. Address the Secretary at West Hartford.

On motion of Mr. Young, unanimously VOTED that the Secretary is instructed to prepare a statement of the expenses of each person connected with the 1940 meeting of the Board and send it to all directors after the expenses are all determined.

Moved, by Mr. Noble, that one page of *QST* be devoted each month to emergency work — including rules for procedure and names of county and community coordinators. After discussion, with unanimous consent, Mr. Noble simplified the motion to provide that one page of *QST* be devoted each month to emergency work. But, after further discussion, the motion was rejected.

On motion of Mr. Caveness, after discussion, unanimously VOTED that the 1941 annual meeting of the Board shall be held in Hartford on Friday and Saturday, May 9th and 10th.

Proceeding to the election of president and vice-president, on motion of Mr. Mathews, two-thirds concurring, Special Rule A was suspended. The Chair appointed Alternate Director Bennett and General Counsel Segal as Tellers. By special order of the Board, secret written nominations were made.

Nominations for president being in order, the Tellers announced that those nominated were Mr. Woodruff, Mr. Bailey and Fred H. Schnell of Chicago. The vote was then taken and the result of the ballot was announced by the Tellers as follows:

Whole number of votes cast, 15  
Necessary for election, 8  
For Mr. Bailey, 11  
For Mr. Schnell, 1  
For Mr. Woodruff, 3

Mr. Bailey, having received a majority of the votes cast, was thereupon declared elected president of the League, for a term of two years.

Proceeding to the election of a vice-president, those nominated were Messrs. Blalack, Caveness, Reid, Schnell, Segal and Woodruff. The vote having been taken, the result of the first ballot was announced by the Tellers as follows:

Whole number of votes cast, 13  
Necessary for election, 7  
For Mr. Blalack, 5  
For Mr. Caveness, 2  
For Mr. Reid, 2  
For Mr. Woodruff, 4

No candidate having received a majority, a second ballot was ordered, the result of which was announced as follows:

Whole number of votes cast, 13  
Necessary for election, 7  
For Mr. Blalack, 6  
For Mr. Caveness, 1  
For Mr. Reid, 1  
For Mr. Woodruff, 5

No candidate having received a majority, a third ballot was ordered, the result of which was announced as follows:

Whole number of votes cast, 13  
Necessary for election, 7  
For Mr. Blalack, 7  
For Mr. Woodruff, 6

Mr. Blalack, having received a majority of the votes cast, was thereupon declared by the Tellers to be elected vice-president of the League for a term of two years.

On motion of Mr. Gibbons, the Board rose in token of appreciation of the splendid services of Dr. Woodruff to the League. (Applause.) Mr. Bailey spoke briefly in appreciation of the honor shown him by his election.

On the joint motion of Messrs. Mathews and Gibbons, the Board adjourned, sine die, at 4:58 p.m.

(In the course of its deliberations the Board also discussed, without formal action, an appeal by K6NYD in the matter of the 1939 DX Contest, communication with the Byrd Antarctic Expedition, code tests from W1AW, F.C.C. monitoring work, headquarters movie, b.c.l. image interference, emergency nets not devoted entirely to amateur activity, DX Contest rules, *QST* articles on home recording, the extension of Class A to the 160-meter band, automatic issuance of Class A after holding Class B three years, and the work of the Planning Committee. Total time in session, 14 hours, 13 minutes. Total appropriations, \$7825.)

K. B. WARNER,  
Secretary.

## Strays

W5ITX, who received his call on his fortieth birthday says, "Life begins at 40." — W5NW.

## Silent Keys

It is with deep regret that we record the passing of these amateurs:

Robert A. Bradley, W8HB, Fleetwood, N. Y.

Thomas W. Burnette, W4FUR, Birmingham, Ala.

Frank V. Cantwell, Jr., W3FNN, Trenton, N. J.

William H. Glander, W2GCY, Newark, N. J.

William Hartwell Harrison, Jr., KB6SQU, Guam

Gerald W. Herrmann, W7DCR, Oregon City, Ore.

Jack R. Kean, VE3ADU, Windsor, Ontario

John J. Long, Jr., W8ABX, Brighton, N. Y.

William Lowry, VE5DG, Pouce Coupe, B. C.

Lt. Charles H. Martin, W5IQS, ex-W9EQ, Ft. Worth, Texas

Col. L. Martin, ON4LM, Bruges, Belgium

Orison McCord, W2LBX, Jamaica, N. Y.

Charles W. McCracken, W9EUI, David City, Neb.

Paul C. Monroe, W8LPA, Mt. Vernon, Ohio

Wilbur Webb Ramage, W7EN, Salem, Ore.

Loren Willing Wood, ex-9EKF, Joliet, Ill.

# Counting Words Per Minute Electrically

*A Combination Audio Oscillator and Counter for Code Practice*

BY M. J. LARSEN\*

THE device described herein was built as an aid for code instruction. The average speed in words per minute is indicated by a meter to enable the sender to keep a continuous check on his rate. For convenience, a code oscillator and power supply are included on the same chassis.

## Principle of Operation

The principle of operation of the counter may be explained with reference to the circuit diagram of Fig. 1. The key operates relay 1. One lever of this relay operates the oscillator. The other lever is connected to the grid of  $V_2$ , a 2A3, which operates relay 2. Between characters the key is open, levers of relay 1 released, and the grid of  $V_2$  approaches the cathode potential as  $C_1$  discharges through  $R_1$ . This activates relay 2. When the key is down condenser  $C_1$  is charged very quickly through the lower resistance,  $R_2$ , the grid goes to ground potential and relay 2 releases, since the cathodes of the 2A3's are positive. By proper adjustment of  $R_1$ , relay 2 is activated only between characters and not between the dots and dashes of the character.

On the break of relay 2, the small condenser  $C_2$  is charged by a 200- to 300-volt supply. On the make of relay 2 this charge is transferred to condenser  $C_3$ . The network composed of  $C_3$ ,  $C_4$ ,  $C_5$  and  $R_3$ ,  $R_4$  acts as a low-pass filter so that the average charge and discharge current from  $C_3$  flows through the grid resistors of the 6A6 with but very little pulsating component. Because of the values selected for the capacitances and resistances of the filter,  $C_3$  does not rise to more than a few volts, say 6 volts, with a medium sending rate. Thus  $C_2$  discharges from about 300

volts down to about 6 volts on each impulse of the relay. That is,  $C_2$  transfers very nearly all of its charge to  $C_3$  between each character. The charge transferred per second, then, which represents the average current flowing from  $C_3$ , is  $Q_2f$  where  $f$  is the number of characters per second. The average current flowing through  $R_3$  and  $R_4$  is  $Q_2f$  or  $C_2Ef$ , where  $E$  is the charging potential of  $C_2$ . The potential appearing between the two grids of the 6A6 is simply this current times the combined grid resistance or

$$2E_o = C_2Ef \left( \frac{R_7(R_8 + R_6)}{R_5 + R_8 + R_7} \right). \text{ (Approx.)}$$

The grid voltage, then, can be fixed roughly by adjustment of  $C_2$  and  $E$  for a given rate, while the finer adjustment can be taken care of by  $R_7$ .

The 6A6 operates the microammeter  $M$  through a direct-current type of push-pull arrangement. The bias required for the 6A6, supplied by the 6H6, is not critical, although one particular bias for a given plate supply will produce the most linear relationship between  $E_o$  and current through the meter. If the elements of the 6A6 are balanced, the meter will indicate zero with no signal on the grids. If the elements are not balanced, adjustment can be made by substituting a variable resistance for either  $R_8$  or  $R_9$ .

## Calibration

The counter was constructed to operate a 0-1 milliamperere direct-current meter. Calibration was made on the basis of 5 characters per word. For 20 words per minute, therefore, the number of impulses per second,  $f$ , becomes 1.67. Adjustments of  $C_2$ ,  $E$ , and  $R_7$ , as given in the above equation, were made so that full scale on the

\*Instructor in Electrical Engineering, Michigan College of Mining and Technology, Houghton, Mich.

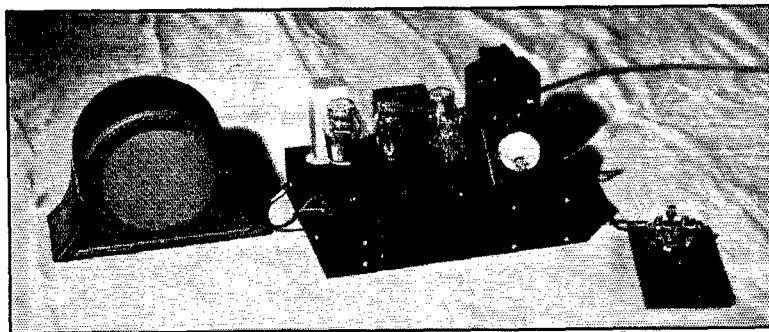

The code-practice unit is built on a standard chassis. The relays and oscillator transformer are mounted underneath. The unit is intended to work with a magnetic speaker.



A novel method of continuous measurement of sending speed. Possibly a bit elaborate for the average beginner, but a useful device for the radio club which conducts code classes.

meter represented 20 words per minute. Thus the rate could be read easily from the meter with no change in scale and without using a calibration curve. By further adjustment of  $R_7$ , full scale can be made to indicate 40 words per minute.

Departures from true reading are caused by  $C_2$  not quite discharging the same amount because of some voltage variation across  $C_3$  with change in rate, by a slight non-linearity between grid voltage and meter current, and line voltage fluctuations. By test, however, the total error has not exceeded 5 per cent.

### Oscillator and Power Supply

The oscillator employed is a tuned-grid type

with  $C_8$  adjusted with respect to the reflected inductance of a high-impedance speaker to give a tone having about a 500-cycle frequency. Keying is accomplished by changing the grid of the 2A3 from ground to cathode potential through the outer lever of relay 1.

The main power supply from the 83 is conventional except that the extra bleeder is provided for the adjustment of the charging potential of  $C_2$ . Extensive filtering is not necessary, a single choke-input section being sufficient.

An assembled view of the apparatus is shown in the photograph. The only controls are the knobs for adjusting  $R_1$  and  $R_7$ . Once calibrated, the only adjustment necessary is that of  $R_1$ , which each sender may have to adjust somewhat to suit his style and approximate speed. The requirement for correct indication of the rate is that the sending be reasonably well done. If there is little discrimination between character spacing and the spacing between dots and dashes, then the time delay will not function properly. But this is a helpful limitation in that it demands good sending.

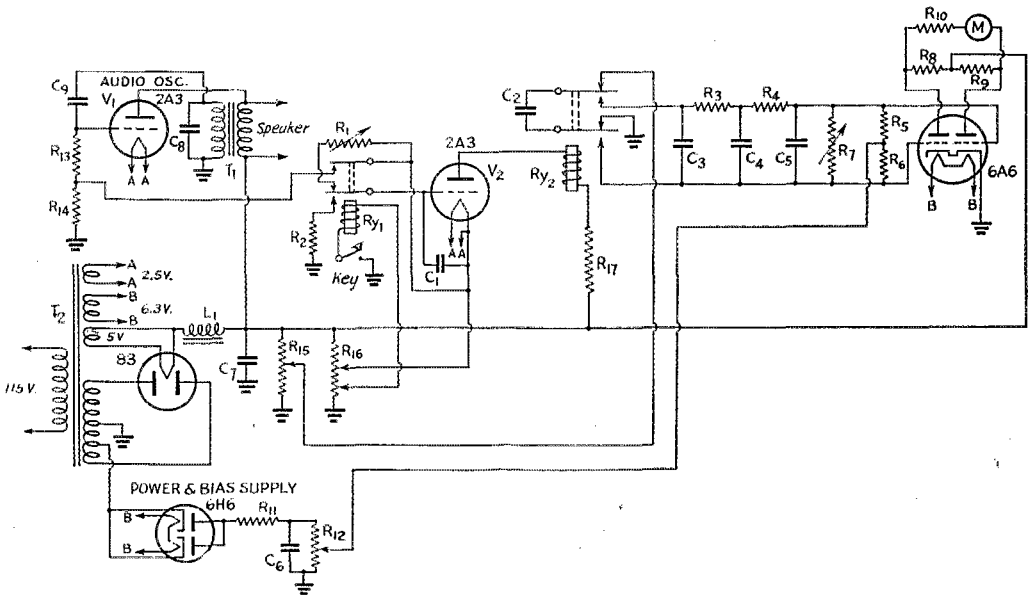

Fig. 1 — Circuit diagram of the code counter and oscillator.

- $R_1$  — 0.5-megohm volume control.
- $R_2$  — 1000 ohms, 1-watt.
- $R_3, R_4, R_5, R_6$  — 0.5 megohm,  $\frac{1}{2}$ -watt.
- $R_7$  — 2-megohm volume control.
- $R_8, R_9$  — 5000 ohms, 1-watt.
- $R_{10}$  — 20,000 ohms,  $\frac{1}{2}$ -watt.
- $R_{11}$  — 15,000 ohms, 1-watt.
- $R_{12}$  — 8000 ohms, 2-watt adjustable.
- $R_{13}$  — 25,000 ohms, 1-watt.
- $R_{14}$  — 50,000 ohms, 1-watt.
- $R_{15}$  — 25,000 ohms, 10-watt adjustable.
- $R_{16}$  — 15,000 ohms, 10-watt adjustable.
- $R_{17}$  — 8000 ohms, 10-watt.

- $C_1$  — 0.5  $\mu$ fd., 100-volt.
- $C_2$  — 0.02- $\mu$ fd. paper, 600-volt.
- $C_3, C_4, C_5$  — 2- $\mu$ fd. paper, 100-volt.
- $C_5$  — 16- $\mu$ fd. electrolytic, 100-volt.
- $C_7$  — 8- $\mu$ fd. electrolytic, 500-volt.
- $C_8, C_9$  — 0.02- $\mu$ fd. paper, 400-volt.
- $L_1$  — 12 henrys, 150 ma. (Thoradson T-17C00-B).
- $T_1$  — Audio-output transformer, 1:1 ratio.
- $T_2$  — 440 volts each side c.t., 125 ma.; bias tap at 38 volts; with 5-, 2.5- and 6.3-volt windings (Thoradson T-74R23). M — 0-1 milliammeter.
- $Ry_1, Ry_2$  — D.p.d.t. relays to operate on 20 ma. (Type used is W.E. E-165.)

# An Efficient U.H.F. Unit for the Amateur Television Transmitter

*Crystal-Controlled 112-Mc. Output for Video or Voice Modulation*

BY L. C. WALLER,\* W2BR0

THE r.f. unit described in this article is particularly designed for amateur television transmission, in combination with the camera-modulator unit described by Mr. J. B. Sherman in May *QST*.<sup>1</sup> Addition of the receiver described in the June issue<sup>2</sup> completes the amateur television station.

At present there are three frequency bands available for amateur television transmissions.

\* RCA Mfg. Co., Inc., Harrison, N. J.

<sup>1</sup> "A New Electronic Television Transmitting System for the Amateur"; *QST*, May, 1940.

<sup>2</sup> "A Receiver for the New Amateur Television System"; *QST*, June, 1940.

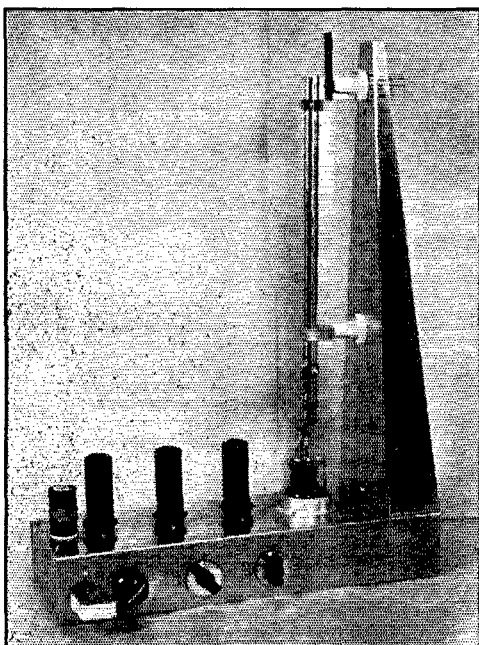

The 112-Mc. r.f. section of the television transmitter is capable of 20-watt or better carrier output with video grid modulation. It also makes an excellent phone transmitter of considerably greater carrier output with conventional plate modulation. Starting with a 7-Mc. Tri-tet oscillator quadrupling in the plate circuit, 112-Mc. excitation is obtained with only two additional doublers. The 829 final stage operates as a straight push-pull amplifier.

These are 112-116 Mc., 224-230 Mc., and all frequencies above 300 Mc. It is desirable, for technical reasons, to use the lowest frequency band available; hence, this transmitter is designed to operate in the present 112-116 Mc. ( $2\frac{1}{2}$ -meter) band.

At first thought, it might seem that a transmitter suitable for handling amateur television signals would have to be of very special design; however, such is not the case. The r.f. unit, shown in the circuit of Fig. 1 and the accompanying photographs, is of simple, straightforward, u.h.f. design. Only 4 r.f. stages are required, thanks to the Tri-tet crystal oscillator which quadruples the 7.119-Mc. crystal frequency. Any good 40-meter crystal can be used.

The 6L6 oscillator is followed by two 6L6 frequency doublers, as shown in Fig. 1. The new RCA-829 twin beam-power tube, especially designed for u.h.f. operation, is used as a straight 112-Mc. r.f. power amplifier. This tube is especially well adapted because of its low driving-power and low modulating-power requirements. The 829, in grid-modulated amplifier service, requires only 0.5 watt of r.f. driving power and negligible video modulating power. The necessary video modulating signal of only 17 volts peak value is easily supplied from the cathode circuit of the 6L6 modulator (located on the camera unit). The carrier output of the 829 operating at about 500 volts is approximately 23 watts.

The Tri-tet crystal oscillator stage is conventional. As usual with this highly efficient circuit, careful attention must be given to the design and adjustment of the cathode tank,  $L_1-C_1$ . Self-excited oscillations are practically certain to occur if the value of  $L_1$  or  $C_1$  is not correct. When the oscillator is operating with the plate tank  $L_2-C_6$  tuned out of resonance, the d.c. plate current will be 45 or 50 ma. At no-load resonance (with  $C_7$  disconnected), the oscillator plate current should make a fast, sharp dip of about 8 to 14 ma. Care must be taken that the 28-Mc. fourth harmonic is selected; a plate-current dip at the 21-Mc. third harmonic will also be within the tuning range of  $L_2-C_6$ . The crystal-current indicator bulb *B* will glow just a little more than a dull red when the Tri-tet is working properly. When the oscillator plate tank is tuned to the

fourth harmonic of the crystal, the crystal current should make a noticeable dip.

The 56-Mc. doubler stage is also conventional. No trouble was experienced in its adjustment or operation. The 112-Mc. doubler is unusual only with respect to the "series-tuned" plate-tank circuit employed. An ordinary parallel-tuned circuit will not provide as good efficiency or power output at 112 Mc., because of the poor  $L-C$  ratio obtainable. In the circuit shown, the tube output capacitance is in series with  $C_{14}$ . These capacitances tune  $L_4$  somewhat like a split-stator condenser, with the result that the total effective capacitance shunted across  $L_4$  is only one-half that of the tube capacitance alone. Thus,  $L_4$  can have almost as much inductance as the 56-Mc. doubler plate coil,  $L_3$ . The inductance of  $L_4$  should be adjusted by squeezing or pulling the coil turns until  $C_{14}$  resonates when half meshed. In this manner, the r.f. voltage node on  $L_4$  can be made to fall very close to the center of the coil. The power output of the 112-Mc. doubler is almost as good as that of the 56-Mc. doubler; it is even

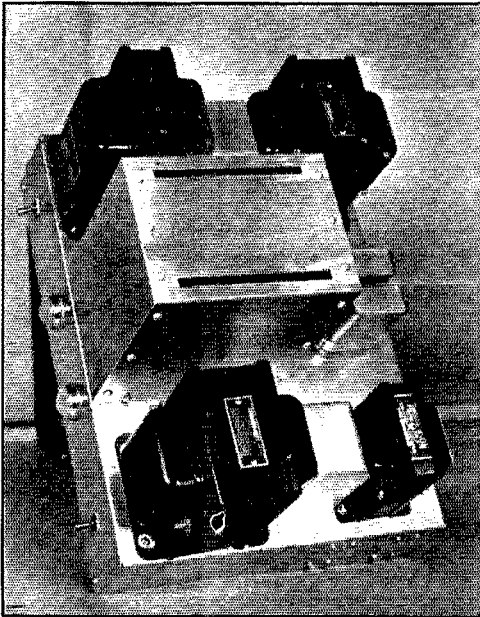

The 866 rectifiers are enclosed in aluminum shielding centered on the power-pack chassis.

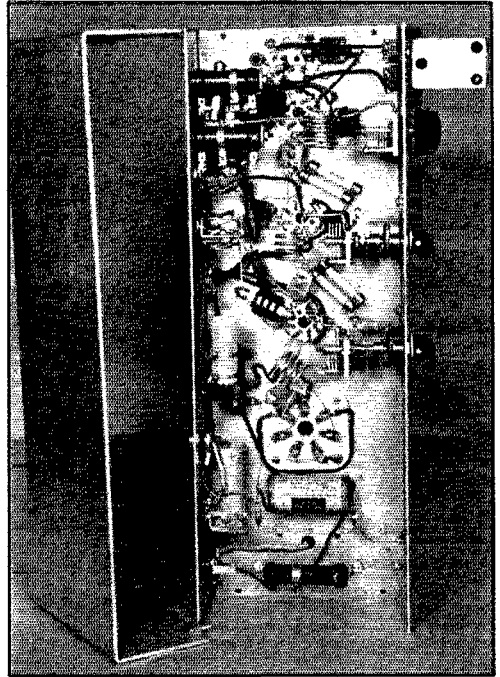

Short, direct connections in the exciter r.f. circuits contribute to the cause of efficiency. The video input concentric-line terminal is to the left of the 829 socket.

adequate for plate modulation of the 829, where a final-amplifier d.c. grid current of 11 ma. is required.

The 829 stage uses a resonant-line ( $\frac{1}{4}$ -wave) plate circuit and a fixed-tuned grid circuit. The grid coil,  $L_7$ , is tuned only by the tube input capacitance. Tuning is initially accomplished by adjusting the length of  $L_7$ . The latter can be squeezed or elongated by means of two bakelite dowel rods; resonance is indicated by the 829 d.c. grid-current meter. A final-amplifier grid current of 2 ma., or slightly less, is adequate for grid-modulated television service. If the grid current is found to be too high, it can be reduced by loosening the coupling of  $L_5$  or  $L_6$ , by reducing the plate voltage on one or both of the doubler stages (the preferable method), or by slightly detuning the 112-Mc. doubler stage.

To set the screen voltage on the 829, adjust the sliding tap on  $R_{14}$  in small steps, starting at the

Really practical amateur television transmission has arrived, at last. And here is the evidence that there is nothing especially complicated about the r.f. end of a ham television transmitter. The job described by W2BRO in this article has been thoroughly proved in field tests, in combination with the camera-modulator and receiver units described by J. B. Sherman in May and June *QST*, and has clearly demonstrated the straightforward practicability of good quality amateur television communication with simplified, economical apparatus. This 112-Mc. rig has shown its worth as a high-grade 'phone transmitter, too. So look it over, u.h.f. 'phone gang.

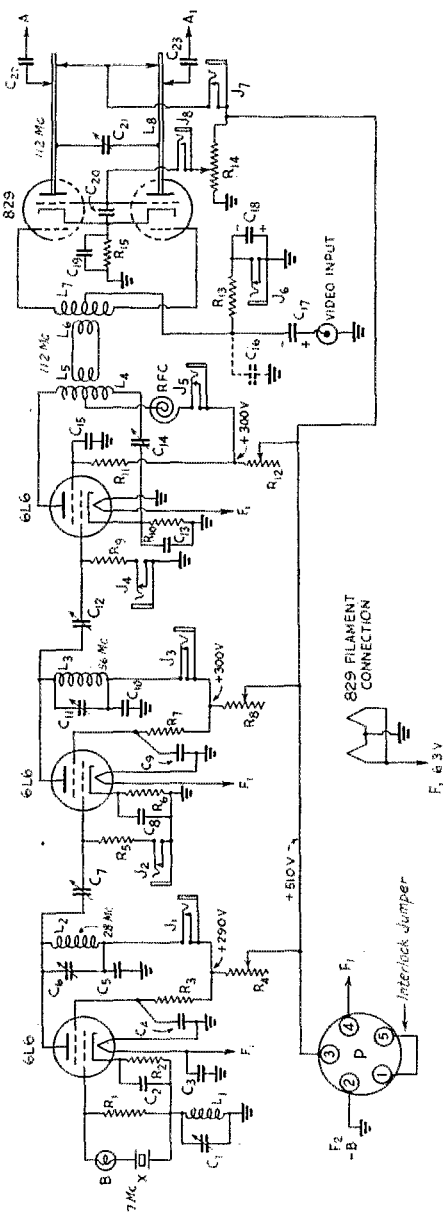

Fig. 1 — Circuit of the 112-Mc. transmitter.

ground end, so that under no condition of operation will the 829 screen voltage exceed 225 volts, measured to the cathode (not to ground).  
 The amplifier plate-tank circuit is tuned to resonance by means of condenser  $C_{21}$ , after the shorting bar at the upper end of the plate rods has been adjusted approximately to the proper position. The 829, like other beam types, should never be operated without a load. A 25-watt lamp clipped across the plate rods 4 or 5 inches from

- X — 40-meter crystal, 7018.7 to 7231.2 kc.
  - RFC — 2½-mh. r.f. choke (National Type R-100).
  - B — Tan bead pilot bulb, 6.3 v., 150 ma. (G. E. Mazda No. 40).
  - P — 5-pin water socket.
  - J<sub>1</sub> to J<sub>8</sub> — Single-closed-circuit meter jacks.
  - L<sub>1</sub> — 10 turns No. 26 d.c.c. on 1½" form, ¾" long.
  - L<sub>2</sub> — 7 turns No. 12 bare solid wire, 1" outside diameter, 1" long, air-wound.
  - L<sub>3</sub> — 4 turns No. 12 bare solid wire, ¾" outside diameter, 1" long, air-wound.
  - L<sub>4</sub> — 3½ turns No. 12 bare solid wire, 1" outside diameter, ¾" long, air-wound, center-tapped.
  - L<sub>5</sub>, L<sub>6</sub> — 1-turn link coils, No. 18 insulated push-back wire, diameter to fit around center of L<sub>4</sub> and L<sub>7</sub>, respectively.
  - L<sub>7</sub> — 4 turns No. 18 bare solid wire, ¾" outside diameter, approx. ¾" long (see text), center-tapped.
  - L<sub>8</sub> — Two pieces ¾" solid copper rod (or tubing) each 17" long, spaced ¾" center-to-center (see text).
  - AA1 — To antenna feeders. An RCA Type UT-106 socket is used for the 829.
- The chassis is 3" x 6" x 18", ¼" aluminum.
- C<sub>1</sub>, C<sub>7</sub>, C<sub>12</sub> — 3–30 μfd. mica trimmer (Hammarlund 6L6, MEX).
  - C<sub>2</sub>, C<sub>3</sub>, C<sub>4</sub>, C<sub>5</sub>, C<sub>9</sub>, C<sub>10</sub>, C<sub>15</sub> — 0.002-μfd. mica (Aerovox).
  - C<sub>6</sub> — 75-μfd. variable (Cardwell Type ZU-75-AS).
  - C<sub>8</sub>, C<sub>11</sub>, C<sub>13</sub>, C<sub>16</sub> — 500-μfd. midgest mica.
  - C<sub>14</sub> — 25-μfd. variable (Cardwell Type ZR-25-AS).
  - C<sub>16</sub> — 25- to 50-μfd. midgest mica (May be omitted).
  - C<sub>17</sub> — 25-μfd. electrolytic, 100-volt working.
  - C<sub>18</sub> — 50-μfd. electrolytic, 25-volt working.
  - C<sub>20</sub> — Special variable condensens (see text).
  - C<sub>21</sub>, C<sub>22</sub> — 500-μfd. mica.
  - R<sub>1</sub> — 75,000 ohms, 0.5 watt.
  - R<sub>2</sub> — 500 ohms, 2 watts.
  - R<sub>3</sub> — 20,000 ohms, 2 watts.
  - R<sub>4</sub>, R<sub>5</sub> — 5000 ohms, 25 watts, adjustable.
  - R<sub>6</sub> — 150,000 ohms, 0.5 watt.
  - R<sub>7</sub> — 500 ohms, 5 watts.
  - R<sub>8</sub>, R<sub>9</sub> — 10,000 ohms, 2 watts.
  - R<sub>10</sub> — 25,000 ohms, 0.5 watt.
  - R<sub>11</sub> — 2500 ohms, 25 watts.
  - R<sub>12</sub> — 3000 ohms, 0.5 watt.
  - R<sub>13</sub> — 20,000 ohms, 25 watts, adjustable (see text).
  - R<sub>14</sub> — 50 ohms, 25 watts.
  - R<sub>15</sub> — 250 ohms, 25 watts.

the shorting bar serves nicely as a dummy antenna. If the 829 is tuned to resonance with no load, severe overheating of the screens will occur with possible damage to the tube.

The +B lead from the shorting bar on L<sub>3</sub> down to plate-meter jack J<sub>7</sub> should be made with shielded wire, with the shield grounded to the aluminum plate-rod mounting bracket. This lead thus has sufficient capacitance to ground to serve as an r.f. by-pass for the plate meter.

Condenser C<sub>21</sub> consists of two thin brass discs, about the size of American pennies, mounted on the ends of two 6-32 brass screws. The plate rods are drilled and tapped for the screws, as shown in the photographs. The screws are slotted to take an all-bakelite screw-driver for purposes of adjustment. A tool having a metal tip is not satisfactory.

The video modulating voltage from the camera unit, via a concentric line, is shunt-fed into the

amplifier grid circuit by means of  $C_{17}$  and  $R_{13}$ . The resistance of  $R_{13}$  should be low enough to avoid degeneration effects due to modulation of the d.c. grid current, and high enough so as not to load the video modulator output circuit too heavily. A value of 3000 ohms is satisfactory.

In order to grid-modulate the 829 properly, it is essential that the plate circuit be heavily loaded. In other words, when  $C_{21}$  is detuned from resonance, the amplifier plate current should not rise more than a few milliamperes. This heavy-loading requirement is characteristic of "efficiency" modulating systems.

Because of the relatively large power input and plate dissipation which the 829 is rated to handle, and its small physical size, the bulb of this tube becomes very hot during operation. For this reason, forced-air cooling is essential. Any small, inexpensive electric fan placed 6 or 8 inches from the tube will provide the necessary cooling.

Table 1 gives the more important voltage and

TABLE 1

	Oscil- lator	56-Mc. Doublers	112-Mc. Doublers	112-Mc. Amplifier
D.C. Plate Voltage.....	290	300	300	510
D.C. Screen Voltage....	200	250	260	238
D.C. Cathode Voltage...	20	30	40	38
D.C. Plate Current, Ma.	35	55	80	120*
D.C. Grid Current, Ma.	—	0.6	2	2*

\* Total current for both units.

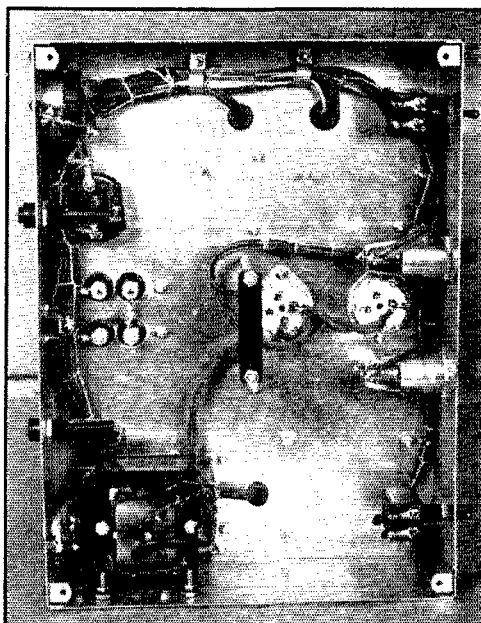

Underneath the power-pack chassis with the base plate removed. Note the safety interlock female socket strip to the left of the 866 rectifier sockets. A male plug mounted on the base plate (not shown) closes the primary circuit when the bottom is covered. The output filter capacitance  $C_3$  consisting of four 20- $\mu$ fd. 450-volt electrolytic condensers connected in series-parallel was added after this photograph was taken. These condensers are readily mounted on terminal strips under the chassis.

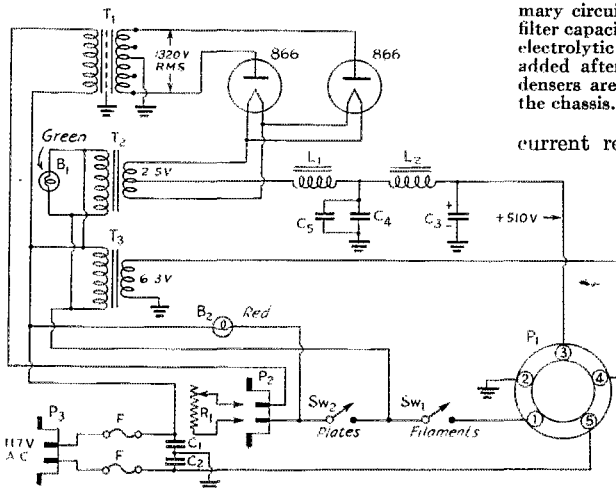

Fig. 2 — Circuit of the Television Transmitter Power Supply.

- $C_1, C_2$  — 0.01- $\mu$ fd. mica (Sangamo).
- $C_3$  — 20- $\mu$ fd. electrolytic, 600 v. d.e. working (Four 20- $\mu$ fd. 450-volt electrolytics can be used in series-parallel).
- $C_4, C_5$  — 2- $\mu$ fd. 600-v. (Cornell-Dublier TJU).
- $R_1$  — 75-watt 50-ohm power rheostat (Centralab).
- $T_1$  — Plate transformer, 660-0-660 volts, 250 ma. (Thordarson T-19P55).
- $T_2$  — Filament transformer, 2.5 volts, 10 amp. (Thordarson T-19F90).
- $T_3$  — Filament transformer, 6.3 volts, 5 amp. (Thordarson T-73F60).

current readings of all four r.f. stages, under normal carrier conditions. The voltages are measured to chassis.

The power supply for the transmitter is shown in the circuit of Fig. 2. Constructional details can be seen in the illustrations. Two 866's are employed in this unit, because the peak inverse voltage involved is considerably above the rating of tubes such as the 83 and 5Z3.

Safety features include shielding of the 866's and all high-voltage terminals, as well as an interlock in

(Continued on page 96)

- $L_1$  — 5-20-henry 300-ma. swinging choke (Thordarson T-19C36).
- $L_2$  — 12-henry 300-ma. smoothing choke (Thordarson T-19C43).
- $P_1$  — 5-pin ceramic socket.
- $P_2, P_3$  — 115-volt male plugs, chassis type.
- $B_1, B_2$  — 117-v. bull's eye pilot lamps, candelabra base, color as indicated (Drake No. 75).
- $F$  — 3-amp. radio fuse (Littelfuse No. 3AG).
- $Sw_1, Sw_2$  — S.p.s.t. toggle switch, 250-V. 6 A. (Cutler-Hammer).
- Chassis, 3' x 10' x 14' cadmium-plated steel.
- The bleeder,  $R_{14}$ , for this power supply is located on the transmitter chassis.

# A Different Portable-Emergency Transmitter

## Simplified Design With the Inverted Amplifier

BY R. P. AUSTIN,\* W3EVA

Now that emergency amateur equipment has had its "baptism in fire" on many occasions during the past few years, the need for such gear in every ham station should be quite apparent. The argument that it might never find use in some localities is not a particularly good one — New England thought "it can't happen here," and was fooled.

Normally the starting point in the design of an auxiliary rig is the junk-box, and that's where I started on this one. A few odd condensers, coil forms and beam-power tubes turned up, and a small 5- by 6- by 9-inch metal cabinet that was slowly gathering dust crystallized the design.

### The Circuit

With c.w. operation in mind, and break-in operation a "must," the need for good, clean keying at any speed was imperative. My personal favorite in this line is the regenerative pentode oscillator. I have two of them now, and either one keys beautifully, with any of 18 crystals, without chirps, blurps, or bloops at speeds up to 150 w.p.m. These keying tests have been conducted with a tape transmitter, tape recorder and an oscilloscope. No difficulty was encountered

with a key lead up to 50 feet in length, and no keying relays were used. So experience indicated the regenerative oscillator circuit, and the junk-box dictated a 6V6G tube. A 6V6, 6F6 and 6L6 all were tried later, with some differences in output but none in keying characteristics.

A very desirable form of amplifier to follow the oscillator would be one that is simple without sacrificing efficiency and requires no fixed bias or neutralization. Such an amplifier is readily obtained by connecting the two grids of a beam-power tube together (resulting in a high- $\mu$  triode) and then inverting<sup>1</sup> it; i.e., the grid (control and screen) is grounded and the cathode is left up in the air. This greatly simplifies the amplifier, because the only parts required are tube, socket, plate coil and condenser, plate by-pass condenser and a low-impedance link to the oscillator stage. There isn't much to that, is there?

The wiring diagram shown in Fig. 1 will give a better idea of the inverted-amplifier connection as well as the rest of the circuit. Doubtless some of the boys are going to indulge in hoarse laughs at this idea, but if they try it they will soon change their tune. It enables us to obtain a cheap, simple and relatively foolproof rig that leaves nothing to be asked for. Of course, the transmitter can be operated on only one band with any one crystal, but crystals are not as scarce as they used to be. A Tritet oscillator could be used to give two-band operation from one crystal but, in my experience, I have yet to see an oscillator of that type that will give good keying at all speeds. And it takes more space.

### Construction

No particular care need be taken in the construction of the rig other than that according to general good practice in amateur design. It is necessary to shield the two stages from each other, since there is a possibility that the amplifier will oscillate if its plate circuit is inductively coupled back to the oscillator plate circuit. However, a simple single shielding baffle was found to be all that is necessary. The link from the oscillator plate coil to the cathode-grid circuit of the amplifier is made by twisting together two pieces of flexible rubber-covered wire. A similar line leads from the amplifier output link to the antenna terminals.

The tube and coil sockets are mounted below

<sup>1</sup> Romander, "The Inverted Ultraudion Amplifier," QST, Sept. 1933.

\* 113 Second Street, Laurel, Md.

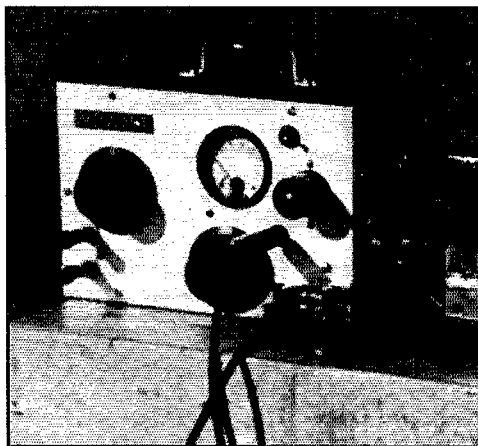

The inverted-amplifier portable emergency rig set up in the field ready to go. Antenna output terminals are at the extreme left; the left-hand dial tunes the amplifier and the dial under the plate meter tunes the oscillator. Key jack and crystal socket are available from the front of the panel.



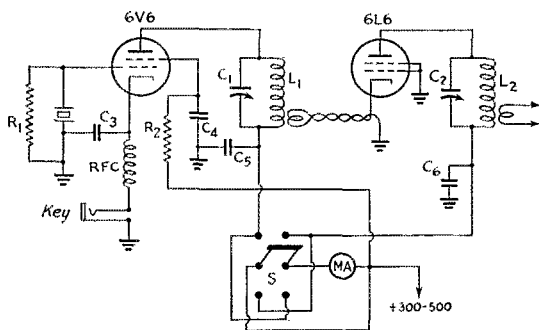

Fig. 1—Circuit diagram of the inverted amplifier portable transmitter.

$C_1$ —100- $\mu$ fd. midget variable (Hammarlund APC-100).  
 $C_2$ —100- $\mu$ fd. midget variable (Hammarlund MC-100-S).  
 $C_3$ —250- $\mu$ fd. mica.  
 $C_4$ —0.001- $\mu$ fd. mica.  
 $C_5, C_6$ —0.002- $\mu$ fd. mica.  
 $R_1, R_2$ —50,000 ohms, 1-watt.  
 RFC—2.5-mh. r.f. choke.  
 MA—0-100 milliammeter.  
 S—D.p.d.t. toggle switch.  
 $L_1, L_2$ —3.5 Mc.: 30 turns No. 22 d.c.c., closewound.

7 Mc.: 13 turns No. 20 d.c.c., closewound.

Link winding on  $L_1$  for 3.5 Mc. is 6 turns wound around ground end of coil; 3 turns are used on all other coils. All coils wound on  $1\frac{1}{2}$ -inch diam. forms.

the chassis. Wires to the tuning condensers are brought through the chassis by means of small porcelain feed-through insulators. The crystal socket is mounted on the panel to make it accessible and to reduce any drift due to heating. A d.p.d.t. toggle switch, also mounted on the panel, allows the plate current of either tube to be measured by flipping the switch.

Either glass or metal tubes can be used in the oscillator without modification—the metal tubes save slightly on space. Either glass or metal tubes can be used in the amplifier, but the shield connection should not be grounded. A glass tube is slightly to be preferred.

The power cable terminates in a 4-prong plug so that the set may be used with any of three available power supplies: a 250-volt 50-ma. genemotor, a 325-volt a.c. power pack, and a 400-volt 100-ma. a.c. power supply.

### Performance

The output terminals of the transmitter should be connected to a link-line coupling to a tuned tank. Any of the usual antennas can be used, and there is no need for elaboration on this point. I have used both ended and Zepp-type antennas in this manner, and the output can be connected directly to a low-impedance line feeding the current loop of an antenna, or a quarter-wave grounded Marconi antenna can be used directly from the link, with a variable condenser in series for resonating the system.

In operation with the 400-volt supply, the inverted amplifier draws only 7 ma. with the key up, 20 ma. with the key down but with no amplifier load, and 85 ma. with the amplifier loaded. Heavier loading at this voltage only drops the output and wastes power. The oscillator draws about 25 ma.

Using this transmitter with the regular home Zepp, inputs from 10 to 30 watts resulted in contacts with all districts but W7 on 7 Mc. The reports were good, and must have been fairly ac-

curate, because hour-long contacts with the west coast and middle west were held without interruption at 40 w.p.m.

## Roanoke Division Convention

Chamberlin Hotel, Old Point Comfort, Va.,  
 August 3rd and 4th

**EMPHASIS** on the fraternal side and plenty of time for the vacation features of the historic Virginia Peninsula are to be the keynotes of the Roanoke Division A.R.R.L. Convention being jointly sponsored by the Norfolk Radio Club and the Peninsula Amateur Radio Club, at the beautiful Chamberlin Hotel in Old Point Comfort, on August 3rd and 4th. Liaison officers of both A.A.R.S. and N.C.R. will be in attendance, as will be other notables of the amateur fraternity. For information write the secretary, Laurie Turner, W3BEK, 115 West 33rd St., Norfolk, Va.

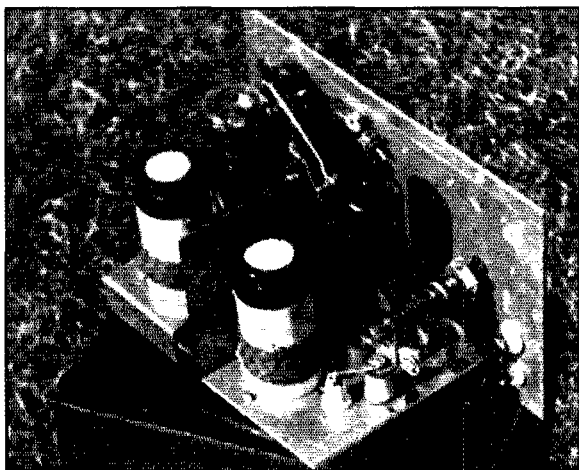

A rear view of the set shows the oscillator stage (left) shielded from the amplifier on the right. Shielding is necessary in this type of circuit. The transmitter is sitting on the 5-inch by 6-inch by 9-inch cabinet into which it fits.

# A Heterodyne Exciter

## Stabilized Frequency-Control Unit for Transmitters

BY W. RODERIC BLISS,\* WIFMZ, AND PHILIP A. BAILEY,† WIBKO

THE production of beat frequencies by the mixture of two other frequencies is well known to the amateur. It is the principle upon which the superheterodyne receiver relies, and the method by which c.w. stations are made audible. It is equally useful in transmission, and has had some application in that field. Before describing the exciter unit shown in the accompanying photographs it may be well to review the method by which beats are employed to obtain stable frequency control.

If a stable high frequency such as is obtained from a well-adjusted crystal oscillator is combined, in a Class-C amplifier, with a low frequency from a high-C oscillator, four major output frequencies will be found. The first will be, of course, the crystal frequency, which we shall call  $f_c$ . The second will be the low frequency, represented by  $f_s$ . Then there will be found the two beat frequencies,  $f_c$  plus  $f_s$  and  $f_c$  minus  $f_s$ . These combination frequencies are the ones used to accomplish our aims.

\* Naval Research Laboratories, Washington, D. C.  
† 14 Alsop Ave., Middletown, Conn.

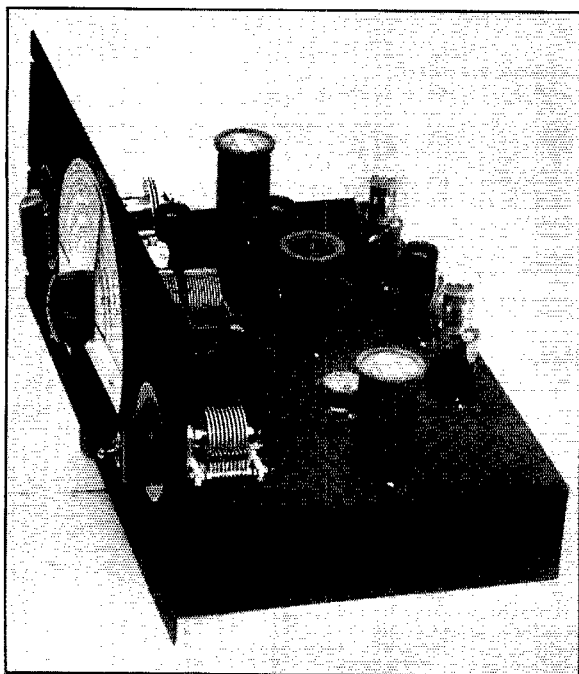

Suppose we have a crystal oscillator operating at a frequency of 6.5 Mc. and mix this with the output of a 500-ke. oscillator in the grid circuit of a Class-C amplifier. The plate could be tuned to 6.0 Mc., 6.5 Mc., or 7.0 Mc. and an output found on these frequencies with a neon bulb or a flashlight bulb and loop. If the low-frequency oscillator were variable from 500 kc. to 1000 kc., two variable frequencies could be found—5.5 Mc. to 6.0 Mc., and 7.0 Mc. to 7.5 Mc. This last frequency range would be very useful for QSY on 40 meters and the higher frequency bands.

The stability of the beat frequencies considerably surpasses the stability of the e.c.o.'s commonly used for QSY. The drift at worst is equal to the crystal oscillator drift plus the drift of the low-frequency oscillator, and by design it is quite possible to have the two oscillators drift in opposite directions, and thus tend to balance out when the upper sideband is used. The authors have made no attempt to do this, for it was not found necessary. The frequency drift of a high-C low-frequency oscillator is often less than that of a high-frequency crystal oscillator when measured in cycles per second, so that even the sum of the two drifts is still very small. The stability of a low-frequency oscillator can easily be confirmed by remembering that a b.c. receiver stays tuned on a broadcast station pretty well and no especial care is used in the design of the b.c. oscillator!

Since the output tank could hardly tune to  $f_s$ , this unwanted frequency is eliminated. It is desirable to eliminate also  $f_c$ , since this will fall outside the band in which QSY is contemplated. This can be done by using a two-tube mixer circuit, with the crystal frequency introduced into the grids in parallel and the beat frequency taken from the plate circuit to which the plates are connected in push-pull. This circuit is well known as a "balanced modulator." In the arrangement of Fig. 1 the low frequency is applied to the grids in push-pull. It will be seen, therefore, that with crystal signal balanced out and the mixer tank tuned to many times the

The exciter unit is designed for relay-rack mounting. A direct-reading dial, hand calibrated, facilitates frequency setting.

◆

In this rear view, the crystal tank circuit is at the extreme left. The next two tubes are the 6V6 crystal oscillator and VR150 regulator. The self-controlled oscillator tank condenser is centered on the panel, with the coil and tube behind it. The three tubes in a row are the two 6F6's for the mixer circuit and the VR150 for the self-controlled oscillator. The output tank of the mixer is at the extreme right.

◆

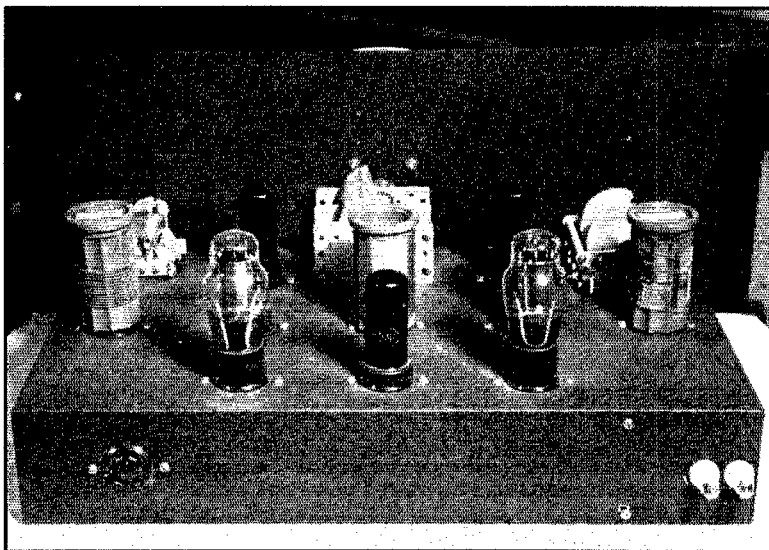

low frequency, the only resonances found in the output will be at the beat frequencies.

Some experimenting was necessary to determine the lowest  $f_c$  which could be used. With  $f_c$  too low,  $f_c$  plus  $f_s$  comes so near  $f_c$  minus  $f_s$  that the mixer plate tuning does not distinguish between the two. The minimum  $f_c$  for 7 Mc. was found to be about 500 kc.; that is, the resonances in the mixer plate were 1000 kc. apart. This minimum value of  $f_c$  is subject to experiment by the individual constructor, as it varies with the  $Q$  of the mixer plate tank, its loading, and the skill of the operator.

This minimum low frequency is also proportional to  $f_c$ . If it is desired to work on 3500 to 4000 kc.,  $f_s$  should not be less than 250 kc., and on 14 Mc. no less than 1000 kc.

The advantages of using the heterodyne method of QSY may be briefly summed up as follows:

1. Less drift than with a conventional e.c.o.
2. Out-of-band crystals, formerly considered useless, may be used.
3. High-power amplifiers operate on a frequency different from either the crystal or variable oscillator, eliminating feedback which

causes frequency instability and crystal heating or fracture.

4. Keying may be accomplished more satisfactorily than in other exciter units.

5. Construction does not require the exacting care that would be necessary in an e.c.o. of comparable stability.

6. Calibration is much more positive and more easily checked than in any other variable-frequency exciter.

#### *Exciter Circuit*

The circuit which emerged after much experiment is shown in Fig. 1. The crystal oscillator is a 6V6 coupled to the screens of the 6F6 mixers. The 6N7 serves as a push-pull low frequency oscillator which excites the control grids of the mixer tubes.

The 6V6 crystal oscillator is quite conventional in design. The plate voltage is held down to 150 volts by the VR150 regulator tube. This results in low crystal current and heating, in addition to providing some degree of independence from line-voltage fluctuation. If desired, any other form of plate-supply regulation may be used with equivalent results.

The crystal is a Bliley B5R unit calibrated at 6499 kc., (6500 kc. would be ideal) and is similar in size and low-drift characteristics to the familiar B5 unit. This  $6500 \pm 5$  kc. unit may be obtained from most amateur supply houses or from the manufacturer. Several other methods of obtaining crystal control outside the band will suggest themselves to the amateur. An 80-meter 'phone band crystal will double into the range of 7800 to 8000 kc. and the lower sideband of the beat frequencies may be used by mixing after doubling in the crystal stage. Another alterna-

This frequency-control unit gives sufficient r.f. output (about 3 watts) to substitute for the crystal oscillator in many transmitters, and gives the advantage of highly-stable variable-frequency control. In the model described the output frequency is in the 7-Mc. region, but suitable choice of oscillator frequencies make it readily adaptable for lower or higher output frequencies.

tive with the same crystal is to heterodyne the fundamental frequency back into the 80-meter c.w. band and double after the mixer. The fundamental frequency of some 10- or 20-meter harmonically-operated crystals may fall a convenient distance outside the amateur band.

Crystals which have been accidentally ground too thin to fall inside the amateur band may be used if they fall an appropriate  $f$ , outside the band. If they are too near the operating frequency, a few more swipes with carborundum will put the frequency high enough. In this case, the lower sideband would be the one to pick out in the mixer plate-circuit tuning.

The low-frequency oscillator uses a 6N7 double triode to obtain push-pull output. For the sake of stability, the plate voltage for this tube is also kept to 150 volts by a VR150. Since the 6N7 operates as a self-excited oscillator, voltage regulation is particularly important if the maximum of stability is to be obtained. Fortunately, only seven to fourteen per cent of the beat frequency stability is dependent upon the low-frequency oscillator. The tuning condenser used in this oscillator is a common double-section broadcast job, and is quite satisfactory if care is used

to see that there will be no excessive thrust on the shaft due to mounting conditions. A small 50- $\mu$ fd. air trimmer is connected between the stator sections for purposes of calibration.

The circuit of the low-frequency oscillator makes use of a condenser and resistor from plate to opposite grid to effect regenerative feedback. This was the handiest scheme and was left as first hooked up. Possibly other circuits will work as well or better, but no need was felt in the authors' case for a change. In any case, the oscillation should be smooth and continuous all over the range of the tuning condenser. The coupling condensers to the 6F6 mixers are purposely made small in order to reduce the reaction of the other circuits upon the frequency of the low-frequency oscillator. Too small a condenser will, of course, reduce the excitation excessively.

The dial is a homemade affair, based on the works of a National Velvet Vernier, with a celluloid pointer substituted for the regular dial. The card mounted behind the pointer is made similar to the Biley frequency chart. Four scales are calibrated upon it. The outside strip is the direct frequency reading of the low-frequency

(Continued on page 78)

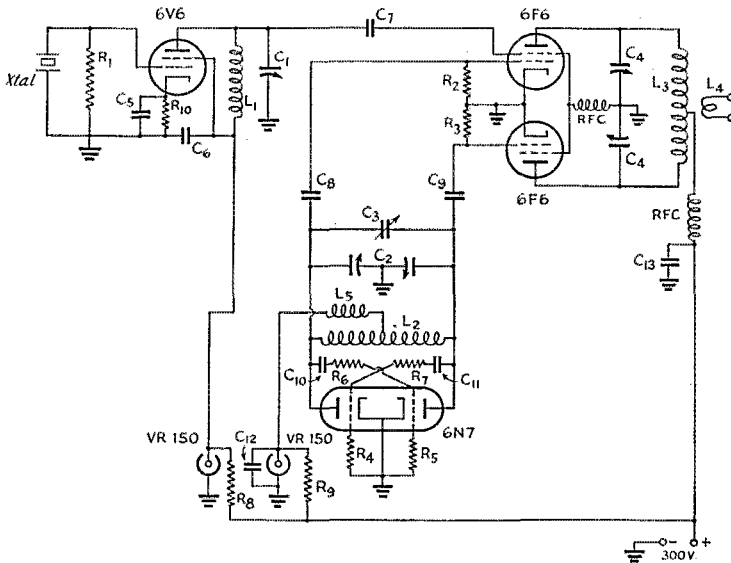

Fig. 1 — Heterodyne exciter circuit

- R<sub>1</sub>, R<sub>2</sub>, R<sub>3</sub> — 30,000 ohms, 1-watt.
- R<sub>4</sub>, R<sub>5</sub> — 50,000 ohms, 1-watt.
- R<sub>6</sub>, R<sub>7</sub> — 12,500 ohms, 1-watt.
- R<sub>8</sub>, R<sub>9</sub> — 5,000 ohms, 10-watt wire wound.
- R<sub>10</sub> — 500 ohms, 10-watt.
- C<sub>1</sub> — 100- $\mu$ fd. midget variable.
- C<sub>2</sub> — 370- $\mu$ fd. dual variable, broadcast type.
- C<sub>3</sub> — 50- $\mu$ fd. air trimmer.
- C<sub>4</sub> — Split-stator, 50- $\mu$ fd. per section.
- C<sub>5</sub> — 0.02- $\mu$ fd. 200-volt paper.
- C<sub>6</sub> — 0.02- $\mu$ fd. 400-volt paper.
- C<sub>7</sub> — 250- $\mu$ fd. 400-volt mica.
- C<sub>8</sub>, C<sub>9</sub> — 10- $\mu$ fd. 400-volt mica.

- C<sub>10</sub>, C<sub>11</sub> — 250- $\mu$ fd., 400-volt mica.
- C<sub>12</sub> — 0.25- $\mu$ fd. 400-volt paper.
- C<sub>13</sub> — 0.5- $\mu$ fd. 400-volt paper.
- RFC — 2.5-mh. r.f. choke.
- L<sub>1</sub> — 15 turns No. 20 d.s.c. spaced to cover 1 in. on 1½ inch coil form.
- L<sub>2</sub> — 150 turns No. 30 d.s.c. close-wound on 1½ inch form, and c.t.
- L<sub>3</sub> — 26 turns, c.t., No. 20 d.s.c. spaced to cover 1½ inch on 1½ inch diameter coil form.
- L<sub>4</sub> — 2 turn link.
- L<sub>5</sub> — 40-mh. broadcast-type choke.

# An Acorn-Tube 112-Mc. Converter

BY M. P. REHM,\* W2HNY

◆

The 112-Mc. converter is a simple gadget. It is built on a single piece of heavy aluminum, with a small piece to serve as a panel and support for the dial. The output-coupling circuit is mounted at the rear of the chassis. The oscillator tuning condenser is the one nearest the dial.

◆

As a start toward improving our ultra-high-frequency gear, a better 112-Mc. receiver seemed imperative. We have a Hallicrafter Five-Ten receiver which has a wide-band i.f. position originally designed to receive 56-Mc. modulated-oscillator signals (remember?), so we decided to try the receiver as a double-i.f. superhet for 112 Mc. with an acorn-tube converter.

The accompanying photograph shows the finished converter using two 955 acorn tubes. The mixer tunes from 106 to 119 Mc., and the oscillator tunes from 81 to 94 Mc., giving a difference frequency of 25 Mc. In operation the Five-Ten is tuned to 25 Mc. and acts as the i.f. amplifier for the converter.

The circuit is quite simple and straightforward, as can be seen from Fig. 1. The detector coil is 8 turns of No. 14 wire  $\frac{1}{2}$  inch in diameter, spaced to occupy  $\frac{1}{8}$ -inch winding length, and it is tuned by a two-plate midget condenser. The detector plate coil,  $L_2$ , is 12 turns of No. 18 push-back wire,  $\frac{3}{4}$  inch in diameter, close wound and tuned to 25 Mc. by a small air padding condenser. The coupling link is two turns around  $L_2$ , and the output is carried through a short twisted-pair lead to the receiver input. Bias is obtained through the cathode resistor,  $R_1$ , which is by-passed by a small trimmer condenser set to about 20  $\mu\text{fd}$ .

The oscillator coil,  $L_3$ , is 5 turns of No. 14 wire  $\frac{1}{2}$  inch in diameter, spaced to cover  $\frac{3}{4}$  inch and tapped at the center. The tuning condenser has three plates and the padding condenser is set at maximum capacity. The oscillator coupling condenser is set "very light" — about 5  $\mu\text{fd}$ . This system of coupling from oscillator plate to detector cathode may be called "cathode injection"

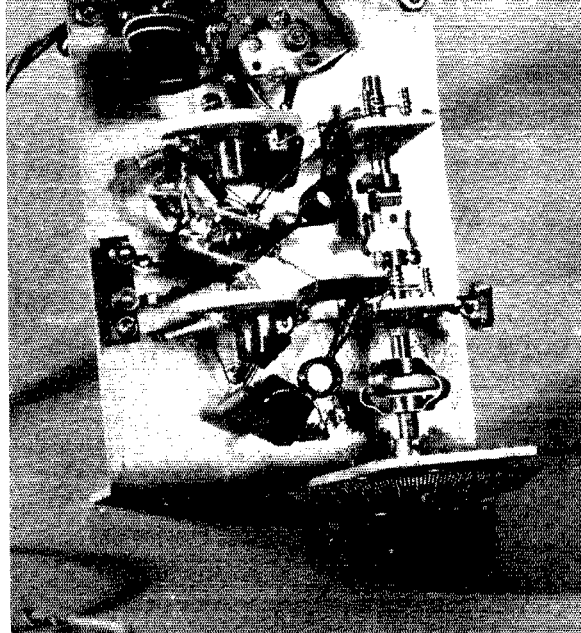

and is used to good advantage in ultra-high-frequency work.

With 100 volts on the plates, the detector should draw 0.4 ma. with the oscillator off and 0.6 ma. with the oscillator on, by proper adjustment of the coupling condenser. The oscillator draws about 5.0 ma.

At present, the parts are just mounted on a  $\frac{1}{8}$ -inch thick aluminum chassis which measures 5 x 7 inches, but everything is "tied down tight." All parts are above the chassis and there is a central ground connection directly under each socket. The sockets are supported on edge by small heavy brackets, as are the condensers  $C_1$ ,  $C_2$  and  $C_4$ . The tuning condensers are ganged and track nicely over eighty degrees of the dial, the 112-116 Mc. band, covering 22 of these degrees. With a five-to-one ratio dial, this spread is ample.

Standard receiving tubes can be used in this circuit but the efficiency will be very poor. The life of acorn tubes is long and their inter-electrode capacity is less than the standard types, so for the slight extra cost, a much better converter will result.

Almost any other i.f. can be used, and a lower frequency would give better efficiency, but it must have a wide pass band. This converter used successfully into a two-stage tuned r.f.

*(Continued on page 104)*

A converter for 112 Mc. doesn't have to be a fancy affair to be effective. Here is a simple one that is short on complexity but long on performance, and it will work into any 25-Mc. amplifier or receiver you may have.

\* 969 Roanoke Avenue, Riverhead, New York.

# A Portable Transmitter-Receiver

*Simple Low-Power Station for All-Around Work*

BY LON M. HILDEBRAND,\* W6QUE

**D**URING the design of the small transmitter-receiver to be described, a few important constructional details were uppermost in the mind of the builder. It had to be small and compact, capable of operation from either a.c. or storage battery power supplies, simple and easy to construct, and the cost was to be kept as low as possible. In addition it was to operate with either end-fed or Zepp-type antennas. Operation was to be confined to the 40- and 80-meter c.w. bands.

This little rig satisfies all of the above requirements, and the results have been better than were anticipated. With an a.c. power supply delivering 400 volts, the input to the 6L6 amplifier is about 30 watts. Using a 250-volt dynamotor or vibrator-pack and storage battery, the input is around 12 watts. In the writer's shack this rig is used as the 80-meter transmitter, and the big rig is left on 40 meters. The middle-western states are contacted regularly on 80. Many of the parts for this rig will be found in the amateur's "junk box." Not much attention was paid to low-loss materials, as the cost was to be kept as low as possible.

Several of these rigs are now in operation in and near Stockton, and all but one are built with separate power supplies, with cable and plug-in connections. The one exception has the a.c. power supply built on the same chassis and, with the exception of a slight hum in the receiver on 40 meters, operates just as efficiently as those using an external supply. The hum is so low that it is not objectionable, and for those who wish to

\*682 North Central Avenue, Stockton, Calif.

build all the units on one chassis, I would suggest an 8 by 12 by 2 inch chassis. This allows ample room for the gear and will fit into a 13 by 9 inch metal cabinet.

With the particular model shown on these pages, a 7 by 9 by 2 inch chassis was used. By exercising a little care in the placement of parts, the components will not appear to be too crowded. This size of chassis fits nicely into an 8 by 10 inch metal cabinet.

The placement of parts on both the chassis and the front panel can be seen from the photographs, and there is no need for a lengthy description. The band-set condenser in the receiver is mounted under the chassis, with the shaft extending up through the chassis, and it is not touched except when changing bands. The main tuning condenser,  $C_2$ , is mounted on the panel and gives good bandspread over both the 40- and 80-meter amateur bands. The only shielding used in the transmitter-receiver is a shield can around the 6C6 (or 6D6 — they work equally well) detector tube.

## Construction

Before mounting any parts or cutting any holes in the chassis, the two condensers and the meter should be mounted on the panel. The circuit diagram, Fig. 1, shows that the band-spread condenser rotor is grounded, so there is no need to insulate it from the panel, but both sides of the transmitter tank condenser,  $C_3$ , are "hot" and the condenser must be insulated from the panel.

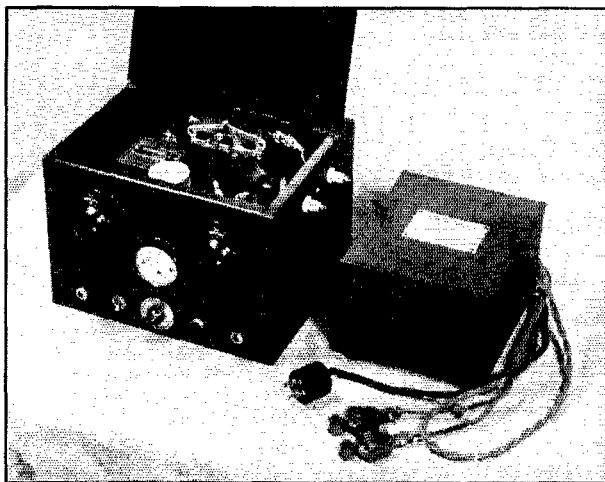

The complete transmitter-receiver is shown here sitting alongside a genemotor power supply. The tuning dial on the left controls the receiver tuning and the one on the right controls the transmitter tuning. Along the bottom, from left to right: headphones jack, send-receive switch, regeneration control, pilot light and key jack. The antenna tuning condenser can be seen at the rear of the cabinet.



**The fellow interested in a simple and inexpensive station that is complete will find many ideas in this description of a rig that can be either the whole works or a useful adjunct to the regular job.**

A small strip of bakelite or hard rubber about 1 inch wide and 2 inches long is used for insulation by first drilling a hole in the center of the strip to support the condenser shaft bearing and then mounting the strip on the panel. The strip is supported by screws through holes at each end of the strip. The hole in the panel through which the condenser shaft extends must, of course, be large enough to clear any of the metal of the shaft bearing and locking nut. The tuning dial covers this hole so there is no reason for not making it sufficiently large. The two tuning condensers are mounted high on the panel to allow plenty of room for the other parts and to give the panel a neat appearance.

The transmitter coil socket, 6L6 socket and 6C5 socket are mounted on the chassis directly in back of the tank condenser, in the order named. They are kept as near as possible to the right-hand edge of the chassis. The crystal socket is mounted on a line to the left of the midpoint between the 6L6 and 6C5 sockets, as close to the sockets as possible without making it impossible to get the tubes and crystal into their sockets. The 4-prong socket that takes the power cable

plug is mounted at the center rear of the chassis, as close to the edge as possible.

The receiver coil socket, audio choke and audio tube socket are mounted behind the band-spread tuning condenser, in the order named and close to the left-hand edge of the chassis. The audio choke is an old audio transformer with the primary and secondary connected in series but, if one prefers, resistance coupling can be used, with some loss in signal strength. The detector tube socket is mounted to the right of the detector coil, allowing enough space for the tube shield to clear the meter, and the band-set tuning condenser is mounted on the chassis behind the detector tube socket. Make sure that the band-set condenser will have enough room under the chassis so that the plates can be set to any position. The detector grid leak and condenser are mounted on the band-spread condenser, thus giving a very short lead to the detector grid. After space has been provided for all the parts, punching and drilling can proceed.

The front panel and chassis are held together by the headphones and keying jacks, regeneration control, pilot light and send-receive switch. Only the headphones jack must be insulated from the metal panel, and the necessary fiber washers are readily available at any radio store.

Wiring of all parts is straightforward in all respects. Bear in mind that this is a portable rig and will be subject to some rough use. Make all soldered connections firm and solid.

Two small feed-through insulators are mounted

A top rear view of the chassis shows the relative position of the parts. The knob just visible over the crystal is used to set the receiver band-set condenser, which is mounted under the chassis. The receiver antenna terminal is at the right-hand corner — the empty socket takes the power supply plug.

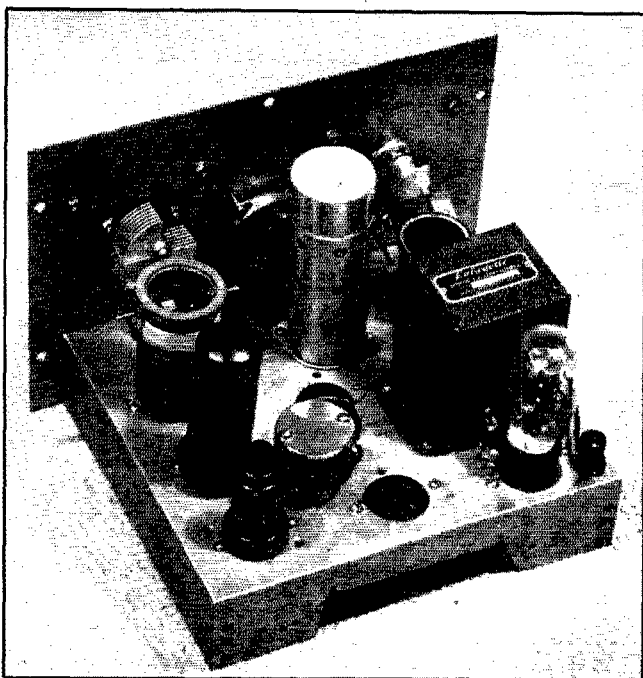

on the transmitter side of the metal cabinet, about 3 inches apart and about 2 inches from the top. These are used to connect to Zepp feeders when this type of feed system is used to the antenna. An old b.c. variable condenser, mounted as high as possible at the rear of the cabinet, is used for tuning the feed line. This condenser is insulated from the cabinet in the same manner as the tank tuning condenser on the panel. Short flexible leads about 4 inches long, with small battery clips on the ends, are used to connect between the condenser and antenna terminals and permit either series or parallel tuning. When an end-fed antenna is used, the antenna is coupled through a 0.002- $\mu$ fd. mica condenser to a short

piece of wire soldered to the "hot" end of the tank coil on the coil form. Terminals of the antenna winding on the coil form are brought to the top of the form and fastened with a small bolt through each side of the coil form. The bolt protrudes about  $\frac{1}{2}$  inch from the form, and it is an easy matter to clip the flexible leads from the antenna condenser and the feed-through insulators to the bolts. This winding is not used, of course, with an end-fed antenna.

Although not shown in the wiring diagram, a small mica condenser of about 0.001- $\mu$ fd. capacity can be connected between the plate of the 6C5 and the crystal. This will remove the plate voltage

(Continued on page 108)

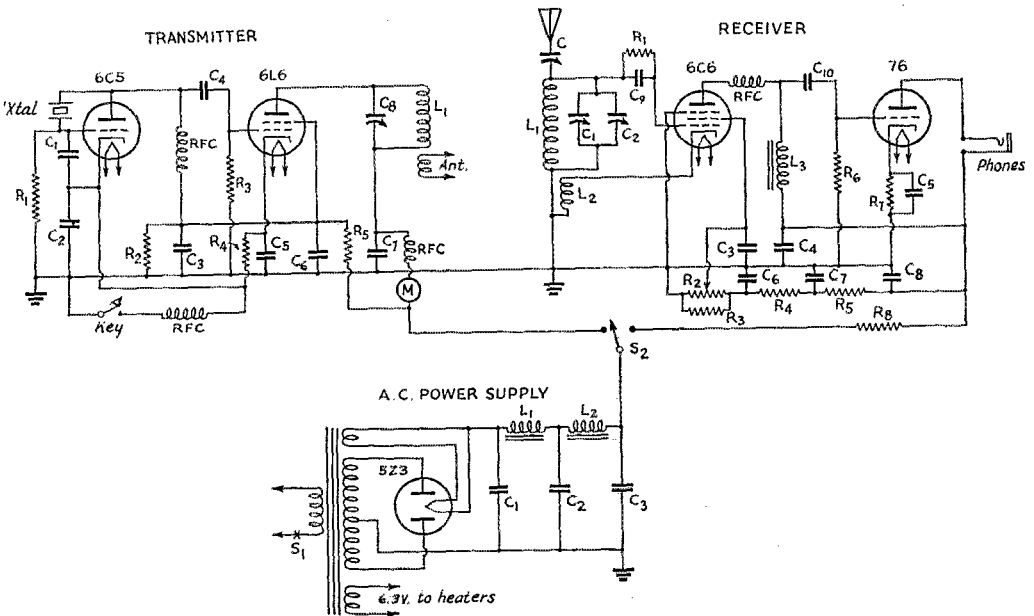

Fig. 1 — Circuit diagram of the transmitter-receiver.

**Transmitter.**

- C<sub>1</sub> — 75- $\mu$ fd. mica.
- C<sub>2</sub> — 0.01- $\mu$ fd. mica.
- C<sub>3</sub> — 0.5- $\mu$ fd. 450-volt paper.
- C<sub>4</sub> — 100- $\mu$ fd. mica.
- C<sub>5</sub> — 0.01- $\mu$ fd. 450-volt paper.
- C<sub>6</sub>, C<sub>7</sub> — 0.02- $\mu$ fd. 450-volt paper.
- C<sub>8</sub> — 100- $\mu$ fd. midget variable.
- R<sub>1</sub> — 25,000 ohms, 1-watt.
- R<sub>2</sub> — 50,000 ohms, 2-watt.
- R<sub>3</sub> — 25,000 ohms, 2-watt.
- R<sub>4</sub> — 300 ohms, 10-watt.
- R<sub>5</sub> — 5,000 ohms, 25-watt.
- RFC — 2.5-mh., 125-ma. r.f. choke.
- M — 0-200 milliammeter.
- L<sub>1</sub> — 3.5 Mc.: 29 turns, close-wound. Antenna coil is 12 turns, close-wound  $\frac{1}{2}$  inch from plate winding.
- 7 Mc.: 19 turns spaced slightly. Antenna coil is 9 turns, close-wound  $\frac{1}{2}$  inch from plate winding.

Both coils are wound with No. 18 enam. on 4-prong  $1\frac{1}{2}$ -inch diameter forms.

**Receiver.**

- C — 30- $\mu$ fd. mica trimmer.
- C<sub>1</sub> — 100- $\mu$ fd. midget variable.
- C<sub>2</sub> — 15- $\mu$ fd. midget variable.
- C<sub>3</sub> — 0.01- $\mu$ fd. 450-volt paper.
- C<sub>4</sub>, C<sub>6</sub>, C<sub>7</sub>, C<sub>8</sub> — 0.5- $\mu$ fd. 450-volt paper.
- C<sub>5</sub> — 0.1- $\mu$ fd. 450-volt paper.
- C<sub>9</sub> — 100- $\mu$ fd. mica.
- C<sub>10</sub> — 0.002- $\mu$ fd. mica.
- R<sub>1</sub> — 2 megohms, 1-watt.
- R<sub>2</sub> — 50,000-ohm potentiometer.
- R<sub>3</sub>, R<sub>4</sub> — 10,000 ohms, 10-watt.
- R<sub>5</sub> — 5000 ohms, 10-watt.
- R<sub>6</sub> — 0.5 megohms, 1-watt.
- R<sub>7</sub> — 2500 ohms, 1-watt.
- R<sub>8</sub> — 5000 ohms, 20-watt.
- RFC — 2.5-mh. r.f. choke.
- L<sub>1</sub> — 3.5 Mc.: 32 turns close-wound.

7 Mc.: 16 turns close-wound.

L<sub>2</sub> — 3.5 Mc. and 7 Mc.: 4 turns, spaced  $\frac{1}{16}$  inch from L<sub>1</sub>. Coils are wound with No. 22 d.c.c. on  $1\frac{1}{4}$ -inch diameter forms.

L<sub>3</sub> — Audio transformer with primary and secondary connected in series.

**Power Supply.**

- T — 400-volt 100-ma. d.c. output transformer, with 5-volt rectifier and 6.3-volt heater windings.
- C<sub>1</sub> — 12- $\mu$ fd. 450-volt electrolytic.
- C<sub>2</sub>, C<sub>3</sub> — 8- $\mu$ fd. 450-volt electrolytic.
- L<sub>1</sub>, L<sub>2</sub> — 10-henry 85-ma. filter choke.
- S<sub>1</sub> — S.p.s.t. toggle.
- S<sub>2</sub> — S.p.d.t. toggle.



# ON THE ULTRA HIGHS



CONDUCTED BY E. P. TILTON,\* W1HDQ

**M**AY, that magic month of u.h.f. DX, has come and gone, and the 1940 season is off to a flying start. Greatly increased interest and activity, particularly in W4 and W5, the considerable improvement in equipment and operating technique, and a generally better understanding of the factors involved in working skip-DX have resulted in a total of stations heard and worked which probably exceeds that of any previous season, despite the fact that conditions appear to have been slightly less favorable, to date, than in corresponding periods of previous years.

Skip, in general, has been longer, in keeping with the trend noticed last summer. When 56-Mc. skip was first noted, in 1935, the usual contacts were W1, 2, or 3, to W8 and the nearer W9's; the average distance being of the order of 700 miles. Work thus far in 1940 has been almost entirely over distances in excess of 800 miles, with 900-1200 being most common. Significantly, fellows who are located at in-between distances from populous 5-meter areas have turned in long call-heard lists, reporting poor results in making contacts.

Up to 1938, the openings were frequently of long duration, with even the lowest-powered stations hammering in with terrific strength for hours at a stretch; 1940 finds openings spotty in most instances, with small areas open at any given time, and for shorter periods. Constant observation of conditions has taught many of the older hands at the game the fine art of figuring out just when and where the skip is going to pop, however, and most of us are convinced that we work DX on Five plenty of times in 1940 when similar conditions would have produced no excitement a few seasons back.

A complete listing of all the DX worked in the past month would make bulky and uninteresting reading; hence only highlights are reported herein. But let no one think that we are not interested in such reports. It has been requested in *QST* many times, and we ask, again, that anyone hearing or working any u.h.f. DX report his observations as completely as possible. This information is not only very useful to your conductor but it is also available to anyone who is genuinely interested in studying this most fascinating business of 56-Mc. DX.

The season started, in earnest, on April 29th, with a contact between W4EQK, Clearwater, Fla., and W5VV, Austin, Texas. Now both Tom Herrin, W4AKA (op. at EQK), and Wilmer Allison, W5VV, are hardened campaigners who have

worked plenty of DX on the lower frequencies, but when they got together on Five (for the first u.h.f. DX for both) neither could carry on a rational conversation, and both suffered a bad case of "fumblyitis." There's something about this business of DX on Five! We work the world on Ten or Twenty without a quiver, but let a W9, a W5, or a W4 break through on Five — and note the tenseness of the voices on the band! We sit on the edges of our chairs, our hands shaking, as we shout ourselves hoarse at some equally excited fellow a mere thousand miles away! We spend two-thirds of the year telling everyone that skip-DX doesn't really count in the u.h.f. picture — but whenever the skip breaks out, so does the gooseflesh!

The first extended opening occurred on April 30th when W4's had quite a time of it working into W1, 2, 3, 5, 8, and 9. Wednesday, May 1st, was better, with 900- to 1200-mile DX being worked generally over two-thirds of the country. May 2d was the peak, with practically the entire period from 9 A.M. to midnight open for DX in some parts of the country. DX was worked in every call area during this hectic period, and thirty-two states are included in the reports. Let

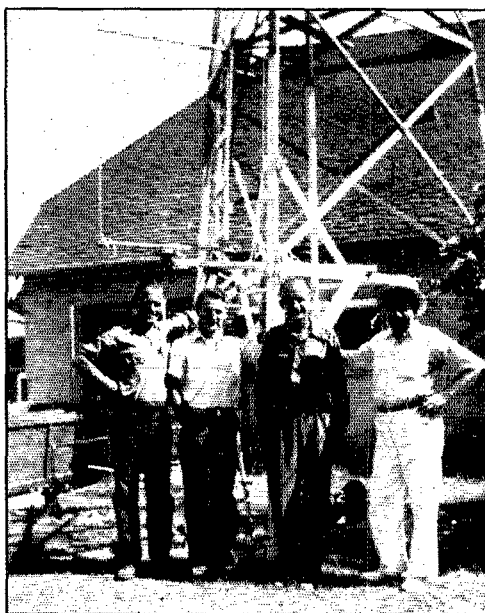

"The Four Horsemen of Phoenix." Left to right: W6QLZ, W6KKQ, W6KTT, W6JFO. Three-section vertical 8JK beam of W6KTT in background.

\* 329 Central St., Springfield, Mass.

no one say that DX cannot be worked on Five from his location!

### HERE AND THERE:

**O**BSEERVE Extraordinary is WILLL of Hartford. Brownie jumps that Skyriider back and forth from Ten to Five a dozen times an hour when DX is in the offing. And when it breaks, he's the guy who gets the first lick every time — and with a pair of 6L6's and an ordinary city location, too!

Getting on Five in a location where local signals are non-existent is quite a problem. The first thing we heard when we warmed up the receiver on the night of May 1st was a furor of W1's, 2's, and 3's, all frantically calling W4EQM. This had not subsided before a calm (and definitely southern) voice was heard "Calling CQ-Five; W4EQM, Langdale, Alabama, calling CQ-Five." Again the roar, as everyone in the skip zone went after Alabama — and again, the same voice "calling CQ-Five; W4EQM . . ." After about three rounds of this, some rather uncomplimentary remarks began to be injected into the calls of the die-hards who were still trying, but still no answer from the gentleman from Alabama! This was all solved a few days later when the boys at W4EQM discovered that the r.f. stage in their converter was not tracking. On May 4th the band opened again for W1-W4 work and the gang in these parts "got Alabama" in rapid succession. As this is being written, W4EQM tells us that he has worked only W1 and that he has never yet heard a local signal!

W4FPM, Atlanta, Ga., got his T-40 doubling from Ten on May 1st. Lee could hardly have picked a more opportune moment than 8:34 p.m. of that date, when his first "CQ-Five" netted W1HXP, quickly followed by W1's INJ, EKT,

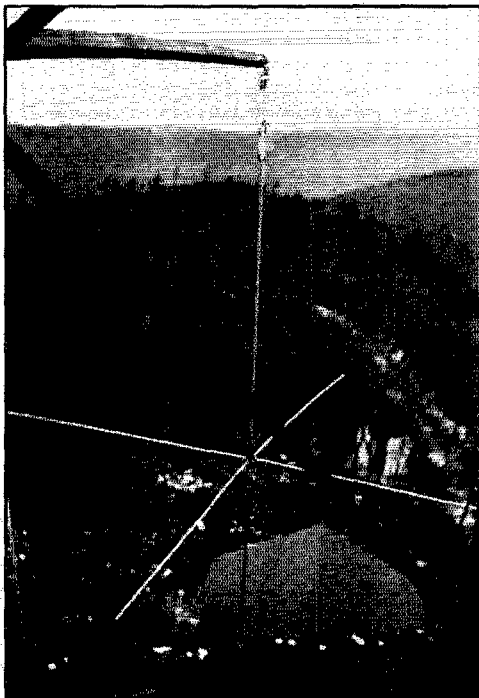

Ground-plane antenna used by W8CIR/8 during the May Relay. This looks like the answer to the problem of an efficient portable radiator. Concentric feedline permits vertical feeder without the usual mechanical troubles.

LKM, and HDQ; W3's BZJ, CUD, AIR, and GYG; and W8's PKJ and FYC. Not bad for a first-nighter!

New stations in W5 are bringing out the fact that this area is one of our best bets for skip DX. W5AJG and W5VV have reported the band open frequently during May, when no DX has been heard in the east at all. North-south work, particularly W9-W5, has been most frequent. Top performance of the month was turned in by W5AJG, Dallas, Texas, who polished off an even 50 contacts on May 2d. Starting at 9 A.M., Leroy worked W8CIR, and followed with 49 others in 14 states (Mass., N. Y., N. J., Pa., Ohio, Mich., W. Va., Va., Ill., Ind., Iowa, Wis., Minn., and S. Dak.); finishing up at 10:21 p.m. with 540 Marathon points for one day's work! The first 50-point contact to be recorded in the U.H.F. Marathon was made by W5AJG with W1DEL, Natick, Mass., 1550 miles. Also worked was your conductor but we happen to be a mere twelve miles under the 1500-mile mark! Leroy says he might have done better but he was sick that day and had to rest from 2 to 5 p.m. DX was worked from Dallas (by W5AJG or his partner, W5EHM) on May 1st, 2d, 13th, 16th, 18th, 19th, and 21st. On the 21st, both boys worked into Massachusetts again. This 1500-mile work is the subject of much discussion hereabouts, with some of us wondering if this is not extended single-hop work; 1200 miles is normally considered to be the limit of single-hop DX but the nature of this particular work has made it appear that only one hop was involved. If it was double-hop, then it must have been by a somewhat devious route, for there was no 750-mile business being done at the time Leroy and Pat were heard in Massachusetts.

Others in W5 who have been giving these old hands some competition are BHO and EEX of Houston; EIN and IHT of Big Lake; FNQ and FWS of Texon; and VV of Austin, all of Texas; and FYF of Oklahoma City. W5FYF heard W1HDQ, W2MO, W3BZJ, W8CIR, and W9USI, on May 2d. It seems that quite a few of us missed a chance at Oklahoma that evening — just because we neglected the high end. Yes, the band still goes to 60 Mc., and Vance holds forth on 59,476.

Another high-ender is W1BJE, Westport Harbor, Mass., 59,120. And while we're on the subject, W1ELP, Cambridge, Mass., would like to have you take a look above 58.5 for his f.m. signal. Bill runs 400 watts to 35T's — you can do that with f.m. — and the signal is easily read on even the most selective receivers. It may not sound too smooth, but it can be copied. There will soon be a 12-element beam up in the air 110 feet at W1ELP!

Did someone say that high power is needed to work DX on Five? Ask W5BHO, Houston, Texas, how he does it with 15 watts, a super-regen receiver, and a half-wave vertical antenna 12 feet off ground! The 600 watts at W5VV seem to produce a slightly different result. Wilmer gets plenty of heard cards but is having some trouble pulling in weak signals, though it seems that his DM-36-HRO combination should do the trick if anything will.

W6QG, Santa Ana, Cal., worked W7HEA, Zillea, Wash. (HK-54's, 225 watts; freq. 58 Mc.); W7FFE, Houlton, Oregon (110 watts to 809's freq. 58.5 Mc.); and W7FDJ, also of Houlton (160 watts to HF-100 on 57.2 Mc., 8-element vertical beam), on May 1st, between 8:35 and 9:30 p.m. (P.S.T.). Ray runs 30 watts, 'phone; 80 watts, c.w.; to a single 800. He reports that W6IOJ, North Hollywood, worked the same stations.

These fellows in California have a somewhat limited field for ordinary 900-1200-mile skip, as this radius takes in much sparsely-settled country. May 12th appeared to hold promise, as short skip was pronounced on Ten, but nothing was heard until 8:55 p.m. when an unidentified XE-1 was heard calling "CQ United States." The signal was badly frequency-modulated and was not positively identified but is believed to have been genuine, as the harmonic of XDA was reported in several places in the west at about this time. Five was open for W6QG again on May 18th and Ray worked the boys at Houlton, Oregon, again; and W7EUI of Kirkland, Wash. W7EUI, who runs 75 watts to 801's on 58 Mc., says that he finds that the band frequently appears to be open when he listens around mid-day, but that signals are seldom heard. The band was open for W6-W7 work from 12:30 to 2 p.m. on the 18th.

W6OVK is going to get some fellows on Five if he has to supply the equipment for them to operate! Jim sent a receiver up to 6GBN at Estrella Peak, and Tommy (GBN) now supplies the missing link between Phoenix and Tucson. Both W6QLZ and W6OVK are now working on W6PBD at Douglas, Ariz., to get him on Five. W5INI at Silver City, N. M., is expected to join this group in a projected Phoenix-to-El Paso 56-Mc. relay.

W9ZJB picked May (of all months, Vince!) to undergo an operation, but he got in on the fireworks early in the month, and expects to spend quite a bit of time at home "recuperating." Vince worked 23 stations on skip, on May 2d.

W9ZHB got going at 10 A.M., May 2d, and worked W5's AJG, EHM, EIN, IHT, FNQ, and VV before 1:30 P.M. That night Ed worked W1KRW; W3's GQS, AIR, CYW, and FJ; and W4AUU. At 11:22 P.M., Ed ran across the harmonic of W9HDU, Colorado Springs, who was on Ten. Changing to 28 Mc., ZHB found that HDU could not transmit on Five but could listen there, so Ed went back to Five and a contact was made with sigs equal to those on 28 Mc. Ed got all excited when he heard the harmonic of LSI on Five on May 19th, and dug down deep for some sign of South American DX, but without success. We are reminded that YV4AE promised W4FPM that he would be on Five shortly. He says he has heard W signals on Five and is determined to make the first Intercontinental QSO in 56-Mc. history.

## RELAY HIGHLIGHTS:

**W**ITH many of the high scorers yet to be heard from as this is being written, it is impossible to present a true picture of the scoring in the Fourth U.H.F. Relay of May 18th and 19th. Far greater participation was in evidence, and messages were handled over much longer routes than in previous events. It looks like W3AC/3 again, though Goynd had plenty of close competition this time. W2DEKJ/2 was right up near the top, despite a misfortune which cost him plenty at the outset. Art was working portable in a hospital, of all places, when the a.c. line he was using was switched to d.c. Some fireworks ensued, but luckily not much of the truckload of expensive apparatus Art had assembled for the event was in use at the time.

Messages were exchanged between W8CVQ, Kalamazoo, Mich., and W2AMJ, Bergenfield, N. J., during the contest period over a network consisting of W8CVQ, W8QDU, W8NYD, W8CIR, W8CIR/8, W3BKB, W3BZJ, W2AMJ; and slight variations of this net, to include W3AC/3, W3HWM, W3RL, and a flock of W2's and W1's, provided a nearly sure-fire route for east-west traffic.

Several openings for sporadic-E DX provided the means for an exchange of messages between stations which have been isolated in previous relays. A new record for snappy long-distance relay work was set when a brief opening gave W6OVK, Tucson, Ariz., a chance to give a message directed "To any East-Coast Amateur" to W5VV, at 7:12 P.M., Saturday. This was handed on by Wilmer to W9CLH, Roselle, Ill., a few minutes later. By a route not yet definitely known, but probably via W9VHG, this message was given to W8CVQ, who passed it on to W8QDU. Fred got it off to W4QN at Orlando, Fla., at 6:04 P.M., Sunday, thereby completing the nearest thing we've yet seen to a 56-Mc. Transcontinental Relay. That three skip contacts were required shows that we are still a long way from linking both coasts by a reliable u.h.f. circuit. Some "heads-up" operating on the part of W3AIR and W4ASE made it possible for a message from W1HUV, Winchester, Mass., to reach Florida in record time. As many inquiries have been received regarding the next Relay, we announce that the date has been set for the weekend of Sept. 14th and 15th.

## 112 MC.:

**H**ERE'S the story on the new 112-Mc. DX record announced last month. On April 21st, while operating atop Mt. Soledad, a 860-foot elevation near San Diego, Cal., W6OIN contacted W6BCX/6 at Mt. LaCumbre, 6 miles north of Santa Barbara, a distance of about 185 miles. The following Sunday, W6OIN working from the same location made contact with W6BCX, this time operating from Mt.

## U.H.F. DX RECORDS

### Two-Way Work

56 Mc.: W1EYM — W6DNS, July 22, 1938. 2500 miles.

112 Mc.: W6OIN/6 — W6BCX/6, April 28, 1940. 200 miles.

224 Mc.: W1KIJ — W1HDF, May 18, 1940. 13 miles.

Santa Ynez, a 4300-foot elevation, 20 miles northwest of Santa Barbara, an airline distance of 200 miles. W6QZA was at the same location and also worked W6OIN. W6BCX says that QZA was 20 feet farther away, and so should qualify as "champ."

The rig of W6OIN is an RK-34, parallel-rod oscillator mounted under the hood, with a concentric line feeding a quarter-wave radiator on the top of the car. Input is 18 watts. Receiver is a 6J5 mounted on the steering post, with the audio in the glove compartment. W6BCX used a mobile transceiver.

W6OIN reports that he has made about 50 contacts over distances around 100 miles in the last few months on 112 Mc., and conditions are just now beginning to be good! This 100-mile work with low power that has been reported so frequently from the west coast had us stumped for a while, as no one in the east seems to be able to even approach these results except by the use of high power in the very best locations. Ray explains this by saying that the California boys are blessed with very frequent and pronounced temperature inversions during all the summer months. As soon as the desert country to the east becomes heated, there is an overrunning layer of hot dry air at an elevation of 1000 to 6000 feet. The cool moist breezes from the ocean (that famous California climate, you know) form a perfect inversion setup which produces u.h.f. bending of an extreme nature. On both 56 and 112 Mc., contacts over distances of 100 miles or more are frequently made with very low power. Ray would like schedules with stations north of San Diego for tests on 224 Mc., to see whether this fortunate condition would permit long-distance work on this frequency also.

The record of 160 miles established last fall by W9VTK and W9WYX was also exceeded on May 5th, when Mike Villard, W1DMV, operating under the call W6YX/6, piloted a Piper Cub Trainer at an elevation of about 8000 feet, maintaining contact with W6HJT/6 located at Lick Observatory on Mt. Hamilton, until they were 165 miles apart; contact being lost abruptly when the plane was just north of Chico, Cal. The rig used in the plane was a pair of HY-615's in a resonant-line oscillator, powered with a Vibropack operated from a tiny 17-ampere-hour storage battery. At Mt. Hamilton, W6HJT/6 used a pair of HK-24's at 150 watts and a 3-element rotary beam.

These fellows point out that the advent of the new low-cost light plane has brought down the cost of rental of a ship of this sort to a point where any group interested in setting a new record for 112-Mc. work might do well to hire a couple of these ships and go to it. They point out that, for \$8.00, a 65-h.p. ship and pilot service can be had for an hour's time. This is sufficient to climb to 10,000 feet and still have approximately 15 minutes' operating at this elevation. With two ships at 10,000 feet, a range of operation of 320 miles is theoretically possible; a distance which is probably beyond the range of possibility from any ground location.

Our past experience in high-altitude portable work indicates that there are other factors than mere height above the surrounding country in this business of long-distance work on the ultra-highs. A good beam; a quiet location; a high-powered transmitter; and, most important of all, a fortunate condition as to temperature inversion, will go a

(Continued on page 108)

# ★ I. A. R. U. NEWS ★

Devoted to the interests and activities of the

## INTERNATIONAL AMATEUR RADIO UNION

Headquarters Society: THE AMERICAN RADIO RELAY LEAGUE, West Hartford, Conn.

### MEMBER SOCIETIES

American Radio Relay League  
Asociatia Amatorilor Romani de Unde Scurte  
Associazione Radiotecnica Italiana  
Burma Amateur Radio Society  
Canadian Section A.R.R.L.  
Československá Amatér Vysílací  
Deutscher Amateur Sende-und-Empfangs Dienst  
Eesti Raadio Amatooride Ühing  
Experimental Radio Society of Egypt  
Experimenterende Danske Radioamatører  
Federation des Emetteurs Belges  
Irish Radio Transmitters Society

日本アマチュア無線聯盟 Japan  
Lietuvos Trumpuju Bangu Radio Megeju Draugija  
Liga Colombiana de Radio Aficionados  
Liga Mexicana de Radio Experimentadores  
Magyar Rövidhullámú Amatőrök Országos Egyesülete  
Nederlandsche Vereeniging voor Internationaal Radioamateurisme  
Nederlandsch-Indische Vereeniging Voor Internationaal Radioamateurisme  
Newfoundland Amateur Radio Association  
New Zealand Association of Radio Transmitters  
Norsk Radio Relé Liga

Polski Związek Krotkofalowcow  
Radio Club de Cuba  
Radio Club Venezolano  
Radio Society of Great Britain  
Rede dos Emissores Portugueses  
Reseau des Emetteurs Français  
Reseau Luxembourgeois des Amateurs d'Ondes Courtes  
South African Radio Relay League  
Suomen Radioamatööritto r.y.  
Sveriges Sändareamatörer  
Unión de Radioemisores Españoles  
Union Schweiz Kurzwellen Amateure  
Wireless Institute of Australia

### VK BOOTLEGGING

**W**ARNING over-enthusiastic Australian experimenters of the danger from their attempts to carry on transmissions on the amateur bands, the editorial in April "Amateur Radio" points out the *Institute* has no sympathy "with those who are foolish enough to break the law in such flagrant fashion." The duty of all real amateurs, says the editor, is to cooperate with the authorities in the suppression of any further illicit transmissions. "We can hardly expect the penalty to be slight," he continues, "and we don't mind saying that we hope it won't . . . such a selfish and irresponsible attitude has considerably upset any chances the Australian amateur possesses with regard to the restitution of our experimental licenses."

### L.R.M. CONTEST

**T**HE 1940 edition of Lithuania's annual "Radio Contest" which took place in February was won by LY1AP in the radiotelephone section and LY1BX in the c.w. division. A unique feature of this L.R.M.-sponsored event is that it invites participation by all short-wave listeners, who are given points for their receiving work. The society points out that one purpose of these contests is to acquaint the general public with the work of the radio amateur. Many such listeners, having heard a number of local stations at work, become interested themselves in the hobby, join the association and so strengthen their numbers.

### LU MILITARY RESERVE

**F**OLLOWING what seems to be internationally a general tendency recently in amateur-government relations, the *Radio Club Argentino* has announced a proposed affiliation of radio amateurs with the military services, to be pat-

terned after the U.S.A.'s Army and Navy reserve affiliations. The plan was inspired by Captain Shaw of the Argentine army, and drawn up by Alberto E. Bird, LU4FD. It contemplates the establishment of nets, first by zones and second by the operating ability of member-stations. Although both 'phone and c.w. nets will be set up, it is expected the latter groups will make up the backbone of the organization.

Sr. Bird proposes likewise a number of special experimental amateur stations devoted to scientific research in radio, to operate jointly under the supervision of the *Club* and the government department of communications.

### S.A.R.R.L. RECESSES

**A**S OF June 30, 1940, the headquarters of the *South African Radio Relay League* is discontinuing all normal activities, pending cessation of hostilities, by decision of its executive council at the annual general meeting. The headquarters, now staffed only by a secretary serving in an honorary capacity, will handle only important correspondence with sections and divisions, relations with the government, and keeping the records of the *League*. "QTC" made its final appearance in April, and circular letters to members will be utilized should the need arise to get in touch with them promptly.

Effective May 1st, the postoffice department discontinued the handling of QSL cards. Those for foreign countries will not be accepted for transmission, and those arriving from other countries will be stopped and disposed of as the censor sees fit.

The Council has strongly urged each division to continue their activities, including regular meetings and publication of monthly news letters.

(Continued on page 70)

# 1940 A.R.R.L. QSO Party Results

BY E. L. BATTEY,\* WIUE

**A**CTIONS speak louder than words — and the scores listed here, representing the actions in the Third Annual A.R.R.L. QSO Party say more than words ever could regarding the success of the affair. Held January 6th-7th, 1940, this get-together for League Members enjoyed a considerably greater participation than either of the previous member-only parties. 533 operators reported results.

## Congratulations to the Winners!

Awards of tie holders with individually engraved diamond-shaped pendants have been made to the winners in the 62 Sections from which entries were received. There were no logs from Alaska or P. I. The champs are: *W1BFT*, *W1BIH*, *W1DFQ*, *W1EKN*, *W1EOB*, *W1KTB*, *W1LAB*, *W2GSA*, *W2HXQ*, *W2IOP*, *W3BES*, *W3BZE*, *W3EDP*, *W3HUM*, *W4AGI*, *W4AXP*, *W4CXY*, *W4DQ*, *W4EFM*, *W4EHF*, *W4EV*, *K4FCV*, *W5ASG*, *W5AWT*, *W5AQE*, *W5BKC*, *W5HAG*, *W5HHB*, *W5WG*, *W6AFH*, *W6CIS*, *W6CW*, *W6FYR*, *W6IPH*, *W6KFC*, *W6MUS*, *K6PAH*, *W6PAR*, *W6PBV*, *W6PUZ*, *W7AYQ*, *W7FJQ*, *W7GPP*, *W7JC*, *W8DZC*, *W8LCN*, *W8NCJ*, *W8OFN*, *W8QDU*, *W9CWW*, *W9EII*, *W9ENH*, *W9FOQ*, *W9FS*, *W9GKS*, *W9RQM*, *W9RSO*, *W9QPG*, *W9TH*, *W9VKF*, *W9ZAR*, and *W9ZTL*. 27 of these were also winners in at least one of the previous A.R.R.L. Parties, and their calls are indicated by italics. Special credit is due the following, who led their Sections in all three Parties ('38, '39 and '40): *W4AGI*, *W4CXY*, *W4EFM*, *W8LCN*, *W8OFN*, *W9CWW*, *W9RQM* and *W9VKF*.

## Participants' Comments

Some representative comments received from participants with their logs will serve to express the spirit of the affair and the manner in which it was received: "It was a lot of fun and I met a lot of old pals I used to QSO on 200 meters back in 1924." — *W9CLV*. "Surely had a swell time and especially got a big kick out of the increased use of break-in." — *W5CJP*. "My 7½ watts worked better than I thought they would! Made 9212 points." — *W9NYH*. "W.A.S. has eluded me for 15 years. For 2 years have lacked only Delaware and Vermont at this QTH. In last hour of contest, Vermont answered CQ at 11:15, and three contacts later at 11:30, Delaware answered CQ, for W.A.S. here!" — *W6MUF*. "All my rigs were torn down except the little 10-watt emergency 'standby' rig. Don't feel so badly at the

way it worked 'em in this hot contest — and a couple of W6's, too." — *W8AQ*. "It was an excellent affair particularly because the prevailing spirit was definitely a 'party spirit' with plenty of good fellowship." — *W3DPU*. "Met old timers of some twelve years ago. Hope we have another real soon." — *W8AOR*. "May I say that I greatly enjoyed the time spent in operating in the contest and lend my voice to those looking for a bigger and better one next year!" — *W3ATR*. "New station record of 40 QSO's in one hour." — *W3BES*. "This contest has everything the boys have said. It has all the fun of the SS, ORS and DX contests combined." — *W2IOP*. "Enjoyed copying the 'clean cut' c.w. signals in this Party, but regretted the lack of participation on the 'phone bands." — *W2HXQ*. "Handled 15 messages during the contest just to show the spirit of the 'A.R.R.L.' Will be looking for the next party." — *W3GJY*. This contest is more fun than others I think because there is more of a personal feeling in the contacts." — *W1KRQ*. "This contest affords a nice diversion and chance to contact lots of old boys and know that they are still alive." — *W9CWW*. "The inactivity of the 'phone gang was the big disappointment of the contest. There were hours at a time when I failed to hear a single 'phone station besides my own call 'A.R.R.L.' " — *W7UQ* (*W9AHR* op.) "It was great fun working all the familiar calls again. I have been in all three of the A.R.R.L. parties held so far and enjoy them a lot, even more than the SS." — *W9RQM*.

## Highlighters

The highest scorer in each district: *W1TS* 37,200; *W2GSA* 36,669; *W3BES* 43,140; *W4EV* 29,441; *W5WG* 31,742; *W6KFC* 32,860; *W7GPP* 10,752; *W8OFN* 36,934; *W9RQM* 38,491.

Those scoring over 25,000 points: *W3BES* 43,140, *W9RQM* 38,491, *W1TS* 37,200, *W8OFN* 36,934, *W2GSA* 36,669, *W9RSO* 36,580, *W2IOP* 35,055, *W9ZAR*, 33,524, *W9EYH* 33,110, *W9FS* 33,060, *W9VDY* 33,060, *W6KFC* 32,860, *W5WG* 31,742, *W9TH* 31,692, *W3EDP* 31,130, *W8QDU* 30,576, *W4EV*, 29,441, *W5KC* 29,028, *W2HHF* 27,984, *W1BFT* 27,390, *W3DGM* 27,280, *W9CWW* 27,000, *W8NCJ* 26,180, *W9ZRP* 25,252.

Leaders in number of members worked: *W3BES* 360, *W2GSA* 360, *W9RQM* 316, *W2IOP* 313, *W8OFN* 313, *W1TS* 310, *W9RSO* 310, *W9EYH* 301, *W9ZAR* 289, *W9VDY* 285, *W3EDP* 283, *W9TH* 278, *W9FS* 276, *W8QDU*

(Continued on page 70)

\* Assistant Communications Manager.





# HINTS AND KINKS FOR THE EXPERIMENTER

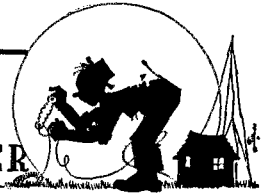

## STARTING TOOL FOR DRILLS

READING the article about polystyrene insulation, page 32, *QST*, Aug., 1939, in which it is stated that a heavy blow with a center punch may cause a star fracture, prompted me to write you suggesting the use of a tool which I have found extremely useful for starting holes in the construction of radio apparatus. The tool is easily made from a small triangular file, as shown in the illustration of Fig. 1.

The file is ground similar to one half of an ordinary drill bit, but comes to a point in place

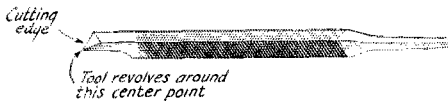

Fig. 1 — Tool for starting drills in metal or other materials.

of the web and has no twist. It is used in an ordinary hand drill. It cuts quickly and will not slip or run. Drills have no tendency to slip or run when the hole is started with this tool; it is not necessary to use a center punch. — Gordon Crayford, Lacombe, Alta.

## LOW-COST 14-MC. VERTICAL

W9EVD of River Forest, Ill., sends in the description of simple 14-Mc. vertical antenna which he and several of the other boys around his neck of the woods are using with good results. The thing is so simple that it ought to be possible to run it up in an hour or two.

A rough idea of the arrangement is shown in Fig. 2. The bottom part is a 22-foot "two-by-two" on which are mounted stand-off insulators to carry a 21-foot length of antenna wire. To the top end of the "two-by-two" is fastened one of those collapsible "window-sill" h.c. receiving antennas. These antennas may be obtained with a 12-foot length which, when added to the 21-foot wire, makes a 33-foot half-wave antenna for 14 Mc.

The assembly is light enough so that one person should have no difficulty in managing it on top of a roof while the guying ropes are fastened in place. Wire could be used for the guys if broken up into small sections with insulators but W9EVD has found that rope guys will do a good job and last a long time if they are soaked in linseed oil before using. He uses ordinary clothesline.

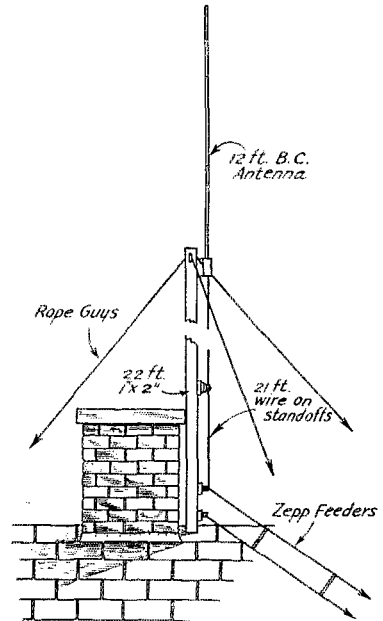

Fig. 2 — Simple 14-Mc. vertical antenna costing less than three dollars.

Any conventional method of feeding the antenna may be used; W9EVD feeds his at the base with Zepp feeders.

## ELIMINATING 'PHONE INTERFERENCE WITH LINE TELEPHONE

IF OTHER amateurs operating powerful 'phone transmitters in the 20-meter band have as much trouble as I have had in clearing cross-talk with their own (and neighbors') telephones, the diagram of Fig. 3 will enable them to clear entirely the interference without impairing the operation of either the telephone or radio transmitter.

This type of trouble results in the radio transmission being heard often S9-plus in the telephone receiver and is the result of r.f. rectification in the carbon telephone transmitter. The standard telephone practice is to put r.f. chokes in the fuse box in the telephone line and, in some cases, by-pass the transmitter with a mica condenser of about 0.002- $\mu$ f. capacity. This generally clears up interference from r.f. pick-up from

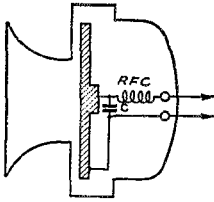

Fig. 3 — Filter for eliminating interference with telephone installations from ham 'phone transmitters. R.F.C. is a jumble-wound coil of 25 turns No. 24 d.c.c. 1½-in. diameter. C is a capacity of 0.002  $\mu$ fd.

adjacent police radio stations, 80-meter 'phones and other stations operating on the lower frequencies. In my case all the usual devices failed to stop the interference and the telephone trouble department was unable to do anything further, while complaints were becoming severe.

A series of experiments showed that the trouble could be reduced by shielding the telephone lead-in wires. The most effective and complete cure, however, was simply to wind about 25 turns of No. 24 d.c.c. wire in a jumble-wound coil about 1½ inches in diameter and put it right in back of the telephone transmitter, connecting it in series between the lead connected to the center terminal as shown. A mica by-pass may be required on some installations and it is a good preventive against more complaints if the station operates on other frequencies. The telephone trouble men were shown this and were glad to find a way of clearing the trouble. They put in similar chokes at several other points where interference was severe, entirely clearing the trouble in every case. They said that the same conditions were noticed on the telephones near the local airport because of interference from the radio stations there and because several frequencies were used, the trouble had been difficult to clear entirely.

I hope this may help some of the other boys who may run into this trouble. — *A. G. Sheffield, VE4SS.*

### NEUTRALIZING R.F. STAGES WITH A MODULATING MONITOR

I SUPPOSE that there is nothing new in ham radio, but from time to time we do run across ideas that are new to us. Here is something I discovered by accident. I have never seen the idea published.

While changing bands in the old rig, I always tuned the buffer stages with the final plate power off and, in so doing, I noticed the modulation monitor's carrier-level meter showing a reading. With a little thought, I realized I had a very sensitive neutralizing indicator.

With this method I re-neutralized all the r.f. stages and was surprised at the amount of neutralization that was necessary to eliminate all the r.f. in the various tank circuits.

For a high degree of accuracy, the monitor can be rather tightly coupled as the tubes become more perfectly neutralized. Also, the percentage-of-modulation indicator will register any audio frequency that might be introduced in the various stages by hum or feedback.

Try it sometime and see if your stages are perfectly neutralized. — *Phillip F. Jones, Jr., W4FWD.*

### 'SCOPE COUPLING

COUPLING a cathode-ray 'scope for r.f. energy from a 'phone rig employing link coupling from the final to antenna or antenna-tuning unit generally means the use of an extra coil. The diagram of Fig. 4 illustrates a simple but effective means of securing the voltage without the necessity of an extra coil, while the coupling may be easily varied to the correct value for any band.

In the diagram  $C_1$  may be any small condenser, such as a double-spaced 35- $\mu$ fd. variable. This condenser is connected to one side of the link coil, which may be any of the numerous types on the market. Then, the other side of the condenser is connected to the ungrounded terminal of the vertical deflection plates. The r.f. input may be varied by increasing or decreasing the capacity of the condenser.

With link coupling to an antenna tuner unit, the link may have to be grounded either directly or through a condenser,  $C_2$ . This might be of more importance at low power than at the

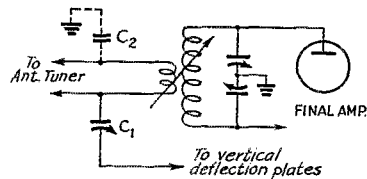

Fig. 4 — Coupling oscilloscope to link output. (See text for values.)

higher powers. The idea of unbalance may be suggested, but satisfactory operation doesn't require much capacity and any unbalance introduced will be slight. — *George W. Brooks, W1JNO.*

### IMPROVING THE USEFULNESS OF A GLOBE

THIS is a relatively simple way to fix up your globe (without mutilating it) to enable you to determine the great circle direction of certain points from your home. The necessary implements are a pencil, a short piece of fine wire, and a common pin.

Wrap one end of the wire around the pin, place the pin on the equator of the globe, run the wire along the equator to a point 90 degrees from the pin point and at this point wrap the wire around the pencil point. A little nick on the side of the lead near the point will help to keep the wire from

slipping off the pencil point. Check a number of times and make certain you have exactly 90 degrees between your pencil point and pin point. In this checking you will notice that unless your wire is taut and exactly along the equator, your measurement may be off as much as a degree or more. Be sure the wire is near the points of the pin and pencil to reduce error.

Then, put the pin point on the location of your home and proceed to make a circle around the globe with your home as the center. The idea is shown in Fig. 5. I found the best way to do this was to swing the pencil through an arc of an inch or so, holding it taut, then mark the globe for about a half inch or so, and then move on and repeat. The reason for taking this added precaution is that the wire has some lag in following the pencil and it tends to bring the pencil a degree or so closer to the pin point.

After you have the circle completed, mark due South on it and make certain it is accurate. If your globe doesn't have a ring on it, you can run a string from pole to pole through your home town and determine due South in this manner. (If you are south of the equator, due North will be your starting point on the circle.) Now take your wire, pin, and pencil, without altering, and mark off your 90-degree spots on the circle. If your work is accurate, you will come out even. (Suggest you work both ways from starting point.) Then mark off 45-degree spots and 10- or 15-degree spots if you wish.

Now take a narrow strip of paper and place it along the equator and mark off 15 or 45 individual degrees on the paper and then, with this paper scale, mark off the degree points on the circle.

In numbering your degrees on the circle, start with North as zero and move westerly from this point around the world numbering every 10 or 15 degrees back to North as 360 degrees; i.e., NE is 45 degrees, East is 90, South 180, West 270, etc.

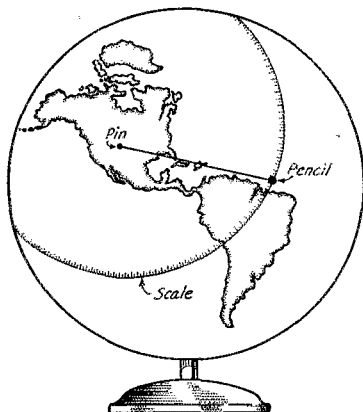

Fig. 5 — New scale on globe by which bearing from the home location to any point may be quickly determined.

Now whenever you want the true direction of a certain place from your home, just stretch a string between the two places and see where it crosses the circle you have made and you have it.

A card or a composition disc with 360 degrees marked on it is a handy thing, especially when you have determined where true North is by means of polaris or old sol (covered in previous issues of *QST*).

You are now ready for a lot of fun and quick calculating and figuring for that new antenna or directive array you have been planning. — *John S. Ingraham, W7CYC.*

#### NOTE ON TUBE KEYING SYSTEMS

W5CY points out that a reduction in drive to a stage in which a tube keyer is connected may result, if provision is not made to keep the operating bias at the same value used without the keying tubes. The amplifier grid return is normally made to ground, as shown at "A," Fig. 6, so that if the keyer tubes are connected between the amplifier center tap and ground, the

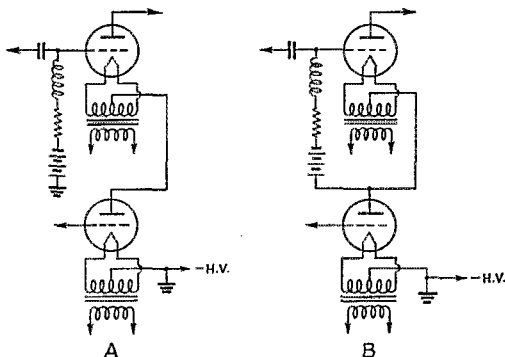

Fig. 6 — Grid returns with tube keyers. The common version shown at A may require an adjustment of amplifier bias to prevent over-biasing.

voltage drop across the keyer tubes will be applied as additional bias to the grid. W5CY suggests connecting the grid return to filament center tap, as shown at "B," but this leaves the keying tubes in the negative high-voltage line only. It should be possible to effect an equivalent remedy by simply decreasing the grid-leak resistance, leaving the grid return connected to ground and maintaining center-tap keying.

#### OUR COVER

W2BRO's 2½-meter crystal-controlled television transmitter rates the nomination for Cover I this month. The u.h.f. boys may well benefit from the description of Lee Waller's rig — even those not committing television at the moment.

Our thanks go to Bob Burnap of R.C.A. for getting this shot for us.



## CORRESPONDENCE FROM MEMBERS

The Publishers of *QST* assume no responsibility for statements made herein by correspondents.

### READ THE REGS

Editor, *QST*:

Cheney, Washington

There seems to be a growing practice lately of purposely removing some of the final power supply filter for the purpose of making the note "easier to distinguish," particularly during contests. I have heard that a few actually admitted this practice. Now, while the resulting note isn't exactly raw a.c., it is definitely not the ideal note for amateurs today. In fact, it is illegal, besides being very undemocratic with regards to other amateurs who strive to keep the c.w. note nothing less than T9. Let's see if we can't all strive to keep our notes on a T9 basis.

Another point which many of us have forgotten or neglected is section 324 of the F.C.C. R&R. It is still in effect, you know, and pertains to amateur radio as well as commercials. It in effect says that all stations must use only sufficient power to insure satisfactory communication over the given distance and under the existing conditions. Now we can't possibly stick to this rule with engineering precision, but we can do something about the abominable practice of using 500 watts or more for those cross-town roundtables on 160 meters. There are many grounds for a short call or test across the street on a kw., but if we are going to spend the evening talking to the next door neighbor or the friend two miles away let's use a low-power rig — say a two-stage plate-modulated rig running 3 to 10 watts input. My 6F6 final with 5 watts input gives me very nice reports on 160 'phone at distances of 50 to 100 miles . . . and does not interfere with stations across the state during the busy hours on the band. You'd be surprised what you can dig out of the junk box. I didn't spend one cent for my flea-power rig. Also it saves a great deal on power bills on local contacts.

I advise all amateurs to take an evening off during the next thunderstorm and read all the rules and regulations of the F.C.C. Then let's resolve to keep our operating and engineering practices within the law. It is the best insurance I know of to keep our rights to use the amateur bands.

— Harry K. Long, W7CQK

### W2AOE, W9AEJ AND OTHERS

742 Central St., Plainfield, N. J.

Editor, *QST*:

I note with interest W9AEJ's comments on my proposals. Evidently he and undoubtedly many other hams fail to realize the size of our need for new amateurs on the ultra high frequencies. If all the hams that we will get in the next twenty years by the present methods could be brought on the air at once and forced to go on u.h.f. for all time, our u.h.f. population would still be pitifully small. We need new types of amateurs and new methods of getting them.

Amateurs fail to realize that playing dog in the manger is a good game only if you are sure of your manger. In our case the F.C.C. can take away our little used playgrounds on the basis of lack of occupancy. With commercial television, frequency modulation, facsimile, aircraft and countless other services crying for more room, how can we possibly expect to hold large slices of the spectrum when giving them little or no use?

If amateurs really are supposed to be of assistance to the country in time of war, I would like to point out that the opinion of our Australian friends has long been outmoded. Our Army is going to 'phone in an increasing number of places where speed, not secrecy, is essential. In time of war

we will need thousands of radiotelephone operators and, what is more important, people who can service this type of equipment. It is of course quite true that we will need trained c.w. men, but we are getting them by our present methods.

In the light of the present blitzkrieg tactics in Europe, it seems to me that the League can be of the greatest possible service to the country by immediately instituting steps to prevent our government from committing the colossal folly of shutting down amateur radio stations in time of war. Let us present instead a comprehensive plan for the creation of country side u.h.f. nets with inter-connections to the present A.A.R.S. and N.C.R. for the purpose of reporting aircraft flights, parachutists, etc. We need little elaboration to see that with wire communications disrupted, amateur radio offers the only possible means of taking care of this situation. Such a plan would require thousands of operators, not the paltry few in action today.

With such a plan in force, the old idea that a shutdown of amateurs in war time is essential would have little or no ground to stand on. This idea is based on the assumption that with no amateurs on the air no spies will use radio. It is about as effective as the "concealed weapon" laws are in preventing criminals from carrying guns. But unless amateur radio can offer some actual benefit to the country, there would be no point in maintaining it and taking the time to supervise it.

Can someone give a good reason why we should not have 50,000 hams on the u.h.f. bands, with or without code training, that will outweigh in importance the saving of these frequencies for amateur use, and the obvious service such a group can render in time of war?

— D. A. Griffin, W2AOE

Huron, So. Dakota

Editor, *QST*:

I think the suggestions of W9AEJ in his article "Another Solution" on page 51 of the June, 1940 issue of *QST* practical, and would like to see it a part of our regulations. Too many new hams who have not been with us long enough to acquire the proper ham spirit go on 160-meter 'phone with tight-coupled misfit antennas, doubling in the final and causing widespread harmonic interference to b.c.l.'s. They never become good operators nor do they ever find out the advantages of c.w. over 'phone. The suggestions of W9AEJ would build a better class of amateurs.

— Philip G. McGinnis, W9IQD

Griffin, Indiana

Editor, *QST*:

May *QST* arrived yesterday, and as usual I turned first to the "Correspondence" section. An article under the heading of "Another Solution" met my eye. I read and re-read it and found it hard to believe that any sane individual could sign his name to such a mess of words and statements. I went back and gave a few minutes to the ideas expressed by W2AOE in his story of how it should be done and I would have held myself in check, had not W9AEJ come forth with the complete solution. I am not fully in accord with W2AOE, not by a long shot! When someone comes along with a problem to be solved, of course then we must have a solution. But until there is a problem to be solved, why in tarnation

(Continued on page 68)



# OPERATING NEWS

F. E. HANDY, WIBDI, Communications Mgr.

E. L. BATTEY, WIUE, Asst. Communications Mgr.

**A.R.R.L. Extends Its Code of Neutrality Precautions to Prohibit Any European Contacts.** The extension of the European conflict again focuses attention on the necessary precautions that radio amateurs should observe to permit unrestricted continuance of our amateur radio in the United States.

This is *not* the time to demonstrate how amateur radio can cross certain international boundaries. For the last three months *QST* has recommended avoidance of any radio work with belligerents or any amateurs in the theater of war. Irresponsibility of certain licensees cannot be condoned. It must be emphasized that any amateur who will work a belligerent or a European (since all are involved or close to involvement) is totally inconsiderate of the more important rights of himself or his fellow amateurs. It is high time that individual tolerance of every license holder toward any few who insist on jeopardizing his privileges, be thrown out of the window. It is the right thing for all of us to monitor our DX bands closely and ask full cooperation of any amateur who flouts any part of our precautionary code. The League's Official Observers are on the job doing this, but let every one of us help.

The League now extends its code of operating precautions, printing them prominently again

below. Please comply with the following points carefully, and also *make yourself part* of the informal Neutrality Patrol. Contact by radio direct (or send radiograms if unsuccessful) any amateurs heard wherein it seems necessary to ask better observance of any one of the operating precautions set forth. Send A.R.R.L. the name and call of any amateur who is uninformed, or non-coöperative, or misunderstands this situation and its importance to all of us, so we may take steps to send him information.

The views in Washington on the actual situation are extremely realistic in the various governmental departments. Our friends there hope that for our own good we shall not require more monitoring surveillance or restriction. This is a request that every licensee who reads these lines may do his part in observing the precautionary code, and assisting others to do likewise. A.R.R.L. will gladly send information to any amateur who tells you he is uninformed or misunderstands. Let us remember that *there is surveillance*, and be watchful to see that the sensible precautions are observed, to avoid possible curtailment.

— F. E. H.

— . . . —

## AMATEUR RADIO AND THE IMPERIAL VALLEY EARTHQUAKE

"On Saturday, May 18th, at 8:37 P.M. P.S.T. (time courtesy of stopped clocks), a sharp earth tremor was felt at many points in Southern California. Most severe shocks were at Brawley and Imperial, where the writer was at the moment passing several others who were in a hurry to get out from under a building. We were in the downtown area at the time. Most of the people killed were doing the same as we were, running out of collapsing buildings and being struck by falling arcades; however, I guess my number wasn't up!

"As the brick dust settled from fallen buildings in the first shock, I was able to find my car under an arcade, as yet undamaged, and finally drove over to the house. Everyone at home seemed OK except for fright, so I proceeded to put the rig on the air, the power having come on in the meantime. I raised W6DZC at Loma Linda and requested him to notify the Red Cross, etc. Shocks continued, a very severe one at 10:30 P.M. doing over a million dollar's damage at Brawley.

"Notable work was done by W6DZC, who stayed on the air all night handling messages and watching the frequencies of stations active in the area. Numerous messages were handled by W6PTM, DAZ, DZC, OXQ, VEY, GG, EFD and MMW on 3.9 Mc. The Amateur Net for the American Legion on 1.75 Mc. was active all night, with W6LCU and W6NLY in the valley doing an excellent job. W6QNM, San Diego, whom I contacted shortly after 9 P.M., and W6JVK, W6DEP and W6DXM, and many others on the Coast, did splendid work. Telephone lines were not entirely out but were swamped under the tremendous traffic load. A Los Angeles newspaper stated that its first information about the quake came via amateur radio."

— Chuck Lunder, W6HWJ

### POINTS IN EXTENDED A.R.R.L. CODE OF OPERATING PRECAUTIONS

1. Do not contact *any* European station.

2. Do not relay anything from one country to another: confine any international contact to technical subjects or trivial small talk.

3. Do not use any code or cipher\*; use plain language, English recommended. Sign *each* transmission with your assigned call; do not permit unlicensed operators to use equipment; contact no unlicensed stations; follow every F.C.C. regulation with utmost care.

4. Do not talk about the war over the air (even among ourselves), or discuss any happenings that might have military significance.

\*Only exception, authorized AARS/NCR station drills.

## ARTICLE CONTEST

Which do you consider "the most interesting amateur band?" If you have followed the contest articles in the past few issues of *QST* you know what some of the gang have to say on this subject. We are inviting more articles for the C.D. contest based on various individuals' ideas of the most interesting band. What is your choice?

A. J. Burton, W5BDX, wins the prize this month with his article, which approaches the question from a somewhat new angle.

Send in your article on why such-and-such-a-band is, in your opinion, the best available. Each month we will print the most interesting and valuable article received on this subject. So far articles have been printed on the Ten, Twenty, Forty and Eighty Meter bands. Please mark your contribution "for the C.D. contest." Prize winners may select a 1940 bound *Handbook*, *QST* Binder and League Emblem, six logs, eight pads radiogram blanks, DX Map and three pads, or any other combination of A.R.R.L. supplies of equivalent value. Try your luck!

## The Most Interesting Band

BY A. J. BURTON, W5BDX\*

**MY FAVORITE** band? Why One Hundred-Sixty Meter C.W. is the best band for local ragchews with low-power, for passing traffic across town and for medium distance contacts, although it isn't very hard to work all states on One-Sixty C.W. if a fellow wants to make the effort. On the One-Sixty 'phone band, practically any kind of a contact can be made, as a listen any evening will demonstrate. Most of the Army Amateur Phone Nets operate on this band with excellent results and for neighboring contacts with fellows you have met or hope to meet in the future, One-Sixty 'phone is swell.

Now, to take part in organized activity on C.W., Eighty Meters is perfect. There we find the trunk lines, the group nets, and Army Amateur C.W. nets. To pass traffic to practically anywhere just get on Eighty C.W., give a short CQ QTC and the traffic hounds will be on your neck, or rather frequency, like a ton of bricks. If you are a rag-chewer you will find plenty of like-minded operators there. If you are looking for DX it's on Eighty also and, brother, you really get a thrill working DX in Eighty Meters. Then there is Seventy-Five Meter 'phone, and my friend, that is a band. Local vicinity rag-chews all day long, up to three or four hundred miles, and at night, take your pick, far and near, all over the country.

So down to Forty Meters where we have practically everything, traffic, rag-chews, DX, nets, contests, low power, medium power, high power, everything, everywhere.

And then Twenty Meter C.W. Do you need those hard-to-get states for W.A.S.? You will probably find them here. Or more countries for the Century Club or that elusive Asian? Here they are; dig them out. If you are a 'phone addict and also a DX hound Twenty Meter 'phone is your meat.

Suppose we don't have a class A ticket and want to work 'phone DX? We just drop down to ten meters and there we have practically the same as Twenty Meters. Not as much QRM, maybe not quite as consistent but full of lots of surprises. Low-power is just as good as high-power on Ten Meters too. Ten Meter C.W. is good for everything, too, but lately it hasn't been very occupied. Maybe if we get on that band it will wake up.

So we come to Five Meters. Perfect low power, local band, fixed station or mobile, and any time DX might pop

into your receiver. What a thrill to be talking to locals and have the DX start to roll in.

Now Two-and-a-Half Meters is opening up with lots of experimenting with both amplitude and frequency modulation. If we are of an investigative mind by all means we should get on that band or even One-and-One-Quarter Meters. There's lots of room for experimenting.

So it settles down to this: My favorite band — the Most Interesting Band — is the band I choose to operate on any given time, depending on my operating interest at that time! They are all interesting, depending on what I want to do.

## O.B.S.

The following is a supplement to the list of A.R.R.L. Official Broadcasting Stations in October *QST* (page 76): W1LVK, W2HXQ, W2KXT, W4EFD, W8REC, W9BQY.

## Brass Pounders' League

(April 16th-May 15th)

Call	Orig.	Del.	Rel.	Extra Del. Credit	Total
W9QIL	79	192	1800	176	2247
W4PL	9	27	1891	25	1952
W3GKO	28	46	1262	27	1363
W2ITX	36	126	1022	100	1334
W4IR	26	113	1076	91	1306
W7EBQ	25	77	1134	59	1295
W3EML	84	210	678	206	1178
W2LZR	52	91	755	79	977
W8GZ	14	33	870	32	949
W6IOX	25	51	786	45	907
W9CRO	5	451	330	64	850
W2SC	50	201	348	197	796
W6PCP	150	228	200	200	778
W4FJR	50	60	600	52	762
W3CIZ	75	138	401	125	739
W6LUJ	127	256	74	252	709
W9ILH	18	40	624	19	701
W4BDB	19	14	640	9	682
W5FDR	101	134	317	127	679
W1KKS	33	38	602	4	677
W3BWT	53	54	515	45	667
W8S5J	14	17	628	5	664
W5CEZ	32	139	432	25	628
W6PGB	59	50	454	48	611
W3QP	214	200	0	194	608
W9NPL	7	18	549	16	590
W9EKQ	4	8	502	33	547
W2PL	148	163	72	141	524
K4IHR	1091	750	570	697	3108
K4IHQ	580	350	978	338	2246
W50W	137	159	1590	100	1986
W1AW	81	99	315	92	587

These stations "make" the B.P.L. with total of 500 or over. One hundred deliveries + Ex. Del. Credits also rate B.P.L. standing. The following one-operator stations make the B.P.L. on deliveries. Deliveries count.

W9ZFC, 240	W2MT, 135	W5GFH, 113
W5HAG, 183	W6RBQ, 132	W1FFL, 111
W3HRS, 176	W1JCK, 121	W5EOE, 111
W2GVZ, 158	W9NCS, 119	W5FOM, 108
W3BZE, 153	W9BHY, 117	W8ASW, 107
W7APS, 148	W3EEW, 116	W1GTN, 102
W9CGK, 145	W5ZM, 116	W1KCT, 102
W9VQG, 136	W9DUX, 115	

### A.A.R.S.

Call	Orig.	Del.	Rel.	Extra Del. Credit	Total
WLTW (W9QIL)	50	98	496	88	732

### MORE-THAN-ONE-OPERATOR STATIONS

Call	Orig.	Del.	Rel.	Extra Del. Credit	Total
WLM (W3CXL)	177	167	3270	84	3698

A total of 500 or more or 100 deliveries + Ex. D. Cr. will put you in line for a place in the B.P.L.

\* 910 South 25th St., Fort Smith, Arkansas.

**FLASH! . . . A.R.R.L. Code Proficiency Certificates are to be issued monthly to amateurs who qualify for them.**

WIAW regular transmissions by tape at 15, 20, and 25 words per minute will be supplemented by additional practice transmissions. One schedule per month will be transmitted on all WIAW frequencies for rating purposes. See full details next month.

Every licensed amateur is eligible for one of the Code Proficiency Certificates. It will be a chance to prove yourself a true amateur, and receive evidence of your increase in skill after being licensed. The certificates will be given for reporting "solid copy" by ear on the official monthly transmission of plain language groups at fixed speeds.

As the transmissions are continued increased skill will receive recognition when it is demonstrated. QST will report the calls of all who receive certificate awards. See next month's announcement for details. It is not too early to start practicing copying the WIAW and other OBS transmissions, planning round-table groups (clubs) for making definite code speed gains possible. There will be a Club Certificate available for individual attainment in such groups, too. The way to get set for the first test transmission is to try to set down on paper for 15 to 30 minutes each day something that is a little faster than can conveniently be set down correctly. Count on nailing down an A.R.R.L. Code Proficiency Certificate in the first run, to be announced in next QST.

— Communications Manager.

**BRIEFS**

Capt. S. C. Collins completed four years as Liaison Officer, Army Amateur Radio System, this June. His new post will be at Patterson Field, Ohio. His successor is Lieutenant Stevenson who was formerly the Officer in Charge of station KA1HR. He will arrive in Washington sometime in June.

— . . . —

**NATIONAL SOARING CONTEST**

The Eleventh Annual National Soaring Contest will be held in Elmira, N. Y., from June 29th to July 14th. Amateur radio has played a big part in all the soaring meets held in Elmira, providing emergency communication in case of disaster, handling traffic, and furnishing communication between the different take-off sites and between the launching winch and the glider, which many times were out of sight of each other.

The Elmira Amateur Radio Association again this year is sponsor of radio communications and has appointed John Mulligan, W8RTW, director of communications. Application has been made to F.C.C. for the call W8USA, which was granted for use at the 1939 meet. It is hoped a 100-watt all-band transmitter will be available for traffic handling and general rag chewing. Portable-mobile rigs will handle the launchings and landings. All amateurs are cordially invited to attend this meet. Bring your tickets! All field operations will be carried on in the 28-Mc. band. There will be daily 28-Mc. glider-to-ground work, and it is requested that all hams be on the look-out for this flea-power transmitter. Any and all reports of reception will be greatly appreciated.

— . . . —

**April '40 O.R.S.-O.P.S. Parties**

With the absence of W3BES from the April O.R.S. Party, a "dark horse" stepped up into first place with a "beautiful" score — W3HQE. We understand that BES was on for less than one hour. It may have been a case of "when

the cat's away . . ." Hi. Congrats to W3HQE and also to W3DGM, who was a close second. In the O.P.S. group W9WXL pushed up into first place, followed by W2JME and W4QL, all more or less new faces in the front row. FB! The next quarterly get-togethers for O.R.S., O.P.S. and all League officials are scheduled for July 27th and 28th. Don't miss them!

**Official Relay Station Scores (April)**

Station	Score	Diff. Sns.	Diff. Sects.	Heard	Power (Watts Input)	Operating Time
W3HQE	21,101,366	232	54	16	750	19 h., 55 m.
W3DGM	20,916,212	242	54	12	300	20 h.
W1TS	17,788,440	215	56	—	350	17 h., 5 m.
W9BYH	17,667,020	209	56	18	90	18 h., 55 m.
W4EV	16,782,582	223	55	19	400	19 h., 20 m.
W3GJY	14,993,253	215	54	27	100	18 h., 45 m.
W3GHM	13,680,000	202	44	—	500	20 h.
W3HUM	13,032,411	197	52	9	100	17 h., 55 m.
W9QPG	12,454,477	206	51	6	100	20 h.
W6PCE	12,005,000	152	48	—	750	19 h., 45 m.

Station	Score	Sns.	Sects.	Station	Score	Sns.	Sects.
W1KQY	11,503,070	188	51	W9QMD	5,998,032	134	50
W3NF	11,112,800	181	49	W9YZN	5,989,375	133	52
W9BRD	10,705,950	176	49	W8SFW	5,822,180	151	45
W6RBQ	10,324,342	145	48	W2LXI	5,498,254	150	43
W5KC	9,863,360	154	54	W6BAM	5,305,671	113	46
W2KHA	9,625,217	217	42	W9BVQ	5,174,450	138	47
W4WE	8,855,000	171	49	W3HXA	4,968,840	143	45
(W4DWB op.)				W9GBJ	4,488,831	130	43
W9VDY	8,731,800	174	46	W1BFT	4,485,542	140	41
W6CIS	8,358,294	127	50	W1LKE	4,477,946	141	37
W3LKW	7,684,930	161	48	W4AQL	4,264,715	127	42
W3GYQ	7,121,832	168	38	(W4DXI op.)			
W8ROX	7,117,586	160	43	W3EML	4,223,694	136	43
W3HQU	7,090,200	145	50	W2GVZ	4,061,827	147	40
W3DGI	7,050,200	157	43	W6PGB	4,020,492	94	44
W8DOD	6,784,224	164	40	W9WMP	3,638,582	112	46
W9VQZ	6,366,025	152	45	W9EGQ	3,494,563	118	39
W2LZR	6,096,362	161	37	W8QQB	3,475,684	119	39
W3GHD	6,047,950	147	47	W2KYV	3,001,440	118	38
W3HJE	6,004,950	147	42	W6LMZ	2,897,244	83	38

The score of WIAW, not competitive with any of the above, is recounted for the information of members: WIAW (Hal); 18,070,278; 224; 54; 21; 1000; 17.

**Official Phone Station Scores (April)**

Station	Score	QSO's	Sects.	Heard	Power (Watts Input)	Operating Time
W9WXL	5681	43	23	16	250	7 h., 35 m.
W2JME	5610	51	22	—	300	6 h., 20 m.
W4QL	5192	40	22	18	300	5 h., 57 m.
W8BOZ	4080	40	20	2	420	4 h., 15 m.
W1EAO	3952	38	19	9	300	4 h., 57 m.
W3DRQ	3760	34	20	9	150	7 h.
W8BQA	3686	32	19	17	140	4 h., 25 m.
W3EQK	3440	33	16	25	250	3 h., 55 m.
W2DYC	3248	33	16	19	400	4 h., 50 m.
W8BFB	3247	35	17	8	—	4 h., 20 m.

Station	Score	QSO's	Sects.	Station	Score	QSO's	Sects.
W1DWP	1396	28	17	W1GZL	1432	15	8
W3DOG	3173	31	19	W9VCO	1430	22	13
W8AQ	2896	25	16	W8MQL	1430	22	13
W8QGG	2890	30	17	W4DGU	1400	20	14
W8MBW	2790	27	18	W4COL	1368	20	12
W2CET	2788	30	17	W8FSK	1368	20	12
W8KNF	2280	26	15	W3CFS	1200	12	8
W3BRZ	2016	20	14	W3PFC	1144	16	13
W3FGJ	1860	24	15	W8JFC	1140	17	12
W8RYC	1806	19	14	W8MQT	1056	18	11
W6CHV	1792	16	16	W1KTE	1042	14	9
W4EM	1680	20	15	W3GWQ	1020	17	12
W8CMF	1652	22	14	W3BEI	1010	20	10
W3AJJ	1540	22					



## JULY HAMFEST SCHEDULE

*July 7th, at Shelton, Conn.:* A ham get-together will be held in Shelton, Conn., starting at 2:00 P.M. E.D.S.T. on Sunday, July 7th. Sponsor is the Southern Connecticut American Emergency Network. The affair will be held on the grounds of the White Hills Coon Hollow Club, about 3/4 mile from Route 110. Registration should be made in advance. All hams, their families and friends, are invited. There will be games, dancing, plenty of prizes and refreshments. Fee: 75¢ for OM's; XYL's and children free. Further information may be obtained from the secretary, S. M. Sill, 305 Derby Ave., Derby, Conn.

*July 20th-21st, at Glacier Park:* The Fifth Annual Glacier Park Hamfest is to be held at Two Medicine in Glacier Park, July 20th and 21st. There is no registration fee. Walter E. Partlow, W7FGZ, 1308 3rd Ave. No., Great Falls, Mont., is the president for the hamfest, and further information can be secured from him, W7AQQ, W7ABT, W7FUQ or W7DSS. Program and stunts will be arranged for the hams as well as for the ladies, with fishing, hiking and boating on Two Medicine, portable radio operation and plenty of subjects for the camera fans.

*July 21st, near Peoria, Ill.:* The Peoria Amateur Radio Association is holding its Second Annual Central Illinois Hamfest on Sunday, July 21st. The place: Loscher Park, about 1 1/2 miles north of Peoria, on Route 150. As usual, there will be free refreshments, and plenty of prizes, including several large prizes, such as an RME DM36 and a Meissner Signal Shifter. There will be the traditional contests, and plenty of interesting activities are planned for the ladies. Facilities will be available for playing ping-pong, baseball or horseshoes. A dance is planned for the evening. Lunch may be purchased at the refreshment stand, or you may bring your own. Advance registration is 75¢ for the OM, 25¢ extra for the YL or YF and children. At the gate, fees will be \$1, and 50¢.

*July 21st, at Rolling Green Park, Pa.:* The Third Annual Hamfest of the Susquehanna Valley Amateur Radio Club is scheduled for July 21st at Rolling Green Park, on Route 11, midway between Sunbury and Selinsgrove, Pa. Registration at 1:00 P.M.; program starts at 1:45 P.M. The program will include a demonstration and talk on frequency modulation, and several reels of motion pictures. Banquet will be held at 6:30 P.M. in the Park restaurant, followed by a short program and the prize drawings. The afternoon activities will be in the Park theatre. Additional details may be obtained from the club secretary, John W. Fisher, R. D. 2, Selinsgrove, Pa.

*July 21st, at Round Lake, Wis.:* The Round Lake Hamfest is staged annually by the Fox River Valley Affiliated Radio Clubs, Sheboygan, Fond Du Lac, Two Rivers and Manitowoc. It has come to be a firmly established part of amateur radio activity in that region. This year's hamfest will be held on July 21st. The Round Lake site, approximately 18 miles southeast of Fond Du Lac, Wis., is ideal

### W2USA, World's Fair

A busy corner of the "shack" at W2USA, New York World's Fair. Fred Seid, W2MQ, keeps an eye on the operators as they do their stuff. Nils Michaelson, W2LSD, organizer of Forty Traffic System, is working the 7-Mc. rig in the foreground. The receiver and transmitter, beyond him, is on 3.5-Mc. c.w., and the pair of units at the end of the bench are on 28-Mc. 'phone. The large transmitter on the floor is on 3.9-Mc. 'phone. At this writing W2USA is getting under way for the new Fair season. All bands will be used with a good number of operators making possible full operation.

for an outdoor hamfest. Last year's attendance was 247, representing 38 communities. An even greater turn-out is expected this year. Don't miss it!

## W1AW Summer Schedule

### JULY-AUGUST OPERATING-VISITING HOURS

7:00 P.M.-1:00 A.M. E.D.S.T. daily, including Saturday-Sunday.

### ADDITIONAL STATION HOURS 1

1:00 P.M.-7:00 P.M. E.D.S.T. daily, except Saturday-Sunday.

OFFICIAL BROADCAST SCHEDULE (for sending addressed information to all radio amateurs):

### Frequencies

C.W.: 1761-3825-7280-14,254-28,600 kcs. (simultaneously)

Starting Times (P.M.)		Speeds (W.P.M.)								
E.D.S.T.	C.D.S.T.	M.D.S.T.	P.D.S.T.	M	T	W	Th	F	Sat	Sun
8:30	7:30	6:30	5:30	20	15	25	15	20	-	20
Midnight	11:00	10:00	9:00	15	25	15	20	15	15	-

PHONE: 1806, 3950.5, 14,237, 28,600 kcs.

Each code transmission will be followed in turn by voice transmission on each of the above frequencies.

### GENERAL OPERATION:

Besides specific schedules in different bands, W1AW devotes the following periods, except Saturdays and Sundays, to GENERAL work in the following bands:

Time, E.D.S.T.	Frequency
2:00 P.M.-3:00 P.M. <sup>1</sup>	28,600 kc. Phone/CW
7:00 P.M.-7:30 P.M.	14,237 kc. Phone
7:30 P.M.-8:00 P.M.	14,254 kc. CW
8:00 P.M.-8:30 P.M.	3825 kc. CW
9:30 P.M.-10:00 P.M.	3950.5 kc. Phone
11:00 P.M.-11:30 P.M.	7280 kc. CW
11:30 P.M.-Midnight	1806/1761 kc. Phone/CW

At other times, and on Saturdays and Sundays, operation is devoted to the most profitable use of bands for general contacts and to participation in special week-end operating activities. The station is not operated on legal national holidays.

Give W1AW a call for an accurate frequency measurement, to communicate with any department of A.R.R.L., to rag-chew when time permits, or to pass a message to ham friends, making use of the Headquarters station's multi-band facilities.

<sup>1</sup>Except for weeks of July 7th, 14th, 28th, and week of Aug. 4th providing for the attendants' vacations.





# How's DX?



## HOW:

If you have been tolerant enough to follow this pillar since its inception a few years ago, you may have noticed that from time to time a note of pride has crept into the stuff, pride in being able to tell about the exploits of the DX gang which, we think, is one of the most highly specialized and developed groups in the amateur radio game. We've always had that pride about them since the old days when we found them the first to take up new technical developments and learn things about DX conditions. Occasionally there have been incidents that have tried to shake that faith but they never got to first base with us.

Recently our confidence and loyalty for the DX gang has been put to a real test. Into this gang of bowled owls there has filtered an element that we aren't too keen about. We like to think that the element is made up of some of the newcomers, unfamiliar with their heritage and the traditions that make up the DX gang, but we can't be sure. We refer to those DX men who are either too stubborn or too stupid to refrain from working belligerents during these troubled times, even though the reasons for not doing so have been pointed out to them time after time in the pages of *QST*. Some we can partially excuse because they haven't seen that particular part of our magazine, and others should be excused, we imagine, because they can't read. Then there is a small group of twerps who get a boot out of working ham stations in belligerent countries, and they just won't stop (they claim) until they are told to by the F.C.C. We think just a little too much of ham radio to let any such lads be responsible for our privileges being curtailed, and that's why we'd like to make an informal suggestion. If you hear any such goings on, call the ham and tell him lightly and politely to lay off until the time comes again when we can work any and all stations without jeopardizing ham radio's position. If he's any kind of a guy at all he'll realize he isn't doing anything to help ham radio and will desist.

We aren't just talking to take up space. We know that the condition exists and we want to see it cleaned up. Every time we turn on the receiver we hear fellows hard at it, and we keep getting lists from some of them, proudly enumerating the Europeans and belligerents they've been working. Naturally we don't run the dope in this column, but we'd like to see the dopes run out of the DX gang. Any time they want to play ball, like the vast majority does, we'll welcome them back. Even if they don't like to have us tell them they might at least recognize the trust placed in all of us by the now off-the-air DX stations who, as their letters show, count on us in this country to keep ham radio going for them until after the hostilities. Let's not betray that trust.



## DXCC ROUND UP:

WE PULLED a small boot last month in assuming that *QST* would get around to everybody by the end of June, the date set for the meeting. It will have reached most, but not all, of the members, but it shouldn't cause too much trouble among the members at the meeting, because they can use the June list of DXCC without too much error.

Speaking of the meeting, we've had notes from some of the gang and we've talked with others, and no one has come out against it, so we'll have the tea and cakes all waiting on June 29 for the first meeting of the DXCC. W6GRL leads the parade this month so he's the chairman unless, of course, Dave Evans has pulled down all of Doc's antennas for some experiments. Don't forget to let us know how many DXCC members you worked during the week-end of the 29th.

The printer's devil scored heavily on us last month, but we hope you all assumed that the general call in the party is to be "CQ CC" and not "CQ CO" as the little man tried to make it.

## WHERE:

THE excitement this month is about **KH6SHS** (14,397 T9). Jerry apparently is squared away with the governor down there and is now pretty active, having worked **W1HX**, **W2GTZ**, **W8OSL**, **W5BB** and others. His address, if you don't already have it, is Jerry Petranek, Box 86, Tutuila, U. S. Samoa. **W1FTR**, down that way on WCFT, says there are two licensed hams in Samoa, but we don't know who the other one is . . . . Another Pacific Islander the gang is catching up with is **KE6SRA** (14,350 T8). **W2GTZ**, **W6WN**, **W6ZS**, **W5BB** and others worked him, but we haven't yet seen anything of the list he was going to send through for DXCC credits . . . . Just as **W6MUS** was going to tear down his rotary antenna he hooked **AC4YN** (14,295 T9) at 1340 GT. Now he's building a fence around the antenna and has hired two small boys to keep it polished and shiny . . . . **W1HX** heard a **KF6JP** (14,380 T9) in the early morning . . . . Cards have been coming through from a couple of EA's. The addresses, if they'll help, are: EA7BA, Dr. Jose M. Gil Guerra, General Queipo de Llano, num. 33., Cadiz, Spain, and EA4AC, Luciano Garcia, Antonio del Rincon, 5, Guadalajara, Spain . . . . Speaking of cards, you'll notice in the I.A.R.U. news section this month that QSL cards to go out of South Africa are not accepted, and incoming cards are being held by the censor.

*(Continued on next left-hand page)*

For a long time we didn't believe there was any **W2GT**, because we never heard him on the air, but we finally tracked the guy down and got a picture and the dope. Doubtless the reason we hadn't heard him was that while we were after the milk, **W2GT** was skimming off the cream. Ed Hopper of Bergenfield, N. J., is an outstanding example of what hard work and determination can do for a fellow who's interested in DX. Ed has more patience and less power than a lot of fellows, but neither seems to have handicapped him. The receiver is an HRO, and the transmitter uses a 1B1 e.c.o. into a 6L6 buffer working Class A, and that drives a 35T at 150 watts input. Practically all the work is done on 20, with a rope-driven 3-element rotary antenna. Ed has been a ham for the past 16 years, but most of the DX has been worked in the past 3½ years.

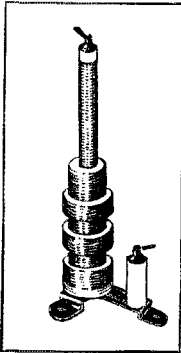

PIE wound transmitting chokes such as the R-152 and the R-154 have served the amateur well for some six years. This is a long time, particularly in amateur radio where there has been a steady trend toward higher plate voltages and higher frequencies. The old pie-wound chokes have protested this state of affairs from time to time by a strong odor of burned insulation, but mostly they have just shown passive resistance. (Editor's Note: Passive resistance absorbs power just like any other kind of resistance.)

Such being the case, we decided to make a thorough investigation of transmitter choke design. A large number of chokes were tested at frequencies from 1.5 to 30 MC with a peak RF voltage of 2500 volts. Measurements were made throughout this range to determine whether the chokes were inductive, capacitive or resonant at the amateur bands. Approximate impedance values were noted, and close attention was given to temperature rise and "hot spots." Measurements of input and output power were taken with and without connection of the RF chokes, and accurate information was thus obtained on the effect of the chokes on amplifier efficiency.

The tests included not only the conventional chokes already available, but also scores of new chokes, ranging from the simplest single-layer windings to the most unusual looking shapes and forms. Various combinations of single-layer windings, conical windings and duo-lateral pies were used.

We finally arrived at the new choke shown in the sketch at the top of this page. Different diameters are combined in such a way as to give sufficient inductance for high reactance at 1.7 and 3.5 MC, and to keep the distributed capacity low, causing the series-resonant frequency of the choke to fall at about 26 MC. Single layer helical windings are used throughout the choke because this type is best for low distributed capacity.

The impedance of the choke is high for all of the amateur bands between 1.7 and 30 MC, and may be used anywhere in this range except at 26 MC. It may be used in parallel-feed circuits without overheating, and without causing a detectable loss of efficiency in the RF amplifier to which it is applied. It is free from voltage breakdown at RF peaks as high as 20,000 volts.

This new type of choke is necessarily somewhat taller than those in present use, but this is likely to prove an advantage in the actual construction of an RF amplifier. The height of the choke is about the same as that of the currently popular medium-power tubes. Thus the connection to the top of the choke may be made by an almost horizontal, short connection from the plate cap of the tube.

By and large, we think the new choke is FB.

T. M. FERRILL, JR.



# \*FP (Fabricated Plate) Capacitors

TRADE MARK REG. U. S. PAT. OFF.

## ...and the Importance of This Condenser

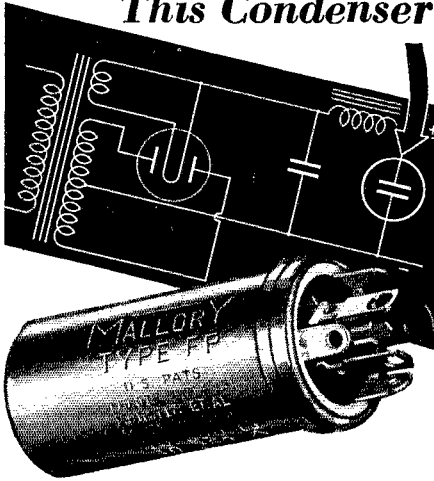

The output filter condenser has two important functions—

1. It suppresses hum.
2. It prevents common coupling through the power supply. The power supply impedance must be low to prevent oscillation (motorboating), or unwanted degenerative effects.

Here, as in other filter circuit applications, FP Capacitors are unexcelled from the standpoint of low impedance, dependability and compactness. A few of the many stock sizes are:

Type	Capacity	Working Voltage	Can Size
FPS140	125 mfd.	350 v	1 3/8" dia. x 3"
FPS146	40 mfd.	450 v	1" dia. x 3"
FPS149	80 mfd.	450 v	1 3/8" dia. x 3"
FPD238	40-40 mfd.	450 v	1 3/8" dia. x 3"

In the past, space and cost limitations have frequently prevented engineers from using optimum capacities in filter condensers.

The startling compactness of FP Capacitors removes this limitation—now you can use enough capacity to produce real results. But insist on genuine FP construction—it is your guarantee of proper life and performance.

**P. R. MALLORY & CO., Inc.**  
 INDIANAPOLIS INDIANA  
 Cable Address—Pelmallo

\*NOT etched Construction

Use  
**P. R. MALLORY & CO. Inc.**  
**MALLORY**  
 APPROVED  
 PRECISION PRODUCTS

### WHEN:

A COUPLE of faithful W6's give us the only dope we have on 40 meters. W6QKB says it's **KE6SRA** (7140 T9), **K7GTB** (7130 T9), **K7FFG** (7125 T9), **K7FYI** (7120 T9), **K7GZH** (7120 T9), **CM6DV** (7130 T8) and **XE3CN** (7135 T9) . . . . W6PMA's info is about **KC4USB**, who can be found on 40 between 7.0 and 7.1 Mc. almost any yawning between 1 and 4 a.m. PST.

Pickings are pretty slim on 20, but let's take a look. W8QQE has **CR6AF** (14,080 T9) from 3 to 5 p.m., and **J2LL** (14,375 T9), **J3FI** (14,380 T9), **J2KM** (14,365 T9), **J6DR** (14,330 T9), **J3HO** (14,395 T8), **XU3OF** (14,335 T9) and **J2KI** (14,375 T9) in the morning . . . . On his list, W2HHF shows **OQ5AV** (14,320 T4), **XU8HM** (14,380), **XU6OH** (14,400), **CP1XA** (14,400 T8), **ZP6AB** (14,280), **K4IDM** (14,350), **XU6LY** (14,300), **XU6AL** (14,310), **K4IER** (14,340), **XU8MC** (14,340), **J6DV** (14,315) and **K4IAC** (14,385), while **K7CBF** (14,280), **OQ5BF** (14,400), **K7HAR** (14,340) and **KB4FTU** (14,280 T7) were heard . . . . W6MUS heard **EK1AA** (14,400 T6) and worked **XU8MY** (14,390 T9), **XU8MK** (14,310 T8), and **K4TTF** (14,295 T9) . . . . W7BIZ, out Montana way, worked **K4IHG** (14,270 T9), **K4IPO** (14,260 T9), **K4ICG** (14,350 T9), **K4IAG** (14,300 T9), **HK2BD** (14,390 T9), **HK5EJ** (14,020 T9), **HK4DA** (14,050 T9), **L77BH** (14,380 T9), **HB8MC** (14,340 T9), **XU6CH** (14,360 T9), **XU7CH** (14,300 T9), **PK1FK** (14,300 T9) and **PK1RK** (14,270 T9) . . . . W8QVF makes it with **J3DQ** (14,400 T9) and **J3FK** (14,400 T9).

### \*PHONE:

**XU3OF** says that **AC4YN** expects to be on 'phone about the middle of June, pending arrival of the gear from Calcutta . . . . W2JME worked **KC4USA** at 14,200, and W5VV found him at 14,150 . . . . W5BB has **W6EXE/K7** (14,150) on the tip of the Aleutian Islands, **YV4AB** (14,100) and **YNU1** (14,050) . . . . W6ITH gives the address of **YNU1** as Ken Jackson, Siuna, Nicaragua, and has recently worked **CP1XA** (14,140), **CE1AA** (14,020), **YV6ACU** (14,080), **K4IFH** (14,120), **OA4AI** (14,020), **J2NF** (14,100), **J2MC** (14,090), **K4IHQ** (14,080), **LU4BD** (14,120), **J2TY** (14,050), **LU1HI** (14,030), **K4IRV** (14,090), **OA4AW** (14,130), **J2KA** (14,010), **CX3CO** (14,060), **LU7BK** (14,080), **LU7AG** (14,100), **CE3DW** (14,020), **CE1AI** (14,000), **LUSAB** (14,030), **CX2AC** (14,030), **YV4AE** (14,067), **ZP6AB** (14,030), **KG6MV** (14,240), **J2NE** (14,210), **CX1XA** (14,140), **HCVT** (14,050), **K4IAC** (14,110), **OASB** (14,020), **J5CW** (14,070), **YS1EO** (14,110), **KC6OKS** (14,160), **CR6AF** (14,040), **H12L** (14,110) and **YSIMS** (14,110) . . . . W3AKT worked **KF6JEG** (14,240), and W5CXH/6 tells about **XU3OF** (14,360) and **XU8PL** (14,360).

(Continued on next left-hand page)





Outstanding transmission at 1 k.w. on each of 5 bands by "Tom" Consalvi's W3EOZ at Bryn Mawr, Pa., is matched by the perfect performance of his AR-77 receiver shown in the foreground before installation in the panel.



**"It Beats Receivers  
Costing  
*Twice as Much!*  
... says **W3EOZ****

Thomas A. Consalvi—W3EOZ—knows receivers. He has seen just about all of them—and he's actually given most of them a whirl. Many manufacturers have sent him sets to be tested under normal as well as exceptional amateur conditions. Here's what he says about the new RCA AR-77 with which he recently replaced a receiver costing more than \$300 in his shack:

"In many features, the AR-77 is superior to any other I ever tried—at any price. In every way, it matches the performance of my old receiver costing more than twice as much. Some features, particularly the noise silencer, are far superior. Its performance on high frequencies is unbeatable; its signal-

to-noise ratio excellent and its stability unmatched. I've tried it under all sorts of conditions and there is negligible drift, even over long periods."

Getting back to the noise limiter, Mr. Consalvi states: "It's the first really effective noise silencer I've ever tried. It really works. For instance, I've had three automobiles at the same time going full blast just outside of my shack, making all possible ignition noise. Then, I've gone to my AR-77, picked up the weakest signals I could find—signals inaudible without the noise limiter in operation—and brought them in 100%!"

# AR-77

## COMMUNICATION RECEIVER

Tests under average conditions show maximum drift at 30 Mc to be only 3.0 KC on one hour run, thereby keeping signal audible. A 2-to-1 ratio of signal-to-noise is obtained at an average sensitivity of 2 microvolts throughout range. Frequency coverage, 540-31,000 KC in *six* ranges. Try it at your nearest RCA distributor's store. You be the judge! Complete Technical Bulletin sent on request.

Net Price, **\$139.50** f.o.b. factory.  
8" Speaker in matched cabinet, **\$8.00.**



# *for Amateur Radio*

RCA MANUFACTURING COMPANY, INC., Amateur Division, CAMDEN, N. J. • A Service of the Radio Corporation of America

# BETTER CONTROL

*with the*

# BLILEY

# B-5

## 40-METER CRYSTAL UNIT

**HIGHLY ACTIVE:** Instantly snaps into oscillation. Accurately follows keying.

**POWERFUL:** Uniformly high power standardized in a loaded oscillator with measured output.

**ACCURATE AND STABLE:** Frequency guaranteed .03% accurate. Drift less than 4 cycles/mc./°C.

**DEPENDABLE:** Thirty-one checks and inspections, including a final overload test, assure reliable operating characteristics.

*Ask your distributor for Circular A-7*

### WHO:

**H**AM radio lingo must give the censors a bad time every now and then. W6NLZ sent a letter to VS2AI, which had been checked by the censor. The words removed from the text were "QRM," "DXCC" and the like! . . . . . Speaking of the DXCC reminds us that, because of a step-up in production schedule, cards for the DXCC must be in by the 20th of the month to make the next QST, rather than by the first as used to be the case . . . . . W6KMS writes to say that he's going out to Wake Island shortly for PAA, where he'll be on 20 and 40 c.w. Paul adds that, because of the high cost of QSL-ing from Wake, cards should be sent to the W6 QSL Manager, and KC6KMS will QSL upon return to the mainland . . . . . We hope everyone is happy now that VU7BR came through with a second batch of cards. Apparently the first ones were lost en route . . . . . LU5FB writes to say that most LU's QSL via the district QSL Managers to W's — cards to LU's can go direct or to LU4AA. LU's get on the low end of 40 for c.w. contacts in the early morning hours, when the 'phone QRM is least . . . . . W8OSL has met personally 27 members of the DXCC above 115 countries, which may or may not be a record. But the best way to meet a lot of them is to get on for the DXCC Round Up on June 29th and 30th, on 14 Mc.

— W1JPE

**Flash!** A last-minute development changes the DX picture considerably. Be sure to read this month's editorial on page 12.

### BRIEFS

The Jersey Shore Amateur Radio Association gave a very successful demonstration of amateur radio during the week of April 8, in connection with the Asbury Park Cavalcade of Progress, held in Convention Hall, Asbury Park, N. J. A complete 400-watt radiophone and c.w. transmitter was set up by a committee consisting of W2GMR, AIW, FZY, FQK and GUM. Other members of the Association who took turns in operating and giving information to visitors included W2HWX, IKL, LMB, LYY, AER, CZP, BZT, MWW and GAK. Practically all the traffic accepted from visitors was handled by BZJ. The amateur radio exhibit and demonstration was the most popular feature among the 53 exhibits on display.

Code speed practice transmissions are being made by W2SC on 3510-kc. each Tuesday and Friday at 8:30 p.m. E.S.T. Here is an opportunity to increase your code speed proficiency. Transmissions are made at speeds from 15 to 40 w.p.m. W2SC is the Second Corps Area A.A.R.S. Net Control Station located at Governors Island, N. Y. The automatic transmitting head of WVP, Army station at the Island, is used for purposes of the code practice. Try your hand at these transmissions on Tuesday and Friday nights.

The first W.P.R. certificate to be issued outside of Puerto Rico itself went to H. S. Bradley, W8JIW. This certificate is issued by the Puerto Rico Amateur Radio Club to amateurs working 25 K4's and submitting verifications.

Winner of the Code Speed Contest at the 1940 Hudson Division Convention was Clay A. Littleton, Jr., W2MNE, who copied a speed of 40 w.p.m. using a typewriter. He won the \$10 prize for this, and was also conceded the prize for best pencil copy. The contest was conducted by D. E. Wingate, W2KEZ, who set up his automatic equipment for the test runs.

The Southwest Weather Reporting Net (general call QWX), which operates on 3540 kc. during the winter, has moved to 7080 kc. for the summer and operates at 5:00 p.m., Mountain Time, daily.

Reorganization of the Chair Warmers Club has recently taken place. This club is for disabled radio amateurs everywhere and it is desired to make the membership as complete as possible. Bulletins are issued to C.W.C. members at regular intervals. Harold Brooks, W9EVB, is president, and Rudy Drews, W8DSQ, is secretary. Send applications to the secretary at 1413 Sheridan St., Lansing, Mich.

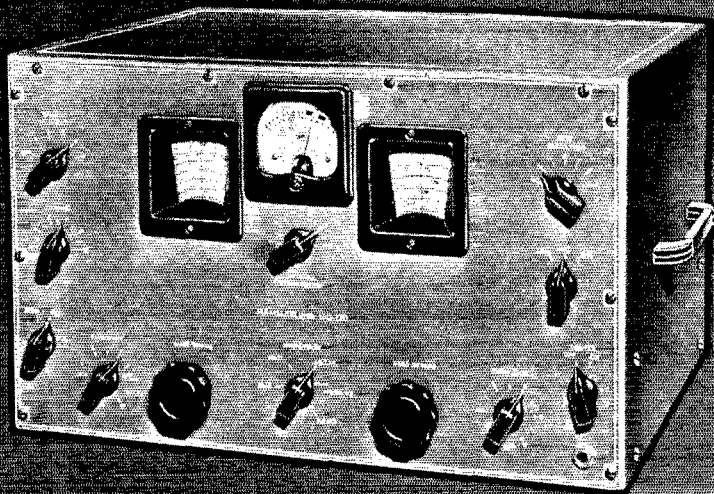

**HQ-120-X**

# Selectivity "Plus" AND STABILITY

IN ever-increasing numbers, amateurs are turning to the "HQ-120-X" because they find it to be everything they have ever hoped for in a medium-priced receiver. Loud praise from thousands who are already using "HQ-120-X" receivers was earned by pioneering on the part of Hammarlund engineers. They put into this receiver features which hams could *really use*, features which are rapidly changing the whole scheme of receiver design. And, today, the "HQ" is even better than ever because our engineers are ever alert to make the slightest improvement. In buying an "HQ-120-X" you do not get two or three year old engineering, but right up-to-the-minute improvements.

Words can hardly express the quality of this fine receiver. To really appreciate its smooth performance, it is necessary to hear and operate it. By all means, visit your dealer and operate the "HQ" yourself, and experience "selectivity and stability plus."

**SEND FOR DETAILS!**

HAMMARLUND MFG. CO., Inc. Q-7  
424 W. 33 St., N. Y. City

Please send 16-page "HQ" Booklet.

Name .....

Address .....

City ..... State .....



Canadian Office:  
41 West Ave. No., Hamilton

# HAMMARLUND

EXPORT DEPARTMENT, 100 VARICK ST., NEW YORK CITY



# YEARS AHEAD

## TRIPLITT

### 1941 Model 1696-A

# MODULATION MONITOR

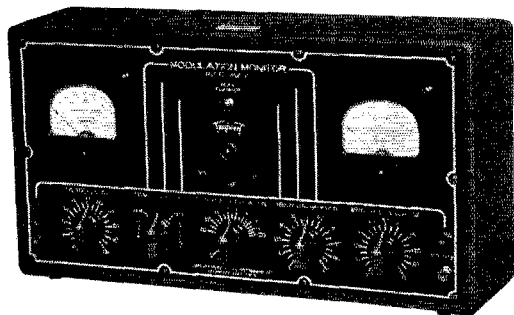

**YOU'VE** solved your problem of getting maximum efficiency from your transmitter when you invest in a Model 1696-A Modulation Monitor.

And . . . better yet . . . it saves you money by increasing your range without the added expense of remodeling your transmitter. (Amateur experience has shown that a properly modulated 10-watt rig can be as efficient as a 50% modulated 40-watt transmitter.) The Model 1696-A is easy to use. Plug it into your A.C. line — make simple coupling to the transmitter output and the monitor shows:

- **CARRIER REFERENCE LEVEL**
- **PER CENT OF MODULATION**
- **INSTANTANEOUS NEON FLASHER** (no inertia) indicates when per cent of modulation has exceeded your predetermined setting. Setting can be from 40 to 120 per cent.

Use of the monitor permits compliance with FCC regulations. Two **RED DOT** Lifetime Guaranteed Triplitt instruments. . . . Modernistic metal case, 14½" x 7½" x 4½", with black suede electro enamel finish. Black and white panel.

Modulation Monitor Booklet — regular purchase price \$1.00 — Furnished **FREE** with each Model 1696-A. Tells you what you want to know about this monitor, and includes details, including diagrams, for operation of Model 1696-A.

**Model 1696-A.** Amateur Net Price (U.S.A.) **\$34.84**

**Model 666-H.** This Volt-Ohm-Milliammeter is a complete pocket-size tester with AC-DC voltage ranges: 0-10-50-250-1000-5000 at 1000 ohms per volt; DC Milliampers 0-10-100-500; High and Low Ohms Scales. **RED DOT** Lifetime Guaranteed Measuring Instrument. Amateur Net . . . . . **\$14.50**

For More Information — Write Section 257, Harmon Drive

**THE TRIPLITT ELECTRICAL INSTRUMENT CO.**  
Bluffton, Ohio

## DX CENTURY CLUB AWARDS

These have been made to the first-listed amateurs, based on contacts with 100 or more countries, the credits all certified by examination of written evidence under the award rules.

W6GRL..... 149	W4BPD..... 132	W9TB..... 122
W8CRA..... 147	W3CHE..... 132	W6GAL..... 121
W2GT..... 147	W5BB..... 131	W9FS..... 121
G6WY..... 145	W8ADG..... 131	W3FRY..... 121
W2GW..... 144	W2CMY..... 131	W5KC..... 121
W2GTZ..... 143	W2JT..... 131	W1AXA..... 121
W1TW..... 142	W8OSL..... 130	W8JMP..... 120
G2ZQ..... 141	W8OQF..... 130	J5CC..... 120
W9TJ..... 141	W1FH..... 130	W2GVZ..... 120
W6KIP..... 140	HB9J..... 129	W9ADN..... 119
W1BUX..... 139	W2UK..... 128	W1JPE..... 119
W8DFH..... 139	W3EPV..... 128	W9PST..... 118
ON4AU..... 139	W8LEC..... 127	ZL1HY..... 118
W1SZ..... 137	W2HHF..... 127	W2BYP..... 118
W3EMM..... 137	W9KG..... 126	W1ADM..... 118
W8BTI..... 136	W2ZA..... 126	W8MTY..... 118
W6CXW..... 135	W9ARL..... 125	W7AMX..... 117
W1TS..... 135	W8DWV..... 124	VK5WR..... 117
W5VV..... 134	W1DF..... 124	W8QXT..... 117
W2BHW..... 134	W4CEN..... 123	W9EF..... 116
W1LZ..... 133	D4AFF..... 123	W3EVW..... 116
W8DHC..... 132	W3EDP..... 122	W1IAS..... 116
G6RH..... 132	W8NJP..... 122	

- 115: W6ADP, W2CYS, G5RV, W1WV, W4CYU, W1HX, G5BD  
 114: W9KA, W8BKP, W2DC, W1CH, G2DH, G5BY, W3BES  
 113: G6CL, W2CJM, W4DRD, W2DSB, W2GRG  
 112: W9GDH, W6FZI, W3EVT, W3GAU  
 111: W2AAL, W1DUK, VE2AX, W3FPU  
 110: ON4UU, PA0XF, W9UM, W2AER, W8IWI, W1ICA, W5QL, W2IYO  
 109: W3DDM, W6FZY, G2MI, W1BXC, W2AV  
 108: W6HX, ZS2X, HB9BG, W3BEN, VE3QD, HB9CE, VK3QK, W2ARB  
 107: W2CBO, G5BJ, W3AG, VK2DG, W1BGY, W9CWW, W7DL, W6MVK, W9BJ, W8LFE, W6AHZ  
 106: G2TR, W8EUY, W6TJ, W9UQT, W1ZI, W1RY, W2VY, W3GEH  
 105: W2OA, G5OY, J2JJ, VK3CX, HB9X, W2IOP, W4TO, W2GNO, W1GNE, W2BMX, W8LYQ, W3ZX  
 104: E1SF, W1ZB, W4AJX, F8RR, W1GDY, W1GDX, W3KT, W8DOD, W4IO  
 103: G6KP, W8KKG, W5CUI, W9RCQ, W9NNZ, W3AGV, W4BYD, VK6SA, W8PQO, LY1J  
 102: W4C8Y, W8AU, W8OXO, W1FTR, VE2EE, W2BXA, W6BAM, W8HGW, W8JAH, LU8EN, W8AAJ, W1IOZ  
 101: F8RJ, VK3KX, W6DOB, SU1WM, W1CC, SU1SG, G6MK, W4MR, W6GHU, W8JTW, W6KWA, W4EQK, W9VDY, LU7AZ, W1AB, W6ADI  
 100: G6NF, W6KRI, VK2ADE, ZL1GX, ZL1MR, PA0QF, W8BSF, D3BMP, W9LBB, W4CCH, W8KTW, W5ASG, W8JIN, W8QDU, G6GH, W1AVK, W3AIU  
 Radiotelephone: W2AZ, W2GW 104; W6OCH 101.

The following have submitted proof of contact with 75-or-more countries: W2EJ, W9AJA, 99, G3JR, W1CBB, W2ALO, W3A0O, W4TZ, 98; W2CTO, W2JME, W4TP, W8LZK 97; G8IG, W3FLH, W4DMB, W8BOX 96; F8LX, F8BAB, G6XL, W3EMA, W3OP, W6TT, W8IQE 95; K4E8H, W1KHE, W3GHD, W8CJJ, W9A8H, W8EEZ 94; G8ZO, ON4CK, PA0QZ, W2WC, W6FKZ, W6MEK, W9JDF 93; SP1L, W4FJ 92; W1BGC, W1DOW, W9GBJ 91; D3CSC, G6YR, ON4FE, SP1AR, W1KID, W8LAV, W9OVU 90; VK3HG, W2BZB, W2UCQ, W8AAT, W8JFC, W9VKF 89; G2LZ, W3JM, W9PGS 88; PY2DN, W6GPE, W6LDJ, W6NLZ 87; W1AFA, W2FLG, W8DAE, W8OUK, W9FLH 86; VK2TT, W4AIF, W4CFD, W6KG, W8BWC, W8GMH 85; SM6WL, W1BFT, W2AJJ, W6AM, W8BWB, W8CED, W9GKS 84; EA4J, OZ7CC, VE2GA, W1BPN, W2ATF, W6TDP, W6KUT, W8BRC 83; W1EWD, W3AXS 82; J2LL, W3EUV, W9GY 81; G8BS, LA2K, W2BNX, W2ETV, W3BVN, W3EPR, W3FUF, W4OG, W6MHH, W8DGP, W8ITK, W9DIR, W9GMV 80; W4ZZ, W9MRW 79; W3DRD, W4EPV, W8FJN, W9NB 78; W6QAP, W9HUV 77; PA0JMW, W1EH, W8EB, W3GRV, W3FHY, ZL1J 76; H2MCC, VE3DA, W1NI 75.  
 Radiotelephone: W4CYU 96; W2LXY 91; G5RV, W3EMM, W8LFE 89; W1ADM 87; W1AKY 84; W2IKV 80; W8QXT 78; W1BLO 77; W9TIZ 76; W2GRG, W6IKQ 75.

Since Century Club applications are falling off, and more personnel time will be required for issuing the Code Proficiency Certificates, the next listing of Century Club Awards and standings will be scheduled for September QST.

# PA-150

## A COMPACT UNIT-TYPE AMPLIFIER!

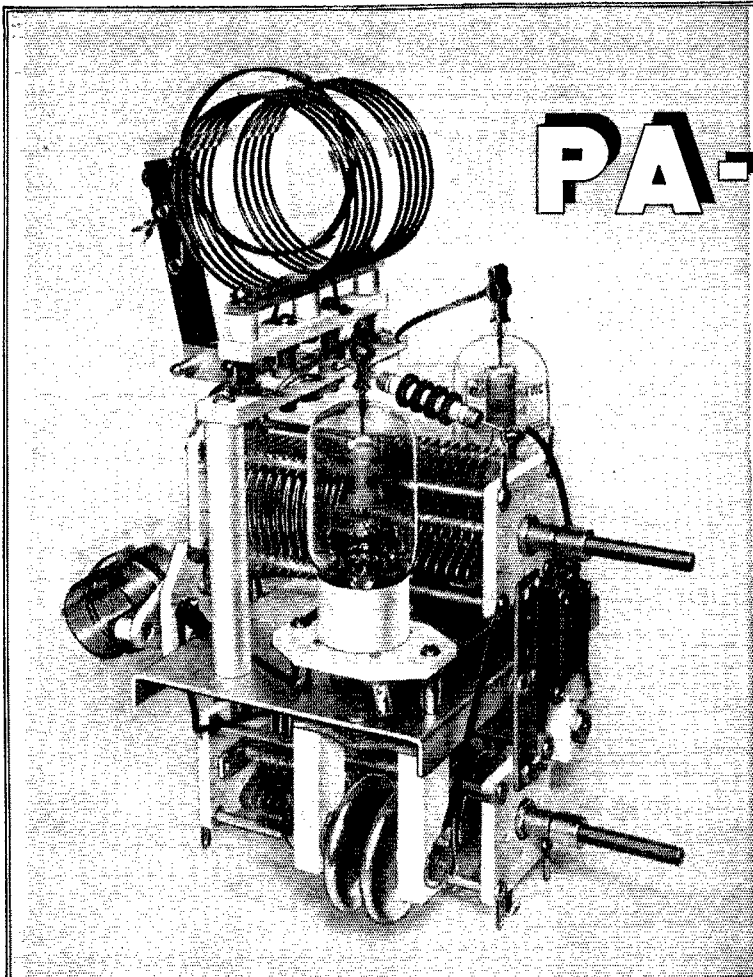

THE new Hammarlund "PA-150" is an ideal final amplifier for the amateur interested in medium power. The "PA-150" is extremely compact, measuring only  $11\frac{1}{2}$ " x 8" x  $5\frac{1}{2}$ " and is capable of outputs up to 175 watts with low-priced HK-24 tubes. Other tubes such as 35-T can be used for higher outputs. The entire foundation unit is designed around the new Hammarlund "HFB" insulated rotor condensers, further adding to the economy of this excellent unit.

If your present rig uses an 807 or similar output tube of around 15 watts, it will be a simple matter to add the "PA-150" and really go places. For further technical information, see October 1939 "QST" Page 38, and write for folder containing diagrams of amplifier and

power supply, as well as complete list of parts. Ask your dealer to show you the new "PA-150" — it's really FB.

WRITE FOR FOLDER!

-----  
Hammarlund Mfg. Co., Inc. Q-7  
424-438 W. 33 St., N. Y. City  
Please send "PA-150" folder

Name .....

Address .....

City ..... State .....



**HAMMARLUND MFG. CO., INC.**  
424-438 WEST 33rd ST., NEW YORK



EXPORT DEPT.

100 VARICK ST., NEW YORK CITY

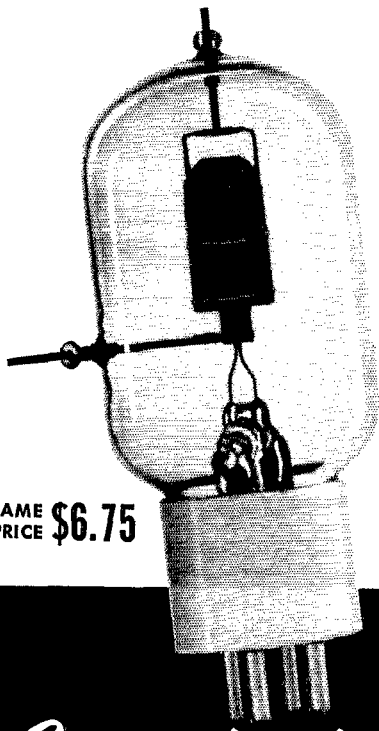

SAME PRICE \$6.75

# Important GAMMATRON TYPE 54 Improvements

The new improved 54 GAMMATRON offers greater plate voltage capabilities up to 3000. The U. H. F. efficiency is higher. This great combination of features makes the 54 ideal for a wide range of applications. Efficiencies shown below are obtainable in conventional circuits of proper design.

WRITE FOR DATA.

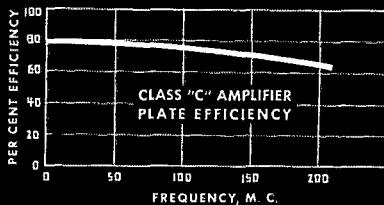

**HEINTZ AND KAUFMAN**  
SOUTH SAN FRANCISCO LTD. CALIFORNIA U.S.A.

## WTDR

The Schoolship of the Massachusetts Nautical School, the steam bark *Nantucket*, is on her annual cruise, this year to Central American waters. From May 11th to September 23d, the following points will be visited: Boston, Gloucester, Washington, Norfolk, St. Thomas, San Juan, Guantanamo, Cristobal, C. Z., St. Petersburg, Havana, East Lamoine, Glen Cove, Fall River and Cataumet, Mass., an estimated sailing distance of 8985 miles. The *Nantucket* carries 118 cadets in training for officers' positions in the U. S. Merchant Marine, and has a crew and officer complement of another 25 men, including 3 radiomen. The radio call is WTDR. Communication with amateur stations is desired, with the view of having personal messages from the cadets forwarded to their parents and friends. WTDR will listen on the 7-Mc. amateur band at 0700 GMT, and will answer on 8280 kc.; and will also listen on the 14-Mc. band at 1900 GMT, answering on 12,420 kc. A.R.R.L. will be interested in hearing of any contacts with the *Nantucket*.

— \* — \* —

## ★ New Receiving Tubes ★

### NEW BATTERY TUBES

SYLVANIA announces a group of three new 1.4-volt, 50-ma. battery tubes which are designed for efficient performance at low plate voltages. All are of the loktal type.

#### 1LC5

This type is an r.f. amplifier pentode with medium cut-off characteristic satisfactory for a.v.c. circuits. Operating conditions are as follows:

Plate voltage . . . . .	45	90
Screen voltage . . . . .	45	45
Grid voltage* . . . . .	0	0
Plate current . . . . .	1.1	1.15 ma.
Screen current . . . . .	0.25	0.2 ma.
Plate resistance . . . . .	0.7	1.5 meg.
Mutual conductance . . . . .	750	775 $\mu$ mbos.

#### 1LC6

The 1LC6 is a pentagrid converter with operating conditions and characteristics as follows:

Plate voltage . . . . .	45	90
Screen voltage † . . . . .	35	35
Anode grid voltage . . . . .	45	45
Control grid voltage † . . . . .	0	0
Oscillator grid resistor . . . . .	0.2	0.2 meg.
Plate resistance . . . . .	0.3	0.65 meg.
Plate current . . . . .	0.7	0.75 ma.
Screen current . . . . .	0.75	0.7 ma.
Anode grid current . . . . .	1.4	1.4 ma.
Oscillator grid current . . . . .	0.035	0.035 ma.
Total cathode current . . . . .	2.9	2.9 ma.
Conversion conductance:		
Control grid voltage at 0 . . . . .	250	275 $\mu$ mbos.
Control grid voltage at -2 . . . . .	50	50 $\mu$ mbos.
Control grid voltage at -3 . . . . .	5	5 $\mu$ mbos.

The 1LD5 is a diode-audio pentode with characteristics and operating conditions as follows:

Plate voltage . . . . .	90
Screen voltage . . . . .	45
Grid voltage . . . . .	0
Plate current . . . . .	0.6 ma.
Screen current . . . . .	0.1 ma.
Plate resistance . . . . .	0.95 meg.
Transconductance . . . . .	600 $\mu$ mbos.

\* A resistance of at least 1 meg. should be in the grid return to negative filament, Pin No. 8.

† Obtained preferably from by-passed series resistor.

‡ A resistance of at least 1 meg. should be in the grid return to negative filament, Pin No. 8.

(Continued on next left-hand page)

# Select "Super Pro"

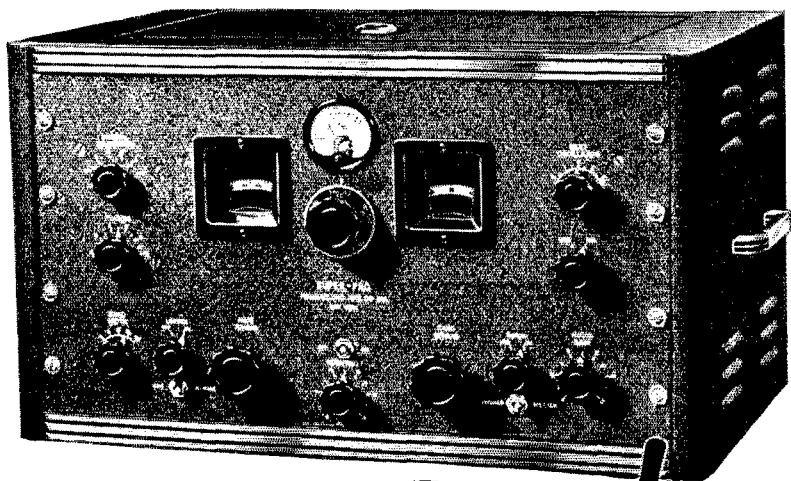

## and Be Sure!

WHEN you choose a "Super-Pro", you are joining a large family of technicians and engineers who have consistently used and specified "Super-Pro" receivers for practically every type of communications service. This is your assurance that you are getting the finest receiver money can buy — for experts use the best. The new Series 200 "Super-Pro" has automatic noise limiting; five-point crystal selectivity with continuously variable I.F. band width, ranging from single signal to high quality broadcast; adjustable "S-Meter"; two T.R.F. stages, and just about everything required for either commercial or amateur service.

Export Dept.  
100 Varick Street, New York City

HAMMARLUND MFG. CO., INC. Q-7  
424-438 W. 33rd Street, New York City  
Please send 16-page "Super-Pro" booklet

Name.....  
Address.....  
City.....State.....

# HAMMARLUND

## NEW LOKTAL TYPES

Sylvania also announces a new list of equivalent types which are now available in loktal form as follows:

Loktal	Service	Equivalent or Similar to
1LA4	Power pentode	1A5G
1LA6	Pentagrid converter	1A7G
1LB4	Power pentode	1T5G
1LE3	Med. Mu Triode	1E4G
1LE4	Diode-triode	1H5G
1LN5	R. F. pentode	1N5G
7E7	Duodiode-pentode	6B8G
7F7	Double triode	6C8G
7E7	Semi-remote cut-off r.f. pentode	6AB7/1853
7N7	Double triode	6F8G
12B7	R. F. pentode	7A7
14B6	Duodiode-triode	7B6
14J7	Triode-hexode	7J7
14Q7	Pentagrid converter	7Q7

## ★ NEW APPARATUS ★

### IMPROVED ACORN SOCKET

THOSE who use u.h.f. gear should be interested in the improved Hammarlund acorn tube socket Type UHS-900. The base of low-loss "Iso-Q" is fitted with new-type silver-plated beryllium contacts which are grooved so that the tube snaps firmly into place and will not jar loose nor shift position. In addition, a shield is available which completes the internal shielding of the acorn pentode, greatly reducing coupling between input and output circuits.

### NEW SOLDEBLESS CO-AXIAL FITTINGS

COMMUNICATIONS Products Co. of Jersey City, N. J., now have a complete line of compression-type fittings for concentric lines and antennas which require no soldering. The fittings are waterproof and it is claimed that a saving of 75 per cent in labor of installation is possible. The concentric half-wave antenna is made in three sizes for powers up to 1000 watts.

### NEW SOLDERING IRON

SOMETHING new in the way of soldering irons is the Ducon "Solder Master." In this iron, the head is fitted with a spill-proof cup which holds 48 drops of solder which is kept in a molten state by the heat of the iron. Each pressure of the thumb on a button on the handle of the iron releases a single drop of solder through a nozzle. This feature makes it unnecessary to hold the solder strip to the point of the iron, thereby releasing one hand for holding the work. It should also prove handy in making connections which are difficult of access. It is made by the Dual Remote Control Co., Inc., 31776 West Warren, Wayne, Mich.

### U.H.F. PUSH-PULL TRANSMITTING PENTODE

THE latest trend in transmitting tubes seems to be toward the multiple-unit type. Close upon the heels of the double and quadruple paral-

lel-connected triodes of Eimac comes the announcement of the 829 by RCA. The envelope of this tube, which is designed for u.h.f. performance, contains two beam tetrodes. The cathodes are connected together inside the tube, while the heaters are connected in series with the center tap brought out to a separate terminal so that they may be operated in series from a 12.6-volt supply or in parallel from a 6.3-volt supply. The tube is designed particularly for push-pull operation.

Maximum CCS ratings in Class-C telegraph service are: d.c. plate voltage, 500; total plate current, 240 ma.; total plate dissipation, 40 watts; maximum plate input, 120 watts. Typical power output is approximately 83 watts. The tube may be operated at full ratings at frequencies up to 200 Mc. and at reduced input to 250 Mc. Less than 1-watt driving power (at the grid) is required for full output at 200 Mc. and no neutralizing is required.

## Correspondence Department

(Continued from page 65)

must there be a solution? I could not swim when I was five years old, but I learned in due time. I could not operate 75- and/or 20-meter 'phone when I first became a ham, but I can do so now. Ten was not worth the effort just a few years ago; even 20 and 40, not to mention 80 and 160, were not everything that the ham wanted. Needless to say "we got there just the same." We got there just the same way that we are getting to the ultra-high's to-day. New equipment is being developed along with new theories and practice. I think all of this effort being expended on how to solve a problem that is not even a problem could well be directed to doing a little more "actual practice" on the ultra high's. In other words give us the dope on your discoveries, show us some simple circuits and put them on pages and pages of *QST*.

And all of this talk of killing two birds with one stone. The only birds that some of you other birds want to kill are the little young birds who, as yet, have only a little fuzz on them. Some day you old birds are going to slip, and when you do, since you killed two birds with one stone while they were unable to defend themselves, ham radio will be no more, Why persecute the beginners?

— Russell M. Price, W9GWL

## Strays

### I.R.E.-A.I.E.E. PACIFIC COAST CONVENTION

THE Institute of Radio Engineers plan a Pacific Coast convention to be held in Los Angeles on August 28th, 29th and 30th. This is a combined effort of the A.I.E.E. and the I.R.E. with one joint session of interest to both groups.

In reference to the *Stray* which appeared on page 18 of *QST* for May, the Precision Transformer Company, Grand Haven Road, Muskegon, Mich., advises that antenna wire in any length can be supplied.

Automobile-radio antenna connectors make good and inexpensive mike connectors. They are handy wherever shielded leads are to be connected. The cost — just six cents. — W5BK5.

DX Century Club Member **ROBERT HECKSHER**

# W4CYU

Uses Eimac tubes to work 134 countries on both phone and CW...104 countries on two-way phone

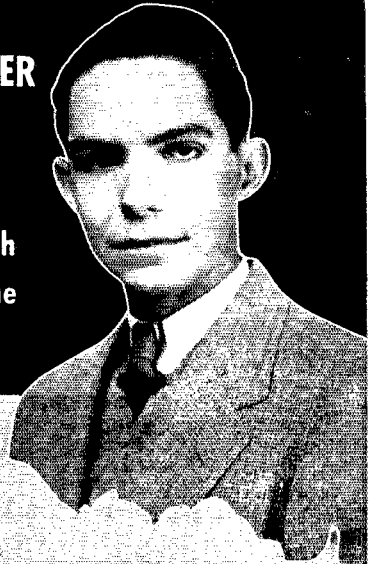

Robert Hecksher finds Eimac 100TH's so easy to drive that he uses old type 210's for the purpose... and the 210's are just loafing along at ten or twenty meters at that. Bob says: "the 100TH's are run at an input of 700 watts on both ten and twenty meters. On twenty meters just the faintest trace of color is perceptible and on ten meters both tubes show an orange color

which is perfectly natural. The Eimac 100TH's drive easily, neutralize perfectly on both bands; operate very efficiently, giving a high output to the antenna."

Outstanding results like this, coupled with economy in operation, are the reasons why most of the leading radio amateurs in the world use Eimac tubes. Chances are you'll find it easier to get results if you switch to

#### EIMAC REPRESENTATIVES

California, Nevada  
**HERB BECKER**, 1530 W.  
104th St., Los Angeles, Cal.  
Wash., Ore., Idaho, Mont.  
**GENERAL SALES CO.**,  
Verner O. Jensen, 2605-07  
Second Ave., Seattle, Wash.  
Colo., Wyo., New Mexico,  
Arizona, Utah  
**RICHARD A. HYDE**,  
4253 Quitman St., Denver,  
Colo.

N. Caro., S. Caro., Georgia,  
Tenn., Flor., Ala., Miss.  
**JAMES MILLAR**, 316  
Ninth St. N. E., Atlanta,  
Georgia  
N. Y., N. J., Penn., Md., Del.,  
Dist. of Col., Maine, N. H.,  
R. I., Conn., Mass.  
**ADOLPH SCHWARTZ**,  
14726 Elm Ave., Flushing,  
New York

Texas, La., Okla., Ark.  
**J. EARL SMITH**, 2821  
Live Oak St., Dallas, Texas  
Chicago, Illinois, Wisconsin  
**G. G. RYAN**, 549 W.  
Washington Blvd., Chicago,  
Ill.  
Ohio, Mich., Ky., Ind., Minn.  
Mo., Kan., Neb., Iowa  
**PEEL SALES ENGINEERING CO.**, E. R. Peel  
154 E. Erie St., Chicago, Ill.

# Eimac

TUBES

Eitel-McCullough, Inc.,  
San Bruno, California

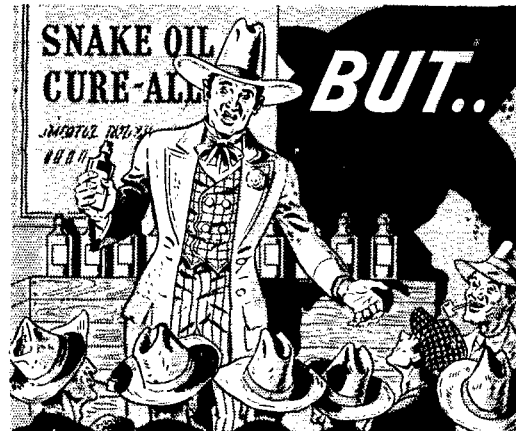

## YOU CAN'T FOOL AN ENGINEER

The old time medicine man was a colorful character but he has no place in an age which insists upon quality — not fanciful claims.

Take transformers, for example! We could make claims, ballyhoo our product to high heaven — but it wouldn't mean a thing because you can't fool an engineer — he buys on Fact not Fancy!

Typical of this is the Kenyon line of Plug-in Transformers which, because they give PLUS value, are favored by engineers who read specifications.

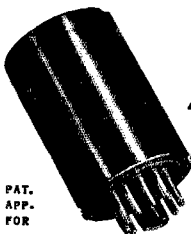

PAT.  
APP.  
FOR

## QUALITY ALWAYS TELLS

Note these Kenyon features which challenge comparison!

1. Over 20 different types
2. Linear response 30 to 20,000 cycles. (No D. C. in primary)
3. No wire sizes smaller than No. 44 (assuring absolute dependability)
4. Positively Submersion-Proof (3/8" lap on all sealed joints)
5. Humbucking construction employed (not practical in smaller sizes)
6. 11-prong base allows maximum electrical versatility plus more rigid mechanical mounting
7. A 'first' by Kenyon

Send for the new Kenyon Catalog which gives complete data on the more than 20 different types of plug-in transformers as well as Laboratory Standard transformers, broadcast and industrial transformers, etc. Many graphs, charts and valuable data. It's yours for the asking.

**KENYON TRANSFORMER COMPANY, Inc.**

840 BARRY STREET • NEW YORK, N. Y.

Cable Address: KENCO. New York, N. Y.

## I. A. R. U. News

(Continued from page 48)

The purpose of this suspension of headquarters activity, as stated by the Council, is simply a conservation of funds by reducing operating expenses.

### NEWS AND NOTES

"AMATEUR DAY" was a recent featured event of both the *Radio Club de Cuba* and the *Radio Club Argentino*. Government officials who were invited to speak on amateur-government relations had much praise for the past accomplishments of amateurs and expressed good-will on the part of the government. . . . During the weekends of May the L.A.B.R.E. staged a national Brazilian QSO party, c.w. and 'phone. Points were allowed for contacts depending on which band was used (extra credit given for 80-meter work) and a multiplier was determined by the distance worked. "CN," for *concurso nacional*, replaced "CQ" in the contest. . . . Like so many other society organs, the Belgian magazine "QSO" has been carrying a course in elementary theory.

### A.R.R.L. QSO Party Results

(Continued from page 49)

273, W5WG 269, W6KFC 265, W2HHF 264, W4EV 250, W1BFT 249, W3DGM 248, W5KC 246, W3ATR 242.

Leaders in number of sections worked: W6KFC 62, W9RQM 61, W1TS, W3BES, W9CWW, W9FS, W9GKS 60, W4EDR, W4EV, W5KC, W5WG, W8OFN, W9RSO, W9ZRP 59, W4CYC, W6ONG, W9VDY, W9VKF, W9ZAR 58, W2IOP, W9TH 57.

As is the case with all successful contests and ham get-togethers the parting shot was "Let's have another." A.R.R.L.'s activity schedule calls for another member-QSO-party next January. Don't miss it!

## Scores

### Third "A.R.R.L." QSO Party, January 1940

(Scores are grouped by Divisions and Sections. . . . The operator of the station first-listed in each Section is winner for that Section. . . . Asterisks denote stations not entered in contest, reporting to assure that stations they worked get credit. . . . Listings show score, number of A.R.R.L. members worked, number of Sections worked. . . .)

ATLANTIC DIVISION		W8RJL	8400-120-35
<i>E. Pennsylvania</i>		W3CPV	8240-103-40
W3BES	43140-300-60	W3FXZ	8240-103-40
W3DGM <sup>1</sup>	27280-248-55	W3FQG	8190-105-39
W3ATE	23232-242-46	W3GHD	6930-105-33
W3GKO	23052-226-51	W3GYY	5712-102-28
W3HHM	21756-222-49	W3EUC	5430- 91-30
W3GJY	21658-221-49	W3EML	5056- 79-32
W3HQE	21320-205-52	W8SEL	4306- 79-28
W3GDI	18624-194-48	W8RJK	3834- 71-27
W3DFU	13356-159-42	W3ICK	3640- 65-28
W3HTF	11890-146-41	W8GV	3213- 60-27
W3HXA	11412-151-36	W3IAY	2037- 49-21

<sup>1</sup> Two operators, W3DGM and W3IKW. <sup>2</sup> Corp, James G. Marglin, opr. <sup>3</sup> HQ's staff member, not eligible for awards. <sup>4</sup> W9AHR (now W7HYD), opr. <sup>5</sup> Two operators, W6PBV and W6QLO. <sup>6</sup> Score of three ops.: W4FPT 3038, W4DXI 2880, W2RVY 24.

(Continued on next left-hand page)



# NC-44

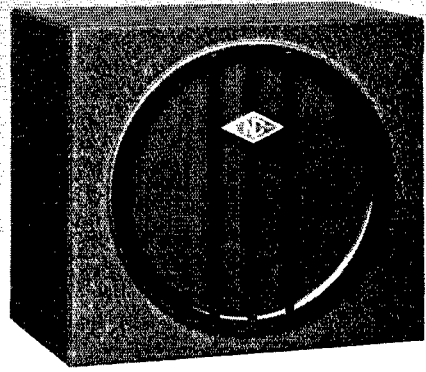

## Count these features

- quality construction
- separate speaker
- professional appearance
- separate band-spread condenser
- low price — only **\$49.50** net with speaker

## Prove its performance

prove to yourself the high performance of the NC-44 by an actual competitive test. Prove, as thousands have done, its ability when the going is tough!



## And rate it "BEST BUY!"

**NATIONAL COMPANY, INC.**



# QUALITY ABOVE ALL!

# SOLAR

# CAPACITORS

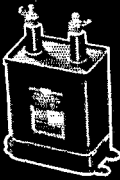

## XL TRANSOIL

For  
Permanent  
Filters

## XD, XC TRANSOIL

for Filters  
and Bypass

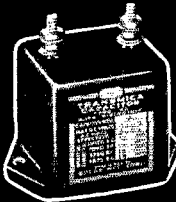

## XA, XH MICA

Oscillator  
Tank Circuits

## XR, XS MICA

Tank Circuits,  
R. F. Bypass

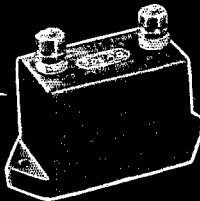

## XM, XQ MICA

Coupling, Blocking  
R. F. Bypass

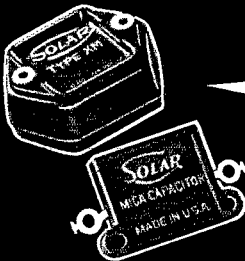

## MH, MW MT, MO MICA

Low-voltage

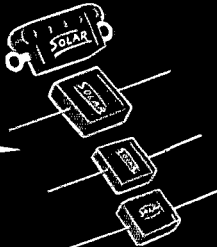

## XT OIL TUBULAR S

Wax-Molded  
Paper Tubular

Catalog Free Upon Request

**SOLAR MFG. CORP., Bayonne, N. J.**

W3ADE	952- 28-17
W3GEW	736- 23-16
W3HHS	634- 30-12
W3JN	598- 23-13
W8ATF	598- 23-13
W8HKS	462- 21-11
W8SNZ	312- 13-12
W3HFE	252- 14- 9
W3EEW	120- 12- 5

### Md.-Del.-D.C.

W3HUM	17683-201-44
W3GYQ	15936-166-48
W3CVA	3930-67-30
W3HTW	3300- 55-30
W3GAC	1444- 38-19
W3FFN	812- 29-14
W3CDQ	30- 5- 3
W3HLQ	18- 3- 3

### Western New York

W8DZC	19992-201-49
W8SBV	12180-145-42
W8DOD	11100-150-37
W8QQB	8892-114-39
W8PLA	7336-131-28
W8BGO	5600- 80-35
W8BLP	5160- 70-35
W8ALP	5168- 76-34
W8OSH	5160-108-24
W8DHU	3900- 75-26
W8GWT	3366- 52-33
W8RTW	1760- 44-20
W8RKM	1462- 43-17
W8AOR	1406- 37-19
W8HQY	1296- 36-18
W8OCY	1116- 31-18
W8OQU*	286- 13-11
W8HQN	280- 14-10
W8TXB	198- 11- 9
W8IOT*	112- 8- 7
W8SZG	70- 7- 5

### So. New Jersey

W3EDP	31130-283-55
W3ZI	3458- 73-23
W3BEI	3168- 66-24
W3EWK	1160- 29-20
W3HVM	1024- 33-16
W2BWW/3	540- 18-15
W3EUH	80- 10- 4

### W. Pennsylvania

W8NCJ	26180-238-55
W8MOT	22080-230-48
W8QAN	20257-219-47
W8SPV	6216- 74-42
W8GON	5644- 83-34
W8QES	5478- 84-33
W8TWI	4760- 85-28
W8NWX	2538- 47-27
W8KWA	2400- 50-24
W8RNH	2200- 44-25
W8OUK	2160- 46-24
W8HKU	506- 23-11
W8CMP	2- 1- 1

### CENTRAL DIVISION

Illinois	31692-278-55
W9TH	16560-184-47
W9WFS	13904-158-44
W9VQE	13068-140-47
W9KXZ	12656-113-56
W9GY	11316-123-46
W9IBC	10406-121-43
W9MUC	8000-100-40
W9WEN	7548-111-34
W9NQI	6591- 85-39
W9AMP	6179-106-31
W9TYV	5970- 71-35
W9AOB	5916- 87-34
W9EBX	4760- 70-34
W9UQT	4544- 71-32
W9TKN	3538- 61-29
W9TCK	3132- 58-27
W9ZAM	2424- 47-26
W9BPU	2352- 56-21
W9IVD	2250- 45-25
W9DGG	2112- 44-24
W9RTA	1044- 29-18
W9DUX	840- 30-14
W9CEO	672- 24-14
W9ADO	288- 16- 9
W9NTU	264- 12-11
W9AGU	40- 5- 4
W9ABF	18- 3- 3
W9QLZ	6- 3- 1
W9LEU	

Indiana	13600-136-50
W9ENH	5880- 84-35
W9MDJ	5698- 77-37
W9HUV	4234- 73-29
W9HPE	2970- 55-27
W9AMM	216- 12- 9
W9ZNZ	32- 4- 4
W9HPQ	

### Kentucky

W9FS	33060-276-60
W9ZWR	17020-185-46
W9THS*	15239-157-49
W9OHA	9758-119-41
W9JIT	4624- 63-34
W9WMI	3120- 52-30
W9PQQ	1340- 34-20
W9NYW*	448- 16-14
W9YGR	123- 8- 8

### Michigan

W8QDU	30576-273-56
W8OQP	20914-187-56
W8NUV	17800-178-50
W8RMH	13708-149-46
W8KPL	11448-108-53
W8SCW	9728-123-38
W8JAH	9015-101-45
W8PTW	4016- 74-27
W8TKW	3250- 65-25
W9EXW	2352- 46-31
W8SAY	1800- 45-20
W8OCC	1496- 44-17
W8SCU	874- 23-19
W8QJZ	330- 15-11
W8RJZ	193- 11- 9
W8PAP	123- 8- 8
W8QGD	4- 2- 1

### Ohio

W8OFN	36934-313-59
W8CKG	17472-168-52
W8ROX	11814-155-45
W8SQE	11524-134-43
W8JIF	4936-108-46
W8MOA	7630- 97-40
W8DAE	5681- 77-37
W8AQ	2600- 50-26
W8SGF	2450- 49-25
W8GVX	2100- 50-21
W8PUD	2072- 36-28
W8QJL	1848- 44-21
W8GER	1768- 34-26
W8BKE	800- 25-16
W8CBI	520- 20-13
W8JFC	384- 24- 8
W8EFW	300- 15-10
W8PNJ	128- 16- 4
W8SCT	128- 8- 8

### Wisconsin

W9RQM	38491-316-61
W9EYH	33110-301-55
W9VDY	33060-285-58
W9DKH	4768- 75-32
W9QLX	2640- 61-22
W9RBI	2460- 41-30
W9BZO	1456- 52-28
W9VSO	880- 28-16
W9YXH	585- 20-15
W9DNO	572- 23-13
W9LUC	8- 2- 2

### Dakota Division

North Dakota	
W9ZTL	12852-127-51
W9NBX	270- 14-10
W9ERR	72- 6- 6

### South Dakota

W9FOQ	10019-117-43
W9ZCC	7560- 90-42
W9WUU	4524- 59-39
W9SEB	2494- 43-29
W9GLA	1365- 33-21
W9QVY	8- 2- 2

### No. Minnesota

W9QPG	11934-153-39
W9QPL	8590-114-38
W9IGZ	1365- 33-21
W9TIV	546- 21-13
W9RIL	448- 16-14
W9RPK	304- 19- 8
W9DNY	184- 12- 8

### So. Minnesota

W9VKF	23548-203-58
W9NYH	9212- 99-47

(Continued on next left-hand page)

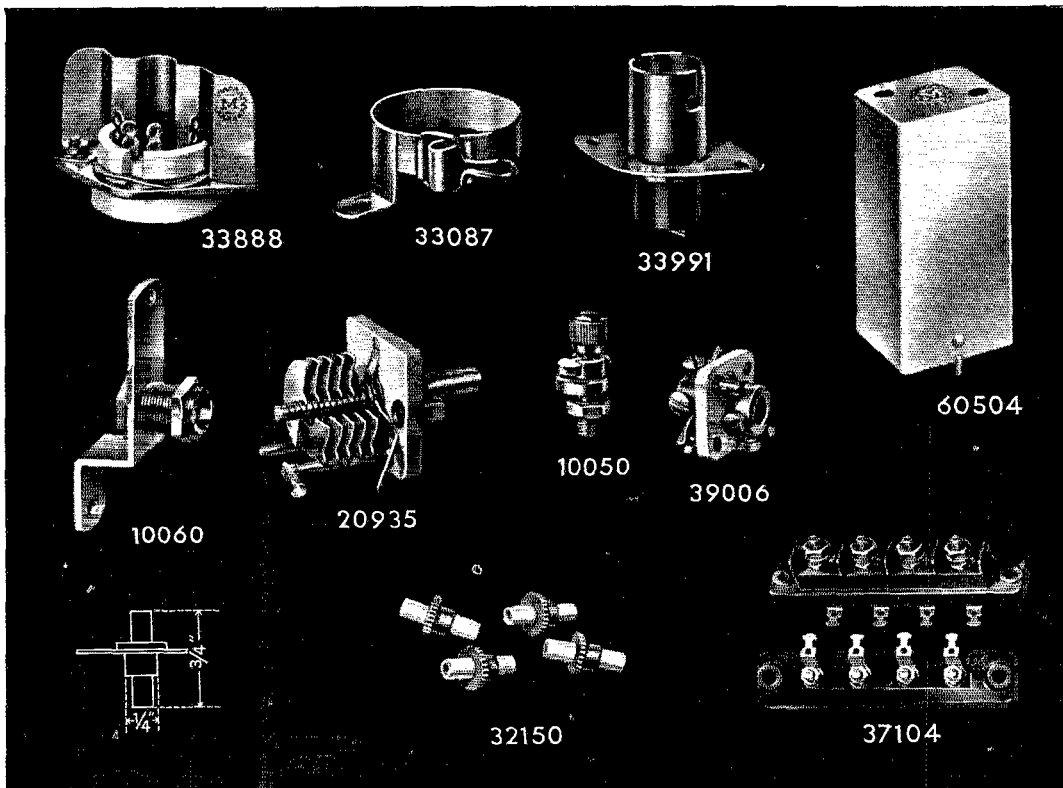

**MORE NEW**

# "Designed for Application"

## MILLEN GEAR

**ESPECIALLY** for mobile rigs! 33991 is socket for RCA 991 voltage regulator tubes. 32150 is entirely new type of Isolantite bushing. Fits  $\frac{1}{4}$ " hole in chassis. Locked in place instantly with drop of solder. No nuts to vibrate loose. 33087 is "snap action" base clamp for 807, etc. No tools required to remove tubes. 10050 is dial lock that does not cause detuning when operated. Single hole mounting. 10060 is concentric type shaft lock for "screw driver adjusted" controls. 33888 is socket shield to permit full advantage from use of "S" type of single ended metal tubes in high gain amplifiers. Provides effective electrostatic shield between grid and plate circuits. 20935 is double spaced ultra midget variable. 39006 is a radically new type of insulated flexible coupling which permits hubs to slide back and forth, in and out, twist, etc., without backlash!

**THESE** are just a few of the many new products that are continuously being added to the MILLEN line of ENGINEERED radio products. Other recent products, still too new to be listed in our general catalog, include FM discriminators (60504, etc.) and IF transformers, terminal blocks (37104, etc.), and many new styles of "UHF" transmitting and receiving condensers, etc., etc., etc.

**YOUR** distributor can show you these and other new as well as regular MILLEN components.

**Modern Parts**

**for Modern Circuits**

**JAMES MILLEN**  
150 EXCHANGE ST



**MFG. CO. INC.**  
MALDEN, MASS.

# A "New-Old" CARDWELL

## The Type "F" Frame

Through no particular effort on our part, this sturdy frame, capable of housing a variety of both fixed and variable air condensers, is staging a "come-back" via the commercial radio application route.

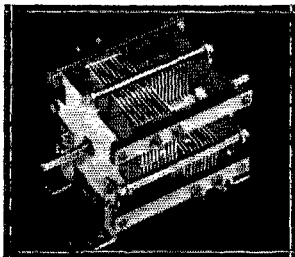

Special Type FR-500-PD  
Balanced Variable

Since our recent catalogs have not included them, we present two representative types with general characteristics for your information.

Amateur and commercial engineers will be interested in the fixed units for loading medium power tank circuits, and the dual variable is noteworthy for its adaptability for mechanically balanced, low torque work, particularly where a necessity for perfect bearings dictates the use of ball races.

### General Characteristics of the "F" Frame:

- End plates and tie rods — Brass, nickel plated.
- Plates, fixed or variable — Aluminum (3S).
- Insulation — G.E. Mycalex No. 1364.
- Frame size — 4" wide x 4" high.
- Mounting — Two standard "X" mounting feet, or four special long brackets (see cut of variable unit) or by three mounting posts on end plate.
- Bearings (on variables) — May be standard ball thrust rear bearing with front shoulder bearing, full ball bearings at each end, or any desired combination.
- Capacity — Standard combinations in the variable type.

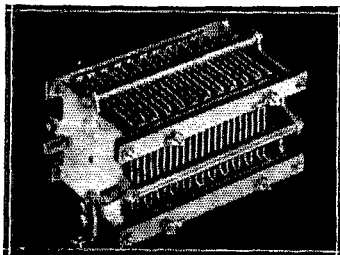

Special Type FS-220-YS  
Fixed Capacitor

**FIXED TYPES**  
150 to 1000 mmds.,  
.070" gap with  
.040" buffed plates  
with rounded edges,  
plus a special 220  
mmd. unit (See cut)  
with .153" airgap,  
6000 V. peak at 60  
cycles.

Quotations on request, but a list of standard types will be shown in Catalog No. 42, soon to be released.

**THE ALLEN D. CARDWELL  
MANUFACTURING CORPORATION**  
83 PROSPECT STREET, BROOKLYN, NEW YORK

W9BQJ	7676-101-38	W2BZJ	2590-43-30
W9NCS	6600-91-37	W2HRN	2436-58-21
W9DOB	5348-64-27	W2KEG	2100-42-25
W9FWN	32-4-4	W2JRU	1978-43-23
		W2CW	1824-48-19
		W2DYO	1680-35-24
		W2KKI	288-16-9
		W2JUC	80-8-5
		W2GVZ	64-8-4
		W2JKH	8-2-2
		W2MLP*	4-2-1
<b>DELTA DIVISION</b>			
<i>Arkansas</i>			
W5ASG	8200-100-41		
W5EIJ	5966-79-38		
W5HTX	1408-32-22		
<i>Louisiana</i>			
W5WG	31742-269-59		
W5KC	29028-246-59		
W5IFM	18150-182-50		
W5HQN	14739-147-51		
W5DWW	10752-128-42		
W5HQE	2322-43-27		
W5FVD	2275-46-25		
<i>Mississippi</i>			
W5BKC	13818-147-47		
W5FGE	7600-96-40		
W5IGD	5280-80-33		
W5DEJ	476-17-14		
<i>Tennessee</i>			
W4CXY	19928-188-53		
W4FCU	19552-189-52		
W4PL	13034-133-49		
W4FDT	12852-126-51		
W4ETD	2001-45-23		
W4FLW	532-20-14		
W4DDJ	190-10-10		
<b>Hudson Division</b>			
<i>Eastern New York</i>			
W2HXQ	13432-146-46		
W2ISJ	11560-170-34		
W2IZO	8432-124-31		
W2KXF	3900-65-30		
W2KPI	840-35-12		
W2KFN*	608-19-16		
W2LLX	2-1-1		
<i>N. Y. C. &amp; L. I.</i>			
W2HOP	35055-313-57		
W2HHF	27981-261-53		
W2DBQ	15840-176-45		
W2HUG	11802-141-42		
W2KYV	11466-147-39		
W2JIN	10693-135-37		
W2KKU	10434-141-37		
W2BGV	9288-108-45		
W2LEI	7106-94-38		
W2LZR	6600-100-33		
W2FTX	6192-87-36		
W2ION	4590-77-30		
W2BUK	3840-80-24		
W2GTL	3834-71-27		
W2MFR	3781-86-22		
W2KLC	3780-68-28		
W2JAU	3240-60-27		
W2BGO	3088-59-27		
W2DW	3016-56-26		
W2KSW	2520-58-20		
W2AHC	2162-47-23		
W2HBO	1800-45-20		
W2EC	1834-43-19		
W9SDC/2	1224-34-18		
W2GP	1080-36-15		
W2LWH*	704-22-16		
W2LLE*	690-23-15		
W2AVS	560-20-14		
W2LEE*	560-20-14		
W2CUE	300-15-10		
W2CLC*	238-17-7		
W2LIF*	128-9-7		
W2CMI	78-7-6		
W2LKG	52-7-4		
W2LIW*	45-9-5		
W2BO	32-4-4		
<i>No. New Jersey</i>			
W2GSA	36669-360-51		
W2LXI	24380-230-53		
W2KHA	24255-221-55		
W2EQS	20100-201-50		
W2JDC	12144-139-44		
W2GBY	10530-135-39		
W2BBK	9984-120-39		
W2IYQ	9720-122-40		
W2LMN	7676-101-38		
W2MLV	7480-110-34		
W2LUE	5880-98-30		
W2MAX	4096-64-32		
W2LJR	2912-56-26		
W2DZA	2600-52-25		
<i>Iowa</i>			
W9GKS	22200-185-60		
W9LEZ	14476-154-47		
W9QVA	7828-103-38		
W9ZQW	4148-61-34		
W9JAP	2783-61-23		
W9WMP	1472-32-23		
W9BBB	735-25-15		
W9WTD	720-20-18		
W9TJA	72-6-6		
<i>Kansas</i>			
W9CWW	27000-225-60		
W9VBQ	22440-204-55		
W9BYV	16320-170-48		
W9CVL	13668-134-51		
W9QIM	7511-102-37		
W9AWP	6336-88-36		
W9MKU	5320-76-35		
W9CGZ	12-3-2		
<i>Missouri</i>			
W9RSO	36580-310-59		
W9YZH	10168-124-41		
W9AFJ	5940-90-33		
W9GIP	4422-67-33		
W9JKI	4086-85-32		
W9QMD	3024-56-27		
W9BUD	1080-30-18		
W9EYM	600-20-15		
W9TBU	442-17-13		
W9KIK	224-14-8		
W9DBD	160-10-8		
W9KOH	160-16-5		
W9SOM	70-7-5		
<i>Nebraska</i>			
W9ZAR	33524-280-58		
W9ZRP	22522-215-59		
W9TQD	23490-218-54		
W9MGP	16014-157-51		
W9QNV	8736-104-42		
W9BBS	4375-63-35		
W9INR	2800-50-28		
W9DMY*	1656-36-23		
W9FLI	308-14-11		
W9ARE	120-10-9		
W9ZFC	108-9-6		
W9BZG	50-5-5		
W9GDB	6-3-1		
<b>NEW ENGLAND DIVISION</b>			
<i>Connecticut</i>			
W1BHH	17280-193-45		
W1CSG	13858-169-41		
W1KQY	13484-153-44		
W1QY	12192-127-48		
W1JHN	9760-122-40		
W1KIE	8280-138-30		
W1CSY	3120-57-30		
W1T	3350-67-25		
W1LTB	2898-69-21		
W1HS	1836-34-27		
W1BHM	1520-40-19		
W1CTI	1280-40-16		
W1NE	1105-33-17		
W1LOP	1084-38-14		
W1KDP	660-30-11		
W1TS*	37200-310-60		
W1UE*	21200-200-53		
W1BD*	3060-51-30		
W1LVQ*	12-3-2		
<i>Maine</i>			
W1DFJ	9266-113-41		
W1GKJ	8018-100-38		
W1IQZ	3172-61-26		
W1LMQ	2496-48-26		
W1MDF	2024-44-23		
W1MFK	504-21-12		
W1V	396-18-11		
W1GXY	300-25-12		
W1ERO	270-15-9		
W1LML	160-10-8		
W1LIE	110-11-5		

(Continued on next left-hand page)

# Announcing

## THE HANDIEST BOOK OF ALL!

# RCA HAM GUIDE...

## Hot Off the Press

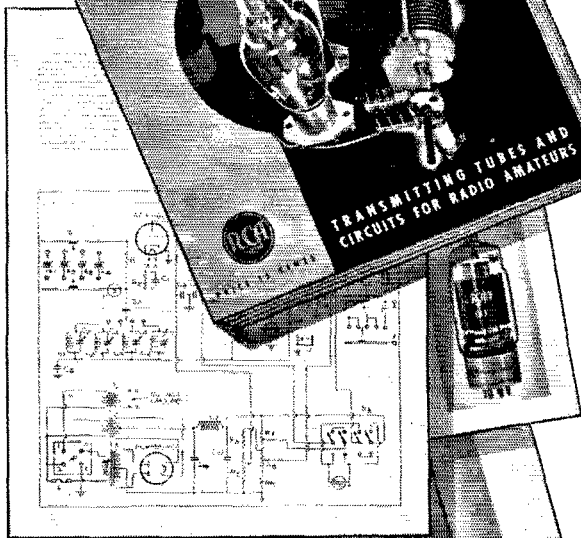
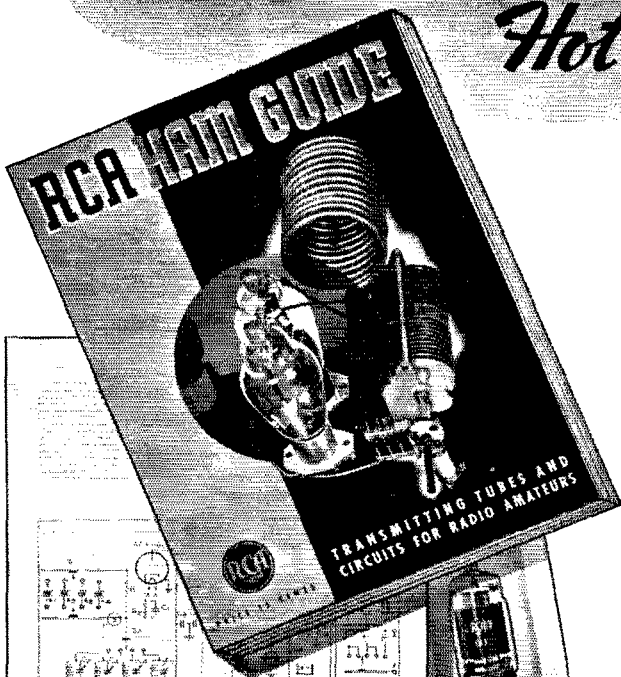

48 Pages Chock Full of Timely Circuits, Photographs, Construction Features and Data on Amateur Radio's Finest Transmitting Tubes. 15c Amateur Net.

Here's the Guide you've been waiting for—the most genuinely helpful, complete and practical volume of its kind RCA has ever issued. Written specifically for the amateur, it contains 48 pages filled with timely technical information on transmitter construction, transmitting tube circuits and complete data on amateur radio's greatest line of tubes.

Easy-to-build rigs designed from "mike to tank"; latest in cathode modulation; "hot" plate-modulated and c-w rigs; straight-forward single-stage circuits, up-to-the-minute data on famous tubes such as the RCA-802, 806, 807, 808, 809, 810, 811, 812, 828 and many others. Tells what to do and exactly how to do it. Richly illustrated, it is a boon to the newcomer, indispensable to the old-timer—a book that is a "must item" for every shack.

Available through RCA Power Tube Distributors, or send 15c direct to RCA Commercial Engineering Section, Harrison, N. J.

### HAM TIPS

#### Free

This helpful little publication is prepared by RCA specifically for the amateur. Free from all RCA Power Tube Distributors.



NOW! PRACTICAL TELEVISION for Amateurs... See back cover announcement



# Transmitting Tubes

## For PERFORMANCE PLUS

RCA MANUFACTURING COMPANY, INC., CAMDEN, N. J. • A Service of the Radio Corporation of America

# NEW Attenuators at NEW Low Prices

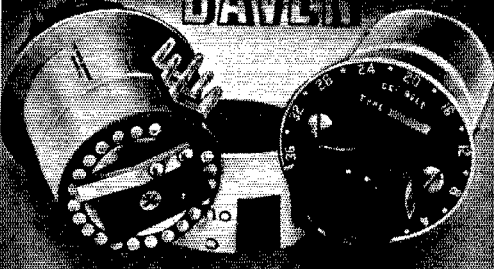

• Noise level below microphones • Excellent frequency characteristics • Low in price, small in size.  
• Complete with dial, knob and shield. • Now ready for immediate shipment.

## Series LA-800 Ladder Network Price \$5.75 20 Steps

SERIES	DECIBEL PER STEP	CHARACTERISTIC	DECIBEL TOTAL
LA-800	2.0	Tapered	Infinite
LA-801	1.5	Linear	Infinite
LA-802	3.0	Linear	Infinite
LA-803	2.0	Linear	40 Db.

Compact low impedance mixing controls for use in portable broadcast equipment and public address systems, similar in construction to larger and costlier units. Dependable, accurate, noiseless in operation, and constant impedance over operating range.

## Series CP-800 Grid Control Price \$5.75 20 Steps

SERIES	DECIBEL PER STEP	CHARACTERISTIC	DECIBEL TOTAL
CP-800	2.0	Linear	Infinite
CP-802	1.5	Linear	Infinite
CP-803	3.0	Linear	Infinite
CP-804	2.0	Tapered	Infinite

These Potentiometers are designed for use as gain controls in portable amplifiers and public address systems. They are rugged, compact, and are readily adaptable to popular priced systems. Long and trouble-free service can be obtained from this type of attenuator.

## FIXED ATTENUATOR (Pads)

Impedances may be secured from 30 to 600 ohms.



"T" Network  
Type T950 ... \$2.50  
Size 1 1/16 x 1 1/8

Balanced  
"H" Network  
Type H950 ... \$3.00  
Size 1 1/16 x 1 1/8

WRITE FOR CATALOG

# THE DAVEN COMPANY

<b>E. Massachusetts</b>		<b>East Bay</b>	
W1EKN	10362-157-33	W61PH	7728- 92-42
W1WV	7144- 94-38	W6ONQ	7137- 92-39
W1JSM	6210-115-27	W6LMZ	6192- 86-36
W1JEA	4785- 73-33	W6CSJ	5440- 81-34
W1BDU	4488- 68-33	W6LVI	3808- 57-31
W1LBY	3996- 74-27	W6OCH	3762- 57-33
W1QF	3503- 57-31	W6EY	3120- 60-26
W1EPE	3250- 65-25	W6EJA	780- 28-14
W1ICA*	2304- 48-24	W6RQE*	4- 2- 2
W1KVB	2280- 60-19		
W1BAQ	1911- 46-21	<b>San Francisco</b>	
W1LYL	1824- 38-24	W6CIS	12936-132-49
W1LNN	1258- 37-17	W6RBR	10032-114-44
W1ALP	756- 27-14	W6PGB	4719- 72-33
W1QW	480- 20-14	W6MUF	4410- 63-35
W1LRO	84- 7- 6	W6OOC	2772- 50-28
W1MHC	32- 4- 4	W6LMD	320- 16-10
		<b>Sacramento Valley</b>	
<b>W. Massachusetts</b>		W6PAR	15808-152-52
W1EOB	16544-188-44	W6GAC	1200- 30-20
W1BGY	11008-128-43	W6MDI	60- 6- 5
W1FKI	9014-119-38		
W1DCH	7280-104-35	<b>San Joaquin Valley</b>	
W1JYH	5742- 87-33	W6AFH	6080- 70-40
W1BIV	3450- 69-25	W6CLZ	3876- 57-34
W1BDV	1200- 40-15	W6IWU	300- 25-16
W1LJF	760- 25-15		
W1IAJ	640- 20-16	<b>ROANOKE DIVISION</b>	
W1FNY	416- 16-13	<b>North Carolina</b>	
W1LHY	154- 11- 7	W4DQ	4692- 69-34
		W4DLX	1900- 50-19
<b>New Hampshire</b>		W4COH	1800- 36-25
W1BFT	27390-249-55	W4GIQ	1401- 39-18
W1MGH	3105- 58-27		
W1LTD	2200- 44-25	<b>South Carolina</b>	
W1KIN	2178- 64-17	W4BEF	6868-102-34
W1ATE	1232- 29-22	W4DNR	6188- 91-34
		W4CZA	640- 20-16
<b>Rhode Island</b>			
W1LAB	15876-190-42	<b>Virginia</b>	
W1KWA	14508-186-39	W3BZE	19584-204-48
W1KRW	3348- 62-27	W3ALF	660- 22-15
W1KZN	1520- 40-19	W3IME	242- 11-11
W1BOY	1376- 43-16	W3HDP	198- 11- 9
W1LWB	585- 20-15	W3GTS	108- 9- 6
W1HRC	320- 16-10	W3ICQ	100- 10- 5
		W3GWQ	70- 7- 5
<b>Vermont</b>		<b>West Virginia</b>	
W1KTB	20140-191-53	W8LCN	20034-189-53
W1BNS	10010-143-35	W8OXO	6265- 90-35
W1KJG	48- 6- 4	W8JSM	6020- 67-35
		W8JJA	2403- 43-28
<b>NORTHWESTERN DIVISION</b>		<b>Rocky Mountain Division</b>	
<b>Idaho</b>		<b>Colorado</b>	
W7AYQ	5400- 70-39	W9EII	7020- 90-39
W7UQ*	5254- 72-37	W9CDP	5776- 76-38
W7HDI	520- 20-13	W9GLI	2700- 45-30
W7GXC	442- 17-13	W9HFC	1800- 45-20
		W9FA	1384- 31-22
<b>Montana</b>		W9YFJ	598- 23-13
W7JJC	7812- 93-42	W9FES	48- 6- 4
W7HCY	3712- 59-32		
W7GSU	832- 26-16	<b>Utah-Wyoming</b>	
W7GYB	98- 7- 7	W6FYR	8400-100-42
		W7GCO	3540- 69-30
<b>Oregon</b>		W7HMC	728- 26-14
W7GPP	10752-113-48	<b>SOUTHEASTERN DIVISION</b>	
W7ENW	3710- 56-35	<b>Alabama</b>	
W7GNJ	2800- 50-28	W4EV	29441-250-59
W7BOH	1892- 43-22	W4CYC	24360-210-58
W7GVG	1260- 35-18	W4EDR	23097-195-59
W7DXF	588- 21-14	W4AAG	9503-112-43
W7BDE*	1- 3- 3	W4PZG	9156-109-42
		<b>Eastern Florida</b>	
<b>Washington</b>		W4EFM	5565- 80-35
W7FJQ	7160- 90-40	W4DAH	2- 1- 1
W7WY	484- 22-11	<b>Western Florida</b>	
W7LD	240- 12-10	W4AXP	6020- 86-35
W7CWN	180- 10- 9		
<b>PACIFIC DIVISION</b>		<b>Georgia</b>	
<b>Hawaii</b>		W4AGI	19012-194-49
K6PAH	3892- 72-28	W4FTI	17068-161-53
K6CGK	1558- 41-19	W4FGU	9546-112-43
		W4AQI*	6080-101-40
<b>Nevada</b>		W4DJT	4158- 63-33
W6CW	3410- 55-31	W4DIA	2133- 40-27
W6GSB	160- 10- 8	W4AOB	1826- 42-22
		W4MA*	748- 22-17
<b>Santa Clara Valley</b>		W4VX	330- 15-11
W6PBV	10752-112-48		
W6DZE	178- 22- 8		
W6YU*	72- 7- 6		
W6QLO	70- 7- 5		
W6MXE*	2- 1- 1		

(Continued on next left-hand page)

# THOUSANDS

## of United States Stations Use

# Taylor's 866



### Here's the Success Story!

The famous Taylor 866 is celebrating its Seventh Anniversary—seven years of Sales Leadership—seven years of real "dollar and cents" savings to thousands of amateur and commercial users.

In 1933, with competitive tubes selling for \$7.50, (just reduced from \$12.50) the announcement of the broadly guaranteed Taylor 866 at \$1.65 was the sensation of the radio world. Sales of Taylor's 866 skyrocketed and leadership has been constantly maintained.

In 1939, Taylor introduced its new Heavy Duty Shielded 866 at \$1.50\*. Since then increasing numbers of unsolicited reports have acclaimed its performance in Broadcast, Police, Airline and Amateur installations.

If you want real "More Watts Per Dollar" value, insist on Taylor Tubes. Taylor's liberal guarantee protects your investment.

\* Same characteristics as 866A. Peak inverse 10,000 volts.

ACTUAL  
SIZE  
New Shielded  
**866**  
**\$1.50**



866 Jr.  
\$100

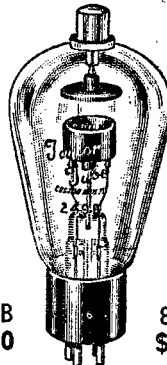

249-B  
\$500



872-A  
\$1050

*"More Watts Per Dollar"*

TAYLOR TUBES, INC., 2341 WABANSIA AVE., CHICAGO, ILLINOIS

# RADIO TRAINING



**P**ORT ARTHUR COLLEGE — not privately owned, not operated for profit, a college built and endowed by the late capitalist-philanthropist, John W. Gates — offers the most thorough practical Radio training in America. P. A. C. owns Radio Station KPAC, which is equipped with the very latest type 1000-Watt high fidelity RCA transmitter, operating on 1220 kc. with directional antenna system. The college is authorized to teach RCA texts. Additional equipment consists of the latest type Marine and Airways Transmitter installation complete; SOS Automatic Alarm; Marine Direction Finder, two-way Television Transmitter and Receiver; Trans-radio Press Receiving Equipment; laboratory facilities where every phase of practical radio assembly technique is taught. Students assemble composite transmitters, audio amplifiers, RF amplifiers, etc. The Radio training covers thoroughly Airways, Press, Announcing, Teletype, Typewriting, Laboratory and practical experience at KPAC transmitter, control room and studios. Announcing is an optional part of this training; nevertheless a number of students annually make successful announcers.

Port Arthur College pioneered the teaching of radio with its first classes in 1909, and for thirty-one years has maintained an active Employment Bureau that is successful in placing graduates in airways, broadcast and marine radio industries.

*If interested in details about the Radio Course, write for Bulletin R*

**PORT ARTHUR COLLEGE**  
**PORT ARTHUR (World-Known Port)**  
**TEXAS**

## PRECISION CRYSTALS

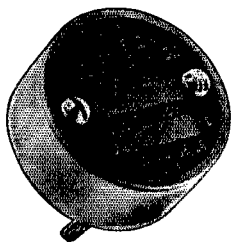

Highest quality crystals carefully prepared for dependable performance.

Low frequency drift Type 4-A unit plugs into tube socket, 40, 80 or 160 meter bands, within 5 kc. of your specified frequency — \$4.00. Calibration 0.03%.

'X' cut in Type 4 holder — \$3.50.

Crystals for commercial requirements quoted on at your request. Now in our Tenth year of business.

**PRECISION PIEZO SERVICE**

427 Asia Street

Baton Rouge, La.

### West Indies

K4FCV 10890-121-45  
 K4KD 2436- 42-29

### SOUTHWESTERN DIVISION

#### Arizona

W6KFC 32860-265-62

#### Los Angeles

W6PUZ 22110-201-55  
 W6AM 21010-194-55  
 W6ONG 19546-189-58  
 W6IOJ 18105-178-51  
 W6IOX 7298- 89-41  
 W6MQM/6 6474- 83-39  
 W6PTR 4310- 62-35  
 W6RYC 1080- 27-20  
 W6ACL 384- 16-12  
 W6DYQ 352- 16-11

#### San Diego

W6MUS 22900-215-55  
 W6BBR 20055-191-55  
 W6PCE 19525-180-55  
 W6BAM 9752-106-46  
 W6ISG\* 836- 22-19

### WEST GULF DIVISION

#### Northern Texas

W5AWT 15337-160-49  
 W5GKA 11711-121-49  
 W5DXA 6880- 86-40  
 W5BKH 2175- 38-29

#### Oklahoma

W5AQE 13616-148-46  
 W5FMP 480- 16-15  
 W5CFC 48- 8- 3

#### Southern Texas

W5HBB 15840-168-48  
 W5FZD 15141-156-40  
 W5IGJ 13216-148-46  
 W5DBR 12096-127-48  
 W5EWZ 5776- 77-38  
 W5DDJ 4488- 66-34

#### New Mexico

W5HAG 5400- 75-36  
 W5CJP 5005- 72-35  
 W5GSD 1020- 30-17  
 W5HJF 180- 10- 9

## 14th Annual Rocky Mountain Division Convention

*Lincoln Park and Auditorium, Grand Junction, Colo., July 6th and 7th*

**T**HE Western Slope Radio Club, sponsoring the 14th Annual West Gulf Division A.R.R.L. Convention to be held in Grand Junction, Colo., July 6th and 7th, expect to cover every square foot of the 125 acres of recreation grounds in Lincoln Park with conventioning hams. To secure this result they have arranged a program including demonstrations, technical talks, special meetings, a conducted tour through the Rio Grande shops, prize drawings, etc. The pre-registration fee (deadline July 1st) is \$2.50; thereafter \$3.00 (ladies, \$1.50). Special rates on the Rio Grande Railroad. Write M. E. Erickson, W9FQT, Grand Junction, Colo.

## Heterodyne Exciter

*(Continued from page 40)*

oscillator. The next in is the five-meter band calibration. This is followed in turn by 10- and 20-meter band scales. A dial drive such as the National PW would probably give smoother action, but has the disadvantage of not being directly calibrated.

The frequency range of the variable oscillator is 500 to 1000 kc. This is very convenient, for the calibration is easily obtained by beating with broadcast stations. With 150 plate volts, regulated by a VR150, the stability as regards drift and shift due to line voltage variation is highly satisfactory. Even better stability could be obtained by using a pair of electron-coupled oscillators in place of the 6N7, but in the authors' case it was not found necessary.

The mixer stage is the most unorthodox. The screens are not given any positive voltage; they are returned to ground through an r.f. choke. If

*(Continued on next left-hand page)*



# "RCA Equipment is Tops"

says S. A. Greever, W5EXW,  
AND OWNER OF  
SOUTHWEST RADIO SUPPLY, DALLAS, TEXAS

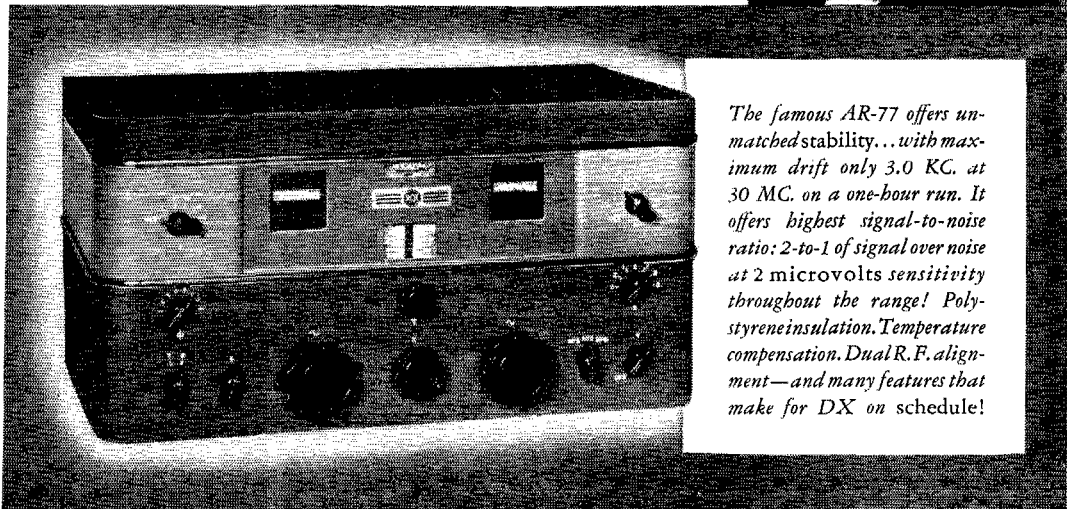

*The famous AR-77 offers unmatched stability...with maximum drift only 3.0 KC. at 30 MC. on a one-hour run. It offers highest signal-to-noise ratio: 2-to-1 of signal over noise at 2 microvolts sensitivity throughout the range! Polystyrene insulation. Temperature compensation. Dual R.F. alignment—and many features that make for DX on schedule!*

Down around Dallas, amateurs know Sneed Greever. The country over, amateurs know his call: W5EXW. And amateurs respect Mr. Greever's judgment. He says:

"We consider our RCA Franchise on Power Tubes, Receiving Tubes, Test Equipment and Amateur Equipment a most valuable asset."

Amateurs come to him for RCA Equipment because they believe, with him, that RCA Equipment is dependable! They know that no other manufacturer offers RCA's world-wide back-

ground in communications . . . or RCA's facilities and personnel. They know that RCA Amateur Receivers are your *best* buy, dollar for dollar.

Over 335 million RCA Radio Tubes have been purchased by radio users . . . in tubes, as in parts and test equipment, it pays to go RCA ALL THE WAY.

## GO RCA ALL THE WAY!

- ★ Amateur Equipment
- ★ Receiving Tubes
- ★ Power Tubes
- ★ Test Equipment



# Tubes and Test Equipment

# The A.R.R.L. ANTENNA BOOK

**Has Whatever You Want!**

## CHAPTERS

1. Wave Propagation
2. Antenna Fundamentals
3. Ground Effects
4. Feeder Systems
5. Half-Wave Antennas
6. Long Single Wires
7. Multiband Antennas
8. Driven Arrays
9. Parasitic Arrays
10. "V" Antennas
11. Rhombic Antennas
12. Antennas for 160 Meters
13. U.H.F. Antennas
14. Special Antenna Systems
15. Finding Directions
16. Supports and Construction
17. Rotating Mechanisms
18. Receiving Antennas

144 pages, in "QST" format.

50 cents, postpaid. No stamps, please!

**A.R.R.L. WEST HARTFORD  
CONNECTICUT**

## RADIO COURSES

Start September

RADIO OPERATING • BROADCASTING • CODE  
RADIO SERVICING • TELEVISION  
• ELECTRONICS — 1 year day course; 2 years eve.  
Day and Evening Classes — Booklets upon request

**NEW YORK YMCA SCHOOLS**  
4 West 63rd Street, New York City

## HOW TO LEARN CODE

Whether you wish to enter radio as a career or as a hobby, the All Electric Master Telexplex Code Teaching Machine will show you how. Telexplex records your sending in visible dots and dashes on a specially prepared waxed paper tape and then sends back to you at any speed you desire. It does not merely show you code. It is code. No experience needed.



While not designated as standard equipment, Telexplex is used at many U. S. Army Posts, Naval Training Stations as well as by the American Telephone & Telegraph Co. Also by practically every private school in the U. S. teaching code; and many foreign governments.

### FREE BOOK

We furnish you complete course, including practice messages, the All Electric Master Telexplex, plus a personal service on a **MONEY BACK GUARANTEE.** Low cost. Easy terms. Without obligation write for booklet "Q7."

In Canada write:

**CANADIAN ELECTRONIC INST., TORONTO, ONT.  
TELEPLEX CO. 67-69 PARK PLACE  
NEW YORK, N. Y.**

the ordinary screen voltage is applied to them, the load is too heavy for the crystal oscillator, and the conversion efficiency is reduced. Obviously, no r.f. at the crystal frequency can appear in the plate tank, for the screens are excited in parallel, and the r.f. balances out in the push-pull output. The control grids are driven in push-pull by the low-frequency oscillator, but no signal from this source can be found in the mixer plate circuit because its resonant frequency is far removed from that of the driving oscillator.

Two points of resonance will be found in the output of the 6F6's. One is the frequency 6499 kc. plus 500 to 1000 kc., and the other 6499 kc. minus 500 to 1000 kc. The first and higher frequency resonance is the correct one, of course, for it gives an operating range of approximately 7000 to 7500 kc. If the double frequency of an 80-meter 'phone-band crystal had been used, the lower frequency sideband should be used.

### Operating Data

Doubling is possible in the mixer stage but is to be strongly discouraged because it gives four output frequencies. If the low-frequency oscillator is set at 500 kc. these would be 14,000, 14,500, 12,000 and 12,500 kc. It is easy to mistake one of these frequencies for the other, and may lead to off-frequency or double-frequency operation.

With no load on the mixers, the low frequency will be found to change about 200 cycles when the mixer plate tuning is swung through resonance. This is due to a reactive load reflected through the tubes. When the output is loaded, however, this effect becomes very small. The coupling to the next amplifier is obtained by a link, and is the most satisfactory method found.

The plate circuit efficiency of the 6F6's runs about 50 per cent. Other tubes such as 42's and 89's were tried as mixers and worked as well. The beam power tubes, while giving somewhat greater output, were troublesome because of parasitics. A pair of 6L6's, for instance, will give up to 15 watts output as compared with about 3 watts for the 6F6's. The plate current was correspondingly greater, but they were never free from spurious oscillations. Because of increased loading of the low-frequency oscillator, the frequency stability was much less.

For c.w. work, either the crystal or the low-frequency oscillator may be keyed. Both methods give a clean-cut note with no chirp. This is probably because the other tuned circuits in the transmitter are on a frequency different from either of the oscillators and thus there is much less liability of transients acting upon them.

This variable frequency exciter has been in use at W1BKO for over two months and is used to drive three 6L6's as doublers in cascade, ending up with a pair of 6L6's on five meters. It is very easy to set the v.f. unit on a station's frequency while listening to him, and come back to him on his own exact frequency. The signal has never failed to get a report of excellent stability. It is definitely better than most e.c.o.'s of ordinary design and equally as stable as any crystal controlled transmitter that we have heard.

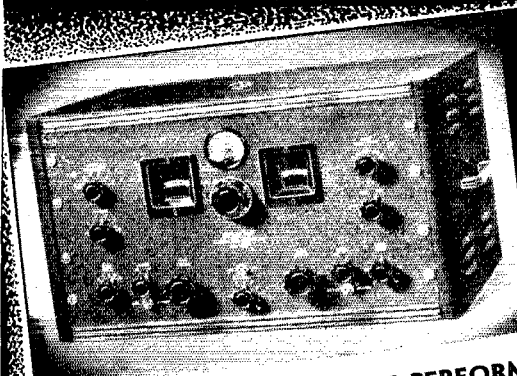

**Hammarlund**  
**SUPER-PRO**  
**\$27.90 down**

**A COG IN THE CAA'S PERFORMANCE RECORD**

Write for free descriptive literature

Model  
**SP-210-SX\***  
**SP-210-X\***

Tuning Range  
**7 1/2-240 meters**  
**15-560 "**

Cash Price  
**\$279.00**  
**279.00**

Down Payment  
**\$27.90**  
**27.90**

Per Mo. for 12 mos.  
**\$22.18**  
**22.18**

\*Includes 10" Speaker in cabinet to match receiver

**HAMMARLUND**  
**NEUTRALIZING**  
**CONDENSERS**

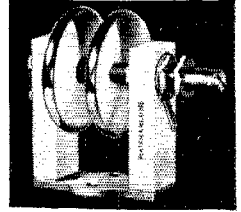

Model	Capacity	Net Price
N-10	2.1-10 MMF	\$1.80
N-15	3.2-14 MMF	3.60
N-20	3.8-14 MMF	3.90

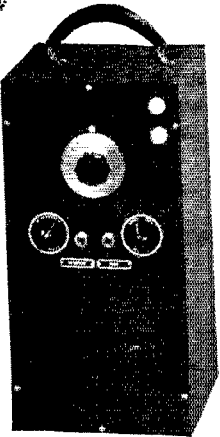

**Hammarlund**  
**HQ-120-X**  
**\$13.80 down**

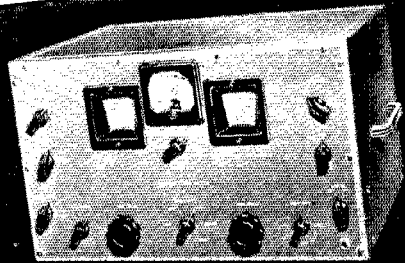

- ★ VOLTAGE REGULATED POWER SUPPLY
- ★ DRIFT CORRECTED
- ★ DIRECT CALIBRATED BAND SPREAD
- ★ VARIABLE CRYSTAL SELECTIVITY
- ★ COMPLETE, WITH 10" PM SPEAKER

**CONVENIENT PAYMENT PLAN**

Model	HQ-120-X
Cash Price	\$138.00
Down Payment	13.80
Per Mo. for 12 mos.	10.97

**\$10.95**

**NET PRICE**  
**LESS TUBES**  
**and BATTERIES**

**KIT OF PARTS FOR THE QST 112 MC**  
**SELF CONTAINED BATTERY TRANSCEIVER**

*Described in*

April '40 QST on Page 28 by Vernon Chambers  
All parts of nationally advertised manufacturers, and as recommended in the original article, drilled chassis and panel including cabinet. Complete instructions, layout blueprints, and diagrams.

**ACCESSORIES USED IN 112 MC TRANSCEIVER**

	Net Price
1 Hytron Hy 615	\$2.00
1 RCA 6G6G	.67
1 Kit 4 "B" and 1 6V "A" Burgess batteries	4.53

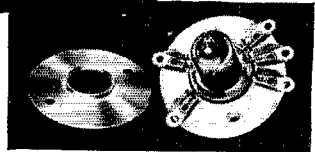

**New Hammarlund Acorn Socket**  
**Model UHS-900**

ISO-Q insulation, Beryllium copper silver plated contacts, supplied with shield for complete internal shielding.

Net Price **66¢**

**The RADIO SHACK**  
**167 WASHINGTON ST., BOSTON, MASS., U.S.A.**

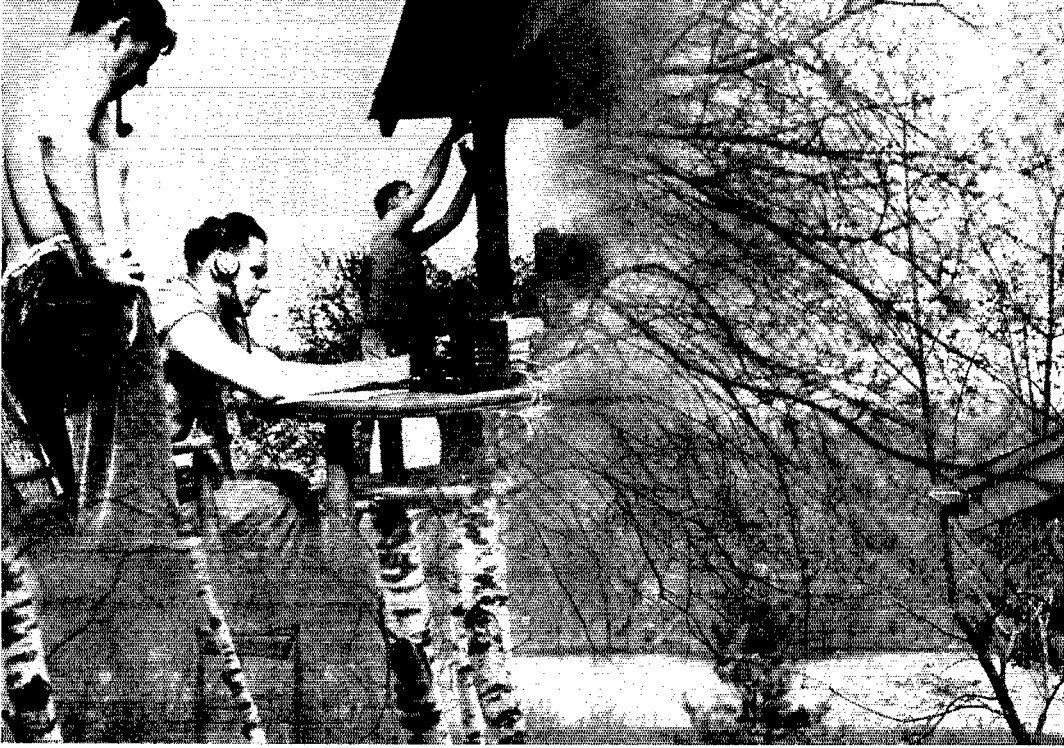

# **SUMMER TIME IS SP**

**QST AND THE HANDBOOK  
ARE THE BASIS OF  
EVERY AMATEUR'S LIBRARY**

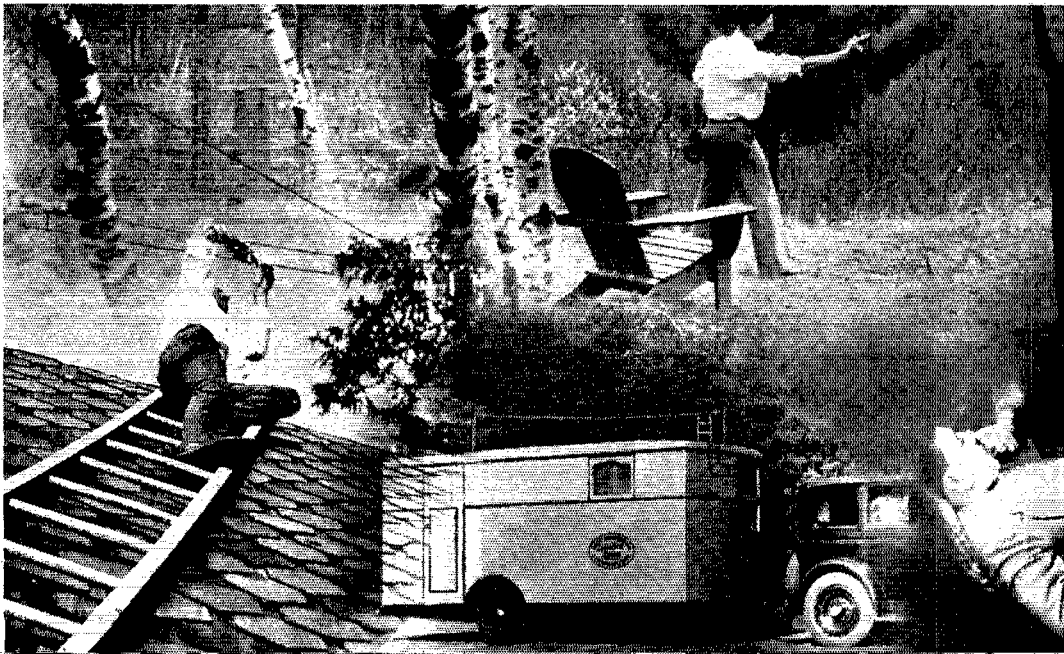

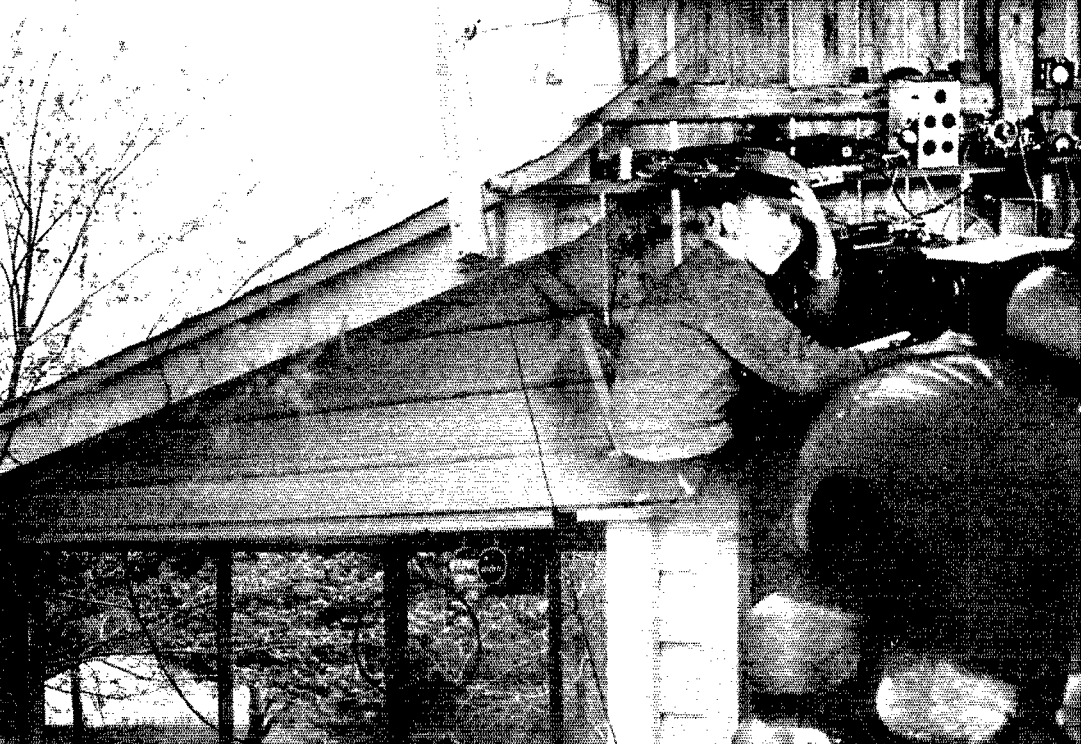

# SPECIAL OFFER TIME

A.R.R.L. Membership  
QST Subscription  
and the HANDBOOK

all for **\$3.00**

*During July and August only*

\$3.25 U. S. Possessions, Canada  
\$3.75, Canadian funds, \$3.75 else-  
where, U. S. funds. *Only direct  
orders to A.R.R.L., West Hart-  
ford, Conn., U. S. A., can be  
handled at these special rates.*

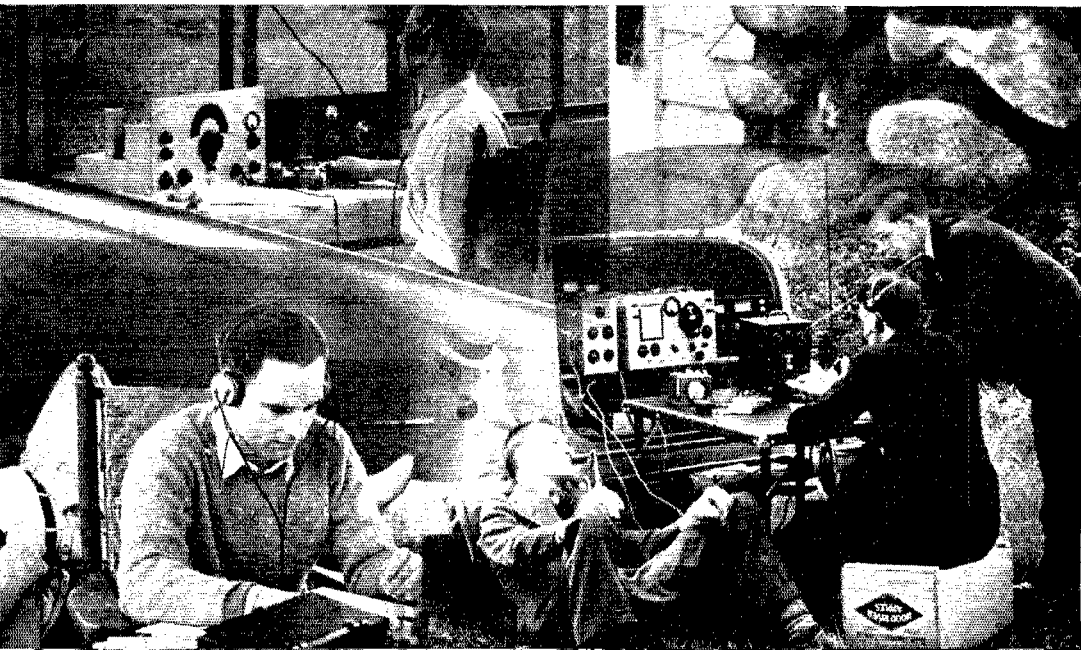

# Station Activities



## NEW ENGLAND DIVISION

**MAINE**—SCM, H. W. Castner, W1HE — The Pine Tree Net closed for the summer on May 3rd after a most successful season. Your S.C.M. had the pleasure of visiting the Portland Amateur Wireless Ass'n on May 14. I am most happy to report some real action in Waterville. The boys up there have formed a fine club, called The Waterville Amateur Radio Club. HSE is president and LMM secy-treas. BTG is vice-president. The boys meet every two weeks in the summer and every week in the winter. We expect to hear JPC with a 242A soon. The boys at OR are doing some fine DX work on 14 Mc. with 500 watts 'phone and 1 kw. on c.w. Many of the boys down this way forwarded a lot of messages to our vice-president, "George," W1KH, on his birthday, May 14th. This fine idea was started by "Ed" W1LYK. Any of you fellows who belong to radio clubs anywhere in New England will be most interested to find out more about the New England Radio Club Council. Information is available from Frank L. Baker, Secy., W1ALP, 21 Colby Road, North Quincy, Mass. This Council does a tremendous good in gathering opinion for the information of the New England Director. I most sincerely urge every radio club to investigate. FV is planning to get a good rig on the air by fall, with either 807's or 809's doing the pushing. I enjoyed a visit to the Northeastern Amateur Radio Club in Wiscasset, May 1st. HYK entertained, and passed out a swell feed. We never saw a new ham make faster improvement than MLP. Good work, Carl. We still need many more Emergency Coordinators in cities and towns. Fellows, this is a most worthy activity. We had a serious flood disaster last August, over West Baldwin way, and no-one on earth knows where or when these things strike, so be prepared. The best preparation is to be lined up with the Emergency Corps so that the authorities know where help can be obtained. I have a full and complete instruction sheet telling you exactly what to do and what NOT to do in emergencies. Better send for one. DHH is on 3.9-Mc. 'phone. VF is active in the N.C.R. LRQ is C.C. on 7191 kc. GOJ still maintains the 14300-ke. 'phone schedule with 5FYZ. LIC has assembled an emergency station and is ready for anything. LHA is rebuilding. LIP is on 1.75-Mc. 'phone every evening. MNI is back on 1.75-Mc. 'phone. KSL is building a small c.w. rig for code practice. LYV and LEH operate the rig at the N.Y.A. station in Eastport. MII, LVJ is working in Woodland, but can't use his rig on the 25-cycle supply there. EOP is on 3.9-Mc. 'phone some. FJP has completed a new rig. LOZ received his W.A.S. certificate after being licensed only 18 months. Fine work, Capt. Rounds. EBM is active, and has schedule with LYK often. The Naval Reserve in Lewiston and Auburn entertained the local hams on April 27th with a fine supper, and 28 attended. If any of you boys are in Boothbay Harbor this summer, be sure to look up LUK. "Ralph" is one grand fellow and very active in the club there. If you are looking for the S.C.M. on the air, I shall stay on 3597 kc. all summer, and the "latchstring" is hanging way out. The A.A.R.S. is still hitting the high spots, and these boys are improving all the time. I hear that BWR is going to do some active duty in the Navy. GKC is still "all hopped up" over that rig on the island; I understand that the engine to furnish the power for the rigs will have to be taken there by airplane.

Traffic: W1HE 21 LYK 20 LRP 5 LHA 14 LIC 48 DHH 2. A.A.R.S.: W1AMR 106 BTA 17 CFO 107 EFR 34 FAP-GE 41 GHT 34 GVS 104 JLF 20 KOU 205 KTN 45 LAP 36 LIC 39 LER 20 LML 53.

**EASTERN MASSACHUSETTS**—SCM, Frank L. Baker, Jr., W1ALP — SS is Radio Supervisor Mass. N.Y.A. JDF puts an S9 signal into Boston. Welcome to Billy Dale of Somerville, none other than the old star of stage and screen, now on 28 Mc. with call MQO. MJK on 28 Mc. is a member of Boston Symphony Orchestra. We have talent in our midst. LTC and MGQ both have new Jr. ops. Congrats. LYH changed QTH. FVN is on 28 Mc. again. JGQ wants more Lynn hams for Emergency Corps. What say, gang? LZV is on 112-Mc. mobile and visited HDQ. LVN changed QTH to Falmouth; will be on 7 and 112 Mc. MDU is in the F.T.S. HUV using a.c.m. worked KH using f.m. on 56 Mc., for first f.m. contact. ELP and KH had

first two-way f.m. QSO on 56 Mc. that has been reported. HIL resigned his O.O. and O.P.S. Sorry, Larry, you felt it necessary. Hope you are with us again later. LNN is new O.R.S. S.S.A.R.C. of Quincy had election of officers: pres., ALP; vice-pres., BIO and CPB; secy., FWS; treas., FVD. KH and ALP attended M.V.A.R.C. annual banquet. ALP and GTN attended dedication of the Parkway Radio Ass'n new station HOB, which is on 1.75- and 3.9-Mc. 'phone; the call was secured, in memory of a deceased member. IXL has 1kw. on 3.9-, 14- and 28-Mc. 'phone. He and EQN applied for O.P.S. KH went to Hudson Div. Convention. MKN has HK24 in final and is back on 1.75-Mc. 'phone. LQV is handling traffic at C.C.C. Camp. AGX is keeping his daily schedules. BDU is on with his daily schedules. WI will be on soon. FGT is back on. AAR is on 1.75-Mc. 'phone, 3.5-Mc. c.w., 112-Mc. 'phone and also 112-Mc. mobile. EHT worked Wyoming for 45th state. 56-Mc. activity is picking up around Boston. GCU is working on portable rig and superhet. KCQ worked portable at Tufts College on Engineering night on 1.75-Mc. 'phone with HWQ, KIQ and MKU. HWE has A.A.R.S. daily schedule on 28 Mc. BIO, DNL, IHA, ALP, LYL and KRL were at Worcester Convention. CGB is on 28 Mc. with pair of T55's. QV has two new poles at his new home. IN has a new vertical antenna for 56 and 28 Mc. 5HCC from Okla. has been visiting some of the locals. The E. Mass. O.R.S. Net closed for the summer, to reopen Sept. 3rd.

Traffic: W1LWH 288 BDU 179 AGX 93 AAR 87 MDU 43 QW 28 KH-HWG 20 LNN 19 WI 11 MKN 10 GCU 7 LQV 5 BB 4 IXL-GAG 3 KCQ-JXU 2 KZT 56 AKS 194 FWQ 26 JSM 99 LBY 96 KTE 7 JCK 268 (WLWG 39) EPE 304 PSL 76 JYJ 130 MEU 10 KCT 176 IIM 11. (Mar.-Apr.: W1WI 9 SS 10 JYJ 208.)

**WESTERN MASSACHUSETTS**—SCM, William J. Barrett, W1JAH — JAH enjoyed meeting all of the gang who attended Worcester Convention. The emergency rig had a good workout in the A.A.R.S. ZCB contest, and guess we are all set now. Other members of the Section who were on for the contest using emergency-powered set-ups included EOB, BVR and AZW. BVR conducted A.A.R.S. meeting at the Convention at Worcester. Perce has new 6-volt supply for the receiver, and reports that it worked swell in the contest. AJ has been supplying the Hartford Weather Bureau with River data via the Conn. Valley Net. Ralph had visits from IIP, JMH, MJP and LPC, and also hooked a few K6's on 7 Mc. DCH keeps active in A.A.R.S. KRX reports that he is helping LNF to get rig on air. Bill also says that KTX is building 56-Mc. portable for use in car and shack. JYH needs only Nevada for W.A.S. BNL reports Hetroff working fine, and that cathode modulation is next on the program. MIM, Fitchburg's new YL op, is active on 3517 kc. KZU is active on 3.5 and 112 Mc. LEP has 500-watt a.c. generator. LRE is operating mobile on 112 Mc. How about some reports?

Traffic: W1JAH 148 (WLGH 36) BVR 34 (WLG 118) AJ 17 DCH 6 KRX-JYH 5 EOB 539 BIV 178 LJF 105.

**NEW HAMPSHIRE**—SCM, Carl B. Evans, W1BFT-DMD — The Manchester Radio Club was entertained on May 24th by Dick Briggs, BVL, of the Hytron Corp., who gave an interesting talk concerning transmitting tubes, particularly the new HY75 and HY69. He also demonstrated a concentric tube oscillator on approximately one meter, using a type HY75 tube. Guest hams from Concord, Nashua and Milford were present. Refreshments followed and a good time was had by all. IP expects to be on 112 Mc. soon. N.H.N. is off until fall. Net schedules will begin about the middle of September. If you fellows prefer a longer report in QST, why not send in a few news items, regularly?

Traffic: W1FFF 260 (WLG 17) JDP 96 JGI 92 CMR 71 TA 63 GEY 55 MLO 47 KKK 41 IDY 28 BFT 25 IP 23 JBM 22 HGV-ANS 21 GVJ 20 FX 19 JKH 16 JDV 13 KMH 11 EAL-MKD 8 LMC-MMG 7 CEA 6 HXJ 4.

**RHODE ISLAND**—SCM, Clayton C. Gordon, W1HRC — The new club that was formed in Providence has selected the name — "Narragansett Association of Amateur Radio Operators." Membership at present consists of MJL, KYK, KOG, KCS, LWA, and a couple of unlicensed fellows. MJL is studying for commercial telegraph ticket at school, and has promise of a job. KYK has new receiving antenna at new QTH. LWA got nearly 2,000,000 points in O.R.S. party, working five new states with new Hertz antenna on 3.5 Mc. He is captain of the N.A.A.R.O. Bowling Team which bowled AQ and lost, as was predicted. MCN is keeping two daily schedules for traffic. IZO is active on 112 Mc. 'phone and N.C.R. Your S.C.M. has been out of town



for over 5 weeks, and has been using the portable emergency transmitter and receiver described in the 1940 *Handbook*. Although there has been some difficulty at times getting through solid, I have been able with about 15 watts and a piece of No. 14 rubber-covered wire about 50 feet long, to make contact on the A.A.R.S. drills at least once a week from Pittsfield, Mass., all daylight on 3.5 Mc. and one night worked solid in the drill with W1INU, using only a spiral spring antenna stretched out less than 10 feet long in the hotel room itself, no ground connection. For distances of 40 to 50 miles with reasonably decent antenna and ordinary lack of QRM which would prevail under emergency conditions, I believe this rig is absolutely dependable and reliable. Cost me: Receiver—approx. \$15.00; Transmitter—approx. \$10.00; Power Supply with Vibrator—approx. \$12.00. Have visited JAH, BVR, BKG and JLT while up in this neck of the woods, as well as attending two nice meetings of the Pittsfield Radio Club and a Hobby Show at the Y.M.C.A. which had the Amateurs as a feature. LWA deserves special credit for doing such reporting in extra fine shape, and Old Reliable GTN for the traffic totals. Tnx, pals.

Traffic: W1INU 387 GTN 205 CPV 143 KYK 127 LDL 99 LWA 95 INT 79 LAB 71 LEG 63 KOG 61 KKE 30 KWA 34 LQG 26 KIV 42 AOP 18 KZN 15 BOY 8 HRC 4 IZO 37.

VERMONT—SCM, Clifton G. Parker, W1KJG—The April QSO party was well attended throughout the Section and many old friendships renewed. KTB went to town, hopping all over all bands for highest score in every band and highest total score of 35,100 points. FB! Runners up were MJU, KJG, FSV, KOO. The bulk of contacts were on 3.5-Mc. c.w. with nearly all stations operating on that band only. Stations submitting logs with scores above 10,000 were: MJU, 30,000; KJG, 22,500; FSV, 21,000; KOO, 20,800; LWC, 16,900; KWB, 16,800. With three parties during the past season, the Section should have a good start on another contest early in the fall. A.E.C. registrations since last month: MLJ, MKM, MMU. New O.R.S.: MLJ and KWB, which aid materially in filling in some "hard-to-deliver" spots for which this Section is famous. LWC has gone to Ford School in Michigan. BLC is active on 3.5 Mc. KEP (Mrs. DQK) and LJZ joined the Y.L.R.L., making Vermont 100% on eligible membership in this activity. MKM perfected a stormproof 1.75-Mc. half-wave using No. 6 H. D. copper, etc.! LRL is back on at Fort Ethan Allen after a winter's sojourn in New Mexico. KXY is expected to return to old QTH from Georgia about June 10th. QQ is active on 7 Mc. John and his XYL visited at DQK and BJP. KTB visited DQK, JZF, LJZ, and reports CUN now on 1.75-Mc. 'phone. KJR spent some time with JVS and GAE while MLJ and AOA dropped in on MJU. AOA is back on after long intermission; he is usually on 3696 kc. MMU is now on Vermont Traffic Net. DQK completed a top-loaded vertical for 1.75-Mc. 'phone work. KVB is leaving for New London with portable rig to keep in contact with gang; he will be at WNLC there. KOO is on the road for the summer and is giving his A.E.C. rig a real shakedown cruise while reporting in on the various drills. LBJ moved across the river to Northumberland where he is now operating under the N. H. gang. MJU is control station of Vermont Traffic Net, meeting daily except Sunday at 8 p.m. on 3860 kc. This net will continue during summer on above schedule until otherwise specified by the control. Appointments for this Section now in force, as of May 15th, are: O.B.S.: FPS, KTB, O.O.: AVP, BJP. O.P.S.: AD, AVP, DQK, GAN, MCQ. O.R.S.: BNS, FSV, KOO, KTB, KVB, KWB, MJU, MLJ. R.M.: BNS (Eastern Vt.), FSV (Western Vt.).

Traffic: W1FSV 176 KJG 103 MJU 78 KTB 49.

CONNECTICUT—SCM, Frederick Ellis, Jr., W1CTI—KKS takes top traffic honors this month, B.P.L. and high station in the Section. Congratulations, Bill. BCG moved into his new home, May 30th, and will install his station in the special radio room. UE and JMY attended New England and Hudson Division Conventions and visited 2USA. GB is all set to go to town on Field Day. LOC will operate portable from Norfolk, Va., this summer, and expects seven other amateur operators from his destroyer, U.S.S. *Semmes*, to give LOC/3 a good work-out. Rumor has it that KYQ can now work "Bk-in." FB! TD worked 7CRE, 6RLQ and 6KLV on 3.5 Mc. IKE is on the way to Puerto Rico. 2MQB/1 will operate at LOC/3 along with MJY/1. CJD says the Middlesex Radio Club recently held a meeting, the first in two years! EH contacted F.C.C., the

State Dept. and F.B.I. on a recent Washington trip. SMYW/1 has an NC 1-10 and will be glad to listen for 224-Mc. stations. We are all glad to hear that ES is recovering and is back at the office, even if only for part of the day. BGJ asks why there isn't more 1.75-Mc. c.w. activity. LIG is out of St. Vincent's Hospital. MHT is now on 1.75-Mc. 'phone. MQM is newest member of B.A.R.A. The following are on, or about to go on 112 Mc.: MQM, MGC, KZC, LIS, LIG, MHH, MGS. New officers for B.A.R.A.: pres., ACV; vice-pres., LIS; secy., MHH; treas., KAB; act. mgr., APA. Plans for Field Day are under way, and B.A.R.A. is going out after top place. On Sunday, May 19th, the Manchester Radio Club held a pre-field day outing in a field in back of LMK's home; 3.5- and 7-Mc. antennae were put up on portable 40-foot masts. Within two hours the station was on the air and made the first contact, using all emergency power. On May 23rd C.B.A. held a dinner at the General Putnam Inn, Norwalk, celebrating over 10 years of organization. BCG, president of C.B.A., was master of ceremonies and introduced the following speakers: ACV, EER, JYQ, QV, LOC, BHV, CTI and Captain Reuben King, Commandant of Combat Train, Norwalk National Guard Unit. BHV gave an outstanding demonstration of magic, entertaining the gang for over an hour. C.B.A. expects to be located at the rifle range of the Norwalk Rod and Gun Club in Easton for Field Day. The Nutmeg Net closed May 31st after the most successful season in its history. The net will reopen Sept. 2nd. In the meantime, use 3640 kc. and "CN" for Conn. contacts.

Traffic: W1KKS 677 AW 587 (WLMK 2) JXP 168 CTI 116 UE 106 KFN 74 MJY/1 73 LOC 53 VB 47 KYQ 46 TD-1KE 43 CJD 35 BDI 24 GB 12 LQK-LVQ 9 ES 7 CSY 1 W2MQB/1 40 W8MYW/1 20 W1AMQ (WLG 21).

#### HUDDON DIVISION

EASTERN NEW YORK—SCM, Robert E. Haight, W2LU—KWG is doing swell job at West Point. MIY helped boys at Albany Radio Club during Albany-N.Y.C. motor boat races. LU can be heard on 3530 kc. MHW is new member of A1-Opr. Club; he's doing FB work on T.L. "G." Don't let this summer weather get you, fellows. Report to your S.C.M. LLU is still on c.w. from Feura Bush. ACB is operating 3.9-Mc. 'phone and lining up Field Day program for S.A.R.A. AMM is heard on 28,590 kc., schedules ICLL Sundays. HNE/2, in Kingston, is using rebuilt rig: 41 e.c.o., 6L6 doubler, 6L6 final, 50 watts on 7 and 3.5 Mc. ALP, on 14,200 kc., schedules 6SDD at San Francisco (formerly 2AUT). DEL is back on 3.5 Mc. Welcome, Horton. SZ is reinstated as O.R.S. No. 16.

Traffic: W2KWG 172 MIY 56 LU 38 MHW 36.

NORTHERN NEW JERSEY—SCM, Joseph P. Jessup, W2GVZ—Ass't S.C.M. in Charge of Emergency Coordination, Les Baglee, W2JMX. R.M.'s: 2BZJ, 2CGG, 2GVZ. P.A.M.: 2HNP. Section Net frequency: 3630 kc. New appointments: O.R.S.—MAX; O.P.S.—DBY; O.B.S.—KXT. New A.E.C. registrations: BCC, BLV, BNU, DBY, EQS, EXY, FPM, HLS, IAY, IBE, IYG, KIL, LAU, LIS, MDV, MDZ, MIG, MND, MOR. We now have approximately 175 A.E.C. registrations, including 15 F.C.'s. There are roughly 1600 hams and 125 large cities and towns in the Section, so we have hardly scratched the surface as yet. Our aim is to obtain 100% registration and to have an E.C. in every city and town. Please do your share and get in touch with JMX. The Tri-County, Inc., gang is building a lot of emergency gear for F.D. The J.S.A.R.A. is also getting all set for F.D. HXI has worked 60 countries using three zepps and separate feeders. BLV is recuperating from two operations and joined the A.E.C. Harry is an active, all-around ham in spite of severe physical handicaps, and he deserves a lot of credit. LOP and GQM rendered valuable assistance to JMX in the demonstration at Summit mentioned last month, and IZP also worked hard to have his rig ready in time for the show. FPM and KXT are applying for O.P.S. IYQ uses an 807 final. MKW operated GYO at Open House at Technical High School in Bayonne and originated a flock of traffic. KIQ is fixing his rig for "bk-in" and is building a portable job. CZM is working 14-Mc. 'phone. HLC will soon be a W3 at Troy Hills. LYV is molding the junk heap into a 1.75-Mc. job. HXI finished a new e.c.o., and it works FB. Looks like KHA was high man for N.N.J. April O.R.S. Party, with about 9 million points. FB. MAX expects to go portable during the summer. LXI has new final with a pair of 812's; Wally is also building an emergency rig. We need lots of them! BZJ is busy working on portable

(Continued on page 88)

# ABBOTT DK2

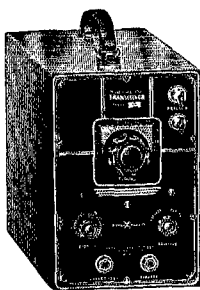

## 2 1/2 Meter Transceiver

Ideal for spring and summer portable operation—simple and convenient

**List Price \$27.50**

LESS TUBES AND BATTERIES  
40% Discount to Amateurs

**GENERAL:** The DK2 is a completely self-contained 112 mc. radio-telephone transmitter and receiver, for use in your car, plane, boat, or while being carried, for portable work. It is very simple to operate. The working

range is between 2 to 30 miles depending on the location. Astonishing results have been obtained.

### SPECIFICATIONS

**CASE:** Size 11 1/2" long x 9 1/2" high x 6 1/2" wide, grey wrinkle finish metal, heavy leather handle. All batteries are self-contained in case. Removable side panel for easy access to the batteries and tubes.

**FREQUENCY:** Will cover 112 mc. to 118 mc. (amateur 2.5 meter band).

**BATTERY REQUIREMENTS:** Three 45 volt B batteries like Burgess 5308; and four No. 6 dry cells, or two Burgess 2F2H batteries.

**TUBES USED:** One type 6J5GT, one type 6G6G.

**SHIPPING WEIGHT:** 12 pounds.

## ANNOUNCING ● ● the new—MRT-3

### 2 1/2 METER HI-POWER MOBILE TRANSCEIVER 20 WATTS—INPUT

The unit you need for your car operates from car battery and vibrator power supply.

Real transmitting tube Hytron HY-75 used in the R.F.

**EXTREMELY COMPACT**

Size 9" long — 8" high — 4" deep. Self contained PM dynamic speaker.

**PRICE \$47.00 List**

Less 40% to Amateurs

SEE IT AT YOUR FAVORITE DEALER

Write for bulletin

## ABBOTT INSTRUMENT, INC.

51 Vesey Street

New York City

## TAKE THE NEW RADIO EXAMS IN YOUR STRIDE

Newly-written, low-cost, home-study courses, under supervision of Arthur R. Nilson, twenty years co-author of technical radio books. Thousands of professional radiomen use Nilson and Hornung textbooks to keep up to date. Now Arthur R. Nilson will give you direct, detailed lessons, step by step.

SEND FOR FREE 16-PAGE BOOKLET "What the Modern Radioman Must Know." Make this step toward your successful radio career... now!

**NILSON RADIO SCHOOL**

51 East 42nd St., New York, N. Y.



**POLICE  
AIRCRAFT  
FORESTRY  
BROADCAST**



## ★ BOOK REVIEW ★

*Radio at Ultra-High Frequencies*, published by RCA Review, 75 Varick Street, New York City. 456 pages; gratis to subscribers to *RCA Review*.

This volume is a collection of technical papers, by engineers of the RCA Laboratories, dealing with various aspects of work above 30 megacycles. Many have previously been published in engineering journals, including *RCA Review*, but a number make their first appearance in the present volume. An extremely useful purpose is served in bringing together important material, from an organization which has done considerable research work in this field, on the subject of ultra-high frequencies. The book is divided into five parts; transmitting methods and equipment, propagation and relaying, measurement, reception, and ultra-high frequencies above 300 megacycles. Papers on television, phase and frequency modulation, frequency control, u.h.f. antennas, and many related subjects are included. Amateurs interested in u.h.f. work will find plenty of worth-while reading.

*Radio at Ultra-High Frequencies* is not sold directly, but is given free with the third year of a subscription to *RCA Review*. It is a companion volume to previously-published *Television* and *Radio Facsimile*, which are similar groupings of RCA papers on the subjects indicated.

— G. G.

### Portable Kinks

(Continued from page 21)

denser, vintage of about 1927, still obtainable in most junk shops for from 50 cents to \$1.00. Each end two of its 360- $\mu$ fd. sections are paralleled, the whole making a split-stator condenser with 720  $\mu$ fd. per section, or a net of perhaps 360  $\mu$ fd. but having a grounded center very necessary to our purpose. The coil  $L_1$  is tapped and the taps connected to a Centralab switch. I will not give the number of turns in the taps because they must be determined by experiment according to the feed system in use. In any event, use about 1 to 2  $\mu$ fd. per meter in the tuning condenser because there are no other tuned circuits between the final plate and the antenna. You will gain in harmonic suppression and ease of driving the final. W1ANC has never had a pink ticket or an OO card in ten years of operation.

Now as to some of the simplified output circuits used in the portables. All of them follow the general scheme of Fig. 7. A coil is used which can be tapped at every turn by a number of connectors going to the plate, the cathode (or filament), two for load, one for ground, and an extra for shorting out end turns for 40-meter operation. If you want 20-meter operation better wind up an extra coil of 6 or 8 turns self-supported and clip on that. It will work, but don't expect 95% plate efficiency. At W1ANC,  $L_1$  is 40 turns spaced over 5 inches, 2 1/2 inches in diameter. Many other dimensions are o.k.

Our favorite antenna is a center-fed wire about 130 feet long, with several bends in it to keep it all on the property. It runs in a general North and South direction but is not particularly directional, we hope. Figs. 7A to 7E show rough antenna dimensions and corresponding output feed connections to put energy into almost anything which will conduct electricity.



# The CENTRALAB Family

## of VOLUME CONTROLS

### STANDARD

Centralab's non-rubbing contact and long wall type resistor. Available plain, or with one, two, or three taps, and with Underwriters Approved switches.

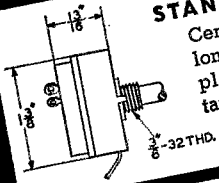

### MIDGET

Small in size, large control efficiency. Small in size, large control efficiency, long straight path of wall type resistor. Available single, dual, or triple, plain, or tapped, with SPST, SPDT, DPST, and a special dial lite push switch for battery sets.

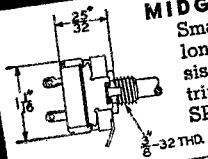

### WIRE WOUND RADIOHM

Identical in size with Standard Radiohm. Range from 2 ohms to 10,000 ohms, Rating 3 watts. Furnished plain or with SPST, SPDT, or DPST switches.

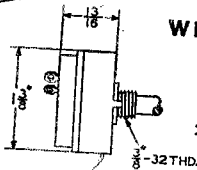

### SUB-MIDGET

The smallest diameter reliable control. Wall type resistor gives low noise, rapid transfer of heat to metal shell. Rating of 1 1/2 watts. No switch or taps.

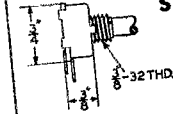

All controls furnished with any desired maximum resistance and with appropriate tapers. Control and resistor problems melt away when you put Old Man Centralab on the job.

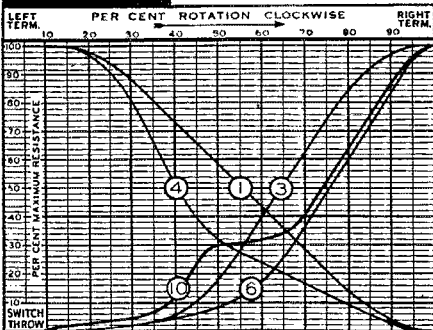

The resistor curve of a volume control is more important than its overall resistance . . . that is why all Centralab controls are furnished with the variety of curves shown here. Curve six is most widely used for high resistance radio grid and diode controls. Curve 1, or 4, are best for C bias, and Curve 3 for antenna C bias. Curve 10 is used on tapped controls.

### TWIN AND TRIPLE CONTROLS

Two or three sections assembled in tandem. Each section fully shielded with all contacts attached to a single shaft. Twin controls available with concentric shafts. Supplied with or without snap switches.

# Centralab

CENTRALAB • 900 E. KEEFE AVE • MILWAUKEE, WISCONSIN  
A Division of GLOBE-UNION INC. Cable Address: Centralab Milwaukee

(Continued from page 85)

equipment for F.D. Walt is a busy guy as R.M., O.R.S., E.C., as well as being on the job as T.L. "A," A.A.R.S., and N.C.R. JUC turned in a nice traffic total for two weeks' work. ARB says that the damage to his beam reported in this column two months ago never happened. Sorry, I was misinformed, and glad that the beam is OK. Ramsey Radio Club meets once per month and expects to grow. The officers are MOO, pres.; FXZ, vice-pres.; and MSR, sec. and treas. FPM and DBY expect to be in F.D. with a 110 volt generator. The problem is to make it portable without using a half-ton truck. (GVZ has the same problem.) Officers of Livingston Radio Club are LZW Pres. and JQE Sec.-Treas. CBL is celebrating the arrival of first Jr op. ALO got hitched. AVO has tower and beam back up at new QTH. KM has new tower, but only a flag on it so far by courtesy of CCJ. GVZ operated with a 110 volt generator and a 20 watt rig in recent A.A.R.S. emergency power contest. The Hudson Division Convention, which was sponsored by U.C.A.R.A., brought quite a gang down from headquarters, including, Woodruff, Bailey, Handy, Budlong, Goodman, Batey, Moskey and others. Speakers at the afternoon organization meeting were 1BDI, 2GVZ, 5JMX and 2DBQ. As announced at the convention, there is an R.M. job open for a qualified O.R.S. who can organize and run a 7-Mc. Section Net. Hard luck broke up our two previous attempts, but we would like to try again to set up a 7-Mc. Net. All O.P.S. and O.R.S. are requested to let the S.C.M. know whether or not they favor retaining the two months' period of probation now applied to new applicants for O.P.S. and O.R.S. The gang who attended the convention had a good time, and thanks are due to the Convention Committee of U.C.A.R.A. for the hard work performed in planning and running the show. The N.N.J. Net closed down for the summer at the end of May and will resume operations after Labor Day.

Traffic: W2GVZ 281 (WLNI 4) CGG 218 LMN 189 (WLNX 45) JUC 106 HCO 71 BZJ 69 KMI 54 MKW-LDB 52 IYQ 50 LXI 49 DYO 38 MAX 23 KHA 21 MNT 13 HXI 12 CJX 10 CIZ 8 JDC 4 IZV 3 MEO 2. (Mar.-Apr.: W2MEO 22 DBY 1.)

**NEW YORK CITY AND LONG ISLAND** — SCM, E. L. Baunach, W2AZV — JAU is out for O.R.S. LYH sends his first report and is trying for O.R.S. MQN is a new station at 47 N. Jerusalem Rd., Hempstead. NAJ is a newcomer at 232 E. 201 St., Bronx. LYH is a new station in Lindenhurst. ELK regrets to state that the elevation to Benedicthood has been cancelled. AEU manages to be on for a few minutes a day. HMJ got his second-class telegraph ticket. KMS and KMT joined the regular Army. KYV enjoyed his first O.R.S. party. Both LZR and EYS did well in the O.R.S. party. AXZ's time was limited to one hour on the party. LGK spent plenty of time on his t.r.f. set for Field Day. GPY is back on 7 Mc. with a new doublet antenna. FAQ installed a new Zepp feeder system with FB results. Ex-LED is now SSSH and is one of the Benedicts. IXQ has become heir to a number of Loktal tubes, so now he is working on a 28-112-Mc. converter. PF will be active with the regular Army during the First Army Maneuvers in N. Y. this August. CHK is back on 3710 kc. LYG handled mostly N.C.R. traffic during the month. JBL is back on the air for his summer vacation. CKQ, LPJ and PL are ops at 2USA. Election results at HJ the City College Radio Club: pres., LBI; vice-pres. and chief op., MXJ; treas., KSF. The station will be on 'phone in October or earlier. EC reports that the A.-P. Trunk Line closed for the season May 31st. LID reports that the Nit-Wit Network on 1805 kc. is going tired; newcomers are AA and DLR; all stations are invited to join and have a rag-chew. The Section Net on 3710 kc. will meet at 9 p.m. E.S.T. for the summer months for rag-chews and traffic. MCG is teaching radio operating at the New York Vocational High School, 21 W. 138 St. The course is free, and MCG would be glad to help anyone with the exam.

Traffic: W2LZR 977 PL 524 SC 796 MT 236 DBQ 135 KI 109 LR 103 BGO 89 AZV 81 AXZ 68 ITX 1334 (WLNW 416) LGK 60 PF 49 KXB 26 MLE 25 IYX 23 EC-KYV 21 WD 19 HMJ 14 FAQ-CIT 13 CET 12 BYL 11 LYG-BDN 10 IRC-CHK 9 LID-BMG-EXR 8 LBI-JAU-AZM 7 AW-AA 5 HAE-DLR 4 DOG-HNJ-AEU 3 IWE-BMG 2 HGO-JGC-EVA 1 LPJ 100 LYH 4 WLNW 58.

#### ATLANTIC DIVISION

**EASTERN PENNSYLVANIA** — SCM, Jerry Mathis, W3BES — 3ADE is in the rebuilding mood again. 3AGV snagged three new countries in one morning, KA,

KE, KF, 3AOC gave 1.8-Mc. cathode modulation a whirl, but is back on 3.5 for the summer. R.M. 3AQN thanks the traffic gang for cooperation in maintaining 5- to 8-hour traffic service to K6. K5, etc. 3BES moved to another QTH: 6042 Master St., Phila. 3BLL is revamping his portable equipment and vows that the Chester boys will "go over the top" in Field Day. 3BRZ worked KC4USA on 14-Mc. 'phone. 3DGM made over 20MM points in the O.R.S. party, which should make him a dangerous competitor in Field Day. 3BXE has his 807 e.c.o. Field Day rig "eating out of his hand." 3EEW and 3ENX are constructing the electronic key as per 21LE's QST article. 3EEW is placing message blanks in a local barber shop to bolster summer traffic. 3FPC, staunch long-wave ham, won a 14-Mc. vertical radiator at the Newark Convention. 3GHD reports contacting KEGSRA and CR6AF. 3GHH and 3GET are getting organized for Field Day. 3GKO finally made good his threat to lead the Section in traffic. 3GKR has a lot of confidence in his 65-foot mast. 3GIW has plenty of sock on 1.75-Mc. e.w. lately; next comes the audio. 3GYK is QRL Field Day preparations. 3HFE also reports plenty of Field Day activity. 3HXA and 3HQE had their one-lung F.D. rig out for an airing, and claim to be "all set." 3HRD received W.A.S. certificate. 3HRS informs us that the Philippine Net is still taking traffic for the west coast, K7, K6 and KA. 3HZK will join the E. Pa. Net when his net crystal arrives. 3HZV is glad he entered his "peanut whistle" in the O.R.S. party. On May 15th, some of the local F.T.S. boys had a meeting; among those present were 3GYJ, HFE, EEW, GKO, HZV, HRD and others. 3QP wants the boys to look for him on Field Day for one extra QSO. 8ASW is training radio operators for the P.N.G. 8EU enjoyed the C.B.S. broadcast of the Susquehanna Emergency Net drill. New QTH of 8FLA is 127 N. Catherine St., Shemandoah. 8QGG urges more O.P.S. activity on 'phone bands other than 3.9 Mc. 8QLV operated at the first Hobby Show in Honesdale where messages were accepted and sent. 3QV states that the York Road Radio Club is getting loaded for bear in the coming Field Day. The Beacon Radio Amateurs won't tell where their Field Day is to be held???? The Phila. Wireless Assn. and the Yeaddon Club are likewise reported to be on the march. Frankford confidently feels it is "in the bag." We are still looking for an Emergency Coördinator for Harrisburg area.

Traffic: W3ADE 45 3AGV 2 3AKB 140 (WLQP 23) 3AOC 14 (WLQ 7) 3AQN 82 3BES-BIL 5 3BXE 41 3DGM 8 3DRO 9 3EEW 264 3EML 1178 3FPC 2 3FXZ 4 3GET 2 3GHD 11 3GHH 4 3GKO 1363 3GKR 3 3GYK 20 3HCT 6 3HFE 10 3HRD 11 3HRS 253 3HZK 29 3HZV 66 3IAY-3ILK 4 3INH 22 3QP 608 8ASW 290 8EU 14 8GV 2 8HKS 9 8QLW 21 8SNZ 14 WLQA 74.

**SOUTHERN NEW JERSEY** — SCM, Lester H. Allen, W3CCO — Ass'n SCM and A.A.R.S. Liaison R.M., Ed. G. Raser, W3ZI — N.C.R. Liaison R.M., Ed. B. Kerr, W3CCC — Regional Coördinator in charge of Emergency Coördination, Ted Toretti, W3BAQ — R.M.'s: 3BEI, 3BYR, 3EUH — P.A.M., 3GNUM. Section Net frequencies: O.R.S., 3700 kc.; O.P.S., 1980 kc. For those in the Southern New Jersey Section who plan to do a little visiting during the vacation, a bit of scouting for appointees such as Emergency Coördinators, O.R.S., O.P.S., Official Observers, etc., should prove interesting and very helpful to the Section. Any recommendations will be most welcome. HTJ worked K6QQE on 1.75-Mc. 'phone and was running 300 watts input. CFS has new  $\frac{1}{2}$ -kw. rig on 3.9 Mc. and needs only Arizona and Idaho for W.A.S. GEV held successful schedules with HC2CC, who hails from Crosswicks, during the past two months. ASQ is conducting a code class every Monday night. ATF is experimenting with facsimile. IOK has TZ20 in new final. BWF is busy gathering up States for a 'phone W.A.S. HW has his vertical radiator working top-notch on 1.75-Mc. 'phone. GNM completed his new Class B modulator. AFH received S.W.L. letter from England; Bill operates on 1.75-Mc. 'phone. GNU, our P.A.M., also was heard in England while operating 1.75-Mc. 'phone. ISY and ISZ are Trenton's latest additions. AQ has a new 6L6, 807, T-55 exciter unit for the 1-kw. rig. AYC, BXA and HHZ staged a demonstration for the Bordentown Hobby Show. IRT is new call in Hainesport on 1.75-Mc. 'phone. GRV is experimenting with a new trick circuit for oscillator use. EED is building a  $\frac{1}{2}$ -kw. rig using a pair of 100TH's. EFE has been assigned a new call, W6SPR; Paul wishes to contact the boys in our Section; he is operating 7-Mc. e.c.o. EFF has a dandy new signal on 3.9-Mc. 'phone. HKO finished winding a generator for 110 volts and works FB on his portable-emergency rig.

IAZ reports his portable rig in good order and available for any emergency. ZI thanks all members of the O.R.S. Net for the excellent cooperation during the past operating season in making our Net one of the most outstanding in these parts, and specially commends the unflinching work of our two R.M.'s for their untiring efforts. The Section O.R.S. Net closed May 30th and will reopen Sept. 3rd. GNU thanks the members of the O.P.S. Net for their endeavors in establishing a 'Phone Net for the Section and particularly commends the outstanding work of the 'Phone R.M., EUE, who carried the Net Control duties like a veteran. The O.P.S. Net closed for the summer on June 3rd, and will resume operations Sept. 9th. FXN schedules BWT in Washington, D. C., several times per week. GMY is joining the A.A.R.S. IHD is on the air in full swing after a month's sick leave. Glad to hear you're feeling better, Carl. CCC threatens to bury the ole peanut roaster and steam up the 200-watter. EHB is at Fort Monmouth attending the Signal School. QL is now located at Cheltenham, Md., one of the control points for NAA. ZI was in "drydock" for a few weeks recovering from an operation. GLG schedules his brother ICMO weekly on 3.9-Mc. 'phone; Willis has 500 watts to the final. EGE is going into higher power. IOW packs a nice wallop on 1.75-Mc. 'phone. CFR bought new receiver. IMY is new Official 'Phone. FMR still maintains daily schedules with 9CAC on 14-Mc. 'phone after a period of two years. TG9BA was recent guest at US's, HKY and FFE (TG9BA QSO'ed his YF from US). IPT and INS are operating 112 Mc. The CRC clubs have several emergency rigs built up perking FB. HEO reports DX very good on 3.9 Mc. DNU has new QTH directly across the street. LDZ is working on new e.c.o. using a 7A7 on BC band. ABS has given up 1.75 Mc. for the summer and is exploring the ultra-highs. GCU would appreciate the comments on his Official Broadcasts. How about it, gang? Let Ray know if you are copying him. IHO will be active around Sept. and wishes to be remembered to the S.J. boys. IP reports for the first time and mentions he has an all-band rig using a 100TH in the final at 380 watts input, and wishes to renew acquaintances in S.J. Section. FIS is interested in making schedules on 112 Mc. with anyone in the vicinity of Trenton. The Delaware Valley Radio Ass'n wishes to advise its many friends the 4th Annual Outing and Hamfest will be held August 11th (Sunday), at the Trenton State Fair Grounds. The affair promises a good time to all who attend. All inquiries should be sent in care of Bill Hannah, W3EUE, General Chairman for this year's Outing and Hamfest. Until next month, a pleasant vacation and 73.

Traffic: W3BYR 240 (WLNJ 50) BZX 192 EFM 110 (WLNJ 66) ZI 100 FXN 66 DNU 55 CCC 48 GCU 43 GRW 41 IHD 39 ATF 32 IDZ 31 VE 25 IFT-BWF 21 IHO 20 IOK 19 FMR 20 AEJ 14 ABS 4.

WESTERN NEW YORK — SCM, Fred Chichester, W8PLA — R.M.'s: BJO, CSE, DSS, FCG. P.A.M.'s: CGU, RVM, E.C.'s: FNT, GWY, RVM, SBV, SMH. Net frequency: 3720 kc. BJO, who has been one of the most active traffic men in the Section, is putting in his spare time getting a cabin cruiser ready for the summer. PCN has been doing a nice job acting as N.C.S. since Kerie quit, and turns in the largest traffic report of the Section for the month. John Long, W8ABX, one of the best known amateurs of the Section and chief technician at WHAM, was killed instantly in an automobile accident May 9th. The three broadcast stations in Rochester observed a minute of silence during the funeral. NCM, secretary of the Rochester Amateur Radio Ass'n, had his car destroyed by fire. All the R.A.R.A.'s secretarial records went up in smoke with it. TYS had a transmitter on exhibit at the Rochester Scout-o-Rama. A baby girl arrived at MC's, April 28th. MNW will be married June 15th. The R.A.R.A. is sponsoring a code instruction class which has 15 members, including one YL. JAD connected a spark coil to his wire fence to keep the neighborhood kids off his new lawn, but the cops made him disconnect it after the neighbor's dog got the surprise of his life. NBI will be married July 6th or sooner. The YL's of Rochester have shown great interest in ham radio and the club is encouraging them to form an auxiliary. New hams in the Section: USF, Rochester; URK, Waddington; and UGH, UHI, UJW of Buffalo. NWH has completed a positive peak modulation indicator at a total cost of 17 cents, using three fixed resistors and a neon bulb. QZP finished an e.c. frequency shifter for use on 14 and 7 Mc. The Western New York

Radio Council has been reorganized with GFP as chairman and IIO secretary. A better understanding exists between the clubs, and the Council is going along in fine shape. The Buffalo Mike and Key Club is in full swing in the new meeting place. They will hold a picnic on July 23rd at Emery Park. A good time and a good turn-out are expected. Lloyd Childs, famed Army and Navy plane-testing pilot from the Curtiss plant, spoke at the last meeting on "Testing New Planes for Army and Navy Use." The club will hold no meeting during June and July. The Kenmore-Buffalo-Tonawanda Radio Club attended a Radio Council joint meeting, and several difficulties were ironed out. NWH announces a kw. 110-volt a.c. generator ready for Field Day. The four transmitters that will be used on all bands have been tried out in different QTH's to determine best location for full set-up. It is expected that Grand Island (N. Y.) will be the place selected. Balloon and kite antennas will be used, and the Field Day activities will have the full support of the entire club membership. The 112-Mc. contest, sponsored by the club, closed June first, and prizes will be awarded those attaining the highest number of contacts on this band. Last meeting of the club will be held on May 24th. It is expected that the club will have a transmitter next season. JIW manages to hook such stations as K4KD and HH2MC with his 15 watts on 14 Mc. Howy has just received his A-1 Op's certificate. NEL, disgusted with 'phone, is planning a c.w. rig. DHB moved to a camp on the St. Lawrence River for the summer. URH, a new ham at Waddington, will be on all bands but will work into the new St. Lawrence Valley Net regularly. MLM expects to be on 1.75-Mc. 'phone soon with 170 watts. TEP and FFN visited NNI. CKC/4 is running a fishing boat at Clearwater, Fla. CUY keeps schedule with CMW/9, formerly of Alexander. DSS expected to have his new 90-foot mast up by June first. The St. Lawrence Valley Net has finally gotten under way with Ken Aitken, W8RVM, as P.A.M.; 21 stations have been signed up so far, and five of these have been appointed O.P.S. They are: RVM, LMF, BCU, LLN, UNY. A spot frequency of 1880 kc. will be used. Traffic in the net will be cleared through the present W.N.Y. Net. A number of the stations are also members of the Emergency Corps. Much credit is due RVM for the formation of this net.

Traffic: W8AQE 18 BJO 245 CSE 38 DOD 44 DSS 37 FCG 239 JIW 6 JTT 25 LJD 66 MCT 54 PCN 287 PLA 130 QQB 68 RKM 195 RVM 4 RZX 24 SBV 141 SMI 12 SZK 39 UPJ 25.

MARYLAND-DELAWARE-DISTRICT OF COLUMBIA — SCM, Hermann E. Hobbs, W3CIZ — 3ZD Regional E.C.; W3BWT Chief R.M.; CXL and CDG R.M.'s. 3IRR keeps regular schedules with BAK. Jean Hudson will operate the Camp radio, 1K1NP, Spofford, New Hampshire. 3AXP will enter the Army Air Corps as flying cadet. Dot and Jean Hudson have joined the Y.L.R.L. BHE has an entirely new outfit. BKZ and GXU are fixed to work on 112 Mc. FSP says he soon will be with them. DOG is back on the air with 750 watts and a signal shifter worked 19 sections in 2 hrs. and 40 mins. with 32 contacts. DRD is looking for traffic sked and QSL for WAS. EQK was appointed Chairman Baltimore Amateur Radio Ass'n; he is building a portable emergency transmitter for all bands. ICT is key station for Baltimore and vicinity in F.T.S. IMN is back on. WU has a new crystal selector holder and switch for eight crystals.

Traffic: W3BKZ 318 BWT 667 CXL 286 (WLM 3698) CDG 8 CIZ 739 ECP 115 EZJ 41 EKZ 10 EQK 16 GYQ 43 HQU 360 ICT 35 IMN 23 WU 1. (Mar.-Apr. W3BKZ 245.)

#### DELTA DIVISION

LOUISIANA — SCM, W. J. Wilkinson, Jr., W5DWW — LERV is active on 28 and 7 Mc. FPZ moved to Lafayette. AXZ is back in Shreveport. EEL has YL op at his home. Congrats, OM. HQN visited HHV. WG is showing interest on 'phone bands. HBY has new portable. FXP and HIJ are trying to get on 28 Mc. IHH is building new rig. IBW is now stationed in Venezuela. GIZ is about ready to put kw. on air. DGB visited in New Orleans. DKR is now located in La Place. GND added Sky Buddy to his collection of receivers. IXL is operating on 28 Mc. CXQ recently visited R.C.A. factory in N. J. CJO is building new shack. EBB has been visiting. IHM has been transferred to New York, and DXK to Pennsylvania.

# PORTRAIT OF AN AMATEUR WHO NEEDS CANDLER TRAINING!



It's no disgrace to be licked by some "dit dah" speed artist. Real code speed is practically impossible to get alone, regardless of the hours upon hours spent in practice. It requires special training in fundamentals, proper mental co-ordination and expertly directed practice — all of which you get with Candler Training. You'll be amazed at the progress you can make in only a short time. Thousands upon thousands of amateurs and professional ops owe their smooth, rhythmic speed to Candler Training. Code Champions, like T. R. McElroy and L. R. McDonald, W3CW, attribute their amazing speed to the mental training that Candler gives. It's the real short-cut to the Code Speed — and it is not expensive.



## SEND FOR FREE 1940 BOOK OF FACTS

A 52-page book packed with vital information for beginners and advanced operators. It's FREE, send for your copy today!

**CANDLER SYSTEM CO.**  
DEPT Q-7 ASHEVILLE, NORTH CAROLINA

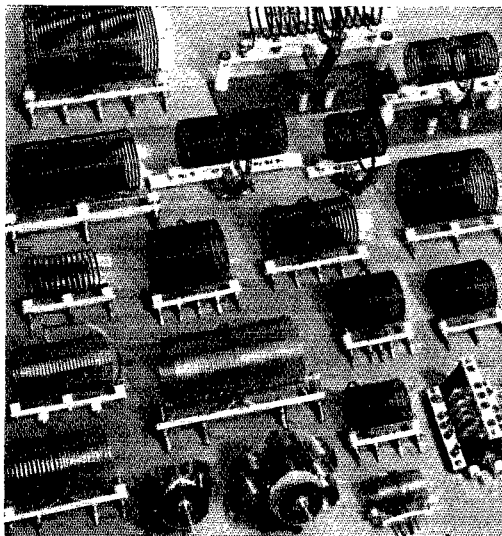

**ONE SURE WAY** to select the right coil — choose it from the complete B & W Air Inductor line. Sizes and types of these rugged, expertly-designed coils are available for every amateur inductance need, regardless of your power. See your jobber, or write, for your free copy of the B & W Air Inductor Catalog. See how easy it is to standardize on B & W's — and get guaranteed efficiency from every coil you buy!

**BARKER & WILLIAMSON**

Radio Manufacturing Engineers • ARDMORE, PENNSYLVANIA

## A Stabilized Variable Oscillator

(Continued from page 17)

6L6 either amplifying or doubling, providing variable condensers having the same plate shape are used and the ratio of fixed to variable capacity is the same in both circuits.

Although the rectifier alone, or the rectifier and voltage regulator could have been built as a separate unit, thereby avoiding some heating, it was decided that to eliminate extra units and cables an integral power supply would be installed. This uses a standard receiver power transformer and type 80 rectifier tube. The single-stage condenser-input filter was found to provide adequate filtering for the crystal oscillator, buffer, and output stages.

Additional filtering for the variable frequency oscillator is provided by the voltage regulator, using a 6F5 ( $VT_5$ ) for the amplifier and a 6C5 or 6J5 ( $VT_6$ ) for the series regulator. The circuit of the regulator is similar to that discussed by Grammer in August, 1937, *QST*, with minor changes. The 6C5 or 6J5 was used in place of the 2A3 originally specified, since the smaller tube can easily pass the low current required for the oscillator, and a separate filament winding is not required. With all heaters supplied from the same grounded 6.3-volt winding, the heater-cathode potential of  $VT_6$  is 150 volts, which seems to cause no difficulty.

Capacitor  $C_{17}$  is included since it reduces output ripple of the regulated supply by 6 to 8 db.

### Keying Circuit

Although this equipment was not designed for oscillator keying, tests were made to see just what it would do. In the course of these tests, a rather interesting keying circuit was developed for use with the voltage-regulated power supply, which is applicable to any oscillator using a similar supply. This circuit makes it possible to key plate voltage without breaking high current with the keying relay, and with complete control over both the "make" and "break" time constants. Unfortunately, triode oscillators still do not have the best keying characteristics, and it was found that when the time constants were so increased as to avoid clicks, some chirps were produced, particularly on the high-frequency bands. Although it has not been tried, it is entirely possible that the electron-coupled 6SK7 oscillator as discussed by Perrine in September, 1939, *QST*,<sup>2</sup> could be used in place of the 6J5 with somewhat more satisfactory keying. And while we are borrowing ideas from Perrine, the method he uses for feeding the oscillator tube heater looks good, too.

In any case, and particularly on the high-frequency bands, it is recommended that a later stage, rather than the oscillator, be keyed. Then the full advantages of the circuit isolation will be realized.

For those who may wish to try it, the operation of the rectifier keying circuit is as follows: The

<sup>2</sup> Perrine, "An Answer to the E.C.O. Problem," *QST*, September, 1939.



# AMATEUR RADIO

## A BEGINNER'S GUIDE

It is *the* textbook, written by J. Douglas Fortune, W9UVC, in collaboration with the Thordarson engineering staff, in answer to thousands of requests for a simplified book on becoming a radio amateur.

It takes you step-by-step — how to study code — how to get your license — radio theory made understandable — how to build your first transmitter and receiver — how to use those same parts in building larger equipment. 160 pages. Over 100 illustrations!

Competent authorities, who have previewed it, judged this book the best of its kind they have ever seen.

Any Parts Distributor can supply you with your copy. Publication is limited! Priced at 75¢ net, prepaid. This fine volume is cloth covered, stamped in gold.

*45th Anniversary*

**THORDARSON**

ELEC. MFG. CO., CHICAGO

“ TRANSFORMER SPECIALISTS SINCE 1895 ”

# 1/2 PRICE SALE

An event which proves our bargains are BARGAINS in every sense of the word — that Harrison offers price as well as quality! Several popular items  
**AT ONE-HALF THE FORMER REGULAR NET PRICES**  
 to save you money! ORDER NOW! Satisfaction guaranteed or your money refunded.

## UTAH 5—10—20

Just what you've been wanting! And now at a price anyone can afford. A compact 5, 10, and 20 meter phone and CW Transmitter of respectable power — 45 watts. Complete band switching — no plug-in coils (two separate final stages).

**RF Chassis:** 6CS Pierce 40 meter crystal oscillator, 6L6G doubler, 807 (HY61—EK39) finals. On 5 and 10 an additional 6L6G doubler is automatically switched in.

**AF Chassis:** 6J7, 6N7, 6N7, PP 6L6's. 35 watts audio. 5Z3 rectifier.

**RF Power Supply Chassis:** 5Z3, 866 1r's.

These three units mount into the neat, grey wrinkle finished cabinet measuring only 15" wide x 10" deep x 21" high.

This Utah Transmitter kit contains every necessary part, all of the highest quality (National, Aerovox, IRC, Utah, etc.). The chassis and cabinet have all holes drilled. Clear schematic and pictorial instructions — simple to wire and operate!

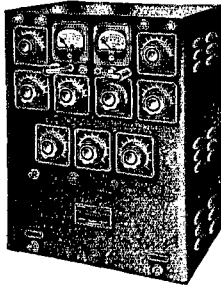

A HARRISON SPECIAL AT \$34.75

Complete kit, less only meters, tubes, and crystals.  
 Former Regular Amateur Net Price — \$69.75

## OIL FILLED CONDENSERS



Here's a compact, modern radio filter condenser in a cylindrical aluminum container, only 2 1/4" long by 2" in diameter. Impregnated and filled with recently developed condenser oil. Full 2 mfd. 1000 volt DC continuous duty rating (guaranteed for 10% higher). Universal mounting bracket for above or below chassis.

Because of the extremely low price, we cannot mention the name of the maker, one of the largest. But you'll recognize the high quality!

Former Regular Net Price — \$2.00

SPECIAL!  
 96c each — Six for \$4.98

## HAMMARLUND CONDENSERS

Brand new transmitting variable condensers at less than half price! For full description see Pg. 108 March QST.

Type	Cap.	Air Gap	Former List Price	SALE!
TC 30 A	30	.192"	\$5.00	\$1.39
TC 50 A	50	.192"	6.50	1.93
TC 150 B	155	.080"	6.50	1.93
TCD 250 C	240 per sec.	.038"	8.00	1.98

## 6L6G

Our own special tube that stands up PB under Ham abuse. We've sold thousands at 79¢ each.

SPECIAL!

Three for \$1.14

30 day free replacement.

## ELECTRIC WORLD TIME CLOCK

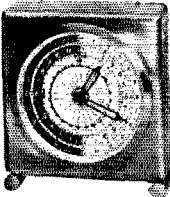

Its 24 hour face reads directly time in the 24 zones of the world — local AM and PM time — and GMT.

For 110 volt, 60 cycle. 5 1/4" x 4 1/4". Neat brushed brass finish.

Advertised and formerly sold regularly at \$5.95. Every modern station should have one!

For value — for service — for dependability — for that extra "something" which makes every transaction a real pleasure —

COME TO HARRISON!

Time Payments and Charge service

12 West Broadway · New York · WOrth 2-6276

# HARRISON

RADIO COMPANY

keying relay contacts (not the key — there are 300 volts there) are connected between  $R_{14}$  and the plate of  $VT_6$  by means of the jack  $S_1$ , and approximately —45 volts (not critical as to voltage or regulation, and need supply a maximum of 4 milliamperes) connected between the open end of  $R_{15}$  and ground. With these connections and the key closed the circuit is normal, with  $R_{14}$  connected between the plate and grid of  $VT_6$ . With the key open, —45 volts is connected to the grid of  $VT_6$  through  $R_{15}$  and  $R_{14}$ , biasing it to cut-off and removing voltage from the oscillator.

The necessary adjustments for the most satisfactory keying can be made by adding capacitors to ground from the plate of  $VT_6$  and the junction of  $R_{14}$  and  $R_{15}$ . The former capacitor, together with the 2-megohm resistor  $R_{14}$ , determines the time constant for the "make." The stray circuit capacity may be all that is required to prevent clicks. In any case, only a few micromicrofarads will be required. The "break" time constant is determined by the 100,000-ohm resistor  $R_{15}$  and the capacitor  $C_{21}$ ; 0.05  $\mu$ d. was found best in the original model, but may need to be varied in individual cases.

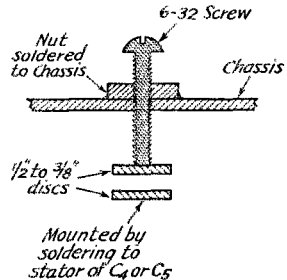

Fig. 3 — Capacity trimmer for calibration correction (See text)

With the circuit as shown, the variable oscillator only is keyed. If it is desired to key the crystal oscillator,  $VT_3$  should be operated from the regulated supply as well as  $VT_1$ . The switch  $S_3$  is used to remove voltage from the variable oscillator when the crystal oscillator is being used.

## General

The plate control switch  $S_2$  is of particular importance. In the first of its four positions, "Off," the negative of the rectifier and the positive lead to the 6L6 output tube are both open. In the "Auto" position, the circuit to the 6L6 is closed, and the negative of the rectifier is connected to an external lead, which should go through a normally-open contact of the transmitter plate control relay or switch to ground for automatic operation. The "Tune" position of  $S_2$  grounds the negative of the rectifier, placing plate voltage on the oscillator and buffer, but removes plate voltage from the 6L6. This is the position normally used for setting frequency on the low-frequency bands, since a signal of about the proper strength to produce a strong heterodyne in the receiver is generated. If a stronger

(Continued on next left-hand page)

# A NEW CHOKE FOR THE AMATEUR BANDS

The R-175 transmitting r.f. choke is suitable for parallel-feed as well as series-feed circuits in transmitters of up to 3000 volts modulated plate supply. Without plate modulation of the transmitter, they are suitable for 4000-volt amplifiers.

Use of pie-wound r.f. chokes in parallel-feed circuits resulted in decrease of transmitter r.f. output—often as much as 15%. The decrease with the R-175 is less than 1%.

In contrast to conventional r.f. chokes, the inductive reactance of the R-175 is high throughout the 28- and 14-mc. bands as well as the 1.7-, 3.5-, and 7-mc. bands.

The characteristics of this new National choke are:

## RATINGS

Voltage breakdown to metal base	12,500 volts
D.C. Resistance	6 ohms
D.C. Current Rating	800 ma.
Inductance	225 $\mu$ h.
Distributed Capacity	0.6 $\mu$ fd.

Price, Type R-175.....List \$2.75.....Amateur Net \$1.65

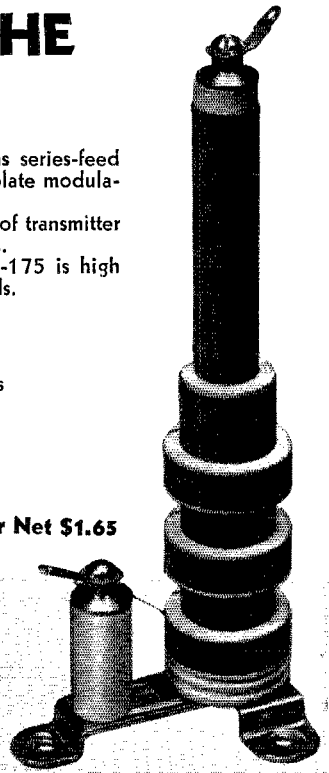

NATIONAL COMPANY, INC.,



MALDEN, MASS.

## AUTOMATIC SENDERS

Type S—Sends 4 to 60 W.P.M. 10 rolls of double perforated tape made up of carefully selected and arranged matter for \$20.00 the most practical results.

Type J—Sends 6 to 60 W.P.M. Practise tape and 5 rolls of blank tape. Make your own special tapes with built-in tape perforator. \$12.50

*If your dealer can't supply you, write us*

Gardiner-Levering Co. Haddon Heights New Jersey, U. S. A.

## AMATEUR RADIO LICENSES

Day and Evening Classes in Code and Theory

HOME STUDY COURSES

*Reasonable, Efficient and Thorough, Hundreds of Licensed Students Now on the Air*

American Radio Institute, 1123 Broadway, New York, N. Y.

## SENSITIVE RELAYS for RADIO CONTROL and General Applications



11-A \$3.00  
Weight 1.8 oz.  
11-D \$3.30  
For Electronic Key

RCH relays are designed to have a curve of tractive pull vs. armature spacing that changes very sharply near the point of closure. With such a curve, small changes in current cause a relatively enormous variation in magnetic pull, resulting in unusually high drop-out ratio. Light in weight, rugged and dependable. Rated power sensitivity: 5.0 milliwatts. Drop-out ratio at 1.5 ma.; 70% min. Coil: 6000 ohms. Contacts: solid silver.

RADIO CONTROL HEADQUARTERS  
GRANBY CONNECTICUT U.S.A.

A GOOD NAME GOES A LONG WAY

Ken-Rad Dependable Radio Tubes are made in a modern Kentucky plant by skilled, intelligent American workers.



**Ken-Rad Radio Tubes**  
KEN-RAD TUBE & LAMP CORPORATION - OWENSBORO, KY.

Manufacturers of all types of radio tubes and Ken-Rad Electric Lamp Bulbs

# CRYSTAL TALK

Informative Bulletin No. 2

## By **HIPOWER** CF-2 MARINE & AIRCRAFT CRYSTAL

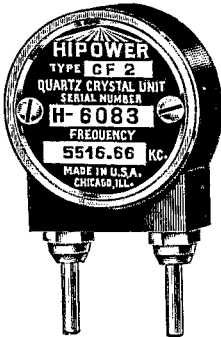

Dependable frequency control for marine-craft and itinerant aircraft is economically obtained with the Hi-power Type CF-2 Crystal Unit. Small and rugged with vertical mountings, the installation of a number of units is possible in limited space. Guaranteed  $\pm .04\%$  for marine-craft and  $\pm .05\%$  for itinerant aircraft as required by the F. C. C.

Available as complete crystal unit at following frequencies. AIRCRAFT: 3105 KC., 3120 KC. MARINE: 2670 KC., 2738 KC., 2110 KC., 2118 KC., 2126 KC., 2134 KC., 2142 KC., 2158 KC., 2166 KC., 2174 KC., 2182 KC., 2198 KC., 2206 KC.

Type CF-2 Crystal Units. . . . \$10.00

### AMATEUR CRYSTALS

"EMERALDS"	"RUBIES"
Guaranteed $\pm .10\%$ . With holder.	Guaranteed $\pm .04\%$ . With holder.
160-80-40 meters. . . . \$3.35	160-80-40 meters. . . . \$4.50
Special 20 meter unit. . . \$5.50	Special 20 meter unit. . . \$7.25

AVAILABLE AT YOUR PARTS DISTRIBUTOR

**HIPOWER CRYSTAL COMPANY**  
2035 CHARLESTON ST. CHICAGO, ILL.

**SICKLES COILS**  
ALL TYPES OF RF AND IF WINDINGS  
Manufactured by  
**F. W. SICKLES COMPANY**  
300 Main Street Springfield, Mass.

**LEARN RADIO • TELEVISION**  
60-page catalog on request. Oldest, largest and best equipped in New England. Write for new catalog.  
**MASS. RADIO SCHOOL**  
18 Boylston Street Boston, Massachusetts

### EASY TO LEARN CODE

It is easy and pleasant to learn the modern way — with an Instructograph Code Teacher. Ideal for the beginner or advanced student. ■ Many tapes available ranging from alphabet for beginners to typical messages on all subjects. Speed range 5 to 40 WPM. ■ Always ready, no QRM, beats having someone send to you.  
**FOR SALE OR RENT**  
STANDARD with 10 tapes and book of instructions, A.C. motor. . . . . \$24.50  
With spring-wound motor. . . . . \$18.50  
JUNIOR with 5 tapes and book of instructions (not rented). . . . . \$12.00  
RENTAL Standard with 10 tapes and book of instructions \$3.00 first month, \$2.25 each additional month. References or \$10 deposit required. All rental payments may be applied on the purchase price should you decide to buy the equipment.  
*Write for details today*

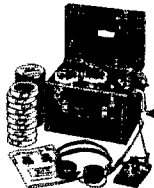

**INSTRUCTOGRAPH COMPANY**  
Dept. Q, 4701 Sheridan Road, Chicago, Illinois  
Representative for Canada:  
Radio College of Canada, 54 Bloor St. West, Toronto

signal is needed on 10 or 20, the switch may be placed in the "On" position, energizing the entire unit and producing additional radiation from the coupling link to the transmitter.

To take full advantage of the frequency stability of such an oscillator as this, a precision dial which can be read to at least one part in five hundred should be used. If expense is not too important a consideration, a National PW dial is about the best available. The dial used on the original model, however, was home made, and probably merits description here. A standard 12/1 split-gear worm drive was removed from an old automobile broadcast-receiver tuning condenser, and so fitted that it could be used to drive  $C_5$  and  $C_{14}$  on a common shaft. The worm shaft was brought out to a dial on the front panel, which was hand calibrated from 0 to 100 for 360 degrees rotation. With the 12 to 1 reduction, this dial makes 6 revolutions or 600 divisions, for 180-degree rotation of the tuning condenser. A small dial, numbered 1 to 6, was driven by a dial cord belt from, and used to count revolutions of, the worm shaft. Backlash is of no importance in this string linkage, since the small dial need be read only to one part in 6. It should, of course, be so belted that it makes somewhat less than one revolution for six revolutions of the main dial.

A rather desirable variation of this dial was used by W2ACB in the oscillator that he constructed. In place of the small dial for counting turns of the main dial, he used a four-inch dial so driven from the worm shaft by dial cord that it makes about 300 degrees rotation for 180 degrees rotation of the tuning condensers. Direct frequency calibrations are then engraved or written directly on the large dial for the various bands. Even with the best of workmanship, however, these scales are only intended to be approximate, and the linear calibration must be used for precision frequency setting. Incidentally, W2ACB used a 50 to 1 worm drive instead of 6 to 1, which accounts for the 25 divisions needed for the linear scale.

A few words about performance are probably in order. During almost two years of operation of the original model, its frequency calibration has consistently stayed well within  $\pm 0.025$  per cent. It was once carried in the trunk of a car for 300 miles, during which it was demonstrated at a banquet, which included a thorough "bounce test," and when rechecked found to be less than 1 kc. off calibration at 3900 kc. Warm-up drift in the 3500-4000 kc. band is approximately 1 kc., mostly confined to the first minute.

As for mechanical stability, the "bounce test" referred to above consists of listening to the c.w. note on a communications carrier while the entire unit is dropped approximately 12 inches to a table. Each time this test has been made the only effect on the note has been a single warble almost obscured by the crash as the unit strikes the table.

Although 7 tubes are used in the original unit, construction is not difficult, since all circuits are straightforward and no critical adjustments need

(Continued on next left-hand page)



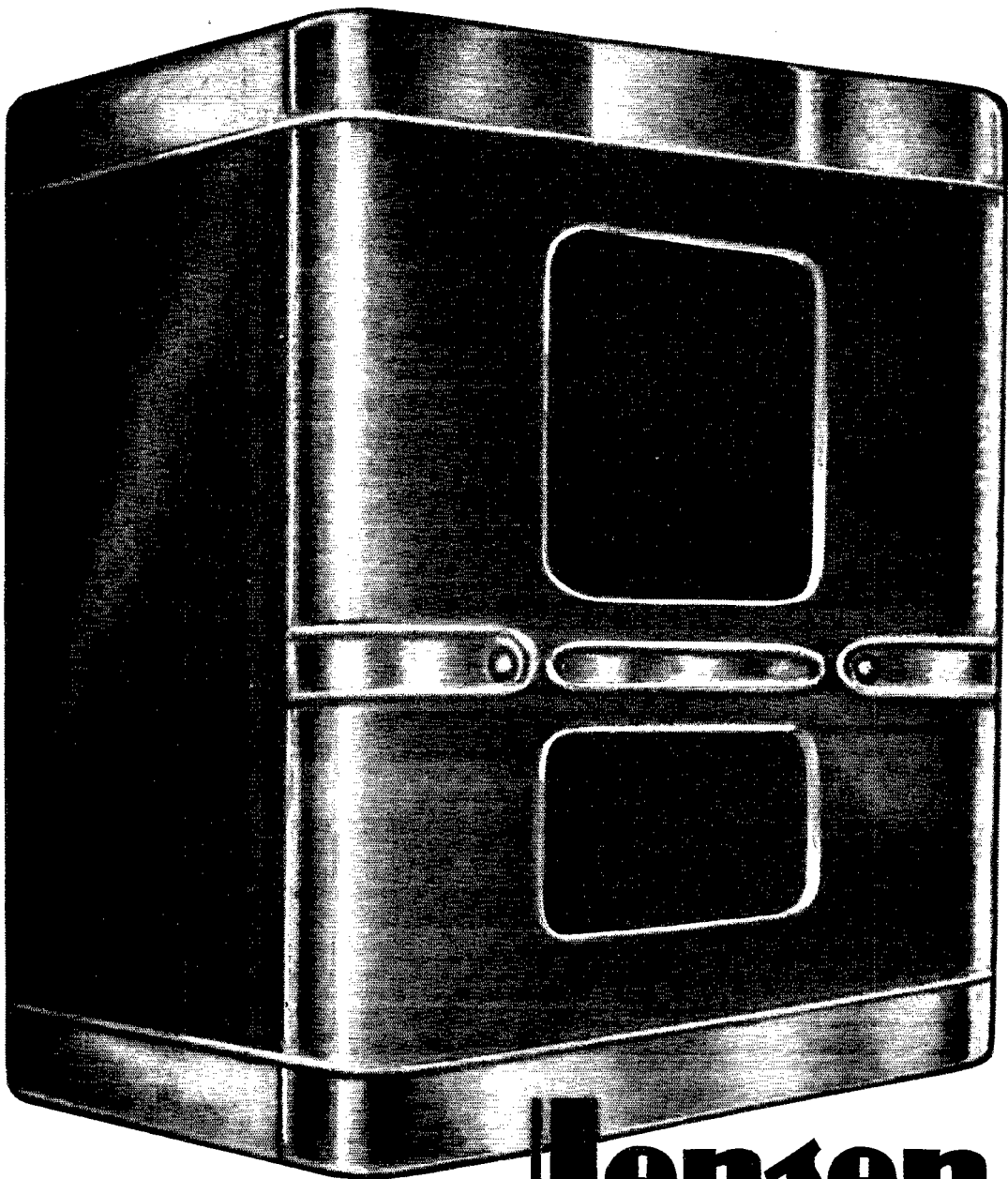

**M**ODEL MT-8 is the high fidelity *extended range* reproducer built primarily for broadcast monitoring and recording work. It employs an especially designed eight inch loud speaker working in conjunction with the well-known Jensen *Peri-dynamic* and *Bass-Reflex* principles.

Mean energy density acoustic measurements show an excellent frequency characteristic from 50 to 10,000 cps. The polar characteristic is substantially superior to any single speaker device we know of. It represents the final perfection in the technically superior amateur station. Cabinet

# Jensen *Bass Reflex* **REPRODUCERS**

dimensions are 24 x 17½ x 11¼. Complete with heavy duty Permanent Magnet Speaker — wall mounting brackets included — \$17.70 amateur's net. Jensen Radio Mfg. Co., 6601 S. Laramie Ave., Chicago.

# HARVEY VALUES ARE A HOWLING SUCCESS



## 2 1/2 Meter TRANSCEIVER KIT

with drilled panel and chassis complete with recommended parts and tubes as described by Mr. Vernon Chambers W1JEQ in April QST. Kit supplied completely assembled and ready for wiring... **\$14.95** net

Set of Batteries consisting of four Eveready long life Mini-Max B Batteries and one 6-Volt A Battery..... **\$4.72** net

## GREENLEE Socket Punches

NO HAMMERING — Just turn bolt. Cuts up to 1/8" steel panel.

Sizes	Prices
3/8".....	\$2.13 net
1 1/4", 1 3/16", 1 1/8".....	1.88 net

1 1/4" size will mount ALL Amphenol RSS, RS, RST sockets except large seven prong.

## PLEXIGLAS Spreaders

Light, durable, unbreakable

Sizes	Prices
2".....	7c net
4".....	9c net
6".....	12c net

## IN STOCK

MEISSNER, BROWNING and COMMUNICATION MEASUREMENT LABORATORY  
Frequency Modulation Receiver Kits.

## The NEW Coto Inducto-Cap Turret

W2IJJ      W2LJA      W2KWY

OUR *Best* VALUE IS OUR RECORD OF LOYAL SERVICE

# HARVEY

Radio Company of New York

103 WEST 43rd STREET • NEW YORK, N. Y.

CABLE ADDRESS: "HARADIO"

be made. If desired some simplifications, as shown in Fig. 2, may be made without sacrificing stability. Note that the crystal oscillator has been omitted, and a simplified voltage regulator used. A voltage-regulated power supply using a VR-150-30 provides adequate voltage stability, with a reduction in power supply complications. Its use will, of course, prohibit the use of the keying circuit described.

## Efficient U.H.F. Television Unit

(Continued from page 35)

one side of the a.c. line. Also, when the 5-pin male cable connector is pulled out of the transmitter chassis, the primary circuit of the high-voltage transformer is automatically opened.

Primary rheostat  $R_1$  is used to reduce the d.c. output voltage of the supply, which has a maximum full-load value of about 510 volts. This arrangement is very convenient when the r.f. stages are being adjusted initially. A Jones plug is used to connect  $R_1$  in the circuit; the rheostat is not mounted on the chassis because of the large amount of heat it must dissipate.

It should be noted that excellent filtering is required for television transmitter plate supplies. Otherwise, hum "bars" will appear on the received picture. The four electrolytic condensers comprising  $C_3$  are not shown in the bottom view of the power supply. The circuit was revised and these condensers were added after this photograph was taken.

### Performance

The transmitter, essentially as described, was operated on plate-modulated 'phone over a period of several months at W2BRO. After the usual "bugs" were eliminated, it performed as smoothly as any low-frequency rig the writer ever built — and a lot better than some!

A television "field test" has been made with the receiver (operated by portable W2ICA) located at Nutley, N. J., and the transmitter at Delawanna, N. J., a distance of about 1 1/2 miles. Excellent pictures were received on the 906-P4 Kinescope, even with a poor inside antenna on the receiver. Tests over much greater distances are planned for the near future. On the basis of the various operating tests made, it is anticipated that distances of 10 to 15 miles can easily be covered with this equipment. A close-spaced 3-element beam antenna is recommended for both receiver and transmitter.

Much work remains to be done on the antenna problem, to say nothing of the interesting circuits of the apparatus involved. At last, amateur television is in a position to go places. New hurdles are waiting to be leaped, new records to be set. The pioneering amateur again has a vast new field for research and experimentation. The problems involved are new and tantalizing — and, although within our ability to solve, are not-too-easy. Amateur ingenuity is due for a real workout.

Let's go!

# Take the Meissner "SIGNAL-SHIFTER" along on your vacation —

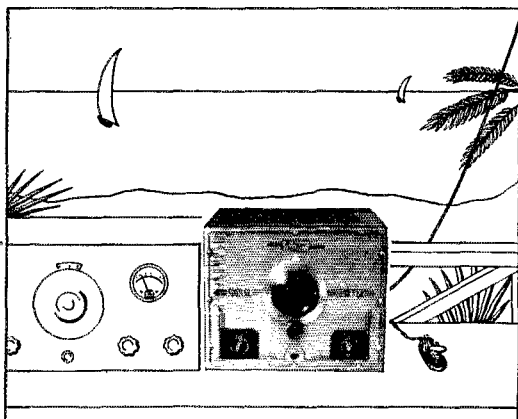

Yes, sir! The Meissner SIGNAL-SHIFTER is really a surprisingly efficient little transmitter — all by itself! Just lift it from your operating table and give it a vacation, too. In the tourist cabin, summer home, shooting lodge or cottage-at-the-shore — wherever 110-volt power is available — the SIGNAL-SHIFTER is always ready to keep you in contact with your skeds!

Its crystal-pure note and extreme flexibility make it easily capable of WAS on 40, 80 or 160 meter CW. Provides 7.5 watts (conservatively rated) on 20, 40 and 80 — somewhat higher on 160.

Easily coupled to a zepp or single-wire feeder, its ability to "get out" will amaze you. And its economy can't be overlooked! Just one moderate price covers a De Luxe variable-frequency exciter for your home station and at the same time provides a husky little portable rig — complete and ready to operate!

Better look it over at your Jobber's — NOW!!!

it's a complete

## Portable Transmitter !!!

Size—	Weight—	Power—
2/3 Cu. Ft.	25 Lbs.	7.5 Watts

# The New Meissner "Signal-Splicer"

is a pi network such as described on page 133 of the 1940 Handbook. It provides:

- Accurate impedance match between any type antenna and receiver . . .
- Tremendous boost in Signal Strength where previously badly mismatched . . .
- Substantial reduction in noise pick-up . . .
- Decided improvement in image rejection . . .

DON'T DELAY! Prove the remarkable efficiency of the SIGNAL-SPLICER on your own receiver. See your Parts Jobber at once — or write for further information. Only \$3.95 net.

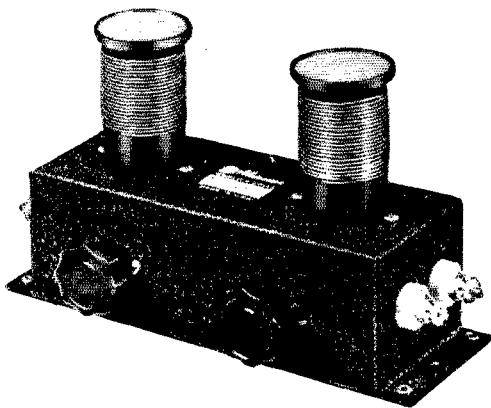

### WRITE FOR FREE CATALOG

If you haven't received your free copy of the big 48-page Meissner catalog it's still waiting for you. Fully illustrated — lists dozens of items of special interest to you! Communications receiver kits, Signal-Shifter, etc. Write for yours today!

ADDRESS DEPT. Q-7

**Meissner** MT. CARMEL ILLINOIS  
"A FAMOUS NAME FOR TWO DECADES"

# ★ A.R.R.L. QSL BUREAU ★

For the convenience of its members, the League maintains a QSL-card forwarding system which operates through volunteer "District QSL Managers" in each of the nine United States and five Canadian districts. In order to secure such foreign cards as may be received for you, send your district manager a standard No. 10 stamped envelope (standard business size,  $9\frac{1}{2}'' \times 4\frac{1}{8}''$ ). If you have reason to expect a considerable number of cards, put on an extra stamp so that it has a total of six cents postage. Your own name and address go in the customary place on the face, and your station call should be printed prominently in the upper left-hand corner.

- W1 — J. T. Steiger, W1BGY, 35 Call Street, Willimansett, Mass.
- W2 — H. W. Yahnel, W2SN, Lake Ave., Helmetta, N. J.
- W3 — Maurice Downs, W3WU, 1311 Sheridan St., N. W., Washington, D. C.
- W4 — G. W. Hoke, W4DYB, 328 Mell Ave., N. E., Atlanta, Ga.
- W5 — James F. Manship, W5ALE, 910 So. Boston, Tulsa, Okla.
- W6 — Horace Greer, W6TI, 414 Fairmount Ave., Oakland, Calif.
- W7 — Frank E. Pratt, W7DXZ, 5023 So. Ferry St., Tacoma, Wash.
- W8 — F. W. Allen, W8GER, 450 Fountain Ave., Dayton, Ohio.
- W9 — Alva A. Smith, W9DMA, 238 East Main St., Caledonia, Minn.
- VE1 — L. J. Fader, VE1FQ, 125 Henry St., Halifax, N. S.
- VE2 — C. W. Skarstedt, VE2DR, 236 Elm Ave., Westmount, P. Q.
- VE3 — Bert Knowles, VE3QB, Lanark, Ont.
- VE4 — George Behrends, VE4RO, 186 Oakdean Blvd., St. James, Winnipeg, Manitoba.
- VE5 — H. R. Hough, VE5HR, 1785 First St., Victoria, B. C.
- K4 — F. McCown, K4RJ, Family Court 7, San-turce, Puerto Rico.
- K6 — James F. Pa, K6LBH, 1416D Lunalilo St., Honolulu, T. H.
- K7 — Jerry McKinley, K7GSC, Box 1533, Juneau, Alaska.
- KA — George L. Rickard, KA1GR, P. O. Box 849, Manila, P. I.

## Strays

U. S. Hydrographic-Office Chart No. 5192 is a time-zone chart of the world,  $2\frac{1}{2}$  feet by 4 feet, in colors. It may be obtained from the U. S. Hydrographic Office, Navy Department, Washington, D. C., for fifty cents postpaid. This map is excellent for marking countries worked and for readily obtaining information on time zones.

— W2GVZ

## PINCOR ROTARY CONVERTERS

Engineered right . . . built right. That is why this complete line of Pincor Rotary Converters can always be depended upon to give thousands of hours of trouble-free service for operation of trouble-address systems, gaseous signs, public amplifiers, radios, A. C. motors, power instruments and other electrical apparatus, even under the most adverse conditions. Available with or without filter for converting 6, 12, 32, 110, 220 or special voltages D. C. to 110 or 220 volts A. C. Capacities: 40 to 5000 watts. Quiet, smooth, lightweight and compact. Send for NEW complete catalog today. Use coupon below.

**PIONEER  
GEN-E-MOTOR CORP.  
CHICAGO, ILL.**

Export Address:  
25 Warren Street, New York, N. Y.  
Cable: Simonrice, New York



PIONEER GEN-E-MOTOR CORP.  
Dept. R-6G, 466 W. Superior St., Chicago, Ill.  
Please send me NEW complete catalog on Pincor Rotary Converters.

Name .....

Address .....

City ..... State .....



## Prevents u.h.f. Oscillations

The way amateurs have taken to this Ohmite Parasitic Suppressor is proof of the swell job it is doing in preventing u.h.f. parasitic oscillations. Combines a non-inductive vitreous-enameled resistor with a choke into one integral unit. Small, light, easy to install.

Ask Your Jobber — Write for Catalog 17

**OHMITE MANUFACTURING CO.**  
4863 Flounoy Street Chicago, U.S.A.

Be Right with **OHMITE**  
RHEOSTATS • RESISTORS • TAP SWITCHES

# Take it from me...



RME really *has* something in the new RME-99, 12-tube communication receiver. Look at that big, easy tuning, calibrated band spread dial. This receiver uses the new Loktal type tubes, and has all the desirable features such as a 5-position crystal selectivity switch, stand-by switch, stable characteristics, and noise limiter with panel adjustment for peak operation. *Take it from me*, when I say this receiver can't be beat for value.

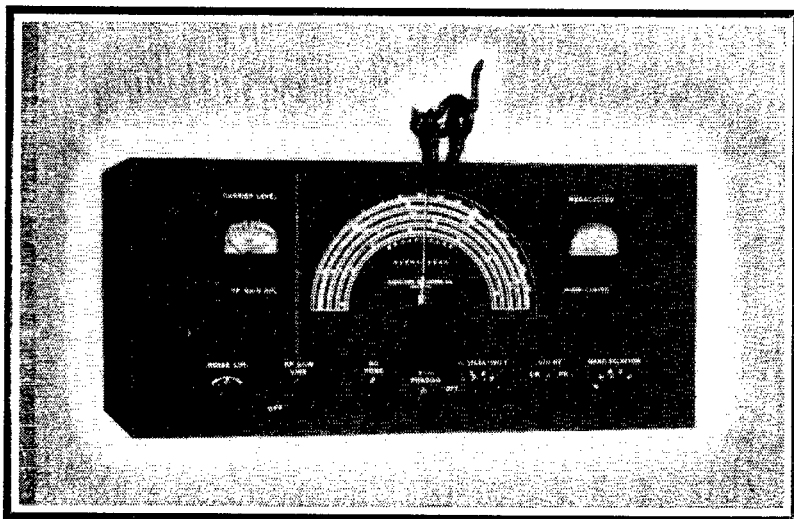

# Buy it from me!



I offer you fast service, a personally financed 6% time payment plan with a minimum of red tape, and the best trade-in on your equipment. I have thousands of satisfied customers everywhere, who will gladly vouch for the fairness of my dealings. Write me today, for complete information on my sales plan, and see if you don't agree that my offer is the best obtainable anywhere. Tell me what you want and how you want everything handled. I will cooperate with you to see that you are 100% satisfied.

I have a complete stock of all amateur receivers, transmitters, kits, antennas, tubes, crystals, parts of all sorts. Send to me for amateur apparatus at the lowest net wholesale price in any catalog or ad. I guarantee you can't buy for less or on better terms elsewhere. Your inquiries and orders invited.

*Bob Henry*

**W9ARA**

**HENRY RADIO SHOP**  
**BUTLER, MISSOURI**

# AN ANNOUNCEMENT of General Interest to "RADIO HAMS"



It is with great pleasure that SUN RADIO announces the addition to their staff of Mr. H. Kahn, associated for many years with Leeds Radio Co. Well-known, well-liked, Mr. Kahn brings with him to SUN the well-wishes of thousands of "Hams" throughout the world who have come to know him through personal acquaintance or correspondence for his fair, honest dealings. SUN is proud to acquire the services of such a personage as Mr. Kahn, long steeped in the tradition of the radio industry.

His many friends will be glad to learn that he is now on tap at SUN where his many years of broad background and experience helps round out a diversified SUN STAFF — aimed to give you BETTER SERVICE.

## A PERFECT COMBINATION FREQUENCY/AMPLITUDE MODULATION RECEIVER — HALLICRAFTERS S-27

NOW! — Enjoy FM programs and Amateur Communications from the same receiver! 3 bands — 27-145 Mc. 15 tubes. Band switch from FM to AM. Beam power tubes in A.F. amplifier. Acorn tubes in R.F. and converter system.

Amateur Net Price — complete with tubes . . . . . **\$175.00**

## IN STOCK — MIMS SIGNAL SQUIRTERS for DE LUXE ANTENNA INSTALLATIONS

The Beam Antenna System of Today and Tomorrow  
Ideal for 10-20 Meter Operations

DE LUXE ROTATOR — Powerful, high-starting running torques, completely weatherproofed. Quiet, continuous rotation in either direction. Electrically operated brake locks unit in any position.

Amateur Net Price . . . . . **\$69.50**

DIRECTION INDICATOR — Operates in either direction. Affords visual monitoring of beam at all times. Control switch operates the Rotator.

Amateur Net Price . . . . . **\$24.50**

Write for latest Mims catalog describing complete line of elements and accessories

## The "FRECO" — for VARIABLE FREQUENCY GENERATION and CONTROL

A new Electron Coupled Oscillator, especially designed as an effective substitute for 40 and 80 meter crystals. Less than 4 kc. drift on 10 meters. Frequency range — 3490 to 3760 kc. (400 degree band spread on 10 meters). Standby switch and keying relay. Employs a 6SK7 oscillator, VR105 voltage regulator and 6L6 doubler.

Amateur Net Price — with tubes . . . . . **\$45.00**

Power Supply for above — 6.3 volts at 1.2 amps. and 325 volts at 75 MA. Amateur Net Price . . . . . **\$15.00**

## SUN X'MITTING CONDENSERS

SPECIAL 1 mfd. 1000 volts D.C. . . . . 78c  
1 mfd. 1500 V.D.C. . . . . **\$1.10**     2 mfd. 2000 V.D.C. . . . . **\$1.95**  
1 mfd. 2000 V.D.C. . . . . **\$1.29**     4 mfd. 2000 V.D.C. . . . . **\$2.95**

NOW ON THE PRESS!

SUN'S NEW P.A. CATALOG — OUT SOON!  
24 Pages Chock-Full of SOUND VALUES!

RESERVE YOUR COPY TODAY!

New York's Oldest "Ham" House  
W2JEH — W2DXC — W2LFV — W2GCX

## SUN RADIO CO.

212 Fulton Street, Dept. JT New York

Cable Address: SUNRADIO NEW YORK

## WWV Schedules

EXCEPT for the special broadcasts of WWV using 20 kw. as described below, WWV is now running a continuous schedule (day and night) on 5000 kc. with a power output of 1 kw. This continuous transmission is modulated with the standard pitch in music, 440 cycles per second.

Each Tuesday, Wednesday and Friday (except legal holidays), the National Bureau of Standards station, WWV, transmits with a power of 20 kw. on three carrier frequencies as follows: 10:00 to 11:30 A.M., E.S.T., on 5000 kc.; noon to 1:30 P.M., E.S.T., on 10,000 kc.; 2:00 to 3:30 P.M., E.S.T., on 15,000 kc. The Tuesday and Friday transmissions are unmodulated c.w. except for 1-second standard-time intervals consisting of short pulses with 1000-cycle modulation. On the Wednesday transmissions, the carrier is modulated 30% with a standard audio frequency of 1000 c.p.s. The accuracy of the frequencies of the WWV transmissions is better than 1 part in 10,000,000.

## THESE THIRD PARTIES

92 Rockview St., Jamaica Plain, Mass.

Editor, QST:

Anent this business of "Say, OM, so you are in Boston, eh? Well, my Aunt Matilda lives in Boston, that is, in Lynn (or Brockton or Lowell, or Worcester, or Pittsfield) and I wonder if you would give her a buzz on the land line and see if we can arrange a sked? Maybe you could have Uncle Willie and Auntie over to your shack and we could have a swell QSO. I've forgotten just what street they live on, but I

## An Amateur Version of a POLICE CAR TRANSMITTER popularly priced

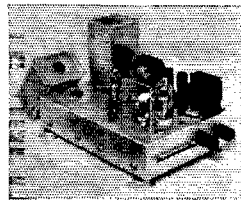

Type T-510 — 12 watt Crystal Controlled Portable Mobile Transmitter with 28 and 56 Mc. Band Switching.

As used by Ansel E. Gridley, W4GJO in working 33 states from his car in Florida.

Write for a complete description of this sensible unit that is powerful, yet easy on your battery and purse.

Type T-510 Kit. **\$21.80**

## RADIO TRANSCEIVER LABORATORIES

8627 115 STREET RICHMOND HILL, NEW YORK CITY  
CABLE ADDRESS: "RATRALAB", NEW YORK

# We Repeat \*\*\*

the F.C.C. requires a record of all transmissions. Have you a separate log for your U.H.F. portable mobile work?

35¢ each, 3 for \$1.00

AMERICAN RADIO RELAY LEAGUE, INC.  
West Hartford, Connecticut

## *New Model UT-48 Crystal Microphone*

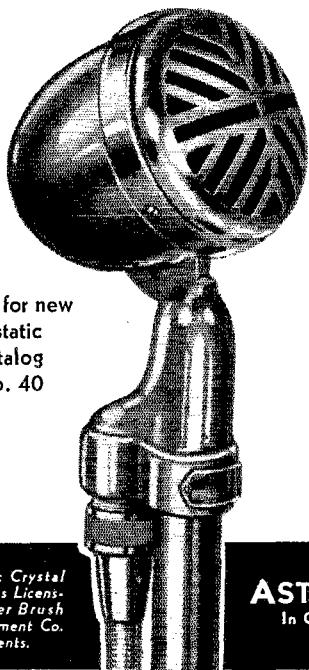

Write for new  
Astatic  
Catalog  
No. 40

# ASTATIC

## AMATEUR SPECIAL

To meet the ever increasing demand among amateurs for a highly efficient, moderate priced, speech range microphone, Astatic engineers have designed Model UT-48. This new microphone is equipped with tilting head swivel mount for semi- or non-directional use and concentric cable connector to permit interchangeability. Lustrous, durable satin chrome finish and attractive modern die cast grille and body will add to the appearance of any amateur's rig. See it at your radio jobber's or write for catalog. List Price \$16.50.

*Astatic Crystal  
Products Licensed  
Under Brush  
Development Co.  
Patents.*

**ASTATIC MICROPHONE LABORATORY, INC.**  
In Canada: Canadian Astatic, Ltd.  
Toronto, Ontario  
**YOUNGSTOWN, OHIO**

## *New Exams*

# NEW LICENSE MANUAL

The new examinations are based on the multiple-choice type of questions. This of course requires an entirely different approach on the part of the applicant studying to take the examination for license. The NEW "License Manual" has been written to make it as easy as possible for the individual to acquire the necessary knowledge to pass the examination with flying colors. Whether you are going up for your Class B or your Class A ticket, "The License Manual" will provide the most direct path to getting that ticket. If you are one of the thousands who always wants a "License Manual" around the shack for ready reference for amateur regulations, it will please you to know that the regulations are very thoroughly indexed.

*Price 25c postpaid (no stamps, please)*

**AMERICAN RADIO RELAY LEAGUE**  
**WEST HARTFORD, CONNECTICUT**

**ARE YOU TRYING TO**  
  
**KEEP or IMPROVE**  
**YOUR JOB?**

**INSURE YOUR FUTURE with CREI**  
 Home Study or Residence Training in  
**RADIO & TELEVISION**  
**ENGINEERING**

■ New developments in radio provide amazing opportunities for men in various branches of radio and television engineering. But it takes ABILITY to earn good money in the good jobs. You can improve your present position thru CREI courses, just as other radiomen have done in preparing for the good jobs open for trained men. The fact that men in more than 300 broadcasting stations select CREI courses, is proof that our training pays!

**NEW BOOKLET just off the press!**

Send for your free copy, TODAY!

In writing please state briefly your radio experience, education and present position — and whether you are interested in home-study or residence training.



**Capitol Radio Engineering Institute**  
 Dept. Q-7 3224 16th Street, N.W., Washington, D. C.

think they have a 'phone (usually listed under some other name) and what say you give them a buzz and see if we can fix up a sked for, say, some Sunday morning, early.

Sure. It's a swell idea, but let's try it this way. Here is my 'phone number, my name and address. Now suppose you drop Aunt Tillie a card or a note, with those items, and suggest the sked idea to her. Then if she is interested she can buzz me and we will be very glad to have the folks come out when they find it convenient. If she does it on her own initiative, we feel less as though we are a humored screwball. The facilities of the shack are ready and waiting for anyone who will make the effort to use them. I have found the above procedure most effective, and the reduction on one's telephone bill is surprising.

— Jack Ferguson, WIIIM

**EDITOR'S NOTE.** — Perhaps it would be just as well to forget the whole thing. Then no one would be bothered — either Aunt Tillie or the other hams on the band who would have to listen to her.

**WIRELESS VICS**

Carleton College, Northfield, Minn.

Editor, QST:

Lately I have been coming into contact with a great number of these so-called "wireless vics." In the dormitory that I am in here there are no less than three of them, and prospects of a few more. The fellows are not satisfied just to have the vic and let the sig carry a few feet to a couple of radios, but have gone so far as to put antennas on them. They have not as yet put out any great sigs, but if they carry out their intentions WLW will have some competition! Now two of them have the bright idea of talking back and forth on their transmitters — point-to-point communication on the broadcast band! What next?! Maybe I have the wrong slant on this, but for two fellows to be able to buy some simple equipment and also a regular radio set and be able to broadcast entertainment and to use it for point-to-point communication burns me, especially after the work that we hams have to put in to get that "ticket."

I guess according to law they are within their rights to a certain extent, but just how far does this little deal go? Can we all go on the air with our low-powered broadcast station and make a little side money, too, as some fellow is apparently doing at Dartmouth?

Seems to me that it just ain't right we have to get a license to go on the air but they don't. 'Course I realize we have more advantages, and I am not advocating abolition of licenses.

Any of the rest of you touchy about this subject too?

— C. J. Ellis, W9YBV

**EDITOR'S NOTE.** — Use of wireless record players as described by W9YBV is illegal. See May 1939 QST, page 26. Such operation should in every case be reported to the local Radio Inspector.

**Catalogs and Pamphlets**

**T**HE following catalogs and pamphlets are available to amateurs upon requests addressed to the manufacturer or his local representative:

**Collins Radio Co., Cedar Rapids, Iowa**

A 12-page bulletin describes the new 231C transmitter which is available in 500-, 1000- and 3000-watt models covering a range of 2500 to 20,000 kc. An automatic tuning device is incorporated which tunes the circuits to predetermined frequencies by remote dial control. The transmitter is equipped for high-speed c.w. and i.c.w. code, or telephone transmissions.

**Hygrade Sylvania Corp., Emporium, Penna.**

The new radio-tube base chart being distributed to Sylvania dealers and servicemen, although reduced in size (21½ by 13), has an increased number of base views. For the 376 types extant, there are shown 118 views and an index and cross-index are included.

(Continued on next left-hand page)

**Performance Accuracy Value**  
**ALL in the NEW PRECISION #832**  
**31 Range Rotary Selective AC/DC**  
**Multi-Range Tester**



- ★ **LARGEST METER** ever provided (3½ inches is the ACTUAL WIDTH) in such a compact instrument, only 7" x 4½" x 3" overall.
- ★ A single Master Rotary Range Selector allows ALL measurements to be made from **ONLY TWO** polarized tip jacks, except for the two highest voltage ranges.
- ★ **RANGES** • 6 DC voltage ranges at 1000 ohms per volt: 0-6, 30, 150, 300, 600, 1200 volts • 6 AC voltage ranges at 500 ohms per volt: 0-12, 60, 300, 600, 1200, 2400 volts • 4 DC current ranges to 600 mils. • 3 OHMMETER ranges to 5 MEGS. up to 500M ohms on internal batteries • 6 DECIBEL ranges (-10 to +82 DB) • 6 OUTPUT ranges to 2400 volts.
- ★ **IT'S "PRECISION" BUILT** — 1% wire wound coils — 1% matched metallic multipliers — individually sealed calibrating controls — telephone cabled wiring, etc.

COMPARE THIS "PRECISION" VALUE at only \$14.95 net  
 This is only one of the more than 40 models comprising the complete "Precision" line of dynamic mutual conductance tube testers, combination set testers, multi-range testers, signal generators, etc. Prices start as low as \$10.95.

Ask for the **PRECISION TEST EQUIPMENT 1940 CATALOG**

**PRECISION TEST EQUIPMENT**  
*Standard of Accuracy* SEE THEM AT YOUR JOBBER  
**PRECISION APPARATUS COMPANY**  
 647 Kent Avenue Brooklyn, New York  
 Export Div.: 458 Broadway, New York, U. S. A. — Cables: Morhanex



# \$1

## OPENS YOUR "CHARGE ACCOUNT" AT NEWARK

See Details  
Below!

### HIGH VOLTAGE POWER TRANSFORMERS

600-0-600 V. — 200 MA.

# \$2.59

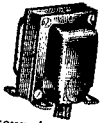

Newark's larger volume of amateur business makes this unmatched value possible. Made by one of the largest transformer manufacturers. These husky transformers have a place in every Ham Rig. Guaranteed. As illustrated.

#### Choice of Two Filament Types

No. 4140 — 600-0-600 V. — 200 MA. Filaments:  
7.5 V.C.T.-3 A. — 5.0 V.C.T.-3 A. — 2.5 V.C.T.-10 A. Wt. 8 1/4 lbs. . . . . \$2.59  
No. 4240 — 600-0-600 V. — 200 MA. Filaments:  
6.3 V.-4 A. — 6.3 V.-3 A. — 5.0 V.-3 A. Wt. 8 1/2 lbs. . . . . \$2.59

#### ANOTHER SALES LEADER!

Just the thing for the Osc. Power Supply, Speech Amplifier and many other services. Same style as illustrated above. Wt. 8 lbs.  
350-0-350 Volts — 150 MA. 5 V. — 3 A. 5 V. — 3 A. 2.5 V. — 3 A. 2.5 V. — 7 A. . . . . \$1.69



WE TAKE PRIDE IN ANNOUNCING OUR APPOINTMENT AS THE EXCLUSIVE DISTRIBUTORS FOR WESTINGHOUSE POWER TUBES IN THIS AREA!

### YOUR CALL LETTERS IN GOLD. 10c

Put these big shadowed decalcomania letters on your Ham Shack door, auto window, etc. Nearly 2" high. Send dime for yours today. Be sure to give call letters.

### FREE BULLETIN

8 pages, illustrated. Just out, and full of Ham bargains, details of NEW CONTINUOUS TIME-PAYMENT PLAN. Every item a real guaranteed value . . . and savings well worth while.

### ALL BEST KNOWN AMATEUR RECEIVERS AVAILABLE ON EASY PAYMENT PLAN!

Pick out any set you want and order it. Include your filter condensers, transformer or other supplies you need in the same order. ENCLOSE ONLY \$1.00 to establish your credit. We notify you when credit is approved, and ship your order upon receipt of the rest of the down payment as stated below.

	Cash Price	Down Payment
Hallcrafters S 19 R . . . . .	\$29.50	\$5.00
Hallcrafters S 20 R . . . . .	49.50	5.00
National NC 44 . . . . .	49.50	5.00
Hallcrafters SX 24 . . . . .	81.50	8.15
Hallcrafters SX 25 . . . . .	99.50	9.95
National NC 101 X . . . . .	129.00	12.90
RME 99 . . . . .	137.40	13.74
Hammarlund HQ 120 X . . . . .	138.00	13.80
RME 70 . . . . .	138.00	13.80
National NG 100 XA . . . . .	142.50	14.25
RCA - AR 11 . . . . .	147.50	14.75
RME 69 . . . . .	152.88	15.28
NATIONAL NHU . . . . .	165.00	16.50
RME 70 DB Comb'n . . . . .	181.80	18.18
National HRO . . . . .	205.50	20.55
Hallcrafters HT 9 . . . . .	237.35	23.73
Hammarlund Super Pro . . . . .	279.00	27.90

All sets complete ready to use. Shipped in brand new, original unopened factory cartons, from stock on hand.

### HOW to GET CREDIT at NEWARK Send only \$1 right now

Think of it! Only \$1 establishes your credit, opens a "charge account" at Newark. You can deduct the \$1 from your down payment when you buy. Select any items you want and pay only 10% down (\$5 minimum down payment). Minimum \$25 purchase required on first order, but you can ADD FUTURE PURCHASES of \$10 or more to your "charge account" at any time. Carrying charge 6%. You make small monthly payments on net balance as follows:

Net balance up to \$50 . . . . .	Monthly payment \$ 5.00
Net balance \$ 50 to \$ 75 . . . . .	Monthly payment 7.50
Net balance 75 to 100 . . . . .	Monthly payment 10.00
Net balance 100 to 150 . . . . .	Monthly payment 15.00
Net balance 150 to 200 . . . . .	Monthly payment 20.00

ORDER TODAY DIRECT FROM THIS AD

### ONCE AGAIN!

NEWARK'S GREATEST  
BARGAIN "SCOOP"

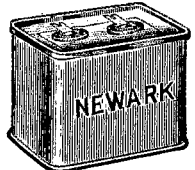

Oil Filled, Oil Impregnated

### FILTER CONDENSERS

# \$3.75

4 mfd., 3000v. DC. Size 4 1/4" x 3 1/4" x 3 1/4"  
Weight 2 3/4 lbs.

# \$1.00

2 mfd. 1000v. DC.

Newark's massive buying power enables us to offer these astonishing values again, in face of ever rising costs. Over 50,000 of these condensers in use, by satisfied amateurs.

DC Volt Mfd.	Size	Wt.	Price
2000 2	4 1/4" x 3 1/4" x 1 1/4"	1 1/4 lbs.	\$1.50
1500 4.4	5" x 3 1/4" x 1 1/4"	1 1/2 lbs.	1.75
1500 5	3 3/4" x 3 1/4" x 1 1/4"	1 1/4 lbs.	1.90
2000 8	5" x 3 3/4" x 3 1/4"	3 1/2 lbs.	2.75

### LIMITED STOCK GET YOURS NOW

# NEWARK

## Electric Company

323 W. MADISON ST.  
Dept. Q CHICAGO, ILL.

See and Hear the New  
Communication-Type  
**RECEIVERS**  
at  
**TERMINAL'S**

Two Conveniently Located Stores  
• 68 WEST 45TH ST. (MIDTOWN)  
• 80 CORTLANDT ST. (DOWNTOWN)

**HALLICRAFTERS • NATIONAL  
RCA • HAMMARLUND • RME**  
Available on Time Payments

**HALLICRAFTERS SX-25**



Considered better than the SX-17, yet costs \$50.00 less! Complete with 12 tubes, crystal filter and 10" speaker in matching cabinet. . . . . **\$99.50**

Model	Cash Price
RME-99, complete . . . . .	<b>\$137.40</b>
Hammarlund HQ-120X, complete . . . . .	<b>138.00</b>
RCA AR-77, complete . . . . .	<b>147.50</b>
Hallcrafters S20R, complete . . . . .	<b>49.50</b>
Hallcrafters S19R, complete . . . . .	<b>29.50</b>
National HRO Sr., less power supply and speaker . . . . .	<b>179.70</b>
National NC-100A, complete . . . . .	<b>120.00</b>
Hallcrafters SX-24, less speaker . . . . .	<b>69.50</b>
Hammarlund Super Pro, complete . . . . .	<b>279.00</b>

**PUBLIC ADDRESS EQUIPMENT**  
Headquarters for amplifiers and accessories for every P.A. need. Write today for our complete P.A. catalog.

**TERMINAL** *Radio Corp.*  
68 West 45th St. • 80 Cortlandt St.  
2 stores in NEW YORK CITY  
Vanderbilt 6-5050 • Cable: TERMRADIO

**Pioneer Gen-E-Motor Corp., 466 W. Superior St., Chicago, Ill.**

A new catalog No. HC-4-40, covering a complete line of rotary converters for converting 6, 12, 24, 32, 38, 110, 220 or any special d.c. voltage to 110 or 220 volts a.c. in capacities of 40 to 5000 watts has just been issued. Engineering specifications, pertinent data, weights, dimensional drawings and tables for quick reference are included. Literature is also available on engine-driven units and generators for aircraft and marine use.

**Solar Manufacturing Corp., Bayonne, N. J.**

Circulars describing the condenser "Quick-Check" and a new more compact line of electrolytic condensers.

The "Quick-Check" is combined with a Wien bridge for checking capacities of condensers out of circuit and quality under conditions of dynamic or static performance. The capacity range is 10  $\mu\text{fd.}$  to 70  $\mu\text{fd.}$

**A 112-Mc. Converter**

(Continued from page 41)

receiver at 25 Mc. and will later be incorporated into a frequency-modulation receiver.

By direct comparison between a 955 acorn super-regenerative receiver and the converter-

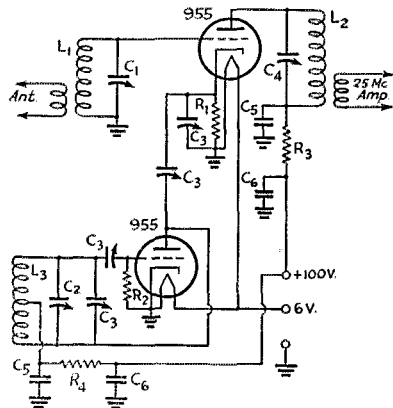

Fig. 1 — The 112-Mc. converter circuit.

- C<sub>1</sub>, C<sub>2</sub> — 15  $\mu\text{fd.}$ , modified. See text (National UM15).
  - C<sub>3</sub> — 3-30  $\mu\text{fd.}$  mica compression (Hammarlund MEX or National M30).
  - C<sub>4</sub> — 25- $\mu\text{fd.}$  air trimmer (Hammarlund APC-25).
  - C<sub>5</sub> — 100- $\mu\text{fd.}$  mica.
  - C<sub>6</sub> — 0.001- $\mu\text{fd.}$  mica.
  - R<sub>1</sub>, R<sub>3</sub> — 10,000 ohms.
  - R<sub>2</sub> — 20,000 ohms.
  - R<sub>4</sub> — 2000 ohms.
- All resistors are  $\frac{1}{2}$ -watt size.  
L<sub>1</sub>, L<sub>2</sub>, L<sub>3</sub> — See text.

superhet, signals that registered three to four on the "S" meter and were readable QSA5 were in most cases indistinguishable on the "rush box." Signals that began to take the rush out of the super-regen, were S7 to 8 on the converter. The superiority of the converter-superheterodyne should be self-evident.

# Where to buy it

A directory of suppliers who carry in stock the products of these dependable manufacturers.

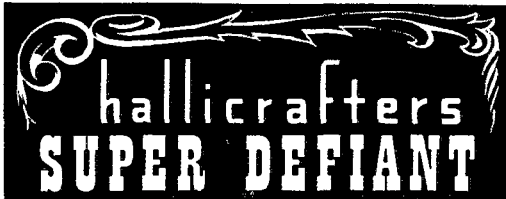

**ALBANY, N. Y.** Uncle Dave's Radio Shack 356 Broadway  
**ATLANTA, GEORGIA** 265 Peachtree Street  
 Radio Wire Television Inc.  
**BOSTON, MASS.** Radio Shack 167 Washington Street  
**BOSTON, MASS.** 110 Federal Street  
 Radio Wire Television Inc.  
**BRONX, N. Y.** 542 East Fordham Rd.  
 Radio Wire Television Inc.  
**BUTLER, MISSOURI** 211-215 N. Main Street  
 Henry Radio Shop  
**CHICAGO, ILL.** 833 W. Jackson Blvd.  
 Allied Radio Corp.  
**CHICAGO, ILL.** 901-911 W. Jackson Blvd.  
 Radio Wire Television Inc.  
**CINCINNATI, OHIO** 1103 Vine Street  
 United Radio, Inc.  
**DETROIT, MICH.** 325 E. Jefferson Ave.  
 Radio Specialties Co.  
**DETROIT, MICHIGAN** 11800 Woodward Ave.  
 Radio Specialties Co.  
**HARTFORD, CONNECTICUT** 227 Asylum Street  
 Radio Inspection Service Company  
**HOUSTON, TEXAS** 4021 Huey Street  
 R. C. & L. F. Hall  
**INDIANAPOLIS, INDIANA** 34 West Ohio Street  
 Van Sickle Radio Supply Co.  
**JAMAICA, L. I.** 90-08 166th Street  
 Radio Wire Television Inc.  
**KANSAS CITY, MO.** 1012 McGee Street  
 Burstein-Applebee Company  
**NEW YORK, N. Y.** Harrison Radio Co. 12 West Broadway  
**NEW YORK, N. Y.** 100 Sixth Ave.  
 Radio Wire Television Inc.  
**NEWARK, N. J.** 24 Central Ave.  
 Radio Wire Television Inc.  
**SCRANTON, PENN.** 519-21 Mulberry Street  
 Scranton Radio & Television Supply Co.  
**SPRINGFIELD, MASS.** T. F. Cushing 349 Worthington St.  
**WASHINGTON, D. C.** 938 F Street, N. W.  
 Sun Radio & Service Supply Co.

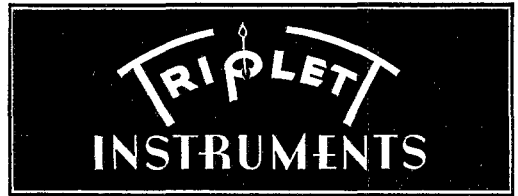

**ALBANY, N. Y.** Uncle Dave's Radio Shack 356 Broadway  
**ATLANTA, GEORGIA** 265 Peachtree Street  
 Radio Wire Television Inc.  
**BOSTON, MASS.** Radio Shack 167 Washington Street  
**BOSTON, MASS.** 110 Federal Street  
 Radio Wire Television Inc.  
**BRONX, N. Y.** 542 East Fordham Rd.  
 Radio Wire Television Inc.  
**BUTLER, MISSOURI** 211-215 N. Main Street  
 Henry Radio Shop  
**CHICAGO, ILLINOIS** 833 W. Jackson Blvd.  
 Allied Radio Corp.  
**CHICAGO, ILL.** 901-911 W. Jackson Blvd.  
 Radio Wire Television Inc.  
**CINCINNATI, OHIO** 1103 Vine Street  
 United Radio, Inc.  
**JAMAICA, L. I.** 90-08 166th Street  
 Radio Wire Television Inc.  
**LITTLE ROCK, ARKANSAS** 409 W. 3rd St.  
 Beem Radio Company  
**MINNEAPOLIS, MINNESOTA** 1124-26 Harmon Place  
 Lew Bonn Company  
**NEW YORK, N. Y.** 100 Sixth Avenue  
 Radio Wire Television Inc.  
**NEWARK, N. J.** 24 Central Ave.  
 Radio Wire Television Inc.  
**SCRANTON, PENN.** 519-21 Mulberry Street  
 Scranton Radio & Television Supply Co.  
**WASHINGTON, D. C.** 938 F Street, N. W.  
 Sun Radio & Service Supply Co.

Listings on this page do not necessarily imply endorsement by QST of the dealers or of other equipment sold by them.

*Operating Pleasure*

**FREQUENCY FLEXIBILITY  
with CRYSTAL STABILITY**

The Bliley Vari-X, with VP2 wide range variable crystal units, provides V.F.O. flexibility with full crystal stability. Circular D2, obtainable from your Bliley Distributor, gives complete information.

**BLILEY Vari-X**  
VARIABLE CRYSTAL OSCILLATOR

## FOR MODERN, COMPLEX RECEIVERS!

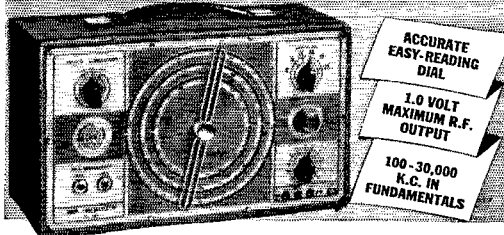

## New RCA Test Oscillator #167 \$34.50

Let this new RCA Test Oscillator make your tough servicing jobs simpler! It has the range you want — 6 bands: 100 to 30,000 K.C. in fundamentals . . . with harmonics of 6th band for U-H-F applications. AC operated. High output, for single-stage alignment work, or for sets misaligned altogether — plus a new, precision, easy-reading

dial-scale, trim appearance and RCA engineering — make it a real buy at only \$34.50. Ask your RCA Distributor to show you all its features.

Over 335 million RCA Radio Tubes have been purchased by radio users . . . in tubes, as in parts and test equipment, it pays to go RCA ALL THE WAY.

**RCA Test Equipment**

RCA Manufacturing Company, Inc., Camden, New Jersey  
A Service of the Radio Corporation of America

## Portable Transmitter Receiver

(Continued from page 44)

from the crystal mounting and eliminate any possibility of shock from this source.

### Operation

There is not a great deal to be said about the operation of the rig because it has been repeated so often for similar ones. With 400 volts on the plate of the 6L6 and with the antenna closely coupled, the plate current will run from 80 to 100 ma. With 250 volts from a genemotor or vibrator-pack supply the plate current will be about 40 ma. A ¼-watt neon bulb can be connected to one of the output terminals to indicate maximum output or a small dial lamp can be used in series with one wire if a tuned feed-line is used.

A short piece of wire about 5 or 6 feet long has been found to be very satisfactory for the receiving antenna, and quite sufficient headphone volume is obtained. The antenna trimmer condenser, C, is usually set to give quite loose coupling, particularly on the 7-Mc. band. Once set, the trimmer does not have to be touched again.

The send-receive switch transfers the plate voltage from the receiver to the transmitter and back. The heaters of all the tubes are left running at all times, to eliminate any delay in the switch-over process.

## On the Ultra Highs

(Continued from page 47)

long way toward making up for a few thousand feet of altitude.

W3BZJ went up in a plane with an Abbott transceiver, on May 4th, as scheduled. Poor visibility prevented their going much over 1000 feet but ten stations were worked, of which eight were 25 or more miles distant. Best DX was W2BZB, Palisades Park, N. J., contacted when the ship was over Langhorne, Pa., a distance of 75 miles.

The Marathon award for April was won by a 112-Mc. man. W6RVL, Los Angeles, came through with some nice contacts (including two of 100 miles each) to turn in the highest score reported for April: 86 points.

112-Mc. work accounted for quite a percentage of the points reported in the May Relay, too. Though no long relays were reported that we know of, the boys on Five and 2½ worked together much more successfully this time. Messages originating on 112 Mc. were handled over longer jumps on Five in several instances. Operating atop High Point, N. J., alongside W3AC/3 was W2IQ/3. Using a pole oscillator with an RK-34 on a perilous perch some 15 feet off ground, Wilson had a flock of contacts with W2's in the New York area and out on Long Island, a distance of approximately 70 miles.

### 224 MC.:

OUR "Centimeter Net," W1's JJR, HDF, KJC, AIY, and KLLJ, got together Saturday night, May 18th, to fatten up their Relay scores with some contacts on 224 Mc. at 10 points each. Since last month W1KLLJ and W1HDF have done two-way work on 1¼, so our record box now shows this 13-mile work on 224 Mc. There may have been longer two-way contacts than this on this band. If so, we'd certainly like to hear about it. Work on 224 Mc. appears to be almost entirely confined to someone putting on a rig and then going out for a ride with a receiver to see how far it can be heard.

New tubes recently announced bring multi-stage transmitter design within the realm of practicability. Thus far, only W3GLV and W6QLZ have reported attainment of crystal control on 224 Mc. The new, but expensive, 829 and 1628 make this a cinch — if you have the price. Other tubes which have possibilities are the new HY-75, and even the old standbys, the HK-24, 54, and 35T.

# HAM-ADS

(1) Advertising shall pertain to radio and shall be of nature of interest to radio amateurs or experimenters in their pursuit of the art.

(2) No display of any character will be accepted, nor can any special typographical arrangement, such as all or part capital letters be used which would tend to make one advertisement stand out from the others.

(3) The Ham-Ad rate is 15¢ per word, except as noted in paragraph (6) below.

(4) Remittance in full must accompany copy. No cash or contract discount or agency commission will be allowed.

(5) Closing date for Ham-Ads is the 25th of the second month preceding publication date.

(6) A special rate of 7¢ per word will apply to advertising which, in our judgment, is obviously non-commercial in nature and is placed and signed by a member of the American Radio Relay League. Thus, advertising of bona fide surplus equipment owned, used and for sale by an individual or apparatus offered for exchange or advertising inquiring for special equipment, if by a member of the American Radio Relay League takes the 7¢ rate. An attempt to deal in apparatus in quantity for profit, even if by an individual, is commercial and all advertising by him takes the 15¢ rate. Provisions of paragraphs (1), (2), (4) and (5) apply to all advertising in this column regardless of which rate may apply.

Having made no investigation of the advertisers in the classified columns, the publishers of *QST* are unable to vouch for their integrity or for the grade or character of the products advertised

**QUARTZ** — direct importers from Brazil of best quality pure quartz suitable for making piezo-electric crystals. Diamond Drill Carbon Co., 719 World Bldg., New York City.

**QSL's** — samples. Brownie, W3CJL, 523 No. Tenth St., Allentown, Pa.

**CRYSTALS**, mounted, 80-160, \$1.25, V-cut 40, \$2.25. R9 Crystals, 338 Murray Ave., Arnold, Pa.

All communication equipment at lowest prices. Sale on used receivers, write for list and details. W9KJF, Van Sickle, 34 W. Ohio St., Indianapolis, Ind.

**QSL's**, Maps, Cartoons. Free samples. Theodore Poncher, 7708 Navahoe, Philadelphia, Pa.

**USED** receivers. Bargains. Cash only. No trades. Price list 3¢. W3DQ, Wilmington, Del.

**QSL's**. Samples. W9RUJ, Auburn, Nebr.

**CALLBOOKS** — Summer edition now on sale containing complete up-to-date list of radio hams throughout entire world. Also world prefix map, and new time conversion chart. Single copies \$1.25. Canada and foreign \$1.35. Radio Amateur Call Book, 610 S. Dearborn, Chicago.

**CRYSTALS**: famous P.R., mounted in latest Alsimag 35 holders — 40, 80 meter PR-X, 160 meter PR-Z, \$3; 40, 80 meter PR-Z (low drift), \$3.50; 20-meter PR-20, \$4.50; unconditionally guaranteed. Immediate shipment. Wholesale Radio Labs., Council Bluffs, Iowa, W9GFQ.

**SHURE** 5B double-button carbon mikes — \$3.49, postpaid; mike rings with springs, 49¢; combination — \$3.75 postpaid. W8RRL, Dymac Radio, 1531 Main St., Buffalo, N. Y.

**FOR** sale: Collins 30FXB phone transmitter. No reasonable offer refused. W9AR.

**BRAZILIAN** quartz — importers of highest quality tested quartz suitable for cutting piezo-electric crystals. Donald M. Murray Co., 38 Pearl St., N. Y.

**QSL's**, all colors, cartoons, snappy service. Write for free samples today. W1BEF, 78 Warrenton, Springfield, Mass.

**CRYSTALS** in plug-in heat dissipating holders. Guaranteed good oscillators. 160M-80M, \$1.25. (No Y cuts.) 40X, \$1.65. 80M vari-frequency (5 kilocycle variance) complete, \$2.95. State frequency desired. C.O.D.'s accepted. Pacific Crystals, 1042 S. Hicks, Los Angeles.

**QSL's** — SWL's. 100, 3 color, 75¢. Lapco, 344 W. 39th, Indianapolis, Ind.

**TELEFLEXES**, Instructographs bought, sold. Ryan's, Hannibal, Mo.

**CRYSTALS** — police, marine, aircraft, amateur. Catalog on request. C-W Mfg. Co., 1170 Esperanza, Los Angeles.

**QST's** wanted, 1916 issues, February, March, May, June. WIKKE, Providence, R. I.

**HALF** kilowatt transmitter. Hammarlund receiver. Complete, \$180. George Bigler, 1601 Wayne, Topeka, Kansas.

W2HNA selling out. One kw. fone rig complete, or parts separately. RME-69 with DB-20. One ten receiver. Many parts and accessories, also laboratory equipment offered for any reasonable price. Write for list. E. B. Clegg, 193 Greylock Parkway, Belleville, N. J.

**QSL'S?** — SWL's? Orders printed same day received. Samples? W8DED, Holland, Mich.

**WANTED**: one set Rider Manuals. W3EQZ.

**CRYSTALS** — 160-80 m. crystal, \$1. 160-80 m. crystal mounted in ceramic holder, \$1.75. Koradio, Mendota, Ill.

**QSL** — SWL. July prices down. Fritz, 455 Mason, Joliet, Ill.

**SELL** — 100 w. T-55 rig with power supply, fone & CW, less modulator, install locally. Also DuMont 154 oscilloscope, both \$50. Write, phone W2BOA.

**DOUGLAS** Universal modulation transformers. 50 watts audio, \$4.95 pair; 100 watts audio, \$7.75 pair. Postpaid. One year guarantee. Details write W9FKR, Box 349, Rice Lake, Wis.

**QSL'S**. Finest. Free samples. Maleco, 1805 St. Johns Place, Brooklyn, N. Y.

**CRYSTALS**: amateur, commercial, experimental. Send requirements for quotation. Ham crystals, 1104 Lincoln Place, Brooklyn, New York.

**WANTED**: Used RME-69. W1KRB.

**FOR** sale — new recording equipment. W2IEF, Irvington, N. J.

**QSL's** — SWL's. Colorful, economical. W9KXL — W9QKS, 819 Wyandotte, Kansas City, Mo.

**CRYSTALS** — modern cuts \$1. Byers Crystals, Indiana, Pa.

**CANDLER** course (Advanced), Fundamentals of Radio (Terman), Radio Manual (latest), Practical Radio Communication, bug for camera, English-type bicycle, wardrobe trunk, or ??? Write W9UUV.

**SACRIFICE** — a.c. — d.c. motor-generator. Ideal for emergency rig. Used only 5½ hrs. New \$68. Need money so best cash offer takes. F.O.B. W9NMA, Lamoni, Iowa.

**TRADE**: QST's March 1925 to 1940 — FB7A — 4 coils — #1750 Powerpack. Want 6X9 printing press — type and stamp collection. Postcard to Amos, 2710 N. Wash. Blvd., Arlington, Va.

**QSL'S**. W8JOT, Box 1111, Rochester, N. Y.

**SELL** 250 watt phone — 450 watt CW transmitter, never used. Relay rack construction, highest quality parts. Separate 15 watt speech amplifier. \$250 cash. Details on request, Box 293, Barberton, Ohio.

**CRYSTALS**, commercial or amateur: aircraft, police, marine, and all types for commercial services at attractive prices. Write for catalog. For the amateur: those time-proven, fully guaranteed T-9 crystals, 40, 80, and 160 meter bands, \$1.60 postpaid — close frequency choice. T-9 ceramic holders, \$1. C.O.D.'s accepted. Sold by: Henry Radio Shop, Butler, Mo.; Frank Mayer Co., Corpus Christi, Texas; Pemberton Labs., Ft. Wayne, Ind.; Kerr Radio Shop, El Paso, Texas; Frank Ansalone, 375 W. 46th, N. Y. C.; Cass Edison, Havana, Cuba; or Eidson's, Temple, Texas.

**ONE** quarter kilowatt CW station complete — National receiver — sell separately. W8SMH, 47 Haendel, Binghamton, N. Y.

**QSL'S**. Need a new batch? Write W1CJD, Gildersleeve, Conn. for samples.

100 watt modulator with speech and power \$35. 75 watt 200 watt and 400 transmitters at bargains. Frampton Radio, Blackwell, Okla.

**NEW** Utah 5-10-20 kits, \$69 value, \$49. Van Sickle, W9KJF Indianapolis, Ind.

**WANTED**: back issues of I.R.E. Proceedings to complete file. 1929 — February, July, Sept.; 1930 — March. R. J. Davis Lanthicum Heights, Md.

**RECONDITIONED** transmitters, receivers, at lowest prices. Special terms: 5-10-20 Utah transmitters, new, original cartons, \$49.50; Utah Jr. complete, \$19.50; 550 v. supplies new, only \$10; many other real bargains. Special — new Howard 460 receivers, original cartons, with crystal, \$59.95. Write Leo, W9GFQ, today.

**FELLOWS**. Lowest prices on new and used equipment. Aluminum beam tubing — 12' lengths, two sizes, 90¢ and 98¢; 70 watt rigs only \$35; 35 watt modulators \$25 complete. Write to Leo, W9GFQ, for your ham wants. Wholesale Radio Labs., Council Bluffs, Iowa.

**WESTON** meters, bakelite case, \$4. each. Four type 425 thermomilliammeters 120 ma. One 250 ma. Two 301, 200 microamperes. Two 301 milliamperes. Jewell type 25 200 microamperes. W. K. Caughy, 20 Glenwild Rd., Madison, N. J.

**STEP** up those signals 10, 15, 20 times. Our 3 or 4 element beam does the trick. Hi-Torque, All-Steel Rotator, AluAlloy elements, Selsynchronous Indicator. Photos, bulletins. Rotary Array Service, W8ML.

BEST place to get amateur receivers, transmitters, parts is W9ARA. Most complete stock, lowest prices, best trade-in allowances, best terms (financed by myself and arranged to suit you), personal cooperation so that you are 100% satisfied. Write and tell me what you want and how you want everything handled. Bob Henry, W9ARA, Butler, Mo.

RECONDITIONED guaranteed amateur receivers at lowest prices. All models. Shipped on free trial. Terms with no red tape. Write Bob Henry, W9ARA, for big free list.

HALLICRAFTER SX-23s \$79.50. Reconditioned at factory, like new, brand-new receiver guarantee, trade-ins accepted, terms available. Send \$5. deposit and will ship on ten-day free trial. W9ARA.

NEED quick cash — Pair RCA-813s \$35. National NTE-C exciter \$50. 1 kw. Thordarson T19P68 \$18. W6PHS.

COMPLETE Ham station, everything new, for \$54.06 — UTC SX25 kit, \$22.56 with tubes, xtal, meter — Hallcrafters Sky Buddy, \$29.50 — Mac key, \$1. — Easy terms. Seeli's Radio, Hartford, Conn.

# RADIO

**ENGINEERING**, broadcasting, aviation and radio telegraphy and telephony, Morse telegraphy and railway accounting taught thoroughly. 48 weeks' engineering course, equivalent to three years of college radio work. School established 1874. All expenses low. Catalog free.

DODGE'S INSTITUTE, Day Street, Valparaiso, Indiana

## Piezo-Electric Crystals Exclusively

• Quality crystals of all practical frequencies supplied SINCE 1925. Prices quoted upon receipt of your specifications.

Our Pledge: **QUALITY FIRST**

### SCIENTIFIC RADIO SERVICE

"The Crystal Specialists Since 1925" University Park, Hyattsville, Md.

**NEW!**

## GORDON QSL CARD ALBUM

The new, de luxe way to keep your QSL cards. A handsome loose-leaf book with rich, red morocco grain cover, gold-embossed. Individual gold call letters furnished. Keeps QSL cards clean and safe. Capacity, 100 strong pages, each holding 4 cards.

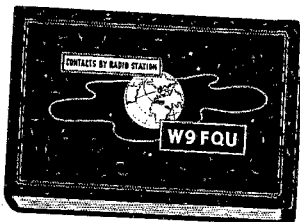

An impressive book that you will always treasure. Complete with 50 pages, only \$2.50 at your jobbers.

### Gordon RF Relay

Full 1/2 inch contact spacing with husky 3/4" silver contacts. Easily handles 1 KW Heavy duty, relay for Antenna Changerover, Multi-Bank Trans. Tank Switching and 60 cycle Power Switching. Ideal for Beam Ant. Alsimag 196 RF Insulation. 110 V AC. Only \$9.00 net.

See Your Jobber or Write for Details

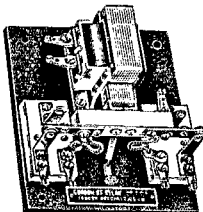

## GORDON SPECIALTIES CO.

1104 South Wabash Ave.

Chicago, Ill.

## RADIO TECHNOLOGY



RCA Institutes offer an intensive course of high standard embracing all phases of Radio and Television. Practical training with modern equipment at New York and Chicago Schools. Also specialized courses and Home Study Courses under "No obligation" plan.

Illustrated Catalog on request

**RCA INSTITUTES, INC.** Dept. ST-40

A Radio Corporation of America Service

75 Varick St., New York

1154 Merchandise Mart, Chicago

# Noticia

Como en años anteriores, la editorial "Revista Telegráfica" de Buenos Aires, la más importante de Hispano-América en técnica de radio, ha traducido y editado en castellano nuestro "THE RADIO AMATEUR'S HANDBOOK" edición 1940.

La fiel y cuidada traducción de las ediciones anteriores, confiada a ingenieros argentinos, se repite este año y se completa también con una impresión lujosa y esmerada.

La edición 1940 del "THE RADIO AMATEUR'S HANDBOOK" contiene el mejor material que puede ofrecerse a un aficionado y con objeto de facilitar la búsqueda de la información que se desea, se ha dividido en varias secciones, agrupando en ellas los temas con la mayor prolijidad. Es, en consecuencia, Un Manual cien por ciento dedicado al aficionado y por lo tanto indispensable en su biblioteca.

"THE RADIO AMATEUR'S HANDBOOK" en Castellano puede remitirlo la American Radio Relay League, West Hartford, Conn., E.U. de N.A. a razón de \$1.50 el ejemplar libre de porte o "Revista Telegráfica," Perú 165, Buenos Aires, Argentina por \$5 moneda argentina.

## AMERICAN RADIO RELAY LEAGUE

# Your Nearby Dealer Is Your Best Friend

Your nearby dealer is entitled to your patronage. He is equipped with a knowledge and understanding of amateur radio. He is your logical source of advice and counsel on what equipment you should buy. His stock is complete. He can supply your needs without delay. His prices are fair and consistent with the high quality of the goods he carries. He is responsible to you and interested in you.

One of these dealers is probably in your city—Patronize him!

<p><b>ATLANTA, GEORGIA</b> Radio Wire Television Inc. 265 Peachtree Street "The World's Largest Radio Supply House"</p>	<p><b>JAMAICA, L. I., NEW YORK</b> Radio Wire Television Inc. 90-08 166th Street (Merrick Road) "The World's Largest Radio Supply House"</p>
<p><b>BALTIMORE, MARYLAND</b> Radio Electric Service Co. 3 N. Howard St. Everything for the Amateur</p>	<p><b>NEWARK, N. J.</b> Radio Wire Television Inc. 24 Central Avenue "The World's Largest Radio Supply House"</p>
<p><b>BOSTON, MASS.</b> Radio Wire Television Inc. 110 Federal Street "The World's Largest Radio Supply House"</p>	<p><b>NEW YORK, N. Y.</b> Radio Wire Television Inc. 100 Sixth Avenue "The World's Largest Radio Supply House"</p>
<p><b>BRONX, NEW YORK</b> Radio Wire Television Inc. 542 East Fordham Road "The World's Largest Radio Supply House"</p>	<p><b>NEW YORK, N. Y.</b> Harrison Radio Company 12 West Broadway Harrison Has It! Phone WOrth 2-6276 for information or rush service</p>
<p><b>BUFFALO, NEW YORK</b> Radio Equipment Corp. 326 Elm Street W8PMC and W8NEL — Ham, service and sound equipment</p>	<p><b>PHILADELPHIA, PENNSYLVANIA</b> Eugene G. Wile 10 S. Tenth Street Complete Stock of Quality Merchandise</p>
<p><b>BUFFALO, NEW YORK</b> Dymac Radio 1531 Main Street — Cor. Ferry Open Evenings GA. 0252</p>	<p><b>PROVIDENCE, RHODE ISLAND</b> W. H. Edwards Company 85 Broadway National, Hammarlund, Hallicrafter, Thordarson, Taylor, RCA</p>
<p><b>HARTFORD, CONNECTICUT</b> Radio Inspection Service Company 227 Asylum Street What do you want? We have it. Radio exclusively</p>	<p><b>RICHMOND, VIRGINIA</b> The Arnold Company Broad at Harrison St. W3EQQ — "The Virginia Ham Headquarters" — W3FBL</p>
<p><b>HOUSTON, TEXAS</b> R. C. &amp; L. F. Hall 4021 Huey Street (W 9-2713) "Specialists in Amateur Supplies"</p>	<p><b>SCRANTON, PENNSYLVANIA</b> Scranton Radio &amp; Television Supply Co. 519-521 Mulberry Street Complete Stock of Quality Amateur Supplies</p>

YOU CAN BE SURE  
WHEN YOU BUY FROM

**QST**

ADVERTISERS

“Advertising for *QST* is accepted only from firms who, in the publisher’s opinion, are of established integrity and whose products secure the approval of the technical staff of the American Radio Relay League.”

*Quoted from QST’s advertising rate card.*

*Every conceivable need of a radio amateur can be supplied by the advertisers in QST. And you will know the product has the approval of the League’s technical staff*

*Index to Advertisers*

Abbott Instrument, Inc.	86
American Radio Institute	93
Astatic Microphone Laboratory, Inc.	101
Barker & Williamson	90
Billiey Electric Company	62, 106
Candler System Company	90
Capitol Radio Engineering Institute	102
Cardwell Mfg. Corp., Allen D.	74
Centralab	87
Collins Radio Company	Cov. 2
Daven Company, The	76
Dodge’s Institute	108
Eitel-McCullough, Inc.	69
Gardiner-Levering Company	93
General Electric Company	9
Gordon Specialties Company	108
Hallcrafters, Inc., The	1, 2, 4, 5, 6, 7
Hammarlund Mfg. Company, Inc.	63, 65, 67
Harrison Radio Company	92
Harvey Radio Company	96
Heintz & Kaufman, Ltd.	66
Henry Radio Shop	99
Hipower Crystal Company	94
Instructograph Company	94
Jensen Radio Mfg. Company	95
Ken-Rad Tube & Lamp Corp.	93
Kenyon Transformer Company, Inc.	70
Mallory & Company, Inc., P. R.	60
Massachusetts Radio School	94
Meissner Mfg. Company, Inc.	97
Millen Mfg. Company, Inc., James	73
National Company, Inc.	Cov. 3, 59, 71, 93
New York YMCA Schools	80
Newark Electric Company	103
Nilson Radio School	86
Ohmite Mfg. Company	98
Pioneer Gen-E-Motor Corp.	98
Port Arthur College	78
Precision Apparatus Corp.	102
Precision Piezo Service	78
RCA Institutes, Inc.	108
RCA Mfg. Company, Inc.	Cov. 4, 61, 75, 79, 106
Radio Control Headquarters	93
Radio Mfg. Engineers, Inc.	111
Radio Shack, The	81
Radio Transceiver Laboratories	100
Scientific Radio Service	108
Shuler Supply Company	100
Sickles Company, F. W.	94
Solar Mfg. Corp.	72
Southwest Radio Supply	81
Sun Radio Company	100
Taylor Tubes, Inc.	77
Telex Company	80
Terminal Radio Corp.	104
Thordarson Electric Mfg. Company	91
Triplett Electrical Instrument Company, Inc.	64
United Transformer Corp.	112
Wholesale Radio Laboratories	81
Yaxley	60



# COMPLETE COVERAGE

## 90 KILOCYCLES—60 MEGACYCLES

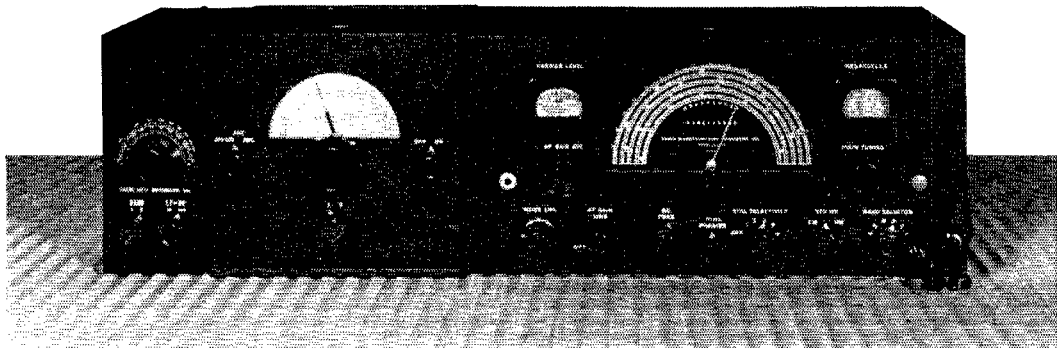

*Instantaneous Finger-Tip Control of  
Low, Medium or High Frequency Tuning*

**CONVENIENT . . . SELECTIVE . . . EFFICIENT**

Imagine tuning all frequencies from 90 kilocycles to 60 megacycles, efficiently and accurately from one receiving position, with never a thought to peaking critical circuits, plug-in inductances or complicated switching arrangements. Imagine having at your finger-tips the finest superheterodyne type receiver for reception of almost everything to be heard in the present day radio spectrum.

You can have all this and more when you assemble RME units as we have them pictured above. The basic, foundation unit is the new RME-99, outstanding precision communications receiver. The unit at the extreme left is the LF-90 LOW FREQUENCY INVERTER which permits reception of all channels from 90 to 600 kilocycles. The center unit is the DM-30X BAND EXPANDER designed to expand the RME-99's frequency cov-

erage to include all channels up to and including 60 megacycles (or the DM-36 for specific ham band coverage of 28 and 60 MC permitting extended bandsread tuning).

This line-up presents a truly commercial control panel with every adjustment for precise and efficient FULL RANGE reception. In this modern era of diversified radio reception, the receiver which does not receive *all* the useful communication channels, is a receiver of incomplete capability.

In buying your new receiving equipment, check its tuning range for FULL COVERAGE. Make certain it is COMPLETE. A combination of RME receiving units assures you of COMPLETE tuning. Write us today for complete information, and be satisfied in the long run.

Radio Mfg. Engineers  
— Inc. —

**RME**  
TIME WILL TELL

111 Harrison Street  
Peoria, Illinois

# Unprecedented Values IN MODULATION UNITS

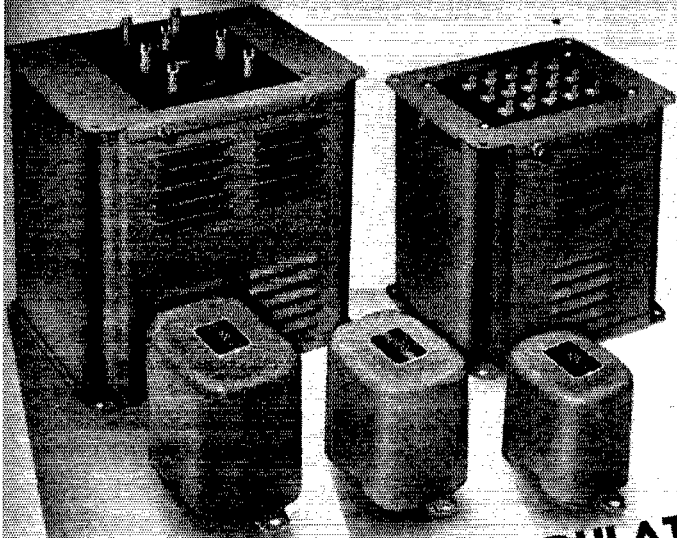

The UTC Special Series includes Audio Transformers for input, matching, driver, and output applications of every type. These units, expressly designed for amateur service, set a new standard of value per dollar. They are attractively housed and ruggedly constructed, with mounting facilities suitable for chassis or breadboard type equipment.

## FOR PLATE MODULATION

- Any modulator tubes to any R F load... plate modulation
- S-18 up to 12 watts audio, net \$2.10
  - S-19 up to 30 watts audio, net \$2.85
  - S-20 up to 55 watts audio, net \$3.90
  - S-21 up to 110 watts audio, net \$6.00
  - S-22 up to 250 watts audio, net \$8.40

## FOR NEW GRID-CATHODE MODULATION

- From all popular tubes to Grid and Cathode
- GCM-2 up to 15 watts audio, net \$ 3.00
  - GCM-3 up to 30 watts audio, net \$ 4.50
  - GCM-4 up to 60 watts audio, net \$ 6.90
  - GCM-5 up to 200 watts audio, net \$13.50
  - GCM-6 up to 110 watts audio, net \$10.00
  - GCM-1 up to 30 watts audio, from 200 or 500 ohm line, net \$ 4.80

## FOR NEW CATHODE-MODULATION

- From all popular tubes; with tapped secondary to match cathode
- CM-15 up to 15 watts audio, net \$2.40
  - CM-16 up to 35 watts audio, net \$3.30
  - CM-17 up to 100 watts audio, net \$7.20
  - CM-18 up to 12 watts audio, from 200 or 500 ohm line, net \$2.40

# UNITED TRANSFORMER CORP.

Write: COMMUNICATIONS DIV. ★ 150 VARICK ST. ★ NEW YORK, N. Y.  
 EXPORT DIVISION: 100 VARICK STREET NEW YORK, N. Y. CABLES: "ARLAB"

## Revolutionary QRM Piercer?

That's what they call our VT-10 Band Pass Filter (described in December QST).  
 So good, others are already copying

QST for July, 1940, EASTERN Edition

PRINTED IN U. S. A.  
 RUMFORD PRESS  
 CONCORD, N. H.

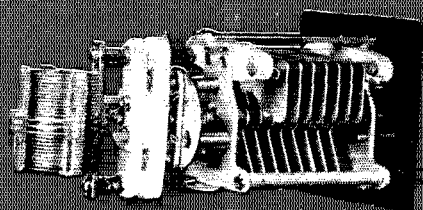

PANEL MOUNT  
COIL REAR

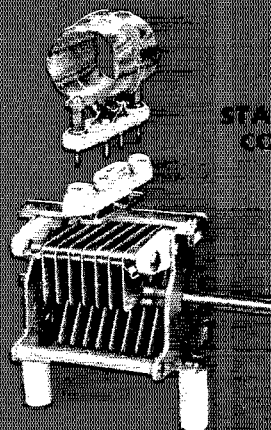

STAND-OFFS  
COIL TOP

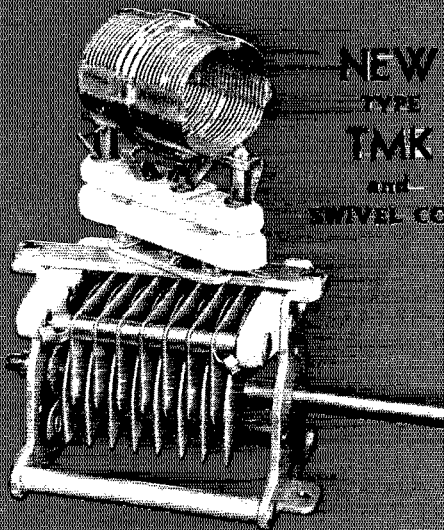

NEW  
TYPE  
TMK  
and  
SWIVEL COIL

NEW CONVENIENCE!

NEW FLEXIBILITY!

# NEW TMK CONDENSER!

compact construction  
panel or stand-off mounting  
swivel coil mount  
coil mounts at top or rear  
uses AR-16 coils or XR-16 forms  
low loss construction  
aluminum plates

**NATIONAL COMPANY, INC., MALDEN, MASS.**

Capacity	Min. Cap.	Air-Gap	Catalog Symbol	List Price	Amateur Net
35	7.5	.047	TMK-35	\$3.25	\$1.95
50	8.	"	TMK-50	3.50	2.10
75	9.	"	TMK-75	3.75	2.25
100	10.	"	TMK-100	4.00	2.40
150	10.5	"	TMK-150	4.50	2.70
200	11.	"	TMK-200	5.00	3.00
250	11.5	"	TMK-250	5.50	3.30
35-35	7.5-7.5	.047	TMK-35D	5.25	3.15
50-50	8-8	"	TMK-50D	5.75	3.45
100-100	10-10	"	TMK-100D	7.25	4.35
Prices do not include coil. Extra for swivel coil hardware.				.15	.09

*for the amateur*



"CQ-ing" the Television world

## Amateur Iconoscope RCA-1847

Just announced by RCA—designed and licensed specifically for amateur and experimental use—engineered by the same men who produced the larger Iconoscopes—this "Mini-ike" paves the way for a brand new thrill for the radio pioneer. In size it is 7 $\frac{1}{4}$ " long, with a 2" face on which the images are focused. The free booklet mentioned below includes full specifications, with circuit diagrams and equipment information.

Amateur Net Price . . . . . \$24.50

## New Thrills, New Adventures for the Radio Pioneer . . . .

The experimental equipment pictured on this page was designed and constructed by RCA engineers to illustrate the possibilities of the new RCA-1847 Iconoscope in Amateur Television. Demonstrated in actual operation, this equipment was the hit of the Chicago Parts Show. Most amateurs already have many of the required components. And, even though you start from "scratch," it is possible to duplicate this system for no more than the cost of a medium-power transmitter!

Images are 30 frame, 120 line; require a total band width of less than 0.4 Mc, and are amazingly clear and stable. Operation is on the 2 $\frac{1}{2}$ -meter band where there is plenty of room. See articles in May and June QST for further details.

FREE! A new booklet, hot off the press, containing complete data on how to build this complete Television Rig is yours for the asking. Get one from your nearest RCA Amateur Equipment Jobber, or write to RCA Commercial Engineering Section, Harrison, N. J.

See Page 75 for Announcement of RCA HAM GUIDE

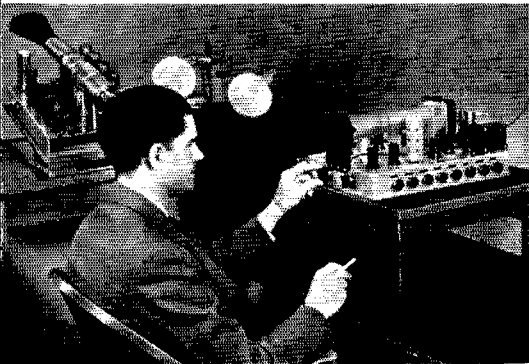

Think of the thrill of seeing the fellow amateur you've been talking with — of pioneering your way to new air adventures!



*for  
Amateur*

# TELEVISION