

# QST

January, 1941

25 cents

35c in Canada

devoted entirely to

# amateur radio



*In This Issue—Efficient Pocket-Size Transmitters*

# COLLINS 12Y

## REMOTE AMPLIFIER

**SIZE:** 3¾" high x 6¼" wide x 7" deep.

**WEIGHT:** 4¾ lbs. without attachment cord.

**NUMBER OF CHANNELS:** One.

**GAIN:** 84 decibels, maximum.

**INPUT IMPEDANCE:** Modified Collins Universal Input System giving 30/50 ohms, 200/250 ohms or direct to grid of tube. Change of impedance is accomplished by a simple internal wiring modification.

**OUTPUT IMPEDANCE:** 500 ohms.

**POWER OUTPUT:** Plus 8 decibels at 1.0% distortion.

**TUBES USED:** 1—6F5, 3—6C5, 1—6X5.

**FREQUENCY RESPONSE:** Uniform within 1 decibel from 40 to 10,000 c.p.s.

**GAIN CONTROL:** High resistance potentiometer with control knob on panel. Semi-adjustable control furnished on special order.

**FINISH:** Both panel and cover are finished in black anodic aluminum.

**CARRYING CASE:** A hard leather carrying case with shoulder strap may be obtained as an accessory. The size is 7" high x 7" wide x 7½" deep. It weighs 2 pounds, 3 ounces.

**POWER SUPPLY:** The rectifier and filter system is self-contained for a-c operation. The power transformer is external and is part of the attachment cord furnished with the amplifier. The weight is 2 pounds, 11 ounces complete.

*Equip your broadcast station with the latest in remote amplifiers — COLLINS NEW 12Y.*

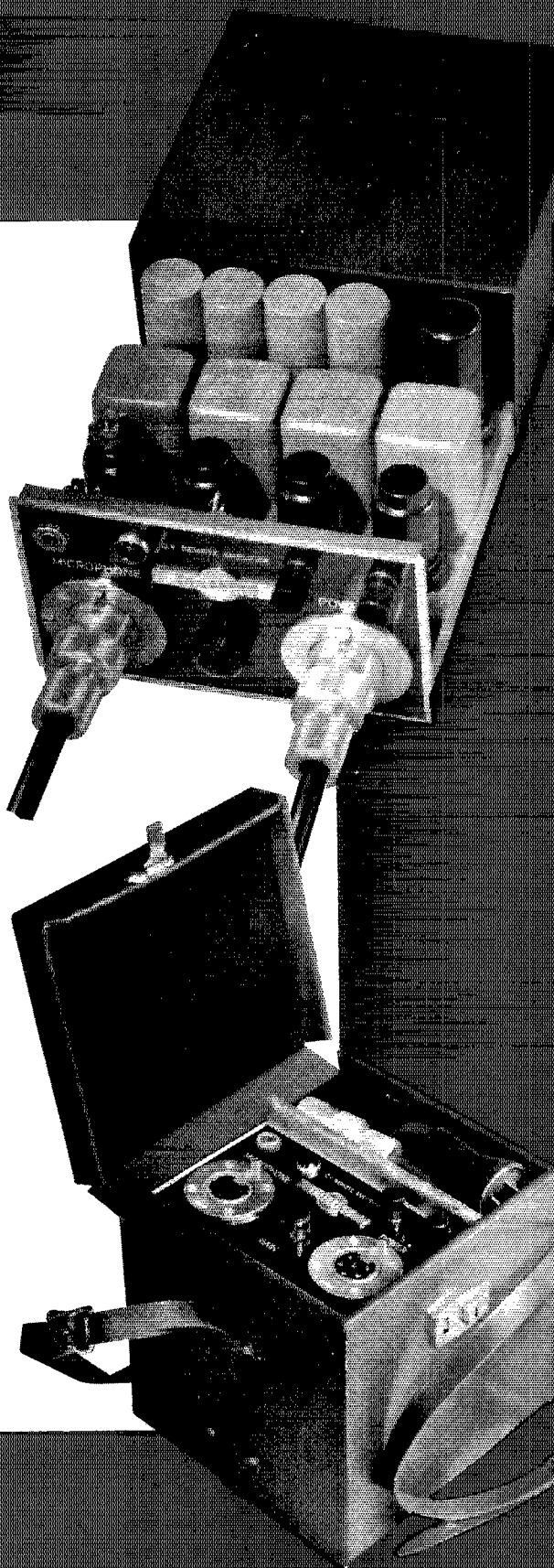

**COLLINS RADIO COMPANY**

CEDAR RAPIDS, IOWA  
NEW YORK, N.Y., 11 WEST 41 ST.

# New High Fidelity FM-AM TUNER

**MODEL S-31**  
High Fidelity  
Tuner for  
Frequency  
Modulation  
and Amplitude-  
Modulated Reception.



**N**OW you can have FM-AM reception by a turn of the bandswitch with the Model S-31 Hallicrafters commercial FM-AM Tuner. Covering the broadcast (AM) band and the 40-51 mc. high frequency (FM) band. The Tuner combines the FM and AM circuits in one chassis with either instantly available at the turn of the bandswitch.

**SPECIFICATIONS**—9 tubes—Frequency range, band one; 550 to 1600 kc., band two; 40 to 51 mc.—Power output 130 milliwatts undistorted—Output impedances 500 and 5000 ohms—Power consumption 120 watts—Controls: bandswitch, radiophone switch, main tuning, audio gain, tone control, "S" meter adjustment, phone jack. Operating from 115-125 volts, 60 cycles AC. Panel dimensions 19" x 8 $\frac{3}{4}$ ". Dust cover dimensions 17" x 8 $\frac{3}{4}$ " x 11 $\frac{1}{8}$ ". Write for prices.

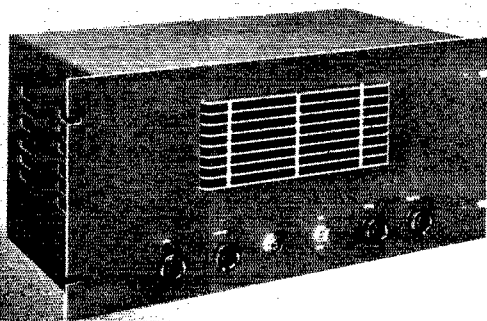

## AMPLIFIER FOR MODEL S-31 TUNER

The Model S-31, a Hallicrafters amplifier, delivers 25 watts of high fidelity audio power to either speaker or 500 ohm load. Designed for rack mounting and for use as a companion unit to the FM-AM Model S-31 Tuner it will provide reproduction of sparkling depth and brilliance.

**SPECIFICATIONS**—6 tubes—Fidelity 2 DB from 50 to 15,000 cycles gain—Channel No. 1, microphone (high impedance) 96 DB—Channel No. 2, phone (low impedance) 60 DB—Power output 25 watts—Power consumption 100 watts—Output impedance No. 1, 500 ohms; No. 2, 8 ohms; No. 3, 4 ohms. Dimensions: panel 19" x 8 $\frac{3}{4}$ ". Dust cover 18" x 8 $\frac{3}{4}$ " x 10". Write for prices.

the hallicrafters inc.

USED BY 33 GOVERNMENTS . . . SOLD IN 89 COUNTRIES



## *for Christmas*

Over two thousand years ago, a small group of men wearily toiled across miles of desert bearing gifts and greetings to an unknown, newly-born babe who lay in the rudely built manger of an old barn. Those men were the forebearers of our present day Christmas message. They were the pioneers who established a custom which has been, and will continue to be, honored until the end of time.

In reverence and memory of that greatest of all holidays, we take much pleasure in extending our sincere good wishes and hearty greetings to you and all of yours for the merriest Christmas you have ever known. And for good measure, we wish that each day of 1941 will bring to you new happiness and prosperity.



*the hallicrafters inc.*



JANUARY 1941

VOLUME XXV

NUMBER 1



STAFF

Editorial

KENNETH B. WARNER, W1EH  
Editor and Business Manager

CLARK C. RODIMON, W1SZ  
Managing Editor

GEORGE GRAMMER, W1DF  
Technical Editor

DONALD H. MIX, W1TS  
BYRON GOODMAN, W1JPE  
Assistant Technical Editors

EDW. P. TILTON, W1HDQ  
Contributing Editor, U.H.F.

VERNON CHAMBERS, W1JEQ  
Technical Information Service

JAMES J. LAMB, W1AL  
Research Engineer, A.R.R.L.

Advertising

F. CHEYNEY BEEKLEY, W1GS  
Advertising Manager

CHARLES BRUNELLE  
Asst. Advertising Manager

Circulation

DAVID H. HOUGHTON  
Circulation Manager

RALPH T. BEAUDIN, W1BAW  
Asst. Circulation Manager



OFFICES

38 La Salle Road  
West Hartford, Connecticut

Subscription rate in United States and Possessions, \$2.50 per year, postpaid; all other countries, \$3.00 per year, postpaid. Single copies, 25 cents. Foreign remittances should be by international postal or express money order or bank draft negotiable in the U. S. and for an equivalent amount in U. S. funds.

Entered as second-class matter May 29, 1919, at the post office at Hartford, Connecticut, under the Act of March 3, 1879. Acceptance for mailing at special rate of postage provided for in section 1103, Act of October 3, 1917, authorized September 9, 1922. Additional entry at Concord, N. H., authorized February 21, 1929, under the Act of February 28, 1925. Additional second-class entries to cover sectional editions authorized March 20, 1935.

Copyright 1940 by the American Radio Relay League, Inc. Title registered at United States Patent Office.

# QST

devoted entirely to

# AMATEUR RADIO

PUBLISHED MONTHLY, AS ITS OFFICIAL ORGAN, BY THE AMERICAN RADIO RELAY LEAGUE, INC., AT WEST HARTFORD, CONN., U. S. A.; OFFICIAL ORGAN OF THE INTERNATIONAL AMATEUR RADIO UNION



## CONTENTS

Editorial . . . . .	7
The "Variarm 150" . . . . . Henry E. Rice, Jr., W9YZH	8
Pocket-Size Complete Transmitters . . . Keith Hayes, W9ZGD R. T. Lawrence, W8LCO	12
Keying Monitors . . . . . Don H. Mix, W1TS	15
What the League Is Doing . . . . .	18
Some Notes on Fidelity . . . . . Herbert Brooks, W9SDG	20
An Amateur Application of the Wien Bridge R. Wade Caywood, W1KRD	22
UHF Marathon for 1941 . . . . . F. E. Handy, W1BDI	24
Silent Keys . . . . .	25
A.V.C. for C.W. Reception . . . . . Edward H. Weber, W2GRD	26
Fifth UHF Contest Successful James R. Buckler, Jr., W9NFL	29
Why Not Parallel Feed? . . . . . T. M. Ferrill, Jr., W1LJI	30
Prediction of Useful Distances for Amateur Radio Communication in January, February and March, 1941 . . . . .	32
Book Review . . . . .	33
A.R.R.L. Party . . . . .	34
25 Years Ago This Month in QST . . . . .	35
On the Ultra Highs . . . . . E. P. Tilton, W1HDQ	36
November Storms Create Communication Emergencies George K. Pritchard	39
Hints and Kinks for the Experimenter Simple 28-Mc. Vertical Antenna — Oscillator Keying Circuit for Click Elimination — An Easy Way to Raise a Mast — Another Glass-Tubing Feeder Spreader — E.C.O. Coupling Circuit . . . . .	40
Correspondence from Members . . . . .	43
Operating News . . . . .	44
Radio Amateurs Help in Gale . . . . .	46
Meet the S.C.M.'s . . . . .	47
Brass Pounders' League . . . . .	47
How's DX? . . . . .	48
Station Activities . . . . .	68
Hamads . . . . .	88
QST's Index of Advertisers . . . . .	94

## Section Communications Managers of the A.R.R.L. Communications Department

All appointments in the League's field organization are made by the proper S.C.M., elected by members in each Section listed. Mail your S.C.M. (on the 16th of each month) a postal covering your radio activities for the previous 30 days. Tell him your DX, plans for experimenting, results in phone and traffic. He is interested, whether you are an A.R.R.L. member or get your QST at the newsstands; he wants a report from every active ham. If interested and qualified for O.R.S., O.P.S. or other appointments he can tell you about them, too.

ATLANTIC DIVISION				
Eastern Pennsylvania Maryland-Delaware-District of Columbia Southern New Jersey Western New York Western Pennsylvania	W3BES W3CIZ W3CCO W8PLA W8CKO	Jerry Mathis Hermann E. Hobbs Lester H. Allen Fred Chichester E. A. Krall	6042 Master St. 9701 Monroe St. Silver Spring P.O. 704 Quinton Ave. 703 Broadway	Philadelphia Linden, Maryland Trenton Soyea East McKeesport
CENTRAL DIVISION				
Illinois Indiana Kentucky Michigan Ohio Wisconsin	W91LH W9AB W9ARU W8DPE W8AQ W9UUT	Mrs. Carrie Jones Harry B. Miller Darrell A. Downard Harold C. Bird E. H. Gibbs Aldrich C. Krones	2407 Central Ave. 729 E. Lowell Ave. 116 N. Longworth Ave. R.F.D. 2 405 Broad St. 2702 So. 46th St.	Alton Mishawaka Louisville Pontiac Wadsworth Milwaukee
DAKOTA DIVISION				
North Dakota South Dakota Northern Minnesota Southern Minnesota	W9WWL W9ADI W9IGZ W9Y9Q	Anton C. Theodos E. C. Mohler Edwin L. Wicklund Millard L. Bender	Box 444 R.D. 149 R.F.D. 3 608 N. Huron Ave.	Williston Rapid City Kensington Spring Valley
DELTA DIVISION				
Arkansas Louisiana Mississippi Tennessee	W5ABI W5DWW W5EWD W4DDJ	H. E. Vette W. J. Wilkinson, Jr. Jewell W. Cole M. G. Hooper	4415 West 12th St. Room 313, Jefferson Hotel % City of McComb Water Dept. 4908 Georgia Ave.	Little Rock Shreveport McComb City Nashville
HUDSON DIVISION				
Eastern New York N. Y. C. & Long Island Northern New Jersey	W2LU W2AZV W2LMN	Robert E. Haight E. L. Baunach Edward Gursky, Jr.	511 South Holmes St. 102 Central Ave. 367 Van Winkle Ave.	Scotia Massapequa, L. I. Hawthorne
MIDWEST DIVISION				
Iowa Kansas Missouri Nebraska*	W9P9R W9AWP W9OJD W9WKP	L. B. Vennard A. B. Unruh Miss Lettia Allendorf Garold Bennett	1113 So. 9th St. 1617 S. Seneca St. 1015 W. 3rd St. 704 12th St.	Burlington Wichita Joplin Atburn
NEW ENGLAND DIVISION				
Connecticut Maine Eastern Massachusetts Western Massachusetts New Hampshire Rhode Island Vermont	W1CTI W1UIE W1ALP W1JAH W1EFT W1HRC W1KJG	Frederick Ellis, Jr. H. W. Castner Frank L. Baker, Jr. William J. Barrett Mrs. Dorothy W. Evans Clayton C. Gordon Clifton G. Parker	19 Merrill Rd. 147 Church 21 Colby Road 239 Columbia St. 163 South Main St. 70 Columbia Ave., Gaspee Box 537	Norwalk Damariscotta North Quincy Adams Concord Plattsburgh, Warwick Morrisville
NORTHWESTERN DIVISION				
Alaska Idaho Montana Oregon Washington	K7GNN W7CRL W7CPY W7GNI W7FCG	James G. Sherry Clifford A. Jessup Rex Roberts Carl Austin W. Beale	803 E. Seventh St. Box 1088 1437 Federal R. 4, School Ave.	Chichagof Moscow Glendive Bend Walla Walla
PACIFIC DIVISION				
Hawaii Nevada Santa Clara Valley East Bay San Francisco Sacramento Valley Philippines San Joaquin Valley	K6ETF W6BIC W6IUZ W6T1 W6CIS W6MDI KA1GR W6KUT	Francis T. Blatt Edward W. Heim Earl F. Sanderson Horace R. Greer Kenneth E. Hughes Vincent N. Feldhausen George L. Rickard Edwin A. Andress	837 16th Ave. 509 Claremont St. 101 Claremont Ave. 414 Fairmount Ave. 622-36th Ave. 113 South Quincy St. Box 849 2921 North Van Ness Blvd.	Honolulu Reno San Jose Oakland San Francisco McCloud Manila Fresno
ROANOKE DIVISION				
North Carolina South Carolina Virginia West Virginia	W4CYB W4BOE/ANG W3GWO W8OXO	W. J. Wortman Ted Ferguson Frank S. Anderson, Jr. W. D. Tabler	P. O. Box 566 1213 College St. 4703 New Kent Ave. 1004 So. Davis Ave.	Morganton Columbia Richmond Elkins
ROCKY MOUNTAIN DIVISION				
Colorado Utah-Wyoming	W9EHC W7GZG	Carl C. Drumeller Henry L. Schroeder	819 East Dale St. P. O. Box 731	Colorado Springs Laramie, Wyoming
SOUTHEASTERN DIVISION				
Alabama Eastern Florida Western Florida Georgia West Indies (Cuba-Puerto Rico- Virgin Islands)	W4DGS W4PEI W4AXP W4AOB CM2OP	James F. Thompson Carl G. Schaal Oscar Cederstrom William U. Hanks Mario de la Torre	12 Clanton Ave. Waucoma Apts. Lakeview Hotel Second St. & Bruce Ave. 4 Hunter St., S.E. Escobar 110 (Altos)	Montgomery Clermont De Funiak Springs Atlanta Habana, Cuba
SOUTHWESTERN DIVISION				
Los Angeles Arizona* San Diego	W6MOM W6KOL W6BKZ	Ralph S. Clier John E. Oliver Louis A. Cartwright	1038 Milwaukee Ave. Box 642 370 Nautilus	Los Angeles Nogales La Jolla
WEST GULF DIVISION				
Northern Texas Oklahoma Southern Texas New Mexico	W5DXA W5GFT W5MN W5ENI	Lee Hughes Russell W. Battern Horace E. Biddy Dr. Hilton W. Gillett	125 N. Main St. Box 290 1746 Schley Ave.	Childress Enid San Antonio Lovington
MARITIME DIVISION				
Maritime	VE1DQ	A. M. Crowell	69 Dublin St.	Halifax, N. S.
ONTARIO DIVISION				
Ontario	VE3EF	Flying Officer Donald R. Gunn	% Canadian Bank of Commerce	New Toronto, Ont.
QUEBEC DIVISION				
Quebec	VE2CO	Lindsay G. Morris	Apt. 6, 4510 Girouard Ave., N.D.G.	Montreal, P. Q.
VANALTA DIVISION				
Alberta British Columbia	VE4GE VESDD	C. S. Jamieson C. O. I. Sawyer	581 W. Riverside Drive 2634 West 31st Ave.	Drumheller, Alta. Vancouver
PRAIRIE DIVISION				
Manitoba Saskatchewan	VE4AAW VE4SY	A. W. Morley Arthur Chesworth	747 McMillan Ave. 1071 4th Ave., N. W.	Winnipeg Moose Jaw

\* Officials appointed to act until the membership of the Section choose permanent S.C.M.s by nomination and election.



# Centralab VOLUME CONTROLS

"Standard Equipment" in millions of receivers, Centralab Volume Controls are more than ever on the "MUST" list wherever a dependable control is indicated. For original equipment or replacement. SMOOTH — performs easier and better.

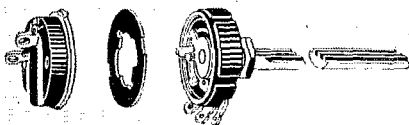

## CENTRALAB STANDARD RADIOHM

WALL TYPE RESISTOR hugs inner circumference of black molded bakelite case. Exclusive non-rubbing contact band assures quiet, smooth rotation and long life. Case dimensions: 1 3/4" diameter x 9/16" deep. Soft aluminum shaft extends 3 3/8" from case; milled full length for push-on or set screw knob.

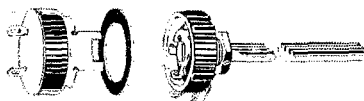

## STANDARD MIDGET RADIOHM

Companion to the Standard Radiohm, the Midget is necessary to replace original controls in many current models using small controls for space savers. Molded bakelite case, 1 1/2" diameter. 1/4" soft aluminum shaft 3 3/8" long, milled for standard push-on or set screw knob.

## ... and the Famous ADASHAFT MIDGET RADIOHM

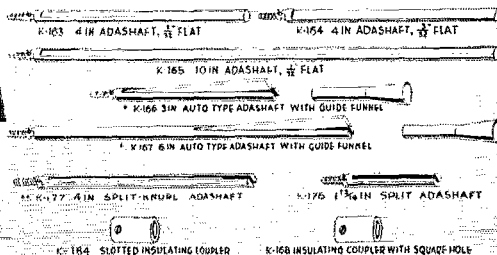
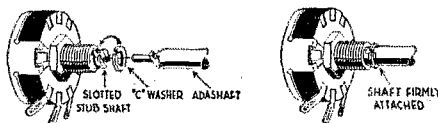

I'm in a jaunty mood as I end the year . . . in the second decade of my life. I still enjoy my reputation as an "old smoothie" and count as my friends the countless servicemen, technicians and set builders the world over who continue to boastfully admit that there is nothing finer than a Centralab part. Thanks.

- Ol' Man Centralab

**CENTRALAB • Div. of Globe-Union Inc.**  
MILWAUKEE, WISCONSIN

# THE AMERICAN RADIO RELAY LEAGUE

## Directors

<i>President</i>	
GEORGE W. BAILEY, W1KH	74 Webster Road, Weston, Mass.
<i>Vice-President</i>	
CHARLES E. BLALACK, W6GG	1700 Foothill Blvd., Altadena, Calif.
<i>Canadian General Manager</i>	
ALEX REID, VE2BE	169 Logan Ave., St. Lambert, P. Q.
<i>Atlantic Division</i>	
WALTER BRADLEY MARTIN, W3QV	Box 612, Roslyn, Pa.
<i>Central Division</i>	
R. H. G. MATHEWS, ex-W9ZN	4534 Dover St., Chicago
<i>Dakota Division</i>	
FRED W. YOUNG, W9MZN	107 Hanover St., Mankato, Minn.
<i>Delta Division</i>	
F. RAY ARLEDGE, W5SI	P.O. Box 286, Pine Bluff, Ark.
<i>Hudson Division</i>	
KENNETH T. HILL, W2AHC	115 Willow St., Douglaston, L. I., N. Y.
<i>Midwest Division</i>	
FLOYD E. NORWINE, JR., W9EFC	7405 Hawatha Ave., Richmond Heights, Mo.
<i>New England Division</i>	
PERCY C. NOBLE, W1BVR	37 Broad St., Westfield, Mass.
<i>Northwestern Division</i>	
RALPH J. GIBBONS, W7KY	c/o United Air Lines, Portland, Ore.
<i>Pacific Division</i>	
J. L. McCARGAR, W6EY	66 Hamilton Pl., Oakland, Calif.
<i>Roanoke Division</i>	
H. L. CAVENESS, W4DW	2607 Vanderbilt Ave., Raleigh, N. C.
<i>Rocky Mountain Division</i>	
GLEN R. GLASSCOCK, W9FA	2164 So. Corona St., Denver
<i>Southeastern Division</i>	
WILLIAM C. SHELTON, W4ASR	Box 652, Daytona Beach, Fla.
<i>Southwestern Division</i>	
JOHN E. BICKEL, W6BKY	801 E. California St., Whittier, Calif.
<i>West Gulf Division</i>	
WILLIAM A. GREEN, W5BKH	801 Ross St., Abilene, Texas

THE AMERICAN RADIO RELAY LEAGUE, INC., is a non-commercial association of radio amateurs, bonded for the promotion of interest in amateur radio communication and experimentation, for the relaying of messages by radio, for the advancement of the radio art and of the public welfare, for the representation of the radio amateur in legislative matters, and for the maintenance of fraternalism and a high standard of conduct.

It is an incorporated association without capital stock, chartered under the laws of Connecticut. Its affairs are governed by a Board of Directors, elected every two years by the general membership. The officers are elected or appointed by the Directors. The League is non-commercial and no one commercially engaged in the manufacture, sale or rental of radio apparatus is eligible to membership on its board.

"Of, by and for the amateur," it numbers within its ranks practically every worth-while amateur in the nation and has a history of glorious achievement as the standard-bearer in amateur affairs.

Inquiries regarding membership are solicited. A bona fide interest in amateur radio is the only essential qualification; ownership of a transmitting station and knowledge of the code are not prerequisite. Correspondence should be addressed to the Secretary.



## Past Presidents

HIRAM PERCY MAXIM, 1914-1936  
EUGENE C. WOODRUFF, 1936-1940

## Officers

<i>President</i> .....	GEORGE W. BAILEY, W1KH
	Weston, Mass.
<i>Vice-President</i> .....	CHARLES E. BLALACK, W6GG
	Altadena, Calif.
<i>Secretary</i> .....	KENNETH B. WARNER, W1EH
	West Hartford, Connecticut
<i>Treasurer</i> .....	ARTHUR A. HERBERT, W1ES
	West Hartford, Connecticut
<i>Communications Mgr.</i> .....	F. EDWARD HANDY, W1BDI
	West Hartford, Connecticut
<i>General Counsel</i> .....	PAUL M. SEGAL
	1026 Woodward Building, Washington, D. C.

Address all general correspondence to the administrative headquarters at West Hartford, Connecticut.

# "IT SEEMS TO US—"

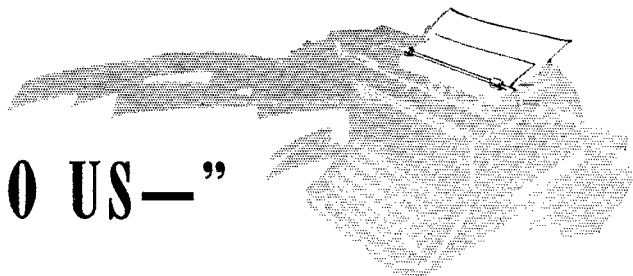

## THE I.A.R.U. SOCIETIES

WE'VE just been checking up on the effect of the war on the member-societies of the International Amateur Radio Union around the world. As is to be expected, it has left a heavy impress on amateur affairs. But not too completely so, by any means: in a surprising number of countries the societies are carrying on in much the same old way.

There are in fact only half a dozen countries from which we have definite word of the cessation of all activity for "the duration": Czechoslovakia, Egypt, France, Lithuania, Poland and Switzerland. From some we've had no word at all since the initial impact of war: Finland, the Netherlands, Norway, Roumania and Sweden. Germany seems a special case: when its officers went to war they left a clerical staff who presumably have been carrying on routine affairs but we get no word from them, no answers to letters and I.A.R.U. calendars. The other seventy percent of the associations are continuing their activities, a goodly list which, in addition to A.R.R.L. and its Canadian section, includes the societies of Argentina, Australia, Belgium, Brazil, Burma, Colombia, Cuba, Denmark, Eire, Estonia, Great Britain, Hungary, Italy, Japan, Luxembourg, Manchoukuo, Mexico, Netherlands Indies, Newfoundland, New Zealand, Portugal, Spain, South Africa and Venezuela. In a dozen countries in this last list, and in another dozen Latin countries not represented in the Union, amateur transmitting continues unabated.

The remarkable thing is the extent to which nearly normal activities are being continued in those countries where the war has brought a halt to operating on the air. It is a fine and inspiring thing to see these societies carrying on despite the temporary loss of transmitting privileges. To the best of their means, varying of course with the circumstances, they are maintaining their old functions. Most of them continue the publication of their official magazines, even though in some cases they're a bit abbreviated. Despite depletions in their ranks

and their finances through the absence from home of men in the services, skeleton staffs continue serving ardent memberships and looking after their interests, innumerable affiliated clubs and district groups continue their meetings, and the journals are filled with descriptions of receivers and receiving experiments and observations on reception, and with courses on theory and radio math — improving otherwise lost time. We should like particularly to make a bow to the Radio Society of Great Britain, which it seems to us is doing a superlative job under conditions which at best must be very difficult. To read their well-known *T. & R. Bulletin* one would scarcely think it came from a country at war were it not for the service notes and the unhappy list of Silent Keys.

To us, these things demonstrate anew the unconquerable spirit of the amateur in science, and it pleases us to think that that is particularly true of the radio amateur. He will find a way to carry on. He is nurtured on disappointment; he will discover another solution. He is determined to have his amateur radio, and to pursue it to the utmost that circumstances permit. He keeps his hand in, takes what he can get, plans for a better day. To us in America it is a splendid sight that so many of the amateur societies continue their functioning regardless of handicaps. We extend to them encouragement, congratulations, bravos. Their actions show, as nothing else could show, the affection we all feel for this our chosen art. They leave no room for doubt about our future. There will be a happier day; no war lasts forever. There will come a day of peace, and of the reopening of our international contacts, and of greater recognition of the value of the radio amateur. We all live for that day. Amateur radio in these countries will be better off then, and will get off faster to a new start, if its organization meanwhile has been maintained to every extent possible. To the officers and memberships of those amateur societies that still proudly hold the torch aloft, despite the din and clamor, all praise!

K. B. W.

# The "Variarm 150"

## A Simple ECO Exciter and Its Power Supply

BY HENRY E. RICE, JR.,\* W9YZH

**I**N ORDER that this discussion may best serve its intended purpose — that of demonstrating that stable note generation is actually a very simple matter — a review of the circuit design rules for self-controlled oscillators will be omitted. These well-known principles are all essentially simple in themselves, but their many ramifications would only tend to muddle an otherwise straightforward story. Let's grant that all of them have been considered carefully, each being given a relative value in the design of the working model with which we are concerned at the moment.

This device consists of a power supply in the form of a full-wave voltage-doubler circuit with a condenser-input filter, an electron-coupled oscillator impedance-capacity coupled to a beam power amplifier, and a parallel-resonant tuned circuit which is link-coupled to the plate tank of the amplifier stage. The r.f. power output of the amplifier is roughly 2 watts over a frequency range of plus or minus 75 kc. from the resonant frequency (plus or minus 150 kc. when used as a

frequency doubler) and the power available from the output coupler is ample for driving any one of the tubes commonly used in the first stage of existing transmitters. The unit is specifically designed to excite the control grid of the crystal-controlled oscillator stage in any transmitter, when variable frequency control is desired, without the necessity for extensive changes in existing equipment. The comments below will serve to explain the reasons for each necessarily unusual detail.

### Circuit Features

The absence of all transformers insures vibrationless operation without the necessity for resorting to a separate power supply unit.

The simplest possible system of voltage stabilization has been used to produce a good keyed note.<sup>1</sup> This idea is worthy of much wider use by amateurs than it seems to enjoy. It can be used to good advantage with nearly all tube combinations, and in any locality which has fair line volt-

<sup>1</sup> W. Wallace, W9EYH, "Hints and Kinks," p. 60, *QST*, October, 1939.

\*7011 Corbitt Avenue, University City, Mo.

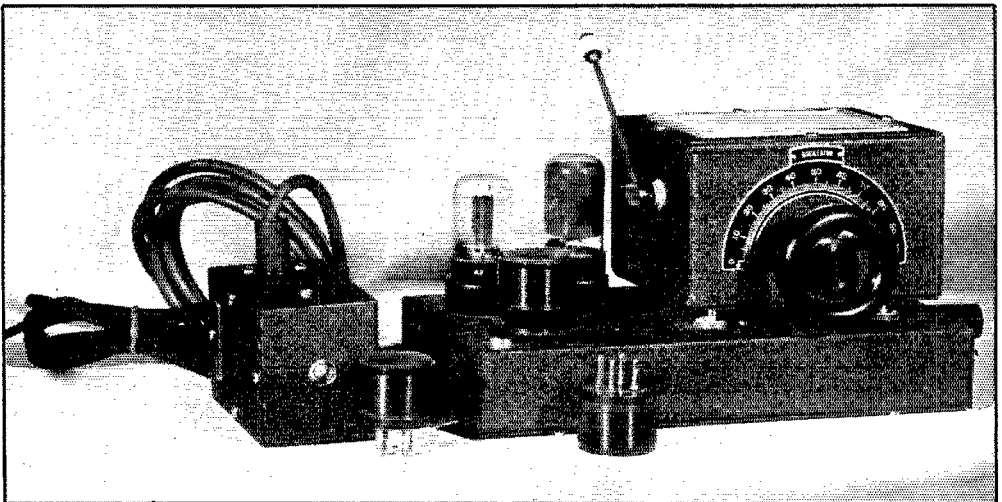

The complete e.c.o. unit, with extra coils. A load-compensated keying circuit maintains constant output voltage from the transformerless power supply.

The oscillator circuit is housed in the 3 by 4 by 5 box which is shock-mounted on and insulated from the chassis. Main tuning is with the control wheel and fine adjustment by means of the arm which operates the two-plate condenser. The rectifier is in the left rear corner; the 25L6GT output amplifier is next to it at the right. The plug-in tank which goes into the crystal socket at the transmitter is contained in the 4 by 2½ by 2 inch box at the left. It is screw-driver adjusted through the hole in the top surface.



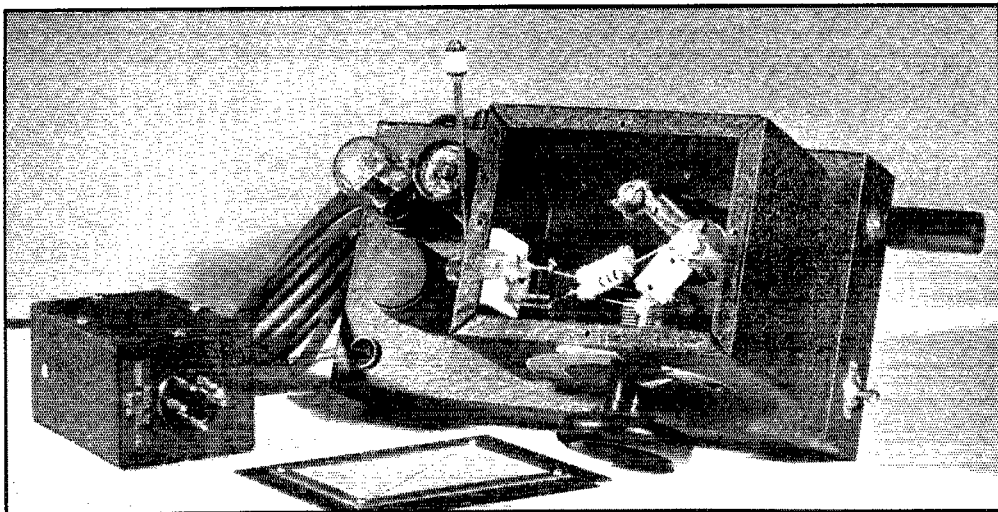

A view into the top of the oscillator box, showing the arrangement of the frequency-determining tank circuit.  $C_1$  and  $C_2$  are mounted on the sides of the box.  $C_3$  consists of two 200- $\mu$ fd. negative-coefficient units in parallel, supported between  $C_1$  and the top of  $L_1$ .

The 6K7 oscillator tube is mounted directly to the box, projecting through a hole in the bottom slightly smaller than the bottom rim of the tube. It is clamped in place by spade lugs with the threaded end cut short and fitted into opposite slots in the tube base, the spade ends being bolted to the box. The tube socket is mounted to the main chassis with rubber grommets for insulating it from mechanical vibration. The chassis is  $9\frac{1}{2}$  by 5 by  $1\frac{1}{2}$  inches.

age regulation this constant current arrangement should be the logical answer for oscillator plate voltage stabilization. It is certainly economical, and practically invaluable for use with a line-powered supply for a keyed oscillator which is, in turn, the most economical answer to the e.c.o. problem.

Almost perfectly regulated plate voltage must be used with all of the commonly known self controlled oscillator circuits if chirpless keying is to be achieved. For one reason or another, all of the conventional methods of improving regulation at the source proved inapplicable in this instance.

The inherent voltage regulation of a supply of the type used in this experiment, although somewhat better than that of a half-wave voltage-doubler, is poor even when a fairly low-resistance bleeder is used. It so happens that amateurs are most familiar with variable frequency e.c. circuits at the present time, and that small tubes and low voltage are essentially easiest to handle. Thus, the only reasonable solution which presented itself was the scheme used in this unit, namely, the maintenance of a constant load. Assuming that all circuits are resonated, the value of the cathode resistor in the amplifier stage can be adjusted for a perfect balance of current flow to the two stages with or without excitation. In this case, we find that the 25L6GT draws 30 ma. plate current and 2 (plus or minus) ma. screen current with excitation when loaded by the output coupler. The plate and screen of the 6K7 total about 14 ma. The amplifier screen current remains very nearly constant

at all times, although the screen voltage varies with keying. Thus, the 25L6GT must be biased only enough to reduce the idling plate current to 44 ma., and a constant load will be drawn from the power supply. In figures: 0 ma. plus 2 ma. plus 44 ma. (key up condition) equals 14 ma. plus 2 ma. plus 30 ma. No voltage divider or bleeder is necessary, and the fact that the amplifier following the self-controlled oscillator is not, in this instance, operated strictly in Class A is more than compensated for by the high order to voltage stabilization attained by the method described.

The by-pass condenser,  $C_{13}$ , between the voltage doubler plates is absolutely necessary for generation of a pure d.c. signal. It is in effect a substitute for the conventional by-pass across the a.c. line commonly found in line-powered receivers, but is definitely more effective when connected as shown, especially when the actual operating frequency is the fourth or higher harmonic of the fundamental control frequency (that which is determined by the constants of the 6K7 grid tank). At any rate, this one 0.002 condenser in-

**The electron-coupled oscillator continues to be a popular piece of equipment with amateur designers. Here's one with some novel features, not the least of which is its intriguing appearance. And it works as well as it looks!**

sures that the below-chassis parts can be rearranged within reasonable limits.

The value of the 25L6GT screen dropping resistor,  $R_7$ , may appear unreasonably high, in view of the general rule of high screen voltage for a beam power tube for optimum loading and power output, but it is actually correct. The reason why this is so lies in the fact that the power input is definitely limited by the supply capability. In other words, higher screen voltage tends to cause the amplifier to draw more plate current, as would be expected, but this in turn lowers the available voltage. With the cathode at ground potential, the static plate current of the stage will not exceed 75 ma. with the 50,000-ohm screen resistor specified, and thus the amplifier tube seems to be safely on the road to a long and carefree life.

The keying method is strictly conventional in its action. The apparent oddity of the system is another result of the oscillator tube mounting, and is actually a convenience in that additional lead wires can be dispensed with.

### Mechanical Layout

For the information of those amateurs who

have an eye for design of radio equipment — *i.e.*, design in the sense of pre-determination of the finished appearance — this unbalanced and strictly functional gadget developed because every other arrangement proved to be inconvenient to wire. The chassis layout indicated is not essential to the successful operation of the circuit by any means.

There are a number of reasons for the omission of a case for the entire assembly. In the first place, the use of a case immediately implies additional labor and added expense, and its use can in no way improve the performance of the equipment. Also, our rectifier and amplifier tubes seem to thrive on free air, the vernier arm enjoys its freedom, and the main tuning control can bounce around at will without being accused of passing transient shocks! All in all, the considerations of simplicity and economy have been the determining factors.

The rather odd method of mounting the oscillator tube has one distinct advantage in that this method of assembly produces a truly rigid grid circuit; *i.e.*, the grid end of the circuit wiring (the danger point of mechanical and frequency in-

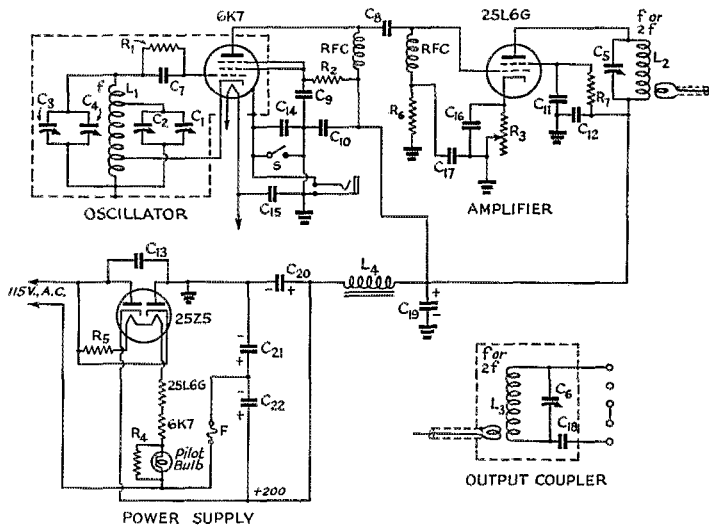

Fig. 1 — Circuit diagram of the control unit. Important: Ground symbols on this diagram indicate a common negative. Because of the rectifier circuit an actual ground cannot be used on the unit. If grounds indicated are made to the chassis, care must be taken to keep the chassis from touching any grounded objects. The usual a.c.-d.c. practice of keeping everything insulated from the chassis may be followed so that the possibility of accidental shock will be eliminated. The dotted enclosure represents the box containing the oscillator section.

- $C_1$  — 5- $\mu$ fd. (approx.) variable.
- $C_2$  — 100- $\mu$ fd. variable.
- $C_3$  — 400- $\mu$ fd. fixed (Centralab neg. coeff. type).
- $C_4, C_5, C_6$  — 3-30- $\mu$ fd. trimmer.
- $C_7$  — 100- $\mu$ fd. mica.
- $C_8$  — 250- $\mu$ fd. mica.
- $C_9, C_{10}, C_{11}, C_{12}, C_{13}$  — 0.002- $\mu$ fd. mica.
- $C_{14}$  — 0.02- $\mu$ fd. paper.
- $C_{15}, C_{16}$  — 0.01- $\mu$ fd. paper.
- $C_{17}$  — 0.001- $\mu$ fd. mica.

- $C_{18}$  — 0.002- $\mu$ fd. mica.
- $C_{19}, C_{20}$  — 8- $\mu$ fd. electrolytic.
- $C_{21}, C_{22}$  — 16- $\mu$ fd. electrolytic.
- $R_1$  — 0.15 megohm,  $\frac{1}{2}$  watt.
- $R_2$  — 25,000 ohms,  $\frac{1}{2}$  watt.
- $R_3$  — 500-ohm variable, wire-wound.
- $R_4$  — 50 ohms, 10 watt.
- $R_5$  — 165-ohm line cord.
- $R_6$  — 0.25 megohm,  $\frac{1}{2}$  watt.
- $R_7$  — 50,000 ohms,  $\frac{1}{2}$  watt.
- $L_1$  — 20 turns No. 16, length 2", diameter  $1\frac{1}{8}$ ", supported

- by slotted insulating strips.
- Tap for  $C_2$  at 12th turn from the bottom; cathode tap 6th turn from bottom.
- $L_2, L_3$  — 3.5 Mc.: 43 turns No. 26 enam., close-wound, diam.  $1\frac{3}{8}$ ". Link 3 turns.
- 7 Mc.: 19 turns No. 22 enam. length  $\frac{3}{4}$ ", diameter  $1\frac{3}{8}$ ". Link one turn.
- $L_4$  — 50-ma. midget filter choke, "30 henry."
- F —  $\frac{1}{2}$ -amp. fuse.

◆

Inside the plug-in tank. The coil socket is mounted upside down on small brackets cut from aluminum to fit. A miniature two-prong socket in the wall brings the link into the box. A five-prong plug is mounted in the bottom to fit the conventional five-prong socket used for crystal mounting.

◆

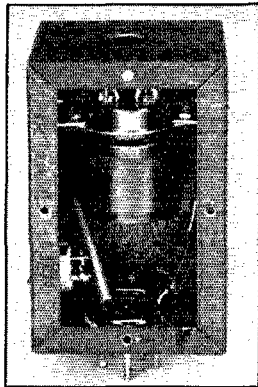

stability) has less chance to bend, sag, vibrate, or otherwise move in relation to the shield, the shell of the tube, or anything else which is at ground potential. Also, this tube mounting simplifies the problem of wiring between the chassis and the oscillator grid circuit. It is interesting to note that a metal tube with control grid and cathode connections brought out at the top would be ideal for use in e.c. oscillators: in this case, no lead would have been used between chassis and shield box, and practically zero frequency shift would have resulted from pressure applied to the shield—

but that is all by way of wishful thinking. For now, the old-style tubes with the grid at the top seem generally better suited to the layout of e.c. circuits than the newer single ended types.

The grid circuit shield for the oscillator is mounted on live rubber, and is essentially a three-point suspension. One of these supports is formed by a standard "non-microphonic" cushion mounting of the octal tube socket. The metal shell of the 6K7 is clamped tightly into a hole in the bottom of the shield.

### Tuning and Stability

The tuning method seems to work out satisfactorily in that all one has to remember is to keep the vernier handle roughly opposite the front corner of the shield box at all times. The final calibration should be done with it in this position, and the two-plate variable condenser which it controls must be turned so that the plates will be half-way open. Then, after the main dial is turned to the desired frequency setting, the final close adjustment can be made with the long arm. It seems to be possible to work the bands a bit faster by this method, and the band edges should be no more of a hazard than with the more commonly used mechanical bandspread. In this particular application, where the coil is never changed in the frequency control circuit, the number of kilocycles covered by the vernier doubles each time the operating frequency is doubled. It will be immediately evident that the use of the vernier makes it practical to spread

*(Continued on page 74)*

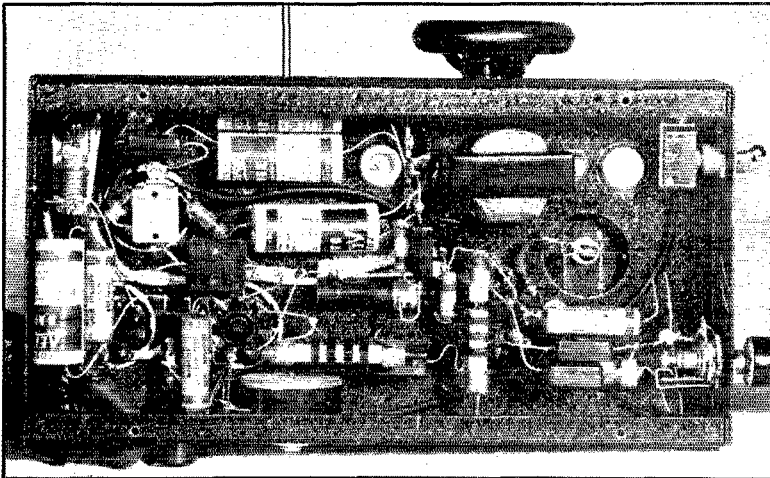

Underneath the chassis. The cathode lead from the oscillator tank is fed through an insulating bushing in the bottom of the oscillator box and projects through the round hole at the right-hand end of the chassis. Connection to the tube socket is made by a Fahnestock clip. By taking off the clip and removing the two nuts on the shock-proof mountings (on either side of the filter choke at the top) the oscillator section can be removed from the chassis without disturbing the chassis wiring.

The trimmer just to the right of the dial lamp in the upper left corner is  $C_5$ . It is mounted directly on the socket for  $L_2$  and can be adjusted through a hole in the chassis bottom plate, which has been removed for this view.

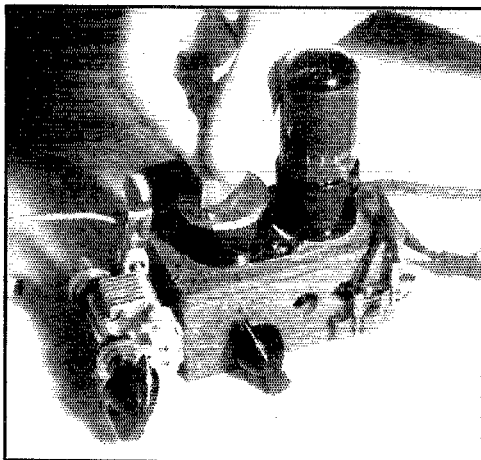

A top view of the W9ZGD transmitter shows how small a complete transmitter can be made when using one of the combination beam-power and half-wave rectifier tubes. The outboard condenser is the antenna coupling condenser.

## Pocket-Size Complete Transmitters

### Transformerless Operation With the 117L7GT

THE recent introduction of tubes containing a beam-power amplifier and a half-wave rectifier in the same envelope offers a number of possibilities for low-power transmitter construction. The design is further simplified by the fact that the heaters of these tubes work directly from 115 volts, thus eliminating the usual heater dropping resistor. Other similar types of tubes use heaters requiring 70 volts (or 35 volts, in some cases), and these can be used with the heaters in series without any dropping resistors.

Here are two transmitters, using the 117L7GT in slightly different circuits, that show how simple the whole thing can be.

### A Pocketful of Watts

BY KEITH HAYES,\* W9ZGD

SEVERAL tubes have been introduced recently which are admirably suited for use in ultra-compact transmitters. The most likely of these are the 117L7GT, the 117M7GT and the 70L7GT, since each has a half-wave rectifier and a beam-power tetrode in one small envelope.

The photographs show two views of a small transmitter using a single 117L7GT to combine the rectifier and r.f. functions in the same

envelope. The circuit, shown in Fig. 1, shows the rig to be a tetrode crystal oscillator with capacity coupling to the antenna and negative-lead keying. The rectifier is a half-wave affair, but 16  $\mu$ fd. of filter does a good enough job of filtering to make the signal T9.

The gear is all mounted on a small chassis made of strips of Masonite fastened together by small

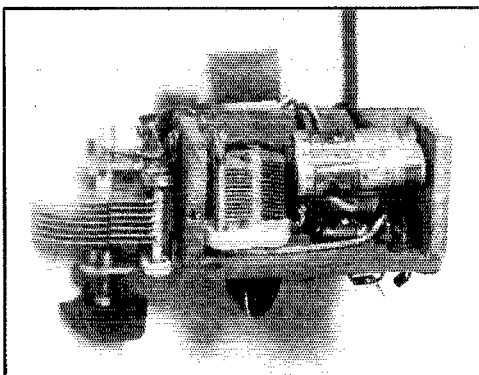

The under side of the "pocketful of watts" shows that not much room was left after the parts were put in place. Note the tank coil that projects out at the rear of the chassis.

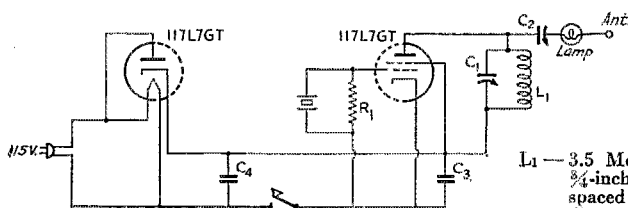

Fig. 1 — Wiring diagram of the W9ZGD transmitter.

C1 — 100- $\mu$ fd. midget variable (Meissner 21-5177).

C2 — 100- $\mu$ fd. midget variable (Hammarlund MC-100).

C3 — 0.01- $\mu$ fd. 600-volt paper.

C4 — 16- $\mu$ fd. 150-volt electrolytic.

R1 — 50,000 ohms,  $\frac{1}{2}$ -watt.

L1 — 3.5 Mc.: 50 turns No. 24 d.c.c. closewound on  $\frac{3}{4}$ -inch diameter, 7 Mc.: 23 turns No. 24 d.c.c. spaced to occupy 1-inch winding length on  $\frac{3}{4}$ -inch diameter form.

If high-powered operation has begun to pall and you're looking for some new fun, or if you're simply interested in gadgety little transmitters, you can get plenty of ideas from the two simple transmitters described here. The fact that they use no transformers and are just about the ultimate in simplicity doesn't seem to prevent their giving an excellent account of themselves on the air.

nails. The crystal and tube mount on the top of the chassis, the tank tuning condenser and filter and by-pass condensers are placed underneath, and the antenna tuning condenser is fastened on the outside of the chassis. Two Fahnestock clips are used to take the keying leads.

The transmitter is tuned as is any crystal oscillator of this type, and the antenna coupling is varied by adjusting the condenser  $C_2$ . Listen to a harmonic on the receiver while tuning, and you will notice a roughness to the note when the oscillator is tuned "on the nose". Tuning slightly to the low-capacity side of resonance will clear it up completely. Don't fail to check this adjustment with a receiver or monitor. The cathode current should run around 35 or 40 ma. when the oscillator is properly loaded.

Although 4 or 5 watts doesn't sound like much input, it is surprising what one of these little transmitters will do, particularly to one who has never tried anything like it before. Possibly, according to tradition, I should list the stations worked but, since the antenna, receiver and operating ability affect the statistics as much as the transmitter power, I'll just mention the fact that 5 watts give a signal about one "S" point lower than 20 watts and 2 "S" points lower than 80 watts. And, anyway, it's more fun to fish with barbless hooks!

## A "Pee-Wee" Transmitter

BY R. T. LAWRENCE,\*\* W8LCO

THIS is the old story told once again. I had been rebuilding the big rig and, getting tired of being off the air, I threw together a little rig to play with. Result: there hasn't been much work done on the big rig!

The power input is just 3 watts. The entire array of tubes is just one 117L7GT. As can be seen from the circuit in Fig. 2, the transmitter uses a switched antenna network that allows work on the 80-, 40- and 20-meter bands with no more fussing than changing the crystal and retuning the output circuit. The network permits matching to almost any piece of wire used as an antenna.

\*\*26 Waverly Avenue, Dayton, Ohio.

A slightly larger coil would also allow 160-meter operation. Cathode keying is used, and the output of the half-wave rectifier is adequately filtered through the use of two condensers and a choke in the filter.

The photographs show how the transmitter is housed in a 3- by 4- by 5-inch metal box. The tube socket and crystal socket mount on the top of the box (one of the 3- by 5-inch sides). The two tuning condensers, the on-off switch and a 60-ma. pilot lamp used for a plate current indicator mount on the front panel, and the band switch is supported on the rear panel. The filter choke mounts on one side, and the tapped inductance is fastened to the other side. A feed-through bushing at the top, between the tube and crystal sockets, serves as an antenna terminal, and the key plugs in to a jack on the side.

With the antenna used at W8LCO, an 80-meter crystal works best with the coil switch set to put 50 turns in the circuit, and a 40-meter crystal seems to work best with 30 turns in the circuit. However, other settings may work best for other antenna systems, and it is well to try various settings until the one is found which allows good loading of the oscillator and a minimum of chirp during keying.

Tuning is very simple. When the tube is not oscillating the indicator bulb lights up to almost full brilliancy. The output condenser, the one next to the antenna, is placed at maximum capacity. The input condenser, the one next to the plate,

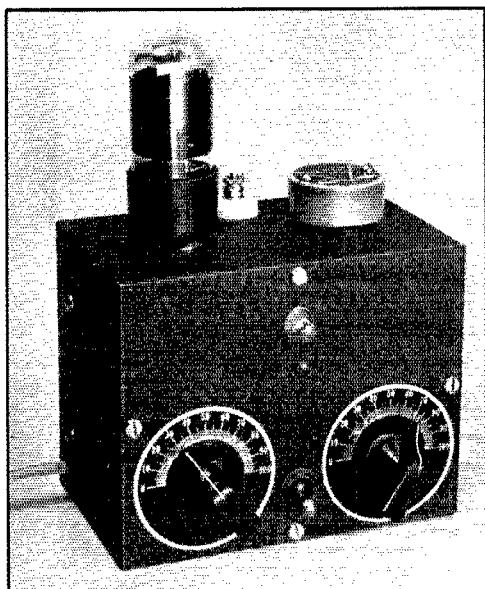

The "Pee-Wee" transmitter is small enough to fit into an overcoat pocket. The tube and crystal plug into sockets at the top — the two knobs control the two tuning condensers of the output network.

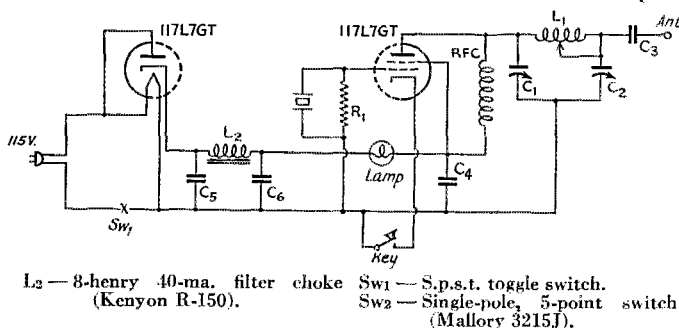

Fig. 2 — Circuit of the W8LCO pre-vee transmitter.  
 C<sub>1</sub> — 100- $\mu$ fd. midget variable (Hammarlund SM-100).  
 C<sub>2</sub> — 140- $\mu$ fd. midget variable (Hammarlund SM-140).  
 C<sub>3</sub>, C<sub>4</sub> — 0.001- $\mu$ fd. midget mica.  
 C<sub>5</sub>, C<sub>6</sub> — 16- $\mu$ fd. 150-volt electrolytic.  
 R<sub>1</sub> — 50,000 ohms  $\frac{1}{2}$ -watt.  
 RFC — 2.5-mh. r.f. choke.  
 L<sub>1</sub> — 90 turns No. 22 enam. close-wound on 1-inch diameter form. Tapped at 50, 30, 20 and 10 turns from shorted end.

is tuned to resonance as indicated by the indicator light going out. The output condenser is then tuned until the antenna takes the desired load. It will be necessary to adjust the input condenser to resonance as these adjustments are made. Further information as to the operation of this type of network may be found in the 1941 *Radio Amateur's Handbook*, pages 336 and 337.

Operation with a low-powered rig like this holds a lot of thrills. The main point to remember is that QRP requires "riding the skip"; that is, working stations at the distance that is optimum at any particular time. Using a 66-foot end-fed wire for the antenna, I have managed to run up a score of 29 states on 40 and 80 meters in slightly over a month's operation. Working in the Sweepstakes Contest, where no one will deny the competition is tough most of the time, 41 stations were worked in 17 sections. Prior to the SS Contest, the best DX was Colorado, but a 7-Mc. contact during the Contest with W6IDZ broke that

record and handed me a thrill that it will take a long time to forget. No doubt "charity begins in contests," and the average signal report of S6 may be only an indication of good humor and tolerance on the part of the stations worked, but the contacts are there in the log and that's what really counts.

— — —

**Editor's Note.** — Transmitters working into a single wire, such as the two units just described, find their ground connection back through the power supply and the power line. More often than not this is not the best ground path for the transmitter, and the performance can be improved by running a short direct ground to the transmitter. This ground lead could be connected to the transmitter through a mica condenser, but this would not comply with the A.R.R.L. Safety Code, which requires that a d.c. ground be maintained. If, however, the transmitter is grounded directly without regard for the polarity of the 115-volt a.c. source, there is a possibility that the line will be shorted. This can be checked by plugging in the transmitter and grounding the transmitter through a small 115-volt lamp. If the lamp lights, the line plug should be reversed. If the lamp doesn't light, the direct ground connection can be made without danger of blowing a fuse. In some d.c. lines, the positive side may be grounded and, in this case, it will not be possible to run a direct ground lead because the line would be shorted. However, an r.f. ground can be made through a mica condenser (0.001  $\mu$ d. or so), and special care should be exercised to avoid contact with the d.c. leads of the transmitter.

If only a.c. operation is contemplated, the single-prong plug idea suggested by W8CMP (*QST*, November, 1940, page 48) is well worth considering.

### **Strays**

A red-hot piece of resistance wire, heated by a source of a few volts, will cut through "Quartz Q" sheets and do a better job than a hacksaw. — W8AZV.

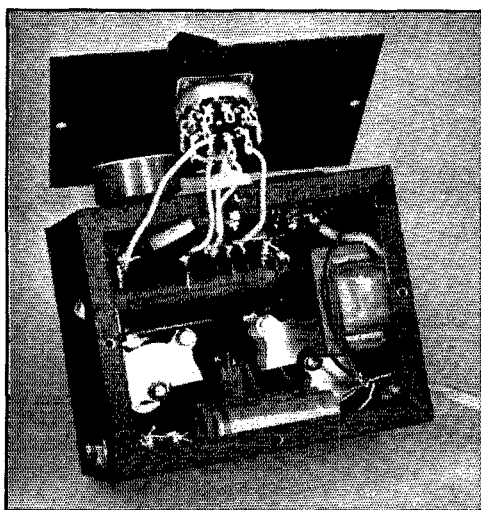

Removing the rear panel from the W8LCO transmitter allows the placement of parts to be studied. Note that the hand switch mounts on the rear panel, and in this picture is only supported by the leads.



# Keying Monitors

## Simple Units for Checking Your Fist

BY DON H. MIX,\* WITS

THE A.R.R.L. code-proficiency tests have stimulated a tremendous interest in building up speed in code reception. It is natural that one would wish his transmitting speed to keep pace with his ability to copy, but not until he has made the attempt does he often discover that increasing speed in transmission is more difficult than in reception. Whereas reception at increasing speeds is largely a matter of brain development through constant practice, transmission includes also the development of accurate control over muscles, which in their normal functions do not require precise control, and the development of an accurate sense of timing. The latter is probably the most difficult, yet most important.

There are a few operators who seem to have the uncanny ability to do a good job merely by a well-developed sense of touch, but most of us require some sort of monitoring system by which we may have a check on what's going on if we are to turn out stuff which we can reasonably expect others to copy with accuracy.

A monitoring system can be extremely simple. It does not necessarily require direct monitoring of the transmitted signal, although direct monitoring does permit a simultaneous check on both keying and the signal characteristics.

Whether you use a bug or a straight key, a keying monitor will help you to improve your fist and increase your transmitting speed. This article describes three different types and how to use them.

The photographs show three different types of keying monitors. The one whose diagram is shown in Fig. 1 is the well-known simple audio-frequency oscillator which is designed to feed an audio tone into the headphones of the receiver. It is keyed simultaneously with the transmitter so that a check on the formation of characters is provided.

The circuit shown in Fig. 2 is that of a similar oscillator with the difference that the signal produced is at a frequency of approximately 465 kc., instead of at an audio frequency. This oscillator is fed into the i.f. amplifier of a superhet receiver and is keyed simultaneously with the transmitter. The receiver b.f.o. beats in the usual way with the signal from the monitor and an audio signal is produced in the headphones.

It is obvious that neither of these two systems can provide signal monitoring; they merely furnish a check on the formation of code characters and cannot tell the operator what sort of signal quality his transmitter is producing. This can be done with the arrangement shown in Fig. 3. Here a signal from the transmitter is introduced in the input of a 6SA7 converter whose output circuit is tuned to the i.f. of the receiver. The output is fed into the i.f. amplifier of the receiver and the signal produced in the phones or loudspeaker gives a true indication of all characteristics of the transmitted signal.

\*Asst. Technical Editor, QST.

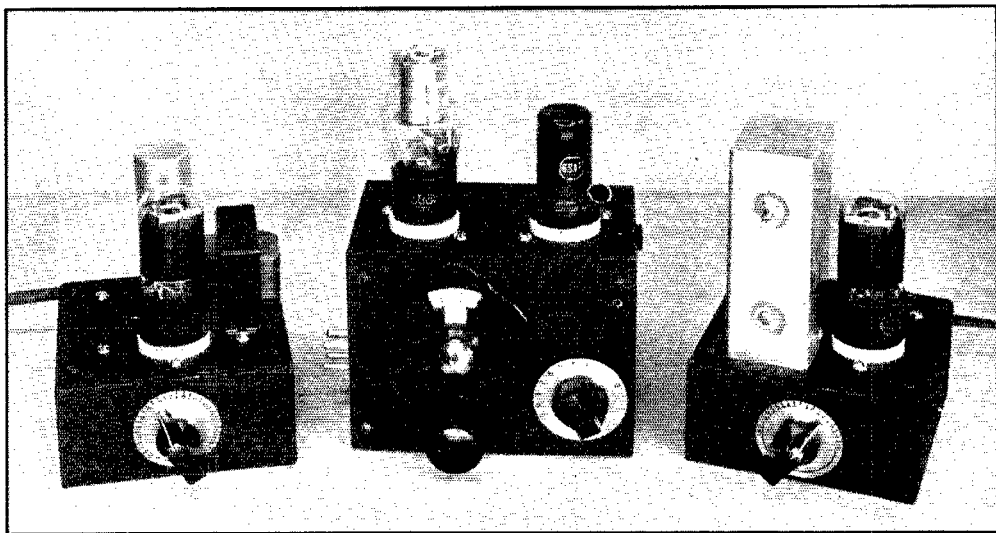

The audio oscillator, the signal monitor and the i.f. oscillator.

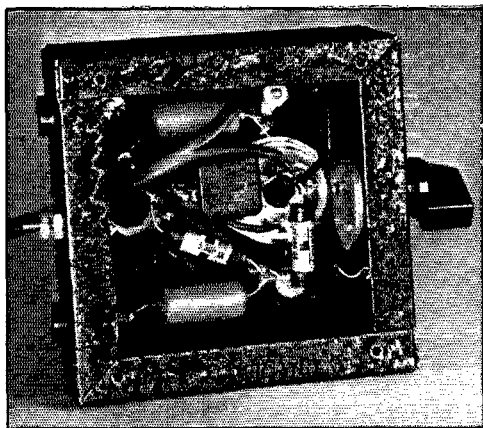

Bottom view of the audio oscillator showing placement of parts and terminal arrangement.

### Comparison of Systems

Each one of these monitoring methods has its advantages and disadvantages and these must be considered before the best one for any given set of requirements may be chosen. Neither the i.f. oscillator of Fig. 2 nor the signal monitor of Fig. 3 is likely to be entirely satisfactory for break-in operation unless special precautions are taken to prevent blocking of the i.f. amplifier by the transmitter signal. A low-power transmitter may not cause trouble except when the receiver is tuned near to the transmitter frequency, but, in a series of tests which were conducted, a medium-power transmitter with a decent antenna for the receiver would knock the i.f. practically dead so that no satisfactory monitoring signal could be heard with the receiver tuned to any part of the band. If either system is to be used with break-in,

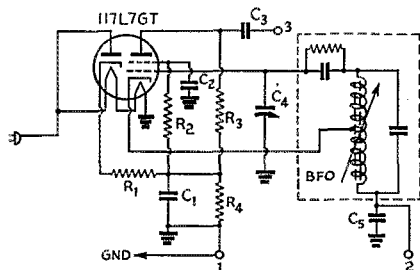

Fig. 2 — Circuit of the i.f. oscillator monitor.

- C<sub>1</sub> — 3  $\mu$ fd., 450-volt electrolytic (Mallory CS-133).
- C<sub>2</sub> — 0.01  $\mu$ fd., paper.
- C<sub>3</sub> — 50  $\mu$ fd., mica.
- C<sub>4</sub> — 25  $\mu$ fd., midget variable (Hammarlund SM25).
- C<sub>5</sub> — 0.01  $\mu$ fd., paper.
- R<sub>1</sub> — 50,000 ohms, 1-watt.
- R<sub>2</sub>, R<sub>3</sub> — 0.1 meg., 1-watt.
- R<sub>4</sub> — 50,000 ohms, 1-watt.
- BFO — Beat-oscillator unit (Sickles 465 kc., permeability-tuned, No. 6577).

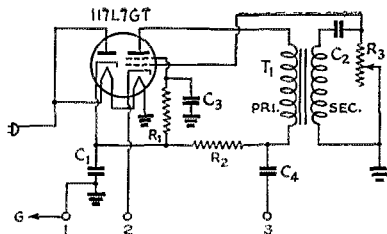

Fig. 1 — Circuit of the audio-oscillator monitor.

- C<sub>1</sub> — 40- $\mu$ fd., 450-volt electrolytic (Mallory FPS146).
- C<sub>2</sub> — 0.002  $\mu$ fd., mica.
- C<sub>3</sub>, C<sub>4</sub> — 0.1  $\mu$ fd., paper.
- R<sub>1</sub> — 50,000 ohms, 1-watt.
- R<sub>2</sub> — 5,000 ohms, 1-watt.
- R<sub>3</sub> — 0.5 meg., variable.
- T<sub>1</sub> — Interstage audio transformer, ratio 1 to 3 (Thordarson T13A34).

a relay short-circuiting the input of the receiver when the key is closed should cure most of this trouble. If break-in operation is not required, a switch in the receiver should be provided which cuts off the "B" supply of the r.f. stages, leaving the i.f. and audio circuits in operation.

The chief advantage of the i.f. oscillator of Fig. 2 is that it is possible to obtain a monitoring signal of more pleasing quality than that of the simple audio oscillator. It is also possible to obtain a wider range of audio frequencies, the range actually being unlimited. Since the signal is at the i.f., the monitoring signal does not change with tuning of the receiver. Once set, the adjustment is good for all bands.

The advantage of the signal monitor of Fig. 3 is, of course, its ability to check the quality of the output signal as well as the keying. Another advantage is that no keying connections are required. Operators who change transmitter frequency often will find that its greatest disadvantage is that it is necessary to retune the moni-

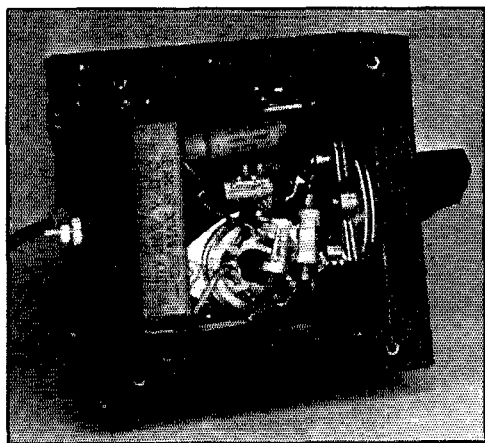

Bottom view of the i.f. oscillator.

tor each time a change in transmitter frequency is made. Once set for any particular transmitter frequency, however, the monitoring signal will be unchanged, regardless of tuning of the receiver.

### The Audio Oscillator

The audio oscillator is perhaps the most fool-proof. It is simple and has the advantage that it is free from the effects of blocking r.f. stages. While its tone is not as pure as that of the i.f. oscillator, many will prefer it to the "pure-c.w." type of signal for monitoring keying.

Either audio or i.f. oscillators may be assembled and wired in a few hours' time. A standard steel case, 4" by 4" by 2", is used as a chassis for each. Both top and bottom plates of the case are removable so that most of the assembly and wiring may be done before the unit is placed in the case.

A type 117L7GT is used as the oscillator tube. This is a combined half-wave rectifier and beam-type tetrode with a 115-volt heater, requiring no filament transformer. In the audio oscillator, a cheap interstage audio transformer is used to couple the grid and plate circuits to provide feedback. This particular transformer works with the terminals connected as marked. Other types may require reversal of connections to one winding to correct the polarity. The frequency of oscillation does not depend so much upon the inductances of the transformer windings as upon the  $RC$  combination in the grid circuit, although a different transformer may require different values of grid-leak resistance and grid-condenser capacity to produce the most desirable audio range. Filtering of the 60-cycle supply is pro-

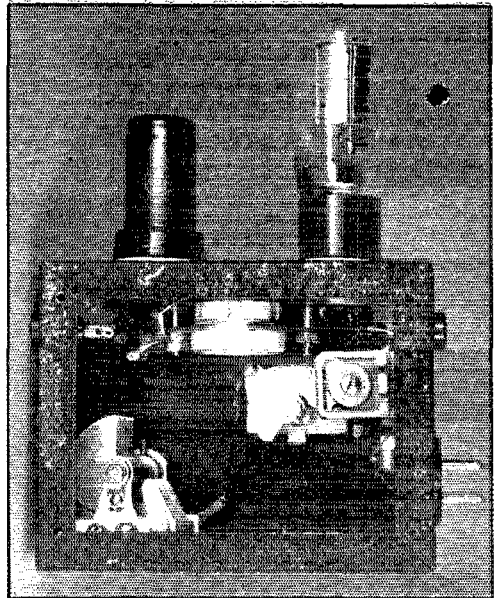

Interior of the signal monitor.  $C_3$  is to the left and  $C_4$  at right center. The i.f. trimmer condenser is soldered across the r.f. choke at the right. The oscillator coil plugs into the inverted socket in the center.

vided by the 40- $\mu$ f. electrolytic condenser,  $C_1$ . Audio output is taken from across the 5000-ohm resistor  $R_2$ . The output frequency may be varied over a considerable range with the variable resistor,  $R_3$ . Further variation may be obtained by altering the value of  $C_2$ .

Placement of parts is not critical. The 40- $\mu$ f. condenser is mounted by drilling a hole about  $\frac{3}{4}$  inch in diameter and bending the mounting tabs outward. Pin jacks are provided at the rear for output and key connections and a grounding terminal is provided for the chassis. One precaution is necessary in connecting the unit to the 115-volt line. The side of the line which is grounded to the chassis should be the grounded side of the line, otherwise, it will be possible to receive a shock between the chassis and ground, or if the chassis is grounded, reversal will cause a short-circuit of the line. This possibility may be avoided by permanently grounding the chassis to a water-pipe or other ground and using but a single wire to the power plug. Thus, if the plug is inserted the wrong way, there is no danger of injury or damage.

The audio oscillator is coupled through a capacity,  $C_4$ , to the high-potential side of the phones, while the chassis of the oscillator is connected to the chassis of the receiver. The high-potential side of the phones may be determined readily after the oscillator is in operation, since little or no signal from the oscillator will be heard if connection is made to the low-potential side. Should

(Continued on page 80)

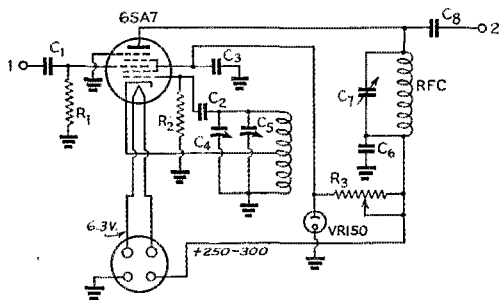

Fig. 3 — Circuit diagram of the signal monitor.

- $C_1$  — 50  $\mu$ f., mica.
- $C_2$  — 100  $\mu$ f., mica.
- $C_3$  — 0.01  $\mu$ f., paper.
- $C_4$  — 75  $\mu$ f., variable (Hammarlund HFA75A.)
- $C_5$  — 250  $\mu$ f., variable (National STH250).
- $C_6$  — 0.01  $\mu$ f., paper.
- $C_7$  — 25-100- $\mu$ f. mica trimmer (Meissner 22-7002).
- $C_8$  — 250  $\mu$ f., mica.
- $R_1$  — 0.01 meg.,  $\frac{1}{2}$ -watt.
- $R_2$  — 20,000 ohms,  $\frac{1}{2}$ -watt.
- $R_3$  — 10,000 ohms, 10-watt with slider.
- RFC — 2.5-mh. r.f. choke.
- L — 19 turns No. 22, 1-in. diam.,  $1\frac{1}{2}$ -in. long, tapped at 7th turn from ground end.

# ★ WHAT THE LEAGUE IS DOING ★

## SERVICE RECORDS WANTED

ARE you in the draft? A volunteer, or a reservist on active duty? Are you participating in national defense radio work in any way?

If so, then we want the dope on it. The League desires to compile statistics on the contributions made by radio amateurs to the present national effort. It goes without saying that such data will be of great interest in the continuing representation of the interests of amateurs. It is, therefore, requested that all amateurs serving in radio work with the military forces of the United States be kind enough to register that fact by means of a *post card* to A.R.R.L. at West Hartford. Please give the following information:

- (1) Are you a Selective Service conscript, a volunteer, or a reservist on active duty?
- (2) For how long a term are you serving?
- (3) Is your service in the Army, Navy or the Marine Corps?
- (4) To what outfit or organization are you assigned?
- (5) Location; where is your organization stationed?
- (6) What rank or rating do you hold?
- (7) What is your present radio duty assignment?
- (8) Were you previously a member of N.C.R. or A.A.R.S.?
- (9) Give your name and your *home call*.

These data are particularly desired from draftees but should not be filed at headquarters until they have passed through reception centers and have been definitely allocated to radio work.

We know that hams are making a splendid showing in the preparedness program, and we want as complete a record of this service as it is possible to get. Make it your responsibility not only to supply this information with regard to yourself, but also to call this request to the attention of other amateurs whom you know to be in service.

## WASHINGTON NOTES

THE licensing log-jam at F.C.C. now seems to be thoroughly unsnarled, as a result of the actions proposed by A.R.R.L. and adopted by the Commission. As reported last month:

Expiring licenses are automatically extended, provided applications for renewal and proof of citizenship are filed.

The permitted period of "portable" operation while awaiting modification of license for change

of address is extended from *two* months to *four* months.

Long before the end of these extended periods, F.C.C. can get out definitive new licenses to all concerned. In the meantime, no amateur will be kept off the air because of licensing tie-ups; and, of equal importance, applicants for new licenses are now receiving satisfactory attention and this work is practically up to date.

We repeat that F.C.C. has promised a waiver of the proof-of-use on behalf of men in the military services, before the time that such cases begin to occur.

Before long there should be some interesting announcements on steps being taken by F.C.C. and the industry to eliminate interference from diathermy apparatus. An informal engineering conference is being held in Washington as we write, with Jim Lamb in attendance in our interests.

Most important development of the month has been the progress in the organization of the Defense Communications Board. Itself consisting of the ranking radio men of F.C.C., Army, Navy, State Department and Coast Guard, the board will do business chiefly through a coordinating committee comprised of government radio experts, working in liaison with committees on law, labor and industry advisory matters. Under this coordinating committee are eleven "industry" committees, representing groups such as amateurs, aviation, broadcasting, cables, etc., whose duties will be to recommend plans for the most effective use and control of their facilities in time of military emergency. At the time of writing, appointments to these committees have not been made, but it is expected that A.R.R.L. will participate in the amateur committee in representation of our interests.

## CODE PROFICIENCY STATISTICS

HAVE you been wondering how the gang stacks up who have qualified for the A.R.R.L. code proficiency certificates? Here they are:

22.80%	have qualified at 35 w.p.m.
16.65	" " " 30 "
32.05	" " " 25 "
18.50	" " " 20 "
10.00	" " " 15 "
100.00%	

Thus 90% of our entrants have done 20 w.p.m. or better, while 71.5% have copied 25 or more.

Improvements are noted with each proficiency run and many "stickers" are being issued. We find that 25.4% of the fellows have increased

their speed by at least 5 words a minute since the test began and that 6.3% of them are up 10 words a minute or more.

### FINANCIAL STATEMENT

THE League lost about \$6000 from normal operations in the third quarter of last year, before taking into account disbursements against Board appropriations. This is about normal for that season of the year which is dull from the business standpoint. By order of the Board, the operating statement appears hereunder for your information:

#### STATEMENT OF REVENUE AND EXPENSES, EXCLUSIVE OF EXPENDITURES CHARGED TO APPROPRIATIONS, FOR THE THREE MONTHS ENDED SEPTEMBER 30, 1940

REVENUES		
Membership dues . . . . .	\$12,811.71	
Advertising sales, <i>QST</i> . . . . .	17,831.48	
Newsdealer sales, <i>QST</i> . . . . .	9,440.77	
Handbook sales . . . . .	5,233.16	
Spanish edition Handbook revenues . . . . .	79.60	
Booklet sales . . . . .	3,702.40	
Calculator sales . . . . .	211.20	
Membership supplies sales . . . . .	1,410.49	
Interest earned . . . . .	460.77	
Cash discounts received . . . . .	168.28	
Bad debts recovered . . . . .	16.02	\$51,365.86
<b>Deduct:</b>		
Returns and allowances . . . . .	\$ 3,433.24	
Cash discounts allowed . . . . .	361.77	
Exchange and collection charges . . . . .	148.39	
	\$ 3,943.40	
Less: decrease in reserve for newsdealer returns of <i>QST</i> . . . . .	365.33	3,578.07
Net Revenues . . . . .		\$47,787.79
EXPENSES		
Publication expenses, <i>QST</i> . . . . .	\$13,102.28	
Publication expenses, Handbook . . . . .	4,427.04	
Publication expenses, booklets . . . . .	1,231.18	
Publication expenses, calculators . . . . .	172.88	
Spanish edition Handbook expenses . . . . .	123.05	
Salaries . . . . .	23,780.91	
President's defense expenses . . . . .	27.10	
Membership supplies expenses . . . . .	929.95	
Postage . . . . .	1,469.50	
Office supplies and printing . . . . .	1,352.38	
Travel expenses, business . . . . .	588.36	
Travel expenses, contact . . . . .	1,071.82	
<i>QST</i> forwarding expenses . . . . .	955.99	
Telephone and telegraph . . . . .	531.15	
General expenses . . . . .	821.94	
Insurance . . . . .	230.05	
Rent, light and heat . . . . .	1,107.11	
General Counsel expenses . . . . .	250.00	
Communications Dept. field expenses . . . . .	169.41	
Headquarters Station expenses . . . . .	234.97	
Alterations and repairs expenses . . . . .	10.00	
Bad debts charged off . . . . .	351.55	
Provision for depreciation of:		
Furniture and equipment . . . . .	307.32	
Headquarters Station . . . . .	448.88	
Total Expenses . . . . .	53,694.82	
Net Loss before Expenditures against appropriations . . . . .	\$ 5,907.03	

### RADIO IN THE DRAFT ARMY

NATURALLY every amateur who is drafted will want to be in radio work. The military authorities, for their part, want to utilize the specialist qualifications that amateurs possess. So we repeat our suggestion to all conscripted amateurs: Take your license with you when you report to your reception center and plug hard for a radio assignment. If you really want radio work, you won't know a thing about any other craft or vocation.

If you get a radio assignment it does not necessarily mean you will go to the Signal Corps, unless you happen to be a member of A.A.R.S. All the arms and services that use radio personnel will receive them from the draft, including such branches as the Air Corps, the tanks, and, of course, the infantry itself. You may be assigned to any one of these.

In the case of A.A.R.S. members, however, the Army has made arrangements whereunder any member who is inducted will be assigned to radio work in Signal Corps organizations. Orders to that effect were issued to Corps Area commanders on October 28th and will guide the reception centers. We quote the following from the order:

It is desired that all Selective Service men inducted into the service whose civilian occupation has been in the Engineering or Plant Departments of the American Telephone and Telegraph Company, the Associated Bell Companies, the Independent Telephone Companies, Western Union, or Postal Telegraph Company, and all members of the Army-Amateur Radio System be assigned to Signal Corps organizations.

In the event that the total number of Selective Service trainees falling within the occupations named above, received in any one corps area, be in excess of the needs of Signal Corps Units in that corps area, the War Department will direct the transfer of the excess to Signal Corps Units of other corps areas.

### ELECTION NOTICE

TO ALL members of the Northwestern Division:

You are hereby advised that no candidate for Northwestern Division alternate director has been nominated under the call published August 1, 1940. By-Law 21 provides that if no eligible nominee be named, the procedure of soliciting and nominating is to be repeated. Pursuant to that by-law you are again solicited to name a member of the Northwestern Division as a candidate for alternate director. See the original solicitation published at page 22 of September *QST* and page 30 of October *QST*, which remains in full effect except as to dates mentioned therein: Nominating petitions must now be filed at the headquarters office of the League in West Hartford, Conn., by noon E.S.T. of the 20th day of January, 1941. Voting will take place between February 1 and March 20, 1941, on ballots to be mailed from the headquarters office the first week of February. The new alternate will take office as quickly as

(Continued on page 70)

# Some Notes on Fidelity

Simple Design Suggestions for A.F. Amplifiers

BY HERBERT BROOKS,\* W9SDG

Here are a few design considerations that may help you in getting the best frequency response out of any simple audio amplifier.

THE designer of an audio-frequency amplifier approaches his problem with three requisites in mind — sufficient gain, minimum wave distortion, and correct frequency response.

Getting sufficient gain is probably the least of his worries, although when he has his gain he may find plenty of "bugs." Generally, it is a simple matter to estimate the number of stages required.<sup>1</sup>

Minimizing wave distortion is not quite so simple. The usual procedure here is to follow the tube manufacturer's recommendations as to electrode voltages, load resistances, and signal levels. The signal level is usually so low compared to the electrode voltage, however, that the plate load may vary widely without introducing distortion in voltage amplifiers. Even-harmonic distortion may be eliminated by using balanced (push-pull) stages.

Push-pull circuits offer so many advantages that it often pays to use all push-pull stages in an amplifier.<sup>2</sup> A comparison of typical circuits A and B in Fig. 1 will show that the push-pull stage does not require twice the number of parts required by a single-ended stage. A further saving in push-pull may be made in power-supply filter and in decoupling circuits, since push-pull stages are less sensitive to disturbances in plate supply voltage than are single-ended stages. Also, the coupling transformer in the plate circuit of a balanced push-pull stage does not suffer from d.c. saturation. This permits the use of a smaller transformer, with consequent increased high-

\* Box 1022, Palos Verdes Ests., Calif.

<sup>1</sup> *Radio Amateur's Handbook*, Modulation chapter.

<sup>2</sup> *Radio Amateur's Handbook*, 1940, p. 206, "All P.P. Speech Amplification."

frequency response, or greater low-frequency efficiency with a given transformer.

The benefits of all-push-pull operation can be enjoyed with single-ended input by using a single-ended input tube with its output in push-pull with a phase-inversion tube (Fig. 2). The ratio of resistance  $R_1 + R_2$  to resistance  $R_2$  equals the actual amplification factor of the inversion tube. This ratio should be adjusted to produce equal excitation to the power tubes, or until no signal voltage appears across the cathode bias resistor,  $R_{k2}$ , of the balanced Class-A stage.

In any resistance-capacity coupled amplifier there is a plate load resistance, a coupling condenser, and a grid leak. The correct value of load resistance is taken from a tube data chart. The coupling condenser allows the a.c. to pass but

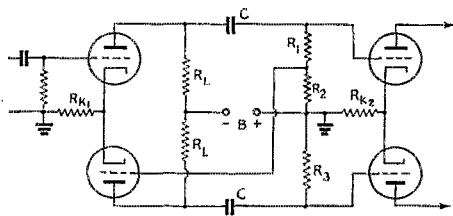

Fig. 2 — A phase-inversion circuit for use with single-ended input and push-pull output.

blocks the plate voltage of the driving tube from the grid. The grid leak feeds the grid bias, since it is connected to a source of potential negative with respect to the cathode and no current is allowed to be drawn through it, and it also acts as part of the plate load. An increase either in the capacity of the condenser or the resistance of the leak will extend the response range of the stage in the low-frequency region. An  $RC$  product of 0.01, where  $R$  is the grid leak resistance in megohms, and  $C$  is the coupling condenser capacity in  $\mu\text{fd.}$ , will give a substantially flat response curve down to 30 cycles.<sup>3</sup> Such a product could be obtained, for example, with a 0.01- $\mu\text{fd.}$  condenser and a

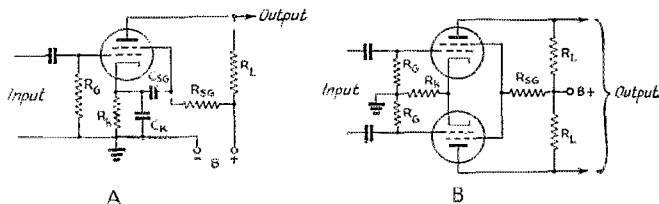

Fig. 1 — Typical voltage amplifier circuits. A single-ended circuit is shown at A, and a push-pull one at B.  $R_g$  is the grid resistor,  $R_L$  the load resistor,  $R_k$  the cathode resistor,  $R_{sc}$  the screen dropping resistor.



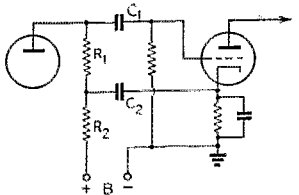

Fig. 3 — A coupling circuit for preventing cathode degeneration. The products  $R_1C_1$  and  $R_2C_2$  should be 0.01 or more, where values of resistance are in megohms and values of capacity in  $\mu\text{f}$ .

1-megohm leak, or with a 0.002- $\mu\text{f}$ . condenser and a 5-megohm leak. The author prefers the latter combination because mica condensers are superior to paper condensers as to low leakage, long life, and resistance to damage by heating; and 0.01- $\mu\text{f}$ . micas are a little hard on the pocketbook. Another reason for using a high-resistance leak is that bass response can be attenuated simply by switching in a lower-resistance leak, say 1 megohm, without fear of too low a grid leak resistance affecting the loading of the driving stage.

Frequencies above 5000 cycles are not so easily controlled on paper. However, the input impedance of conventional tubes is in the megohms over the whole audio range, so it should be possible to build a satisfactory wide-band amplifier without inverse feedback or other

<sup>3</sup> The coupling condenser and grid resistor are effectively in series across the load resistance. The coupling coefficient equals the signal voltage developed across the grid resistor divided by the signal voltage across the resistor and condenser in series, or

$$K = \frac{R}{\sqrt{R^2 + X^2}}$$

(assuming  $Z = X$ ). By manipulation and substitution of  $\frac{1}{2\pi fC}$  for  $X$ , we obtain the useful form

$$RfC = \frac{K}{2\pi\sqrt{1 - K^2}}$$

Probably the easiest way to handle it is to assume a minimum satisfactory value for  $K$ . Choosing 0.9 for this value and substituting,

$$RfC = 0.326$$

or, for 33 cycles,  $RC = 0.01$ .

<sup>4</sup> "Facts You Should Know About Condensers," Sprague Products Co., 1939.

<sup>5</sup> Analysis will show that the degeneration caused by a cathode resistance common to grid and plate returns is

$$\frac{e_{\text{cath}}}{e_{\text{input}}} = \frac{\mu}{\frac{R_{\text{load}}}{R_{\text{bias}}} + \mu}$$

where  $\mu$  is the actual amplification factor. It will be found that  $\frac{R_{\text{load}}}{R_{\text{bias}}}$  will nearly equal  $\mu$ , and thus that the gain of a Class-A amplifier which obtains all of its bias from an unby-passed cathode resistor will be approximately half that of a perfectly by-passed stage. This degeneration does not alter the signal wave-form; and it is perfectly practical to design an amplifier without cathode by-pass condensers if the lower gain can be tolerated. Otherwise the cathode by-pass impedance must be a small fraction of the cathode resistor value over the entire desired frequency range if a flat frequency-response curve is to be obtained.

compensation. Stray, uncontrolled feedback is our worst enemy, but a logical layout of parts with short leads and with the power and low-level stages well separated should minimize valleys and peaks in the response curve below 5000 cycles. One other thing to remember when considering the high frequencies is that electrolytic condensers are not very efficient at 5 kc., and should be shunted by small paper condensers.<sup>4</sup>

The zero-audio-potential elements of tubes used in single-ended circuits must be by-passed to "ground." Perhaps the most common destroyer of both low- and high-frequency response is the cathode by-pass condenser. For good response down to 30 cycles, this should be at least 5  $\mu\text{f}$ . for by-passing 2000 or 3000 ohms and at least 25  $\mu\text{f}$ . for by-passing 400 ohms or so.<sup>5</sup> As men-

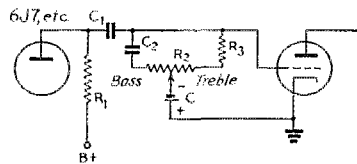

Fig. 4 — A tone control circuit for full bass or treble attenuation with one control.

$C_1$  — 0.002  $\mu\text{f}$ .

$C_2$  — 250  $\mu\text{f}$ .

$R_2$  — 5-megohm potentiometer.

$R_1$  — 0.25 megohm.

$R_3$  — 1 megohm.

tioned above, these should be by-passed for high frequencies by 0.1- $\mu\text{f}$ . or so paper condensers. The circuit of Fig. 3 separates the plate- and grid-return circuits and eliminates the cathode by-pass condenser, at the expense of a slight reduction in voltage gain. Sometimes it is more practical to forget cathode-drop biasing and use batteries or their equivalent. A satisfactory screen by-pass capacity is 0.1  $\mu\text{f}$ .

The author knows hams who never use "tone controls" because they want true, unimpaired frequency response. Nevertheless, it is an advantage to be able to eliminate the high frequencies or the low frequencies for more efficient and understandable modulation. A bass attenuator has already been mentioned, and

(Continued on page 28)

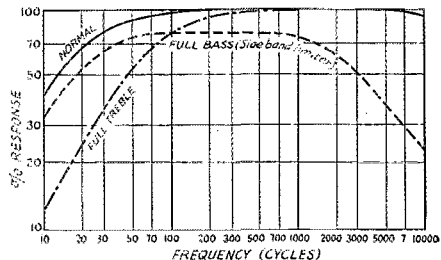

Fig. 5 — The theoretical frequency response of the tone control of Fig. 4 for various settings of the tone control. The solid line (normal response) corresponds to a midway setting of  $R_2$ .

# An Amateur Application of the Wien Bridge

**A. F. Oscillator for General Ham Use**

BY R. WADE CAYWOOD,\* W1KRD

THE Wien bridge is quite an old timer in the communication game, but it has remained in the laboratory until recently. During the last year, however, there have been several commercial applications, although the "Hetrofil"<sup>1</sup> is so far the only amateur device using the principle.

The fundamental circuit, shown in Fig. 1, is quite simple, and with some modifications can be applied to such uses as heterodyne reduction, oscillator frequency selection, sound analyzing, frequency measurement, capacity measurement,

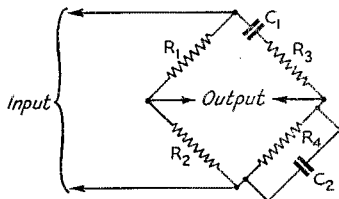

Fig. 1 — The fundamental Wien bridge circuit. Frequencies for which the bridge is balanced do not appear in the output circuit.

and condenser power-factor measurement. Our present concern is with its application in simple audio oscillator circuits, of the type suitable for speech amplifier testing and similar uses about the ham shack. Without going into the operation of the bridge, already covered in Dr. Woodward's article,<sup>1</sup> we may say that it is a selective network with a sharp selectivity characteristic, Fig. 2 being typical.

In many applications of the bridge circuit it is necessary to use a transformer or a Wagner ground to get balance to ground. The circuit in Fig. 3, the equivalent parallel-T network,<sup>2</sup> has a common ground connection for input and output, and is therefore frequently more convenient to use. The bridge shown in Fig. 1 can be tuned by varying the two resistors  $R_3$  and  $R_4$  simultaneously, or by varying  $C_1$  and  $C_2$  simultaneously. The equivalent parallel-T network can be tuned with three ganged resistors,  $R_5$ ,  $R_6$  and  $R_7$ , or three ganged condensers,  $C_3$ ,  $C_4$  and  $C_5$ . If, in the circuit of Fig. 1,  $R_1 = 2R_2$ ,  $C_1 = C_2$ , and the ganged resistors  $R_3$  and  $R_4$  have the same value, the sim-

ple equation defining the frequency of the null point is:

$$f = \frac{1}{2\pi R_3 C_1}$$

In the parallel-T network of Fig. 3, if  $C_3 = C_4 = \frac{1}{2}C_5$  and  $R_5 = R_6 = 2R_7$ , the equation is:

$$f = \frac{1}{2\pi R_5 C_3}$$

Audio oscillators using the Wien bridge or its equivalent parallel-T network as a selective feedback network have recently been introduced commercially.<sup>3</sup> Essentially such an oscillator is an amplifier with both positive and negative feedback. The positive feedback occurs at all frequencies while the degenerative feedback just cancels the positive feedback at all frequencies except the frequency for which the network is tuned. By varying this null point, the frequency

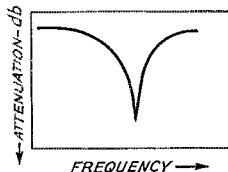

Fig. 2 — A typical selectivity characteristic of the Wien bridge. This characteristic is basic in audio oscillators using the circuit.

of oscillation is varied. An audio oscillator using the Wien bridge or its equivalent-T for the degenerative feedback has many advantages over the conventional heterodyne and LC audio oscillators. The heterodyne oscillator is a complicated affair with many tubes and circuits; while the LC oscillator requires an iron-core coil

<sup>3</sup> H. H. Scott — "A New Type of Selective Network and Some Applications," *Proc. I.R.E.*, February, 1938.

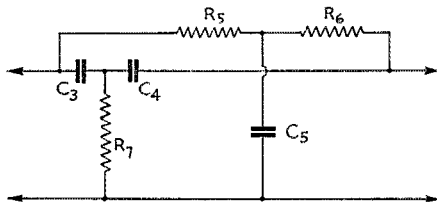

Fig. 3 — The equivalent parallel-T network, for use with grounded input and output circuits.

\* Engineer, James Millen Mfg. Co., Inc., Malden, Mass.

<sup>1</sup> R. W. Woodward — "Hetrofil — An Aid to Selectivity," *QST*, September, 1939.

<sup>2</sup> W. N. Tuttle — "Bridged-T and Parallel-T Null Circuits for Measurements at Radio Frequencies," *Proc. I.R.E.*, January, 1940.

A simple oscillator circuit having many uses about the ham shack. Continuously variable over the audio range, and generates a signal with good waveform.

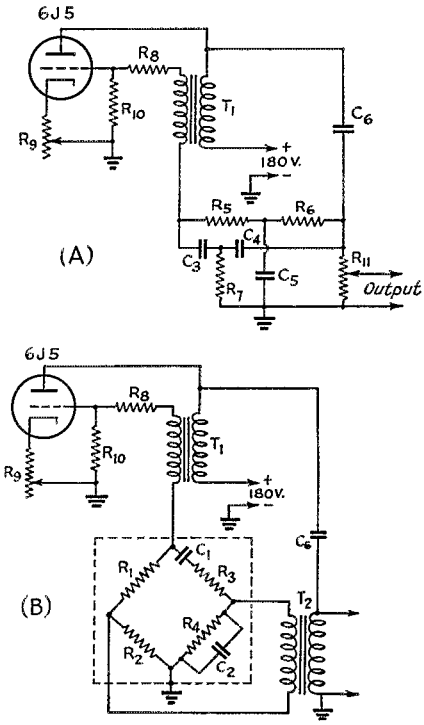

Fig. 4—Simple bridge audio oscillator circuits. A — using the parallel-T network; B — using the bridge.  
 C<sub>1</sub>, C<sub>2</sub> — 0.15  $\mu$ fd.  
 C<sub>3</sub>, C<sub>4</sub> — 0.15  $\mu$ fd.  
 C<sub>5</sub> — 0.3  $\mu$ fd.  
 C<sub>6</sub> — 0.1  $\mu$ fd. or larger.  
 R<sub>1</sub> — 4000 ohms.  
 R<sub>2</sub> — 2000 ohms.  
 R<sub>3</sub>, R<sub>4</sub> — 10,000-ohm potentiometers.  
 R<sub>5</sub>, R<sub>6</sub> — 10,000 ohms.  
 R<sub>7</sub> — 5000 ohms.  
 R<sub>8</sub> — 500 ohms.  
 R<sub>9</sub> — 5000-ohm variable.  
 R<sub>10</sub> — 0.25 megohm.  
 R<sub>11</sub> — 0.5-megohm potentiometer.  
 T<sub>1</sub> — 3:1 audio transformer.  
 T<sub>2</sub> — 500-2000-ohm transformer.

The above listed values are merely examples. Any resistors and condensers that satisfy the equations may be used.

and large condensers to tune to audio frequencies, with the result that the frequency is usually varied in steps rather than continuously. The Wien bridge oscillator can be made quite simply, requiring only one tube, and can be tuned continuously by resistances; in addition, it gives practically harmonic-free output because of the sharp characteristic curve of the degenerative network.

Fig. 4-A is a simplified oscillator of this type, using the parallel-T network. The Wien bridge and a transformer are used as the selective network in the oscillator shown in Fig. 4-B. A Retrofil can be used as the bridge in the latter

circuit. In both circuits the positive feed-back is obtained through the 1:3 transformer, T<sub>1</sub>, with the low-impedance side in the grid circuit. The amount of regeneration is controlled by the cathode resistor, R<sub>9</sub>. A by-pass condenser across R<sub>9</sub> is apt to cause the oscillator to produce all sorts of gurgling sounds, and therefore should not be used. The oscillator can be tuned by either of the methods previously described. If the feed-back is too great a resistor, R<sub>8</sub>, of the order of 500 ohms, will have to be put in series with the grid lead.

The circuit of Fig. 4-A has the advantage of requiring only one cheap transformer, but has the disadvantage that a three-gang resistor that stays ganged is needed. Condenser tuning might be used instead, or a number of feed-back circuits could be switched in or out for different fixed frequencies. The circuit of Fig. 4-B has the advantage of being easily tuned by a two-gang resistor, but has the disadvantage of requiring two transformers.

It would be possible to obtain the 180-degree phase shift necessary for degeneration by using a voltage from the plate circuit of the second section of a double-triode tube. This would make possible the elimination of a transformer, thereby cutting cost and reducing size. However, in this connection it must be pointed out that the two feed-back voltages applied to the grid must be exactly 180 degrees out of phase. This condition is hard to fulfill when more than one tube is used.

In Fig. 4-A, the resistance of the potentiometer across the output should be high so that the degenerative voltage is unaffected. The resistors in the degenerative network should be fairly high in value so that a substantial degenerative voltage can be developed at low current.

The cathode-resistor control should be advanced only far enough to set up reliable oscillation. The plate-supply voltage can be varied from about 150 volts to about 450 volts without causing a noticeable shift in oscillator frequency.

At medium and low output, the harmonic distortion is so small as to be negligible. However, at high output a small second harmonic is discernible. The output volume is too great for comfort when using a headset, but if greater volume is needed for loud-speaker operation it would be advisable to add an amplifier rather than to try to get more output directly from the oscillator. This will keep the harmonic content to a minimum.

# U.H.F. Marathon for 1941

**January 16 to December 15, 1941, Inclusive—New Monthly Credit for Minimum Regular Activity—Added Multipliers for F.M. and Work Above 400 Mc.**

BY F. E. HANDY,\* WIBDI

**M**ARATHON certificate winners for each A.R.R.L. Section for the year 1940 will be announced shortly . . . with the Medallion awards to the leading operators for the records made for each of three u.h.f. band groups, 56-60 Mc., 112-116 Mc., and above 224 Mc. Suggestions for a new A.R.R.L. Marathon received from a number of sources have been incorporated in plans for a brand new opportunity for the coming year.

(1) In 1941 the high monthly scorer will receive certificate recognition for the leading results reported covering performance between each 16th of one month and the 15th of the following month inclusive. (2) Special certificates will go to Marathon Leaders for each A.R.R.L. Section for the whole period Jan. 16 to Dec. 15, 1941, inclusive. (3) Solid-bronze medallion awards will be engraved with the calls of winners for each of four u.h.f. band groups for the whole 1941 period (56-60 Mc., 112-116 Mc., 224-230 Mc., 400-and-

\* Communications Manager.



above Mc.). Reproductions of the medallion and certificate awards, each to be approved by an award committee consisting of the Contributing Editor, U.H.F., *QST's* Technical Editor, and the A.R.R.L. Communications Manager, appear herewith.

## HOW MANY STATES CAN YOU WORK ON U.H.F. IN 1941?

The three amateur operators demonstrating confirmed contacts to show the three highest numbers of "states worked" of the United States during 1941 will again be in line for bronze medallion awards.

The awards are independent of Marathon scoring, though the number and name of new states as you work them will be reported with your Marathon operations throughout the year. All contacts must be made from one location. Any or all u.h.f. bands (frequencies of 56 Mc. and above) assigned amateurs may be used. For definitions of location and requirements, see page 23 of January 1940 *QST*. The medallions will be engraved for the u.h.f. leaders in "states worked" (Jan. 1st to Dec. 31st inclusive). The calls of the winners and number of states engraved on bronze medals will depend on presentation and examination of written confirming evidence in support of states worked claims that are received by the A.R.R.L. Communications Department on or before January 17, 1941.

## Rules

1. The Contest is open to all U. S. licensed radio amateurs, and will take into account operating and experimental work reported at monthly intervals during the contest period Jan. 16 to Dec. 15, 1941, inclusive.

2. **Contact Points.** Contacts may be scored for each completed QSO sufficiently good to permit exchange of intelligence with a station! *One contact only, per band, per year, per different station.* counts in the claims. Points claimed depend on distances measured by a great circle line between stations as follows:

Under 25 miles.....	1 point
25 to 75 miles.....	2 points
75 to 250 miles.....	5 points
250 to 500 miles.....	25 points
500 to 1500 miles.....	10 points
Over 1500 miles.....	50 points

## 3. Multipliers.

56-60-Mc. contacts.....	1
112-116-Mc. contacts.....	2
224-230-Mc. contacts.....	10
Above 400-Mc. contacts.....	25

The frequency band of one's transmitter shall determine contact multipliers allowed (1, 2, 10 or 25) and permits cross band work to count.

4. **Frequency Modulation Multiplier.** For all points made in which the transmitter of the claimant is adjusted for and uses controlled FM, the points may be figured as in Rules 2 and 3 for various frequency bands, and then a multiplier of *two* in addition to any other factors may be applied. The use of FM at stations contacted does not

affect your own score. Claims for a given station in a given band may include either an FM or AM credit, but not both.

5. **Special Credit for Regular Activity.** A maximum of 3 points per day, one for each contact with a different station, may be claimed by each contestant, the total number of points per month on this basis not to exceed 50. For this factor, the same stations may be worked on different days toward this regular activity credit. It is necessary that all three contacts for a particular day be made with transmitter on one particular u.h.f. band. All QSO's must be shown in logs kept available for call (in proof of the points, if requested by award committee). This monthly credit not to exceed 50 points is added after the score has been determined under Rules 2, 3 and 4.

6. **Substitution of Portable or Portable-Mobile Credits.** Instead of a credit for work with a fixed or permanent amateur station, a credit for communication with that same call identity operating portable or portable-mobile, may be substituted in a given band, if the distance and the resulting credit is greater. All locations of temporary stations of portable or portable-mobile character must be accurately and correctly defined to permit a valid claim. A call signal is regarded as indicating a single station identity, whether operated in fixed or portable or mobile status. Points claimed must, therefore, be only those attained by an individual amateur operator, operating equipment under his own call, and whether one or both stations go portable, there is only one acceptable claim per band for those stations, that of the best DX.

A portable or portable-mobile equipment may be used by the competitor himself, and when duly controlled and operated by this operator, points attained by contact with stations not included in claims resulting from the operation from the fixed or permanently located station, may be granted. In other words, but one contact between any two station identities may count for credit in a particular band, that claim for the best distance between two given stations taking precedence.

7. **Reporting.** Monthly claims must be made in the form of a "stations worked" list, showing distances and points for each QSO and giving claimed total of all credits for a given reporting month (16th to 15th inclusive).

Reports must be sent at once after each reporting month for claims to be allowed, i.e. reports for a particular month must bear a postmark not later than the 22nd of that month. The special mimeographed report forms (or facsimile thereof) available from the Contributing Editor, U.H.F., should be used in making monthly report.

8. Proof of contact in writing from any stations contacted may be required as prerequisite to credit, whenever thought necessary by the award committee. F.C.C. logs may be submitted as necessary to straighten out points in doubt.

9. An extra credit, in no case to exceed 10%, may be granted participants for submitted articles in the u.h.f. field, intelligent observation of unusual conditions, photos, etc., such to count for marathon awards only if these items are summarized and brought to the attention of the Committee toward the end of the 1941 Marathon. No claims will be considered if received after December 31, 1941.

Operating utilization of the u.h.f. bands and experimental progress making contacts possible on the higher frequency of these bands will prove important and necessary to come out a winner. The Marathon should clearly indicate the U.H.F. leader for the year for each territorial Section.

In computing scores, claims will be allowed for each different station worked but once on a particular u.h.f. band (of the four named in Rule 3) for the entire year. The monthly additions to your credits boost the score standing to be considered at the year-end toward the 1941 U.H.F. ACHIEVEMENT Certificates for Section leaders — and toward the four medallion awards!

All points claimed must be those obtained by one individual amateur operator himself, operating equipment only under his own call and control. A call signal indicates a single station identity for all purposes whether combined with the portable indicator or not. The Award Committee may declare "no award" if fewer than three entries turn up in any classification or may declare "duplicate awards" if circumstances warrant. A.R.R.L. staff members may participate but are ineligible for awards. It is not required that an amateur be a League member to take part fully. All licensed U. S. hams are invited to report their worked lists and point claims for each reporting month, starting in mid-February for the period Jan. 16th—Feb. 15th inclusive. Mail reports to A.R.R.L. Communications Department, West Hartford, Conn.

## Silent Keys

It is with deep regret that we record the passing of these amateurs:

Charles J. Dawes, VE3NM, Mille Roche, Ont.

William Taft Durham, W9NKG, Harrisburg, Ill.

Baird W. Fordham, W6MUM, Los Angeles, Calif.

John Frigar, W3AIF, Philadelphia, Penna.

Edmund L. Gaffney, W7HMV, Kent, Wash.

Gordon R. Gilchrist, W7BVZ, McCleary, Wash.

Leo S. Hower, W8PFM, Rome, N. Y.

P. C. E. Lay, VE5AGQ, Yellowknife, N.W.T., Can.

Miss Amelia E. Laslovich, W7DUR, Anaconda, Mont.

Leonard C. McCall, W5AFR, El Paso, Texas

W. H. Meyers, W8BTH, Akron, Ohio

Fred Moose, W8IFE, Detroit, Michigan

William W. Morgan, W5FRZS, Seymour, Texas

C. L. Page, W8BWY, Oneida, N. Y.

Lt. Nathan H. Samuels, ex-W6CWN, W6CNT, Oakland, Calif.

Joseph Schwendt, W3ENZ, Trenton, N. J.

Edward H. Southoff, W2HDG, Laurelton, N. Y.

Horace G. Stark, VE3UH, Carleton Place, Ont.

Dr. A. W. Taft, W1AVH, Cranston, R. I.

Shiko George Tahara, W6QLE, Compton, Calif.



# A.V.C. for C.W. Reception

## Automatic Control of Code Signal Levels

BY EDWARD H. WEBER,\* W2GRD

A COMMON fault of the ordinary super-heterodyne receiver using a "c.w. oscillator" is the inability to use automatic volume control when the c.w. oscillator is turned on without greatly reducing receiver sensitivity. This is due to the fact that the c.w. oscillator loads up the a.v.c. rectifier which, in turn, imposes proportionate negative bias on the grids of the preceding amplifier tubes. Since the output of the c.w. oscillator is usually much greater than the output level of the i.f. amplifier, there is a very great reduction in receiver sensitivity. For this reason, receivers are equipped with switches to

reasons: (1) to prevent overloading of i.f. amplifier tubes, (2) reduction of level variations due to fading, and (3) limiting output to a desirable level. In present-day receivers these features are not attainable automatically for c.w. reception.

A simple modification of the second detector-a.v.c. circuit has been designed by the writer which permits a.v.c. action both for 'phone and c.w. reception without the fault previously mentioned. Because of its simplicity, modification of most modern receivers is practical at little or no expense.

### The Circuit

The fundamental principal involved in the new circuit is illustrated by Fig. 1, where the second detector is represented by the parallel impedance  $Z_1$ ;  $Z_2$  is a balancing impedance equal to  $Z_1$  at the intermediate frequency;  $R$  and  $R$  are equal resistances representing the two halves of a center-tapped i.f. amplifier output transformer secondary. The arrangement is seen to be equivalent to a Wien bridge which is in balance at the intermediate frequency, which is also the frequency of the c.w. oscillator. Since the second detector is one arm of the bridge, it receives the outputs both of the i.f. amplifier and the c.w. oscillator. Any audible difference in frequency between these two sources will, consequently, be found in the output of the second detector—the familiar heterodyne. The a.v.c. rectifier, however, is bridged across opposite corners of the balanced bridge. For this reason, it receives only the output of the i.f. amplifier, and is unaffected by the c.w. oscillator.

The practical circuit is shown in Fig. 2. Here,  $V_1$  and  $V_2$  are second detector and a.v.c. rectifier, respectively, and may be contained in a single envelope, as in a 6H6.  $R_1$  and  $R_2$  are the second detector load resistors.  $R_2$  and  $C_2$  form an r.f.

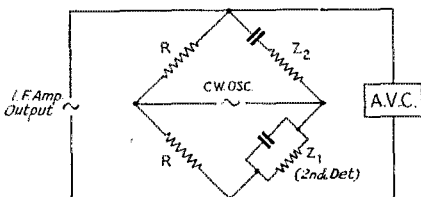

Fig. 1—The fundamental circuit of the c.w. a.v.c. system uses the bridge principle to prevent the b.f.o. (c.w. oscillator) voltage from affecting the a.v.c. rectifier.  $R$  and  $R$  represent the two halves of a center-tapped i.f. output transformer secondary,  $Z_1$  is the second detector impedance, and  $Z_2$  is an impedance added to balance the bridge.

disable the a.v.c. when the c.w. oscillator is operating. Receiver gain then is controlled manually by an "r.f. gain" dial.

In more elaborate receivers of a few years ago, a separate i.f. amplifier and rectifier was used for a.v.c. alone. One such receiver is described in the Handbook of 1936. One purpose of this design was isolation of the c.w. oscillator from the a.v.c.

Whether in reception of phone or c.w. signals, automatic gain control is desirable for three

\* 10 Gateway, Toms River, N. J.

Fig. 2—A practical circuit for c.w. a.v.c. representative values are:

- $C_1, C_5$ —0.01  $\mu$ fd.
- $C_2$ —100  $\mu$ fd.
- $C_3$ —3.5  $\mu$ fd. (see text).
- $C_4$ —0.25  $\mu$ fd.
- $C_6$ —100  $\mu$ fd.
- $R_1, R_5$ —0.5 megohm.
- $R_2$ —0.1 megohm.
- $R_3$ —38,600 ohms (see text).
- $R_4$ —1.0 megohm.
- $P$ —R.f. gain control potentiometer (see text).

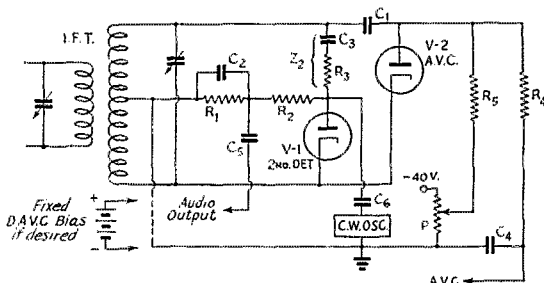



filter circuit to isolate the c.w. oscillator from the audio output and  $C_3$  and  $R_3$  together comprise the balancing impedance  $Z_2$  of Fig. 1.  $R_4$  and  $C_4$  make up the filter and time circuit for the automatic volume control, while  $R_5$  is the a.v.c. rectifier load resistor,  $C_1$  and  $C_5$  are r.f. coupling d.c. blocking condensers, and  $C_5$  is an a.f. coupling, d.c. blocking condenser. The c.w. oscillator is merely represented as a block, since it may be of any conventional design. The potentiometer  $P$  will be explained later. The values shown are representative only, and may be chosen in accordance with requirements.

The essential condition for balance is that  $Z_1$  of Fig. 1 must equal  $Z_2$  at the intermediate frequency.  $Z_1$  is represented as shown, since the input impedance of the second detector is composed of the inter-electrode capacity of the diode, shunted by its input resistance to the carrier. The input resistance of a diode, when the load resistance is high, is nearly equal to one-half the total load resistance, or,  $(500,000 + 100,000)/2$  for the values assumed in this case. The plate-cathode capacity of the No. 1 section of a 6H6 is  $3 \mu\text{fd}$ . Since  $Z_2$  is composed of  $C_3$  and  $R_3$ , these values may be determined by the expression

$$R_3 - jX_{c3} = \frac{rX}{r - jX}$$

where  $r$  is the input resistance of the second detector, and  $X$  is the reactance of the plate-cathode capacitance at the intermediate frequency. For the values assumed, and an intermediate frequency of 456 kc., the values of  $R_3$  and  $C_3$  are 38,600 ohms and  $3.5 \mu\text{fd}$ ., respectively.

Other requirements are that the c.w. oscillator and its wiring be well shielded to prevent any stray coupling into the receiver circuit at any point other than as indicated in the diagrams; and that the secondary winding of the i.f. output transformer be balanced, both in inductance values and in capacities to ground, on each side of the center-tap. This latter is more readily assured if an air-core transformer is used, with primary and secondary windings well separated.

Now that a.v.c. action is obtained on c.w. reception, there is the annoyance of rapid changes in receiver sensitivity as the incoming carrier is keyed, resulting in a thump. One way to reduce this effect is to use a large time constant in the

A.v.c. is never used with present-day c.w. receivers because, with the usual systems, the b.f.o. voltage knocks down the gain of the receiver too far. The method described here eliminates this disadvantage and shows how practically any receiver can be modified to include the advantages of a.v.c. for c.w. reception.

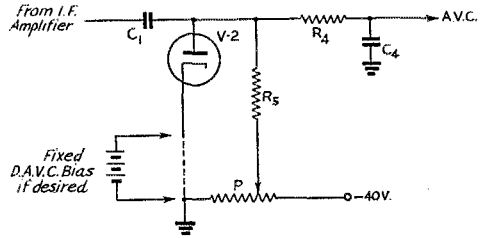

Fig. 3—The d.a.v.c. bias can be increased as the sensitivity is reduced by the circuit shown above. The values are the same as in Fig. 2. This is an equivalent circuit of the a.v.c. portion of Fig. 2.

a.v.c. circuit. A better method, however, is to augment the a.v.c. with manual r.f. gain control, adjusting the latter until the change in gain due to a.v.c. action is slight. However, for receivers using full a.v.c., the sensitivity must be greatly reduced to accomplish this. Where delayed a.v.c. is used, the optimum adjustment of the r.f. gain control is obtained when the peak value of the signal applied to the a.v.c. rectifier is equal to the d.a.v.c. bias voltage. This gives smooth reception of c.w. signals, but limits the output level of the i.f. amplifier to the fixed value of the d.a.v.c. bias voltage, and makes delayed a.v.c. a requirement for smooth c.w. reception.

A very much better method of controlling receiver sensitivity is to increase the d.a.v.c. bias voltage as sensitivity is reduced. By so doing, there is no sacrifice of receiver sensitivity, output level, or the desirable features of a.v.c. action. The slight modification necessary to accomplish this is shown in Fig. 3, and is applicable to any diode-type a.v.c. system. Values, including that of potentiometer  $P$ , may be chosen at will in accordance with good practice. The potentiometer uses or replaces the r.f. gain control on the receiver. It will be seen that this potentiometer accomplishes the dual functions of supplying variable negative bias to the amplifier grid returns, and biasing the a.v.c. rectifier by the same amount. Thus, the total bias delivered to the amplifier grids is the sum of that obtained from the potentiometer, and the voltage delivered by the a.v.c. rectifier. Up to the point on the potentiometer where rectification ceases in the a.v.c. rectifier, due to the bias from  $P$  being equal to the peak r.f. voltage, the total bias delivered to the amplifier grid returns is uniform, and is the same as would be obtained from the a.v.c. rectifier if unbiased. Consequently, the gain of the receiver remains the same up to that point, but reduces beyond that point. However, as that position on  $P$  is approached, the variation in receiver sensitivity, as the carrier is keyed, becomes less, and remains perfectly constant at the point where rectification just ceases, the ideal condition.

In most receivers the manual r.f. gain control consists of a potentiometer, or its equivalent,

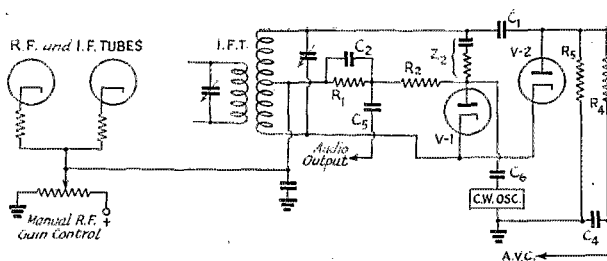

Fig. 4 — A modification of the circuit of Fig. 2 for receivers in which i.f. gain is controlled by varying the cathode potentials of r.f. and i.f. tubes. The values are the same as in Fig. 2.

in the cathodes of the r.f. and i.f. tubes, to vary the potential of the cathodes above ground. In such cases, the only modification necessary to obtain the same result is to return the cathode of the a.v.c. rectifier to this potentiometer instead of to ground. The resultant combined circuit is shown in Fig. 4.

Here are combined the advantages of manual and automatic volume control, for c.w. reception. There is also a decided improvement in the reception of non-continuous carrier radiophone, such as is encountered when voice-operated relays, or push-to-talk switches, are used on transmitters in certain types of commercial services. In such cases, the advantage lies in the fact that by adjusting the manual r.f. gain control near the optimum setting as previously explained, overall receiver sensitivity is restricted when the carrier is off, thereby limiting the noise level during carrier-off periods.

By combining the two modifications, either as shown in Fig. 2 or in Fig. 4, nothing is sacrificed in the receiver, and much is gained at little or no expense.

### Results

For the original trial, these modifications were made in an RCA ACR-155 receiver, which is "made to order" for the arrangement of Fig. 2. The ACR-155 uses a 6H6 second detector-a.v.c. tube, the c.w. oscillator is thoroughly shielded and isolated, and the manual r.f. gain control is arranged to provide variable negative bias for the grids of the r.f. and i.f. tubes. Complete change-over was accomplished in three hours, and the only expense involved was replacement of the i.f. output transformer with one having a center-tapped secondary. The 100,000-ohm r.f. gain control was retained for P, but a 10,000-ohm unit would work as well. Incidentally, values of the balancing impedance  $Z_2$  components were found to be non-critical, full satisfaction having been attained using an available 35,000-ohm resistor for  $R_3$ , and a 3-30  $\mu$ fd. trimmer condenser at minimum setting for  $C_3$ .

Operation of the receiver for c.w. can be handled in the same manner as for 'phone reception. With the r.f. gain control at maximum receiver sensitivity, and the c.w. oscillator on, it is a pleasure to tune across the c.w. bands and hear

the weakest signals, with the assurance that the speaker won't jump out on the floor when strong signals are encountered, since the a.v.c. is always in use. When a particular signal is selected, the r.f. gain control may then be adjusted for smooth operation if necessary, and the a.v.c. will still take care of increases in signal strength due to unsteady transmission, or sudden blasts from strong interfering signals. When an interfering signal is considerably stronger than the desired signal, it will take control of the a.v.c. and cause variations in the strength of the desired signal as the interfering signal is keyed. This is remedied by adjusting the r.f. gain control until the interfering signal no longer operates the a.v.c. The desired signal then no longer controls the a.v.c., and is weakened accordingly, just as when full manual r.f. gain control is employed as in present receivers. There is an advantage in tuning 'phone stations, particularly on the ten-meter band where tuning may be critical, since the c.w. oscillator may be turned on to zero-beat a signal without reducing volume, and without causing frequency shift if stability of the converter tube is affected by changes in grid bias, since the c.w. oscillator has no effect on grid bias through the a.v.c. channel. This system may also facilitate break-in operation, since the a.v.c. will prevent overloading the receiver when the transmitter is operating at or near the receiving frequency.

All in all, the improvements attained by these changes are well worth the little effort and expense involved, for, after all, if a.v.c. is desirable for 'phone reception, why not equally so for c.w. reception? Furthermore, operation is simplified by the elimination of one more control, the a.v.c. switch, from the front of the receiver panel.

### Some Notes on Fidelity

(Continued from page 21)

treble frequencies can be attenuated by a small condenser shunting the load resistance or the grid resistor. For example, a 250- $\mu$ fd. condenser shunting a 0.25-megohm load will begin its attenuation at about 2000 cycles. Fig. 4 shows a circuit in which a single control attenuates either bass or treble, depending upon the setting, and the curve in Fig. 5 shows the range of control using this system.

# Fifth U.H.F. Contest Successful

BY JAMES R. BUCKLER, JR.,\* W9NFL

**W**ITH many established routes of past relays working in fine style, the September Contest Relay saw many new stations taking part and a further extension of the trend to higher frequencies. The absence of DX-skip communication made the work of carefully planned routes stand out as being the most reliable and effective means of handling messages over distances on the u.h.f. bands. Reports indicate that 112 Mc. was used to a greater extent than ever before; many participants used this band exclusively.

Outstanding was the score of W2DKJ/2, taking top place with 858 points and a total of 50 contacts. Arthur Lynch used both 56 and 112 Mc. and handled 116 messages from his portable location to set this new high for U.H.F. Contest scoring. Runner-up W1AUN/1 piled up a score of 476 points with 65 contacts from Mt. Wachusett. Third place we find claimed, once again, by a station using 112 Mc. exclusively — this time W1BSG/1, on Mt. Monadnock, N. H. He took advantage of the extra multipliers for 2½-meter and portable operation to score 392 points and make 46 contacts.

W1HDQ, making use of both 56 and 112 Mc., came through with 348 points and 33 contacts for the highest score yet attained by a fixed station. Of the many routes along the East Coast, the W1HDQ-W2ILK/2-W3HOH-W3ABS-W3BZJ route and the circuit of W2DKJ/2-W1MRF-W1IJ-W1HDQ were among the foremost. These channels handled a number of third party messages in addition to test messages.

The East Coast-Illinois route was clicking very well, indeed, with the line-up of W3BZJ-W3HWN-W8EUO/8-W8CIR-W8QUO/8-W8QDU-W8MDA-W8CVQ-W9VHG. Variations and extensions of the route took messages from New England to Chicago and to other points along the route in both directions. Too much credit cannot be given W8EUO/8 and W8QUO/8 who, operating portable at carefully picked points, effectively bridged the gaps which have given trouble in the past. W8EUO/8 reports his location on Blue Knob Mountain, Pa., to be by far the best yet found. Located atop the 352-foot shaft of the International Peace Memorial at Put-in-Bay, Ohio, W8QUO/8 had no difficulty maintaining contact with W8CIR, Aliquippa, Pa., and W8QDU, Detroit.

The number of messages delivered, especially those covering long distances, shows that relays on the u.h.f. bands are rapidly developing into a practical and efficient system. The routes listed

\* Communications Department.

## SCORES, FIFTH U.H.F. CONTEST AND RELAY

(Figures represent score and number of different stations worked. Letters indicate band or bands used. A for 56, B for 112 Mc.)

W2DKJ/2	858-50-AB	W1JDV	58-25-A
W1AUN/1	476-65-AB	W1MDN	58-18-A
W1BSG/1	392-46-B	W1SS	55-31-A
W1HDQ	348-33-AB	W1LMU	46-16-B
W8EUO/8	298-8-A	W1LSN	45-14-A
W8QUO/8	244-15-A	W8MDA	43-5-AB
W3BZJ	223-25-A	W1LPP	42-21-A
W3HOH	172-22-A	W1KSB	40-12-B
W2MWA/2	150-27-B	W1LEA	39-22-A
W8ODU	149-19-AB	W9VHG	38-4-A
W2BZB	146-40-B	W9NFN	37-6-A
W2ILK/2	144-10-A	W9ARN	33-6-A
W2LAU	144-30-AB	W8TIU	32-4-A
W1HXP	130-38-A	W9ZHL	31-6-A
W1EKT	119-37-A	W1MRF/1	28-5-B
W2DZA	117-39-B	W3FBH	28-8-A
W8CVO	114-8-A	W3AXC/3	25-7-A
W2MLM/2	112-17-B	W2MOF	24-8-B
W1CQY/1	108-13-A	W1MRF/1	22-1-A
W3AXU	105-11-A	W8RFW	22-2-A
W2FZA	103-40-B	W1CEA	20-10-A
W1IUI/1	100-24-A	W3BRZ	16-3-B
W2CUZ	94-19-A	W1P	16-2-A
W2MES	91-35-B	W1P	14-5-B
W2MIV	71-25-B	W1MNC	10-3-B
W3ABS	69-10-A	W2HZP	6-3-B

below each carried a message to its destination. Asterisks mark those routes by which a reply was returned to the originating station. In some cases the return route may have differed slightly.

W1EKT-W1HXP-W1HDQ-W2ILK/2-W3HOH-W3ABS-W3BZJ-W3HWN-W8EUO/8-W8CIR; W1KIK/1-W1HDQ-W2CUZ-W3BZJ-W3FQS-??-W8CIR-W8QUO/8-W8QDU-W8CVQ-W9VHG; W1AKD/1-??-W1HDQ-W3AXU-W3BZJ; W1MEM-??-W2GHV-W3BZJ-W3FQS-W3HWN-W8EUO/8-W8CIR; W1MBS-W1AUN/1-W1HDQ-W1IJ-??-W1MRF-W2DKJ/2-W2MES; W1COO-W1LSN-W1MDN-W1AUN/1-W1KIK/1-W1HDQ-W2GHV-W2CUZ\*; W1JJR-??-W1HDQ-W2ILK/2; W1ELP-W1IUI/1-W1COO; W1JLK-W1MDN-W1GQV-W1CEA; W1JK-W1LSN-W1MDN-W1EKT-W1KH; W1KH-W1LPP-W1JDV-W1JK; W2MUU-??-W8CIR-W8QUO/8-W8QDU-W8CVQ-W9VHG; W2LJT-W2DKJ/2-W1MRF-W1IJ-W1HDQ; W2ADW-??-W1HDQ-W1EKT-W1AUN/1-W1MBS-??-W1GEJ-W1SS; W2ILK/2-W3HOH-W1HDQ; W2USA-W2DKJ/2-W2HRP-W1MRF-W1IJ-W1HDQ-W1HWH; W3AXU-W3BZJ-W3FQS-??-W3HWN-W8EUO/8-W8CIR-W8QUO/8-W8QDU-W8CVQ-W9VHG; W3BRZ-W3HWN-W8CIR-W8QDU-W8MDA-W8CVQ-W9VHG; W3BZJ-W3HWN-W8CIR-W8QDU-W8MDA-W8CVQ-W9VHG; W3HHC-??-W3BZJ-W3AXU; W8JLQ-W8QUO/8-W8CIR-W8EUO/8-W3HWN-W3BZJ-W3ABS-W1HDQ-W1HXP; W8RFW-W8CVQ-W8QDU-W8QUO/8-W8CIR-W8EUO/8-W3HWN-W3BZJ-W3ABS-W1HDQ-W1LL; W8CIR-W8QUO/8-W8QDU-W8CVQ-W9VHG; W8EID/2-??-W2GHV-W3HOH-W3HPX; W8TIU-W8TCX/8-W8CVQ-W9VHG; W8JLQ-W8QDU-W8CVQ-W9VHG; W9VHG-W8CVQ-W8MDA-W8QDU-W8QUO/8-W8CIR-W8EUO/8-W3HWN-W3BZJ\*; W9BDL-W9ZHL-W9AQQ.

Continued on page 70)

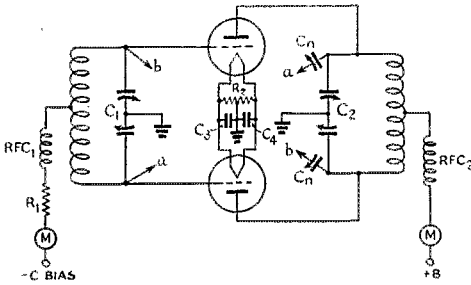

Fig. 1 — The Ordinary Series-Fed Circuit.

- C<sub>1</sub> — 200  $\mu$ fd. per section, 0.077-inch spacing (National TMC-200D).
- C<sub>2</sub> — 100  $\mu$ fd. per section, 0.344-inch spacing (National TML-100B).
- C<sub>n</sub> — 2.5- $\mu$ fd. capacity at 0.6-inch spacing, disc type neutralizers.
- C<sub>3</sub>, C<sub>4</sub> — 0.01- $\mu$ fd. mica by-pass condensers.
- R<sub>1</sub> — 5000-ohm grid leak, 50 watts.
- R<sub>2</sub> — 100-ohm center-tapped resistor.
- RFC<sub>1</sub> — 2.5-mh., 125-ma. r.f. choke.
- RFC<sub>2</sub> — 1-mh., 600-ma. r.f. choke.

## Why Not Parallel Feed?

### A Comparison with Series Feed in Transmitter Circuits

BY T. M. FERRILL, JR.,\* WILJI

WITHOUT risk of serious contradiction, the author considers the points of highest importance in transmitters of any power class to be efficiency, cost, compactness, and dependability. If a good design, based on the first three of these considerations, is properly constructed with quality parts, dependability will result.

Economy, efficiency, and compactness depend a great deal on the circuits used. A quick glance at the photograph will give a clear comparison between two push-pull amplifiers of the same power and efficiency, but with marked contrast in compactness and cost. The same tubes are used, operated at the same plate voltage, excitation, and grid bias, with the same *L/C* ratios, and on the same frequency.

The important difference between the two circuits lies in the use of parallel feed in the plate and grid circuits of the compact amplifier. The other unit, operated at equal efficiency and equal power, but using a base twice as large to hold the bigger parts, uses conventional series-feed in plate and grid circuits.

One important feature in transmitter design is the degree to which the operator is protected from death-dealing shock. The two r.f. amplifier designs shown contrast strongly in this respect — the parallel-feed system is far safer. Even without the economic reasons, increased safety alone should stand as a sufficient reason for choice of parallel feed. Strangely enough, an amateur who would not tolerate the risk of bare 110-volt a.c. wiring in his home too often will scarcely give a thought to exposed 2000-volt transmitter circuits almost asking to be touched!

With several advantages of the parallel-feed r.f. amplifier pointed out, let's go a bit further into detail on how much is to be gained by use of

parallel feed, and why these benefits result. To begin with, this is an old-timer among transmitter circuits — as old as Hartley oscillators. Although parallel-fed circuits were very popular many years ago, they are seldom found in modern medium- and high-power amateur transmitters.

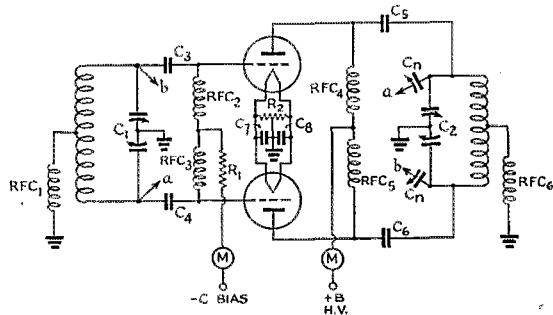

Fig. 2 — The Parallel-Fed Circuit.

- C<sub>1</sub> — 350  $\mu$ fd. per section, receiving spacing (National EMCD-350).
- C<sub>2</sub> — 100  $\mu$ fd. per section, 0.171-inch spacing (National TMA-100DA).
- C<sub>n</sub> — 2.5- $\mu$ fd. capacity at 0.3-inch spacing, disc type neutralizers.
- C<sub>3</sub>, C<sub>4</sub>, C<sub>7</sub>, C<sub>8</sub> — 0.01- $\mu$ fd. mica receiving by-pass condensers.
- C<sub>5</sub>, C<sub>6</sub> — 0.001- $\mu$ fd. mica, 5000-volt working condensers (Aerovox 1654).
- R<sub>1</sub> — 5000-ohm, 50-watt grid-leak resistor.
- R<sub>2</sub> — 100-ohm, center-tapped resistor.
- RFC<sub>1</sub>, RFC<sub>2</sub>, RFC<sub>3</sub>, RFC<sub>6</sub> — 2.5-mh., 125-ma. r.f. chokes.
- RFC<sub>4</sub>, RFC<sub>5</sub> — Special transmitting r.f. choke (National R-175).

The reason for this is the fact that amateurs nowadays build their transmitters for multi-band operation, and the pie-wound chokes in almost universal use are nearly always unsatisfactory for

\* National Company, Malden, Mass.

parallel-fed high-power circuits at 14 and 28 Mc.

About the only strain to which chokes are subjected in the series-fed circuits is the heating effect of the d.c. plate current. The chokes usually are rated only in terms of d.c. current-carrying capacity, d.c. resistance, and inductance measured at low frequencies. Connecting a conventional r.f. choke across a high-power transmitter tank invariably results in marked inefficiency at the high-frequency amateur bands—and the choke usually burns up in a hurry!

With series feed, the r.f. voltage across the choke is a very small fraction of the r.f. tank voltage, but with parallel feed half or all of the tank voltage, depending on the circuit, is across the choke. Unless the choke has very high impedance at 28 and 14 Mc., as well as the three lower-frequency bands, the r.f. amplifier efficiency will be low and the choke will be short-lived.

If the amplifier is used only on the lower frequencies, ordinary pie-wound chokes may be used successfully and the advantages of parallel-fed circuits may readily be obtained. Similarly, solenoid-type chokes may be wound for transmitters working on one, or perhaps two, bands at the high-frequency end of the ordinary communications spectrum, the proper number of turns and type of winding being determined experimentally. However, if the same transmitter is to be used on all five bands the construction of a choke which will provide high impedance and efficient operation over such a wide frequency range is a prime necessity. Consideration of this problem led to the development of a choke of the type shown in the photograph. With fewer turns of smaller wire single-layer wound on a

**A parallel-fed r.f. amplifier can operate just as efficiently as one with series feed. Among the advantages to be gained, not the least is lessened danger from accidental shock. For the others, read this article.**

special form, this choke has low d.c. resistance and can stand the full r.f. voltage across a high-power tank circuit without overheating or sparking. The design is the result of a considerable amount of experimental work, in the course of which it was found that, although the construction is simple enough, the performance depends critically upon the number of turns per section and the dielectric constant of the form on which it is wound. Even the wire size must be held to a closer tolerance than is ordinarily the case with common gauge numbers, and substitution of other materials for the ceramic form probably will necessitate some revisions in the coil sections. For the benefit of those who might want to "roll their own", the data on the original wooden-form choke from which the final model was developed are given in Fig. 3.

There is more difference between the circuits of these two amplifiers than just insertion of new r.f. chokes. The series-fed circuit of Fig. 1 has been in very common use during several years past. In it, no attempt has been made to minimize voltage across tuning or neutralizing condenser sections, and no thought is given to precautions for the operator's safety.

Three measures can be taken to remove the

*(Continued on page 78)*

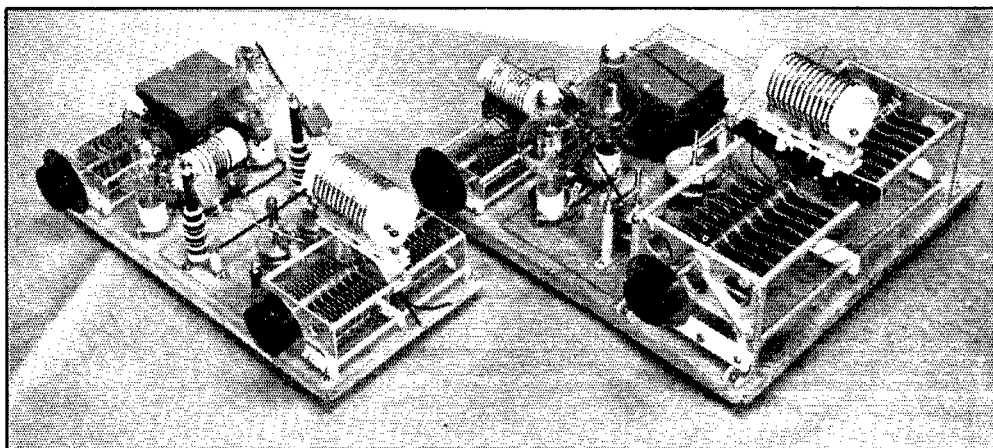

At the right, a conventional r.f. amplifier with series-fed plate and grid circuits. Note the large tank and neutralizing condensers required; these are not only expensive and inconvenient, but the capacity ranges obtainable are limited and the large size makes them poorly adapted to high-frequency circuits.

The same supply and modulating voltages may be used in the parallel-fed amplifier at the left, in spite of the small plate spacings of the variable condensers. Greater compactness (with a base half as large), lower cost, better circuit arrangement, and more operating safety are features of this parallel-fed amplifier.

# Predictions of Useful Distances for Amateur Radio Communication in January, February, and March, 1941

National Bureau of Standards  
Washington, D. C. \*

THESE predictions are for maximum and minimum useful distance ranges in the five amateur frequency bands regularly useful for long-distance sky-wave transmission during January, February, and March 1941. For a discussion of sky-wave transmission see Letter Circular 614 of

\* Report prepared by N. Smith, F. R. Gracely, and A. S. Taylor.

the National Bureau of Standards, "The ionosphere and radio transmission"; it was published in part in *QST*, page 32 of March, 1940. The use of the charts in the present article was explained in the article in the September, 1940, issue, page 26, entitled "Predictions of useful distances for amateur communication."

Propagation conditions during January and

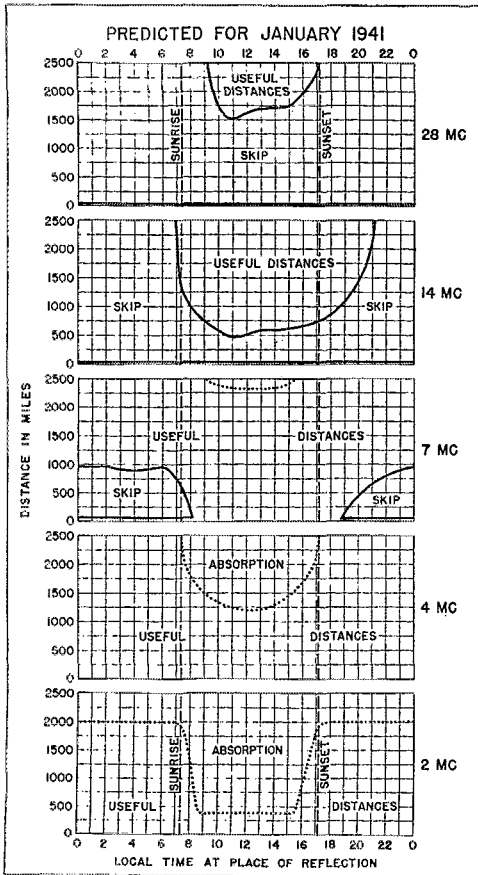

Fig. 1 — Useful distances for radio wave propagation via the regular layers of the ionosphere, predicted for January, 1941. The 56-Mc. band will be useful only for local transmission (optical and quasi-optical paths).

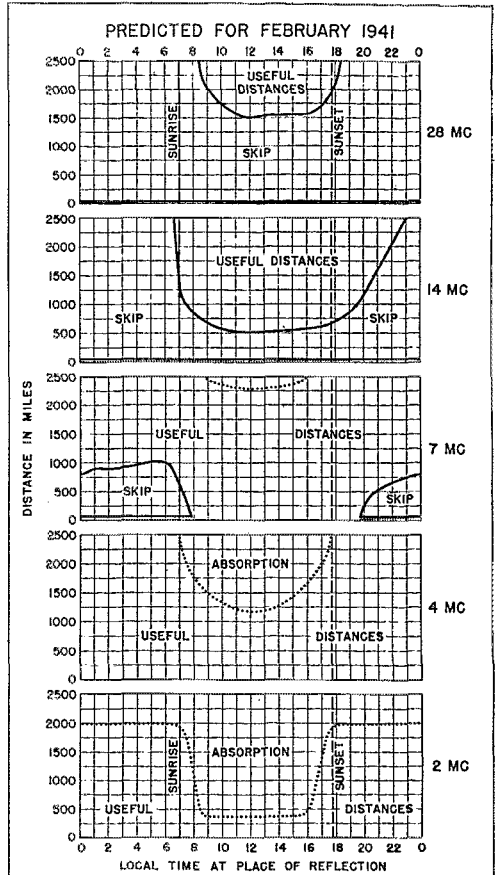

Fig. 2 — Useful distances for radio wave propagation via the regular layers of the ionosphere, predicted for February 1941. The 56-Mc. band will be useful only for local transmission (optical and quasi-optical paths).

February will be of the winter type, similar to those during November and December. The daytime skip distances will be short and the static and absorption small, so that conditions will be favorable for daytime long-distance transmission. The night skip distances will be greater than during the summer and in general conditions will be poor at night on the 14- and 28-Mc. bands. Daytime transmission at 28 Mc. will still be good over long distances.

In March the static and absorption will increase somewhat and the daytime skip distances will start to increase for the approaching summer. Ionosphere storms may also be more likely to cause periods of poor transmission. It should be kept in mind that the graphs represent average conditions for undisturbed days. There will be some day-to-day variations about the average, and on days of ionosphere storms variations may at times be extreme.

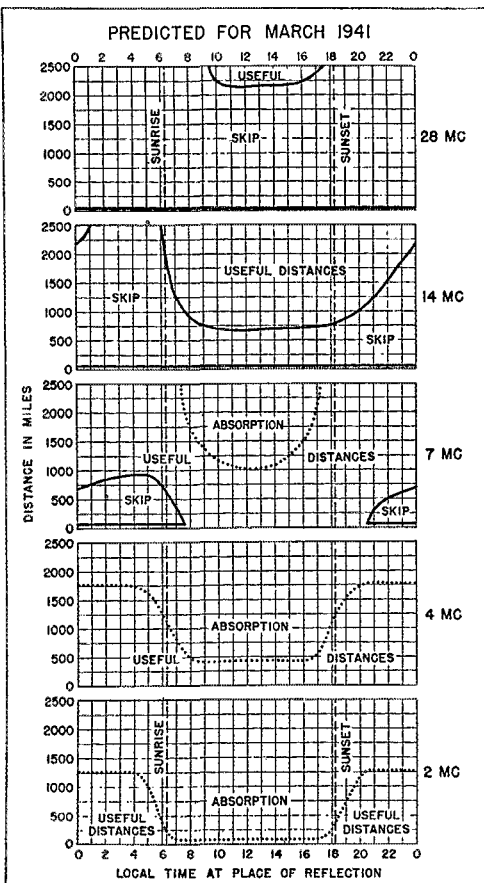

Fig. 3 — Useful distances for radio wave propagation via the regular layers of the ionosphere, predicted for March, 1941. The 56-Mc. band will be useful only for local transmission (optical and quasi-optical paths).

## ★ BOOK REVIEW ★

*The Amateur Radio Handbook (Second Edition).*  
Published by The Inc. Radio Society of Great Britain, 16, Ashridge Gardens, London, N. 13, England. 328 pages, numerous illustrations. Price, 4/2 (5/- by post, abroad, or about \$1.00).

With amateur radio completely closed down, with many amateurs themselves actively engaged in a military service, yet the first edition of the R.S.G.B.'s Amateur Radio Handbook during the past year sold out 3000 copies of a second printing fatefully received from the printer the week following the outbreak of hostilities last September.

In the face of such an amazing demonstration both of the amateur's loyalty and of the genuine merit of the publication, the Society felt itself justified in bringing out a thoroughly-revised second edition. Like the earlier edition, this one will be found not only in ham shacks throughout the Commonwealth, but "in barrack rooms, dug-outs, ship's wireless cabins, research laboratories and workshops." It is accepted as an authoritative instruction manual by many branches of H.M. forces.

The revision enhances the utility of the book as a text somewhat, but in no wise does it destroy the ham spirit or convey any purpose other than that of catering to transmitting radio amateurs. Two entirely new and very useful chapters have been included — one on Workshop Practice which every American amateur could read with profit, and one on Crystal Band-Pass Filters.

As with the previous edition, the emphasis is on theory and fundamentals, rather than practical constructional information. It is therefore an ideal source of technical instruction and training.

The R.S.G.B., the fifteen collaborators and contributors, and in particular Jack Clarricoats, G6CL, the editor, are most heartily to be congratulated on an excellent job done under trying circumstances. The Editor's Foreword concludes: "The Spirit of Amateur Radio shall never fail." They have done their part to make this statement a true one.

— C. B. D.

## Strays

We often see hams climbing over roofs and up poles to make changes in the antenna system, fumbling around trying to get their pliers out of their back pocket. As a rule, the pliers work their way down into the bottom of the pocket where it's difficult to get them out. This trouble can be avoided by just hanging them over the edge — one handle in the pocket and the other handle outside. You might think they would fall out, but my experience has proved otherwise. Any electrician or telephone man uses this trick when he doesn't have a belt. — W8OKP.

### BOUND VOLUME XXIV OF 'QST'

WE have a limited number of Bound Volume XXIV of QST. This volume is made up in two sections, each containing six issues of 1940 QST. Handsomely bound and gold imprinted the complete volume is priced at \$7.50, postpaid.

# Fourth Annual A.R.R.L. Member Party

**Saturday-Sunday, January 18th-19th—Certificate Awards—Get In On Membership Fun—Call "ARRL de . . .", Start a QSO List—Use 'Phone or Telegraph or Both, Any Bands—Try Your Luck; See What You Can Do; Report**

**WE** DON'T ask anybody to shift from c.w. to 'phone, from 'phone to c.w., or from one band to another. Work any or all ways you like best. Try new sides to amateur radio if you wish. Just *take part* and send in the list of calls of members you worked, with the exchanged information (*name* of Section<sup>1</sup> and the *date* their membership expires, month and year) with your claimed score. Just for information tell what frequency bands you worked.

Log forms (not necessary) will be sent free on request to Hq., or rule your own, just three columns listing *calls, Section,<sup>1</sup> dates*. In radio-telephone contacts the Section, membership month and year will be named. No special order is required. It's a "one operator" activity, or separate scores for each operator may be sent in.

Radiotelegraph members will abbreviate Section names and use four numerals to show membership dates. "Conn 0343" will mean "Connecticut Section, my membership good through March 1943" for example. Information to be exchanged in every case comes right off your own *League membership certificate or pocket card*.

League Members only are eligible. It is a family party for members. To get contacts send "A.R.R.L. de . . ." Chat with as many other A.R.R.L. members (anywhere) as possible. The leading member in each Section will receive a Certificate Award. Advance entry is not necessary. Scores can be all by one mode, or part telegraph and part voice — and any combination of frequencies you like. When completing contacts, be sure to add to fraternalism by giving your personal "sine" (c.w.)<sup>2</sup> or nickname ('phone) before your identifying final transmission of your call signal, at the conclusion of QSO's.

One new factor this year: A fixed credit of 50 points may be added to one's score, before multiplier, depending on (1) submitting evidence such

<sup>1</sup> See complete list of A.R.R.L. field organization Sections, in the front of this issue of *QST*.

**Easy to take part. Enjoyable! SWAP name of Section and month-and-year of A.R.R.L. membership expiration; 50 Points (new) for Code Proficiency Evidence. Get in it! Send worked list to A.R.R.L.**

as the date of *having received* a League WIAW Code Proficiency Award, responsive to the A.R.R.L. Member QSO Party Advance Announcement appearing in December *QST* or previous WIAW code-qualifying runs, or (2) submitting with the report or list on this activity, copy made during this Member Activity, at any one of the speeds, on the WIAW run starting at 10.30 P.M. EST, Sunday, January 19th. (Send your copy, however it looks to you.)

**Starting Time:** Saturday, January 18th, 3 P.M. PST; 4 P.M. MST; 5 P.M. CST; 6 P.M. EST or the equivalent time at any point.

**Ending Time:** Monday, January 20th, 12:01 A.M. PST; 1:01 A.M. MST; 2:01 A.M. CST; 3:01 A.M. EST or equivalent.

Operate *any* 20 hours of the 33-hour party. "Time out" is permitted for copying WIAW. State contest hours you did *not* operate if your score is over 10,000.

**Scoring:** 1 point for each complete set of information sent; 1 point for each set of data received and logged. No member can be worked to get more than one complete exchange for 2 points. Add 50 points if you include Code Proficiency Evidence, as explained. The sum of all points will be multiplied by the number of *different Sections*<sup>3</sup> in which at least one member has been worked and exchange effected. A convenient way to keep record of new and different Sections as you work them is to circle and number the name of the Section the first time it is written in your list . . . or mark the list in the front of *QST*, also.

<sup>2</sup> The personal "sine" or sign consists of the initials of the operator, the first and last letters of his name, an abbreviation for his name, or other identifying designation. For example our "sine" is "FH," while our nickname (some prefer "handle") is "Ed." It's fraternal in amateur work and the mark of a real and experienced operator as well to *have* a personal sine and use it. In commercial work, the operators in a given service are often assigned personal identification to use in putting handling data on messages without confusion between two operators of the same name. In amateur work the "sine" has this use but is mainly used for fraternal, as well as convenient *personal* identification.

<sup>3</sup> An example: The multiplier is that number of field organization Sections in which *at least one* A.R.R.L. Member is contacted. Assume W5XXX has completed two-way exchanges with 60 different stations, located in 30 different A.R.R.L. Sections. His multiplier is 30. Each station worked resulted in adding two points. Besides this W5XXX gives the date of his Code Proficiency Award (Aug. 30th, from WIAW), or submits new qualifying copy made Jan. 19th to enable him to claim 50 points. His score is  $2 \times 60 = 120$ .  $120 + 50 = 170$ .  $170 \times 30 \text{ Sec.} = 5100 \text{ score}$ .



The WAS (worked all states) possibilities are unlimited. Fun and new member-contacts are assured. See how many members *you* can work on these dates. If you work anyone not a member, ask him "Why not?" After all, *that* fellow also has a stake in our frequency assignments, and continued operating privileges, and the proper support of the only organization giving insurance or assurance through its program of both representation and activities . . . and he owes it to himself to become a Member. This activity is one of the big annual events. Don't miss it.

— F. E. H.



THE feature article of the January, 1916, issue was "The Oscillating Audion," by Tuska, the editor. Describing the Ultraudion circuit in connection with a long-wave loose coupler having a secondary 10 inches in diameter and wound with 1100 turns of No. 28 wire, it reported the almost unbelievable feat of hearing Honolulu and German stations on an antenna only 50 feet high and 200 feet long. "It is beyond the scope of *QST* to go into the theory of this wonderful piece of radio apparatus. . . . In order that the reader may understand the operation, it is well to say that the audion is used simultaneously as a receiver and generator of undamped waves. The incoming oscillations are received at a definite frequency and are superimposed on a slightly higher or lower frequency of the audion oscillations. For example, the incoming wave has a frequency 100,000 per second and at the same time the audion is generating waves at the rate of 101,000 per second; the result of these two series of oscillations is a musical note of 1000 vibrations per second. This is known as a 'beat' effect. . . . It is difficult to give precise directions for operating the oscillating valve but the majority of amateurs will have no trouble with it. In five or ten minutes they will stumble on the proper combination and get far better results than the writer could suggest. Important: If the audion is operating properly, a sharp click can be heard in the telephones when the point marked X in the diagram (the grid) is touched."

The Correspondence Department, Ham-ads and "Amateur Radio Stations" appeared in *QST* this month for the first time, the latter including a description of the station of Ross Gunn in Oberlin, Ohio. Dr. Gunn is now a physicist at Naval Research. The first story appeared by The Old Man, on rotten testing between amateur stations. Amongst three pages of new members listed, we spot the names of L. C. Herndon, 3SZ, Portsmouth, Virginia (now radio inspector at Seattle), Charles W. Weber, 3AFA,

now W3CC; and Philip A. Bailey, 1WW, now WIBKO.

In the editorials, a Volunteer Radio Corps is projected as a practical way of offering amateur services to the government if the trouble in Europe becomes acute enough to involve the United States. The editor also complains of "new wireless associations while you wait," saying that it seems to be the fashion to announce a new one every few days and calling attention to the fact that A.R.R.L. is not organized for private profit "but entirely for our mutual assistance in telegraphing to each other."

Bunnell and Mesco are the leading advertisers but the best-looking piece of gear is the handsome Navy-type loose-coupler offered by J. F. Arnold: "Will tune up to 3500 meters on a fair-sized antenna." F. B. Chambers & Co. also feature their loose coupler, having a double-slide primary. Brandes' "Superior" headsets are offered as "the great favorite with both professionals and amateurs." The Institute of Radio Engineers advertises their Proceedings as of interest and value to amateurs. The League itself offers for sale its "List of Stations Book," being a complete list of the relay stations of A.R.R.L. "Shows what relay stations are within your range; gives name of owner, complete address, call letters, sending power, kind of gap used, number of words can receive per minute, listening hours, what license is held, telephone connection or not. . . . Indispensable to every amateur whether in Relay League or not."

## WWV Schedules

THE standard frequency station WWV of the National Bureau of Standards was destroyed by fire on November 6th. A temporary transmitter has been established in another building and is carrying on a reduced service which will be in effect for the several months required for establishing a new permanent station.

In the interim, a 1-kilowatt transmitter (the old transmitter was 20 kw.) is broadcasting continuously from 10 A.M. to midnight, E.S.T., every day except Sunday. Transmissions are continuous-wave only, with telegraphic announcements of the call letters WWV every 20 minutes. The accuracy is the same as before, better than one part in ten million.

Until the new permanent station is complete, the 10- and 20-Mc. transmissions will be discontinued as will also the standard second pulses, the 440-cycle musical pitch standard, and the 1000-cycle standard frequency.



W8RME has N. Y. car license plate 73-88. W2IQQ drew FB-88-S.



# ON THE ULTRA HIGHS



CONDUCTED BY E. P. TILTON,\* WHDQ

It is said that there is something of the Crusader in every man of us. Nearly every amateur worthy of the name is a salesman for his hobby, but nowhere else in the whole amateur picture is the booster instinct so pronounced as among the die-hards who work on Five the year around. The true 56-Mc. enthusiast spends the better part of his time selling his band to the devotees of the lower frequencies, in contacts over the air, at hamfests, radio clubs, and even by mail.

When Five opens up for skip DX and word spreads around that another DX season is getting underway, there is little need for crusading. In nearly every part of the country, operators scramble for their u.h.f. gear and take a crack at some of the elusive DX thrills. But during the late fall and winter months, those of us who regard the Ultra-Highs as something more than a three-months DX spree are often hard put to it to find enough activity to keep interest alive.

The going started off in a particularly rocky fashion this fall, with counter-attractions on every hand. Ten crossed us up. Just when it was scheduled to be passing out for a few years, the 28-Mc. band has turned up with some of the best days (and plenty of them, too) in several seasons. In late October and into November the political campaign held the attention of many during the hours ordinarily spent on Five. Operating range on Five shrank, as it always does with the passing of summer and early fall inversions. All in all, the regular occupants of Five found little to get enthused over as they went into November.

Particularly lacking in consistent nightly activity was the area within a 50-mile radius of New York City. Once the scene of almost unbelievable turmoil in early days on Five, the Greater New York area was too often a complete blank as far as 56-Mc. signals were concerned. This aroused the crusader instinct in several of the gang of W2 and W3. We have been unable to get anyone to claim responsibility for the movement, but we have heard that during early November just about everyone who was known to have operated 56-Mc. gear within the past two years received a card asking him to join in a series of Tuesday-night Roundups, beginning on November 12th. Everyone who was contacted on Five was told of the plan and asked to be on deck. No special program was arranged, no "net" operation planned; everyone was just invited to fire up the old rig and get acquainted again. The result? Well, the Tuesday Niters have had two

sessions of it as this is being written, and we find 34 calls listed in the reports sent in by several of the gang. They are listed below:

W2ACR	Millburn, N. J.	W2JPX	Larchmont
W2AMJ	Bergenfield	W2KKE	Bronx
W2AQA	Bronx	W2LAL	W. Englewood, N. J.
W2AWO	Corona, N. Y.	W2LAU	Summit, N. J.
W2BGX	Flushing	W2LRE	St. Albans, N. Y.
W2BW	New York City	W2LXC	Whitestone, N. Y.
W2CLA	Garden City	W2MEU	Union, N. J.
W2CVF	Ridgefield Park, N. J.	W2MO	Livingston, N. J.
W2DAJ	Jamaica	W2NFT	Elmhurst, N. Y.
W2DIO	Brooklyn	W2QG	Forest Hills
W2FHJ	Bronx (YL)	W2QZ	Bronx
W2FJQ	South River, N. J.	W2TP	Leonia, N. J.
W2FVV	Elmhurst, N. Y.	W3ABS	South Branch, N. J.
W2GHV	Dumont, N. J.	W3ACC	Neshanic Station, N. J.
W2GUC	Summit, N. J.	W3ACC/3	So. Boundbrook, N. J.
W2HGU	Ridgefield	W3AXU	Trenton
W2LLK	Staten Island	W3HOH	Bernardsville, N. J.

It will be noted that these calls represent all stages of amateur radio, from the 10-watt mobile W2LLK to the 700-watt W2MO. There are several real old-timers represented, some of those two-letter boys having up to thirty years of hamming to their credit; and there is also the newcomer, W2NFT. Everyone agrees that he hasn't enjoyed himself so much in many a day. No DX there — but no QRM, either — and a swell chance to get reacquainted with the rest of the gang in your own neighborhood. If your call is not on the above list, why not put the rig on Five next Tuesday and join the "Tuesday-Niters"? Nice work, fellows — keep it up!

A somewhat similar lack of regular activity was confronting the occupants of Five in the Boston area. Like New York, this territory was once literally crammed with 56-Mc. enthusiasts, but recent times have seen a considerable dropping-off in daily activity, though not to the extent noted in the New York area. Deciding to see what could be done by concentrating on one particular night, the boys picked Thursday. Each Thursday at 9 p.m., W1DA, Lynnfield, Mass., calls the gang together. November 7th saw less than ten stations active. The following week 22 stations responded, with this number or better each week since. A snappy round-table follows the first call, following which the gang breaks up for general QSO's. No official name has as yet been approved but the suggestion of W1JTB, "Persistent Five-Meter Cusses" is finding favor! They include the following W1's:

AOZ	Melrose, Mass.	58,560
BJB	Brookline, Mass.	58,120
COX	Lowell, Mass.	56,100
DA	Lynnfield, Mass.	56,966
DJ	Winthrop, Mass.	56,080
DID	Andover, Mass.	56,916

\*329 Central St., Springfield, Mass.

DXK	Clinton, Mass.....	
EHT	Stoneham, Mass.....	56,220
EKT	Wakefield, Mass.....	56,500
GAQ	Boylston, Mass.....	58,400
HUV	Winchester, Mass.....	56,200
IIQ	Arlington, Mass.....	56,200
IUT	Kingston, N. H.....	57,500
JDV	Nashua, N. H.....	56,632
JLK	North Easton, Mass.....	58,776
JTB	Wayland, Mass.....	57,980
LPF	Lowell, Mass.....	57,724
LTF	Dunstable, Mass.....	
LSN	Exeter, N. H.....	56,816
MDN	Amesbury, Mass.....	57,966
MJ	Wakefield, Mass.....	57,384

This list was taken from a report of the second week's activity. Many more calls have been added recently. If you are located within 50 miles of Boston, you are cordially invited to join these Thursday-night sessions. The boys are particularly desirous of hearing from some of the gang south of Boston.

The month of November provided little in the way of operating thrills. There were a few scattered reports of sporadic-E skip. W5VV, back on the job at Austin, Texas, reports the band open on November 8th; contact being made with W6OVK, Tucson, Ariz., at 9:42 P.M. C.S.T. Harmonics from Ten were heard by W6OVK and W6QLZ on November 18th, but no contacts were made. W2AMJ was reported heard by W9NFM on November 21st. Short skip of summer-time proportions was noted on ten on several other occasions, but lack of activity on Five in the right places very likely was responsible for the scarcity of 56-Mc. reports. One we missed in October is reported by W8RUE, Pittsburgh, Pa., who heard W9WTL on October 21st.

The first session of the "Tuesday-Niters" was marked by the first pronounced aurora refraction of the season, but the boys were so busy working each other locally that they paid little attention to the DX. The familiar broadness of signal and fuzzy quality of speech on all but purely local signals were first noticed by several W1's shortly after 7 P.M. Only a few of the gang recognized the symptoms of aurora and went to c.w. Despite all that has been said and written about this type of refraction, not more than half a dozen of the fifty or more stations active in the area affected realized what was up. Most of them continued to attempt to get through on voice or tone modula-



"When good fellows get together." George Sperry, W9CBJ (left), and Ed Grabill, W9ZHB, at the "Ham-festers" Picnic last August. Note tags, "I'm on Five Meters."

tion, though repeated experiences have proved that c.w. is the only effective means of communication under these conditions.

W8CIR provided the only DX contacts that we have heard about. Contacts with Ed were made by W1HXP, Newton, Mass., 450 miles; W1HDQ, 400 miles; W1LLL, Hartford, Conn., 390 miles; W8FDA, Pottsville, Pa., 200 miles; and possibly some others. All were made on c.w. W8CIR was apparently heard over most of the northeastern part of the country, at least wherever the boys were on the job with the b.f.o. A few missed hearing anything because they forgot that aurora signals come in from the north, and turned their beams toward the southwest, instead. The signals of the "Tuesday-Niters" were audible, but unreadable, over most of New England, the band being full of carriers of W2's even up as far as New Hampshire.

We quote a gem heard from a certain W1 who had just been told about the aurora refraction on the band: "— So that's why everyone sounds so lousy! I heard Ed calling 'CQ Aurora,' but I thought he meant Aurora, New York!"

### U.I.F. DX RECORDS

#### Two-Way Work

- 56 Mc.: W1EYM — W6DNS, July 22, 1938. 2500 miles.
- 112 Mc.: W6BJI/6 — W6KIN/6, July 4, 1940. 255 miles.
- 224 Mc.: W6IOJ/6 — W6LFN/6, August 18, 1940 — 135 miles.
- 400 Mc.: W6IOJ/6 — W6MYJ, September 23, 1940 — 11 miles.

### HERE AND THERE:

**T**HE Boston-Washington relay circuit mentioned last month is gradually taking shape. Each Friday night, messages for W1EI/3 are started from Natick, Mass., by Mel's brother, W1QB. A reliable net has been lined up as far as Wilmington, Del., but from here on the going has been not too successful, to date. More stations between Wilmington and Washington are needed before the net can be considered reliable. Mel reports things rather quiet around Washington, with W3AWM and W3IHW most active. W3CIC is on occasionally. What has become of W3DBC, the Washington rock-crusher, and that old standby, W3RL? W3EIS tells us that he is moving to a new home in Arlington.

**U.H.F. MARATHON**  
OCTOBER WINNER: W3HOH,  
BERNARDSVILLE, N. J., 146 POINTS

Call	Contacts Through October			Cumulative Score	States in 1940
	56	112	224		
W1AFY	23		3	68	2
W1CGY	52			138	5
W1DJ	102			163	4
W1EHT	60			91	3
W1EKT	115			311	12
W1ELP <sup>1</sup>	37	53		306	12
W1HDF	31	12	4	374	13
W1HDQ <sup>2</sup>	208	57	1	1435	24
W1HXP	—	—	—	—	20
W1JJR	110	4	3	588	17
W1JKK	90	28		203	6
W1JP	1	31		75	3
W1KLJ	239	7	5	1291	24
W1LLL	149			849	20
W1LPP	65			134	7
W1LSN	58			139	14
W1MBS		160		348	3
W1MEP	28			90	7
W2ADW	16	27		170	4
W2AMJ	191			878	24
W2BYM	45	7		251	15
W2BZB	32	115		314	5
W2COT	127	12		285	7
W2DZA		116		232	5
W2GHV	122			590	21
W2LAL	95			220	11
W2LXO		131		300	4
W3BZJ	217	58		1345	25
W3CGV	80			237	11
W3EIS	22	13	1	97	5
W3FSM		42		86	2
W3HOH	216	59		847	16
W5AJG	163	6	5	1751	25
W6IOJ	8	95	4	393	3
W6OVK	19			194	7
W6QG	24	4	2	136	4
W6QLZ	58	2		1051	18
W8MHM	32	16	1	112	7
W8NKJ	53	23		397	11
W8QDU	115	50		807	20
W8QCS	63			540	15
W8RUE	78	16		328	15
W9ARN	83			708	20
W9DQH	44			297	17
W9ZJB	137			1351	26

<sup>1</sup> Frequency modulation used exclusively at W1ELP.  
<sup>2</sup> Not eligible for award.

Va., in the spring, and will resume activity on Five as soon as settled. Landlord trouble has been holding Don back recently.

There appears to be a good chance of extending the Atlantic Seaboard Five-Meter Net to Portland, Maine. W1MFK writes that he is listening and transmitting on Five at regular intervals, but is getting nowhere yet. A new converter and beam antenna are under construction which should certainly help matters. John is listening especially for some sign of those Thursday-night sessions in Eastern New England.

November brought high winds and ice storms which were too much for several antenna structures. Known casualties include the eight half-waves in phase at W1HDQ and more serious damage in the loss of all antennas at W8QDU, Detroit. Fred is now off the Ultra-Highs entirely until something can be erected to replace that concentric and extended double zepp, for 56 and 112 Mc., respectively.

Stations in Pennsylvania and New York are gradually being lined up for a permanent relay chain between the east coast and the middle west. Service from New Hampshire to Philadelphia is now definitely assured, but from Eastern Pennsylvania across to the Great Lakes area the route is less definite. Assurances of cooperation have been received from W3BRZ, Lancaster, Pa.; W8FDA, Pottsville; W8OKC, Shamokin; and W8RUE, Pittsburgh. That still leaves us with plenty of mountainous country in Central and Western Pennsylvania to hop over into Pittsburgh. All right when conditions are good, but not the sort of thing for

a reliable relay circuit. Rumors of increasing interest in Central New York may yet provide the solution. Will interested parties kindly get in touch with the writer in order that test schedules may be arranged? In the meantime, effort is being made to get everyone who has gear for Five to put it to work on Friday nights. Just turning the converter to the 56-Mc. range is not enough. Fire up the rig on Five and do some calling, preferably on c.w., at frequent intervals. We feel certain that surprising things will happen if we can get everyone, the country over, to make "Five-Meters on Friday Night" a national slogan.

W8FDA, Pottsville, Pa., heard his first five-meter DX during the aurora refraction of November 12th. Using a straight regenerative detector, Stan logged the c.w. sigs of W1LLL, W1HDQ, W1KLJ, W1HXP, W3BYF, and W8CIR. There were also many unreadable 'phone carriers on the band. These were DX of the aurora variety, as there are not normally many signals heard at Pottsville.

W8RUE, Pittsburgh, has been hearing W8GU, Erie, Pa., and W8GBE, Sherman, N. Y., frequently on their 10 p.m. schedule, so it would appear that if we can get contacts through to Pittsburgh, Ted and W8CIR should be able to get traffic through to Detroit without too much difficulty.

W8OKC, Shamokin, Pa., writes that he works W8FDA nightly on c.w. at 10:45. Bill has worked W3HWN at Mechanicsburg in the past, but has not heard anything of him for some time. He reports W8PIK and W8SBH of Williamsport as likely net prospects. W8QCM, Osceola Mills, who has been on the receiving end of much u.h.f. sales talk by W2MO on 75, has promised to get on Five if he can hear someone to work first. Unfortunately, someone has to start things off. Development of activity on Five in a new area invariably involves plenty of calling and listening—the Crusader angle, again.

There has been plenty of throwing out of chests in Phoenix and Tucson these days. W6QLZ and W6OVK, after over a year of persistent effort, have finally made the grade on Five. Though the distance is just over 100 miles, the country in between is a solid mass of mountains. It is safe to say that if these two fellows can work on Five (and they both run under 200 watts), then any 100-mile path in these United States can be broken down by the right technique. In their case horizontal antennas did the trick, contact being made when W6OVK put up a 3-element (radiator and two directors) array. The boys are working on a daily schedule, now, and we hope that much interesting information will be forthcoming as they observe the changing conditions over this 100-mile mountainous path.

We won't vouch for the authenticity of it, but a little bird told us that Clyde had his receiver up in a tree, making tests on his beam, when he first heard W6OVK calling him on schedule. Clambering down in haste, contact was established, following which Clyde scampered up and down that cottonwood with the agility of a squirrel in order to keep things going each way!

**112 MC.:**

"HARTFORD-BOSTON Link Established on 2½ Meters." This is not recent hot news, but the title of an article appearing in QST for March, 1935! How far have we gone since then, in nearly six years? Hartford to Boston is still considered as a rare feat on 2½, though greater distances are being covered over other paths. We have vastly greater activity in urban areas, but the coverage generally is not materially greater than when work was first started on frequencies higher than 60 Mc. years ago.

Perhaps this is as it should be, for 2½ has largely replaced Five as the ideal band for the beginner. Like Five in former days, 112 Mc. now also offers the old-timer in the game, long since tired of DX thrills, a chance to get back to the essentials of the game; essentials long buried in a maze of technical complications and manufactured gear on the lower frequencies. It is this combination of traits, together with the opportunity for friendly local chats, which has played such a large part in the popularization of the 112-Mc. band in Eastern New England, New York, Philadelphia, Chicago, Los Angeles, and many other areas where ham population is large.

(Continued on page 48)

# November Storms Create Communications Emergencies

## Minnesota Hams Whip History-Making Snows

BY GEORGE K. PRITCHARD\*

MONDAY morning, November 10, 1940, was a perfect day for duck-hunting in the Upper Mississippi Valley, in that region where the great river trails to its end and Lake Superior points down to Duluth.

The air was cool, and rain drizzled down from a slate-colored sky. Scores of hunters slogged through the bottoms of the Mississippi or crouched behind thickets waiting for the southbound ducks.

About noon, the rain changed to sleet, the sleet to snow. Ominous gusts of wind swept down from the North. The mercury began to drop, sharply. Suddenly the Northwest realized that it was in the grip of the worst November storm in its history and that hundreds of persons were literally fighting for their lives.

By nightfall the snow had blocked country highways; by morning, telephone and telegraph lines were down, railroads blocked, death toll mounting. (Before it ended, the storm would take 159 lives.)

Then, as always, amateur operators stepped into the breach. Fred Herman of Minneapolis, W9BPK, received an urgent call from the dispatcher of the Minneapolis and St. Louis Railroad. A passenger train was stalled in mountainous drifts and bitter cold outside Wallace, S. D. Could he contact the conductor? Herman could, and did. At his orders the engine was drained, the crew got its instructions to stand by for orders, passengers were conducted to shelter.

More telephone calls came in. Wives wanted to locate husbands, worried parents sought to find their children, gone on an Armistice Day holiday.

A. E. Swanberg of St. Paul, W9BHY, the Red Cross emergency co-ordinator for Minnesota, began to direct the work of all operators, most of them trapped in their homes by blocked streets and working alone.

The word came in — Willmar, Minn., is without telephone or telegraph communication. So is Watertown, S. D. So is Albert Lea, Minn. Can you get through?

The operators could and did. Twin City com-

*(Continued on page 68)*

\*1000 University Ave., S. E. Minneapolis, Minn.

## Texas Ice Storm Isolates Amarillo

THE newsboys of Amarillo still had the European war on their minds, even though there was bigger news right at home. "Amarillo taken!" they yelled, according to the Associated Press. "Amarillo taken by the enemy — nature," they shouted.

"Panhandle frozen like Finland. Texas flooded but refuses to surrender . . . read all about it!" they croaked.

The residents of storm bound Amarillo did not need to read, the last week of November, to know that power and communications lines had snapped beneath a 3- to 5-inch coating of ice, isolating the city.

Those elsewhere who read of Amarillo's plight did so because amateur radio was on the job.

Dr. William B. Thomas, Jr., W5ECL, and James B. Redfearn, W5AVM, stayed on the air constantly from W5ECL, powering the station from a storage-battery source and operating by light from a neighbor's gasoline lantern. A lengthy eyewitness account by Dr. Thomas was released through United Press.

Pryer C. Smith, W5CYX, who is on the staff of the *Amarillo News-Globe*, received AP dispatches from W5DAM at Dallas for his paper, as well as transmitting Amarillo news to the AP. Reports that fires, started by broken power lines, were burning in several parts of Amarillo were denied by W5CYX, preventing the spreading of rumors.

W5ECL reported that Ted Smith, W5CCJ, also worked night and day with storage-battery power, helping to clear the hundreds of messages pouring into Amarillo.

From Harold Brown, W5IBC, of Slaton, comes this report of a useful bit of work:

"We are located about one hundred and twenty-five miles southeast of Amarillo. . . . Slaton is a division point on the Santa Fe Railroad, and Amarillo is the next division point going North. All train orders concerning schedules, times, etc., originate at these two points, and of course they depend on the telephone line to dispatch their messages. Sometime last Sunday the telephone line went down and left one or two trains running blind between Happy and Amarillo, a distance of some thirty-five miles. One of the local dispatchers (a b.c.l.) went over to the shack of W5INM, who was operating on 160 'phone and asked him to try to get a message

*(Continued on page 90)*



# HINTS AND KINKS FOR THE EXPERIMENTER

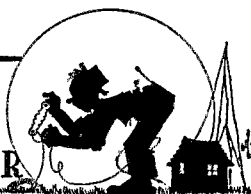

## SIMPLE 28-MC. VERTICAL ANTENNA

Fig. 1 shows a simple vertical antenna which Dr. M. C. Hecht, W9IJX, and several of the boys in the Chicago area have found to be particularly effective for 28-Mc. work. The half-wave antenna is made up from a 10-foot section of thin-wall copper tubing plus a 7-foot "buggy-whip" b.c. antenna. The top end of the lower section is fitted with a bushing to fit the lower end of the top section and the two sections are soldered together so that the total length is  $16\frac{1}{2}$  feet.

The base of the antenna is fastened to the top of a simple 37-foot mast with heavy stand-off insulators so that the bottom of the antenna is a full wavelength above ground. The mast is braced against the side of the house. Immediately below the base of the antenna a waterproof box is attached to the mast. This contains the antenna tank circuit which is connected to the base of the antenna through a feed-through insulator. The coil and condenser are the same size as the corresponding units in the final-amplifier tank circuit. The center of the tank coil is connected directly by a wire one wavelength long to a pipe driven 10 feet into the ground.

This wire should be run in the same vertical plane as the antenna. Grounding helps to balance the transmission line and also serves to give protection against lightning.

The shaft of the antenna tank condenser is fitted with a pulley which is driven from the operating position by a long line of 25-pound-test linen weatherproof fish line. A couple turns of line are taken around the pulley to prevent slipping. The line is guided by screw eyes at appropriate points. With the tuned tank, the antenna is equally effective over the entire band.

The antenna is coupled to the final tank circuit by means of a low-impedance link-line. It is as effective in reception as in transmission.

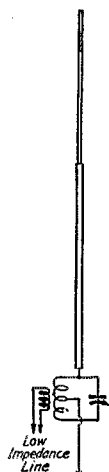

## OSCILLATOR KEYING CIRCUIT FOR CLICK ELIMINATION

Fig. 2 shows an oscillator keying circuit which I have found effective in eliminating key clicks.

Fig. 1 — Simple vertical 28-Mc. antenna used effectively by W9IJX.

Even with a 2A5 at 250 volts, clicks with ordinary cathode keying were ruining reception on all b.c. receivers here — and there are ten of them in the building. In this circuit an impedance  $L$  is inserted between the cathode and ground to prevent oscillation and yet maintain a d.c. connection between cathode and ground. This causes the oscillator tube to draw screen and plate currents continuously and, if the load is adjusted to the correct value, a set of conditions may be found wherein these currents are essentially the same with the key open or closed.

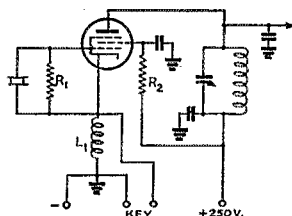

Fig. 2 — Keying circuit used by W5FXO to eliminate clicks.  $L_1$  may be almost any coil resonating in the circuit at a frequency lower than that of the crystal.  $R_1$  and  $R_2$  are the usual grid leak and screen-dropping resistors respectively, 50,000 and 20,000 ohms for a 2A5.

Any inductance which, with the stray capacities connected across it, will tune the cathode circuit to a frequency lower than that of the crystal should prevent oscillation. I use an r.f. coil taken from an old b.c. receiver. The chief disadvantage of the circuit is that the key leads form part of the r.f. return circuit, although it works successfully with keying leads up to at least 6 feet long.

One nice thing about the circuit is that there is no d.c. across the key, so that you can put your fingers across the key without getting hurt. It is a simple job to change over any standard cathode-keying system merely by substituting the coil for the usual by-pass condenser. While I have not tried the circuit with the 6L6, it should work equally well with a coil of appropriate size. However, plate voltage should be limited so that the rated dissipation of the tube is not exceeded when the circuit is not oscillating. — Lucius Smith, W5FXO.

This circuit is quite similar to the one in which a cathode resistance is used instead of the inductance. The resistance method has the ad-

vantage that the key leads may be by-passed, but it is not always possible to find a value of resistance which will stop oscillation and yet not cause considerable difference in plate current when the key is open. — ED.

### AN EASY WAY TO RAISE A MAST

SINCE assistance in mast raising is often lacking, others might like to know how a 60-foot pole was raised at W6QXK by one person unassisted. The general method, discovered by accident, is so simple that it has probably been used in many instances, but perhaps some may not have thought of it.

It was discovered when an attempt was being made to raise a 37-foot pole by sliding it up a 10-foot stepladder, top first, so that the pole would be in such a position that it could be pulled upright with a guy. The center of gravity had already passed the top of the ladder, creating the problem of keeping the base down while continuing to slide the pole over the top of the ladder without too much friction. The eventual result of this was that the pole got away and the bottom shot up as the pole pivoted on the top of the ladder. When the pole finally hit the ground, the top was on the ground and the bottom was sticking up in the air. The halyard had tangled around the bottom of the pole and the end was hanging down far enough to be reached. By merely pulling the base down with this rope, the pole was pivoted into the desired position using the ladder as a fulcrum, making it an easy matter to pull the pole erect with a guy. This pole was made of "two-by-three's" and, though it creaked some and bent considerably, it did not break from its own weight.

This job was so easy that it was thought that, with a fulcrum twice as high, a pole twice as tall could be raised in the same manner. Of course the strain on the mast at the fulcrum would be much greater for a taller pole. In order to see if a 60-foot pole made of the same material could be raised without breaking, the strain was calculated using the density of wood as 40 pounds per cubic foot (actually about 35, but it is best to have lots of safety). This strain for the 40-foot length, which would project beyond the 20-foot fulcrum came out to be about 1500 lb.-wt.-feet. This was applied to a small section of "two-by-three" (150-lb. boy 10 feet from fulcrum). The result showed that some sort of bracing was necessary. Since there were many odd pieces of lumber available, it was decided that the pole should be made strong enough around the point of support so that it would not break of its own weight. This was accomplished by adding lengths of "two-by-three" and "two-by-two" as bracing until the pole was strong enough. The strength was tested with each additional bracing by hanging the pole on a short stepladder at the desired

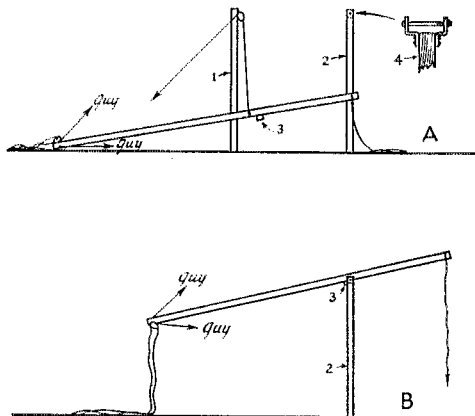

Fig. 3 — W6QXK raised a 60-foot mast without assistance by a leverage arrangement. A shows how the butt end of the mast is hoisted to the top of the fulcrum. B shows the mast partially hoisted into place.

point of support. To be strong enough to support its own weight the pole had to have the thickness of three sticks around the point of support and two sticks halfway up and one stick at the top.

After painting the pole and bracing the joints with bands of No. 12 galvanized wire, the guy wires were put on. Three guy posts were used, each with three wires. One set of wires was 25 feet from the ground, the next 40 feet, and the top set was fastened at the end of the pole. The guys were No. 12 galvanized wire, broken every 12 feet with insulators. The guy posts were each 30 feet from the base of the pole. The length of the wires was calculated fairly closely so that there would not be too much slack while the pole was being raised. The fulcrum was a 20-foot "four-by-five." The top of this fulcrum was fitted with an arrangement something like that shown at (4) Fig. 3-A. In this particular case, a double roller-skate wheel with a guide made of "one-by-two's" was nailed to the top of the fulcrum, to allow the pole to slide as easily as possible. To prevent the pole from sliding too far when being raised, a chock was nailed to the pole at the desired pivot point, 21 feet from the base (see (3) Fig. 3). The fulcrum was raised 6 feet from the peg which marked the desired position of the base. This peg was sunk about 3 feet into the ground and protruded above the ground another foot. It was essential to the raising of the pole.

Now came the biggest problem of all — that of how to get the base of the pole onto the top of the fulcrum. The pole was quite heavy and, in spite of the thickness around the fulcrum, quite limber. Another factor was that the pole was very apt to break near the top, where there was only a single "two-by-three," if it were supported only at its two ends. These problems were solved by erecting another 20-foot "four-by-five," about 12 feet from the fulcrum in line with the fulcrum, peg

and guy post. This "crane" had a pulley arrangement with the pole as shown at (1), Fig. 3 A. To raise the pole to the fulcrum, it was hoisted slowly by the pulley arrangement. As it was being raised, the top end was braced with a 4-foot stepladder which was constantly moved back to keep the pole fairly straight. When the end was brought near the top of the fulcrum, it was guided with a 20-foot piece of "two-by-two."

After the end was securely on top, the pole was pushed from the far end until the hoisting pulley on the pole was even with the fulcrum. The hoisting rope was pulled through the pulley with the aid of a long stick. When this operation was completed, the pole was pushed the rest of the way until the chock hit the skate wheel. The lifting crane was now taken out of the way, and two sets of guy wires were tied off. Then the base of the pole was pulled down toward the base peg. Because of uneven ground, the base hit about 2 feet from where it was intended, but it was lashed firmly in place with a rope around the peg. All that was left was to pull the pole into place with the unfastened set of guys. By fastening a long rope to the top guy and another to the middle one and getting off about 50 feet or so, the pole was pulled up with very little difficulty. After the pole was straightened a bit, the base was moved over to the peg by merely lifting and pushing.

The only equipment needed to raise poles up to about 40 feet by this scheme is a 10-foot stepladder. — *Bill Snyder, W6QXK.*

— . . . —

### E.C.O. COUPLING CIRCUIT

I HAVE found the circuit shown in Fig. 4 very efficient for coupling an e.c.o. to a former crystal oscillator. Coupling the e.c.o. to the rig is somewhat of a problem when the transmitter is

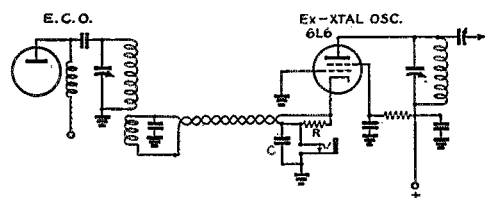

Fig. 4 — Coupling circuit between e.c.o. and crystal oscillator used by W9ERN to eliminate tuned input circuit and prevent oscillation in the crystal-oscillator circuit.

located at some distance away. Ordinary link coupling, while efficient, requires the use of an additional tuned circuit at the transmitter. This circuit eliminates this tuned circuit, and provides good coupling efficiency. Since the control grid of the crystal oscillator is grounded, there is no danger of oscillation when the 6L6 is operated as a straight amplifier. — *John Clemens, W9ERN.*

(Continued on page 88)

## On the Ultra Highs

(Continued from page 58)

From W9AVE comes word of a gathering of u.h.f. enthusiasts to be held in the Sherman Hotel, Chicago, on the evening of January 9th. Primary purpose of the meeting will be the encouragement of activity on 112 Mc. Main event of the evening will be a talk by Bill Conklin, W9BNX. There will be demonstrations of equipment and discussions of u.h.f. problems. The meeting, open to all, will be sponsored by a group of operators who are active in 112-Mc. work.

We have some additional data on the contact between W1MON and W2LAU mentioned in last month's column. From W2LAU, we learn that W2MPQ and W2PP, both of Irvington, N. J. (5 miles east of W2LAU), heard W1MON during the record-breaking contact. W2MPQ reports that W1MON reached 88-9 peaks at Irvington, but that the signal had "a very fuzzy quality," indicating the possibility of aurora refraction in this 200-mile work. As aurora conditions will certainly be in evidence frequently during the next few months, everyone who is active on 2½ is asked to be on the lookout for unusual signals of any sort. If you hear anything out of the ordinary on 2½, note the conditions carefully and send your observations to your conductor as promptly as possible. We should learn much on 2½ in 1941.

### 224 MC.:

FROM W8IPU, Lakewood, Ohio, comes word of two-way work over a 15-mile path with W8UKS at Lorain. Both stations are using Kraus "Square Corner" reflectors. The transmitter at W8UKS is a pair of HK-24's in a push-pull oscillator, while W8IPU is running crystal controlled 24's as push-pull triplers, the rig starting out with a 4.7-Mc. crystal. The receiver is a National 1-10. W8UKS uses a single 955. Signals are strong at both ends, and more consistent than those obtained on 28 Mc. with similar power. These fellows are situated on the curving coast of Lake Erie, and appear to have a fine chance for some long-haul work with W8GU and others, or even up to Buffalo for a new record.

W2HWH, Jackson Heights, L. I., who puts a fine signal up to W1HDQ on 2½ on occasion, says he has two rigs ready to go to work on 224 Mc.

As you read this, another year will just about be over. 1941, with another edition of the U.H.F. Marathon, will be just around the corner. Complete rules for the 1941 Marathon appear in this issue. There are a number of changes to increase interest and permit more prompt reporting in QST. Your monthly reporting will be made easier through the use of the standard reporting form which is available to any amateur without cost. Keep one of these sheets tucked in the regular log-book and, whenever a new contact is made, enter it on the report form at the same time it is entered in the station log. At the end of the monthly period just slip it into an envelope and mail it to Headquarters.

As we come to the close of our first full year of editing "On The Ultra-Highs," may we take this opportunity to thank all those whose letters, reports, and helpful suggestions have made this department a success. A happy holiday season to you, and success on the Ultra-Highs in 1941 to all!







# CORRESPONDENCE FROM MEMBERS

The Publishers of *QST* assume no responsibility for statements made herein by correspondents.

## ARMY TRAINING SCHOOL

Fort Monroe, Va.

Editor, *QST*:

There has been much written about the time when amateur radio is to aid the Army. The Army is already aiding amateurs by sending them to school.

Any ham who wants to get in this "get-paid-as-you-learn" school merely has to enlist in the Coast Artillery Corps and come to the Coast Artillery School at Fort Monroe, Virginia. When you enlist, be sure you are enlisting in the Coast Artillery Corps and don't accept a substitute. After you enlist, there is a short period in which you are taught the basic principles of soldiering. As soon as you arrive at your outfit, see the Battery Commander and tell him that you wish to attend the Coast Artillery School. You will be given a fairly easy examination and then sent to the school.

Here you will do nothing but go to school — from 8 A.M. to 4 P.M., with an hour out for lunch. There is a study period from 6 P.M. to 8 P.M. The Radio Course was originally a ten-months' course, but has been condensed into a three-months' course. After covering elementary basic principles, study is given to such topics as: Design of Audio Amplifiers, High Frequency Amplifiers, Detection-Receiving Systems, Rectifiers and Power Apparatus, Oscillators, Transmitters, Antennas and Transmission, and Ultra High Frequencies. There is also an interesting subject, Servicing and Instruments, in which is covered the use and operation of practically all instruments used by radiomen. Special attention is given to the use and operation of the oscillograph. There is a well-equipped laboratory in which you can see the theory at work.

The course is divided into two sections. One section has no code at all; the other section puts in about three hours at code practice each day. Receiving practice is given by means of recorded signals, graded to suit beginners and experts. Time is also given to the delicate art of "bug-slapping."

Upon graduation the students are promoted to Staff Sergeant (Radio) as needed, which means an increase in pay of about 140% and paves the way for further advances that compare favorably with the best that most of us could have hoped for in civilian life. As one ham to another, I can heartily endorse the opportunities for education and a career to be found in this work.

— Jack W. Adams, Staff Sgt. (Radio), W3IWG

## "RARIN' TO GO"

Chelmsford College, Arbour Lane, Chelmsford, Essex, England

Editor, *QST*:

In these unfortunate days, after experiencing the longest enforced period "off the air" that I can remember as a radio amateur in twelve years of continuous operating, I feel that you might like to know how the "G's" are carrying on.

As you know, a great many of the amateur fraternity are serving with the various forces. Others are engaged in research work and production jobs. Whenever and wherever conditions permit, amateurs stage meetings and yarn about "the good old days" on the air. The enthusiasm and belief that one day the ether will ring again with our crystal notes is unabated by present world conditions. A large number of Dominion and Colonial hams have been able to make personal contact with friends whom they had encountered first over the air, and we have been proud to know these boys and give them a welcome.

Local District and Town meetings of the R.S.G.B. continue and, in the circumstances, are well attended. Everywhere enthusiasm is high and amateur progress in U.S.A. is followed and discussed eagerly.

Of course, with the ever present possibility of heavy objects being apt to fall in a somewhat disconcerting manner from a sky which, in happier times, yielded much goodly DX — or at worst some real English weather! — the conditions of life are slightly changed and a fellow has to get acclimated.

There are, however, some things without which one just could not get along — and *QST* is certainly one of these! Every month it brings real pleasure to those of us who are, perforce, off the air but "rarin' to go!" when the ban is off.

So good luck to you over there — and CUAGN before so long!

— R. L. Varney, G5RV

## B.C.L. QRM

Middle Road, North Haven, Me.

Editor, *QST*:

The letter from W9JGZ in September *QST* strikes home with me, and I wish to affirm Mr. Kingery's statements.

For you fellows who live in metropolitan districts, just make note of the frequencies of your popular local b.c. stations, then add 460 kc. to each and tune in each resulting frequency.

In every case you will find the wierdest, wickedest mess of cat calls one could imagine. Yours truly resided in Fall River, Mass., for several years. The local station operated on 1450 kc., the resultant being 1910 \* (variation being due to misalignment or odd i.f. frequencies).

Many carriers were noted, some being S8 to 9, which, as you low-powered 160 boys will check, is tough on the flea-powered (or emergency) stations.

Just keep in mind that the l.f. oscillator in these cheap a.c.-d.c. and even in some straight a.c. superhets operates the 1st detector frequency + the i.f., and in 9 of 10 cases the coil is unshielded and there is no r.f. stage to isolate the mixer from the antenna. . . .

Just try to tell the b.c.l. listener his set offends and see where you get!

Let's all push together for elimination of all this unnecessary QRM! . . .

— S. H. Beverage, W1MGP

## HAMS IN SERVICE

Chelsea Naval Hospital, Chelsea, Mass.

Editor, *QST*:

After reading your "It Seems To Us" editorial in November *QST*, I thought I would attempt to congratulate you on such a fine bit of reading.

You are absolutely right about the preference for hams in this draft business, at least in Uncle Sam's Navy. Here is an example of what the instructors in Submarine Sound Operators School think of the hams:

Upon entering the S.S.O. school, the students were given an application blank to fill out. Out of a starting class of 31 men, three of us were recommended for the Submarine Sound Material (Servicemen) grade even before we completed the operators' class, which lasts two weeks. Now, if that statement doesn't prove that the hams have something "on the ball," I'll pull the switch. . . .

If some of the fellows think that there are no chances for advancement for the hams going into service under the

(Continued on page 76)



# OPERATING NEWS



F. E. HANDY, W1BDI, Communications Mgr.

J. A. MOSKEY, W1JMY, Asst. to the Coms. Mgr.

**New Year's Resolutions.** We could write a page on this subject, but we know you couldn't keep so many resolutions. We couldn't ourselves. So let's boil it down to this: We're going to try to use the great privilege of Amateur Radio Communication in 1941 in such a way that we train ourselves to be more useful operators to Uncle Sam (and to ourselves). Suppose we ask ourselves a personal question: "If I was the *only* radio amateur would my use justify the license? Would the service that I give others, would the training that I give myself by use of my station authorization, be adequate to prove my case of 'public interest, convenience and necessity' under which F.C.C. grants me a station license authorization?"

The American Radio Relay League has represented the amateur in the government councils for many years, has sent witnesses to testify at public hearings and has proved the case of "public interest" for the fraternity. It must be remembered, however, that the case for the group, after all rests on the collective performance of the individual amateurs.

Are you supporting the one institution that is the sole institution to represent you? Are you up and doing things in the framework of that organization, the A.R.R.L.? Are you registered in the Emergency Corps? Do you belong to the A.A.R.S. or N.C.R., or participate in A.R.R.L. Net or private scheduled operations that are in the public interest, or give self-training? Have you your Code Award Certificate? Do you in other special ways advance yourself and the public interest? Only if you can truthfully say "yes" to some of these things can you be sure you belong to the number helping to preserve our amateur radio and keep it alive in the face of adversity within the vision of our founders by each amateur being able to justify his grant of authority by his actions.

Let us resolve to dedicate at least part of our operating time to constructive (as opposed to careless and purely selfish) activity; let us add our weight to the positive side of the record and not be found dragging our feet!

**Amateurs Invited to Work WAR.** On December 3rd WAR (4025 kcs.) established communication with W1AW, exchanging formal messages signaling the beginning of a program making possible informal contacts between the official station of the War Department and radio amateurs. A.R.R.L. President George W. Bailey took the key of W1AW, sending a personal e-

sponse to the message to the League on behalf of all amateurs. The message from the Chief Signal Officer was as follows:

This message initiates the exchange of contacts between War Department Net Control Station WAR and amateur stations as represented by W1AW, the A.R.R.L. Headquarters station. It is my sincere hope that these contacts will help to foster closer relations between the Signal Corps and the Radio Amateur for mutual benefit. Very 73 to all.

MAUBORGNE, Chief Signal Officer.

WAR's schedules for contact with amateurs are Tuesdays, Wednesdays, Thursdays and Fridays. 4025 kc. is used for 80-meter band contact, 7 to 8 P.M. EST. 13,320 kc. will be tried for 14-Mc. band amateurs, 10 to 11 P.M. EST. Distinctive acknowledgment cards will be sent to all amateur stations contacted. The call CQ ZCAA, followed by a band designation, will indicate when WAR is ready for amateur calls. Traffic will not be handled except requests for A.A.R.S. information or application blanks to be routed via Corp Area offices, since it is hoped to work as many amateurs as possible.

**NAA-Amateur Schedule Extended.** The frequency-day schedule for work with radio amateurs from NAA has been extended "as is," so the contacts taking place may continue until further notice. On the most recent night of operating we observed that the bands were *hot* with amateurs calling NAA and WAR! The battle is on to see who in one's community can *first* win a real QSL from one of Uncle Sam's key stations. We have the one from NAA — and now to follow the new information and get the mate for a prominent place in our collection. See the tabulation giving both NAA and WAR schedules in this issue. Give them a buzz on their next schedule.

**Coming Activities.** See full details of the big January activity, the A.R.R.L. Member Party elsewhere in this issue. In February comes another popular operating activity, the 1.75-Mc. W.A.S. Party is scheduled.

Dec. 17th, W1AW Code Proficiency Qualifying Run.  
Jan. 18th-19th, 4th Annual A.R.R.L. Member QSO Party  
Jan. 19th, W1AW Code Proficiency Qualifying Run.  
Feb. 15th-16th, 1.75-Mc. W.A.S. Party.  
Feb. 21st, W1AW Code Proficiency Qualifying Run.

Fifty points fixed credit will be granted those taking part in the February W.A.S. doings (as in the Member Party) for holding an A.R.R.L. Code Proficiency Certificate, or submitting "copy" on either the January or February qualifying runs, *with special mention of the desired*

*credit* prominently noted on that copy. If not made until February, a 1.75-Mc. Party participant should hold his report on Feb. 15th-16th work and clip Feb. 21st copy to that report.

**WIAW Code Proficiency Runs.** The code *practise* continues daily, except Friday, starting 9:15 P.M. CST. 1762-3825-7280-14253-28510 kcs. are used simultaneously, so you can pick the best frequency to copy. The next *qualifying* runs follow transmissions at the usual practice time, qualification copy starting at 9:30 P.M. CST:

January 19th, Sunday  
February 21st, Friday  
March 21st, Friday

April 17th, Thursday  
May 14th, Wednesday  
June 17th, Tuesday

State on copy if you are working for a first certificate or for endorsement. Underline the full minute of perfect copy that you believe qualifies you at any speed. Attach a statement that you copied by ear, without aid (except typewriter or pencil which please mention). Mail your original copy, for best chance of qualifying. We want to give *every* U.S.A. licensee a certificate. Got yours? If not, there's no time to start like now.

**Habit in Operating.** Advancing our Code Proficiency from any present level to a higher speed is a matter of training of our responses. The ability to coördinate, the essential ability, depends on habit, which in turn is largely a matter of practice. The ability to cultivate good operating habits determines the speed with which we can improve our sending or receiving ability.

Every amateur should make a habit of taking a little time out each day to examine his operating. We must rationally direct our conscious impulses so they all aid the formation of *good* operating habits and so they handicap and slow down the development of *bad* operating habits. Skill and efficiency in code knowledge are the constant goals of the real amateur. Habit is a good slave but a bad master. We must not let improper mannerisms that we have to *unlearn* enter our operating!

The ability to handle procedure and message forms depends on first having a fine Code Proficiency, maintained and extended unconsciously through customary habitual practice. While the subconscious responses speed up from day to day, making us better amateurs, with increased Code Proficiency, our conscious mind should explore the field that is new to some of us, that of procedure as required for speed and accuracy in recorded work.

As soon as we can do 15 w.p.m., we can profitably look at our *procedure* introspectively, and start forming efficient procedure habits, which are essential to the *reliable* operator. Habit will also assist us here. Getting the right start means a great deal. The sloppy operator who cannot be depended on is often the fellow who never took the time to keep his log properly, to put the

TOR (time of receipt) and date on his message, with the call of the station sending the message and his initial or personal "sine." The careful operator is one who checks his word count on all traffic before receipting, and who takes pride in things like the ability to copy "ten to a line" and use the efficient form and procedure for any occasion.

**Copying behind.** Several inquiries have been received from amateurs who want to know the "secret of copying behind." There is no secret about this, no mystery at all. Regular practice has enabled you to speed up from the point where letters are recognized to the point where you can copy down entire word groups. It is a habit born of fear that one is going to miss something that makes one copy character by character as information comes in. We have seen operators who had the even worse habit of guessing ahead and copying ahead. A reasonable practice period every day or two, listening to good copy, sending to emulate the style about 30% of the practice time, but not practising to the point of extreme fatigue will enable you to gain speed, and simultaneously gain confidence, so that you can copy behind.

Copying behind requires nothing but practice to give you the extra confidence in your ability to make it possible for you to carry a few letters and words in your head before you put them down. Try copying behind, when your speed permits even consistent reception, free of nervousness. It will shortly come to you as a *good habit*; continue to cultivate this habit of copying behind to a reasonable degree. An unusual word, some figure groups, or an unexpected bit of interference may throw you off at first. But your inherent ability will rise to the top with practice. Your subconscious mind will retain the image impressed from your ears if you will stop worrying about the thought that you may not be able to do it. To practice copying behind force yourself to stay two or three words behind, in spite of your inclination to overtake the transmitting station operator. Make a full and complete copy. Have no compunctions about dropping a word or two if you fail to get them. Don't let such a break stop you. Keep going; keep a few words behind; there is no way to learn except by doing the thing. You will be surprised how soon you will have some ability at "copying behind."

Copy a little faster than you are capable of taking, for a short time each day. Send a little faster than you normally send comfortably for a little while each day — but with ability to listen to your sending and special attention to insure *perfection in spacing in characters and between words* — which is the secret of good sending. Make habit your slave. Make Code Proficiency Your Aim.

— F. E. H.

## ARTICLE CONTEST

The article by John T. Frye, W9EGV, wins the C.D. article contest prize this month. We invite entries for this monthly contest. Regarding subject matter, we suggest that you tell about what activity you find most interesting in amateur radio. Here you will find an almost limitless variety of subjects. Perhaps you would like to write on working for code proficiency, Emergency Corps planning, traffic work, working in Section Nets, Phone and Telegraph operating procedures, holding a League appointment, working on radio club committees, organizing or running a radio club, the most interesting band or type of ham activity, or some other subject near to your heart.

Each month we will print the most interesting and valuable article received. Please mark your contribution "for the C.D. contest." Prize winners may select a bound *Handbook*, *QST* Binder and League Emblem, six logs, eight pads radiogram blanks, DX Map and three pads, or any other combination of A.R.R.L. supplies of equivalent value. Try your luck!

## The Most Interesting Band

BY JOHN T. FRYE, W9EGV \*

**T**EN years ago I put out my first feeble chirp from a single '12A on the eighty-meter band. Since that time I have operated on every band to and including the five-meters, but my first love is still the best. Eighty meters is the "home" to which I always return after a foray into the other frequencies.

Dependability is one of the virtues of this band. I know that I can raise a station on this "old reliable" any hour out of the twenty-four. Having spent five years in the A.A.R.S., with nightly schedules six nights out of the week, nine months out of the year, I know whereof I speak when I say that for day-in and day-out consistency, eighty is without a peer.

Being one of the lean-purse hams, I am also charmed by the fact that a fellow does not have to have a kilowatt in order to make his voice heard on my favorite band. Right now I am running twenty watts into a single 807, but I work in the A.A.R.S. Net during a crowded traffic hour, experiencing little or no difficulty. Just the other evening I had a forty-five-minute chat with W3CXL, and he did not ask for a single repeat. Forty-six of the forty-eight states have been worked with the twenty watts without any special effort being made to do so.

Still another feature is that eighty combines the local rag-chew possibilities of one-sixty with the DX potentialities of the higher frequencies. I have often had schedules with a neighboring town and with a station a thousand miles away on the same night.

In short, I like eighty meters because it is dependable; it enables the low-powered station to work out; it permits both local and DX contacts; it is occupied by the best operators in our ranks, the traffic men; it is far enough away from the broadcast band to minimize BCL trouble; and it is one of the most economical bands in terms of equipment needed to place a transmitter in operation.

## BRIEFS

W3BWT recently came across his first Official Relay Station Certificate issued in March, 1923. He has been an active O.R.S. continuously since — a record of which anyone might well be proud!

— \* \* \* —

Flo K. Hart, W9CHB lives on *Woman Lake Road* in Pine River, Minn.

\* 1810 Spear Street, Logansport, Ind.



Ensign E. L. Battey, U.S.N.R.

The call of National Defense was quickly answered by Assistant Communications Manager Battey of A.R.R.L. Headquarters. "Ev" immediately volunteered his services for a tour of active duty when he learned that N.C.R. officers were needed to conduct the Naval Reserve Radio School at Noroton, Conn. He is presently hard at work helping to turn out a goodly share of the many radio operators that will need to be created under the nation's expanded naval program. We're proud to say that from among us the country has obtained as capable and experienced a man as Ev Battey. We salute you, Ensign!

Although we're not doing much flag waving, we do have at A.R.R.L. Headquarters a commissioned officer in the Signal Corps, four A.A.R.S. members, and two commissioned officers in the N.C.R. Ensign E. L. Battey is on active duty, on a one-year leave of absence from the American Radio Relay League . . . doing things right out in the front ranks dedicated to preparedness and national defense!

## Radio Amateurs Help in Gale

**O**N NOVEMBER 11TH a terrific gale swept over the country, hitting Michigan in general, doing the most damage in the northern part of the state. Western Union facilities were crippled north of Bay City.

At 10:00 A.M. on November 12th, W8DPE established contact with W8LA of Frankfort, Mich., who reported all lines down. W8DPE immediately took messages from W8LA to be transferred to the Western Union here.

At approximately 10:30 A.M., W8NQUI of Grand Rapids, Mich., came on the air. He was asked to contact the local Western Union Office and to arrange to handle Frankfort traffic through W8LA. This setup was established immediately, and W8NQUI stayed on the air until 11:15 A.M. of November 13th, with the exception of a few hours' sleep during the time when no traffic was available. W8LA commends Mr. Edwards, W8NQUI, very highly for his very efficient work and also his reliability. W8LA is operator for the Ann Arbor Railroad, both for the radio station and the railroad system. Other stations who should also be commended for their work and willingness to cooperate are W8SJQ of Traverse City, W8SSQ of Owosso, who handled two of the most important messages, and W8SAY of Muskegon, who aided very materially in establishing emergency setups for "standbys." Others were W8NVR and W9UCD, and later, members of the QMN Net who reported in as soon as they returned home from their work.

A very important lesson was learned during the time when the only communication was radio. Each station should have an alternate, so when he is away to work his alternate would be available in the day time if possible.

— Harold C. Bird, S.C.M., Mich.

## Meet the S.C.M.'s



W2AZV

Edward Baunach, S.C.M., N.Y.C.-L.I., received his present call in 1920, and has managed to keep some sort of transmitter on the air ever since. He has been O.R.S. continuously since 1928 and is also O.O., O.B.S., and R.M. Active in the N.C.R., he hasn't missed a drill schedule in six years. A 6L6 e.c.o.-6L6 amp. with battery and genemotor supply is the emergency transmitter. Regular transmitting equipment consists of a Collins 45A and an e.c.o. rig ending up in PP-810's. The receiver is an HRO. W2AZV operates on 7 Mc., and with both 'phone and c.w. on the 1.75 and 3.5 bands. The most used frequency is 3710 kc. S.C.M. Baunach received a Public Service Certificate for his work in the 1938 Long Island hurricane. He's a member of the Radio Club of America and the I.R.E. His other hobby is amateur photography and, to keep in trim, he turns to swimming and handball. He's employed by the News Syndicate Co. as a photographer.



W7GNJ

Carl Austin of the Oregon Section is another S.C.M. whose experience in amateur radio dates back a good many years. He received his first ticket in 1922 and was active with the call 7ADD. 1.75- and 3.9-Mc. 'phone are the bands on which he spends most of his time these days. The rigs in use are a 1.75- to 28-Mc. bandswitching affair with PP-T55's final and a job with 204A's that works down to 14 Mc. A 12-watt self-powered 'phone-c.w. transmitter is on hand for emergency use. Receivers are an HQ120 and a Super Sky Buddy. W7GNJ is O.P.S., O.B.S., O.O., participates in many contests, and was the winner for Oregon in the 'phone section of the 1938 Sweepstakes. S.C.M. Austin is active in the Oregon Amateur Radio Association as one of its Directors at large.

## Brass Pounders' League

(October 16th-November 15th)

Call	Orig.	Del.	Rel.	Extra Del. Credit	Total
W6ROZ	26	33	1040	25	1124
W3GKO	25	24	1050	12	1111
W3BWT	61	80	864	72	1077
W4AXP	16	13	952	13	994
W9EBQ	0	0	991	0	991
W5MN	26	96	754	83	959
W9ILH	6	103	760	75	944
W3AOC	50	42	824	20	936
W9QIL	66	131	545	106	848
W2HXI	27	46	702	24	799
W1KKS	75	38	544	12	669
W8SJF	10	14	624	8	656
W6PGB	39	80	415	66	600
W3QP	156	218	10	213	597
W4FDT	27	49	456	49	581
W2MIY	53	54	421	26	554
W5CEZ	15	109	402	22	548
W3EEW	80	70	362	35	547
W6DH	41	32	446	14	533
W8NCJ <sup>2</sup>	47	66	355	60	528
W2SC	22	85	365	53	525
W4FRU	15	7	496	7	525
W9GFF	8	25	471	21	525
W1JSM	52	35	402	19	508
K1IHR	676	663	54	629	2022
K1IHR <sup>1</sup>	616	603	14	589	1822
W5OW	146	118	1004	68	1336
W4HQ	980	0	0	0	980
K1IHQ	236	191	230	90	747
W1AW	55	152	379	147	733
W9BNT	18	135	439	12	604
K1IHQ <sup>1</sup>	200	60	194	55	509

These stations "make" the B.P.L. with total of 500 or over. One hundred deliveries + Ex. Del. Credits also rate B.P.L. standing. The following one-operator stations make the B.P.L. on deliveries. Deliveries count.

W2AV, 284	W5GFT, 190	W3DRD, 129
W6LUJ, 251	W9YTV, 186	W9KBL, 128
W9CRK, 238	W2KL, 179	W9QG, 127
W1MEC, 223	W5CEB/5, 160	W5FDR, 122
W3HRS, 220	W7APS, 157 <sup>3</sup>	W8FCG, 122
W7GVH, 211 <sup>3</sup>	W2LZR, 154	W7APS, 120
W6RBO, 204	W8JW, 152	W3BXE, 118
W8KWA, 198	W2CGG, 136	W9TGK, 114

A.A.R.S.

### MORE-THAN-ONE-OPERATOR STATIONS

Call	Orig.	Del.	Rel.	Extra Del. Credit	Total
WLM (W3CXL)	225	170	2941	73	3409

A total of 500 or more or 100 deliveries + Ex. D. Cr. will put you in line for a place in the B.P.L.

<sup>1</sup> September-October.

<sup>2</sup> August-September.

<sup>3</sup> July-August.

### BRIEFS

**Correction:** In December *QST* the call of Colorado S.C.M. Drummeller was in error given as W9EFC. Our mistake. It should have read W9EHC.

Back in the spark days one of the stations that made a lot of racket up and down the Pacific Coast on 200 and 375 meters was 7ZJ, which was operated by three brothers — Royal, Harold, and Bill Mumford. About the time c.w. came into general use the station was dismantled as each went to college, married, etc. At the present time the Mumford brothers are scattered around the country. They are on the air again using 7044 and 7046 kc. and have been holding successful schedules nearly every week-end, so if you hear W7AXZ, W2DIH and W6FAR rag-chewing far into the night, it is just a three-way family reunion going on.



**WHICH:**

It would take a guy more skilled in legerdemain than we are to pull any plums out of the hat this month, but that isn't going to prevent our telling all we know. Cheer up—it won't take long . . . . W6PMB, working **KF6JEG/KG6** (28,750 'phone), learned that **K6SBM** is on Jarvis now, using 7025 and 7175. JEG is on Sundays and sometimes Saturdays at 4 p.m. PST . . . . You've been told before, but W8TOB reminds us that **KF6SJJ** (14,350) should be QSL'd via his old QTH, W1K1FV . . . . K5AP, ex-W4FBD, writes to say that K5BR, many of whose cards came to K5AP, was never located down there as far as he knows. Dave has been off a few months, but hopes to get back on in the near future . . . . W2GT sent us G2ZQ's list of confirmations so, to keep the records straight on which countries John has that neither W6GRL or W2GT has, here they are: ZD8A, EA959 (EA6), SV6SP (Crete), FQ8AB, EA9AI, and ZC1S. With the 164 Doc and Ed have between them, this makes a possible 170 countries.

**WHEN:**

**KD4GYM** is still active on 14,240 'phone and 14,280 c.w., and will be down there until the latter part of February . . . . W6PMA reports the KA stations mostly off 7 Mc., but **K6HOT** (7030), **K6PIT** (7010), **K6LKN** (7080), **K6PHD** (7200), **K6PAH** (7105), **KC4USB** (7045), **W7FBN/K7** (7030), **K7HBJ** (7020, 7100), **K5AX** (7015) and **K4FCV** (7015) are all active. **K5AX** is a new one at Riohatoin . . . . More K6's, reported by W6QKB, include **K6FAZ** (7170), **K6QUJ** (7215), **K6SAJ** (7135), **K6RGZ** (7120), **K6AYD** (7130). **K7GOM** is on 14,355 . . . . Speaking of 7 Mc., it was pretty good around the middle of November—we heard a couple of W6's at 6 p.m. EST and got all hepped up about the possibility of working 7 Mc. cross continent, with daylight all the way. Dunno if it has ever been done, but it is certainly possible. Years ago, on the west coast, we heard a couple of W4's at noon on 7 Mc. and almost burned up the pet 210 trying to raise them. It's no fun, though, because the boys at the club sure gave us funny looks for a couple of weeks afterwards . . . . W6BAM was telling us during the

DXCC Round Up that he had worked **K6NZC** on 28,100 c.w., and several other fellows have mentioned that the 10-meter c.w. activity is picking up. Weekends are the best times to go scouting, and you'd better get in your time this year because it is probably the last good season for some time.

**HOW:**

The notice last month that the DXCC listing is to be discontinued "for the duration" brought forth a few cries of anguish and despair from the poker men who play 'em close, on the basis that they'd been holding out until they got one hundred, and now the door is closed. To take care of these fellows, cards will still be checked and certificates awarded to those who can hit one hundred or more with cards and other confirmations, sent in all at one time. Thus there is still plenty of incentive to scare up as many of the possible countries as possible, to get the award for the shack wall, but the burden of cards straggling in a few at a time will have been removed from the card-checking department. But we hate to think of the deluge when the listing is re-opened, in the very near future, we hope!

As far as lists of contacts go, the only ones we have here at HQ, aside from the DX Contest logs (which you can check on by looking in the story on that particular contest), are ones from VU2FA, PZ1AB, HB1CE, LN1A, YT6MEN, FN1C, I7AA, YS2LR, YV2CU, PK6XX, YA5XX, VR6AY, OX2QY, K6NVJ (Jarvis), YU7TE, VP7NT, VU7BR, KC4USA, KC4USB, KC4USC, KE6SRA, KG6MV and KD4GYM.

Not all of these are complete, of course. Remember these are only used for checking fellows that can get into the 100 class if they are listed, so please don't ask us for a QSL from these stations. QSL's are still obtained by the usual methods: bribery, plaintive pleading, cajolery, fustian, or just downright luck. But please, Gretchen—no tricks!

The changes in the DXCC listing since last month are as follows:

W2GTZ . . . . .	149	W8DPS . . . . .	99
W2GW . . . . .	148	W9DIR . . . . .	90
W2BHW . . . . .	136	W6LDJ . . . . .	90
W5BB . . . . .	134	W8CED . . . . .	89
W4CYU . . . . .	122	W8GMH . . . . .	89
W1ADM . . . . .	122	W9MRW . . . . .	81
W1IAS . . . . .	120	K4KD . . . . .	79
W1HX . . . . .	119	W6SN . . . . .	77
W3FQP . . . . .	116		
W1BXC . . . . .	112	Radiotelephone	
W8LFE . . . . .	110	W2GW . . . . .	107
W8PQQ . . . . .	109	W4CYU . . . . .	100
W3KT . . . . .	106	W1ADM . . . . .	93
W4TZ . . . . .	102	W8LFE . . . . .	91

Since cards will now only be checked to bring applicants to a total of 100 or more, future listings here will show only those over 100. When the full listing is resumed the old procedure will be followed.

**DXCC ROUND UP:**

The Round Up, held over the last weekend in November, didn't bring out quite as many fellows this time as last, although those who were in it seemed to be having a good time. It looks as though 14 Mc. folding up early had something to do with it, plus the fact that, while everyone seems to have listened on 40, very few put their transmitters up there. A rough check shows that about 35 of the gang were on during the weekend. That's hardly enough to make the thing pay and, unless a lot of fellows request otherwise, we will have to let the Round Ups go by the bored.

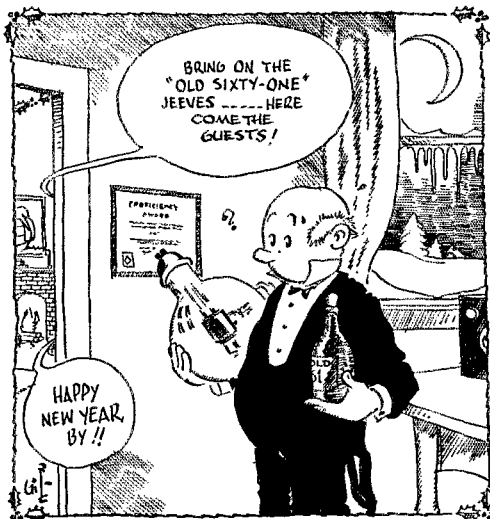



(Number eighty-three of a series)

Merry Christmas  
and  
Happy New Year  
from  
National's Company

*which includes*

Samuel Samour . . . . .	W1AMB	Jack Ivers . . . . .	W1HSV
Lester Harris . . . . .	W1AOP	Earle D. Benson . . . . .	W1HXF
Thomas P. Leonard . . . . .	W1AUJ	Matthew Sokolowski . . . . .	W1ISR
Rufus Turner . . . . .	W1AY	Joseph Homan . . . . .	W1IYA
Herman S. Bradley . . . . .	W1BAQ	Sumner Herrick . . . . .	W1JDF
James A. Ciarlone . . . . .	W1BHW	Edmund Harrington . . . . .	W1JEL
Dana Bacon . . . . .	W1BZR	Kenneth Nagle . . . . .	W1JGD
Calvin F. Hadlock . . . . .	W1CTW	Delbert Hood . . . . .	W1LD
Seth Card . . . . .	W1DRO	Richard Ireland . . . . .	W1LDT
Gene Simms . . . . .	W1DXD	Richard Gentry . . . . .	W1LEN
John F. Bartlett . . . . .	W1EU	Walter McMillen . . . . .	W1LIS
Donald E. Hinds . . . . .	W1FRZ	T. M. Ferrill, Jr. . . . .	W1LJI
Robert Murray . . . . .	W1FSN	F. A. Waden, Jr. . . . .	W1LNV
Claude W. Darling, Jr. . . . .	W1GDI	Edward Mallumian . . . . .	W1LOE
Richard Minichiello . . . . .	W1HBR	Walter Lannan . . . . .	W1LOQ
Wallace Battison . . . . .	W1HE	R. Johnson . . . . .	W1LZG
Richard Chaloff . . . . .	W1HME	Richard Heileman . . . . .	W1MWT
Robert Moses . . . . .	W1HMH	William S. Doyle . . . . .	W1TV
David Smith . . . . .	W1HOH	Arthur H. Lynch . . . . .	W2DKJ
Vicent Messina . . . . .	W1HRW	Myrl B. Patterson . . . . .	W5CI
Herbert Becker . . . . .	W6QD		



**ONLY** **P.R. MALLORY & CO. Inc.** **MALLORY**  
**TRANSMITTING CAPACITORS**  
**ARE BUILT WITH X-64**  
**IMPREGNANT**

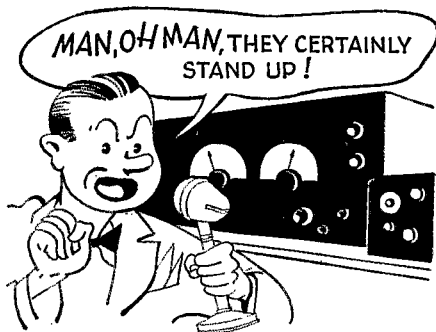
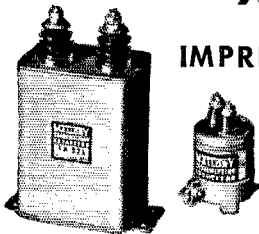

Mallory X-64 is the symbol that designates the exclusively developed synthesized plastic dielectric which contributes so much to the amazing performance records established by Mallory Transmitting Capacitors. X-64 is a non-oxidizing, non-polar translucent resin of exceptional stability. Among its many special advantages are:

Excellent for high temperature operation up to 200°F. (93°C). Power factor decreases with increasing temperature throughout normal operating temperature range. At high temperatures the power factor is below that of other types of dielectrics at normal temperatures. Capacitor may be mounted in any position without danger of leakage.

Semi-solid impregnant provides anchorage for capacitor components and helps resist effects of extreme vibration and physical shock.

Average breakdown higher than usual for oils or wax. Capacity change with temperature less than 12% from -80°F. to +200°F.

Extremely high insulation resistance—long life—low leakage.

High dielectric constant (K). Smaller size with maintained quality.

Non-inflammable.

Moisture-repellent.

Low vapor pressure.

Types available for all standard applications. See your Mallory distributor.

**P. R. MALLORY & CO., Inc.**  
**INDIANAPOLIS INDIANA**  
 Cable Address—Pelmallo

Use **P.R. MALLORY & CO. Inc.** **MALLORY**  
**APPROVED**  
**PRECISION PRODUCTS**

**WHO:**

The top and bottom men of the DXCC listing last month, W2GT and W2WC, both work at WEN . . . . . W9HLF sent an e.c.o. to AC4YN, so Fox will now be able to jump around when we get a chance to work him again. As if he weren't elusive enough already! . . . . . G16TK sends his best to the gang, and mentioned that anyone who hasn't received his card can get it by dropping a line to Frank A. Robb, 60 Victoria Ave., Sydenham, Belfast, North Ireland . . . . . W5IOA and his roaring 8 watts grabbed off KF6SJJ for another one . . . . . W4ZZ hopes to take another trip to the West Indies and Central America, this summer, if (1) the draft board will let him go and (2) he can get a couple of weeks' vacation. Herrick took a lot of pictures down there last year — *Life* magazine used one of them in a recent issue, a shot of Antigua harbor . . . . . W3ASW makes no claims to being a DX man or even an outstanding amateur, a modesty that is quite becoming, since he was the first W3 to work KH6SHS and the last station to take traffic from W2USA. An all-around amateur, DX and traffic man, we would say . . . . . A note from ex-G4FH says conditions (for radio receiving) are good over there — all districts but W6 and W7 coming through on 28 Mc., and W1AW's code practice is QRK5 on 80 . . . . . W2BHW has been QRL work and hasn't had much time to clean up the rig, with the result that it looks like, as he so aptly puts it, a "wire-mess room." Lindy adds that Dave Liang, XU9MK, XU6D, XU5MK, is at the University of Michigan taking grad work . . . . . Unless you guys send in more dirt about the DX gang and what their latest indiscretions are, we'll have to turn this pillar into either a cooking column or one of those advice-to-the-lovelorn jobs. Of course you'd want to know about our qualifications. With all modesty, we take full credit for a very succulent dish called "Loon à la PK 4." For those of you who enjoy exotic dishes, this is a Dugan. Clean the loon after it has been hung for several weeks (unless you like it gamey) and place it gently in a pot of boiling water. After an hour of cooking, place a large stone in the pot with the loon and continue cooking at a slow boil. When you can stick a fork in the rook, the loon is tender. Next month: "Cooked goose à la DXCC," or "I thought I could get away with it."

— . . . —

— W1JPE

The P.R.A.R.C. reports that another W.P.R. Certificate has been issued to an amateur outside Puerto Rico. The winner this time is W3EDP. K4FOW also received one of the awards recently. For details on W.P.R., refer to page 68 of May, 1940, *QST*.

— . . . —

Add W.A.S.: W3AGV sent us cards to prove that he had worked all states on each of three bands — 3.5, 7, and 14 Mc. They were all okay and he has been issued a certificate endorsed for three bands.

**October '40 O.R.S.-O.P.S. Parties**

The quarterly get-togethers in October were highlighted by numerous fine performances on the part of both the 'phone and c.w. gangs. W3DGM was the hit of the O.R.S. show with a score second only to the record made by W3BES in the January 1940 party. Jerry took second honors with a total only slightly less than DGM's. Those lads in the Eastern Pa. Section really have what it takes! Our "sleepless wonder," W1TS, was healthy third with quite a husky score, too. Competition in these parties is rapidly becoming stiff. Look at those figures! In the "big ten" there are seven scores over twenty million, and fifty-three O.R.S. made over five million points. W4DCQ, who manages to stay up near the top in the O.P.S. Parties, was top man for the second consecutive time in the 'phone doings with a showing that turned out to be a new high under the present scoring system. W9WMI, who might be placed in the "dark horse" category, "placed" with a handsome score. W2LXI, who is fast becoming a threat to the old-timers, ran a very fine third.

January O.R.S. and O.P.S. quarterly activities are usually scheduled for the last week-end in January. The January bulletin will bring full details of a change in the plans that should make more QSO's than ever possible on January 18th and 19th. All League members who are interested in becoming top-notch operators and have a



*Proved*

# DOLLAR VALUE!

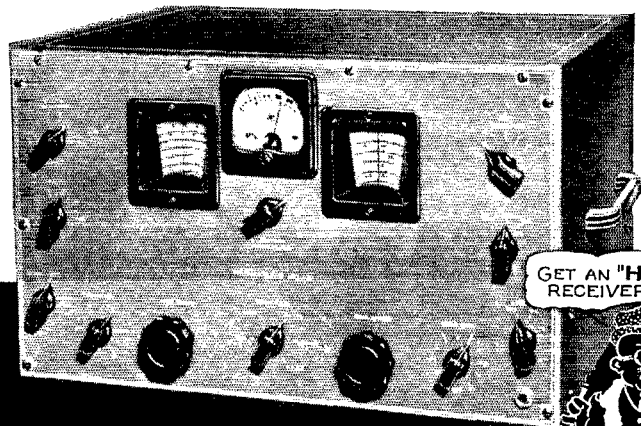

GET AN "HQ" NOW AND YOUR RECEIVER WORRIES WILL BE OVER!



## "HQ-120-X"

HOW does it perform? How will it stand up? And, how soon will it be obsolete? These are all important questions in determining the actual value of any product. The "HQ-120-X" has established a record which answers all of these questions and assures the amateur of the finest dollar for dollar value. Many owners write that the "HQ" outperforms anything they have ever owned. Its ability to "stand up" is proved by the exceptionally few used "HQ" receivers on the market, despite the thousands which have been sold since the "HQ-120-X" was first introduced. As a matter of fact, we know of hams who bought other

makes last year in preference to the "HQ" but who, this year, traded them in on the "HQ-120-X" — no obsolescence in that!

So, if you intend buying a new receiver, by all means see and hear the "HQ-120-X." Its up to the minute performance and sound dollar value have been proved by thousands of users.

### MAIL COUPON TODAY!

-----  
 HAMMARLUND MFG. CO., INC. Q-1  
 424 W. 33 Street, New York City  
 Please send "HQ-120-X" booklet  
 Name .....  
 Address .....  
 City..... State.....



Canadian Office:  
 41 West Ave. No., Hamilton

# HAMMARLUND

EXPORT DEPARTMENT: 100 VARICK ST., NEW YORK CITY

# BETTER CONTROL

*with the*

# BLILEY B-5

## 40-METER CRYSTAL UNIT

**HIGHLY ACTIVE:** Instantly snaps into oscillation. Accurately follows keying.

**POWERFUL:** Uniformly high power standardized in a loaded oscillator with measured output.

**ACCURATE AND STABLE:** Frequency guaranteed .03% accurate. Drift less than 4 cycles/mc./°C.

**DEPENDABLE:** Thirty-one checks and inspections, including a final overload test, assure reliable operating characteristics.

*Ask your distributor for Circular A-7*

legitimate traffic interest (which is the enjoyable fast way to become "tops") should report monthly traffic to S.C.M.'s and ask to be appointed O.R.S. Those with first class voice stations and operating methods are invited to be O.P.S. similarly.

### OFFICIAL 'PHONE STATION SCORES (OCTOBER)

Station	Score	QSO's	Sets.	Heard	Power (Watts Input)	Operating Time
W4DCQ	13,838	77	34	22	900	7 h., 39 m.
W9WMI	10,520	72	32	—	500	9 h., 45 m.
W2LXI	10,100	65	25	24	300	6 h., 20 m.
W4FLS	9,639	64	27	12	800	8 h.
W3CWG	9,100	57	25	27	275	8 h., 55 m.
W3FJU	9,075	58	25	24	1000	4 h., 47 m.
W9WXL	7,982	55	26	16	250	8 h., 25 m.
W8KNF	7,953	54	23	7	400	7 h.
W2LV	7,900	58	25	13	600	7 a., 20 m.
W1IXL	7,337	61	23	7	1000	8 h., 35 m.

Station	Score	QSO's	Sets.	Station	Score	QSO's	Sets.
W6AM	7,035	48	21	W9MWR	5,676	48	23
W8NDN	6,994	49	26	W2DRY	5,120	46	20
W3HDJ	6,975	53	25	W1BNO	5,022	48	19
W3EQK	6,888	58	21	W2CET	4,826	48	18
W8BFB	6,463	44	23	W8FSK	4,780	41	20
W1GZL	6,420	51	20	W6CHV	4,662	27	21
W3DRQ	5,775	44	21	W8BOZ	4,536	42	21
W1EAO	5,760	45	20	W8AVH	4,374	32	18
W4QI	5,760	50	20	W8TNC	4,300	51	20
W8VZ	5,754	50	21	W8RBI	4,237	37	19
				W8QJJ	4,009	31	19

### OFFICIAL RELAY STATION SCORES (OCTOBER)

Station	Score	Diff. Sns.	Diff. Sets.	Heard	Power (Watts Input)	Operating Time
W8DGM	28,245,028	263	53	18	300	20 h.
W8BES	28,115,729	257	56	8	100/450	20 h.
W1TS	26,262,560	250	54	—	350	1 Ch.
W9CRK	23,554,472	239	53	6	90/150	18 h., 49 m.
W9BRD	23,110,650	230	55	—	95	18 h., 20 m.
W4DWB	23,098,470	244	51	46	100/200	19 h., 40 m.
W8RBQ	21,364,236	184	49	—	900	17 h., 37 m.
W9IU	17,728,100	216	52	—	—	—
W3GKO	16,547,960	211	49	6	200	18 h., 39 m.
W2HXI	15,968,040	214	50	5	400	19 h., 10 m.

Station	Score	Sns.	Sets.	Station	Score	Sns.	Sets.
W6CIS	15,284,295	149	46	W2LPJ	8,894,672	163	49
W6PCE	14,921,765	148	49	W9YTV	8,504,568	168	48
W3HXA	14,660,248	198	48	W8RFP	8,372,885	166	49
W3NF	14,275,015	203	46	W9ZRP	8,328,025	148	49
W8GBF	14,026,320	190	52	W1FMV	7,831,650	176	42
W8KUN	13,812,736	205	51	W4GNQ	7,789,120	153	49
W3HUM	13,135,250	203	47	W2IYQ	7,786,368	170	46
W9VDY	12,943,269	193	51	W6BAM	7,564,440	115	41
W2LZR	12,576,200	212	48	W3DRD	6,817,230	161	49
W9YCR	12,538,400	174	50	W3EJE	6,758,535	148	43
W5KC	12,371,120	185	51	W9CVH	6,530,088	157	44
W3EML	12,019,020	201	46	W1KQY	6,241,900	140	45
W9AEJ	11,129,171	184	45	W9KBL	6,065,928	—	—
W3BXE	11,102,688	184	44	W9VOQ	6,055,780	157	40
W3BZE	10,454,445	186	49	W9VBQ	6,021,924	138	44
W9YZN	10,431,030	179	47	W9WFS	5,857,510	150	40
W9GJB	9,283,780	164	45	W2AYJ	5,846,568	141	41
W3FIO	9,255,500	—	—	W8FFK	5,751,725	144	41
W9NCS	9,162,400	163	45	W3HRD	5,445,385	128	43
W3EEW	9,103,150	172	45	W8DAB	5,353,810	127	43
W8ROX	9,009,488	189	43	W3GDI	5,163,840	146	36
				W3IAY	5,045,450	141	37

**BUILT TO SERVE BETTER**

**AND**

**LONGER**

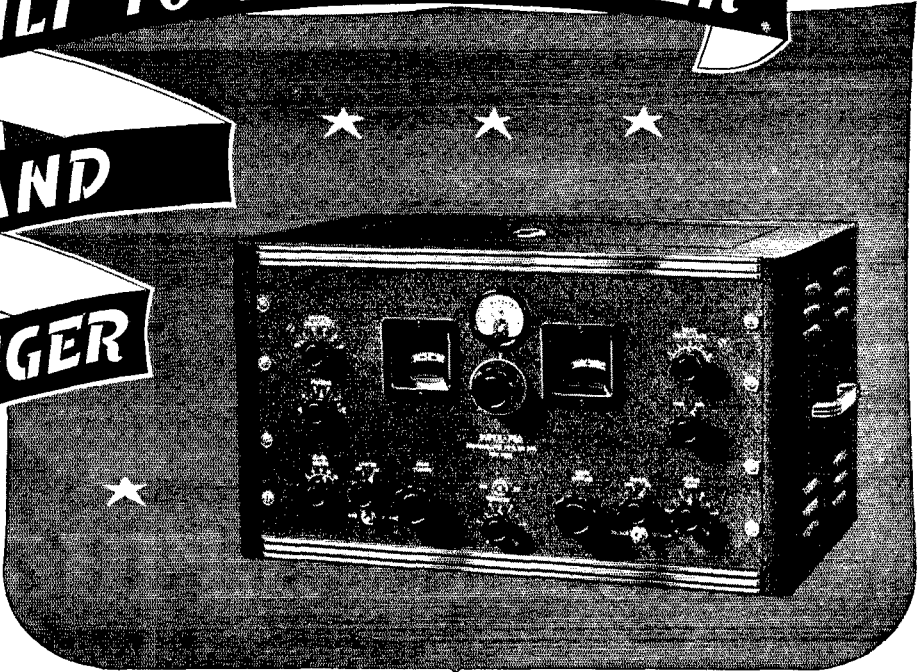

*The*

# SUPER PRO *Series 200*

THE high standards to which the "Super-Pro" is manufactured, assures the user of the best possible service over a long period of time. That is why "Super-Pro" receivers are used in practically every department of our national government; by a host of foreign governments, and by many important commercials and expeditions.

Early models of the "Super-Pro" have been in continuous service for nearly five years with remarkable satisfaction. As an example of its sound engineering, we find not a single record of band switch failure and that is an extremely important and much used part of any receiver. Slight changes and refinements have been

made from time to time with a result that the "Super-Pro" is, and always has been, one of the finest pieces of communications equipment available. The many hours given to the inspection, testing, and adjustment of each "Super-Pro" by skilled craftsmen are not without results — the record speaks for itself.

**SEND FOR BOOKLET!**

HAMMARLUND MFG. CO., INC. Q-1  
424 W. 33 Street, New York City

Please send "Super-Pro" booklet

Name .....

Address .....

City.....State.....

Canadian Office:  
41 West Ave. No., Hamilton



# HAMMARLUND

Export Address: 100 Varick Street, New York City • Cable ARLAB

# HIDDEN EXTRAS

*at no extra cost*

THE BASIC REASON FOR  
CORNELL-DUBILIER LEADERSHIP

**E**XTERNALLY, the best and poorest capacitors may look alike. Internally, and in service rendered, they differ vastly. Cornell-Dubilier Dykanol Filter Capacitors are not merely well designed and constructed. They contain those valuable HIDDEN EXTRAS — Extra Stamina, Extra Dependability and Extra Long Life. That's the reason for their superior performance! That is why there are more C-D Capacitors in use today than any other make.

**EXTRA VALUE FEATURES  
YOU GET IN C-D  
FILTER CAPACITORS  
TYPE TQ**

- Vacuum impregnated—5000 megohms per mfd.
- Stand 10% continuous overload.
- Low power-factor.
- Hermetically sealed.
- Unaffected by temperatures up to 200° F.
- Impregnated and filled with non-inflammable Dykanol.

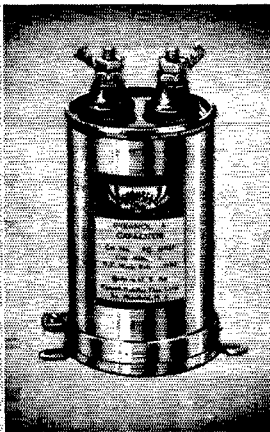

WHEN THE BEST IS A "MUST"  
**Specify C-D's CAPACITORS  
YOU CAN TRUST**  
Capacitor Specialists for 31 years.

**CORNELL-DUBILIER  
ELECTRIC CORPORATION**  
1013 HAMILTON BLVD. • SO. PLAINFIELD, N. J.

## High Sweepstakes Scores

Logs from operators who took part in the 11th A.R.R.L. Sweepstakes are still pouring in at Hq. as we go to press. It appears that this SS will be a record breaker for number of participants. Entries from some 900 amateurs have been received at this writing, and we are listing the high claimed scores submitted. Further checking is necessary before we can give you any official results. A full account of the affair is scheduled to appear in the April issue of QST. The highest score received is that from W2GSA, who worked 631 stations in 62 sections for 97,419 points. Although the info' has not been verified, we hear via the grapevine that the all-time high of 101,500 points set last year by W2IOP has been topped by a good margin. However, we'll know more about that when all the reports are received. Thus far there is no indication that anyone worked all sections. W6PCE and W6ITY each worked 63. Vermont being the one missed. W6ITH, who has led the 'phone gang in many previous Sweepstakes, also reports working 63 sections. He worked all states, which is no mean accomplishment! The missing section in his case was KA. The tabulation below shows score, stations worked and sections worked.

C.W.		WSROX	48600-365-54
W2GSA	97419-631-62	W1BFA	47809-321-61
W2JAE	89610-621-58	W6PMA	47733-313-61
W6QAP	88272-575-62	W9LDH	47495-322-59
W8OKC	87900-600-60	W9BZG	47436-402-59
W9BHD	87225-586-60	W3JAE	47435-332-57
W6PCE	85550-542-63	W2WC	47122-309-61
W9ZRP	85035-549-62	W1FMV	46971-355-52
W6ITY	84295-536-63	W6ITT	45600-380-60
W5KC	81762-538-45	W3HQU	45264-370-49
W9VKF/9	77035-497-62	W3PSS	42930-318-54
W8KUN	73316-515-57	W3ODJ	41006-298-53
W3TWM	73200-480-61	W3DRD	41550-277-60
W9YCR	70915-472-62		
W9MUX	70615-488-58	'Phone	
WITS	70184-566-62	W6ITH	52542-417-63
W9BQJ	69750-450-62	W9YQN	42539-361-59
W9MGN	65650-439-60	W6BD	40504-332-61
W2JRH	65070-482-64	W9NDA	37670-292-64
W9PKW	64742-447-58	W8IFT	36099-250-63
W9GKS	62400-521-60	W8DTE	31860-270-59
W9A0B	61802-423-59	W4PLS	33855-228-61
W9DUX	61040-545-56	W1HKK	31293-257-61
W9ZWR	59450-410-58	W7IBY	30745-280-55
W1EXU	59015-407-58	W9KXK	27043-190-58
W5CWV	58800-420-57	W9ZLK	23313-207-57
W2HXI	57285-335-56	W3PQP	23024-164-58
W6ONG	56378-372-61	W5IRO	22700-227-50
W2HUG	56473-390-58	W8JAH	20776-196-53
W9GBJ	56425-370-61	W5EHL	20295-185-55
W8OPF	55050-367-60	W9KMN	19387-141-55
W9YTV	54180-389-56	W9TJA	19372-145-54
W8SLH	53200-385-56	W6SPQ	19370-153-62
W5DBR	53100-356-59	W8CWY	18704-164-56
W8JVI	53066-404-53	W2TJQ	17950-181-50
W3HRW	53000-427-50	W1KGN	14804-150-49
W3Z50	52950-349-61	W6GVM	14400-144-50
W8NCS	51773-355-59	W8NKK	13536-144-47
W8SMC	51638-383-54	W2DVR	13413-132-51
W7RT	51545-342-61	W7GVX	12955-127-41
W9GDE	51300-365-57	W9ADJ	12876-131-48
W1FTU	50820-376-56	W7ZSR	12398-129-48
W9ZVN	50576-436-58	W6PQQ	12015-134-45
W9MGV	50209-426-59	W6MEP	11811-131-47
W9KBL	50018-351-57	W9VFW	10911-102-48
W9AEJ	49118-337-59	W5HOU	10656-111-43

### 112 Mc. Hpt in Boston

A general picture of 2 1/2-meter activity in the greater Boston area may be enlightening to the multitude of 2 1/2-meter experimenters elsewhere in the nation! These results are deductions from a 2 1/2-meter station survey conducted by WIPI in November 1940. Information concerning 84 stations was obtained showing:

- Lowest power, 1 watt, used by W1LID
- Highest power, 150 watts, used by W1JDF
- Average power used, 28.5 watts
- Elevations — Highest, W1LHV, 350 ft.
- Lowest, W1KIX, W1IYC, 20 ft.
- Average Elevation, 106.5 ft.

In all cases the stations reported their DX records in different directions from their location, exclusive of work portable and from hill tops. The best DX listed was a contact made by W1MON with W2LAU, Summit, N. J., a distance of approximately 200 miles.

Thirty-five per cent of the stations reporting had worked over 100 other 2 1/2-meter amateur stations. W1JQA of Randolph had worked most stations (385!) in some four

"I chose *Eimac 75T's*  
...and they have exceeded all my  
expectations" . . . says Ben C. Comfort

**W9GHW**  
Ben C. Comfort . . . at the mike



Ben says . . . "the performance of any transmitter is no better than the Class C amplifier . . . I was very careful in my choice of every unit that went into its construction . . . after considering them all, I chose Eimac 75T's and they have exceeded my expectations . . . I have loaded them from 150 watts to 1050 watts input and they have come through with flying colors."

At the present time Ben is running the pair of 75T's at 310 watts input. The results obtained with this class C amplifier speak well for the design and performance of the tubes. Right now Ben is converting other sections of his transmitter to Eimac Tubes. There's no stronger recommendation than that. A pair of 75T's going in as doublers.

**Eimac**  
**TUBES**

Eltel-McCullough, Inc. • San Bruno, California

#### EIMAC REPRESENTATIVES

California, Nevada

HERB BECKER, 1530 W. 104th St., Los Angeles, Cal.

Wash., Ore., Idaho, Mont.

GENERAL SALES CO., Verner O. Jensen, 2605-07 Second Ave., Seattle, Wash.

Colo., Wyo., New Mexico, Arizona, Utah

RICHARD A. HYDE, 4253 Quitman St., Denver, Colo.

Ohio, Mich., Ky., Ind., Minn., Mo., Kan., Neb., Iowa

PEEL SALES ENGINEERING CO., E. R. Peel, 154 E. Erie St., Chicago, Ill.

N. Y., N. J., Penn., Md., Del., Dist. of Col., Maine, N. H., R. I., Conn., Mass.

ADOLPH SCHWARTZ, 14726 Elm Ave., Flushing, New York.

N. Caro., S. Caro., Georgia, Tenn., Fla., Ala., Miss.

JAMES MILLAR, 316 Ninth St. N. E., Atlanta, Georgia

Texas, La., Okla., Ark.

J. EARL SMITH, 2821 Live Oak St., Dallas, Texas.

Chicago, Illinois, Wisconsin

G. G. RYAN, 549 W. Washington Blvd., Chicago, Ill.

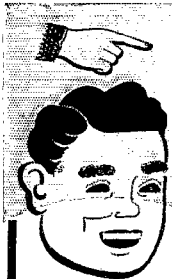

Take it from me  
OHMITE parts  
do a swell job!

—they put you on the air with plenty of pep and efficiency! They're time-proved in thousands of amateur and industrial applications all over the world. Ask your Jobber for Ohmite Parts — you'll insure peak performance for your rig!

**Dummy Antenna**  
Used in checking R.F. power, impedance match, line losses, etc.; helps you tune up to peak efficiency.

**Brown Devil**  
10 and 20 watt vitreous-enameled resistors for voltage dropping, bias units, bleeders, etc.

**Parasitic Suppressor**  
Small, compact resistor and choke, prevents u.h.f. parasitic oscillation.

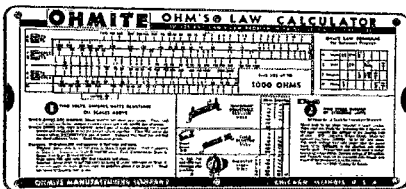
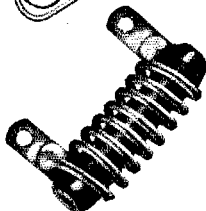
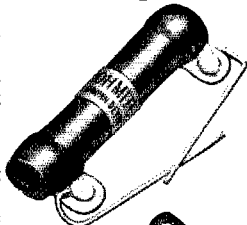
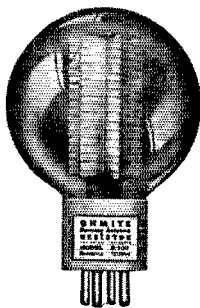

Get the New Ohm's Law Calculator—at Your Jobber

Solves any Ohm's Law problem with one setting of slide! Simple — handy, complete! Only 10¢ to cover handling cost. See your Jobber or send 10¢ in coin now.

**OHMITE MANUFACTURING CO.**  
4863 Flournoy Street Chicago, U. S. A.

**OHMITE**

RHEOSTATS RESISTORS TAP SWITCHES

years of activity. Twelve other amateurs had worked over 200! In order of most worked, these are: W1LDD, W1APH, W1JDF, W1PI, W1GEJ, WISS, W1EJU, W1EYR, W1KIX, W1KSA, W1LEM, and W1LKT.

The average number worked was 93 stations. The longest term of activity reported was that of 72 months (i.e. 6 yrs.), in the case of W1EYR. Several were newcomers to the band, with "1 day" the report in the case of W1FON and W1LID.

## Aid to Moving Traffic

### USE THE GENERAL TRAFFIC PERIOD

The daily period 6:30-8:00 P.M. (your local time) has been designated the "General Traffic Hour." All Official Relay Station appointees have been requested to keep this period, working general with all amateurs. Trunk Line Station appointees are likewise requested to work general during this period. In this manner operators who are unable to maintain regular schedules or whose operating time is limited may get on the air from 6:30-8:00 P.M. and clear their traffic through O.R.S. and T.L.S. who keep schedules on established traffic routes. Make use of this period so that delivery of traffic and dependability of service may be improved. Give your traffic to stations signing "ORS" or "TLS," "CQ TFC" is the general call for the "traffic hour." Directional CQs will also be found useful during this period.

For 7- and 3.5- and 1.8-Mc. band operators the local time designation 6:30-8:00 P.M. will enable traffic-training minded hams to swap messages over north-south strips of territory within their time zones and perhaps extending a zone each way.

14- and 28-Mc. band operations (and longer hops on 7 Mc.) can be taken care of by making a selective use of the designated period. That is, let us assume we are in San Francisco and have a message for New York. We know that 8:00 P.M. New York time is 5:00 P.M. locally, so we get on the air with our 14-Mc. transmitter and tune for New York stations, starting at 3:30 P.M. and continuing until 5:00 P.M. PST. When we identify a station logged in our call book as a New York fellow, we go after him. Try it! Everybody patronize the General Traffic Period. It will make for effective amateur results in the traffic line.

## EUGENE, ORE. VOCATIONAL SCHOOL

The Eugene Vocational School is offering training in several radio fields of interest to amateurs.

A course in radio operating designed to qualify trainees for the communication service of the Army and Navy is now in progress. Instruction is given in International Code, radio theory and in the servicing and maintenance of radio receivers and transmitters. Touch typing is given as a related subject.

Training will also include work in recording and in studio technique for those interested in those fields. Individuals may build radio equipment for their own use as a work project if they so desire.

Individuals holding amateur licenses may enter at any time; those with no radio experience may register only at certain specified times. Although no tuition is charged, there is a material fee of two dollars per month.

Roger Houghlum, W7FHB is senior instructor

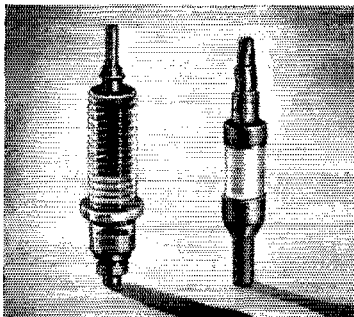

Dual alignment of r-f circuits provides greater approach to constant sensitivity, higher image rejection throughout each range. H-f end of each coil aligned with Air-Dielectric Trimmer. L-f end inductance tuned.

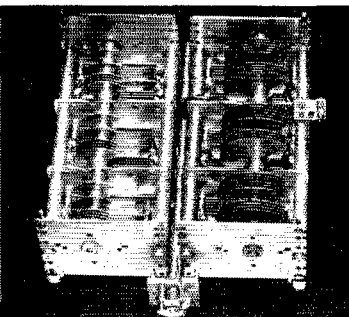

Electrical bandwidth at its best results from use of this special 3-gang, triple-section condenser connected in parallel with the 3-gang, double-section main-tuning condenser. Ceramic insulation used for dependability, strength.

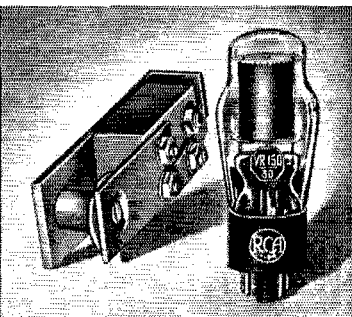

A temperature-compensated trimmer condenser in the h-f oscillator circuit stabilizes frequency from effects of temperature changes. A voltage-regulator tube guards against frequency shifts caused by line voltage variations.

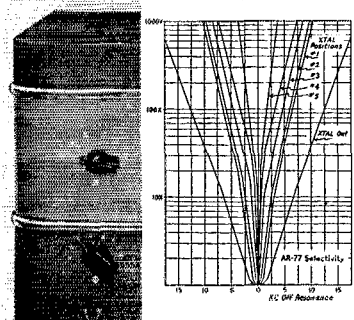

Selectivity is variable in six steps. Curves show degree of selectivity for each step. Note that step #6 has a bandwidth at "two times down" of less than 100 cycles!



## AN RCA ENGINEERING ACHIEVEMENT

The few features shown above will give you some idea as to why the AR-77 is one of the finest, most sensitive and most stable receivers on the market today. Space here does not permit the inclusion of other outstanding features ranging all the way from more effective use of insulation to the manually-adjusted Noise Limiter. That is why we suggest that,

before buying your new receiver, you see the AR-77, look it over from stem to stern and give its dials a whirl at your nearest RCA Amateur Equipment Distributor's store. You be the judge!

## AR-77 Communication RECEIVER

Stay-put tuning; break-in operation; highest signal-to-noise ratio; uniform sensitivity; bandwidth tuning for the amateur 10, 20, 40 and 80-meter bands; improved image rejection; negative feed back; antenna trimmer, etc.

Amateurs' Net Price, \$139.50  
MI-8303 Table Speaker in  
matched cabinet, \$8.00 extra  
F.O.B. Factory



*for Amateur Radio*

RCA MANUFACTURING COMPANY, INC., Amateur Division, CAMDEN, N.J. • A Service of the Radio Corporation of America

In Canada: RCA VICTOR COMPANY LIMITED, MONTREAL





QUALITY ABOVE ALL!

**SOLAR**

**CAPACITORS**

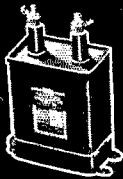

**XL  
TRANSOIL**  
For  
Permanent  
Filters

**XD, XC  
TRANSOIL**  
for Filters  
and Bypass

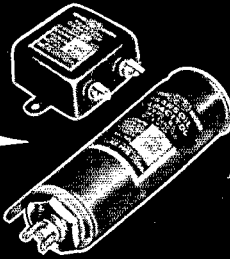

**XA, XH  
MICA**  
Oscillator  
Tank Circuits

**XR, XS  
MICA**  
Tank Circuits,  
R. F. Bypass

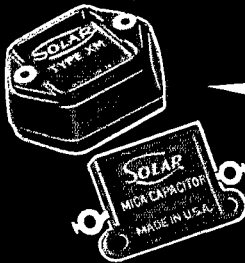
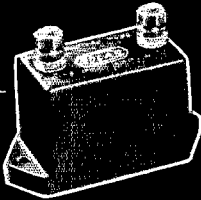

**XM, XQ  
MICA**  
Coupling, Blocking  
R. F. Bypass

**MH, MW  
MT, MO  
MICA**  
Low-voltage

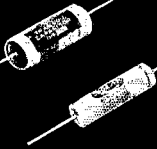
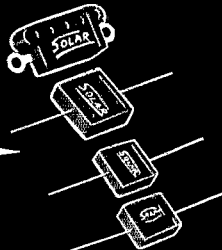

**XT  
OIL TUBULAR**  
S  
Wax-Molded  
Paper Tubular

Catalog Free Upon Request

**SOLAR MFG. CORP., Bayonne, N. J.**

and Fred Riebe, W7HPS assistant instructor. Inquiries should be addressed to the Eugene Vocational School, Fourth and Madison Streets, Eugene, Oregon.

## Thirty-Two Hams at N.C.R. School

### How to Apply

"EY" BATTEY, A.C.M., A.R.R.L., who is on active duty with the U.S.N.R. at the Naval Reserve Radio School at Noroton, Conn., sends us the following: The training schedule at the school is well under way. There are thirty-three amateurs among the officers and enlisted men. Lt. Comdr. H. F. Breckel, C-V(S), U.S.N.R., is the Communication Officer and is in charge of instruction. Lt. F. R. Tuthill, Lt. William F. Grogan (ex-W4QY and former Fla. S.C.M.), Lt. Perce B. Collison (W2IXE), Ensign D. C. S. Comstock (W1MY), Ensign Robert W. Percy (W8DZU) and Ensign E. L. Battey (W1UE) are instructors. C. E. Johnson, CRM, U.S.N., L. F. St. Amand, CRM, U.S.N.R., and F. B. Fucile (W8FZS), CRM, U.S.N.R., serve as assistant instructors. Among the students are the following amateurs: W1IOT, LBW, LDV, LJE, LQB, LRW, LZS, MQL, MTM; W2FQW, HYN, IMW, HPS, GYQ, KWO; LAW, MBB, MIF, MHB, IVP, KXX, NAL, IWM; W3EHX, HSZ, ISO, GTB; W5HNY. New classes are scheduled to begin March 1st. Anyone interested in signing up for the school should contact his local N.C.R. headquarters well in advance of this date, to insure that all the necessary arrangements are made in time. For a list of Commandants from whom applications may be obtained, see page 39 in August 1940 *QST*. The Noroton School is the largest of its kind in the country. There are several others, and those signing up will undoubtedly be sent to the one nearest them.

### CODE PRACTICE QRM

Collierville, Tenn.

Editor, *QST*:

Although I am not a licensed amateur, I expect to try for my ticket shortly. Your practice transmissions from W1AW sure have helped me to speed up my code. I listen to every one. At present I can copy 20 w.p.m., or a little better. The only complaint I have to make is that the transmissions don't come often enough.

Also I hope you will make a plea in *QST* for other hams to avoid using the same frequency as W1AW during the practice transmissions. Sometimes it is barely possible to copy through the terrific QRM.

— Madison Wilson

### SWEEPSTAKES

43 Butler St., Mt. Clemens, Mich.

Editor, *QST*:

Again I come to you with a topic that is a sore spot in amateur communications. . . . I refer to O.P.S. and S.S. parties and their objectionable interference with messages and communication.

It always has been my understanding that the League was formed for development of orderly traffic-handling and communications. This useless QRM defeats our very purpose, and the justification of the bands we occupy. You in your official capacity are entrusted in promoting these qualities; then why do you instigate these O.P.S. and S.S.



# 6

## OUTSTANDING REASONS WHY *Taylor T-40 and TZ-40*

### Lead In Sales-Performance-Value

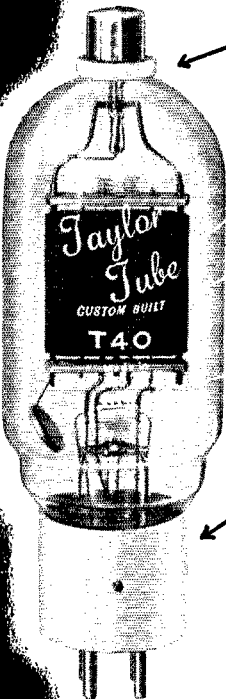

Safety Insulator protects against glass failure.

Safety Factor affords real protection against failure due to temporary overloads. T-40 and TZ-40 Safety Factor is 260 watts.

Processed Carbon Anode dissipates heat better and makes possible the high Safety Factor.

Complete Molybdenum Grid can stand heavy overloads—a costlier material but important to you in every day use.

Alsimag Base—one of the best insulating materials available.

Taylor T-40's and TZ-40's cost more to produce because better materials are used throughout. As a result, better performance, greater safety and longer life will be secured.

**SOLD OVER 30,000**

**TAYLOR WONDER TUBES**

**ONLY  
\$3<sup>50</sup>**

### T-40 and TZ-40 Characteristics

Filament Volts .....	7.5
Filament Current, Amps. ....	2.5
D.C. Plate Volts .....	1500
D.C. Plate Current, MA. ....	150
Plate Dissipation, Watts .....	40
Safety Factor, Watts .....	260

**"More Watts Per Dollar"**

*Merry Christmas  
and a  
Happy New Year*

FRANK HAJEK W9ECA  
WARREN TAYLOR  
JOSEPH HAJEK  
REX L. MUNGER W9LIP  
BILL BISHOP W9UI  
CHARLES KIDNER

*Taylor* HEAVY **CUSTOM BUILT** DUTY *Tubes*

TAYLOR TUBES, INC., 2341 WABANSIA AVE., CHICAGO, ILLINOIS

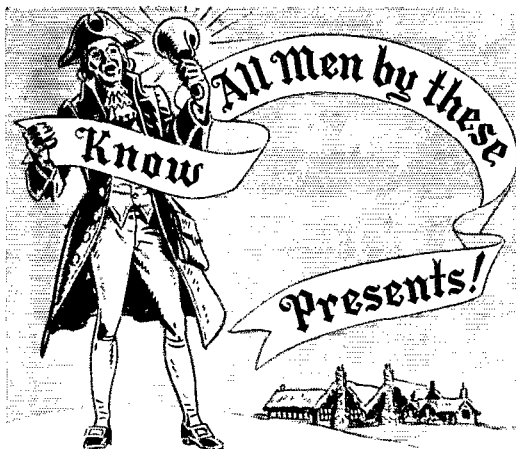

*It is only fitting that at this season we give pause for a moment to contemplate the many Blessings which are ours and to rejoice with you that of all the places of the Earth, we are fortunate enough to live in a Land of Peace and Promise.*

*In looking ahead to the New Year, let us more firmly determine to solidify the Partnership ties which bind us together in the common cause to make that Peace secure and long lasting.*



*If, at times in the past year, you have had to endure delays and tardy delivery schedules, it was because a more pressing and more universal National Duty was ours to fulfill.*

*The entire Kenyon Organization from President to Watchman are as one man in support of the great cause which will make this Holiday Season more secure and to insure for you and for us — for all the future —*

**"Peace on Earth to Men of Good Will"**

KENYON TRANSFORMER CO., INC.  
840 BARRY STREET  
NEW YORK, N. Y.      DECEMBER 25, 1940

parties? That is beyond my dim imagination. They serve absolutely no useful purpose, and clutter up those bands which are the avenues of communication.

I am sure you are aware of the overcrowded conditions of particularly our 75-meter 'phone and 80-meter c.w. bands, more so recently due to the exodus from the high-frequency bands, also the ever increasing number of amateurs. These communication bands need no exploration, nor do the amateurs who work them need introduction to each other. Then why do we have these parties? . . . If they were held say on 2½ and 5, also possibly the 10-meter band, they would create more interest in these spectrums, and at the same time relieve congestion where relief is most needed. These bands need exploration. Think this over.

. . . During the past two week-ends while the QRM parties were in session I was called upon with important traffic. In order to get these messages through correctly I was compelled to spend 55 minutes, which under ordinary circumstances should not have taken more than 5 minutes. . . . This Sunday morning the Michigan Emergency Net tried to function in their weekly drill; they had to give it up for a bad job. O.P.S. QRM. This is a deplorable condition which must be corrected.

I like to see fellows enjoy amateur radio and get as much pleasure out of it as the art affords in rag-chews, etc., but these parties are not fun, nor are they funny. It is a serious proposition, with nothing to be gained.

. . . We should ban child's play in the exchange of a few meaningless numbers and scores from our activities; there is no room for this at the present stage of the game. I hope you will agree with me. It looks like we have more serious business at hand.

— Arthur Grolz, W8DK

U.S.S. Wyoming, Norfolk Navy Yard, Portsmouth, Va.

Editor, QST:

It gave me just a touch of nostalgia to open the November issue of QST and find the announcement of the A.R.R.L.'s Eleventh Sweepstakes. I suddenly realized that I wouldn't be able to take part in the contest this year, and it hit me hard. . . .

Being a Radioman Third Class in the Naval Reserve, I am doing active duty now, whereas just about a year ago I was oiling up the old bug and getting ready to loose that first momentous "CQSS." I never realized, then, what those S.S. contests would contribute to my operating skill, but as I look back now I can see that they served as some of the finest training periods in my radio experience.

So, even though I won't be in the thick of the fray this year, I'll be sitting down here in the radio shack of the Wyoming listening to skilled operators in the making. They will be having fun, then, but no one knows how soon that fun will be converted into valuable experience so necessary to-day in our own national defense.

— Jack Najork, RM3C/USN, W8HNH

### BCL QRM

4317 Barrington Rd., Kensington, Baltimore, Md.

Editor, QST:

. . . Having worked as control operator for some time with one of the local broadcast stations, I've been impressed by the number of 'phone calls the broadcasters get relative to amateur interference. As some of these calls are transferred to the technical department in order that information may be given to the complainant, I've found that the person logically calls the station which is being interfered with for information as to how the interference can be eliminated, except when he knows the amateur personally. The broadcaster has no other alternative than referring such complaints to the local F.C.C. office.

However, if the local clubs or S.C.M.'s or any other responsible amateur agency could arrange with the local stations to gather these complaints and distribute them to the offending amateur, I'm sure that many citations by the R. I. would be stopped before complaints reached his office. Also, the broadcaster would probably be glad to have some way of handling the complaints.

Possibly arrangements could be worked out whereby the station could forward the information or it could be picked up periodically by some person connected with the amateur organization, who could distribute them as necessary.

— William Hoos, W3FDJ

# Build It Yourself!

## 12 WATT UNIVERSAL TRANSMITTER

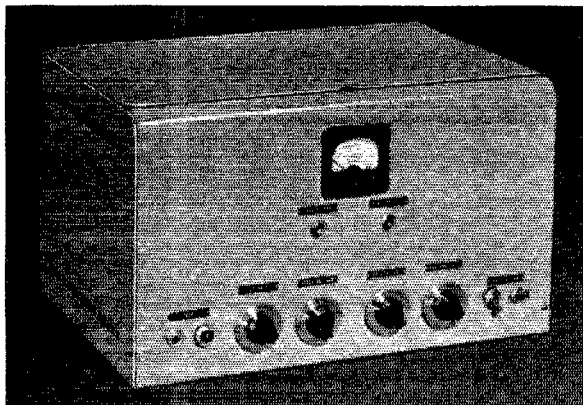

The complete transmitter is mounted in an attractive metal cabinet and the entire unit, including the chassis, is finished in smooth gray enamel.

### THORDARSON TRANSMITTER GUIDE

No. 344E

Illustrates and describes 14 smart, new transmitters — from 20 Watts CW to 1000 Watts Phone — including two mobile types. 44 pages of complete details including diagrams, parts lists, photos, etc. You can obtain your copy now from your Thordarson Distributor or write the factory direct. 15c postpaid anywhere in the U.S.A.

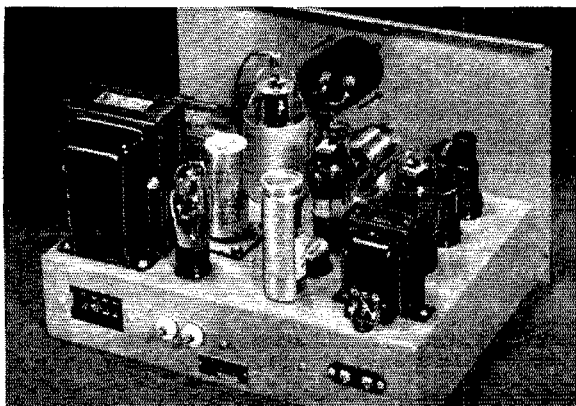

Another new Thordarson designed and laboratory tested transmitter. Operates on either 115 volts AC or 6 volts DC, without change of parts or wiring for conversion from AC to DC — only the insertion of proper power plug is required. The transmitter may be used on all bands from 160 to 10 meters, and doubling may be accomplished in the crystal stage when using 160, 80, and 40 meter crystals. A built-in network provides matching to any type of antenna. A single meter is provided with switch which permits reading plate current in either the oscillator or final stage.

*Transformer Specialists*

# THORDARSON

*Since 1895*

500 W. HURON ST., CHICAGO

# RADIO TRAINING



**P**ORT ARTHUR COLLEGE—not privately owned, not operated for profit, a college built and endowed by the late capitalist-philanthropist, John W. Gates—offers the most thorough practical Radio training in America. P. A. C. owns Radio Station KPAC, which is equipped with the very latest type 1000-Watt high fidelity RCA transmitter, operating on 1220 kc. with directional antenna system. The college is authorized to teach RCA texts. Additional equipment consists of the latest type Marine and Airways Transmitter installation complete; SOS Automatic Alarm; Marine Direction Finder, two-way Television Transmitter and Receiver; Trans-radio Press Receiving Equipment; laboratory facilities where every phase of practical radio assembly technique is taught. Students assemble composite transmitters, audio amplifiers, RF amplifiers, etc. The Radio training covers thoroughly Airways, Press, Announcing, Teletype, Typewriting, Laboratory and practical experience at KPAC transmitter, control room and studios. Announcing is an optional part of this training; nevertheless a number of students annually make successful announcers.

Port Arthur College pioneered the teaching of radio with its first classes in 1909, and for thirty-one years has maintained an active Employment Bureau that is successful in placing graduates in airways, broadcast and marine radio industries.

*If interested in details about the Radio Course, write for Bulletin R*

**PORT ARTHUR COLLEGE**  
**PORT ARTHUR (World-Known Port)**  
**TEXAS**

## Minnesota Hams Whip Storms

*(Continued from page 39)*

mercial stations went on the air and told all listeners whom to call if they were attempting to locate relatives.

George H. King, W9OTE, Minneapolis, worked from morning to night on Tuesday. "The telephone rang continuously," he says. "My wife couldn't get away from it long enough to cook dinner."

Up in Kasson, Minn., Robert S. Erickson, W9QNH, was contacting missing hunters and relaying the messages. In Minneapolis, Forrest Nelson, W9NNO, and Arthur Anderson, W9ZMQ, never moved from their sets.

Trains stalled for 10 hours — for 15 hours — were located, and the operators stood by until the crews informed them "All's well."

Near Farmington, Minn., a C. M. St. P. & P. train steamed onto a siding, and the conductor informed passengers that trains ahead were blocking the main line. Passengers spent the night on the train, and when morning came they were still trapped. Dr. Ralph D. Casey, Chairman of the Department of Journalism at the University of Minnesota, had two urgent messages to get out, one to his family and one to faculty associates. But all telephone and telegraph lines were down. Finally, he located Ham Clay, Jr., publisher of the *Dakota County Tribune*, who took him immediately to Kenneth G. Springen, high-school instructor and amateur operator. In less than 10 minutes Springen had contacted a St. Paul operator and the messages were delivered.

Many persons from Watertown were stranded in Minneapolis. In that South Dakota city, however, Stanley L. Burghardt, W9BJV, was steadily on the job, and contacted dozens of persons.

Once, at the height of the storm, Burghardt's antenna collapsed, and he had to step out into an almost blinding gale to do a hurry-up job that held for the rest of the storm.

Fred Herman's antenna collapsed, too, and with only a pair of pliers he got it back in operation. Three times his power failed, but with the aid of his emergency plant he stayed in continuous operation.

Tom Davis, W9VVA, at Willmar, worked steadily from 10 A.M. to 5 P.M., as did Sherman Booen, W9RHT, at Albert Lea.

The operators virtually made the Minneapolis and St. Louis railroad their personal property "for the duration," and when they had finished, officials of the road could hardly find words to express their appreciation. The "thank you" calls from other railroads and persons aided were still coming in a week later.

It was grim work, but there was humor in it, too. Anderson recalls that one Minneapolis woman blandly demanded that he locate her husband "somewhere up in the North woods." He says she probably is still not convinced that this would have been a difficult assignment indeed.

## CLEARANCE SALE!!

### WELL KNOWN GROSS TRANSMITTERS

*Completely Wired and Tested*

95 WATTS C.W.....	\$ 64
95 WATTS PHONE & C.W...	110
150 WATTS PHONE & C.W...	200
250 WATTS PHONE & C.W...	295

*Descriptive Bulletin on Request*

**GROSS RADIO, INC.**

51 Vesey Street

New York City

# NEW!

## GL-866A/866

### All the Wallop

### of an 866A

### at the Price of an 866

### Completely Interchangeable with Both Types...

*Only* **\$1.50**

### An amazing new tube and it's a bargain!

See or write your G-E dealer without delay.  
General Electric, Schenectady, N. Y.

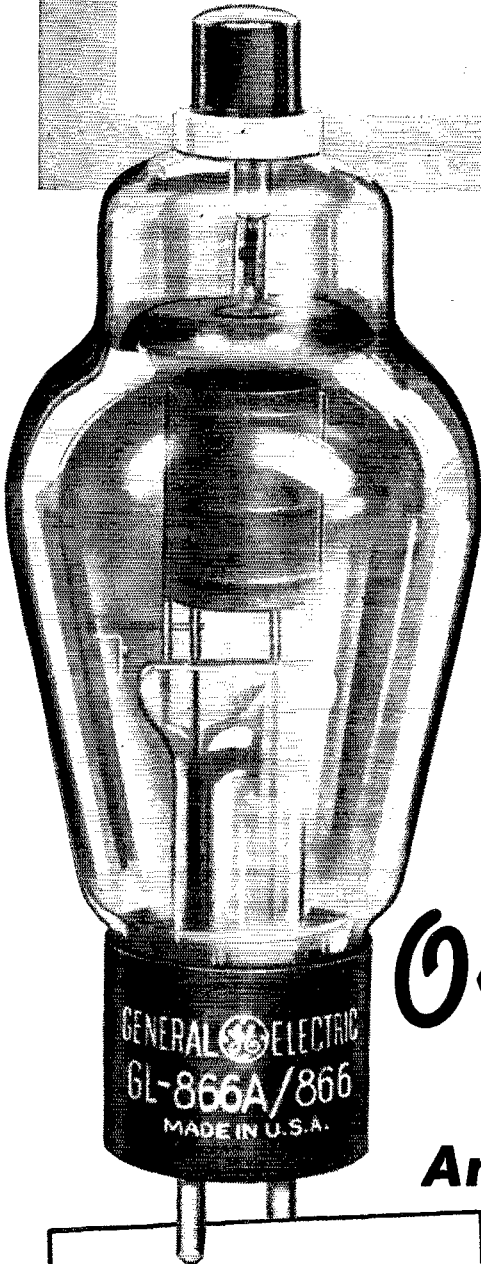

#### RATING

Fil. volts.....	2.5
Fil. Amp.....	5
Max. inverse peak plate volts.....	10,000
Average plate amp.....	0.25
Peak plate amp.....	1.0

#### BANDSWITCHING?

See "Magnetic Bandswitching" by Lew Bellem in QST for October, 1940. See your G-E dealer for those GL-807's and GL-814's.

# GENERAL ELECTRIC

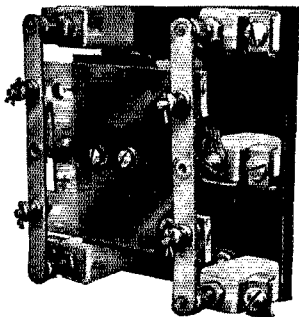

## NEW HEAVY DUTY RF ANTENNA RELAYS

Provide for switching antenna from transmitting to receiving.

### FEATURE NEW MATERIALS

1. Lucite cross arm carries contact fingers.
2. Isolantite blocks mounted on a Bakelite base support contact posts.
3. Contact fingers of stiff metal blades using coil springs to maintain contact pressure.
4. Contacts arranged for double pole, double throw, single break and rated at 25 amperes.

Write for Circular 507B

## WARD LEONARD ELECTRIC COMPANY

41 South Street

Mt. Vernon, N. Y.

PATENTED JEWEL MOVEMENT DELUXE  
Genuine

## VIBROPLEX

"World's Finest Semi-Automatic Key"

This Patented JEWEL Movement De Luxe Vibroplex key places at your command a degree of sending performance which we believe is unapproachable by any other make of key. Operators who have used it say it is the outstanding key value. If you get a kick out of performing a smart looking key that will particularly delight with the polished chromium parts and base, colorful red switch knob, finger and thumb pieces, green silk cord and, above all, the "feather-touch" action and brilliant sending performance of these JEWEL movement De Luxe Vibroplex keys.

832 Broadway

THE VIBROPLEX CO., Inc.  
New York, N. Y.

Mail coupon for catalog of Vibroplex keys priced from \$8.55 to \$19.50

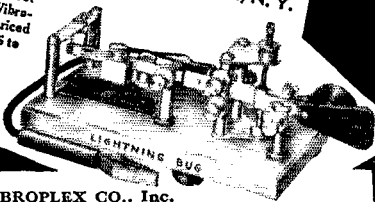

THE VIBROPLEX CO., Inc.  
832 Broadway, New York, N. Y.

Please send me your New FREE Catalog of Vibroplex keys.

Name.....  
Address.....  
City..... State.....

Another woman called Anderson and said: "There's a car stalled out in front of my house, and it's been there for hours. What are you going to do about it?"

Anderson suggested she try the police department.

Totalled up, it was another great chapter in the story of amateur radio operation in the United States, and hundreds of persons in the Dakotas, Iowa, Wisconsin and Minnesota will be eternally grateful.

Supplementing Mr. Pritchard's narrative account, additional reports on amateur work during the November storm emergency are here summarized.

From Sherman Booen, Albert Lea, W9HRT:

"When all other means of communications fail, call on the ham radio operator! . . . About 6 p.m. most of the wire facilities of Albert Lea had been wiped out. The railroads were without orders, many people were stranded, and human suffering became acute. The 75-meter band became a beehive of activity. . . . W9BJV of Watertown was the first to take up the torch. I don't know how many hours Stan spent on the air, but it seemed he was on continually. . . . After sending a dozen personal messages Monday night, I went to bed, realizing that anything could happen. Tuesday morning at 10:30, the M. & St. L. depot at Albert Lea called. The dispatcher wanted permission from the chief at Minneapolis to start a snowplow north. . . . I went on the air. . . . W9BPK took the message and within 10 minutes the OK was given to Albert Lea to start the snowplow. At the same time all southbound traffic was ordered held at Montgomery. . . . About that time W9UOS, Fort Dodge, Iowa, reported that the local depot wished some information from Minneapolis. The message was relayed from W9UOS to W9RHT to W9BPK, then back via the same route. . . . A train was started from Fort Dodge, as a result of the contact. From then on until 10 p.m., the M. & St. L. sent 15 messages and answers. . . . Service to the railroads continued until wire service was restored. . . .

"The Interstate Power Co. wished to get a report from the head office. I took the message and relayed it through W9UOS to W9CVU at Cedar Rapids, Iowa, who telephoned it. . . . Hundreds of personal safety messages were handled. . . . A group of Hormel employees were marooned in Farmington. W9QMR relayed to W9OTE at Minneapolis, then to W9RHT at Albert Lea, then to Austin via the only telephone wire still up. That wire happened to be the KATE broadcast loop. . . . The worries of many people were dispelled by short wave radio. . . . Snow static was terrific, the 30,000-volt power line was chattering away R9, and the skip was long and uneven. Fading was very bad. . . . The Minneapolis and St. Paul gang figured

BUY ON EASY TERMS · MAIL ORDERS PROMPTLY FILLED · WRITE FOR FREE CATALOG

*World Wide Service*



Model  
**5X-28**  
for only  
**\$15.95**  
down

Send for our New  
and Bigger Catalog  
with Exceptional Values

## WORLD WIDE SERVICE

• A complete stock of other Hallicrafter Models on hand for immediate delivery. . . . Write for details. Liberal Trade Allowance and Budget Plan.

THIS title in three short words describes fully the performance that we have been carrying on for the last seven years . . . by command performance of thousands of satisfied Radio Shack boosters reaching 'round the globe. This host of friends through the years buys their needs from us, confident that we will perform to their complete satisfaction. You too can depend on us — we guarantee your satisfaction.

*The* **RADIO SHACK**  
167 WASHINGTON ST., BOSTON, MASS., U.S.A.

# Pocket Tester FOR THE AMATEUR

TRIPLET  
Model 666-H

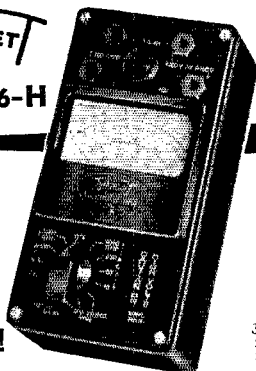

**\$14.50**

Net Price

**5000 VOLTS**

**SELF-CONTAINED!**

Size:  
3-1/16"  
x 5 3/4"  
x 2 3/8"

Model 666-H Volt-Ohm-Milliammeter is a complete pocket size tester — with AC and DC Voltage ranges to 5000 Volts (self-contained). AC and DC Voltage at 1000 ohms per volt 0-10-50-250-1000-5000; DC Milliampere 0-10-100-500; Resistance 0-300 ohms; shunt type circuit, 10 ohms reading at center scale; 0-250,000 ohms, series type circuit, 3700 ohms at center scale. Higher resistance measurements available by using external batteries. Selector switch for all instrument readings. The ideal Pocket Volt-Ohm-Milliammeter for amateurs, radio technicians, industrial engineers, research. Black Molded Case and Panel. Completely Insulated... with RED DOT Lifetime Guaranteed Measuring Instrument. **\$14.50**  
Dealer Net Price

Section 251 WRITE FOR CATALOG! Harmon Avenue

THE TRIPLET ELECTRICAL INSTRUMENT CO.  
Bluffton, Ohio

## BE PREPARED —

*Learn the Wireless Code*

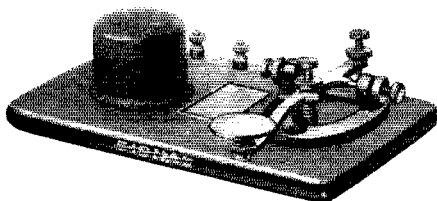

Make your spare moments count now! Learn the wireless code with a Signal wireless Practise Set. Set consists of key and high frequency buzzer mounted on a mahogany finished wood base equipped with binding posts. The code is printed on a plate fastened to the base between the key and buzzer. Adjustable buzzer. Price of instrument illustrated is \$3.40 list. If your jobber cannot supply you, order direct.

SIGNAL ELECTRIC MFG. CO.  
MENOMINEE, MICHIGAN

Established  
1892

**SIGNAL**

it out so that someone was on all the time. All I had to do to get into the cities was to call for just a few minutes, and either Minneapolis or St. Paul would be standing by, ready to relay a message via the land line to its destination. . . ."

W9HRT, incidentally, is chief announcer and program director of KATE, and when not on 75-meter 'phone during the emergency he was broadcasting personal messages on the b.c. band.

From Kenneth G. Springen, W9QMR:

"... At 5 P.M. the local AP correspondent called me and asked if I could get a message through to Minneapolis in case the storm continued. I informed him I could if the power was still available. About 8 o'clock the same evening he called me again, giving me an AP dispatch to handle as all land lines were out of commission. It was only then I realized that the services of my station might be needed badly. . . ."

"Unable to raise any Twin City hams on 80, I contacted W9WCA, Douglas Lovelace, at Duluth, who finally raised W9BCT, Bert Coil, of St. Paul, and turned him over to me. . . . We made a schedule for 7:15 A.M. the next day, little knowing the deluge of messages that was to come.

"Next morning things began to look serious. . . . Here in Farmington over one hundred travellers were snowbound and innumerable others in farms along the highways. Messages poured into my house, and Mrs. Springen spent practically the entire day answering the telephone and writing messages for me to send to families of stranded travellers, besides numerous messages for the highway department, in routing snow removal equipment, the Jefferson Bus Company, and AP press dispatches.

"W9BCT . . . stayed on the job until his transmitter blew a by-pass condenser. He then got W9HCC at Wyzata for me by land line, and HCC took over until BCT got his transmitter back on the air. . . . The Minnesota Net, directed by W9BHY, did a grand job of relaying and delivering messages during the storm. . . ."

T. L. Graffunder, W9BMJ, of Marshall, Minn., is reported by W8CBI as working with 4 watts input and a wire thrown out the attic window. Despite weak signals and QRM, W8CBI, W2EC and W3ASW succeeded in getting W9BMJ hooked up with the Minnesota Net on 3795 kc.

Other stations who participated in the emergency work include: W9GEU, Rochester; W9WAS, Redwood Falls; W9BIY, Winona; W9BQY and W9UYO, St. Paul; W9MYX, Sioux Falls, So. Dak.; and W9LKC, La Porte City, Iowa.

— C. B. D.

**SWITCH  
TO SAFETY!**





# START 1941 with a Skyrider SX 28 by hallicrafters

pay only **\$15.95** down and  
take all year to pay the balance

**\$12.68**

per month  
for  
12 months  
and it's  
Yours!

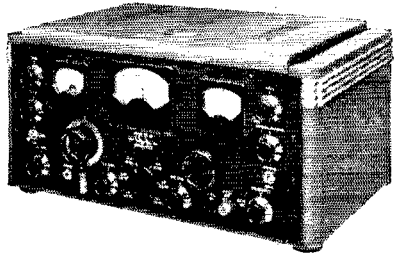

★ 15 tubes, 6 bands, 540 kc. to 43 mc. 2 stages preselection. Adjustable noise limiter, P.P. high fidelity audio. Band pass audio filter and other features as advertised in Dec. QST. Cabinet or relay rack mounting. Panel of 1/4" steel morocco. Machine tool, grey wrinkle steel cabinet. Designed to government specifications.  
SX 28 complete, less speaker, cash price . . . . . \$159.50

## CHOOSE ONE OF THESE FINE SPEAKERS

Regular PM 23 speaker in metal cabinet . . . . . \$12.00  
Hallicrafters Jensen bass-reflex enclosure 30" high, 16" deep, 22 1/4" wide . . . . . \$29.50  
Hallicrafters Jensen bass-reflex enclosure 23 1/4" high, 10 1/4" deep, 17 1/4" wide . . . . . \$19.50

## New Sky Champion S20R

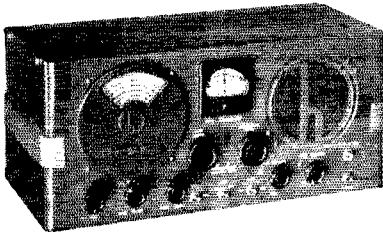

**\$4.95** down **\$5.90** per month

**EIGHT MONTHS TO PAY!**

Sensitivity, selectivity, and all-around quality performance you'd expect only in a high priced receiver . . . yet Hallicrafters give it to you for only \$49.50! Has all the essential controls for good amateur reception. Complete with tubes and speaker. Nothing else to buy. Cash price . . . . . \$49.50

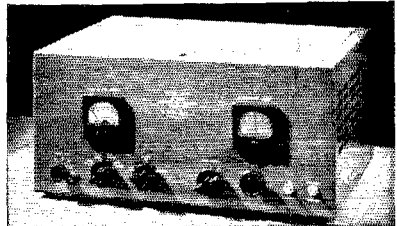

## hallicrafters HT-6

25 w. phone and CW Transmitter  
**\$9.90 DOWN . . . \$7.87 per month for  
12 months or \$15.74 per month  
for 6 months**

Main features include 25 w. output, clickless keying, 6 bands 160 to 5 meters. Coils for any 3 bands may be plugged in, pre-tuned, and switched from front of panel control properly connecting all circuits from crystal to antenna. Uses any high level, high impedance mike.

HT-6, with tubes, less coils and crystals . . . . . \$99.00 cash

## FREE . . . a book every Ham should have BIG NEW CATALOG

Just out . . . with many more items than we've ever put between the covers of any catalog. Thousands of bargains, sets, parts, accessories, supplies, of best known makes. Hundreds of illustrations. This book belongs in every "ham" shack, ready for instant reference. Helps you plan your new rigs, figure costs, learn sizes and specifications before you start construction. NEWARK'S most complete amateur radio catalog . . . 1941 issue . . . just out!

## How to Order Your Hallicrafters Set

Pick out the receiver or transmitter you want, and write or print your order plainly. Include a transformer in the same order, if you want to. Write name and address plainly, enclose down payment and credit reference. We ship immediately upon credit approval. You pay balance plus carrying charges, in equal monthly payments of \$5 or more. Any Hallicrafters receiver may be purchased this easy way if you order it from NEWARK!

★ ORDER TODAY DIRECT FROM THIS AD ★

## HIGH VOLTAGE POWER TRANSFORMERS

One of America's largest transformer builders made these . . . and NEWARK'S immense amateur radio business enabled us to get them for you at a price! We guarantee every one. Real "hustlies" they are, and just the thing for your Ham rig!

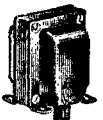

Choice of Two Filament Types  
No. 4140 — 600-0-600 V. — 200 Ma. Filaments: 7.5 V.C.T.-3A. — 5.0 V.C.T.-3A — 2.5 V.C.T.-10 A. Wt. 8 1/4 lbs. **\$2.85**  
No. 4240 — 600-0-600 V. — 200 M.A. Filaments: 6.3 V.-4 A. — 6.3 V.-3 A. — 5.0 V.-3 A. Wt. 8 1/4 lbs. **\$2.85**

# NEWARK Electric Company

323 W. MADISON ST.  
Dept. Q CHICAGO, ILL.

# Station Activities



## ATLANTIC DIVISION

**EASTERN PENNSYLVANIA** — SCM, Jerry Mathis, W3BES — W3ADE reports plenty of Sweepstakes interest in Harrisburg. AKB put in a little time in the SS and is holding down a pile of schedules. AOC suggests a Section bulletin. What does the gang think of this? If no more information or subject matter is supplied for it than for the S.C.M. report, it could be printed on a post card. Hi. AQN states that the following stations are reporting into the Eastern Penna. O.R.S. Net: 3HCT, 3DXC, 3BXE, 3DRO, 8ATF, 8OML, 8HKS, 3BES and 3DGM ran a close race in the O.R.S. Party. RXE has been pounding some mean brass lately. In four successive weeks he operated in the O.R.S. Party, R.M. Nite and Sweepstakes, besides making the B.P.L. DRO wants a schedule with Allentown or Bethlehem. HFE is back on 112 Mc. again with frequency modulation. EFH entered his Field Day portable in the S.S. Contest. FPC, our P.A.M., received his 20 w.p.m. Code Proficiency Certificate. FXZ received her 30 w.p.m. certificate and a QSL from NAA. GET had to move during the S.S. Contest, thereby losing many points. HYD is in the Navy. With the assistance of GRF's NC-101X, GKO went to town in the Sweepstakes. With the assistance of BR's NC-101X, 3FEW went to the same town. Hi! HFD enjoyed the SS so much he wants 'em to bring on another contest. HRS is rebuilding his rig into a rack for safety. QP is back again with a pile of KA traffic. 8ASW looks forward to more traffic when conscription gets going. There is a new transmitter on the fire at 8BQ. EU visited AVK. QEW received his 25 w.p.m. certificate. UQM enjoyed his first O.R.S. Party. GV broke two million in the ORS Party. FLA is now in Michigan working for the F.C.C. SSP is in the Army. The Eastern Penna. O.R.S. Net drills daily except Saturday and Sunday, at 6 p.m. and 10 p.m., on 3835 kc. 8ATF has a new HQ120 and is handling much local personal army traffic.

Traffic: W3ADE 62 3AKB 257 3AOC 935 3AQN 160 3BES 33 3BXE 401 3DRO 47 3DXC 11 3EFH 22 3FXZ 34 3GHM 3 3GKO 1111 3HCT-3HFD 7 3HRS 290 3IAY 6 3QP 597 8EU 104 8HKS 25 8SNZ 48 8UQM 4 3HZK 5 3JEW 547 3HFE 8 8GV 2 8ATF 53 8ASW 124 8OML 31 3EML 60.

**MARYLAND-DELAWARE-DISTRICT OF COLUMBIA** — SCM, Hermann E. Hobbs, W3CIZ — Eppa W. Darne, Chief RM, W3BWT, Roy Corderman, Regional Co-ordinator, W3ZD. The Eastern Shore gang is holding a series of semi-monthly meetings. They're sort of local ham-fests. FRV has been transferred to Sykesville, Md. He will be greatly missed among the W.M.A.R. gang. BWT has a fine bunch of traffic schedules, and keeps them all busy. Good work. "EP." CDQ has resumed her weekly schedule with 8CMP. The Y.L.R.L. is flourishing like the proverbial green bay tree, and keeps the Chairman QRL. The Y.L.R.L. are gathering in the Code Proficiency Certificates. CMS has rejoined the Md. A.A.R.S. Net. The W.M.A.R.C. is planning checker games via amateur radio. EIZ manages to work in a schedule Sunday mornings from 11 to 12, and keeps the A.R.R.S. Phone Net. EQK would like schedule with stations in Arizona and Utah for W.A.S. on 1.75 and 3.9 Mc. FPK's 805 went bad, and he has rebuilt for 812s. In addition to a bride, FTD also has 1 kw. on 3.9-Mc. 'phone, with Class B 203Z's modulating a pair of T200's. DRD is a new O.R.S. in this Section and is T.L. "C" outlet for Del.; he picked up more than six million points in the Oct. ORS Party. DWX is active on 14 Mc. and is good outlet for Baltimore traffic. HUM reports TL AP running smoothly on 3630 kc. at 9.30 p.m. daily. 1VT is displaying a 35 w.p.m. certificate. He is planning on getting a signal shifter in the near future. 3OZ, Baltimore, Md., is a new O.R.S., O.P.S. in this Section. WIIZO/3 is a new O.R.S. located in Annapolis, Md. 3EUT is a new O.P.S. in Cumberland, Md. The Washington Radio Club recently had a talk by Oscar Reed, W3FPQ, on frequency-modulated transmitters and receivers. This was followed by a demonstration in conjunction with 3BXO, Washington's pioneer frequency-modulated experimental broadcast station. On November 9th the Washington Radio Club held its annual fall hamfest in the Palm Room of Hotel 2400. A turkey dinner, prizes,

speeches, and entertainment by Dr. Moore, Amateur Magician Extraordinary, made for a large evening, thoroughly enjoyed by the eighty-five hams present from Washington and Baltimore. Dr. Moore told of his early experiences as an associate of Dr. Lee DeForest in his pioneering exhibit of wireless radiotelephony.

Traffic: W3BWT 1077 CDG 3 CDQ 4 CIZ 294 ECP 27 EIZ 20 EQK 23 DRD 156 DWX 2 EKZ 108 GJY /FIO 165 HUM 155 1VT 6 CXL (WLM 3409).

**SOUTHERN NEW JERSEY** — SCM, Lester H. Allen, W3CCO — Ass't SCM and A.A.R.S. Liaison R.M., Ed. G. Raser, W3ZI — NCR Liaison R.M., Ed. B. Kerr, W3CCC — Regional Co-ordinator in charge of Emergency Co-ordination. Ted Toretti, W3BAQ — R.M.'s: 3BEI, 3BYR, 3ITU — P.A.M., Bill Hannah, 3EUF; Section Net frequencies. ORS, 3700 kcs., OPS, 1980 kcs. If you haven't affiliated yourself with one of the Southern New Jersey A.A.R.S. Nets, the opportunity is still available, so why not help the various workers in our Section put over the individual networks? There are still several of the various counties unheard from in respect to appointments and net members. Just to show your S.C.M. that his work is appreciated, how about getting at least one appointment for each county in our Section, and send in some more traffic totals and comments for the column. One thing that is sadly overlooked in our Section is the lack of use of the A.R.R.L. monthly reporting cards. These cards, fellows, show me that you are active; they also assist me in writing this column. Last, but not least, they list your traffic totals. According to the rules and regulations set up by the Headquarters, if you miss two months in succession, without good cause, the S.C.M. can cancel your appointment. If these cards are not forthcoming, appointments will be cancelled and your column will shrink quite a good deal in size. Heretofore your S.C.M. has been travelling around a good deal in the Section trying to dig up the dirt for this column but, due to business conditions, must curtail a big portion of my activities. 3IMY recently constructed a 3-element rotary beam for 28 Mc. 9YBM, formerly of Grand Rapids, is operating 14-Mc. 'phone from his fixed portable location in Trenton. 8TZC and 8SZK, both of Buffalo, were recent visitors in Trenton at W3AQ. These boys are enlisted Army men stationed at Fort Dix, N. J. The new AEC members for the month are: 3GMY, ISY, DCQ, IOW, GPS, GRW and CFB. We welcome EOP to our O.P.S., O.R.S., O.B.S., and O.O. INF recently joined the A.A.R.S. ABF is building a new rig and expects to be on the various 'phone bands shortly. 3FTU was a recent visitor to Major Armstrong's laboratory. The Delaware Valley Radio Association has started a school which meets one night a week to teach code and theory. The course is under the leadership of ARN. GPU finally hooked up with CCO on 28 Mc. and was recommended for membership in the Rag Chewers Club. HEO has left the 'phone bands for a little 7-Mc. c.w. work. IPT is working 3.9-Mc. 'phone using cathode modulation. GLZ has new tower for the antenna. SW of the N.C.R. is looking for recruits in the Trenton area. IDY is working on 112 Mc. in Trenton, and reports having made contact with a station in Willow Grove, Pa., 25 miles away. GCU made 13,420 points during the O.R.S. Party, which isn't half bad. AVJ and GMY are doing a swell job as net controls. ACC gave 56 Mc. a whirl, and is doing swell. ABS reports he also is on 56 and enjoying it very much. CWG, one of the O.P.S. gang, reports he is the proud papa of a new baby girl, "Vesta Ann," born Oct. 12th. Jack also tells us he has new Meissner DeLuxe Signal Shifter and that he collect 9100 points in the O.P.S. fray. ZI is operating portable in the second call area using Doc's call, 3GNU. Ed and Doc are both operating the station at the N.Y.A. Resident Center and can be heard on both 'phone and c.w. AC and BJO have been recommended for O.P.S. appointments. How about it, fellows? Let's hear from you. ITU is increasing power to 100 watts input on 28 Mc. HHZ has been promising the boys around the Section a QSL card, after being out of cards for three years. AYC is doing fine on 28 Mc., and reports getting into the K6 district quite consistently. FMR is changing his final around so that he can get back on 1.75 Mc. to rejoin the O.P.S. Net on Thursday evenings. Due to a change in working conditions, our P.A.M., GNU, had to resign because moving to a new QTH in the Northern New Jersey Section. However, Doc is going to carry on his OPS work and is trying to encourage a N.N.J. 'Phone Net. Replacing GNU will be EUH, who will carry out the P.A.M. duties, and assisting Bill with net drills will be ITU at the controls

of A.Q. Hope you all have a very prosperous and successful New Year. 73.

Traffic: W3BYR 207 (WLVN 74) IFT 135 CCC 86 ZI 82 BUH 35 DNU 50 BEI 30 HLVT 29 EWK 21 OQ 16 HFX 15 GRW-ASQ 15 HAZ 20 A-Q-ITU 14 GCU 13 CCO 12 AEJ-AVJ 10 ACC 6 ABS 5 CWG 3.

WESTERN NEW YORK — SCM, Fred Chichester, W8PLA — R.M.'s: BJO, CSE, DSS, FCG, PCN. P.A.M.'s: CGU, RVM, UNY. E.C.'s: FNT, GWY, DHB, SBV, SMH, THC, KYR. Net frequency, 3720 kc. The Thirteenth Annual Hamfest of the Finger Lakes Transmitting Society was a big event in this Section. It was held at the Hotel Osborne in Auburn, on Nov. 9th, with an attendance of about 185 amateurs from Central New York and Northern Pennsylvania. Among those present at the speakers' table were K. B. Warner, Secretary of the A.R.R.L.; Brad Martin (W3QV), Atlantic Division Director; Doctor Woodruff, Past President of the A.R.R.L., and Doctor Simpson (W8CPC), who acted as toastmaster. Take it from us, "Doc" is some toastmaster! A.R.R.L. was well represented by Secretary Warner, Clark Rodimon, Managing Editor of QST, Roland Bourne, WIANA of West Hartford, was also present. The Telephone Employees Radio Association held a little get-together, with ALP, CSE, DSU, IGT, SED and TOD present. A steak dinner was served, and those who attended report that the hamfest was right up to the standards set by the Finger Lakes Club. Buffalo activities: HJG, GFP and MED were married this month. DSB is ready for 3.5 to 28 Mc. with his new 500-watt transmitter; the rig is the last word in transmitters and is the envy of many hams. The Buffalo Mike and Key Club schedules their annual election of officers for December. Their regular meeting place is the Buffalo Museum of Natural Science. The Western New York Radio Council also has election of officers in December. RL, PE and MBH have been speakers at the meetings of K-B-T Club this season. This club has filed application for affiliation with the A.R.R.L. They have signed up sixteen new members for A.R.R.L. Their meeting place is the American Legion Hall in Kenmore. QZP has a new YL op.; she was born in November. Congrats, Omar. MQX took the fatal step Nov. 9th. JTT, one of W.N.Y.'s leading traffic men, has left for Washington, D. C., to work with the Navy Department. We regret his loss in both O.R.S. and A.A.R.S. nets, and wish him lots of good luck in his new work. BJO is now N.C.S. in the 3.5-Mc. A.A.R.S. Net, and PCN is N.C.S. 2. RKM is N.C.S. in the 7-Mc. A.A.R.S. Net. OMP, who is active on 3.5 and 7 Mc., has filed application for membership in the A.A.R.S. PCN is now located at Kenmore. SFD and UPJ are new O.R.S. in the Section, at Buffalo and Port Kent respectively. RVM has new modulators going with 6L6's in Class AB2. SZB has changed his rig from parallel to push-pull T55's, and installed the final tank condenser in oil. QQB is in Coleville, Calif. NA is using 6L6's and two half waves in phase on 28 Mc. UNY reports St. Lawrence Net members getting started for the season. JTW worked KC4USA and KD4GYM with his 20-watter for his 89th and 90th countries. He is after a three-band W.A.S. DOD and his xyl, TUQ, have returned from their honeymoon. On their trip to the West Coast they visited 8SJF, 9GDC, 6QIL, 6LDQ, 6QQL and 6QQB. Rochester now has several professors among its hams; LTJ, MC, DFN, TEX and RKJ are all teaching radio at night school. ILO has left Rochester for a new position at Buffalo. QGO was married Oct. 19th. YDA, a new Rochester ham, is on 1.75-Mc. phone with a 6L6 final. MC has a new signal shifter. The R.A.R.A. hamfest will be held on Washington's birthday, Feb. 22nd. OQC has joined the U.S.N.R. for active duty. R.A.R.A. holds a club meeting on the air every Sunday, at 11:00 A.M., on 2020 kc. SZK is now Staff Sgt. with the 174th Infantry at Fort Dix. SBV has been working on a rig for 28 and 56 Mc. ADY won the door prize at the Schenectady hamfest, a T40. While trying it out in his final his old T40 rolled off into the floor, so he still has a single tube final. H1 RZF was home on furlough, and gave the Elmira Club a talk on how radio operators work in the Navy. TEP is a new O.P.S. in the Section. UEU is building a rig for 28 Mc. UYP, with 120 watts, is using a 120-foot center-fed vertical. SMI spent his vacation visiting MUQ, TOD, IGT, CSE, ALP, DSU and RKM.

Traffic: W8BJO 272 CSE 43 DSS 111 FCG 322 KYR 22 PCN 208 RKM 287 SBV 74 SMI 67 UPJ 61 UXT 29 JIW 416 JTT 8 SFD 44 PLA 172 AQE 144 RGN 44.

WESTERN PENNSYLVANIA — SCM, E. A. Krall, W8CKO — Ass't S.C.M. in charge of Emergency Coordination, W8AVY — Ass't S.C.M. in charge of O.R.S., 8KWA,

P.A.M., 8RBI, O.R.S. meet nightly at 8:30 P.M. to handle traffic. BWP reports that UOUQ is on assignment at Bloomfield, N. S. 90TM is a fixed portable at Wilkinsburg. OUT is on duty at Newport, R. I., with the Naval Dental Corps, and wants to hear from the gang. QRK sent in a nice report. TTD is still pounding brass on 3.5. Mc. JSA is a papa to a new junior op. TOJ worked hard in the S.S. NCJ sends in a nice report and says that this winter promises to be a busy traffic season. Both he and XYL hold 35 w.p.m. certificates. RBM has finished his 28-Mc. rig and beam. We note that Doc Woodruff still schedules his old friend W3CDQ. MJJK sends an extract from a broadcast to Army Amateurs to the effect that it is expected that every A.A.R.S. member called to duty under the selective Service Act will be assigned to duty with the Signal Corps. PA 4 would like some new members. Contact W8KWA. IOH will use e.e.o. from now on. KYW has a new QTH. BOZ participated in the River Net. New arrivals on ten are UHO-UGL-AFP-GRX-UAW, and RBE. RMS is building a tower and rotary for 14 Mc. The W. Pa. A.A.R.S. 'Phone Net now has eighteen active members. BHN, KBJ and the rest of the A.A.R.S. 'Phone Net are experimenting with loop antennas. QXT has done some tall rebuilding. PX is still doing fine work with his Weather Net. Stations in the upper Ohio River Valley are requested to contact him for schedules and drills. SJX booms through with extra power on 3.9-Mc. phone. SHY is attending Carnegie Tech and is operating fixed portable in Pittsburgh. OVT has moved, and his transmitter will be set up at CKO's where he will operate. We need more O.O., O.R.S., O.P.S., and O.B.S. stations in W. Pa. Whether you have an appointment or not, how about sending a report in to your S.C.M. each month? CIR is reported to be operating on 28 Mc. instead of 56 Mc. NRI is active at Conneville. The Mon-Yough Radio Club at McKeesport is an active gang of amateurs. S.H.B.P.M. has been featuring educational movies at their meetings. The A.T.A. of W. Pa. is an up and growing organization as it has always been. As a reminder, all O.R.S. and O.P.S. are requested to send their monthly reports to the S.C.M. They have been neglectful in the past about doing so. Wick, KWA, reports that out of the twenty-nine odd counties in the W. Pa. Section there are only about six counties represented by active stations. We need more stations in the Northwest, Southeast and Southwest. He states that there is no reason why we cannot have a much more active net, even though there is not a great deal of traffic. If each member would originate a message each week it would help.

Traffic: W8NCJ 174 CMP 82 QBK 73 JSU 33 PX 41 MJK 23 RBU 22 BWP-KRY 18 RAT 16 HKU 4 RIS-SFV 3 PER 2 CKO 84 KWA 322.

#### NEW ENGLAND DIVISION

CONNECTICUT — SCM, Frederick Ellis, Jr., W1CTI — AW, KKS and MEC all make B.P.L. Hal, at W1AW, is working on a new modulator and 5-meter gear. The rig at KKS blew up at the start of the SS, so Bill had time for only 242 contacts! MEC is fast becoming one of the Nutmeg's consistent traffic pushers. As recorded last month, our grapevine dope on HSX was correct; at this writing he is back on the air from West Haven, signing WHSX/1. Welcome back to the air, Andy. Who has contacted NAA? We know AW, JFN and CCF have. Any others? KAT has moved his rig from a shack on the ground floor to living room on the second floor. BDI is busy with N.C.R. work. CSY moved and got set up just a week before the SS. LQK is hard at work on an e.e.o. for 3.5 Mc. APA ran two No. 4's and one No. 6 wire from the meter to the shack in his new home at Easton. B.A.R.A. raffled off 100 gals. of gasoline to raise money for emergency equipment. DWP received his 25 w.p.m. certificate on the last Code Proficiency run. KFN is working for American Airlines now. We will all miss you, Tommy, and will look for you signing portable. UE and MY are instructors at the Naval Reserve Radio School in Noroton Heights. UE 1 is on the air at Noroton and schedules BDI, JMY and CJD. Traffic for the school should be put through the Nutmeg Net or the above stations. BCG has overhauled his emergency 120-volt supply and is working on a new transmitter.

Traffic: W1AW 733 (WLML 11) KKS 669 MEC 482 CTI 174 KYQ 142 MGC 105 TD 90 ES 43 KQY 33 JFN 19 LVQ-KAT 16 KSJ 15 BDI 14 CSY 10 LQK 8 FMV 6 APA 5 JHN 3.

MAINE — SCM, H. W. Castner, W1HE — The Section

(Continued on page 78)

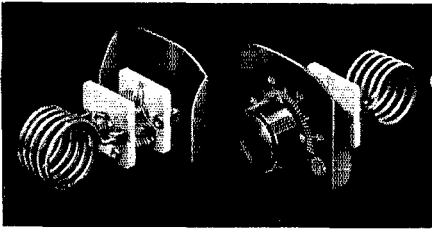

## MIDGET FREQUENCY METERS

MANY amateurs and experimenters do not realize that one of the most useful "tools" of the commercial transmitter designer is a series of very small absorption type frequency meters. These handy instruments can be poked into small shield compartments, coil cans, corners of chassis, etc., to check harmonics; parasitics; oscillator-doubler, etc., tank tuning; and a host of other such applications. Quickly enables the design engineer to find out what is really "going on" in a circuit. Sold in sets of 4 in handy protective case or individually.

90605	Range 2.8 to 9.7 mc.....	\$1.65
90606	Range 9.0 to 28 mc.....	1.65
90607	Range 26 to 65 mc.....	1.65
90608	Range 50 to 140 mc.....	1.65
90600	Complete set of four, in case...	6.50

JAMES MILLEN  
150 EXCHANGE ST.



MFG. CO. INC.  
MALDEN, MASS.

## What The League Is Doing

(Continued from page 19)

the result of the election can be determined after February 20, 1941, and will serve for the remainder of the 1941-42 term. The present alternate is W. N. Wintler, W7KL.

You are urged to take the initiative and file nominating petitions.

For the Board of Directors:

K. B. WARNER,  
Secretary

November 1, 1940

## Fifth U.H.F. Contest Successful

(Continued from page 29)

Because of the lack of active u.h.f. stations in certain sections of the country and unfilled gaps between other active centers, some messages did not reach delivery points by the close of the contest. For the benefit of the fellows originating these messages we list below the points to which such messages were traced.

Starting Station	Traced To	Starting Station	Traced To
W1AUN/1.....	W2ILK/2	W2LOS.....	W1MRF
W1BSG/1.....	W1HDQ	W2LXC.....	W3GGR/3
W1CEA.....	W1HDQ	W2MBU/2.....	W9VHG
W1CGY/1.....	W2ILK/2	W2MIV.....	W2LAU
W1DLY/1.....	W3BZJ	W2MLM/2.....	W1MRF
W1EHT.....	W3BZJ	W2MQS.....	W2GPO
W1EKT.....	W3HOH	W2MUD.....	W2LXO
W1HDQ.....	W3IWA	W2MWA.....	W2LAU
W1HXP.....	W9VHG	W2USA.....	W1HDQ
W1IJ.....	W3IWA	W3AXC.....	W8CIR
W1IUI/1.....	W3ABS	W3BWQ.....	W1IUI/1
W1JDF.....	W2CUZ	W3FBH.....	W1HDQ
W1JDV.....	W9VHG	W3GGR/3.....	W1HXP
W1KSB.....	W2CUZ	W3GQK.....	W1HDQ
W1LEA.....	W3GGR	W3HEK.....	W3ABS
W1LMU.....	W1HXP	W3HPX.....	W3CGV
W1LPF.....	W1BJE	W3HWN.....	W9VHG
W1LSN.....	W3GGR	W3IDS.....	W1MRF
W1MDN.....	W3BZJ	W8CIR.....	W2GHV
W1MEP.....	W9VHG	W8CVQ.....	W3ABS
W1MUB.....	W2ILK/2	W8EUO/8.....	W1HDQ
W1MWU.....	W2ILK/2	W8MDA.....	W3ABS
W1SS.....	W1HDQ	W8OKC.....	W9VHG
W2BZB.....	W2HRP/1	W8QDU.....	W3ABS
W2DAJ.....	W9VHG	W8QDU/8.....	W1MDN
W2DZA.....	W2GPO	W8TCX/8.....	W3HWN
W2FZA.....	W2LAU	W8TIU.....	W1MDN
W2JVT.....	W2FZA	W9NFM.....	W9ZHB
W2LAU.....	W1MRF	W9VHG.....	W1HXP

## Strays

W6NZ suggests an "Annual Crystal-Cleaning Day." A thorough cleaning of his batch of crystals more than doubled grid current to the following stage.

Rubber feet on a bug, if clean, will not slip on glass. You can get a piece of plate glass for a table top cheaply by watching for broken store windows. — W4GMO.

**Performance Accuracy Value**  
**ALL in the NEW PRECISION #832**  
**31 Range Rotary Selective AC-DC**  
**Multi-Range Tester**

★ LARGEST METER ever provided (3 1/4 inches is the ACTUAL WIDTH in such a compact instrument, only 7" x 4 1/2" x 3" overall.)

★ A single Master Rotary Range Selector allows ALL measurements to be made from ONLY TWO polarized slip jacks, except for the two highest voltage ranges.

★ RANGES • 6 DC voltage ranges at 1000 ohms per volt; 0-5, 20, 150, 300, 600, 1200 volts • 6 AC voltage ranges 600, 1200, 2400, 4800, 9600, 19200 volts • 6 DC current ranges to 5 AMPS, up to 500M ohms on internal battery • 6 DECIBEL ranges (-10 to +62 DB) • 6 OUTPUT ranges to 2400 volts.

★ ITS "PRECISION" BUILT — 1% wire wound bobbins — 1% matched metallized multipliers — individually selected calibrating controls — telephone cabled wiring, etc.

COMPARE THIS "PRECISION" VALUE at only \$14.95 net  
 This is only one of the more than 40 models comprising the complete "Precision" line of dynamic mutual conductance tube testers, combination test testers, multi-range testers, signal generators, etc. Prices start as low as \$70.95.

Ask for the PRECISION TEST EQUIPMENT 1941 CATALOG

**PRECISION TEST EQUIPMENT**  
 Standard of Accuracy SEE THEM AT YOUR JOBBER  
**PRECISION APPARATUS COMPANY**  
 647 Kent Avenue Brooklyn, New York  
 Export Div.: 458 Broadway, New York, U.S.A. — Cables: Morhanex

# 10 ACOUSTICALLY CORRECT REPRODUCERS AND CABINETS

ALL WITH  
*Bass Reflex*

CHOICE OF SPEAKER EQUIPMENT

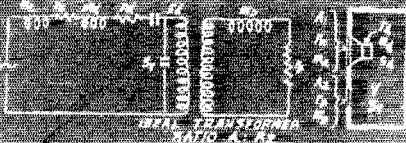

Equivalent circuit illustrating Bass Reflex principle.

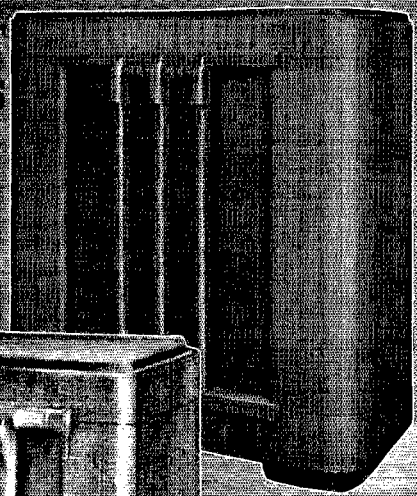

CR REPRODUCERS

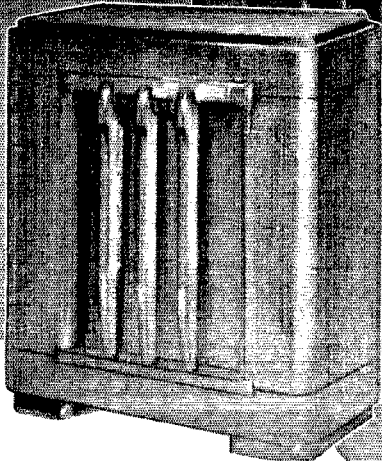

**B**ASS REFLEX gives you better sound reproduction because it enables the loud speaker to function with full effectiveness, to perform even better than with an infinite baffle. This great development, originated by Jensen Engineers, is available in a complete line of acoustically-coordinated reproducers and cabinets for every application. The arresting beauty of the new "CA" Reproducers qualifies them for the finest surroundings. Equivalent performance is provided in the practical, less expensive "MT" Reproducers. Economical "BR" enclosures accommodate your choice of speakers from 8 to 18 inch sizes. Write for complete information.

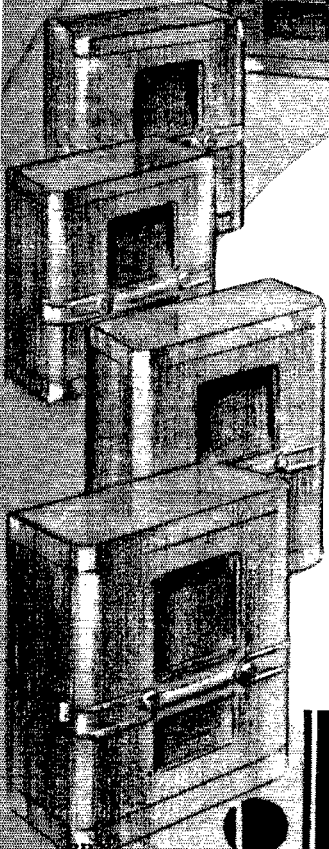

BR ENCLOSURES

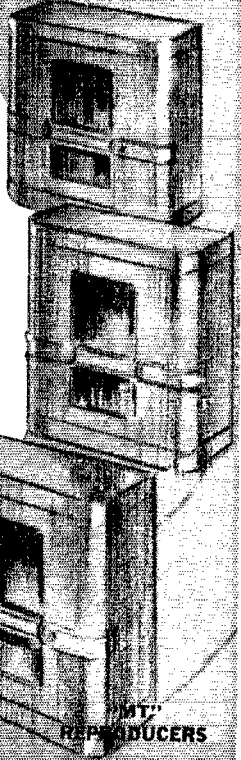

MT REPRODUCERS

# Jensen

JENSEN RADIO MFG. CO.  
6601 S. LARAMIE AVE., CHICAGO

(Continued from page 89)

is very active. WIDHH lost an 810. DRZ is on 1.7-Mc. 'phone. BAV is certainly a busy man with all his schedules. LIP is coming along fine with his code speed. MNI has a new D104 crystal mike on 1.75-Mc. 'phone. LWX has greatly improved his rig. IKE is reporting into the P.T.N. LSI has moved to Topsham. CBF has taken unto himself a wife, and is living in Auburn. Hams in Lewiston and Auburn include 1 Moving Picture Op., 2 BC Ops., 1 Textile Supt., 1 Banker, 1 Lawyer, 1 Army Captain, 6 Soldiers, 6 U.S.N.R., 4 Shoe Workers, 1 Farmer, 1 R.R. Sig. Engineer and 1 R.R. Section Foreman. WILKP has a new NC-200. The P.A.W.A. had a swell Halloween Party, October 29th! MCW sure does a great job on 28-Mc. 'phone. PQ has a new e.c.o. AKR is on 28-Mc. 'phone. DLC is on 3.5-Mc. c.w. FNI, has built a new fixed 28-Mc. beam which works fine. LHA is building a swell new band-switching rig. The "Country Line Net" had a swell meeting at IGW's on November 16th, with all XYL's present. ICQR of Feeding Hills, Mass., and SNSO of Fort Edward, N. Y., were present as the guests of honor with their XYL's. An orchestra was on hand, and it was a grand party. Those present were: SNSO, ICQR, ILOZ, ITB, IYF, IEWN, IIGW, IMVD and ILYK. The Northeastern Radio Club of Boothbay Harbor and Wiscasset is very active. WILUK was elected President at the recent annual meeting, held at HYK's. IQZ is active again. We hear that AMR is on 28-Mc. 'phone. KMM is putting in a fine signal on 3.5-Mc. c.w. The hams at Boothbay Harbor are teaching several recruits to copy code. MLP has sure progressed. He already has a fine collection of QSL cards. ALO has been very busy with U.S.N.R., active duty afloat, and moving his family and the Radio Club. The Livermore Falls Radio Club held its first meeting, Wednesday, Oct. 16th, at the U.S.N.R. Headquarters. ALO is Secretary and Unit Commander. MBD, LTH and IVZ are all rebuilding, and will be on soon. AUR is on 28 Mc. ITU uses 1.75 Mc. HXO has moved to Mass. FBJ has organized the Maine Net on 3.9-Mc. 'phone. It meets at 5:00 p.m. daily and is on until about 5:30 p.m. The stations at present reporting in are WIFBJ, WIAI, WIAUC, WIATS, W1BAV, WIDHD, WIEUL, WIGMD, WIKYT, WILKP, WILKA, WIDEG and WIKKZ. Contacts with neighboring state stations is contemplated. LBH, of Methuen, Mass., is a present outlet. This is an excellent idea, and I heartily endorse the idea as a preparation in case of need. MXR is new amateur at Auburn. KJU is on 3.5-Mc. c.w. The Maine A.A.R.S. is certainly going places. CFO had to resign command. KOU has been taking over the work for him, and LML has been appointed S.R.A. Note in the traffic report that the A.A.R.S. handled 1345 messages during the last period. Very fine work. Stations making up the Maine A.A.R.S. are: AMR, BKN, BTA, CFO, EFR, FAP, GE, GHT, GVS, IJF, IST, KOU, KTN, LAP, LER, LHA, LML and LIC. Reports come to me from all over the Section of the great interest in the WIAW code practice sessions. Many have written me that they have made great improvement in their speed through this excellent schedule. I hope every amateur in Maine will get a certificate. I hope you all know that NAA is on 5865-ke. c.w., Mon., Tues., Wed. and Fri., and that they work amateurs from 8 to 9 p.m. on the 3.5-Mc. band and from 9 to 10 p.m. on the 7-Mc. band, and you get a special QSL card for working them. Let's listen for them and show them that we are anxious to work grand old NAA.

Traffic: WIGOJ 81 IIE 105 LKP 10 LHA 50 IKE 14 LML 157 IYK 17 LIP-MAP 2 GXY 19 BAV 94 LYJ 27 GHT 24. A.A.R.S.: WIAMR 132 LML 148 CFO 53 EFR 86 FAP 135 GE 57 GHT 20 GVS 169 IJF 99 IST 34 KOU 177 KTN 74 LAP 76 LER 30 LHA 55.

EASTERN MASSACHUSETTS — SCM, Frank L. Baker, Jr., W1ALP — Let's make the NEW YEAR BIGGER AND BETTER. JOX is new E.C. for Newton. MQO is now O.P.S. and has a schedule with W9QJP. AAI is now O.R.S. and will be on 28- and 1.8-Mc. 'phone. LBI, LWH, IYU and KON applied for O.P.S. ALP has been on 112 Mc. and also went into the SS. At this date we have 23 O.P.S. and 27 O.R.S. in our Section. I would like to issue a challenge to each one of you. Who can sign up the largest number of new O.P.S. or O.R.S. in the next six months (Jan. 1st to July 1st) and get them to pass the usual test QSO and send in reports? Our present O.P.S. are as follows: GAG, JGU, AAR, JCX, LMB, JDG, BB, LO, GCU, KTE, ERE, JNU, SS, HUV, EHT, IN, LEU, JXU, LGH, HUP, IXL, EVJ, MQO. Our O.R.S.: LMO, KH, EPE, MEU, KCT, JYJ, BDU, HWE, WI, KMN, KCQ, QW, LNN, AAR,

FWQ, AKS, KXU, EMG, AGX, EVJ, AAL, LBY, BB, LWH, JCK, JSM, KZT. What say, gang? Let's build up our Section and show the others we are very much alive and on our toes. Don't forget the A.R.R.L. Party in January. New officers of the Hi-Q Radio Club of Lynn are: Pres., JIX; Vice-Pres., LWM; Asst. Secy., ALG; Treas., BSM; Activities Manager, JYB. Congrats and good luck. The whole Hi-Q gang are out for proficiency awards. Welcome to MYO, a new ham in Lynn; he's on 28 Mc. MJK has a new e.c.o. LYH is now on 14-Mc. 'phone and working DX. IRN is rebuilding for a kw. on 3.5 Mc. HOB worked K4FKS on 3.5 Mc. during the SS. W2HCV visited KTE. K4GIG visited GDY and LEU. W21YX, on 28,523 kc., wants a Sunday a.m. round table with W1's. QD sends in nice report of 112-Mc. A.A.R.S. Net. The following are members: AAR, BHL, EYR, KAL, LEM, LOV, LSR, MIF, MON, MQH and QD. They hold drills on Sunday mornings and Wednesday nights which tie in with the 1.75-Mc. A.A.R.S. Net. MON is Alternate N.C.S. We would like any other reports, traffic and otherwise, from other A.A.R.S. nets or members. Milton hams had a test mobilization day on 112 Mc. as a part of the town's Defense Committee. F.B.

Traffic: W1JSM 508 BDU 345 AKS 251 LWH 243 EPE 205 JCK 185 (WLGV 33) IXL 151 AAR 138 KXU 89 FWQ 77 AAT 39 HWE 29 LNN 23 KH 14 GAG 12 SS 6 LZW 5 EVJ 2 EMG 101 JYJ 89 MEU 83. 112 Mc. A.A.R.S. Net: W1AAR 16 BHL 3 EYR 69 KAL 4 LEM 14 LOV 13 LSR 7 MIF 4 MON 29 MQH 16 QD 51. (Sept.-Oct.) W1EPE 231 LWH 164 JYJ 138 MEU 81 EMG 140 LSA 36 LGH 20 WI 6 LBH 3.)

WESTERN MASSACHUSETTS — SCM, William J. Barrett, W1JAH — BIV leads us this month, the result of plenty of hours devoted to A.A.R.S. schedules. Nice going, Pres. IOR says he would like a few traffic schedules. LJJ turns in a nice score to wind up his first year as O.R.S. KZS joined the A.A.R.S. and is also in line for O.R.S. That's the spirit, Ernie. LUA is new S.N.C. 4 for West. Mass. A.A.R.S. BVR had visits from BKG, AZW and JAH. Perce keeps plenty busy these days with his duties as our A.R.R.L. Division Director and Radio Aide for the first Corps Area. DCH is keeping schedules in the A.A.R.S. and P.T.S. BKG reports that his brother is now MWE, and is running flea power from a vibrapack. FOI is spending most of his time ragchewing. KRX is rebuilding. GZL is copying WIAW code practice on a mill. Les is back on 1.75 and 3.9 Mc. for the winter. BNL says the old key hand is itching to get swinging again after the summer layoff. KVN enlisted in Signal Corps and is now at Fort Monmouth, N. J. IIP joined the A.A.R.S. MJP reports and is interested in joining an organized net. And now, fellows, this next is addressed especially to hams in Springfield and Holyoke. The West. Mass. A.A.R.S. Net, the only organized net now active in this end of the state, needs members in both towns. How about some of you 3.5-Mc. c.w. men joining us. Code speed is secondary. Regular attendance at drill will take care of that angle, so how about it? EOB is taking a year of active service with the N.C.R. at Boston Navy Yard.

Traffic: W1BIV 343 (WLGN 154) IOR 135 (WLGJ 12) JAH 126 (WLGH 9) LJJ 80 KZS 70 LUA 61 HNE 47 BVR 9 (WLG 134) DCH 9 BKG 53.

NEW HAMPSHIRE — SCM, Mrs. Dorothy W. Evans, W1FTJ — Glad to see so many of the New Hampshire boys getting their Code Proficiency Certificates from A.R.R.L. We heartily approve of this and earnestly suggest that each and every one try for a certificate. JBA is a newly commissioned Ensign in the U.S.N.R. and is on active duty on the U.S.S. *Tennessee*. This now makes a total of six of the Concord boys on active duty in the Navy. JNC is building a new exciter unit and intends to get on 3.5- and 7-Mc. c.w. CME/4 is operating from Florida, this winter, and can be heard on the high end of 3.5-Mc. c.w. LCD has been rebuilding his final and is on 1.75 Mc. MWI and MUW, new YL's in New Hampshire, can be found on 3.5-Mc. c.w. KPL is sporting an RME69. He also has a new 14-Mc. vertical. FX has built a new frequency standard. LIN is rebuilding with a pair of HK24's in the final. EAL is rebuilding his entire rig. BFT/DMD worked 43 states during the Sweepstakes with 15 watts input. The boys at Wolfeboro are doing FB work on 28 Mc. MXL has moved to Laconia. IVU finally made an FM receiver work. The boys are still working on the transmitter at LVK. LVG has joined the Army and is located at the Savannah Air Base, Savannah, Georgia. AOQ is new in Concord. FTJ worked 27 different YL's in 18 states in the recent Y.L.R.L. QSO Party.



Traffic: WIKIN 236 JDP 102 GEY 116 MLO 90 GMM 77 BFT 59 HXJ 58 JKH 56 MMG 55 MOF/BFA 43 IP 30 HFO 5.

RHODE ISLAND—SCM, Clayton C. Gordon, W1HRC—The N.A.A.R.O. has its application in for a station license and has applied for affiliation with A.R.R.L. KYK has fully recovered and has resumed his operating schedules. His new rig is a 6F6 e.c.o. and 807 with 70 watts on 3.5 and 7 Mc. KCS has a T20 on 7 Mc. KOG has a 7-Mc. antenna up. MJL is running 160 watts to an 812 on 3.5 and 7 Mc., has a new bug, and has joined the A.A.R.S. LWA is on 3.5, 7 and 14 Mc. with 90 watts. QR received his 35 w.p.m. Proficiency Certificate from Hq. He has a schedule with W4HBV, Saturday afternoons, at 4 p.m., on 7150 kc. DDD has been having trouble trying to work a Collins Pi into EO1 cable. JP still leads the field in R.L. Ultra-High Frequency activity. HJB says lots of 28-Mc. stuff is coming in again. JAR is active on 28 Mc.

Traffic: W1LWA 109 LDL 158 HRC 12 QR 2.

VERMONT—SCM, Clifton G. Parker, W1KJG—GAN is busy building a new compact rack-and-panel transmitter for 3.9-, 14- and 28-Mc. 'phone to be installed in living quarters. KVV has joined the Vt. National Guard as a radio operator. FSV is busy with S.R.A. duties. KOO has joined Hq. Co., 172nd Inf., Vt. National Guard. CGV is busy with duties as foreman on N.Y.A. project. MMV reports a new jr. operator at his house and all doing fine. MMU has invested in a new skywire and receiver. BZS has terminated his position at WCAX and goes to Portland, Maine, as operator at WGAN. Jim, GAE, has foregone "single blessedness" and now resides at 24 Russell St., Burlington. Congratulations! KDB has returned from Erie, Pa. and is now living at Mallett's Bay, with plans to be on 7 Mc. shortly. HLB is rebuilding his rig for 28-Mc. 'phone. The Burlington Radio Club is holding regular meetings and was invited to an illustrated lecture on Ultra-High Frequency Antennas by MFL, Research Fellow in Radio Engineering, of the University of Vermont. MFL spent the summer at G.E. experimenting with television antennas, and is now engaged in the same type of work at U.V.M. JVS has completed new 28-Mc. 'phone rig with a final input of 300 watts. KXY has new signal shifter and is busy on traffic nets. JRU has moved to Morrisville, Vt., and erected a new 1.75-Mc. half-wave antenna. LDM has his rig at JVT's for changes. KTB and KJG visited at KXY's. Recent developments, National Guard, etc., are making a large number of changes in our active amateurs. FPS is now working for the F.C.C. at Boothbay Harbor, Maine. KTB anticipates a change shortly. KOO, KVV and CUN expect to leave Vermont with the National Guard shortly, and KOO is very anxious to arrange 7-Mc. c.w. skeds with Vermont stations before he goes. Anyone who can assist in this, please advise him or your S.C.M. immediately. TJ has returned to the air after long absence, and is heard on 3.9 Mc. 'phone. KXY has acquired a new receiver. ND has new skywire, and continues to drop in on amateurs in his work about the Section.

Traffic: W1KTB 188 KXY 97 KJG 92 KJR 165 MLJ 24 FSV 124 MJU 30.

#### HUDSON DIVISION

EASTERN NEW YORK—SCM, Robert E. Haight, W2LU—MIY, E.N.Y. A.A.R.S., offers to handle monthly reports to the S.C.M. from O.R.S. EZO of Mt. Vernon comes to the aid of the E.N.Y. Section with a fine traffic total. NIY is a new O.R.S. in E.N.Y. He comes to us from W.N.Y. Welcome, Andy. JRG is heard regularly on 7095.24 kcs. SZ participated in the SS using a new National 600-watt rig. LLU reports 654 QSO's total for this year, and enjoyed the SS contest. ACB, local E.C., moved to a new QTH. HCV is welcomed as new O.P.S. in the Section; he also joined the A.E.C. MIY, R.M., reports that due to lack of cooperation and interest the E.N.Y. O.R.S. Net must be disbanded. What say, boys? Don't let our Section be without a net. If every O.R.S. lived up to their appointment, we could not fail. Contact W2MIY and give her your support, even if it can only be for 15 minutes a week. Your S.C.M. extends to all hands his best wishes for a Merry Christmas and a Happy and Prosperous New Year.

Traffic: W2MIY 554 EZO 112 NIY-LU 32 JRG 27 SZ 17.

NEW YORK CITY AND LONG ISLAND—SCM, E. L. Baumach, W2AZV—FAQ and 3MA/2 are now O.R.S. NJB is a new station in Babylon. EC did some nice emer-

gency work by helping to get two Minnesota stations together to handle traffic for a snow-bound town without communication. Although PF will be on active duty at the War Dept. Message Center in Washington, D. C., he will be home on week-ends to pound brass. DBQ is now C.A. Radio Aide for the A.A.R.S. BWC has the call WLNS for the S.N.Y. A.A.R.S. Net. MRL is out for O.R.S. appointment. HYJ worked 125 miles on 112 Mc. during the Sweepstakes. KTA finds the new high end of the 1.75-Mc. band FB for DX contacts. HAE works 1.75-Mc. c.w. with high power. ETD has a pair of used RK20's for sale now that he is using the 41 oscillator and 6A6 final job on 3.9-Mc. 'phone. FF is operating on 3.5 and 14 Mc., using low power for the present. VG spends all of his time working on his 50-watt modulator and speech amplifier. LYC got his Class A ticket but is staying on c.w. Although working nights, AEU manages to handle traffic. IHT is getting on the air from Yale. AXZ is the one and only operator at SC, and is putting in plenty of operating time. JN enjoys his operating on 7 Mc. NAZ enjoyed the Y.L.R.L. contest. YL's who are not members may schedule NAZ on Tuesdays at 10 p.m., on 7220 kc., for all dope. FAQ is acting N.C.S. for the S.N.Y. 7-Mc. A.A.R.S. Net. All LYH needs now is a job since he got his First Class Commercial 'Phone and Second Class Commercial Telegraph license. MRV has a neat layout for operating and handling traffic. KVV has his signal shifter wired so that he can work one hundred percent break-in. LR is doing a tour of active duty at N.C.R. Headquarters. IXZ discovered that one of his fellow workers was NGB. GIC and HYJ are completely emergency-powered A.E.C. stations. AYJ is getting things in shape at his new QTH. LZR used low power in the SS, but managed to run up a high score. HGO is working hard for his Code Proficiency endorsements. On election night JCS and a number of the gang paraded through the crowds on 42nd St., N.Y.C. They called CQ and managed to find a number of W1's, W2's, W4's, W9, and a Navy on in the crowd. EYS is looking for a schedule at 6 a.m., on 7 Mc. The following are on the Section Net on 3710 kc.: DBQ, DW, GDF, LBI, LGK, LR, MT, NAZ, CTN, GIC, and ITX. Stations in the Section are invited to join the net any night at 8:00 p.m. LR is the control station.

Traffic: W2SC 525 LZR 421 AV 343 KI 217 FAQ 211 DBQ 139 LRV 129 MRV 127 BWC 114 HYJ 104 EC-MT 71 NAZ 66 AZV 50 LGK 41 DW 34 JIN 32 PF 28 JAU 23 AA 12 BYL 11 LBI-ADW 10 CIT-CET 9 AEU 8 FLD 7 AYJ 6 DOG 5 IXZ 5 LID 5 KYV-LYC 4 HGO-CHK 3 VG-DLR 2 AZM-BGO 1 W3MA/2 187 HQL (WLNR 10). Special A.A.R.S.: W2FAQ 5. (Sept.-Oct.: W2AV 195.)

NORTHERN NEW JERSEY—SCM, Edward Gursky, Jr., W2LMN—R.M.'s: 2BZJ, 2CGG, 2HXI, 2IYQ, P.A.M.: 2HNP. Section Net frequency: 3630 kc. New R.M. appointments: HXI and IYQ. Many thanks to Fred Read for the fine job he did as Acting S.C.M. for the past two months. LMN is the new S.C.M. Address all correspondence, news and reports to 367 Van Winkle Ave., Hawthorne, N. J. HXI is taking over R.M. job for the N.N.J. 3.5-Mc. Net. IYQ is R.M. of the new 7-Mc. Section Net, and would like to hear from all fellows who are interested. The net frequency and operating time will be decided later, to suit the convenience of the members. NCY is on the air using a signal shifter and a HQ-120X. MLW has W.A.S. on 7 Mc. BZJ resigned his trunk line appointment. He is now NC4 of the N.J. 3.5-Mc. A.A.R.S. Net with the special Army call W2NF, and was also appointed Executive Officer in his N.C.R. Unit. Congrats and best of luck, Walt. NIG pulled a fast one on his ham friends. He didn't let them know he was interested in ham radio until he had his license. NJE is ex-3GUS and is in Plainfield. 3GNU is working portable at the N.Y.A. Center in Verona. JV is working with a new 28-Mc. beam. MRX is building a speech unit, and expects to be on 28 Mc. 'phone shortly. HXI has been trying hard to make the B.P.L., and finally succeeded. FSQ, GBY, HZR and EKU are the nucleus of the "Milkman's Net" which meets on 1823 kc. every Tuesday morning. GYY is back on 1.75-Mc. 'phone. IVP joined the N.C.R. and is at the Naval Radio School in Noroton, Conn. MRK got a great kick out of his first SS. CMY, who swore he would never use e.c.o., finally broke down and built one. MTZ is the Irvington High School station and uses about 15 watts. MRJ has a new 75-watt rig using pp 6L6's. JKH in Roselle is new O.P.S.

Traffic: W2HXI 799 CGG 365 MKW 164 LMN 98 (WLNX 24) BZJ 72 LXI 39 MAX 14 MRX-KSR 10 MRJ 9 CJX-IZV 4 MRK 1.

# ELECTRIC POWER ANYWHERE

with  
**BLUE  
DIAMOND  
POWER  
PLANTS**

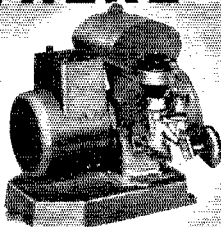

Pincor Hipower Blue Diamond power plants provide a PORTABLE electric generator of high output ratings. Available in various models to meet any requirements: 450 watts 110 volts, 60 cycles A.C. PLUS . . . 6, 12, or 32 volts D.C. in various wattages; for charging batteries; for direct operation of electric lights or appliances. Sturdy, light weight, easily portable for use anywhere. Send for complete information today.

**PIONEER GEN-E-MOTOR CORP.**

Dept. R-6, 466 W. SUPERIOR ST., Chicago, Ill.  
Export Address: 25 WARREN ST., N. Y., N. Y.  
Cable: SIMONTRICE, New York

**PINCOR Products**  
FOR AIRCRAFT • SOUND • POWER SUPPLY USES

## The "Variarm-150"

(Continued from page 11)

the band coverage over the entire main dial scale, actually 3500 kc. to 3650 kc. or 7000 kc. to 7300 kc. from 100 to 0 on this particular scale. *The grid circuit of the oscillator tunes from 3500 kc. to 3650 kc. at all times.* The coil is not plug-in, and there are no switches or movable taps in the grid circuit.

For all practical purposes, the warm-up period of this unit is the same as that of the average communications receiver, although the extent of frequency shift is not nearly as great. There are many reasons for this condition, probably the most important contributing factor being the inherent simplicity of a frequency control circuit which is effectively isolated from all external sources of heat radiation. In this case, the heater and shell of the 6K7 are quite capable of warming the interior of the comparatively small and air-tight shield box to its operating temperature (enough higher than room temperature to be fairly effective in damping sudden external changes caused by drafts) in short order, and the use of an air-wound grid coil and low-drift padding condensers are all that is necessary from that point on.

The parts cost of a complete variable frequency exciter, line-powered and comparable in output with this one, will not exceed \$18.00 with all new parts. A word of caution — when preparing to build any piece of frequency control or measuring equipment, it is best to keep religiously away from the proverbial junk box until the frequency control circuit proper is completed, then wade in! In an e.c.o. this means the tube and grid circuit components in particular.

### Application

It is common sense that an amateur should want to have his signal heard frequently on one or two spot frequencies, although he may use these spots only as a starting point for contacts on schedule. If we accept this theory as reasonable, it would be a misnomer to call our gadget a "crystal replacement something-or-other." What we want is something to take the place of the dozens of crystals which we *don't* have.

It would be impractical in the extreme to attempt to cover all the problems which may arise in applying this device to existing transmitters. In general, it may be said that the output can be used to supply excitation to any low-power stage whose plate circuit tunes to either 80, 40 or 20 meters, and that the driven stage should be operated as a frequency doubler wherever practicable.

For example, we have a triode crystal oscillator with a 40-meter plate tank. To prevent self oscillation in the triode stage, we will have to use the 80-meter coils in our amplifier and output coupler. But suppose our triode uses an r.f. choke across the crystal; no grid leak. A 15,000- or 20,000-ohm resistor should be wired between the choke and ground, and the output from the triode as a driven doubler will then be about equal to that

★ ★ ★ ★ ★ ★ ★

## BE PREPARED

FOR THE

NAVY, ARMY OR  
COMMERCIAL FIELD

For over a quarter of a century the Candler System has trained men at home with their simple, practical system. You, too, can learn code the Candler way, easily and quickly. Let Candler give you that "Coördinative Knack" necessary to speed, skill and copying behind.

The Communications Reserve of the U. S. Navy is enlisting 5400 expert radio operators. You can qualify in half the usual time for your amateur or commercial license and a good rating by taking Candler Training NOW!

WRITE TODAY

For the New Book of Facts. It's FREE! It tells you how Candler trained world-famous speed champions. Get Candler's inside tips — drop a postcard now to

**CANDLER  
SYSTEM CO.**

DEPT. Q-1

ASHEVILLE, N. C., U. S. A.

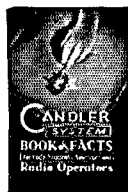

★ ★ ★ ★ ★ ★ ★



# Here's the Winning Combination—

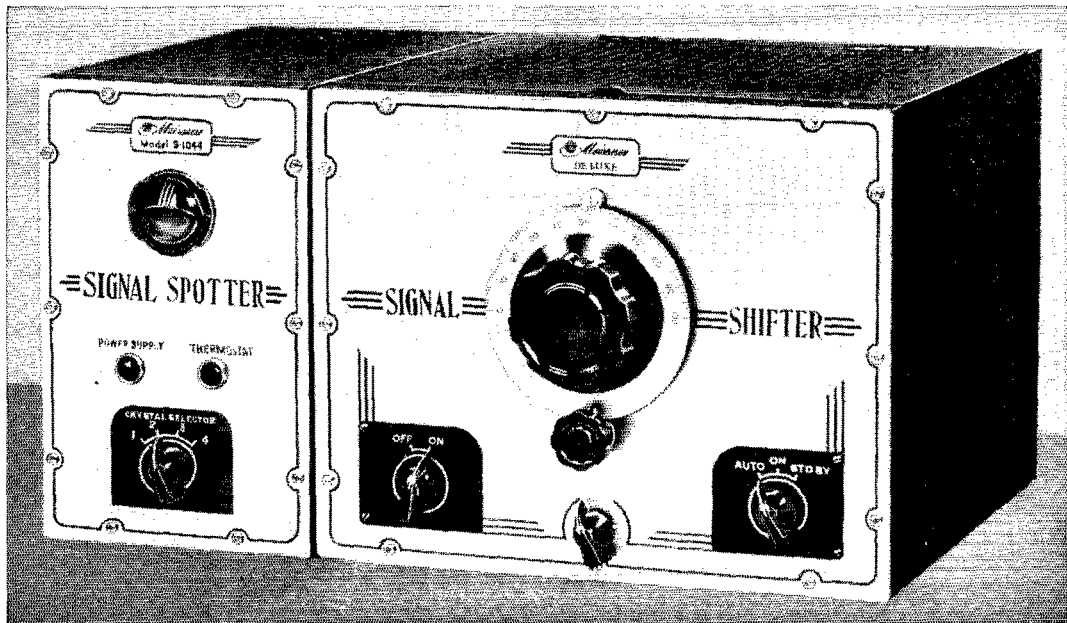

## Four X'tals and a Precision E-C-O!

The New Meissner

### SIGNAL SPOTTER

- ★ Four "Spot-Frequency" Crystals
- ★ Front Panel Crystal Switching
- ★ Pre-Tuned Tank Circuits
- ★ Provision for Crystal Oven and Thermostat Temperature Control

In response to unprecedented demand, we present a companion unit to the popular Meissner Signal Shifter—the Signal Spotter. Basically, the Signal Spotter is a crystal-controlled oscillator, operating from the voltage-regulated power supply of the Signal Shifter. Four crystals may be used and the desired "spot frequency" is instantly selected by a front panel control knob. A separate control on the Signal Shifter panel enables the operator to switch to either ECO or Crystal excitation. The four crystals can be placed on any one amateur band or may be divided over any two bands. Provision is made for installation of a Meissner Crystal Oven, designed to accurately control temperature of the crystals. Independent, pre-tuned tank circuits; designed for operation with any type amateur crystal.

SIGNAL SPOTTER, Complete with tubes and coils  
 No. 9-1044 Amateur Net . . . . . \$22.45

The Improved Meissner

### SIGNAL SHIFTER

- ★ Positive ECO Stability-Flexibility
- ★ Oscillator Keying for Break-In
- ★ Instant Switching from Crystal to ECO
- ★ Complete Voltage Regulation and Temperature Compensation

The popular Meissner Signal Shifter, universally used and accepted as the outstanding manufactured ECO design, now features oscillator keying for perfect "break-in" operation. The Signal Shifter is so well known that it is hardly necessary to repeat the story about its many points of merit. Positive PROOF of dependability, accuracy, stability and flexibility is clearly shown by the widespread acceptance of the precision-built Signal Shifter—throughout the amateur fraternity! The Signal Shifter—Signal Spotter Combination provides a COMPLETE SYSTEM for positive frequency control and selection: the Signal Shifter for full-band flexibility—the Signal Spotter for extreme band-edge operation, network frequencies, etc. This team deserves a place in every modern amateur station.

SIGNAL SHIFTER, Complete with tubes  
 No. 9-1028 Amateur Net . . . . . \$47.50

Write Today for Complete Amateur Catalog!

ADDRESS DEPT. Q-1

MT. CARMEL  
ILLINOIS

**HARVEY** Has the  
*Best Selling Quality  
 Communications  
 Receivers!*



**THE NEW 1941 SX-28**

Double check all these new Hallicrafters Features in the 1941 SX-28: 15 tubes—6 bands—Frequency range 550 kc. to 43 mc.—Two stages preselection—Electrical bandspread on ALL BANDS including international short wave band—Calibrated bandspread inertia controlled—Beat frequency oscillator—AF gain—RF gain—Micrometer scale tuning inertia controlled—Crystal phasing—Send-receive switch—80, 40, 20, 10 meter amateur bands calibrated—Band pass audio filter—Push-pull high fidelity, audio output—Phone jack—Dimensions 20½" x 10" x 14¾". Model SX-28 with crystal and tubes. \$159.50.

W21JL  
 W2LJA  
 W2KWY  
 CABLE  
 ADDRESS  
 "HARADIO"

**Time Payments  
 and  
 Liberal Trades  
 GET  
 HARVEY'S TERMS**

OUR *Best* VALUE IS OUR RECORD OF LOYAL SERVICE

**HARVEY**  
*Radio Company of New York*

103 WEST 43rd STREET • NEW YORK, N. Y.

the hallicrafters inc.  
 USED BY 33 GOVERNMENTS  
 SOLD IN 89 COUNTRIES

obtained with 40-meter crystal excitation, and the stage should operate satisfactorily either way.

Another example: how do we proceed in the case of a Tri-tet used as a doubler to 20 meters? Our grid bias is okay this time, but we will have to change to 40-meter coils for the 25L6GT and coupler. Also, it is good policy to short out the cathode coil, although this is not necessary in every case.

It is entirely practical to work 80-meter c.w., assuming reasonable care in neutralizing the entire transmitter; 3500 to 3650 kc. is all the coverage we have on that band. If the existing crystal stage has to be neutralized, the jumper in the output coupler plug can be utilized to make the connection at the grid of the tube. The neutralizing lead will be floating when the crystal is in use. The general rule concerning the use of a frequency doubler (the output section of an e.c.o. or the stage which follows any self-controlled oscillator) as a guarantee against r.f. feedback is a very good rule to follow, but the method of shielding used in this particular instance seems to be effective enough to permit operation on the fundamental frequency.

We are now agreed that this has been a reasonably successful attempt to produce something in the way of a practical and really economical means of frequency change for use with normally crystal-controlled transmitters. Whatever degree of success may have attended this attempt has been due to a fortunate combination of ideas which have been developed by others. In order to effect this combination, one or two new structural tricks have been brought about, and these may in turn be applied to the problems of others, and so it goes. One idea can often make a complete piece of radio gear possible, and, because that is so, every amateur has a chance to contribute indirectly to the development of the highly specialized equipment required by the important communications services. True, they have their own great laboratories, but we have thousands of small ones in basements and kitchen corners.

I believe that those of us who never seem to get around to improving our operating proficiency by code practice and traffic handling still have a chance to help in times such as these, but it must be remembered that most practical ideas are brought out in the process of actually planning, and rebuilding. For that reason, if for no other, let's keep going as we have done in the past, continually improving our equipment and telling others what we learn as we go along.

**Correspondence Dept.**

*(Continued from page 45)*

new draft, just put this letter in print to show them. . .

I will conclude with this bit of advice to the Young Squirts going into military service. Don't be afraid to let the executive officers know that you are a ham or serviceman. If you know your work and really love it, you will not have a bit of trouble making good. And you will have the pleasure of working at the job that all of us hams are designed for — radio.

— F. A. Lanning, RM8C U, S. N., W8LGR

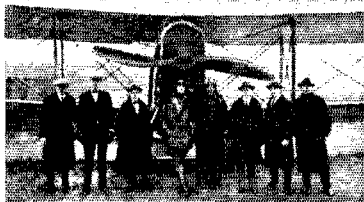

**AIRWAY RADIO** was in the experimental stage when this picture was taken of radio engineers and post office officials along with Captain Jack Knight of United (in center with short leather coat).

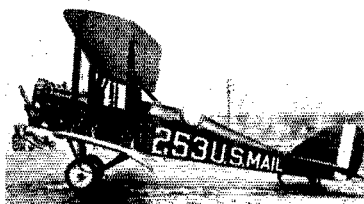

**BUILT FOR WAR**, this DeHaviland plane became a mail carrier on the first coast-to-coast airway in 1920. Note open cockpit and ancient Model-T touring car in background.

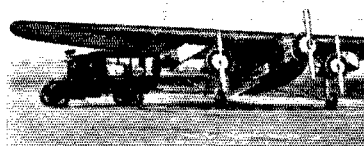

**"TIN GOOSE"** was the nickname given the tri-motored Ford when these planes were introduced to the coast-to-coast airway. Note how the mail compartment in the wing was lowered for loading.

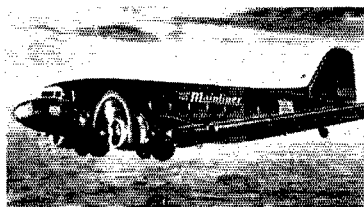

**4 TIMES FASTER** than 1920 is this huge three-mile-a-minute "Mainliner" which carries air mail cross-continent in 16 hours. Burgess Batteries assure positive operation of emergency radio equipment under all circumstances.



## BURGESS SALUTES UNITED ON 20th ANNIVERSARY OF TRANSCONTINENTAL AIRMAIL

Coast-to-coast airmail service recently celebrated its 20th birthday, and of course, United Air Lines was "all dressed up" for the occasion. Above is Capt. Jack Knight veteran United pilot, who made the first night airmail flight in history. The Burgess Battery Company is proud of its opportunity to serve airmail development, having supplied Burgess Radio Batteries as exclusive standard equipment for several years on all United Air Lines planes. Below, a United maintenance man installs a Burgess Battery in the auxiliary radio equipment—the "safety" equipment which *must operate immediately and unfailingly* if the regular equipment should fail.



**BURGESS BATTERY COMPANY, FREEPORT, ILLINOIS**

## Why Not Parallel Feed?

(Continued from page 31)

d.c. supply voltage from the sum of voltages which cause high breakdown peaks across tuning and neutralizing condensers. The first is to connect an r.f. by-pass condenser between the tuning condenser rotor and chassis, thus eliminating the d.c. supply voltage from the arc when the tuning condenser breaks down. Such a blocking condenser, however, will not *prevent* the arcing, or reduce the voltage causing it.

The second, which allows the use of a smaller tuning condenser, is described in detail in *QST* for December, 1938.<sup>1</sup> This circuit actually removes supply voltage from across the tuning condensers, but leaves room for improvement in two respects. It is necessary to insulate the condenser frame and rotor shaft from chassis and operating controls, and the entire tuning condenser — frame, rotor and stator — is at high d.c. voltage and therefore a safety hazard. The tuning coil and neutralizing condensers also are danger points. No remedy is provided for the d.c. voltage which appears across the neutralizing condensers.

The last step in reducing condenser voltage was taken by B. P. Hansen, in an article in March, 1940, *QST*<sup>2</sup> on removing d.c. voltage from across neutralizing condensers. The method used, while effective, requires special high-voltage blocking condensers, supported well above the chassis, along with suitable d.c. bleeding resistors. Thus two parts were added to the high-voltage circuits, again increasing operating hazards.

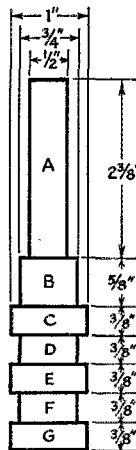
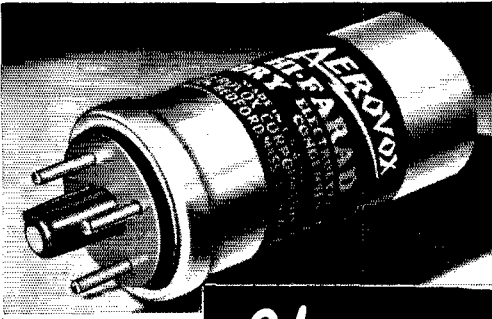

Fig. 3. — Experimental wooden-form choke. The form was turned from well-seasoned maple. Coils were wound with No. 30 d.s.c. wire, with the following number of turns on each section: A, 160 turns, starting 1/4-inch from top; B, 40 turns; C, 20 turns; D, 26 turns; E, 20 turns; F, 26 turns; G, 20 turns.

With parallel plate and grid feed, the tank condensers, tank coils, and neutralizing condensers are operated with all portions at ground d.c. potential. This provides safety for the lives of those coming in contact with the tuned circuits or neutralizers, allows mounting the tank condensers directly on metal chassis and panels,

<sup>1</sup> Ferrill, "How Much Condenser Spacing?", *QST*, Dec., 1938.

<sup>2</sup> Hansen, "Neutralizing Economy," *QST*, March, 1940



Quick-change electrolytic capacitors. Fit standard octal socket.

Proper connections insured by octal keying.

Ultra-compact. Aluminum internal construction. Non-corrosive. Fully vented.

Single section 10-, 20-, 40 and 80 mfd., 450 v. D.C.W. Also in 10-10 and 20-20, 10-10-10, and 10-10X450+20 X25.

## Plug-in CAPACITORS

● Just the thing for "rigs" that must keep going. Handle like tubes — readily plugged in, removed, tested, replaced. Heretofore made special for U. S. Signal Corps, police and aircraft radio, but now standard items. ● Ask jobber for them. Ask for data — or write direct.



IN CANADA: AEROVOX CANADA Limited, Hamilton, Ont.

## Janette

### ROTARY CONVERTERS

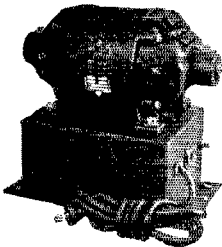

Janette Converters were the ORIGINAL machines designed and built especially for radio apparatus.

These machines progressed with the industry and have made operation that today economical, reliable, trouble-free.

such an outstanding record for economical, reliable, trouble-free operation that today Janette and quality products are synonymous.

**WARNING:** Janette converters are being imitated — be sure Janette is stamped on the name plate. Dynamotors, generators and motor-generators are also available.

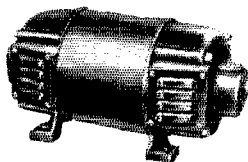

MAY WE SEND LITERATURE?

Janette Manufacturing Company

556-558 West Monroe Street Chicago, Ill. U.S.A.

# Astatic Crystal Products Give Grand Performance

Careful engineering, accuracy of manufacture, rigid laboratory control and years of experience, all contribute to the dependable service of Astatic Crystal Microphones, Pickups and Recording Heads. For assembly and replacement parts, efficient operation of Astatic products is a guaranteed certainty.

New catalogs, illustrating and describing Astatic's complete line, are now available at your Radio Jobber's or will be mailed direct upon request.



## ASTATIC

ASTATIC CRYSTAL PRODUCTS LICENSED UNDER  
BRUSH DEVELOPMENT CO. PATENTS

## ASTATIC MICROPHONE

IN CANADA, CANADIAN  
ASTATIC Ltd., TORONTO, ONT.

YOUNGSTOWN  
OHIO

Laboratory, Inc.

## LEARN RADIO • TELEVISION

60-page catalog on request. Oldest, largest and best equipped in New England. New classes now forming. Write for new catalog.

### MASS. RADIO SCHOOL

18 Boylston Street Boston, Massachusetts

## WANTED

Development Engineer on aircraft transmitters, variable frequency, approximately 100 megacycles, low power; U. S. citizens only; location Eastern U. S. State full particulars and experience. *Write:*

Box AIR, Advertising Department, QST  
West Hartford, Conn.

## LEARN CODE THE WAY YOU'LL USE IT—BY HEARING IT

### Type S - \$17.50

Sends from 4 to 60 words per minute. Higher speeds if desired. Complete with 10 rolls of double-perforated lesson tape of carefully selected and arranged matter for speediest results in learning code. Most compact and practical code teacher on market.

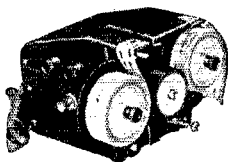

### Type J - \$12.50

Double-purpose instrument—code teacher and automatic sender. Sends from 6 to 70 words per minute. Built-in tape perforator. Cut your own code-practise tapes and message tapes. Complete with already cut practise tape and 5 rolls of blank tape. Repeats calls and messages indefinitely. Length of messages practically unlimited.

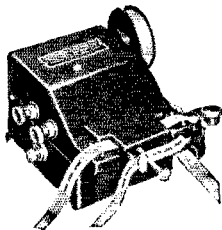

If your dealer can't supply you, write us

FULLY GUARANTEED

GARDINER-LEVERING CO. Haddon Heights, N. J., U. S. A.

## HELP WANTED

Licensed radio Amateur wanted. Permanent position with large established radio parts store in New York. One with pleasing personality and living in New York or very close to N.Y.C. Capable of selling "ham" receivers, transmitters, parts, tubes, etc. Write giving age, experience, and full details. Excellent opportunity for right man. *Write:* Box NY, c/o Advertising Dept. QST, West Hartford, Conn.

## WANTED...

Two quartz crystal grinders, experienced on accurate commercial work. State experience and all particulars first letter. Must be U. S. citizens.

### STANDARD PIEZO COMPANY

West Louthar and Cedar Streets

CARLISLE, PENNSYLVANIA

# GREETINGS and GOOD CHEER

## The Whole Year Thru!

To every ham and short wave enthusiast throughout the length and breadth of this wide world —

### A Merry Christmas and a Happy New Year!

*May joy and bliss be yours through this merriest and happiest of all holidays and this coming year 1941 prove the most glorious ever! And from the bottom of our hearts, too, in our own small way, we wish to thank each and every one of you for your valued patronage during the past year. As for 1941, we pledge ourselves to one resolution, i.e.*

**RESOLVED:** That our unbroken record for *Perfect SERVICE* will be maintained through 1941 — that our stock of goods will still be amongst the largest, our terms the easiest and our deliveries the fastest. Amen.

## GET A XMAS BONUS?

What better way to spend it than for a new ham receiver? That's one way of getting something you'll really enjoy! We have all the latest and finest receivers in stock!

## HALLICRAFTERS NATIONAL



RCA  
RME



## HOWARD HAMMARLUND

LATEST DESCRIPTIVE LITERATURE ON REQUEST

New York's Oldest "Ham" House

W2JEH — W2DXC — W2LFV — W2CLH

**SUN RADIO CO.**  
212 Fulton Street, Dept. PT New York  
Cable Address: SUNRADIO NEW YORK

and provides for use of the smallest parts throughout the transmitter circuits. Although more blocking condensers and r.f. chokes are required, the cost of the parts for the amplifier is considerably lower than that of the series-fed system.

It was stated in the first part of this article that the parallel-fed r.f. amplifier is much safer than the one employing series feed. This fact can be better understood when the high-potential parts of the two amplifier arrangements are compared. The series feed transmitter has plate condenser stators, plate tank coil, and neutralizing condensers at d.c. plate voltage above ground. The grid tuning condenser stators and grid coil are exposed parts above ground by a grid bias voltage ranging from 300 to 800 volts.

The only exposed parts of the parallel-fed am-

*(Continued on page 88)*

## Keying Monitors

*(Continued from page 17)*

the signal in the headphones be too strong, it may be reduced by connecting successively smaller capacities in series with the coupling line to the phones until the strength is reduced to a satisfactory level. A resistance in series with the line will accomplish the same result, and is probably preferable since its attenuation is more constant with frequency. If connection of the monitor to the headphones causes a.c. hum, the power plug for the receiver supply should be reversed.

If the keyed stage in the transmitter is operating at a plate voltage less than 600 or 700, the audio oscillator may be keyed in parallel with the transmitter, providing the same type of keying circuit is used in both cases. In the circuit diagram of Fig. 1, center-tap or cathode keying is shown. Therefore, if a low-power stage of the transmitter is keyed in the center-tap or cathode, it is merely necessary to connect the keying terminals of the oscillator to the key of the transmitter, connecting the oscillator chassis terminal to the grounded side of the key. When a high-power stage is keyed, a double-pole relay with sufficient insulation should be used to key the transmitter and the monitoring oscillator independently.

Blocked-grid keying may also be used. With this system, simply make a connection between the negative of the blocking-voltage source and the grid of the audio oscillator through a resistance of one-half megohm or so, and connect the two chassis together.

In circuits in which appreciable capacity is used across the key to eliminate key clicks, it may be found that keying the monitoring oscillator alone without the transmitter will show tails or a running together of characters. This will clear up when the transmitter is turned on causing a faster discharge of the capacities.

The i.f. oscillator of Fig. 2 also uses a 117L7GT and is similar in construction to the audio oscillator. A standard b.f.o. unit is used in the e.c.o. circuit.  $R_1$  and  $C_1$  form the supply filter, while  $R_4$  is a bleeder resistance to cut out chirps when the oscillator is keyed. The plate and screen resistors are of such a value that the cathode current is

# EARN AS MUCH AS \$160 A MONTH

**SHORTAGE OF TRAINED AIRLINE RADIOMEN BECOMES ACUTE...**

Mr. Amateur Operator, you have a most unusual opportunity before you. The demand for Midland-trained Airline Radio Operators and Maintenance Men continues to exceed the supply. As a qualified Midland Graduate, your employment opportunities will be exceptional, with ample opportunity to increase your earnings to \$160.00 a month and more. Starting wages are liberal, increases being on a regular basis; employment steady and pleasant. Most Airlines have benefit associations that take care of employees during illness. Amateur Radio Operators from every section of the United States have bettered their positions in life through Midland training.



Midland Graduate, Don Roush, ready to board a luxurious airliner for a steady, pleasant, Airline position. To the best of our knowledge, more radiomen have departed from the Kansas City Municipal Airport to take Airline positions, than from any other airport in the United States. And they have been Midland trained men.

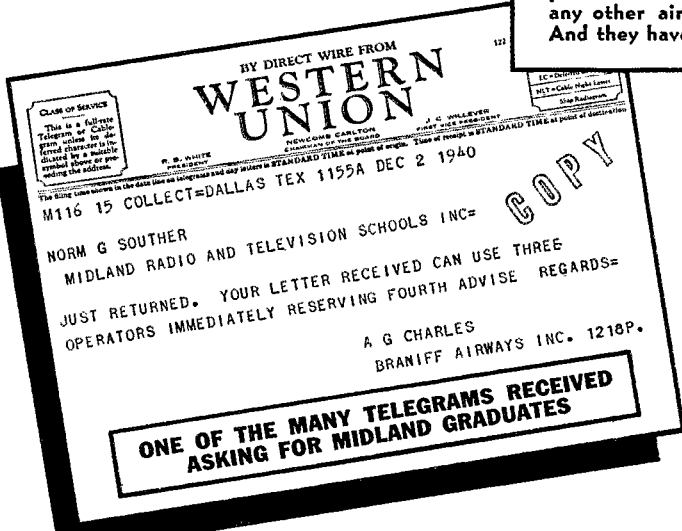

Midland Airline training is supervised by capable radio instructors, experienced operators released to us by major Airlines, and is directed by the Communications Officials of nine Airlines. Two training plans: combination Extension-Resident and straight Resident training. Classes are limited. If you are between the ages of 18 and 32, in normal health with no physical disability, write or wire Norm Souther, Vice President, at once for complete information on both operating and maintenance training. We welcome strict investigation.

**MIDLAND RADIO AND TELEVISION SCHOOLS, INC.**  
 DEPT. Q, POWER AND LIGHT BUILDING  
 KANSAS CITY, MISSOURI

*Operating Pleasure*

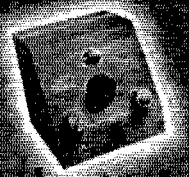

**Bliley Vari-X**  
VARIABLE CRYSTAL OSCILLATOR

**FREQUENCY FLEXIBILITY  
with CRYSTAL STABILITY**

The Bliley Vari-X, with VF2 wide range variable crystal units, provides V.F.O. flexibility with full crystal stability. Circular D2, obtainable from your Bliley Distributor, gives complete information.

**BLILEY Vari-X**  
VARIABLE CRYSTAL OSCILLATOR

**SICKLES COILS**  
ALL TYPES OF RF AND IF WINDINGS

Manufactured by  
**F. W. SICKLES COMPANY**  
300 Main Street Springfield, Mass.

**FULFILL YOUR AMBITION  
IN RADIO**

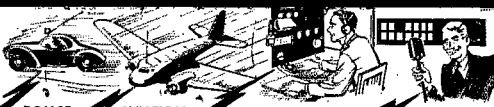

POLICE AVIATION RADIOTELEGRAPH BROADCAST

Train yourself at home for that technical radio job or promotion you want. Study under personal direction of A. R. Nilson — for twenty years expert author-instructor. Three up-to-the-minute, low-cost, home-study technical radio courses:

1. Essentials of Radio Communication;
2. Advanced Radiotelegraphy;
3. Broadcast Operating,

will help you succeed in your job or on license examinations.

FREE BOOKLET "What the Modern Radioman Must Know" describes these courses in detail. Send for your copy now!

**NILSON RADIO SCHOOL**  
51 East 42nd St., New York, N. Y.



reduced to less than one milliampere. A 25- $\mu$ fd. midget variable is used for fine adjustment of the beat note. The plate of the oscillator is coupled through a small capacity,  $C_3$ , to the i.f. amplifier of the receiver. In most cases, this will not require a direct connection to the amplifier, since bringing a lead in the vicinity of one of the i.f. grid leads will provide sufficient coupling for a strong signal. Trial will show the best location for the coupling wire.

The input of the receiver should be short-circuited or the plate supply removed from the r.f. stages of the receiver while making the tests so that blocking of the i.f. amplifier will not occur. The oscillator tuning is adjusted by the main control on the b.f.o. unit until the beat note is heard in the receiver and from then on any desired changes in pitch are made with the vernier condenser whose control is on the front of the chassis. Do not mistake one of the harmonics of the b.f.o. for the fundamental. The former will be of less stable character and will be tunable on the receiver while the latter will not be tunable. A terminal arrangement similar to that described previously for the audio oscillator is used in this unit and the i.f. oscillator may be keyed in the same manner. The same precautions should be observed in making connections to the key and to the 115-volt line.

*The Signal Monitor*

The signal monitor, whose circuit is shown in Fig. 3, is somewhat more complicated. A 6SA7 is used as the converter tube. A resistor is used in the input circuit of the converter so that no tuning of this circuit is required. A 2.5-mh. r.f. choke in the output circuit is tuned to the i.f. by means of a small mica trimmer condenser. An external power supply delivering 250 to 300 volts is required for operation of this unit. This may be taken from the receiver supply if desired. A VR150 is connected in the screen-supply circuit to provide a regulated voltage for the screen so that changes in line voltage with keying of the transmitter will not result in a false indication of signal characteristics because of frequency shift of the monitor.

The unit is built in a 5" by 4" by 3" steel case. The sockets for the 6SA7 and VR150 are sub-mounted on top, while the socket for the oscillator plug-in coil is mounted in an inverted position inside the case. The two variable condensers are mounted directly on the front panel. The left side of the case is fitted with a four-prong male plug for the power-supply connections. Pin jacks on either side are provided for input and output connections.

The idea behind this type of monitor is that a small signal from the transmitter output stage will be introduced at the input. The signal is converted to the i.f. of the receiver in the monitor and the i.f. signal fed into the i.f. amplifier of the receiver. The oscillator circuit is, therefore, designed to tune approximately 465 kc. higher than the transmitter signal. The tuning condensers have been proportioned so that the 3.5-Mc. band is spread out over the entire range of  $C_4$ . Signals in



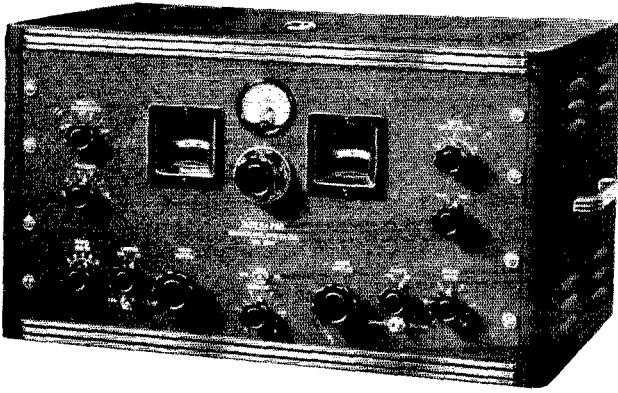

SAY, OM, YOU CAN FREEZE IF YOU WANT - BUT WHY PUT UP WITH FROZEN SIGS? I'M THE HAMMARLUND SUPER-PRO, AND IF BYRD CAN USE ME AT THE SOUTH POLE, I GUESS YOU CAN GET TOP RESULTS FROM ME TOO! WRITE BOB HENRY FOR A DEAL!

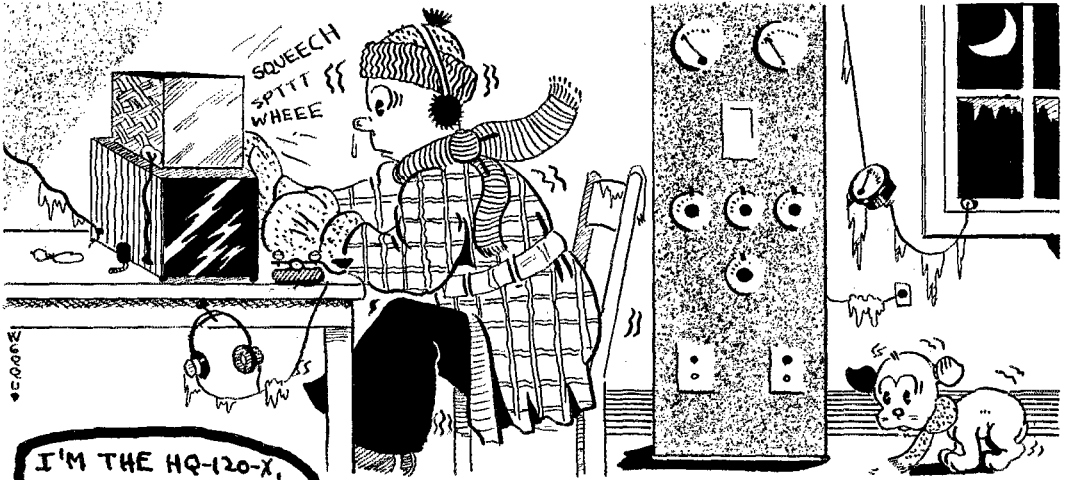

I'M THE HQ-120-X, OM, ES IF U WANT REAL SIGS IN THAT ICE-BOX SHACK OF URS, TAKE A TIP FROM THE BYRD EXPEDITION. SUPER-PRO ES I WILL DELIVER HOT OPERATING AT THE POLES OR ON THE EQUATOR. GET ONE OF US FOR A FREE TEN-DAY TRIAL FROM BOB HENRY!

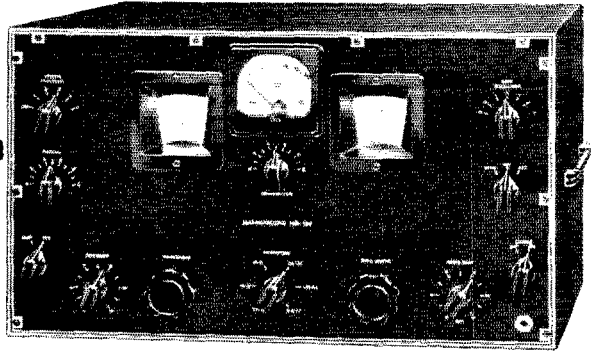

YOU CAN GET EITHER THE SUPER-PRO, AT \$279<sup>00</sup>, OR THE HQ-120-X, AT \$138<sup>00</sup>, ON MY PERSONALLY FINANCED EASY TERMS, WITH HIGH TRADE FOR YOUR PRESENT RECEIVER. I SELL EVERY COMMUNICATIONS RECEIVER MADE, AND HAVE THEM ALL RIGHT HERE FOR PROMPT SHIPMENT FOR YOUR FREE TRIAL. I WORK WITH YOU PERSONALLY TO HELP YOU GET EXACTLY WHAT YOU WANT. WRITE ME TODAY. 73, Bob Henry, WQARA BUTLER, MISSOURI

**G**reetings

To old friends and new, for  
 your loyal patronage, we ex-  
 tend our sincere thanks. May  
 your Christmas be joyful and  
 your New Year prosperous.

**TERMINAL  
 RADIO  
 CORP.**

68 WEST 45th STREET  
 AND  
 80 CORTLANDT STREET  
 NEW YORK CITY

the 7- and 14-Mc. bands may also be monitored, since the harmonics of the monitor oscillator will beat with 7- and 14-Mc. signals.

The value to be used for  $R_3$  will depend upon the voltage of the plate supply. Starting with the full 10,000 ohms, the resistance should be reduced until the regulator tube ignites. In putting the monitor into operation, a check may be made to make certain that the oscillator is functioning by tuning the receiver to the high-frequency end of the 3.5-Mc. band and listening for the signal from the monitor as  $C_5$  is tuned with  $C_4$  set at maximum capacity. The arrangement for picking up the signal from the transmitter will depend upon the location of the monitor in respect to the output stage of the transmitter and the power output of the latter. In most cases a few feet of wire within 3 to 5 feet of the final connected to the input terminal of the monitor will be sufficient. With high-power transmitters, less pickup may be required. If possible, keep the pick-up wire well spaced from exciter stages. Sufficient coupling to the i.f. amplifier will be obtained in most cases by simply running a wire from the output-terminal of the monitor to a spot inside the receiver near one of the i.f.-amplifier grid wires. Try to keep it away from the high-frequency circuits as much as possible. A connection should be made between the case of the signal monitor and the chassis of the receiver. As with the i.f. oscillator, the input to the receiver should be short-circuited to prevent blocking of the amplifier by the transmitter.

With the transmitter running and  $C_4$  set at about mid-scale, adjust  $C_5$  very carefully until the signal is heard in the receiver. In tuning over the range of the monitor various extraneous beats may be heard. These, however, are much weaker than the main beat between the signal and monitor fundamental oscillations. When the main beat has been located, it will be found that tuning of the receiver has no effect upon it. The length of the pick-up antenna and its position should then be adjusted for the desired signal strength. In monitoring a 7-Mc. signal, the beat with the second harmonic of the monitor oscillator will be found satisfactory. This beat will be found with  $C_5$  set at a slightly higher capacity than for a 3.5-Mc. crystal. At 14 Mc.,  $C_5$  should be set toward the low-capacity end of the scale so that the beat with the second harmonic of 7 Mc. will be obtained. The beat with the third harmonic of the monitor should also be satisfactory. At the higher frequencies, more care must be exercised in selecting the correct beat, although any beat which is not tunable in the receiver and which gives satisfactory signal strength may be used. The setting of  $C_5$  for each of the bands should be marked so that no time will be lost when changing from band to band. If it is desired to increase the bandspread, one of the plates may be removed from  $C_4$ , although this will make it necessary to shift  $C_5$  to cover the entire 3.5-Mc. band. If it is found that a rough beat is obtained from a transmitter which should produce a stable signal, it is an indication that the mixer is being overloaded and the size of the pick-up should be reduced.

## MEETS F.C.C. REQUIREMENTS FOR FREQUENCY CHECKING



### The Browning Type S-1 Frequency Meter

Custom built for your required frequencies. It furnishes precision measurement at a moderate cost. Designed especially for police, relay, emergency and other similar transmitters.

Stable electron coupled oscillators are employed which cover very narrow bands so that reading accuracy is

extremely high. These oscillators are accurately set in calibration by means of a built in 100 K.C. crystal oscillator which may in turn be checked against WWV or any standard broadcast station on a multiple of 100 K.C. No gears—no back lash error—visual indication of zero beat. Guaranteed to .01% or better. Send for descriptive circular.

ANY 1 or 2 Bands \$97.95 — 3 Bands \$122.50



WINCHESTER, MASS.

# RUBIES by HIPOWER

Hipower Rubies are super active, precision cut, low drift crystals, cut from the finest Brazilian quartz. They are without doubt one of the finest amateur crystal units available. With a guaranteed drift of less than 4 CY. per °C per MC. They are available with holder to all amateurs at "X" cut prices. 160-80-40 meter crystals...\$4.50 Special 20 meter crystal...\$7.25



The Hipower Crystal Company, one of America's oldest and largest manufacturers of precision crystal units, is able to offer the amateur and manufacturer attractive prices because of their large production and the exclusive Hipower grinding process. Numbered among Hipower's customers are:

U. S. Army and U. S. Navy  
National Broadcasting Co.  
Columbia Broadcasting System  
Mutual Broadcasting System  
United States Airlines

Such satisfied customers provide assurance that whatever the need may be, Hipower can supply it.

AVAILABLE AT YOUR PARTS DISTRIBUTOR

Manufacturers Write for Prices

## HIPOWER CRYSTAL COMPANY

Sales Division—205 W. Wacker Drive, Chicago, Ill.  
Factory—2035 Charleston Street, Chicago, Ill.

## STANCOR XMTR KITS

Stancor 10-P Transmitter is a compact, five-band rig, with 12 watts input on phone, 20 watts c.w. Total weight in cabinet only 14 lbs. Many outstanding features.

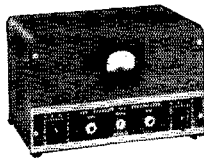

Model 10-P

Net to amateurs, \$21

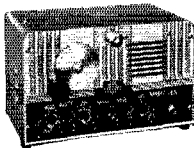

Model 112-T

Full data on these and other Stancor kits in new Hamannual. Get your copy.

The 112-T is a 10 to 15 watts input transceiver operating on the 2½ meter (112-116 mc.) band, using the new HY75 tube. In ultra-modern cabinet for ultra-modern operation on an ultra-modern band. Net to amateurs, \$18.25

## TIME PAY. FOR CONN. HAMS

## HOWARD RECEIVERS



Model 435

Howard's Progressive Series Plan, a direct factory conversion set-up, enables you to own the latest Howard equipment at all times, without loss or unfavorable trade-in deals. Get details from us.

Start on the Progressive Series with the 435. 6 tubes, electrical bandsread condenser, ceramic coil forms, BFO, "slide rule" dial, etc. This fine receiver is the basic unit of the Progressive Series, enabling you to step up later, as you will. Sells complete for only \$29.95, net.

## SAVE EXPRESS CHARGES

Hatry & Young is organized to give you quick, dependable service from three Connecticut stores. Save delay and express charges.

## HATRY & YOUNG

203 Ann St., Hartford, Connecticut  
1172 Chapel St., New Haven, Connecticut  
177 Cannon St., Bridgeport, Connecticut

## 3 CONVENIENT STORES

# CARDWELL Specials

for Portable Emergency Equipment

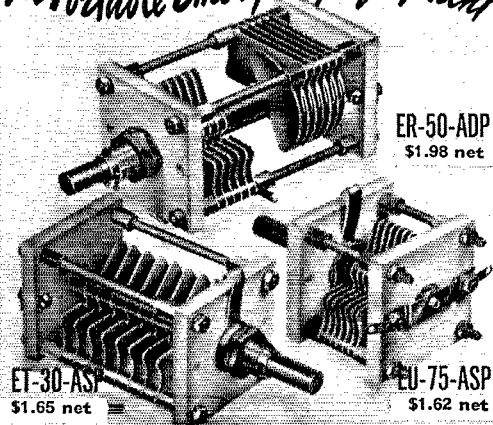

ET-30-ASP  
\$1.65 net

ER-50-ADP  
\$1.98 net

EU-75-ASP  
\$1.62 net

These three capacitors especially designed for Stancor 30-M Mobile H.F. Radiophone Transmitter

**THE ALLEN D. CARDWELL MANUFACTURING CORPORATION**

83 PROSPECT STREET  
BROOKLYN, NEW YORK

## USE THE BVL FOR MANY 100-WATT APPLICATIONS

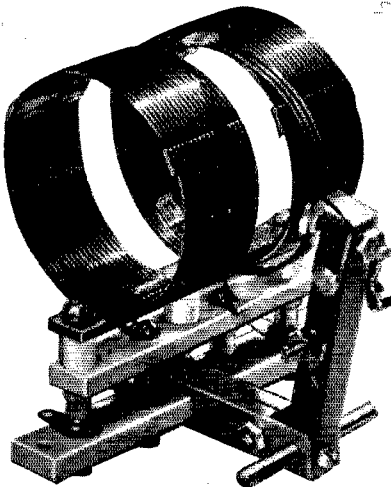

BECAUSE of its adaptability to such a wide variety of 100-watt applications, the B&W Type BVL Variable Link Assembly has attained exceptional popularity. BVL's are smaller and more compact. Designed for direct mounting on condenser and allowing front-of-panel control, they provide accurate, dependable control of most jobs up to the grid of the final stage. Six interchangeable coils, from 5 to 160 meters, are available. They're economical, too. Ask your jobber — or write for details.

**BARKER & WILLIAMSON, Ardmore, Pa.**

## Why Not Parallel Feed?

(Continued from page 80)

plifier at high d.c. voltage are the r.f. chokes and blocking condensers. To make this amplifier completely safe, a bakelite tube or small cylinder of other insulating material may be used to cover entirely each combination of plate r.f. choke and plate blocking condenser. The tube should be somewhat higher than the r.f. choke, so that the top choke terminal or blocking condenser could be touched only by special effort; a diameter of 3 inches is satisfactory. A closer fitting form would alter the characteristics of the choke, as would placing other parts too near the choke winding.

The grid r.f. choke and grid blocking condenser similarly are at d.c. grid bias potential, but these parts are so compact and well hidden in the layout that they are difficult to reach, and therefore are safe from operating accidents.

With the same efficiency, same operating voltage, same power and breakdown voltages, then, parallel feed has three major advantages: More compact construction, lower cost, and less chance for loss of human lives!

## Hints and Kinks

(Continued from page 48)

### GLASS-TUBING FEEDER SPREADER

IN TRYING to make some of the glass-tubing feeder spreaders described in *QST* for April, I found that the shape was rather difficult to form and also that it could not easily be annealed so as to reduce brittleness at the ends. I thought that a much simpler formation would be satisfactory and this seems to be the case.

The form, shown in Fig. 5, is very quickly made, is easily annealed and simple to install. A 6-inch spreader will be  $7\frac{1}{2}$  inches long, allowing  $\frac{3}{4}$  inch at each end as shown. The cost of these spreaders is a cent or two, depending upon what is paid for the tubing.

To make the spreader, the tube is heated in the gas flame of an ordinary kitchen-stove burner. When soft, it is laid on one of the hot prongs of the burner grid and then compressed as shown with a warm bit of metal. It should be pressed

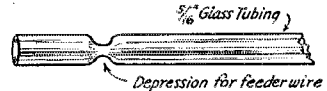

Fig. 5 — Simple glass-tubing feeder spreader made by W8QBW.

completely shut so that the tube will be sealed against the entrance of water. To anneal, the tubing is again heated and then withdrawn very slowly.

A 6-inch spreader made from 8-mm. tubing weighs exactly one-quarter as much as the usual porcelain spreader, so that four glass-tubing spreaders weigh no more than a single porcelain spreader. This is an advantage when a center-fed antenna is used with open-wire feeders, since the reduction in weight will eliminate much of the sag ordinarily experienced. The tubing itself is much stronger than porcelain. — Fred Sutter, W8QBW.

# THE ONE FOR '41!

## *The* **RADIO AMATEUR'S HANDBOOK**

constructional data, it offers a wide variety of tried and proven designs for all

is the all-purpose volume on radio. Text, data book, operating manual—it is all

these, and more. A comprehensive text on radio fundamentals and design, it is probably more used in radio schools and colleges than any other volume. An outstanding collection of practical

the latest equipment. As an operating manual, it provides information on station operation and procedure available from no comparable source.

*I* N THE 1941 edition, the basic arrangement and method of presentation initiated in the 1940 edition has been retained. Dozens of new pieces of equipment of all kinds were built for this edition. There are three new receivers, for example — a two-tube beginner's set, a three-tube superhet covering long waves as well as short, and a 7-tube super. New this year also are a converter and a beat oscillator unit. The transmitter construction chapter describes sixteen different units, including several simple and inexpensive transmitters for beginners, as well as band-switching exciters and amplifiers, a new e.c.o., and a number of antenna systems. Modulation, instruments and measurements, u.h.f. — all these sections are generously sprinkled with new gear not hitherto described. The u.h.f. section, in particular, has been considerably expanded, with a whole new chapter dealing with frequency modulation alone. Add these to all the features of earlier editions — and the 1941 HANDBOOK is now more than ever the "greatest dollar's worth in radio."

*\$1.00 postpaid in Continental U. S. A.*

*\$1.50 postpaid elsewhere*

*Buckram Bound \$2.50*

**AMERICAN RADIO RELAY LEAGUE WEST HARTFORD  
CONNECTICUT, U.S.A.**



To my friends

I wish all the joys  
of Christmas  
and the best of  
everything through-  
out the New Year.

73,  
Bill Harrison, W2AVA



**One "best" for the New Year**

that you can start enjoying right now is  
the pleasure of a new receiver —

improved selectivity — lower back-  
ground — easier tuning — noise sup-  
pression — advanced design — better  
all-around performance —

*you owe it to yourself!*

**You don't have to wait! —**

Harrison's low prices and liberal trade-in  
allowances make it easier on your pocket-  
book than you'd expect. Or you can pay it  
on Harrison's Easy Payment Plan at the  
lowest credit cost in the country!

**Let's Go!** — Mail the coupon *NOW!*  
No risk — try it for 10 days.  
If not *entirely* satisfied, return for  
cash refund. (If you have a set to  
trade in tell me all about it.)

Halicrafters — Hammarlund — National —  
Howard — RCA — RME — from the \$19.95  
Echophone Commercial to the \$279.00  
Super Pro —

**IT'S HARRISON FOR RECEIVERS!**

*\* Large Stock \* Fast Delivery \* Lowest Prices*

**BILL HARRISON**  
12 West Broadway, New York City

Please send me a \_\_\_\_\_

\_\_\_\_\_ receiver.

I enclose \$5.00 deposit (or full amount).

Collect the balance when delivered.

I want to pay \_\_\_\_\_ monthly payments of  
\$ \_\_\_\_\_ each.

Name \_\_\_\_\_

Address \_\_\_\_\_

AT . . .

**CAMERADIO**

*See and Hear*

The

**HAMMARLUND**

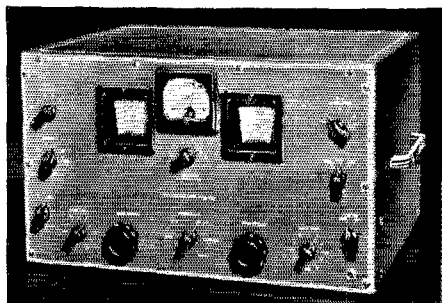

**HQ-120-X**

This ultra-modern 12-tube receiver covers a  
range of from 31 to .54 mc. (9.7 — 555 meters).  
It is designed to meet the most exacting demands  
of the amateur and short wave experimenter.  
This is no ordinary receiver, no redesigned  
broadcast set, it is especially engineered from  
start to finish. With the type construction em-  
ployed in the "HQ-120-X," the inclusion of  
the broadcast band in no way jeopardizes the  
efficiency of the receiver at higher frequencies.

**Amateur Net Price, \$138.00**

Speaker Cabinet to Match, \$3.90



*Available on our time-payment plan*

*You can depend on our usual prompt service*

**CAMERADIO  
COMPANY**

963 Liberty Ave.  
Pittsburgh, Pa.



1002 Main St.  
Wheeling, W. Va.

# Where to buy it

A directory of suppliers who carry in stock the products of these dependable manufacturers.

## THE NEW 1941 SUPER Skyrider

ALBANY, N. Y.	Uncle Dave's Radio Shack	356 Broadway
ATLANTA, GEORGIA	Radio Wire Television Inc.	265 Peachtree Street
BOSTON, MASS.	Radio Shack	167 Washington Street
BOSTON, MASS.	Radio Wire Television Inc.	110 Federal Street
BRIDGEPORT, CONN.	Hatry & Young, Inc.	177 Cannon Street
BRONX, N. Y.	Radio Wire Television Inc.	542 East Fordham Rd.
BUTLER, MISSOURI	Henry Radio Shop	211-215 N. Main Street
CHICAGO, ILL.	Allied Radio Corp.	833 W. Jackson Blvd.
CHICAGO, ILL.	Radio Wire Television Inc.	901-911 W. Jackson Blvd.
CINCINNATI, OHIO	United Radio, Inc.	1103 Vine Street
DETROIT, MICH.	Radio Specialties Co.	325 E. Jefferson Ave.
DETROIT, MICHIGAN	Radio Specialties Co.	11800 Woodward Ave.
HARTFORD, CONNECTICUT	Radio Inspection Service Company	227 Asylum Street
HOUSTON, TEXAS	R. C. & L. F. Hall	1021 Caroline Street
INDIANAPOLIS, INDIANA	Van Sickle Radio Supply Co.	34 West Ohio Street
JAMAICA, L. I.	Radio Wire Television Inc.	90-08 166th Street
KANSAS CITY, MO.	Burstein-Applebee Company	1012 McGee Street
NEW HAVEN, CONN.	Hatry & Young, Inc.	1172 Chapel Street
NEW YORK, N. Y.	Harrison Radio Co.	12 West Broadway
NEW YORK, N. Y.	Radio Wire Television Inc.	100 Sixth Ave.
NEWARK, N. J.	Radio Wire Television Inc.	24 Central Ave.
READING, PENN.	George D. Barbey Company	404 Walnut Street
SCRANTON, PENN.	Scranton Radio & Television Supply Co.	519-21 Mulberry Street
WASHINGTON, D. C.	Sun Radio & Service Supply Co.	938 F Street, N. W.

## TRIPLET INSTRUMENTS

ALBANY, N. Y.	Uncle Dave's Radio Shack	356 Broadway
ATLANTA, GEORGIA	Radio Wire Television Inc.	265 Peachtree Street
BOSTON, MASS.	Radio Shack	167 Washington Street
BOSTON, MASS.	Radio Wire Television Inc.	110 Federal Street
BRIDGEPORT, CONN.	Hatry & Young, Inc.	177 Cannon Street
BRONX, N. Y.	Radio Wire Television Inc.	542 East Fordham Rd.
BUTLER, MISSOURI	Henry Radio Shop	211-215 N. Main Street
CHICAGO, ILLINOIS	Allied Radio Corp.	833 W. Jackson Blvd.
CHICAGO, ILL.	Radio Wire Television Inc.	901-911 W. Jackson Blvd.
CINCINNATI, OHIO	United Radio, Inc.	1103 Vine Street
HARTFORD, CONN.	Hatry & Young, Inc.	203 Ann Street
JAMAICA, L. I.	Radio Wire Television Inc.	90-08 166th Street
LITTLE ROCK, ARKANSAS	Beem Radio Company	409 W. 3rd St.
MINNEAPOLIS, MINNESOTA	Lew Bonn Company	1124-26 Harmon Place
NEW HAVEN, CONN.	Hatry & Young, Inc.	1172 Chapel Street
NEW YORK, N. Y.	Radio Wire Television Inc.	100 Sixth Avenue
NEWARK, N. J.	Radio Wire Television Inc.	24 Central Ave.
READING, PENN.	George D. Barbey Company	404 Walnut Street
SCRANTON, PENN.	Scranton Radio & Television Supply Co.	519-21 Mulberry Street
WASHINGTON, D. C.	Sun Radio & Service Supply Co.	938 F Street, N. W.

Listings on this page do not necessarily imply endorsement by QST of the dealers or of other equipment sold by them.

# BE Good TO YOURSELF

... or be good to the kid down the street with some of that extra Christmas money ... by giving a copy of the License Manual ... or the Handbook ... or a couple of Log Books ... or some Message Blanks ... or, best of all, a membership-subscription to *QST*. Orders can be sent direct to:

**American Radio Relay League, Inc.**  
West Hartford, Connecticut

## AMATEUR RADIO LICENSES

Day and Evening Classes in Code and Theory  
HOME STUDY COURSES

*Reasonable, Efficient and Thorough, Hundreds of Licensed Students Now on the Air*

American Radio Institute, 1123 Broadway, New York, N. Y.

## RADIO COURSES

Mid-Term Classes Now Starting

RADIO OPERATING • BROADCASTING • CODE  
RADIO SERVICING • TELEVISION  
• ELECTRONICS — 1 year day course; 2 years eve.  
Day and Evening Classes — Booklet upon request

**NEW YORK YMCA SCHOOLS**  
4 West 63rd Street, New York City

## RADIO TECHNOLOGY



RCA Institutes offer an intensive course of high standard embracing all phases of Radio and Television. Practical training with modern equipment at New York and Chicago Schools. Also specialized courses in Aviation Communications, Radio Servicing and Commercial Operating. Illustrated Catalog on request

**RCA INSTITUTES, INC.** Dept. ST-41

A Radio Corporation of America Service

75 Varick St., New York 1154 Merchandise Mart, Chicago

## Texas Ice Storm

(Continued from page 39)

through to Amarillo. W5INM immediately contacted W5HVZ at Lubbock, and the message was relayed to W5EYX in Amarillo. This all happened about 9:15 p.m. The result was that an automobile was sent from Amarillo to Happy to flag along the road for the trains en route, the highway running parallel to the railroad most of the way. . . ."

Braniff Airlines, with two planes grounded at Amarillo, wheeled one of them from its hangar and used the two-way radio equipment aboard for contact with Dallas when the ground station went off because of power failure.

Full details of the amateur work performed during the Texas flood and ice storm are not available as *QST* goes to press. But enough is known to make it certain that another chapter of achievement has been added to the annals.

— C. B. D.

## RADIO OPERATING QUESTIONS AND ANSWERS

Nilson & Hornung's new edition covers all FCC commercial license exam elements. Standard handbook 20 years. \$2.50, postpaid. Money back if not satisfied and book returned in 10 days. Send check or money order . . . not cash. Free circular on request.

**NILSON RADIO SCHOOL, 51 East 42nd St., New York**

## RADIO

**ENGINEERING**, broadcasting, aviation and radio telegraphy and telephony, Morse telegraphy and railway accounting taught thoroughly. 48 weeks' engineering course, equivalent to three years of college radio work. School established 1874. All expenses low. Catalog free.

**DODGE'S INSTITUTE, Day Street, Valparaiso, Indiana**

## EASY TO LEARN CODE

It is easy and pleasant to learn the modern way — with an **Instructograph Code Teacher**. Ideal for the beginner or advanced student. ■ Many tapes available ranging from alphabet for beginners to typical messages on all subjects. Speed range 5 to 40 WPM. ■ Always ready, no QRM, beats having someone send to you.

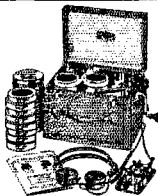

**FOR SALE OR RENT**  
STANDARD with 10 tapes and book of instructions, A.C. motor, . . . \$24.50  
With spring-wound motor . . . \$18.50  
JUNIOR with 5 tapes and book of instructions (not rented) . . . \$12.00

RENTAL Standard with 10 tapes and book of instructions \$3.00 first month, \$2.25 each additional month. References or \$10 deposit required. All rental payments may be applied on the purchase price should you decide to buy the equipment.

Write for details today

## INSTRUCTOGRAPH COMPANY

Dept. O, 4701 Sheridan Road, Chicago, Illinois

Representative for Canada:

Radio College of Canada, 54 Bloor St. West, Toronto

## GENERAL COMMUNICATIONS CRYSTALS HOLDERS AND OVENS

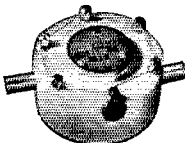
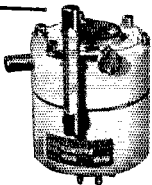

Precision Made by *Bliley*

WRITE FOR CATALOG G-11

**BLILEY ELECTRIC CO., ERIE, PA.**

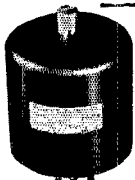



# HAM-ADS

(1) Advertising shall pertain to radio and shall be of nature of interest to radio amateurs or experimenters in their pursuit of the art.

(2) No display of any character will be accepted, nor can any special typographical arrangement, such as all or part capital letters be used which would tend to make one advertisement stand out from the others.

(3) The Ham-Ad rate is 15¢ per word, except as noted in paragraph (6) below.

(4) Remittance in full must accompany copy. No cash or contract discount or agency commission will be allowed.

(5) Closing date for Ham-Ads is the 25th of the second month preceding publication date.

(6) A special rate of 7¢ per word will apply to advertising which, in our judgment, is obviously non-commercial in nature and is placed and signed by a member of the American Radio Relay League. Thus, advertising of bona fide surplus equipment owned, used and for sale by an individual or apparatus offered for exchange or advertising inquiring for special equipment, if by a member of the American Radio Relay League takes the 7¢ rate. An attempt to deal in apparatus in quantity for profit, even if by an individual, is commercial and all advertising by him takes the 15¢ rate. Provisions of paragraphs (1), (2), (4) and (5) apply to all advertising in this column regardless of which rate may apply.

Having made no investigation of the advertisers in the classified columns, the publishers of QST are unable to vouch for their integrity or for the grade or character of the products advertised

## HELP WANTED

THE National Research Council of Canada invites applications from British subjects for positions in the Radio Laboratory, Division of Physics and Electrical Engineering, for: (I) Engineers. Qualifications—graduation in honours Physics, Engineering Physics or Electrical Engineering from a recognized university. Post-graduate training and experience in radio desirable. Experience in the design and operation of radio-frequency equipment. Experience in transmitter design and construction. Mathematical ability in the theoretical type of calculations arising from radio work. (II) Radio Technicians. Qualifications—technical school training or equivalent, in Radio Communications, practical machine shop training an asset. Ability to construct transmitters and/or receivers and carry out preliminary tests. Application forms may be obtained from the Secretary-Treasurer, National Research Council, Ottawa, Ontario, Canada.

WANTED: 2 quartz crystal grinders experienced on accurate commercial work. State experience and all particulars first letter. Must be U. S. citizens. Standard Piezo Company, West Louthers & Cedar Sts., Carlisle, Pa.

SEVERAL men experienced in the grinding of quartz plates to commercial frequencies. Apply Bendix Radio Corp., 920 E. Fort Ave., Baltimore, Md.

QUARTZ—direct importers from Brazil of best quality pure quartz suitable for making piezo-electric crystals. Diamond Drill Carbon Co., 719 World Bldg., New York City.

QSL'S. Maps. Cartoons. Free samples. Theodore Porcher, 7708 Navajo, Philadelphia, Pa.

CRYSTALS. mounted, 80-160, \$1.25, V-cut 40, \$2.25. R9 Crystals, 338 Murray Ave., Arnold, Pa.

USED receivers. Bargains. Cash only. No trades. Price list 3¢. W3DQ, Wilmington, Del.

QSL'S. W8JOT, Box 101, Rochester, N. Y.

TELEPLEXES, Instructographs bought, sold. Ryan's, Hannibal, Mo.

CRYSTALS: famous P.R., mounted in latest Alsimag 35 holders—40, 80 meter PR-X, 160 meter PR-Z, \$3; 40, 80 meter PR-Z (low drift), \$3.50; 20-meter PR-20, \$4.50; unconditionally guaranteed. Immediate shipment. Quality blanks, 65¢ Wholesale Radio Labs., Council Bluffs, Iowa, W9GFG.

CALLBOOKS—Winter edition now on sale containing complete up-to-date list of radio hams throughout entire world. Also world prefix map, and new time conversion chart. Single copies \$1.25. Canada and foreign \$1.35. Radio Amateur Call Book, 610 S. Dearborn, Chicago.

MACAUTO code machines: low monthly rental 50,000 words practice tapes. Write N. C. Ayers, 711 Boylston St., Boston, Mass. Granite 7189-W.

QSL'S—Brownie, W3CJI, 1725 Frankenfield Ave., Allentown, Pa.

CRYSTALS: police, marine, aircraft. C-W Mfg. Co., 1170 Esperanza, Los Angeles.

COMMERCIAL radio operators examination questions and answers. One dollar per element. G. C. Waller, W5ATV, 6540 Washington Blvd., Tulsa, Okla.

RADIO KITS—\$3.95 up. Single band; all-wave, 5-10 tubes. Fluorescent lighting. Save 50%. Catalog—free. McGee Radio, P-2035, Kansas City, Mo.

QSL'S. Free samples. Printer, Corwith, Iowa.

CRYSTALS in plug-in heat dissipating holders. Guaranteed good oscillators. 160-M 80M AT \$1.25; 40X \$1.65. 80M vari-frequency (5 kilocycle variance) complete \$2.95. State frequency desired, C.O.D.'s accepted. Pacific Crystals, 1042 S. Hicks, Los Angeles.

QSL'S—SWL's. Fritz, 455 Mason, Joliet, Ill.

FOR sale: W2AZ, 1 kw. fone rig. Same rig that made #1 Century Club. Super Pro & HRO. Preselector. Any offer considered. W2AZ, R.F.D. 2, Bellefontaine, Ohio.

WANTED: QST's 1930—1939, also Journals IRE. Roland Beers, 580 Massachusetts Ave., Cambridge, Mass.

QSL'S?—SWL's?—QSL's? Unbeatable. Samples? W8DED, Holland, Mich.

WANTED—Precision variable air condensers; resistance or decade boxes; G.R. 224 wavemeter or condenser from same; precision fixed condensers; precision vernier dials; Wheatstone bridge. Give condition, age, type, manufacturer, and best price first writing. Accuracy unnecessary. Bob Eubank, W3WS, 1227 Windsor Ave., Richmond, Va.

SELL, Rider Channalyt, new, \$85. W. Haussinger, 1102 Marion, Winona, Minn.

QST'S February 1931—March 1939 inclusive. Huston, 172 Concord St., Portland, Me.

QSL samples, prices, on request. W2AEY, 338 Elmora, Elizabeth, N. J.

SELLING—150 watt fone and FB7 receiver. W1APF, Alden Specht, Newton, Mass.

QST'S—1924-36 inc., good condition. Steel rack fone xmtr. Meters. Best offer. W3UB.

HRO Jr. Excellent condition. 150 watt transmitter, miscellaneous equipment. Complete for \$125 cash. W. J. Rowe, R.D. #4, Mechanicsburg, Pa.

DYNAMOTOR, input 6 volts, output 350 volts 150 ma. Used 4 hrs. \$20. W8OPM.

QSL'S. Finest. Lowest prices. Maleco, 1805 St. Johns Place, Brooklyn, N. Y.

WANTED: Utah kits 4 and 5. new. W8TRX, Waverly, Ohio.

DODGE separately excited 110 v. a.c. generator. \$15. Riders, Volumes 5, 6, 7, \$14. WILFS.

QSL'S—SWL's. Colorful, economical. W9KXL, 819 Wyandotte, Kansas City, Mo.

FOR sale—Comet Pro—DB20—xmitting equipment. W1KCC, Hartford, Conn.

HK-354 complete final for sale. W9SHL.

CRYSTALS: unmounted, \$1; three blanks, \$1. Crystal Manufacturer, Indiana, Pa.

WRITE Bob Henry, W9ARA, for best deal on all amateur receivers, transmitters, kits, parts. You get best terms (financed by myself); largest trade-in; personal cooperation; lowest prices. Prompt delivery of the NC-200X and all other newest apparatus. Write now. W9ARA, Butler, Mo.

SPECIALS: Brand new latest models in factory sealed cartons: Howard 436s \$29.95 (regularly \$39.95); Howard 460s with crystals \$59.95; SX-23s \$79.50. Terms. W9ARA.

RECONDITIONED guaranteed amateur receivers and transmitters at lowest prices. All makes and models. Free trial. Terms. Write for free list. W9ARA.

SELL NC-81X \$50. W1HTO.

ALL band kilowatt phone transmitter, RME69, DB20, DM36, \$550. Photo free. W7BL, 1921—30th South, Seattle, Wash.

QSL'S, SWL'S. 100—3 color—75¢. Lapco, 344 W. 39th, Indianapolis, Ind.

FOR sale—RME-69 new crystal filter. Looks and works like new. Also new 250 watt phone—CW transmitter. Photo and description. Fred Hofmann, 1445 Aster Place, Cincinnati, Ohio.

HAMS — wholesale prices on new Underwood portable type-writers — regular price \$54.50 only \$39.50 — \$3.95 down. Write Leo W9GFQ.

TRANSMITTING headquarters: 10P kits wired complete \$19.50; Utah Jr. xmtr complete \$15; 70 watt xmtrs ready to go only \$35; speech amp. modulator up to 80 watts \$25, same up to 150 watts \$49.50. Your own terms. Write Leo W9GFQ today.

RECONDITIONED receivers all makes, lowest terms, free trial — send for list. New Howard 460 receivers \$59.95, SX-23 \$79.50. Write for new bargain 124-page catalog. You get the best deal when you trade with Leo, W9GFQ, Wholesale Radio Laboratories, Council Bluffs, Iowa.

CRYSTALS; commercial or amateur: police, aircraft, marine and all types of low drift units for commercial services at attractive prices — send for catalog or get our bid. For the amateur: those FB, fully guaranteed T9 crystals, 40, 80, and 160 meter bands \$1.60 postpaid. Amateur "spot frequencies" \$2. T9 ceramic holder \$1. C.O.D.'s accepted. Sold by: Kerr's Radio Shop, El Paso, Texas; Henry Radio Shop, Butler, Mo.; The Hargis Company, Austin, Texas; Pemberton Labs., Ft. Wayne, Ind.; Frank Anzalone, 375 W. 46th, N. Y. C.; Casa Edison, Havana, Cuba; and Edison's, Temple, Texas.

WHEATSTONE tape automatic transmitters. Also new parts for Creed automatic transmitters. Probor Instruments, 99 Rogers Ave., Brooklyn, N. Y.

VE'S — wanted, coils 36 to 42 for SW3, swap parts or buy. VEAYE.

SELL: complete station W8CHB 400-watt rack and panel phone, condenser microphone, Meissner Signal Shifter, DB20 preselector, Comet Pro, oscilloscope and miscellaneous equipment, \$400. G. R. Gaskell, 317 Northview Rd., Dayton, Ohio.

1 kw. fone 250THs final 25 or 60 cy \$450. Write W8RYA, Niagara Falls, N. Y.

HT6 xmtr — 160-75-20 meter xtals and coils plus Shure xtal mike. Also Howard 438 revr with xtal. No reasonable offer refused. W9QYF.

BARGAIN — 1939 National 81-X, \$45. 1937 Harvey UHX-10 transmitter, 5-160 coils (except 40), AC power supply, microphone. Cost \$118.10. 1938 dynamotor for same, used 10 hours. Cost \$35. Make offer. WIBVR.

RCA television deflection and high voltage power supply chassis complete with yoke for nine or twelve inch kinescope. Original carton thirty dollars. Also complete file Electronics magazine 1930 thru 1938. Best offer. W2HNY.

HEAR everything broadcast to 10 meters, for \$19.95. New Echophone EC-1 full handsread receiver. Appeals to whole family's listening desires. Makes dandy portable because of small size, metal cabinet, self-contained speaker, phone-speaker switch, doublet antenna provision, beat oscillator, stand-by switch. Terms to suit. Write or call today. Scell's Radio, Hartford, Conn.

## HOW TO LEARN CODE

Whether you wish to enter radio as a career or as a hobby, the All Electric Master Teleplex Code Teaching Machine will show you how. Teleplex records your sending in visible dots and dashes on a specially prepared waxed paper tape and then sends back to you at any speed you desire. It does not merely show you code. It is code. No experience needed.



While not designated as standard equipment, Teleplex is used at many U. S. Army Posts, Naval Training Stations as well as by the American Telephone & Telegraph Co. Also by practically every private school in the U. S. teaching code; and many foreign governments.

### FREE BOOK

We furnish you complete course, including practice messages, the All Electric Master Teleplex, plus a personal service on a **MONEY BACK GUARANTEE**. Low cost. Easy terms. *Without obligation write for booklet "Q1."*

**TELEPLEX CO.** 67-69 PARK PLACE  
NEW YORK, N. Y.

In Canada write:  
CANADIAN ELECTRONIC INST., TORONTO, ONT.

## REWARD FOR TRAINING

-Better Jobs!  
-Increased Salaries!

CREI trained men are well rewarded for their earnest ambition to succeed in Radio. Surveys disclose that CREI graduates, as a group, are among the **HIGHEST PAID IN RADIO**. . . . 69% enjoy SALARY INCREASES during or immediately after their training!

If you are no longer content with your present progress in radio — if you are anxious to advance to the better radio job you **KNOW** should be yours — now is the time to investigate the opportunities that await you through CREI training in advanced Practical Radio Engineering. **5,000 RADIOMEN CAN'T BE WRONG!** They're the men who have already turned to CREI for the advanced training they realized is necessary for success. Can't we help **YOU?**

Write us Today —

If you are a professional radioman and want to make more money — let us prove we have the answer to your problem. Our free booklet gives complete details — without obligation. To help us intelligently answer your inquiry — please state briefly your education, radio experience and present position.



**Capitol Radio Engineering Institute**  
Dept. Q-1 3224 16th St. N. W., Washington, D. C.

### JACOBS ADJUSTABLE SEPARATOR

U. S. patent No. 2,950,170 — March 6, 1964 — others pending



Made of plastic, this improved Separator provides efficient and split-second adjustment of open 2-wire R. F. feedlines of any spacing from 2" up to 8". Used in conjunction with Herts, Loop and Bentz antennas; also vertical radiators. Weight less; no tie wires! Unbreakable. Price: \$1.50 for a set of 6.

Charles F. Jacobs (W2EM)

270 Lafayette St.

New York, N. Y.

## Piezo-Electric Crystals Exclusively

- Quality crystals of all practical frequencies supplied SINCE 1925. Prices quoted upon receipt of your specifications.

Our Pledge: **QUALITY FIRST**

**SCIENTIFIC RADIO SERVICE**

"The Crystal Specialists Since 1925" University Park, Hyattsville, Md.

## STOP GUESSING

By using the new sensitive  
**DB Field Strength Meter**

Comparative field intensity in decibel units. Unexcelled for adjusting all kinds of antennas, checking phone quality, over-modulation or neutralization. 1715 to 60,000 kc. in six bands.

Amateur Net. . . \$18.50

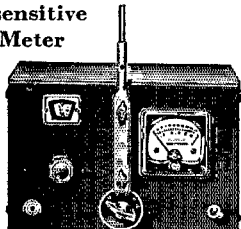

**RADIO TRANSCEIVER LABORATORIES**

8427 115 STREET RICHMOND HILL, NEW YORK CITY  
CABLE ADDRESS: "RATRALAB", NEW YORK

# Your Nearby Dealer Is Your Best Friend

Your nearby dealer is entitled to your patronage. He is equipped with a knowledge and understanding of amateur radio. He is your logical source of advice and counsel on what equipment you should buy. His stock is complete. He can supply your needs without delay. His prices are fair and consistent with the high quality of the goods he carries. He is responsible to you and interested in you.

One of these dealers is probably in your city — Patronize him!

## ATLANTA, GEORGIA

Radio Wire Television Inc.  
265 Peachtree Street  
"The World's Largest Radio Supply House"

## JAMAICA, L. I., NEW YORK

Radio Wire Television Inc.  
90-08 166th Street (Merrick Road)  
"The World's Largest Radio Supply House"

## BALTIMORE, MARYLAND

Radio Electric Service Co.  
3 N. Howard St.  
Everything for the Amateur

## MONTREAL, CANADA

Canadian Electrical Supply Co., Ltd.  
285 Craig Street West  
Largest Distributors of Radio Parts & Testers in British Empire

## BOSTON, MASS.

Radio Wire Television Inc.  
110 Federal Street  
"The World's Largest Radio Supply House"

## NEWARK, N. J.

Radio Wire Television Inc.  
24 Central Avenue  
"The World's Largest Radio Supply House"

## BRONX, NEW YORK

Radio Wire Television Inc.  
542 East Fordham Road  
"The World's Largest Radio Supply House"

## NEW YORK, N. Y.

Radio Wire Television Inc.  
100 Sixth Avenue  
"The World's Largest Radio Supply House"

## BUFFALO, NEW YORK

Radio Equipment Corp.  
326 Elm Street  
W8PMC and W8NEL — Ham, service and sound equipment

## NEW YORK, N. Y.

Harrison Radio Company  
12 West Broadway  
Harrison Has It! Phone WO 2-6276 for information or rush service

## BUFFALO, NEW YORK

Dymac Radio  
1531 Main Street — Cor. Ferry  
Open Evenings GA. 0252

## PHILADELPHIA, PENNSYLVANIA

Eugene G. Wile  
10 S. Tenth Street  
Complete Stock of Quality Merchandise

## HARTFORD, CONNECTICUT

Radio Inspection Service Company  
227 Asylum Street  
What do you want? We have it. Radio exclusively

## PROVIDENCE, RHODE ISLAND

W. H. Edwards Company  
85 Broadway  
National, Hammarlund, Hallicrafter, Thordarson, Taylor, RCA

## HARTFORD, CONNECTICUT

Hatry & Young, Inc.  
203 Ann Street  
Stores also in Bridgeport and New Haven

## RICHMOND, VIRGINIA

The Arnold Company  
Broad at Harrison St.  
W3EQQ — "The Virginia Ham Headquarters" — W3FBL

## HOUSTON, TEXAS

R. C. & L. F. Hall  
1021 Caroline Street (C 0721)  
"Specialists in Amateur Supplies"

## SCRANTON, PENNSYLVANIA

Scranton Radio & Television Supply Co.  
519-521 Mulberry Street  
Complete Stock of Quality Amateur Supplies

YOU CAN BE SURE  
WHEN YOU BUY FROM

**QST**

# ADVERTISERS

“Advertising for *QST* is accepted only from firms who, in the publisher’s opinion, are of established integrity and whose products secure the approval of the technical staff of the American Radio Relay League.”

*Quoted from QST’s advertising rate card.*

*Every conceivable need of a radio amateur can be supplied by the advertisers in QST. And you will know the product has the approval of the League’s technical staff*

## Index to Advertisers

	PAGE
Aerovox Corporation . . . . .	78
American Radio Institute . . . . .	90
Astatic Microphone Laboratory, Inc. . . . .	79
Barker & Williamson . . . . .	86
Bliley Electric Company . . . . .	52, 90
Browning Laboratories, Inc. . . . .	85
Burgess Battery Company . . . . .	77
Cameradio Company . . . . .	88
Candler System Company . . . . .	74
Capitol Radio Engineering Institute . . . . .	92
Cardwell Mfg. Corp., Allen D. . . . .	86
Centralab . . . . .	5
Collins Radio Company . . . . .	Cov. 2
Cornell-Dubilier Electric Corp. . . . .	54
Dodge’s Institute . . . . .	90
Eitel-McCullough, Inc. . . . .	55
Gardiner-Levering Company . . . . .	79
General Electric Company . . . . .	63
Gross Radio, Inc. . . . .	62
Hallcrafters, Inc., The . . . . .	1, 2
Hammarlund Mfg. Company, Inc. . . . .	51, 53
Harrison Radio Company . . . . .	88
Harvey Radio Company . . . . .	76
Hatry & Young . . . . .	85
Henry Radio Shop . . . . .	83
Hipower Crystal Company . . . . .	85
Instructograph Company, The . . . . .	90
Jacobs, Charles F. . . . .	92
Janette Mfg. Company . . . . .	78
Jensen Radio Mfg. Company . . . . .	71
Kenyon Transformer Company, Inc. . . . .	60
Mallory & Company, Inc., P. R. . . . .	50
Massachusetts Radio School . . . . .	79
Meissner Mfg. Company, Inc. . . . .	75
Midland Radio & Television Schools . . . . .	81
Millen Mfg. Company, Inc., James . . . . .	70
National Company, Inc. . . . .	Cov. 3, 49
New York YMCA Schools . . . . .	90
Newark Electric Company . . . . .	67
Nilson Radio School . . . . .	82, 90
Ohmite Mfg. Company, Inc. . . . .	56
Pioneer Gen-E-Motor Corp. . . . .	74
Port Arthur College . . . . .	62
Precision Apparatus Corp. . . . .	70
RCA Institutes, Inc. . . . .	90
RCA Mfg. Company, Inc. . . . .	Cov. 4, 57
Radio Mfg. Engineers, Inc. . . . .	95
Radio Shack, The . . . . .	65
Radio Transceiver Laboratories . . . . .	92
Scientific Radio Service . . . . .	92
Sickles Company, F. W. . . . .	82
Signal Electric Mfg. Company . . . . .	66
Solar Mfg. Corp. . . . .	58
Standard Piezo Company . . . . .	79
Sun Radio Company . . . . .	80
Taylor Tubes, Inc. . . . .	59
Teleplex Company . . . . .	92
Terminal Radio Corp. . . . .	84
Thordarson Electric Mfg. Company . . . . .	61
Triplet Elec. Instrument Company, Inc. . . . .	66
United Transformer Corp. . . . .	96
Vibroplex Company, Inc., The . . . . .	64
Ward Leonard Electric Company . . . . .	64
Wholesale Radio Laboratories . . . . .	65
Vaxley . . . . .	50

# In 1941 . . .

••••• the well equipped amateur station and the efficient commercial installation will use RME receiving equipment exclusively,

because: —

## ONE:

RME offers a specialized design service in the construction of radio apparatus built to individual specifications. Such uncommon units as CRYSTAL CONTROLLED RECEIVERS, OSCILLOSCOPE AMPLIFIERS, and FOREST SERVICE COMMUNICATIONS INSTRUMENTS are only a few of the "special" units which have already come from the RME lab.

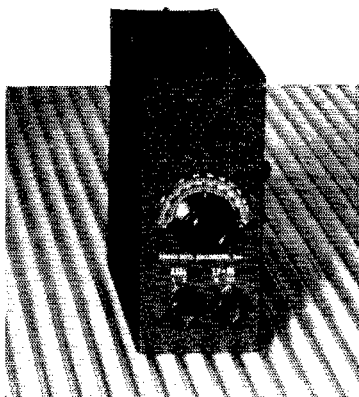

LF-90 INVERTER

## TWO:

There is an RME customed unit for operation on every frequency channel in the practical radio spectrum, from 90 kilocycles to 60 megacycles. A complete receiving installation would be one consisting of an RME-99 receiver as the foundation unit, an LF-90 INVERTER for long-wave reception, and a DM-36 EXPANDER for ultra-short-wave operation.

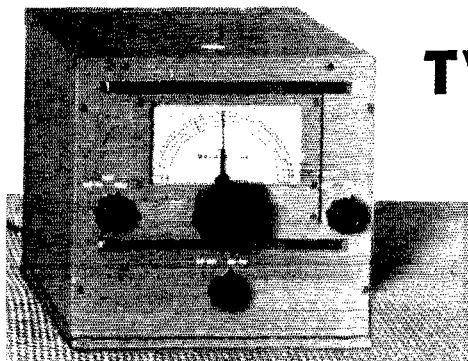

DM-36 EXPANDER

## THREE:

There is the assurance that when an RME is purchased, long years of trouble-free operation may be expected from it. Expeditions, governmental agencies, and others where reliability of communication is absolutely necessary KNOW that RME instruments are completely trustworthy.

RME-99  
COMMUNICATIONS  
RECEIVER

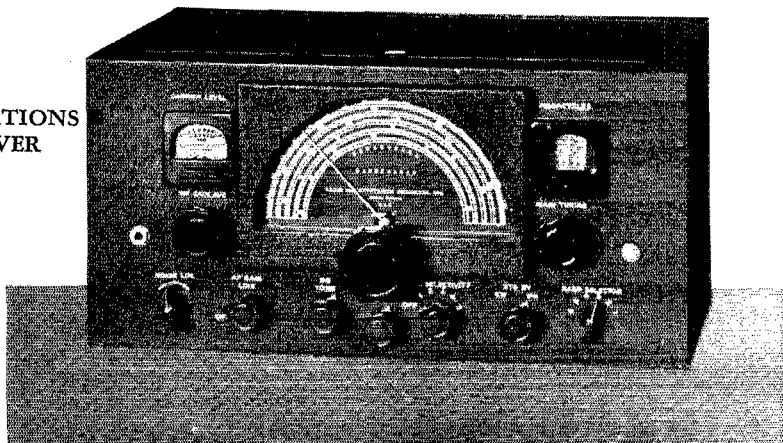

Radio Mfg.  
Engineers, Inc.

Peoria, Illinois

# VARI-TRAN CONTROL UNITS



For controlling: Rectifier output—  
Motors—Heaters—  
Line voltage—  
Lights



### FEATURES

- PRECISE OUTPUT VOLTAGE ADJUSTMENT
- VOLTAGE INDEPENDENT OF LOAD
- HIGH EFFICIENCY
- LOW TEMPERATURE RISE
- ROLLER TYPE NON-FUSING CONTACT
- OVERSIZE HEAT RADIATING DISC
- GLASS INSULATED WIRE
- RECTANGULAR LAMINATION AND CASE STRUCTURE
- PANEL OR BENCH MOUNTING

Standard Varitrans are for 115 or 230 Volt service. The respective smoothly adjustable output voltages are 0-130 and 0-260 volts. Universal Varitrans have a 0-30 volt variable secondary ideal for line voltage correction and low voltage equipment. 115 Volt Varitrans are available in 2, 5, 7.5, 11, 17, 30, and 44 amp. stock sizes. Write for Bulletin PS-404.

# VARIPOWER AUTOFORMERS

The UTC Varipower Autoformer is a universal voltage control device suitable for every purpose where a STEP TYPE voltage control is satisfactory.

They are designed to effect reduced power for transmitter operation, and they are so arranged that simultaneously with line voltage correction any output voltage from 0 to 130 volts can be obtained in five volt steps. The Varipower Autoformer thus permits control of filament voltage at the tube socket to within 2% of any desired value simultaneously with the line voltage and plate voltage control. These Varipower units may also be used to reduce or increase voltages on filament transformers. Thus an 872 filament transformer can be used for 866 tubes. The Varipower Autoformer has taps at 55, 75, 95, 100, 105, 110, 115, 120, 125 volts.

	Net Price
VA-1— 150 watt output rating ...	\$3.60
VA-2— 250 watt output rating ...	4.50
VA-3— 500 watt output rating ...	6.00
VA-4— 1000 watt output rating ...	9.00
VA-5— 2000 watt output rating ...	12.00

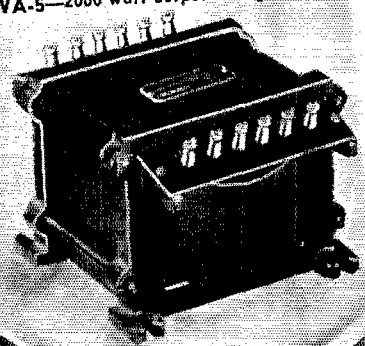

# UNITED TRANSFORMER CORP.

Write: COMMUNICATIONS DIV. ★ 150 VARICK ST. ★ NEW YORK, N. Y.  
EXPORT DIVISION: 100 VARICK STREET NEW YORK, N. Y. CABLES: "ARLAB"

# W2BKX

*A price winner in the National  
Amateur Station Contest*

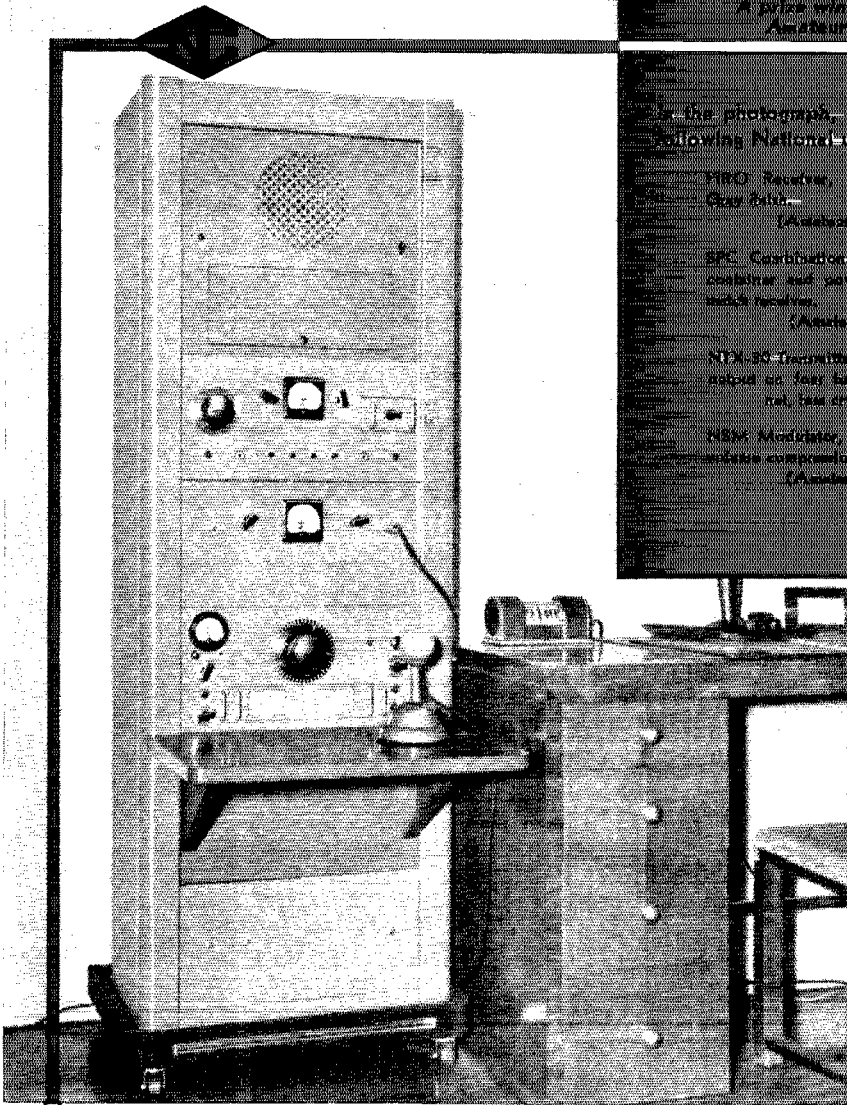

In the photograph, W2BKX uses the following National units—

PRO Receiver, rack mounted—  
Gray 540—

(Amateur ret. \$192.00)—

SPC Coordinator—speaker, coil—  
cabinet and power supply, to  
match receiver—

(Amateur ret. \$54.00)—

NTX-20 Transmitter with 20 wide  
adjust or less bands (Amateur  
ret. less crystal, \$130.00)—

MSM Modulator, with automatic  
volume compression—

(Amateur ret. \$87.00)—

## **“Dependability, Compactness, Economy”**

In selecting equipment for his station, George Wies, W2BKX, tells us that he was guided by three requirements — “Dependability, Compactness and Economy.” Compactness is self-evident from his photograph, for the portable rack incloses complete receiving and transmitting equipment.

“As for the dependability,” he says, “for almost a year we have operated this station and it has never failed us. . . . The Xmitter has done a swell job for us, getting out better than a lot of bigger rigs we have used. . . .”

On economy — “Correct, it costs a lot of money to buy all this gear at one shot, but we have never had to buy anything since to make it work or to ‘improve’ it. . . . Real economy is getting the best in the first place as one usually ends up with it anyway.”

**NATIONAL COMPANY, INC., MALDEN, MASS.**



RCA-829

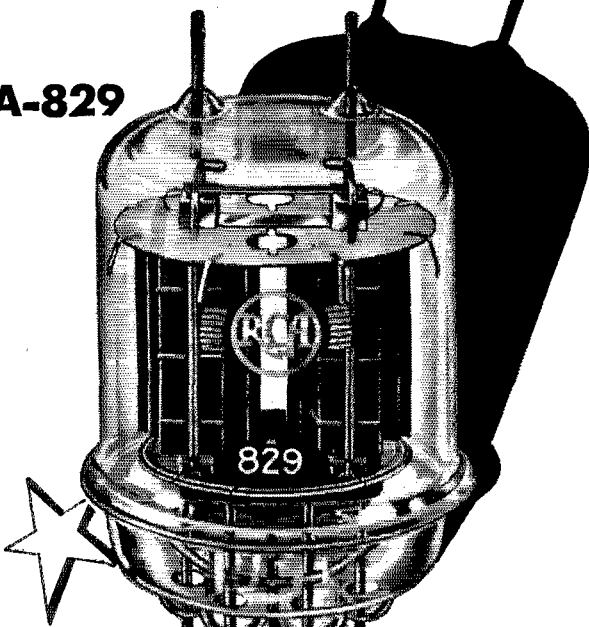

**HIGHER  
EFFICIENCY for the  
HIGHER FREQUENCIES!**

**"A WHALE OF A TUBE FOR ITS SIZE"**

Small enough to lay comfortably in the palm of your hand, the new RCA-829 Twin R-F Beam Power Amplifier is "big" enough so that a single tube in push-pull class C telegraph service can handle 120 watts power input with less than 1 watt of r-f grid drive—at frequencies as high as 200 Mc. At reduced ratings, it may be operated as high as 250 Mc. And don't forget! The 829 is a real money-saver, due to the simplifications it makes possible in transmitter design. *Neutralization is unnecessary.* The twin structure simplifies circuit adjustments. In brief, at the U.H.F.'s the 829 offers exceptional efficiency, high power sensitivity and plenty of power output. The heater can be series-operated from a 12.6-volt supply or parallel-operated from a 6.3-volt supply. Max. CCS (Continuous Commercial Service) Ratings are: D-c plate voltage, 500 volts; total d-c plate current, 240 ma.; and total plate dissipation for both units, 40 watts. At a plate input of 120 watts, typical power output is approximately 83 watts.

RCA-829 Amateur Net Price \$19.50

*Take the mystery out of ultra-high frequencies!  
Write today for complete technical information on  
these three new tubes to Commercial Engineering  
Section, RCA Manufacturing Co., Harrison, N. J.*

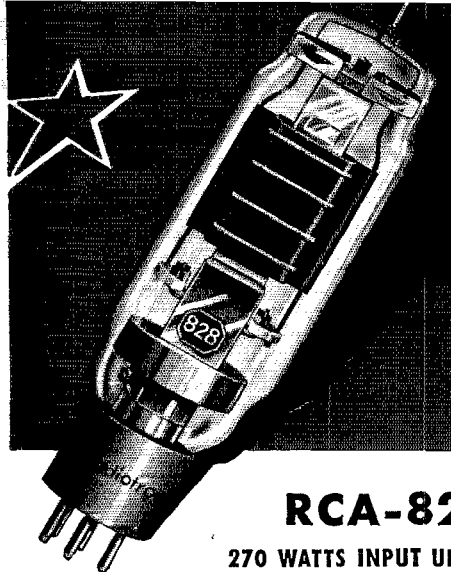

RCA-828

270 WATTS INPUT UP

30 Mc WITH ONLY 2.2 WATTS DRIVING PO

This new multi-electrode Transmitting Beam Power Amplifier offers, we sincerely believe, more for your money than any other tube of its class. It is tops for r-f applications, especially where a hand-change without neutralization is desired. Max. ratings as high as 30 Mc and at reduced ratings up to 75 Mc. Two RCA-828's may be used as class AB<sub>1</sub> modulator with 300 watts a-f output and 1% distortion. Maximum ICAS (Intermittent Commercial and Amateur Service) Ratings for class C telegraph service are: D-c plate voltage, 1500 volts; d-c plate current, 180 ma.; and plate dissipation, 80 watts.

RCA-828 Amateur Net Price \$17.50

**RCA-1628 THIS TRIODE TAKES**

**FULL RATED 50 WATTS INPUT UP TO 500**

The new RCA-1628 is a general-purpose triode with a tantalum grid and plate. It is capable of operating at maximum ratings at frequencies as high as 500 Mc and at reduced ratings as high as 67 Mc. The three filament leads may be connected in parallel through r-f by-pass condensers, thus minimizing the effect of filament-lead inductance at the ultra-highs. D-c grid and plate leads brought out of the bulb through separate seals make neutralization at the U.H.F.'s a simple matter. Max. class C telegraph CCS ratings are: D-c plate voltage, 1000 volts; d-c plate current, 60 ma.; plate input, 50 watts; and plate dissipation, 40 watts; typical driving power at a plate voltage of 1000 volts is approximately 1.7 watts; typical power output, approximately 35 watts.

RCA-1628 Amateur Net Price \$32.00

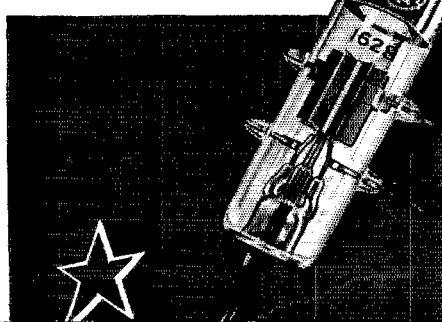

**Radio Tubes**