

QST

may, 1941

25 cents

35c in Canada

devoted entirely to

amateur radio



In This Issue—Some Successful 56-Mc. Arrays



Sorry, Mister Janus

Mr. Janus, the old Romans said, was a smart guy. But why not, being double-headed as he was? ★ We were thinking the other day that it would be handy to have him around. And then taking stock, we decided we could dispense with the idea because here at Collins

we have not two but many heads. ★ Our recently expanded factory is manned by a skillful personnel trained to build radio equipment of excellence. Collins engineering department abounds with every kind of mechanical and electrical proficiency.

COLLINS RADIO COMPANY

GENERAL REPRESENTATIVE: NEW YORK, N. Y.: 44 WEST 42 STREET

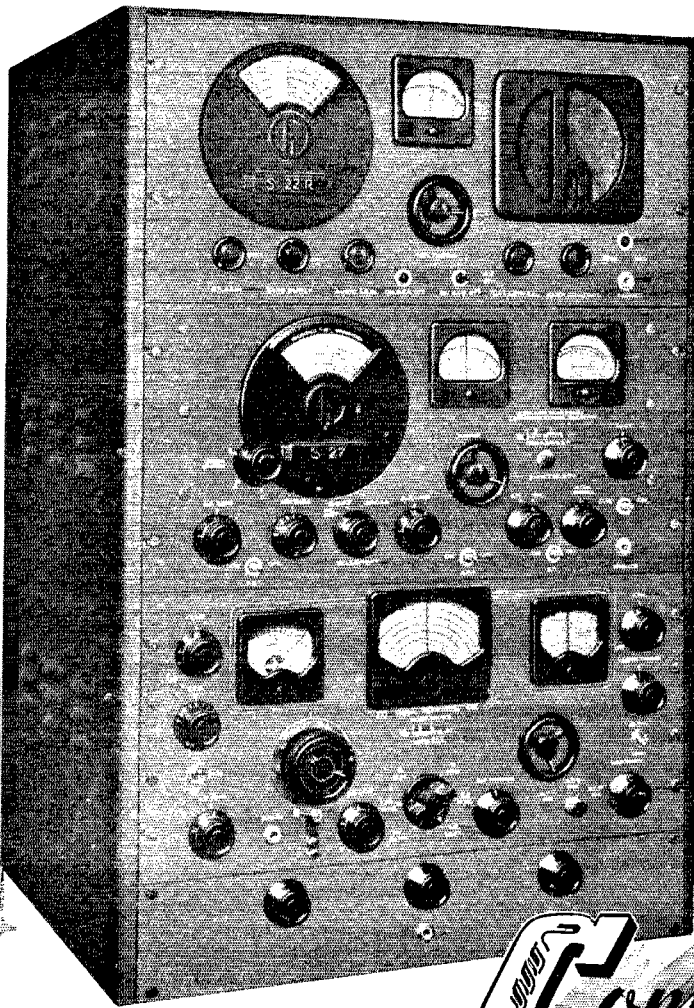

2730
to
1.8 METERS
FM/AM

Complete Radio Receiving Station!

Covers substantially everything in the radio spectrum. You can use one, two or all three units simultaneously through the separate antenna switch. Monitoring speaker connects to any one; in addition separate speakers can be connected as you wish. Headphone monitoring jack ties into output of any one of the three receivers. The only receiving unit made which tunes continuously from 1.82 to 2730 (165 mc to

110 kc) A few of its services are: time signals, coastal and ship telegraph and telephone, aircraft beacons, standard broadcast, relay broadcast, aviation, amateur, international short wave bands, police, government, press and educational channels. FM broadcast and relay bands with high fidelity audio for best FM reception. Is 20½" wide, 30" high, 18" deep. Sells complete for \$450.00.

the hallicrafters co.
CHICAGO, U. S. A.

USED BY 33 GOVERNMENTS SOLD IN 89 COUNTRIES

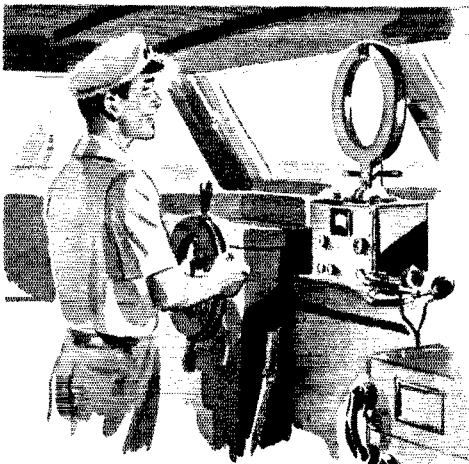

Dependable Communications for your travels

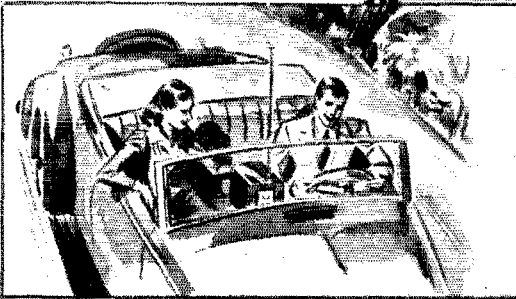

Model S-29, The Sky Traveler is the perfect portable communications receiver for use in automobiles and trailers. It is rugged and compact.

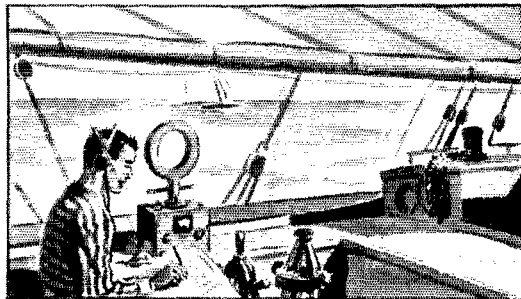

Model S-30, Radio Compass. Put a radio compass on your craft and know your location—it has the broadcast band, too.



Model S-30, Radio Compass enables you to check your position against beacon, broadcast or shore radio-phone stations. Covers from 200 to 3000 kc.

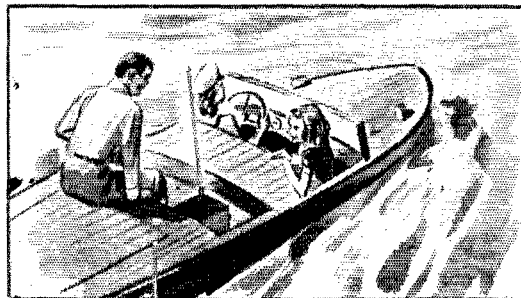

Model S-29, The Sky Traveler. You can take it with you wherever you go. A real portable designed to communications receiver tolerances.

You can enjoy your travels better with Hallicrafter communications equipment—there is a unit to suit your every requirement.

Model S-29, The Sky Traveler
\$59.50 Complete
Model S-30, Radio Compass
\$99.50 Complete

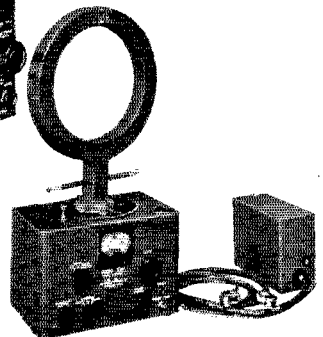
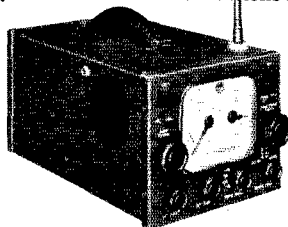

the hallicrafters co.

CHICAGO, U. S. A.

USED BY 33 GOVERNMENTS • SOLD IN 89 COUNTRIES

MAY 1941

VOLUME XXV

NUMBER 5



STAFF

Editorial

KENNETH B. WARNER, W1EH
Editor and Business Manager

CLARK C. RODIMON, W1Z
Managing Editor

GEORGE GRAMMER, W1DF
Technical Editor

DONALD H. MIX, W1TS
BYRON GOODMAN, W1JPE
Assistant Technical Editors

EDWARD P. TILTON, W1HDQ
Contributing Editor, U.H.F.

VERNON CHAMBERS, W1EQ
Technical Information Service

JAMES J. LAMB, W1AL
Research Engineer, A.R.R.L.

Advertising

F. CHEYNEY BEEKLEY, W1GS
Advertising Manager

Circulation

DAVID H. HOUGHTON
Circulation Manager

RALPH T. BEAUDIN, W1RAW
Assl. Circulation Manager



OFFICES

38 La Salle Road
West Hartford, Connecticut

Subscription rate in United States and Possessions, \$2.50 per year, postpaid; all other countries, \$3.00 per year, postpaid. Single copies, 25 cents. Foreign remittances should be by international postal or express money order or bank draft negotiable in the U. S. and for an equivalent amount in U. S. funds.

Entered as second-class matter May 29, 1919, at the post office at Hartford, Connecticut, under the Act of March 3, 1879. Acceptance for mailing at special rate of postage provided for in section 1103, Act of October 3, 1917, authorized September 9, 1922. Additional entry at Concord, N. H., authorized February 21, 1929, under the Act of February 28, 1925. Additional second-class entries to cover sectional editions authorized March 20, 1935.

Copyright 1941 by the American Radio Relay League, Inc. Title registered at United States Patent Office.

QST

devoted entirely to

AMATEUR RADIO

PUBLISHED, MONTHLY, AS ITS OFFICIAL ORGAN, BY THE AMERICAN RADIO RELAY LEAGUE, INC., AT WEST HARTFORD, CONN., U. S. A.; OFFICIAL ORGAN OF THE INTERNATIONAL AMATEUR RADIO UNION



CONTENTS

Editorial	Arthur Aubin Hebert, Sr.	7
Keying the Crystal Oscillator	Byron Goodman, W1JPE	10
An Improved Electron-Coupled Oscillator	D. F. Metcalf, W5ECF	14
In the Services		18
Red Cross Emergency Test	Gil	19
For the Junior Constructor		
Low-Power 112-Mc. Transmitter-Receiver		20
Successful 56-Mc. Arrays	E. P. Tilton, W1HDQ	23
The Month in Canada		26
P.O.W.		26
What the League Is Doing		27
Army-Amateur Radio System Activities		29
How to Build a Code-Instruction Table		30
On the Ultra Highs	E. P. Tilton, W1HDQ	33
Emergency Transmitter Design Considerations	O. W. Read, W2JHR and W. J. Stiles, W2MBS	36
Code Proficiency Program Expanded	F. E. Handy, W1BDI	40
Hints and Kinks		
Warning to Users of Transformerless-Powered Equipment— Single-Switch Change-Over Systems—Something New in Sideswipers		42
Correspondence from Members		44
Operating News		45
Brasspounders' League		48
DX Notes		50
Code Practice Transmissions		52
WIAW Operating Schedule		54
Hamfest Schedule		58
Silent Keys		60
Delta Division Convention		66
Book Reviews		68
QST, 25 Years Ago this Month		70
WWV Schedules		78
W9JID		78
W7GGG		82
New Transmitting Tubes	6SF7-12SF7-6SN7GT, 45Z3-3Q4	86
KA1NF		88
Hamads		91
QST's Index of Advertisers		94

Section Communications Managers of the A.R.R.L. Communications Department

All appointments in the League's field organization are made by the proper S.C.M., elected by members in each Section listed. Mail your S.C.M. (on the 16th of each month) a postal covering your radio activities for the previous 30 days. Tell him your DX, plans for experimenting, results in phone and traffic. He is interested, whether you are an A.R.R.L. member or get your QNT at the newstands; he wants a report from every active ham. If interested and qualified for O.R.S., O.P.S. or other appointments he can tell you about them, too.

ATLANTIC DIVISION			
Eastern Pennsylvania Maryland-Delaware-District of Columbia Southern New Jersey Western New York Western Pennsylvania	W3BES W3CIZ W3CCO W8PLA W8CKO	Jerry Mathis Hermann E. Hobbs Lester H. Allen Fred Chichester E. A. Krall	6042 Master St. 9701 Monroe St. Silver Spring P.O. 704 Quinton Ave. 703 Broadway
			Philadelphia Linden, Maryland Trenton Sonyea East Mc Keesport
CENTRAL DIVISION			
Illinois Indiana Kentucky Michigan Ohio Wisconsin	W9IHL W9AB W9ARU W8DPE W8AQ W9UIT	Mrs. Carrie Jones Harry B. Miller Darrell A. Downard Harold C. Bird E. H. Gibbs Aldrich C. Kroes	2407 Central Ave. 729 E. Lowell Ave. 176 N. Longworth Ave. R. F. D. 2 405 Broad St. 2702 So. 46th St.
			Alton Mishawaka Louisville Pontiac Wadsworth Milwaukee
DAKOTA DIVISION			
North Dakota South Dakota Northern Minnesota Southern Minnesota	W9WWL W9ADJ W9IGZ W9YNQ	Anton C. Theodos E. C. Mohler Edwin L. Wicklund Millard L. Bender	Box 444 Box 149 R. F. D. 3 608 N. Huron Ave.
			Williston Rapid City Kensington Spring Valley
DELTA DIVISION			
Arkansas Louisiana Mississippi Tennessee	W5GNV W5DWW W5EGE W4DDJ	John R. Sanders W. J. Wilkinson, Jr. S. Benton Cain M. G. Hooper	P. O. Box 1563 Room 313, Jefferson Hotel 221 E. Monticello 4908 Georgia Ave.
			Little Rock Shreveport Brookhaven Nashville
HUDSON DIVISION			
Eastern New York N. Y. C. & Long Island Northern New Jersey	W2LU W2AZV W2LMN	Robert E. Haight E. L. Baumach Edward Gursky, Jr.	511 South Holmes St. 102 Central Ave. 367 Van Winkle Ave.
			Scotia Massapequa, L. I. Hasthorne
MIDWEST DIVISION			
Iowa Kansas Missouri Nebraska*	W9PJR W9AWP W9OUD W9WKP	L. B. Vennard A. B. Unruh Miss Letha Allendorf Garold Bennett	1113 So. 9th St. 1617 S. Seneca St. 1015 W. 3rd St. 914 West 7th St.
			Burlington Wichita Joplin Hastings
NEW ENGLAND DIVISION			
Connecticut Maine Eastern Massachusetts Western Massachusetts New Hampshire Rhode Island Vermont	W1CTI W1ITE W1ALP W1JAH W1FTT W1HRK W1KJG	Frederick Ellis, Jr. H. W. Castner Frank L. Baker, Jr. William J. Barrett Mrs. Dorothy W. Evans Clayton C. Gordon Clifton G. Parker	19 Merrill Rd. 147 Church 91 Atlantic St. 239 Columbia St. 163 South Main St. 70 Columbia Ave., Gaspee Box 537
			Norwalk Damariscotta North Quincy Adams Concord Plateau, Warwick Morriaville
NORTHWESTERN DIVISION			
Alaska Idaho Montana Oregon Washington	K7GNL W7CRR W7CPY W7GNJ W7FCG	James G. Sherry Clifford A. Jessup Rex Roberts Carl Austin W. Beale	Post Office Dept. Box 1088 1137 Federal R. 4, School Ave.
			Chichagot Mocow Glendive Bend Walla Walla
PACIFIC DIVISION			
Hawaii Nevada Santa Clara Valley East Bay San Francisco Sacramento Valley Philippines San Joaquin Valley	K6ETI W6BIC W6IUZ W6T1 W6CIS W6MDI KAIGR W6KUT	Francis T. Blatt Edward W. Heim Earl F. Peterson Horace R. Greer Kenneth E. Hughes Vincent N. Feldhausen George L. Rickard Edwin A. Address	837 16th Ave. 5009 Claremont St. 101 Claremont Ave. 414 Fairmount Ave. 209 Lincoln Way 113 South Quincy St. Box 849 2921 North Van Ness Blvd.
			Honolulu Reno San Jose Oakland San Francisco McCloud Manila Fresno
ROANOKE DIVISION			
North Carolina South Carolina Virginia West Virginia	W4CVB W4BOE/ANG W3GWO W8OXO	W. J. Workman Ted Ferguson Frank S. Anderson, Jr. W. D. Tabler	P. O. Box 566 1213 College St. 4703 New Kent Ave. 1004 So. Davis Ave.
			Morganton Columbia Richmond Elkins
ROCKY MOUNTAIN DIVISION			
Colorado Utah-Wyoming	W9EHC W7ZGZ	Carl C. Drumeller Henry L. Schroeder	224 Colorado Ave., Apt. 3 P. O. Box 731
			Pueblo Laramie, Wyoming
SOUTHEASTERN DIVISION			
Alabama Eastern Florida Western Florida Georgia West Indies (Cuba-Puerto Rico- Virgin Islands)	W4DGS W4PEY W4AXP W4AOB CM2OP	James F. Thompson Carl G. Schaal Oscar Cederstrom William U. Hanks Mario de la Torre	12 Clanton Ave. Waucoma Apts. Lakeview Hotel Second St. & Bruce Ave. 4 Hunter St., S.E. Escobar 110 (Altos)
			Montgomery Clermont De Funiak Springs Atlanta Habana, Cuba
SOUTHWESTERN DIVISION			
Los Angeles Arizona* San Diego	W6MQM W6KOL W6BKZ	Ralph S. Click John K. Oliver Louis A. Cartwright	1038 Milwaukee Ave. Box 642 370 Nautilus
			Los Angeles Nogales La Jolla
WEST GULF DIVISION			
Northern Texas* Oklahoma Southern Texas New Mexico	W5EAV W5GFT W5SMN W5ENI	R. E. Hughes Russell W. Battern Horace E. Biddy Dr. Hilton W. Gillett	1410 Ave. E, N.W. Box 290 1740 Sciley Ave.
			Childress Enid San Antonio Lovington
MARITIME DIVISION			
Maritime	VE1DQ	A. M. Crowell	69 Dublin St.
			Halifax, N. S.
ONTARIO DIVISION			
Ontario	VE3EF	Flying Officer Donald R. Gunn	% Canadian Bank of Commerce
			New Toronto, Ont.
QUEBEC DIVISION			
Quebec	VE2CO	Lindsey G. Morris	Apt. 6, 4510 Girouard Ave., N.D.G.
			Montreal, P. Q.
VANALTA DIVISION			
Alberta British Columbia	VE4GE VE5DD	C. S. Jamieson C. O. Sawyer	581 W. Riverside Drive 2634 West 31st Ave.
			Drumheller, Alta. Vancouver
PRAIRIE DIVISION			
Manitoba Saskatchewan	VE4AAW VE4SY	A. W. Morley Arthur Chesworth	747 McMillan Ave. 1071 4th Ave., N.W.
			Winnipeg Moose Jaw

* Officials appointed to act until the membership of the Section choose permanent S.C.M.'s by nomination and election.

A NEW CONCEPT IN SPEECH REPRODUCTION

Jensen

Speechmaster TYPE "AP"

YOU NEED A "SPEECH-MASTER" FOR CLEAR, CRISP, BETTER SPEECH REPRODUCTION

To demand attention . . . to put the message through with "punch" . . . to overcome static, QRM and room noise . . . to do all this efficiently, compactly, requires scientific design for most effective speech reproduction. Jensen Engineers provided a new solution to the problem in the Type AP "Speech-Master" using the Peridynamic principle and special radiating system.

Desk Type AP-10 for desk or wall mounting, and Panel Type AP-11, permit you to add or build-in "Speech-Master" advantages anywhere—easily! List Prices \$9.95 and \$8.10.

Ask your distributor for free Bulletin B106—or write us.

Jensen

3631 SOUTH LARAMIE AVENUE - CHICAGO
CABLE ADDRESS: JENKAD CHICAGO

REPRODUCTION

THE AMERICAN RADIO RELAY LEAGUE

Directors

<i>President</i>	
GEORGE W. BAILEY.....	W1KH 74 Webster Road, Weston, Mass.
<i>Vice-President</i>	
CHARLES E. BLALACK.....	W6GG Box 55, Yuma, Ariz.
<i>Canadian General Manager</i>	
ALEX REID.....	VE2BE 169 Logan Ave., St. Lambert, P. Q.
<i>Atlantic Division</i>	
WALTER BRADLEY MARTIN.....	W3QV Box 612, Roslyn, Pa.
<i>Central Division</i>	
GOODWIN L. DODLAND.....	W9TSN 10 No. Clark St., Chicago
<i>Dakota Division</i>	
FRED W. YOUNG.....	W9MZN 1333 North 12th Street, Fargo, North Dakota
<i>Delta Division</i>	
E. RAY ARLEDGE.....	W5SI P.O. Box 286, Pine Bluff, Ark.
<i>Hudson Division</i>	
ROBERT AKERIDGE KIRKMAN.....	W2DSY 920 Eighth Ave., Brooklyn
<i>Midwest Division</i>	
FLOYD E. NORWINE, JR.....	W9EFC 7405 Hiawatha Ave., Richmond Heights, Mo.
<i>New England Division</i>	
PERCY C. NOBLE.....	W1BVR 37 Broad St., Westfield, Mass.
<i>Northwestern Division</i>	
KARL W. WEINGARTEN.....	W7BG 3219 N. 24th St., Tacoma, Wash.
<i>Pacific Division</i>	
J. L. McCARGAR.....	W6EY 66 Hamilton Pl., Oakland, Calif.
<i>Roonuke Division</i>	
H. L. CAVENESS.....	W4DW 2607 Vanderbilt Ave., Raleigh, N. C.
<i>Rocky Mountain Division</i>	
C. RAYMOND STEEDMAN.....	W9CAA 925 So. Gaylord St., Denver
<i>Southeastern Division</i>	
WILLIAM C. SHELTON.....	W4ASR Box 652, Daytona Beach, Fla.
<i>Southwestern Division</i>	
JOHN E. BICKEL.....	W6BKY 801 E. California St., Whittier, Calif.
<i>West Gulf Division</i>	
WILLIAM A. GREEN.....	W5BKH 301 Ross St., Abilene, Texas

THE AMERICAN RADIO RELAY LEAGUE, INC., is a non-commercial association of radio amateurs, bonded for the promotion of interest in amateur radio communication and experimentation, for the relaying of messages by radio, for the advancement of the radio art and of the public welfare, for the representation of the radio amateur in legislative matters, and for the maintenance of fraternalism and a high standard of conduct.

It is an incorporated association without capital stock, chartered under the laws of Connecticut. Its affairs are governed by a Board of Directors, elected every two years by the general membership. The officers are elected or appointed by the Directors. The League is non-commercial and no one commercially engaged in the manufacture, sale or rental of radio apparatus is eligible to membership on its board.

"Of, by and for the amateur," it numbers within its ranks practically every worth-while amateur in the nation and has a history of glorious achievement as the standard-bearer in amateur affairs.

Inquiries regarding membership are solicited. A bona fide interest in amateur radio is the only essential qualification; ownership of a transmitting station and knowledge of the code are not prerequisite. Correspondence should be addressed to the Secretary.



Past Presidents

HIRAM PERCY MAXIM, 1914-1936
EUGENE C. WOODRUFF, 1936-1940

Officers

<i>President</i>	GEORGE W. BAILEY, W1KH Weston, Mass.
<i>Vice-President</i>	CHARLES E. BLALACK, W6GG Altadena, Calif.
<i>Secretary</i>	KENNETH B. WARNER, W1EH West Hartford, Connecticut
<i>Treasurer</i>	ARTHUR A. HEBERT, W1ES West Hartford, Connecticut
<i>Communications Mgr.</i>	F. EDWARD HANDY, W1BDI West Hartford, Connecticut

General Counsel.....PAUL M. SEGAL
1026 Woodward Building, Washington, D. C.

Address all general correspondence to the administrative headquarters at West Hartford, Connecticut.

"IT SEEMS TO US—"

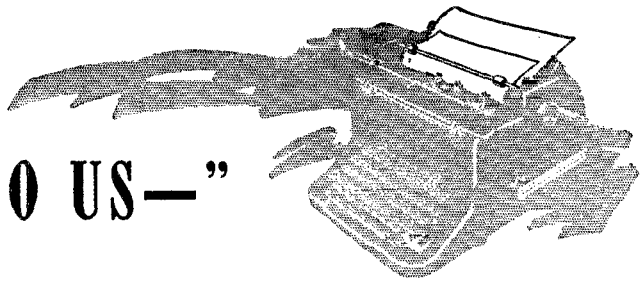

THE death on April 3rd of Arthur A. Hebert, W1ES, the well-loved treasurer of the American Radio Relay League, ended the life of one of the best-known figures in amateur radio and closed a remarkably long career of service to our art. He was nearing his sixty-eighth birthday, had been in failing health for over a year.

For many years the traveling representative of the League at amateur gatherings, it is probable that "AH" of W1ES was personally acquainted with more American hams than any other person who has ever lived. Thousands of amateurs will grieve at his passing and will feel, with us, that we have lost a friend and comrade.

MR. HEBERT was born in Quebec on August 30, 1873. He was educated as a foundry and mechanical engineer. We recall his saying that at some time in his youth he was a railroad Morse operator (indeed, he kept up his membership in the Order of Railway Telegraphers all his life) but most of his business career was spent in the steel industry. He was for some time assistant to the president of the Midvale Steel Company and for many years sales manager of the E. G. Long Company in New York, a foundry firm manufacturing heavy railway-car parts and special machinery. He was also president of the Ulster Foundry Corporation, founders of ship hardware and dealers in marine supplies. During this time he resided in Nutley, New Jersey.

As with all of us, he took up the study of wireless as a pastime. Unlike most of us, with him this occurred in 1906, in our shadowy

beginning days. By about 1908 he was an active amateur, and he never ceased. Even during his last illness, controls were run into his bedroom and W1ES kept most of its schedules.

When the League was organized, "AH" was one of its first members. Our first *List of Stations*, issued in 1914, shows him operating a 1-kilowatt rotary-spark station at Nutley with the special-license call 2ZH and possessing a first-class commercial operator's license. By early 1916 the League was organizing definite trunk lines for its relaying work and 2ZH was appointed eastern trunk-line manager for Trunk Lines C (Boston to Jacksonville) and D (branching off at Philadelphia and running to New Orleans). His first progress report appears in *QST* for just twenty-five years ago this month. The following year he participated in a series of meetings which resulted in the adoption of ARRL's first formal constitution and first Board of Directors, and in his own

election as vice-president of the League and general manager of all trunk lines. At this stage all operating activities of the ARRL were managed from his home, only *QST* and business matters at Hartford. But this arrangement was little more than in effect before the declaration of war brought the suspension of all ARRL activities. Not, however, before the consummation of that classic in our annals, the urgent Navy call that brought Messrs. Hebert and Maxim to the Brooklyn Navy Yard to hear a request to raise five hundred skilled operators from amateur ranks in ten days, and the doing of the same!

Arthur Hebert was similarly a participant in the



Arthur Aubin Hebert, Sr., W1ES
1873-1941



Giving some pointers on photography, to the not-too-interested W1UE, at a staff picnic. (Photo by W1BDL.)

post-war reorganization of the League, one of those who helped start the ball rolling again, and he retained membership on the Board of Directors until 1923 — when the entire Board of that day voted itself out of office to give effect to a new constitution which would provide ARRL a more representative form of government. In early 1920, however, he had been elected the League's treasurer, and he remained until his death the famous watchdog of our treasury, responsible for the safe-keeping of the funds and investments of our growing League.

It was at about this time, too, that ARRL

became conscious of the need for better contact with its members. It was proposed to the Board that "a field man is needed to travel around the country and maintain contact, spread spirit, prevent misunderstandings, help clubs, maintain interest, etc." and Hebert was proposed for the job. The trouble was how to afford it. Moreover, a man couldn't stand traveling all the time, nor could the League finance it. It happened that at that same time the secretary needed a financial man on the QST staff. The combination of the two needs resulted in bringing Hebert to the headquarters staff in middle 1923 in the unique position of a man of many jobs — treasurer, fieldman, credit manager, collections manager, headquarters office manager — so many angles that we used to say that one of the departments at headquarters was the Hebert Department. For over twelve years he spent a great deal of his time as the Board's representative in the field. When he retired from that strenuous activity in 1936 he figured that he had traveled over 157,000 miles, attended 99 divisional conventions and 189 special meetings, made talks before 35,438 people. In 1924 on one journey he covered 23,559 miles, visiting 14 conventions and 34 special meetings. It was these travels which made "Hebie" the best-known amateur in America.

He continued his office duties on the staff



At the 1917 meeting of the Board of Directors, shortly before the U. S. entry into the war, Mr. Hebert was elected vice-president and general manager of station activities. In this picture he is immediately to the right of Mr. Maxim, who is in the center of the group.

Here is Hebert the ardent yachtsman, skipper of the motor cruiser "Yoho," a hobby in which he found much relaxation.



until 1940, when his advancing illness compelled him to retire from all but his best love, the treasuryship. These lighter duties he was well able to carry, and just a few days before his condition again became serious he completed his regular annual report to the directors on his stewardship of last year.

W1ES WAS a movie fan, as was **H.P.M.**

before him, and he was the treasurer and a director of the Amateur Cinema League from its formation. He was a charter member of the Institute of Radio Engineers, an honorary member of the Radio Club of America. While still living in **W2** he was successively vice-president and president of the old Second District Executive Radio Council. He was an ardent yachtsman, the skipper of the *Yoho* and later of the *Jayem*, a member and former commodore of the



"AH" in a corner of the ARRL booth at the National Convention in Chicago in 1938. This was the 129th convention he had attended as a League representative, not counting hamfests and club meetings. Guy Wilson, **W9FL**, himself an old-timer, is at the left.

Hartford Yacht Club. A man of fraternal feeling, he was a Mason, an Elk, an O.R.T. He was a retired lieutenant in the Naval Reserve and a member of the NCR net — beside, of course, ORS, RCC and A-1 Operator. His favorite band was 80 c.w., his favorite occupation relay traffic, and until recent years his fist was of the very best.

HEBIE WAS no great radio inventor, no writer of fancy words, no elaborator of complicated organization schemes. He was a plain man, with a conservative business man's approach to practical problems, but possessed of a great love for his fellow man and a tremendous affection for amateur radio and his League. It was the fraternal side of our art, based on the simple and natural relations between people, which he made his own and in which he shone. You could not meet him and fail to know that that greeting and that friendly handclasp were real and sincere, that here was a man who liked you. No one could escape the realization that here was one who genuinely loved his amateur radio and the friends he made through it. It was as that great exemplar of the friendliness of the radio amateur that Art Hebert will be best remembered.

73, OM; CUL!

K. B. W.



Operating at **W1ES**. AH was an active amateur from 1908 onward, but we have no pictures either of his early stations or of his modern one. This one was taken in 1930.

Keying the Crystal Oscillator

And Some Observations on Blocked-Grid Amplifier Keying

BY BYRON GOODMAN,* WIJPE

THE subject of crystal oscillator keying is complicated somewhat by the differences in various crystals, tubes and circuits. All crystals do not key alike, some circuits are better than others, and different types of tubes in the same circuit behave differently. For these reasons, it is well-nigh impossible to set down any hard and fast rules about crystal keying that will apply in every case. However, work in the laboratory with the more common tubes and circuits has resulted in some general principles that can be applied to all crystal oscillators that are being adjusted for keying.

* Assistant Technical Editor, *QST*.

"Adjusting an oscillator for keying" is nothing new to the experienced amateur who uses several different crystals and has worked with the problem, but it may come as a shock to those who work on the premise that a crystal oscillator adjusted for maximum output need only be turned on and off rapidly with a key to affect good keying. As with self-excited oscillator keying, the best procedure for adjustment of a crystal oscillator seems to be first to adjust it so that it follows the key closely at quite high speeds, and then to introduce some filter to reduce the clicks to the degree necessary only for good communication at amateur code speeds. The better crystal oscillator circuits are all capable of keying speeds up to well over 100 w.p.m., but a keying circuit capable of handling this speed cleanly results in more key clicks than are necessary for the more normal speeds of from 20 to 35 w.p.m., and so some lag should be added.¹

One slight disadvantage of crystal oscillator keying is that, when several crystals are used (for different parts of the bands), the total current to the oscillator is not the same in every case. This means that a key filter adjusted for one particular voltage-current combination may introduce too little or too much lag on "make" and too much or too little lag on "break" when a different crystal (with different total oscillator current) is used. This is likely to be the case, since all crystals do not key best with the same tuning adjustment. It is, however, a fine point that is mentioned only to explain the apparent discrepancies some operators encounter.

As is the case with self-excited oscillators, cathode keying of a crystal oscillator seems to be more difficult to filter than power-supply keying (in the negative or positive lead). The time constant of the oscillator grid circuit has an effect on the keying, and simply adding a lag circuit at the key is not as effective as might be thought. The photographs in Figs. 5B and 5C show a comparison between the effectiveness of key filters in the cathode and negative leads of a crystal oscillator. Cathode keying has won popularity because, for the same oscillator, the sparking at the key and the voltage across the key is less than with power-supply keying. The obvious answer is, of course, to key a low-power circuit where these factors become unimportant.

Combination oscillators such as the Tri-tet

¹ Goodman, "Some Thoughts on Keying," *QST*, April, 1941.

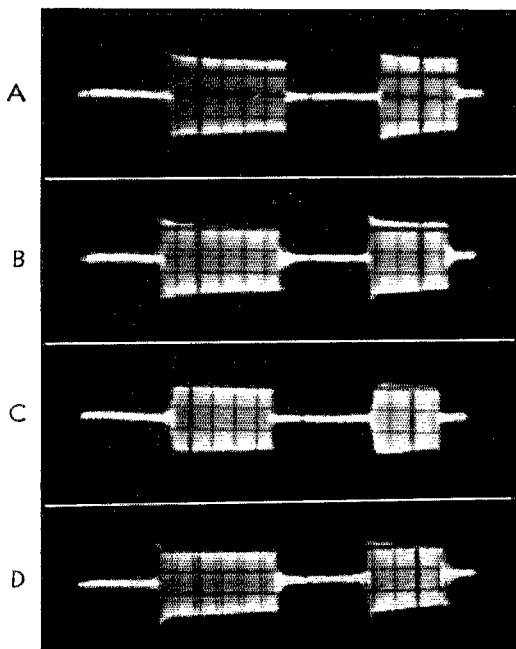

Fig. 1 — Some oscillograms of the keying of a grid-plate oscillator (see Fig. 3). The oscillator is keyed in the negative lead, with no key filter, so that the pure characteristic can be seen. A, B and C show a 6V6 grid-plate oscillator tuned for optimum keying, the high-frequency side and the low-frequency side of optimum, respectively. D shows a 6L6 substituted for the 6V6 and tuned for optimum.

(The oscillograms on these pages all show the second dot shorter than the first. This is caused by the 'scope sweep circuit not having a pure saw-tooth form, something that is often encountered at low frequencies.)

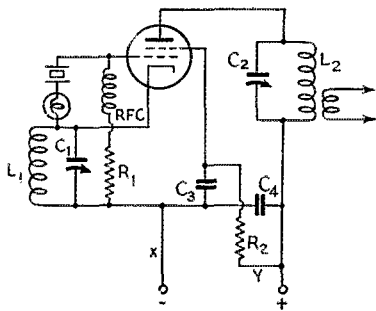

Fig. 2 — The Tri-tet oscillator. The value of C_3 will introduce some lag and thus reduce clicks if a well-screened tube is used. Negative high-voltage keying is done at "X," and screen-grid keying at "Y."

(Fig. 2) and the grid-plate oscillator (Fig. 3) that use the screen grid as the grounded anode in the oscillating circuit can, when used with well-screened tubes, be keyed satisfactorily in the screen circuit when doubling. If the plate voltage is too high or if the screening is poor, the crystal will oscillate weakly all of the time and discourage break-in work on one's own frequency, but the circuit has the advantage that the screen dropping resistor, R_2 , and the screen by-pass condenser, C_3 , serve as a filter that helps to reduce clicks. When adjusting for minimum clicks, the values of C_3 and another condenser across the key should be varied until the results are satisfactory. Well-screened tubes like the 6SK7, 6AG7 and the 10-watt pentodes are satisfactory in this application, but results with the more common beam tubes (6V6, 6L6) will be discouraging, since the crystal will oscillate continuously.

General Considerations

One sometimes sees crystal oscillator circuits with no r.f. choke in series with the grid leak across the crystal, but the slight saving in expense hardly justifies the improvement in performance that can be obtained by using the choke. Several circuits that gave mediocre keying with no choke showed a marked improvement when the choke was added. The same sort of improvement is obtained when the value of the grid leak is increased to 0.25 megohm or so, but this value of grid leak cuts down the output of the oscillator to a point where it is of little value. The use of the r.f. choke (and also a large value of grid leak) removes some loading from the crystal and leaves it freer to start oscillating. As "musts" for most crystal oscillator circuits that are keyed, it is recommended that the grid r.f. choke be included and the value of grid leak be made as high as possible consistent with adequate output to drive the following stage or, in the case of a single-stage transmitter, to give sufficient output without a compromise with good keying. The straight tuned-plate triode oscillator is an exception, and it is best operated with cathode bias only. Frankly,

we are at a loss to explain why the cathode-biased triode works better than one with leak bias while all of the other circuits are better with leak bias, but such seems to be the case, as Figs. 4A and 4B show.

Simply using an r.f. choke and a high value of grid leak is not enough to give good keying, of course. A suitable choke and condenser filter circuit must be used at the key, and the key should be used in the negative (or positive, if it's hard to get at the negative) lead, as described in the keying article last month.¹ The same principles apply to adjustment — more choke is used to remove the click on "make" and more condenser is used to remove the click on "break." It appears to be slightly more difficult to smooth out the keying of a crystal oscillator than of a self-excited oscillator, possibly because one is dealing with a partially mechanical oscillator instead of a purely electronic one, but in general it will respond to the same treatment.

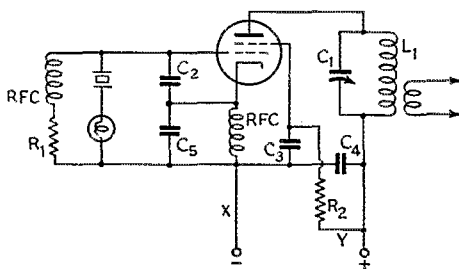

Fig. 3 — The grid-plate oscillator. The remarks about Fig. 2 also apply to this type of oscillator. C_2 should be 50 $\mu\text{fd.}$ and C_5 will range from 50 to 250 $\mu\text{fd.}$, depending upon the tube. Some versions of this circuit use only the input capacity of the tube for C_2 , but the addition of the small condenser is worth trying.

The oscillator should be capable of oscillating with only 3 or 4 volts on the plate, and an excellent test is to connect several dry cells in series for the plate supply to check this point. An oscillator that won't oscillate at a low plate voltage will drop in and out of oscillation with a "plop" as the voltage is increased from zero and decreased back again, and hence is not as suscepti-

Last month we presented a story pointing out some of the factors influencing the keying of amplifiers and self-excited oscillators. This follow-up article treats some of the considerations in crystal-oscillator keying and the blocked-grid keying of amplifiers (and keyer tubes) and, although it may not offer the cure-all for your particular problem, it may start you in the right direction towards clearing up your keying troubles.

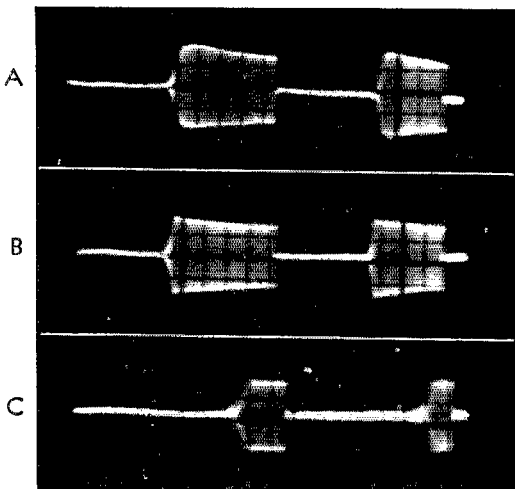

Fig. 4 — Oscillograms of a keyed 6C5 crystal oscillator. A shows the triode adjusted for optimum keying with a 10,000-ohm grid leak, B shows the triode with cathode bias and tuned for optimum keying, and C shows what happens when the cathode- (or grid-) leak biased triode oscillator is tuned too much to the low-frequency side of the optimum keying adjustment. The dots in C become light and the keying is somewhat erratic.

ble to key filtering as one that will work at a low voltage. Straight pentode oscillators and some triode oscillators will require additional feedback to make them oscillate at less than 10 or 15 volts. Under critical adjustment, the Tri-tet will oscillate with no apparent plate voltage when the circuit is closed (as is well known), but this is caused by the contact potential of the tube and the drop through the cathode circuit. The grid-plate oscillator (Fig. 3) will oscillate at very low voltages with proper proportioning of the cathode condenser, C_5 .

Another important factor in the adjustment of a crystal oscillator for best keying is that it be keyed while tuned. Electronic bug owners will find this a simple matter, while the straight key or mechanical bug owners will have to content themselves with sending a series of dots while tuning the oscillator. It is relatively easy to hit the best tuning adjustment by listening to the signal in the receiver, but one can end up with some rather horrible keying if he just tunes the oscillator for maximum output and then keys it. This is assuming, of course, that a proper key filter has already been installed and that the switch to a different crystal has just been made. The key filter constants can be determined in the same manner as described last month for self-excited oscillators. Be sure to listen with the r.f. gain of the receiver well reduced, else the receiver is likely to give too pessimistic a picture of the clicks.

If the oscillator circuit is one using a screen

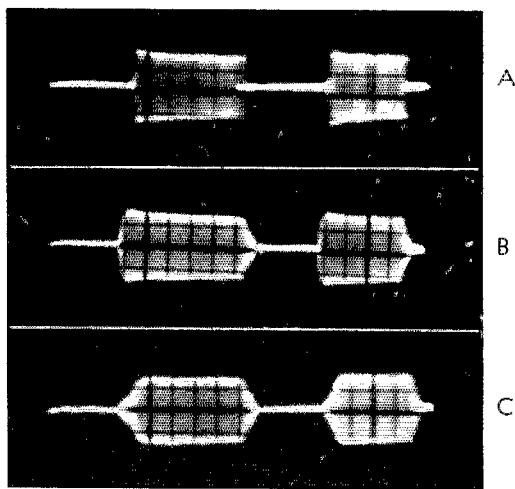

Fig. 5 — A 6AG7 leak-biased Tri-tet oscillator with the plate tuned to the fundamental frequency. A shows the oscillator tuned for optimum keying, and B shows the same with optimum key filter. Both A and B are keyed in the negative lead; C is keyed in the cathode with the same filter as B. Adding capacity to C did not extend the tail on "break" enough to reduce the click to a good value.

grid tube, the screen circuit should not be overlooked when adjusting for minimum clicks. The size of the dropping resistor is usually fixed by the screen operating voltage, but the size of the by-pass condenser can increase or decrease the clicks, depending upon the type of circuit. It is suggested that a 0.001 by-pass condenser be used right at the socket, for a short r.f. path, and then different values of shunting condensers can be tried at some more accessible point. Here again testing is most readily done by sending a steady string of dots and listening to the signal (with the b.f.o. turned off) while different values of screen by-pass condensers are tried. The screen adjustment is best made before the key filter is adjusted. The additional capacity should be added on the tube side of the dropping resistor, of course.

Loading has an effect on the keying of oscillators where the feedback is obtained from the plate circuit, as in the case of the straight tetrode or triode oscillators, but it doesn't seem to be very important in circuits like those shown in Figs. 2 and 3.

A conclusion from the work described in this article is that the regenerative type of crystal oscillator (Tri-tet and grid-plate) keys better than the straight triode, tetrode and pentode oscillators. Not only do they seem to work more uniformly with different crystals, but their optimum keying is more likely to occur at the maximum output point. It may very well be possible to make a triode or multi-element tube oscillator show similar results by adding additional feed-

back from plate to grid, but the Tri-tet and grid-plate oscillators are easier to control.

Grid-Block Keying

The use of a blocking voltage on the control (or suppressor) grid of a tube to cut off its output until the blocking voltage is removed by the shorting of the key, as shown in Fig. 6, is an excellent method of keying an amplifier. The resistor R_1 is the normal grid leak and R_2 is a resistor used to prevent the blocking-voltage supply from shorting when the key is down. The capacity C_1 is the normal r.f. by-pass plus any additional capacity necessary for a good keying characteristic. A nice feature of grid-block keying is that it requires no inductance to give a lag on "make," the lag coming from the time constant of C_1 discharging through R_1 . On "break," the constant is determined by C_1 charging through R_1 plus R_2 . Since the grid leak, R_1 , is determined by the tube that is being keyed, adjustment of a grid-block keying system consists of adding enough capacity across C_1 until the "make" is as soft as desired and then, if the "break" still shows some click, raising the value of R_2 until desirable keying is obtained. The same rule as set forth in the previous article applies—it is preferable to have a harder "make" than "break" for good copy at high speeds, and this is obtained automatically with grid-block keying. The same adjustment procedure applies to tube keyers (that use a blocking voltage) and to suppressor-grid keying.

Grid-block keying is most convenient in amplifier stages using high- μ tubes that aren't being driven too hard, since such stages will require a lower voltage for cut-off.

Unfortunately, grid-block keying does not work any too well with oscillators. It can be used, of course, but it isn't possible to get a soft "make" characteristic because the bias must be brought down to a value that gives a high enough mutual conductance before the tube will oscillate and it then plunges into oscillation in the usual

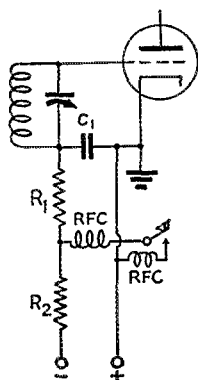

Fig. 6—Grid-block keying circuit. R_1 is the normal grid leak and C_1 is the r.f. by-pass condenser plus enough capacity to give a good keying characteristic. R_2 is included to prevent a short circuit of the blocking-voltage supply when the key is closed. Increasing the size of C_1 will make the keying "softer" on both "make" and "break," making R_2 larger will soften "break."

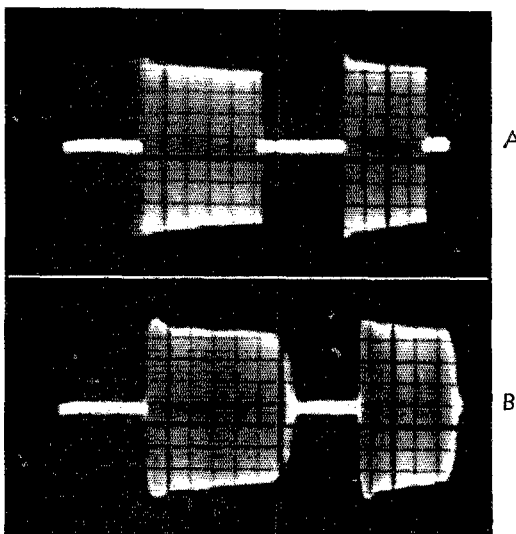

Fig. 7—Grid-block keying of an amplifier. A shows the characteristic with only the normal grid leak and r.f. by-pass condenser, B shows the addition of 0.1 μ fd. across the condenser. The clicks of B were very slight, with almost none at all on "break." Note that the addition of capacity in B has made the dots "heavier," requiring a slight readjustment of the key if a bug is used.

manner. Further, a soft "tail" is not added to the oscillator when grid-block keying is used as is added to an amplifier keyed this way. The closest approach is suppressor-grid keying of a Tri-tet or grid-plate oscillator, and these both require that the oscillator run constantly, prohibiting break-in on one's own frequency without elaborate shielding and neutralization.

Summary

In addition to the keying checks listed last month, the following applies specifically to keyed crystal oscillators.

1. Holding the key down and tuning the crystal oscillator for maximum output does not always give the optimum keying adjustment. Send a string of dots and tune the oscillator for best keying.
2. A crystal oscillator should be capable of oscillating with only 3 or 4 volts on the plate if it is to key well.
3. In adjusting the lag filter at the key, don't overlook the effect of the value of screen by-pass condenser if the oscillator is one that depends upon the screen for feedback (Tri-tet or grid-plate oscillator doubling or with well-screened tube).
4. Use an r.f. choke in series with the grid leak and as high a value of leak as is consistent with adequate output.
5. Don't be surprised if some crystals key better than others in the same circuit.

An Improved Electron-Coupled Oscillator

Negative Transconductance Circuit with Better Stability and Output-Circuit Isolation

BY D. F. METCALF,* W5ECF

IN RECENT years the justly-popular electron-coupled oscillator has attained a state of development such that, in the hands of an experienced amateur, it can easily satisfy all the requirements of an oscillator for amateur frequency control. These requirements, both mechanical and electrical, have been given excellent treatment by Brown,¹ and the purpose of this

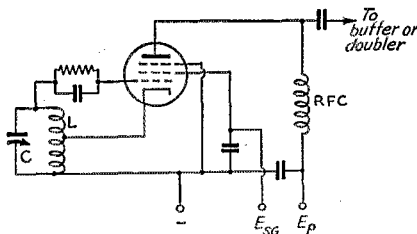

Fig. 1—Conventional electron-coupled oscillator. An undesirable feature of this circuit is the fact that the cathode is not at r.f. ground potential.

article is to present another type of electron-coupled oscillator circuit which not only meets these requirements, but in addition is free from certain undesirable effects present in the conventional form of the e.c. oscillator as shown in Fig. 1. This is the circuit employed in the majority of variable-frequency exciters presented in *QST* and by the various manufacturers. It is commonly used in conjunction with a buffer or doubler, followed by a straight amplifying stage. The oscillator to be described, while considerably less affected by variations in plate loading than the conventional electron-coupled oscillator, is still recommended for use with a buffer or doubler. These subsequent stages will not be considered here, however, as attention is to be focussed on the basic oscillator stage.

Probably the most undesirable feature of the oscillator of Fig. 1 is the fact that the cathode is not at r.f. ground potential. This connection is responsible for several effects, some of which are detrimental to frequency stability and some of which are merely annoying.

In the first place, the interelectrode capacitance between the heater and cathode is shunted across a portion of the frequency-determining grid tank.

*Geophysical Dept., Humble Oil and Refining Co., Houston, Texas.

¹Brown, G. M., "A Stabilized Variable-Frequency Oscillator," *QST*, July, 1940.

While this capacitance is only of the order of a few micromicrofarads, it is subjected to a large variation in temperature during the warm-up period, and during this time has an important effect on frequency drift. A further deleterious effect of this connection is the regeneration which occurs at harmonics of the grid-tank frequency owing to the fact that the grid tank carries current at both the fundamental and harmonic frequencies. This effect can be minimized by using a low L/C ratio in the grid tank and by the use of impedance coupling between the oscillator and the following stage, but is still not completely eliminated. And obviously it cannot be minimized by selecting a tube with extremely low grid-plate capacitance, since it is not primarily caused by this capacitance. This regenerative effect is not

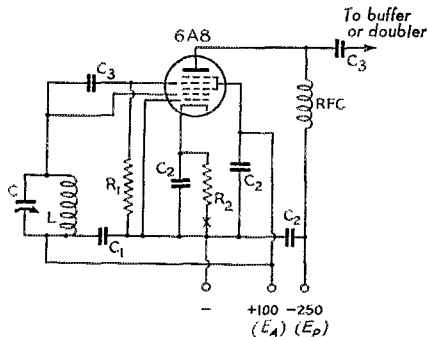

Fig. 2—Circuit diagram of the negative-transconductance electron-coupled oscillator.

- L, C—Frequency-determining grid tank.
- C₁, C₂—0.01 μ fd., at amateur frequencies.
- C₃—250 μ fd., at amateur frequencies.
- RFC—2.5-mh. r.f. choke, at amateur frequencies.
- R₁—0.25 megohm, $\frac{1}{2}$ -watt.
- R₂—500 ohms, $\frac{1}{2}$ -watt.

present in the electron-coupled oscillator to be described.

Another undesirable feature of the circuit of Fig. 1 is that the position of the cathode tap on the grid tank is critical. It not only has an important effect on the frequency stability of the oscillator with respect to supply voltage variations, but it can also be the cause of parasitic oscillations; and the necessity for the tap and for its adjustment in the first place is a nuisance. (Anyone ever having attempted to tap between the pies of a type R-100 r.f. choke can appreciate this.)

Negative Transconductance Oscillators

The oscillator presented in this article is shown in Fig. 2; it is similar to a circuit used by H. R. Heese (*RMA Engineer*) and operates with both the screen grid and the cathode at r.f. ground potential, thus eliminating the regenerative effect mentioned above. At the same time, it retains all the advantages of electron-coupling. It oscillates by virtue of the fact that the transconductance of the signal grid (G_4) of the 6A8 with respect to the oscillator anode (G_2) is negative. This negative transconductance characteristic is shown in Fig. 3, for the operating conditions of Fig. 2. At a signal grid bias of -5 volts, the negative transconductance is around -350 micromhos, as indicated on the figure. The a.c. resistance of the oscillator anode for these conditions is around $16,000$ ohms.

The dynamic action of a negative transconductance tube (or "transitron," after Brunetti²) is similar in most respects to that of an ordinary triode, with the exception, of course, that the transconductance of the ordinary triode from control grid to plate is positive. The operation of the transitron oscillator can be most easily understood by considering the transitron as an ordinary Class-A amplifier. Referring to Fig. 4, the plate tank is assumed to be tuned to the frequency of the impressed signal, and the grid-plate interelectrode capacitance is neglected. Then, if the tube VT is an ordinary triode, possessing positive transconductance, it is apparent that the r.f. voltage appearing across the LC tank is exactly 180° out of phase with the voltage at the grid. But on the other hand, if VT is a negative transconductance tube, the r.f. voltage across the tank will be *in* phase with the signal voltage on the grid; consequently, all that is necessary to convert Fig. 4 into an oscillator for the case when the transconductance is negative is to directly (i.e., capacitively) couple the control grid to the

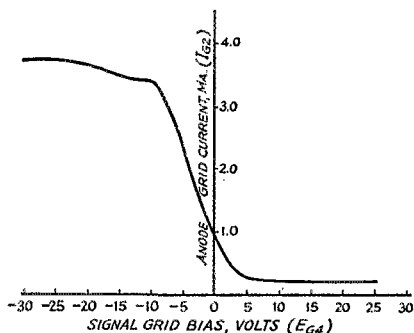

Fig. 3 — Static negative-transconductance characteristic of the 6A8. At a signal-grid bias of -5 volts, the slope of this characteristic is about -350 micromhos.

Plate voltage, 250 volts.
Oscillator anode voltage, 100 volts.
Screen grid voltage, 100 volts.
Oscillator grid voltage (G_1), -5 volts.

A two-terminal oscillator circuit with true electron coupling between oscillator and output, avoiding the common cathode impedance characteristic of the ordinary e.c.o. Excellent voltage-frequency characteristics, and easy to adjust for optimum performance.

plate and replace the generator by a grid-leak, whereupon the circuit becomes self-exciting and oscillates at the resonant frequency of the LC tank.³ An inspection of Fig. 2 will show that this is precisely what is done here, the signal grid of the 6A8 being the "control grid" and the oscillator anode being the "plate." The actual

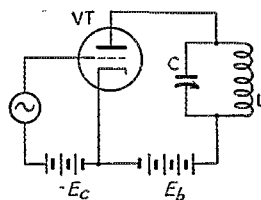

Fig. 4 — In this circuit, if the grid-plate transconductance of VT is negative, the r.f. voltage across the LC tank will be in phase with the signal voltage at the grid. To convert the circuit to an oscillator, all that is necessary is to capacitively couple the grid and plate and replace the generator by a grid-leak. Such an oscillator is called a transitron oscillator.

plate of the 6A8 has a negligible effect on the operation of the oscillator section of the tube. A complete study of the negative-transconductance oscillator is not within the scope of this article, and for the reader who desires further information as to the various characteristics of the transitron, several references are given below.^{2, 4, 5, 6}

Design Considerations

The simplicity of the oscillator shown in Fig. 2 is such that no special precautions are necessary

² Brunetti, C., "The Transitron Oscillator," *Proc. I.R.E.*, Feb., 1939.

³ Strictly speaking, it is also necessary that the resonant impedance of the plate tank be higher than a certain critical value, below which the net amplification of the tube and tank is insufficient to sustain oscillation when the grid is coupled (capacitively) to the plate. This critical value of tank impedance depends only on the (negative) transconductance of the tube and the dynamic anode resistance of the oscillator anode. For the circuit conditions of Fig. 2, this minimum resonant tank impedance can be calculated to be about 3400 ohms. The resonant impedance of the frequency-determining tank circuits commonly used in e.c. oscillators is seldom less than $10,000$ ohms.

⁴ Brunetti, C., "Clarification of Average Negative Resistance with Extensions of its Uses," *Proc. I.R.E.*, Dec., 1937.

⁵ R.C.A. Application Note, No. 45, Feb., 1935. (Abstracted in *QST*, April, 1935.)

⁶ Herold, E. W., "Negative Resistance and Devices for Obtaining It," *Proc. I.R.E.*, Oct., 1935.

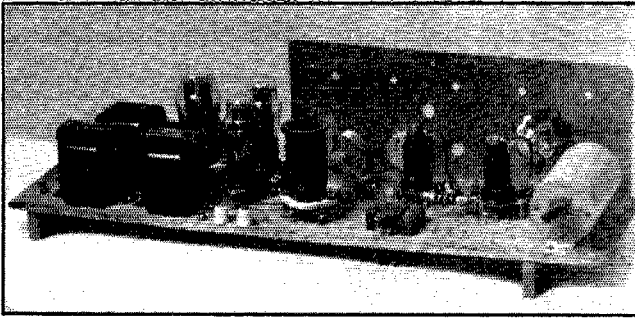

An experimental breadboard layout of the low-power exciter used for transmitter frequency control at W5ECF. The 6A8 oscillator at the right employs the circuit of Fig. 2; the 6J7 doubler to the left of the oscillator is conventional. The shield can at the right contains the oscillator tank coil, the fixed portion of the tank condenser, and an air trimmer. Stiff wiring in the tank circuit is avoided to reduce vibration.

to insure satisfactory operation. A tank circuit of good electrical and mechanical design is essential, as in any oscillator, and anyone desiring further information along these lines is referred to two able treatments by Perrine⁷ and Brown.¹ The supply voltage shown for the oscillator anode and the screen grid of the 6A8 is 100 volts, in accordance with the manufacturers' recommendation for the use of the tube in frequency converter service. Likewise, the plate voltage shown is 250 volts; both of these supply voltages should be well regulated, and the VR type of gas-filled regulator tube is well suited to this purpose. Satisfactory keying can be obtained by inserting the key at *x*, Fig. 2, and shunting its terminals with a resistor of from 5000 to 10,000 ohms ($\frac{1}{2}$ -watt rating).

An experimental low-power exciter using the

⁷ Perrine, "An Answer to the E.C.O. Problem," *QST*, Sept., 1939.

6A8 negative-transconductance oscillator and a 6J7 doubler is shown in the photograph. The cylindrical shield can at the extreme right (as viewed from the rear) contains the oscillator tank coil, the fixed tank condenser (silvered mica), and the air trimmer. The band-spread condenser is mounted on the panel a little to the left of the shield can. Proceeding from right to left, the 6A8 oscillator is seen next, then the 6J7 doubler, and then the doubler plate coil and condenser. Farther on to the left, the VR-150 and VR-105 gas regulator tubes are seen, and the power supply occupies the remaining one-third of the baseboard space. The power transformer is located at the extreme left end of the baseboard.

Fig. 5 shows the circuit diagram of the exciter. It will be noted that the oscillator portion of the circuit is exactly the same as Fig. 2. The 6J7 doubler is conventional. Cathode keying in the oscillator is used, as indicated on the diagram.

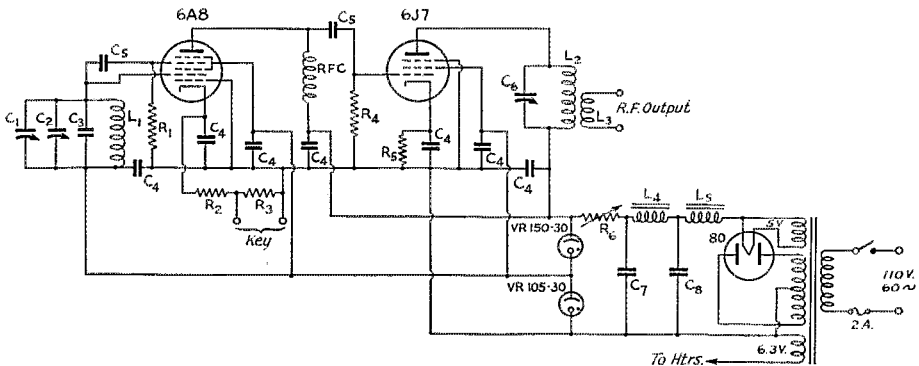

Fig. 5 — Circuit diagram of the 6A8-6J7 exciter.

- C₁ — 50- μ fd. midget variable (tuning).
- C₂ — 20- μ fd. air trimmer.
- C₃ — 500- μ fd. silvered mica (in two units).
- C₄ — 0.01- μ fd. mica.
- C₅ — 250- μ fd. mica.
- C₆ — 150- μ fd. doubler tuning.
- C₇, C₈ — 8- μ fd. electrolytic, 450-volt.

- R₁ — 0.25 megohm, $\frac{1}{2}$ -watt.
- R₂ — 500 ohms, $\frac{1}{2}$ -watt.
- R₃ — 5000 ohms, $\frac{1}{2}$ -watt.
- R₄ — 0.1 megohm, $\frac{1}{2}$ -watt.
- R₅ — 500 ohms, $\frac{1}{2}$ -watt.
- R₆ — 1500-ohm, 10-watt, adjustable. (Adjust to 30 ma. through VR-150 regulator tube.)
- RFC — 2.5-mh. r.f. choke.
- L₁ — 30 turns No. 22 enameled;

- in. diam.; winding length, 1 in.
- L₂ — 24 turns No. 22 enameled; 1 $\frac{1}{2}$ in. diam.; winding length, 1 $\frac{1}{2}$ in.
- L₃ — 3-turn link.
- L₄, L₅ — 15-hy., 40-ma. filter choke.
- T — Power transformer, 300 volts d.c. at 40 ma. Fil. windings: 6.3 v. at 2 amp.; 5 v. at 3 amp.

The oscillator tank coil is solidly mounted and permanently wired into the unit. It is wound to tune to 1.75 Mc. with condenser C_1 at maximum capacity, and about 1.84 Mc. with C_1 all the way out. The fourth and eighth harmonics of the oscillator frequency then cover the 40- and 20-meter bands, respectively, for which the exciter was intended.

Other Circuits

Another oscillator circuit employing negative transconductance is shown in Fig. 6. In this circuit the transconductance of the suppressor of the 6J7 with respect to the screen grid is about -250 micromhos, for the operating voltages shown. This is essentially the circuit studied by Herold and Brunetti,^{2, 4, 5, 6} and is an excellent oscillator for a frequency meter and in other services where the external coupling to the oscillator is very light. It is less suitable for transmitter frequency control than the oscillator of Fig. 2, since it does not possess the electron-coupling feature. It can be used to advantage, however, in conjunction with an automatic amplitude control circuit in which the control grid of the 6J7 is biased by the output of a rectifier connected across the tank. The oscillator grid (G_1) of the 6A8 in Fig. 2 could similarly be used in an a.a.c. arrangement, but it does not possess quite enough control over the oscillation amplitude to produce a really effective amplitude limitation action without preliminary amplification of the a.a.c. bias.

The circuit of Fig. 6 can be converted into a novel crystal oscillator by substituting a crystal for the coupling condenser C_2 and tuning the LC

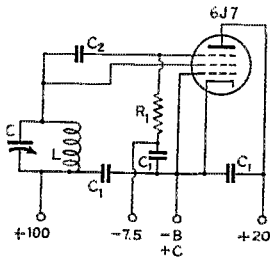

Fig. 6—Circuit diagram of a 6J7 in a negative-transconductance oscillator circuit. The transconductance of the suppressor of the 6J7 with respect to the screen grid is about -250 μ mhos. for the operating voltages shown. This circuit does not have the electron-coupling feature of the oscillator of Fig. 2; the plate is at a low d.c. potential and functions only to collect stray electrons passing through the suppressor grid. Cathode bias can be used with this circuit to provide the negative bias for the suppressor; a 1000-ohm cathode resistor ($\frac{1}{2}$ -watt rating and suitably by-passed for r.f.) is satisfactory. The control grid (G_1) is then tied to the cathode and R_1 returns to ground (B-).

C_1 — 0.01 μ fd. at amateur frequencies.
 C_2 — 250 μ fd. at amateur frequencies.
 L, C — Frequency-determining tank.
 R_1 — 0.25 megohm, $\frac{1}{2}$ -watt.

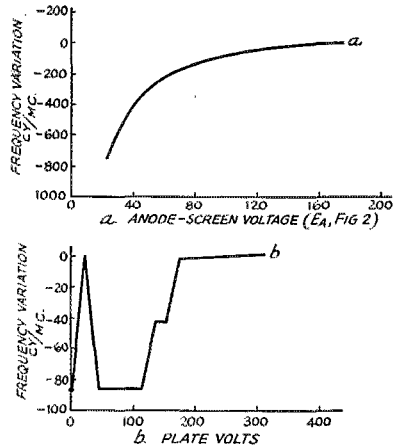

Fig. 7—Frequency stability characteristic of the oscillator of Fig. 2. Curve *a* shows the effect of a variation of anode-screen supply voltage (E_a , Fig. 2), with plate voltage fixed at 250 volts. Curve *b* shows the stability with respect to plate voltage, the anode-screen voltage being fixed at 100 volts. In the former case the stability is about the same as obtained with screen-grid voltage variation in the conventional e.c.o., with optimum setting of the cathode tap. In the case of plate voltage variation, however, the stability is considerably better than that of the conventional e.c.o. A variation in plate supply voltage from 175 to 310 volts produces a frequency variation estimated at about 2 cycles per megacycle. Nominal oscillation frequency, 3.5 Mc.

circuit to the crystal frequency (as indicated by maximum d.c. suppressor current). In a similar manner, the oscillator of Fig. 2 could be converted into an e.c. crystal oscillator by substituting the crystal for the coupling condenser between the signal grid and the oscillator anode. With either of these arrangements, the crystal oscillates at essentially its resonant frequency, as contrasted to the conventional pentode crystal oscillator in which the crystal oscillates at approximately its antiresonant frequency. A resistance of suitable value could be substituted for the LC tank in these circuits; at the higher frequencies, however, the output with this arrangement is greatly reduced, and above a certain limiting frequency crystals with average activity refuse to oscillate.

Performance

The following data were taken from the oscillator section of the exciter shown in the photograph, with the oscillator tank coil replaced by a coil tuned to approximately 3500 kc.:

Tank inductance: 4.1 μ hy.

Tank capacitance: 500 μ fd., approx.

Plate load: 2.5 mh. r.f. choke (National R-100).

Oscillation voltage across tank, 13 volts, peak.

Anode grid and screen grid currents, 8 ma. total.

Plate current, 2 ma.

Supply voltages as in Fig. 2.

(Continued on page 74)



IN THE SERVICES



IN RECENT months thousands of American amateurs have left their keys and microphones at home and gone to work for Uncle Sam. They are rendering service in every conceivable niche of the communications end of the great national defense effort — as operators, engineers, technicians, mechanics. They have become the mouth and ears of the military services, the brains and hands of the laboratories and factories supplying defense equipment. To record their participation in the present national defense program will be the purpose of this column.

To you sitting watch on a Navy battlewagon....to you tracking down illegal operations for the F.C.C.....to you pounding out observation reports from the rear cockpit of an O-46...to you designing special gear for the Signal Corps....to you teaching code and theory to recruits....to all amateurs who are lending their services to aid in the national defense, we dedicate this monthly space in *QST*.

We wonder if crime will run rampant in Columbus, Ohio, now that former district attorney L. G. Windom, W8GZ-ZG, has gone on active duty as Lt. Colonel at Camp Shelby, Miss.

John Gill, W4GMR, is on duty at the Coast Guard air station at South San Francisco. . . . W3HZU, W4DGJ and W4BC are communications lieutenants in the Air Corps stationed at Ponce, P. R., Fort Knox, Ky., and Langley Field, Va., respectively; all were previously members of the A.A.R.S. . . . Sgt. Vernon Kimball, W5FPV, pounds brass for the Air Corps at WYYH, Homestead Field, Hawaii, and awaits a K6 call. . . . Students at Scott Field, Ill., are learning a.c. theory from John Specialny, W3HIX. . . . Up in one of the B-18's maneuvering high over Hickam Field, Hawaii, you will find Bernard Sedlacek, W9GKK, pounding out observation reports to Lt. Schwartz, W6SSM, on duty at the field's radio station. . . . At Camp Beauregard, La., Master Sgt. Fulkerson, W8IHT, troubleshoots any aircraft radio equipment which might act up, while OM Bretelson, W8TMC, has the same duty at Wright Field, Dayton. . . . Cpl. John Carroll, W3IIL, works aircraft in flight from the Air Corps station at Bolling Field, D. C.

The roster of the Tuboro Radio Club has been somewhat depleted by the enlistment of seven of its members: W2BVE and HBO are Naval Reservists stationed at Floyd Bennett Field, while W2HPB at the San Diego school studies

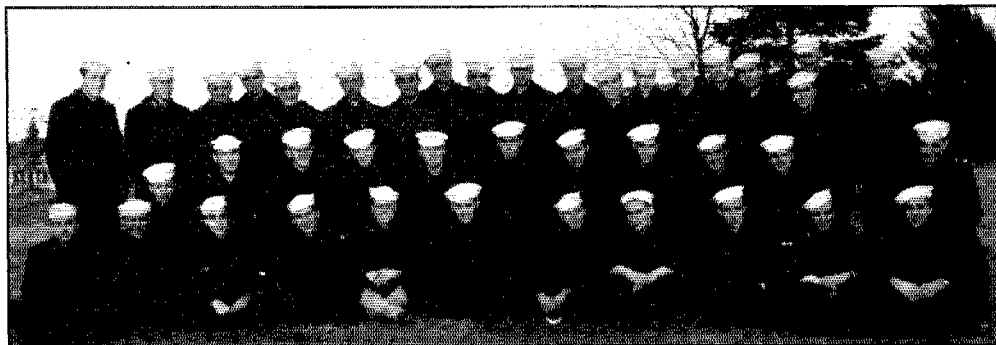

In early March the U. S. Naval Reserve Radio School at Noroton Heights, Conn., graduated its first class of 431 Radiomen 3d Class. The group included 43 licensed amateurs, who assembled for this photograph — probably including some friends of yours.

Front row, l. to r.: J. L. Junior, W2HPS; J. Rossnick, W2LAW; V. Musso, W2NMV; R. L. Perry, W8KDX; M. Blumkin, W2MIF; F. Reiner, W2CWX; R. P. Gooding, W1LDV; M. Krichick, W2IVP; E. D. Gillen, W2NAL; A. Gura, W1LRW; W. A. Langley, W2HYN. *Middle row, l. to r.:* J. H. Schneer, W2JKP; W. F. Hemenway, W8STC; J. R. Rounding, Jr., W1LZS; B. H. Rubin, W1MQL; W. J. Ziner, W2MMY; A. L. Ehramjian, Jr., W2LXD; N. Seechik, W2JEN; A. W. Horanzky, W3EHX; F. M. Fabian, W1LJE; J. J. Sexton, Jr., W1MTM; J. F. Goveia, W1LOB; E. H. Wechsler, W2KCU; H. Labrie, W1IOT. *Standing, l. to r.:* A. A. Rosenthal, W2IXO; H. V. Smith, W2LFL; Wm. D. Moehring, W2MSU; R. Myers, W2IWM; M. A. Felt, W2GYO; F. J. Ritter, W3HSZ; I. B. Stirberg, W2LRD; U. Manfredi, W2KKX; P. D. Marshall, W5HNY; M. F. O'Keefe, W2KTS; R. H. Abeles, W2LMR; L. P. Fournarakis, W3ISO; D. F. Ingalls, W1IHE; T. S. Trimmer, W2HMM; E. B. Edberg, W2FQW; W. G. Austin, W1LBW; F. H. Shorkley, W2HIE. Not included in this photograph, but also attending the first class, were J. F. Costello, W2MBB; and W. Catcher, W2KWO.

The first class contained 43 hams, the second has 66. The entire instruction staff is made up of reservists on active duty, some of them former service men, and most of them amateurs present or past. In this photograph of the 1940-41 instruction staff are, front row, l. to r.: Lieut. Commander H. F. Breckel; Lieut. F. R. L. Tuthill; Lieut. W. F. Grogan, ex-40Y; Ensign D. C. S. Comstock, W1MY; Ensign R. W. Percy, W8DZU; Ensign E. L. Battey, W1UF; Lieut. (jg) Perce B. Collison, W2IXE. Rear row, l. to r.: Archie Bunting, CRM, W2ISJ; C. E. Johnson, CRM; Frank B. Fucile, CRM, W8GZS; J. L. Moretti, CRM, W2IOH; L. F. St. Amand, CRM.



The largest of the Navy's new Naval Reserve Radio Schools is at Noroton Heights, Conn. Giving a four months' course, it graduated its first class of 431 students the first of March and immediately started work on a new group of 450.

hard for an assignment; W2KIK is a first-class private in the Signal Corps at Ft. Monmouth; Cpl. W2KNL is assigned to the Q.M.C. at Malone, N. Y.; W2HVD keeps track of supplies on the U.S.S. *Illinois*; and W2BOT is on active naval duty in New York City.

West Pointer Lawrence Sheetz, W8MII, is studying in the officer's training course at Ft. Monmouth's signal school. . . . At the same location, Capt. "Web" Soules is doing research work and awaiting a W2 call in lieu of W9DCM. . . . Also there are Vernon Russell, K6SMD, doing intercept radio work, and Pvts. Houldsworth, W1KVN, and Chertak, W3GRF, in the signal school. . . . Over at Fort Hancock we find Master Sgt. John Geddes, W2DAT, and Staff Sgt. George Longobardi, W2MFB, handling the post radio station for the 245th Coast Artillery.

Southeastern Division Assistant Director Leland Smith, W4AGI, is a lieutenant stationed at the Norfolk Navy Yard. . . . W2FAR, GGW and KHN are reservists on active duty assigned

to the Navy's d.f. station at Amagansett, L. I., N. Y. . . . CRM Bellis, W6DBK, handles one of the watches at NPG, Los Angeles. . . . RM2C Frank Walczak, W8QCH, is in charge of radio aboard the U.S.S. *Linnet*, an auxiliary minesweeper. . . . Former SCM Bannie Stewart, W4CE, is now Lt. (jg) and assistant radio officer on the U.S.S. *Wasp*, Atlantic fleet. . . . Back from the Ellsworth Antarctic Expedition, CRM Fred Seid, W2MQ, is inspecting radio material at the Brooklyn Navy Yard.

Among many N.C.R. men now on duty in the nation's capital we find Ray Ewing, W4FGW, former SCM Arthur Braun, W9TE, and Bill Conklin, W9BNX. . . . Here we should also mention that Lt.-Comdr. John Reinartz, W1QP, is in charge of N.C.R. work, while Maj. David Talley, W2PF, has similar duties for the A.A.R.S. . . . W3JCQ is Lt.-Comdr. Charles Green of the Coast and Geodetic Survey.

Richard L. Tester, W9FAI, and Karl Pfoil, W8FKO, are helping the F.C.C. national defense

(Continued on page 70)

RED CROSS EMERGENCY TEST

APRIL 4-5-6

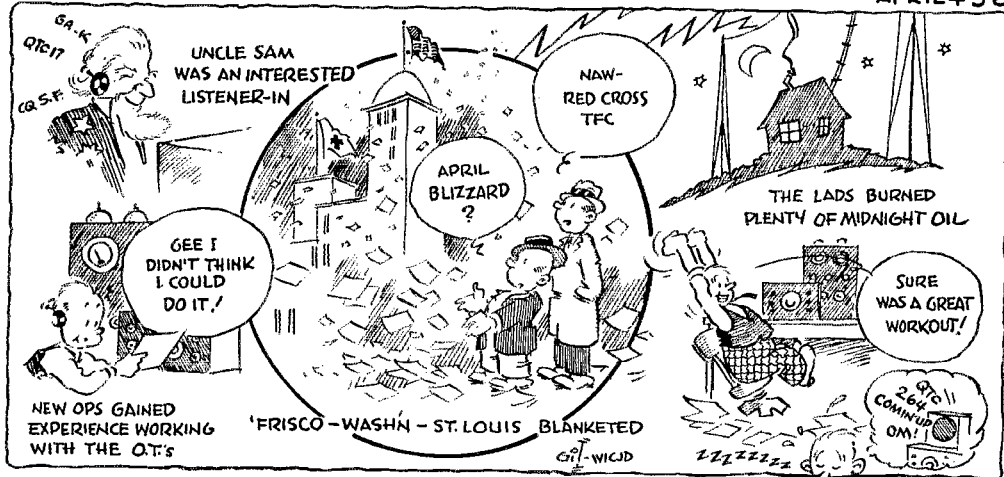

• For the Junior Constructor —

Low-Power 112-Mc. Transmitter-Receiver

A Complete Station for the U.H.F. Newcomer

ALTHOUGH a transceiver that uses a single tube as both transmitter oscillator and receiver detector is doubtless the simplest form of u.h.f. equipment, it is far from the most satisfactory. The receiver usually radiates as much as the transmitter unless some provision is made for tightening the antenna coupling in the "send" position, and usually the output of the transmitter is but a fraction of a watt. The rig to be described is an attempt to circumvent some of the disadvantages of a transceiver by including separate transmitter and receiver units, with the result that better performance is obtained in both the "send" and "receive" positions. The cost is not much greater than that of a transceiver, since the additional expenditure is only for another receiving-type tube, a tuned circuit and a few associated parts.

The circuit diagram is shown in Fig. 1. For receiving, a 7A4 superregenerative detector is used working into a 6F6 audio amplifier. No provision is made for controlling the regeneration of the detector by changing the plate voltage, but the detector is adjusted for the antenna in use by tuning the antenna circuit. This results in smooth superregeneration over the band once the adjustment has been made. The bandwidth of the receiver can be adjusted to give good coverage across the dial. When transmitting, a 7N7

dual triode (similar to two 6J5's in the same envelope) is used in the push-pull Hartley circuit, modulated by the 6F6. With a 250-volt supply to the set, 6 or 7 watts can be run to the 7N7 and the full audio output of the 6F6 can be utilized. Since the transmitter and receiver have their own tuned circuits, it is not necessary for the transmitter and receiver to be on the same frequency, as is the case with a transceiver.

Although separate receiving and transmitting antennas could be used, the same antenna is most commonly used for receiving and transmitting, particularly when it is one with some directional characteristics, and so an antenna change-over switch is included on the set. Switching from "receive" to "send" and back again is done by turning the switch on the panel and throwing the antenna switch simultaneously. The antenna switch can be mounted on the wall or table just as conveniently as on the back of the set if in a permanent installation and if that is considered by the operator to be more convenient.

Construction

The gear is all mounted on a 5- by 10- by 3-inch black ripple chassis. The first step in laying out the gear is to mount the transmitting tuning condenser, C_3 , on the side of the chassis on small brass pillars $\frac{5}{8}$ -inch long, centering the con-

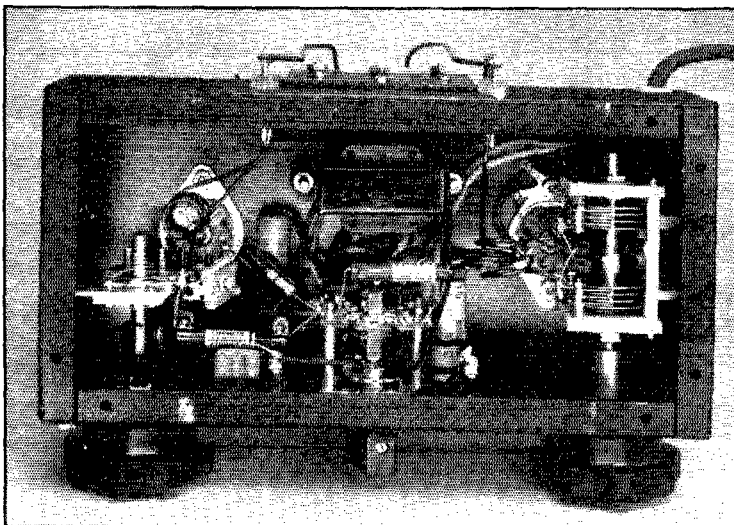

The arrangement of parts under the chassis can be seen in this photograph. The receiver circuit is at the left and the transmitter at the right. The transceiver transformer mounts on the same screws that hold the modulation transformer to the top of the chassis but it is raised above the metal by small studs. Note the method of supporting the receiver tuning condenser by means of a small brass strap fastened to the side of the chassis. The transmitter tuning condenser is supported off the side wall by four studs.

A complete 112-Mc. station for the low-power u.h.f. man. The 7N7 oscillator tube is at the left and the 7A4 detector is at the right, with the 6F6 common modulator and audio amplifier in the center. The modulation transformer is behind the 6F6 and below the antenna change-over switch. On the panel, from left to right: transmitter tuning, microphone jacks, send-receive switch, head-phone jacks, and receiver tuning. The power supply cable is brought out at the rear of the chassis.

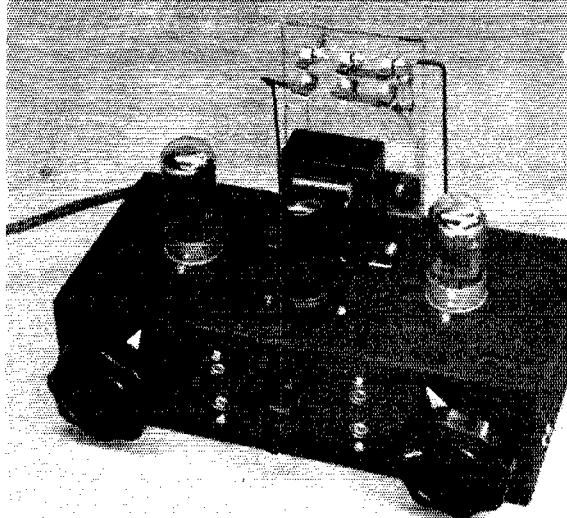

denser on the side wall so that the shaft will come out half-way up on the front panel. The low-loss bakelite loktal socket for the 7N7 should be mounted on the center line running down the chassis in such a position that the Nos. 3 and 6 pins are exactly under the stator terminals of the tuning condenser. The 7A4 socket is next mounted the same distance in on the other end of the chassis, and the detector tuning condenser, C_1 , is mounted on a bracket made of strap brass so that its shaft will project out to a point on the panel the same distance in from the edge as the shaft of C_3 . The 7A4 socket should be mounted so that the Nos. 1 and 8 pins are facing the front of the chassis.

The receiver tuning condenser has all but one rotor and one stator plate removed, a job that is easily and quickly done with a pair of long-nosed pliers. The transmitter tuning condenser is made more symmetrical electrically by removing the center shield and fastening two small straps of spring brass to the end-plate spacer bars. These two springs make contact to the center of the

rotor shaft, and a lead soldered to one of them is later connected back to the ground point on the 7N7 tube socket. No connections are made to the ends of the rotor. Bakelite shaft coupling extensions are used to extend the shafts of the two tuning condensers out through the panel and to insulate the knobs from body-capacity effects.

The 6F6 socket and the modulation transformer are mounted at the center of the chassis in a position that balances up their appearance. The transceiver transformer, T_1 , mounts under the chassis on the same bolts that hold the modulation transformer, and it is mounted above the

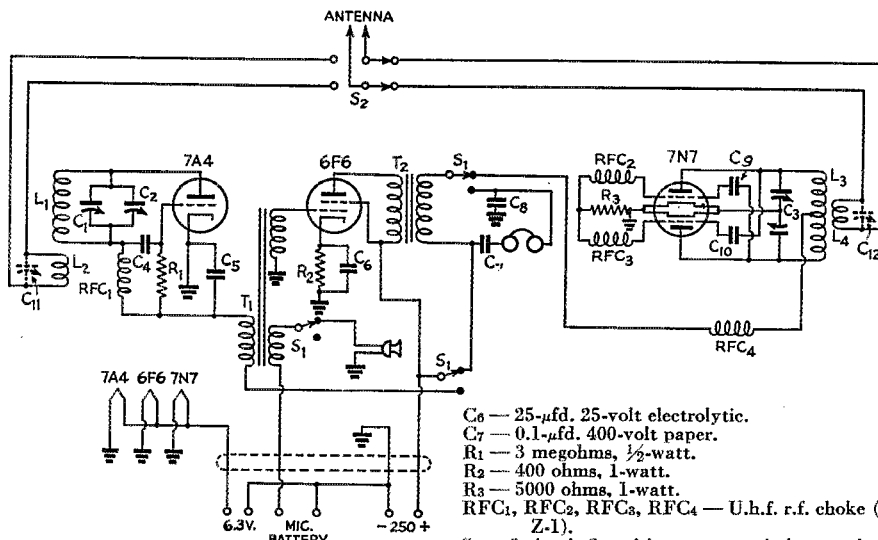

Fig. 1 — Wiring diagram of the 112-Mc. transmitter-receiver.

- C_1 — 5- μ fd. midget variable (National UM-15 with all but one rotor and one stator plate removed).
- C_2, C_{11}, C_{12} — 3-30 μ fd. mica padder (National M-30).
- C_3 — 25 μ fd. per section dual (Cardwell ER-25-AD) modified. See text.
- C_4, C_9, C_{10} — 50 μ fd. mica.
- C_5, C_8 — 0.001 μ fd. mica.

- C_6 — 25- μ fd. 25-volt electrolytic.
- C_7 — 0.1- μ fd. 400-volt paper.
- R_1 — 3 megohms, $\frac{1}{2}$ -watt.
- R_2 — 400 ohms, 1-watt.
- R_3 — 5000 ohms, 1-watt.
- RFC1, RFC2, RFC3, RFC4 — U.h.f. r.f. choke (Ohmite Z-1).
- S_1 — 3-circuit 2-position rotary switch, non-shorting.
- S_2 — D.p.d.t. knife switch with polystyrene insulation. See text.
- T_1 — Transceiver transformer (Stancor A-3833).
- T_2 — 6L6 modulation transformer (Stancor A-3871).
- L_1 — 3 turns No. 14 enam., $\frac{1}{2}$ -inch diam., spaced diam. of wire.
- L_2 — 3 turns No. 14 enam., $\frac{1}{2}$ -inch diam., close wound.
- L_3 — 2 turns No. 14 enam., $\frac{3}{4}$ -inch diam., spaced $\frac{1}{2}$ inch.
- L_4 — 2 turns No. 14 enam., $\frac{1}{4}$ -inch diam., spaced wire diam.

metal on half-inch studs to allow the wires from the modulation transformer that come through the chassis to clear the transceiver transformer. The 6F6 socket is mounted with the key slot towards the transmitter end of the chassis.

The antenna changeover switch is made from a small porcelain-based d.p.d.t. knife switch. A piece of $\frac{1}{8}$ -inch thick Millen Quartz-Q (or any other similar polystyrene) has a $\frac{3}{8}$ -inch wide strip sawed off one end and then the remaining piece is sawed in half to give two identical pieces. Part of the narrow strip is used to replace the fiber crosspiece on the two switch blades. One of the larger pieces is drilled for the switch blades and jaws, using the old porcelain base as a template, and the switch hardware is mounted on this piece. Large holes are drilled in the other piece of polystyrene to pass over the round heads of the screws holding the hardware, and the two pieces are then fastened together by spotting one piece with polystyrene cement and pressing the two pieces together. They can then be clamped in a vise and left while the cement hardens. A thick piece of $\frac{1}{8}$ -inch polystyrene can be used if it is available, but the screws that come with the knife switch will not be long enough to pass through the material and longer ones will have to be substituted. The knife switch can be made to work smoothly by judicious applications of vaseline to the jaws and pivots. A piece of aluminum, painted black if some paint is handy, is used to mount the polystyrene to the back of the chassis. The switch can well be left off, however, until the rest of the set has been wired and tested. Four National TPB polystyrene bushings are mounted on the rear of the chassis to support the antenna coupling coils and to furnish feed-through points to the antenna switch.

The tuning condensers and send-receive switch are best left off until most of the wiring at the sockets has been done. The lugs on the 6F6 socket must be bent flat to clear the switch lugs. One side of each heater is grounded to the metal ring that holds the socket, and the other heater terminals are connected together with a wire. The r.f. chokes and resistor in the grid circuit of the 7N7 are mounted flat on the chassis, making sure that they are insulated from the chassis and yet will clear the transmitter tuning condenser when it is in place. A few pieces of spaghetti tubing and some cellophane scotch tape will help to insulate these parts and still hold them tightly in place. After the heater and cathode connections have been made to the sockets, and the oscillator grid chokes and leak are in place, the two oscillator grid condensers should be fastened to the socket in such a position that they will come up between the two stator sections of C_3 when it is put in place. The send-receive switch, S_1 , can then be installed and most of the wiring done to it. Then the tuning condensers can be put in place and the rest of the wiring completed. For convenience in wiring, the common ends of

RFC_1 , R_1 and C_5 are brought to an unused pin on the send-receive switch.

When the coils have been wound and soldered in place, the simplest way to adjust them for the correct frequency range is to use someone else's calibrated receiver to check your frequency. The receiver tuning range is adjustable by changing the capacity of the trimmer, C_2 , but the transmitter can only be adjusted by changing the size of the coil if its range doesn't include the 112-Mc. band. Since only two turns are used, the value of inductance is best changed by varying the diameter slightly. If the calibrated receiver can pick up the transmitter and receiver radiation there is nothing much to worry about as far as the frequency range goes. A small absorption-type wavemeter can also be used to check frequency. If none of these methods is available, one will have to resort to Lecher wires, as described in the *Handbook*.

The output of the transmitter should be sufficient to light a small dial lamp connected across the antenna terminals. Upon speaking or whistling into the microphone the brilliance of the lamp should increase. If it decreases, it indicates that the coupling is too tight, and the coupling loop, L_4 , should be moved out of L_3 slightly until the transmitter modulates "up." The receiver should give a steady hiss in the headphones when no signal is being received, and the antenna circuit should be tuned so that this is a smooth hiss without any raspiness. This is its most sensitive operating point, and time spent in adjusting for this condition will be repaid in results.

It is only necessary to use enough microphone voltage to give a fair increase in brilliance of the lamp load when speaking at a normal level. Some microphones will require less voltage than others, depending upon their sensitivity so, since there is no way to control the gain except by this voltage and the level of the operator's voice, the voltage should be adjusted for normal operating.

A power supply capable of delivering 250 volts at about 70 ma. will handle the power requirements of the rig. Higher voltages, up to about 300, can be used, with some increase in transmitter output and reduction of tube life, but a good antenna is a better investment than higher plate voltages. Any of the usual types of antennas that is fed by a two-wire line can be used.

— B. G.

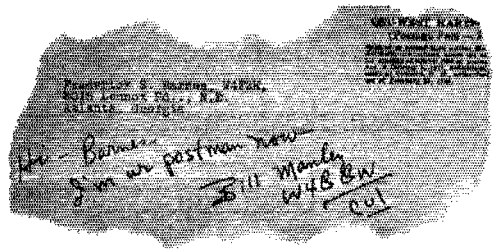

W4FZH gets a QSL on his QST wrapper!

Successful 56-Mc. Arrays

If this month of May runs true to form the five-meter band is going to be hot — and with more stations on than ever, chances for some new records. Just enough time left to read this article, pick out the beam you like, and get it up!

BY E. P. TILTON,* W1HDC

The "whirling tower" of W1K1J, Bristol, Conn. Dimensions for 56,120 kc.: Radiators 8 feet $3\frac{1}{4}$ inches, reflectors 8 feet $5\frac{3}{4}$ inches, directors 7 feet 7 inches; radiator to reflector spacing 4 feet $\frac{1}{4}$ inches, radiator to director 6 feet $6\frac{3}{8}$ inches. Radiators are arranged in "H" formation and are center-fed with a half-wave closed-end stub. Feeders come down inside the lattice mast to the base, where slip rings contact a line to the transmitter.

EXPECT to go on five meters this spring. What would you suggest as the best antenna for this band?" We think that the answer to this oft-received query may be found in an examination of the sky-wires in use at some of the leading 56-Mc. stations.

For the past few years, radio magazines have featured countless articles on rotary beams of every description. But most of this dope was concerned with low-frequency work, and many a five-meter man has found, to his sorrow, that while the theory may be the same for any frequency, an array which is hot stuff on twenty may be pretty much of a washout when it is tried on five.

The typical two or three-element close-spaced array which is the accepted standard for 28 or 14 Mc. will perform on 56 Mc., of course, but its high front-to-back ratio, so important in working through the QRM on ten or twenty, is a distinct disadvantage on the u.h.f. bands where we want to cover just as much territory as possible, ordinarily. The sharp frequency discrimination of the close-spaced array is not too disadvantageous in low-frequency applications — but don't forget

*Contributing Editor, QST.

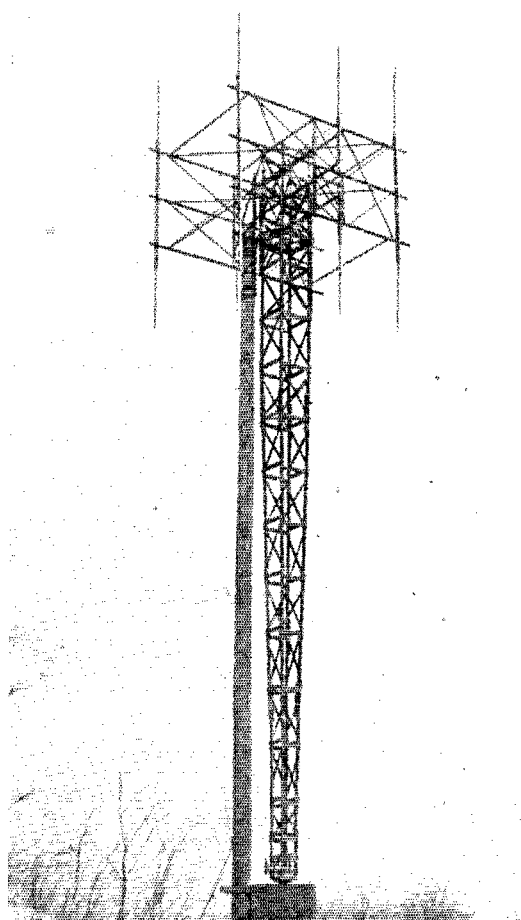

that the 56- and 112-Mc. bands are four megacycles wide. No room for a sharp-tuning antenna there! And so it goes — so let's have a look around the country and see what the fellows who are doing the really outstanding work on the ultra-highs are using.

The past year has seen a tremendous increase in 56-Mc. activity throughout the Middle West. In a number of places regular schedules are being maintained over distances in excess of 200 miles. Over the whole territory one antenna is practically standard equipment — the 3-element horizontal array using $\frac{1}{4}$ -wave spacing. First made popular through the conspicuous success of W9ZHB, W9ARN, and others in central Illinois, this type of array is probably used by more operators than any other single system. Its adjustment is simple and its frequency response is broad, yet it provides enough gain to effect a tremendous improvement over the operating range obtainable with a simple dipole. The outstanding signals of the stations using this system when the band is open for skip DX provide ample proof of the effectiveness of the "W9ZHB 'Q' Beam," as it is popularly known.

Element lengths may be cut to the standard

A Review of Beam Antennas Used by Outstanding Five-Meter Stations

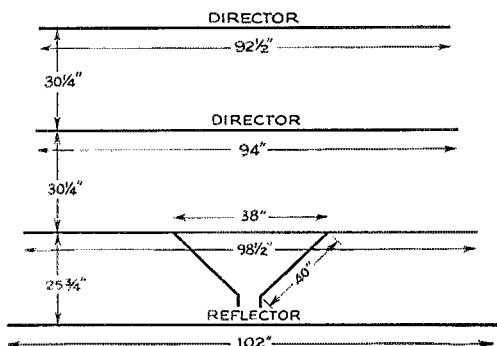

Fig. 1—W6QLZ 4-element 56-Mc. array. Delta shown is for 4-inch spaced line. For 2-inch line use 33 inches with 36-inch sides. Dimensions are for 57 Mc.

formula for radiator and parasitic element lengths, though the exacting enthusiast will provide some means of adjusting the elements for maximum performance. Using the wide spacing, the center impedance is still high enough so that feeding may be accomplished with a quarter-wave "Q" section. Spacing of the "Q" bars will be somewhat closer than for a single half-wave radiator. Correct spacing can be found by checking the feedline for standing waves. If a neon lamp (or other r.f. voltage indicator) shows an increase in brilliance when moved down the line from the "Q" section, the bar spacing should be widened. If a decrease is noted, the bars should be brought closer together. Like all other arrays using parasitic elements, the "Q" array should employ large tubing (half-inch or larger), *not* wire, for the elements.

W9ZJB, Gashland, Mo., uses a half-wave closed-end stub in place of the "Q" section. The

array was parasitically excited and an r.f. meter (a pilot lamp would do) was slid up and down the stub to determine the correct position of the shorting bar. The feeders were then attached at the point which produced the least detuning of the final tank condenser from the no-load point. Small stubs in the centers of the parasitic elements provide means of adjustment for maximum forward gain. In most cases it will be desirable to adjust elements for maximum forward gain and let the front-to-back ratio fall where it may.

Skip-DX champion of 1940 was W6QLZ, Phoenix, Arizona. This fellow broke all records for consistent DX work by knocking off contacts over distances in excess of 1500 miles on numerous occasions. That all this was done with 150 watts or less would seem to indicate that Clyde "has something" in the way of antennas. He has! Not only does the now-famous "W6QLZ 4-element Beam" give a good account of itself in skip work, but it has proven to be the key by which the mountainous country of Arizona has been opened up for long-haul "local" work on five. The tough going between Phoenix and Tucson is now covered by daily schedule by several Tucson stations who have erected duplicates of this array. In several instances these were put up exactly according to the dimensions worked out, with infinite pains, by W6QLZ, and no further adjustments were made. Clyde erected 27 five-meter beams in a period of fifteen months — so there's some experience in back of this setup! The frequency discrimination is somewhat sharper than the quarter wave spaced type, but it is still broad enough to give a good account of itself over the portion of the band where activity is at present concentrated. Dimensions given in Fig. 1 are for 57 Mc.

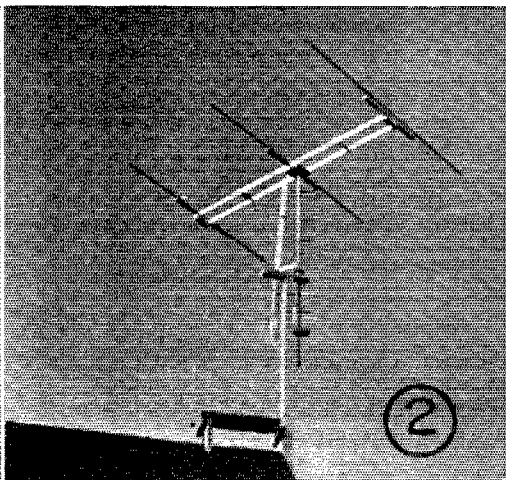

① W6OVK, Tucson, Ariz. This array is one of several erected to dimensions supplied by W6QLZ, as shown in Fig. 1. The small array is a 3-element for 112 Mc. ② Simplicity and efficiency are combined in the 3-element "Q"-fed array with quarter-wave spacing, so popular throughout the Middle West. This one is used at W9ANH, Terre Haute, Ind.

Once upon a time we thought that any old piece of wire was good enough for skip-DX work. Admittedly, when the band is really wide open almost anything will get you some contacts now and then — but it is the fellows who have something on the ball who make the contacts when the going is rough. Matching the polarization of the station at the other end is of much greater importance in skip work than was once thought. This should justify the erection of more horizontal arrays in the East, if only for the purpose of getting more and better contacts when the band is open. With the advent of more horizontals we will then have a chance to find out whether we have been passing up a good bet in standardizing on verticals for extended local work. For some time to come, however, the vertical array will be a mighty useful article in many sections of the country, so a few suggestions are in order.

Probably the minimum in the way of additional complication which will produce any gain over an extended double Zepp or other non-directional systems using two or more stacked elements is the popular "H" using four halfwaves in phase. The "H" serves as the basis for most multi-element vertical arrays. Here the respective merits of close and wide spacing come in for more discussion. The justly famous 16-element struc-

ture of W1DEI-W1QB (*QST*, November, 1940, page 43) uses two sets of close-spaced directors and four reflectors quarter-wave spaced. Two outstanding examples of the "H" in an 8-element setup are the arrays of W1AZ and W7FDJ shown in *QST* for August, 1940, page 40.

W1KLJ, Bristol, Conn., put up a 12-element structure using close spacing for the directors, but scrapped it in favor of the $\frac{3}{8}$ -wave spaced system shown in the photo on page 23. Perched atop Fall Mountain, this whirling tower (the whole structure rotates) is an imposing sight when viewed from the surrounding countryside. Equally imposing is the signal it puts out over W1, 2 and 3 on 56,120 kc. We might add that Bob uses a 3-element horizontal array for skip-DX work, however.

At W1HDQ we wanted an array which would permit work in two directions, with a pattern broad enough so that the beam would not have to be turned for every contact. The 8-element stick-and-wire affair shown in Fig. 2 gives us a minimum of 8db gain over a dipole in New York City and New Hampshire at the same time. The gain goes up when strong inversion bending prevails, indicating that most of the gain comes from the low radiation angle attained by stacking of the elements. While not many will have the ver-

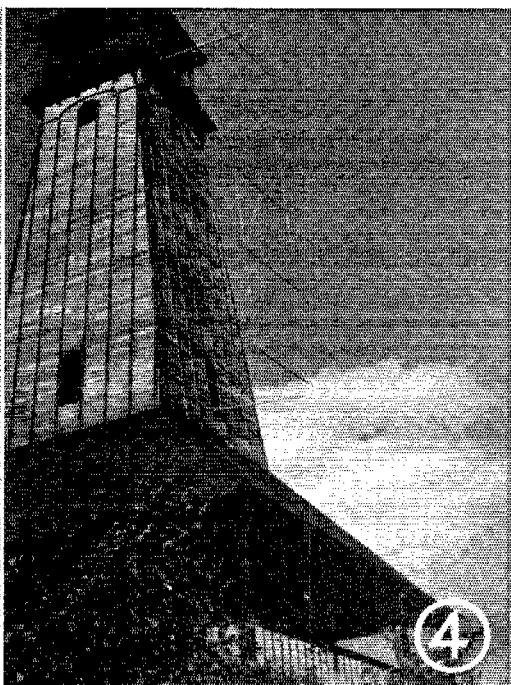
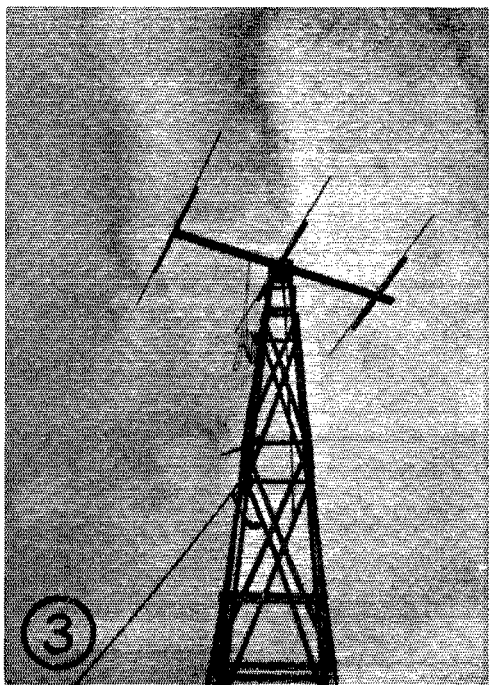

③ W9ZJB, Gasland, Mo., uses a half-wave closed-end stub in place of the "Q" bars. Radiator is 98 inches, reflector 101 inches, director 94 inches. Elements are spaced approximately 50 inches apart. Parasitic elements are adjusted for maximum forward gain by small stubs in the center of each. ④ Eight db gain in two directions for two bucks! Eight half-waves in phase at W1HDQ, Wilbraham, Mass. A similar array for 112 Mc. is mounted inside the tower.

Fig. 2 — The 56-Mc. array at W1HDQ, 8 half-waves in phase, bidirectional. The array is suspended on swivels, top and bottom. Only 90-degree rotation required. Phasing sections are held in place by 1-by 1-inch spreaders, to which glass insulators are attached. Dimensions are for low-frequency end of band.

tical height required for this type of array, its fine performance has resulted in numerous requests for details regarding it. A word of caution regarding this and other systems using a large number of driven elements: They should *always* be fed from the center of the array. In this way, design errors are balanced in all directions and the array becomes uncritical in adjustment. While it is difficult to figure the center impedance of this type of array, it is low enough so that it may be fed with a 500-ohm line directly, without the use of matching stubs, and without a serious standing-wave ratio on the line. The feeders should be tuned at the receiver, however, to realize the full gain of the system in receiving. This is good advice for any sort of array, incidentally.

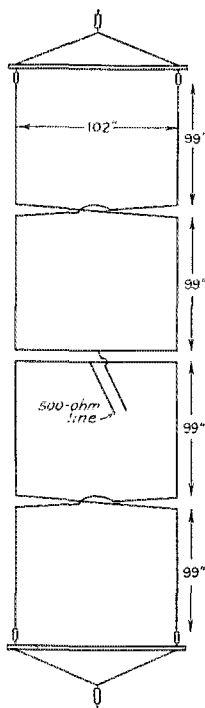

The arrays described represent only a few examples of systems which may be used successfully in u.h.f. work. While we have been chiefly concerned with 56 Mc., most of the principles apply equally well to 112 and 224 Mc. We have tried to present a few solutions to the beam problem — the rugged individualist will have his own ideas, of course, and countless variations are possible. The important point to remember is that time and money invested in good antenna systems bring a return which cannot be matched in any other way.

we can keep QSO through a department in our journal, the same as we used to do in our operating days. If we'll all contribute some notes on the activities of ourselves and our friends, we'll have the story just the way we used to get it. The Editor of *QST* will tell you, in the adjoined comment, how to go about helping. I urge you to do your part, so that we may again have fun together in the pages of our magazine. 73.

What everybody wants to know is as much as it is wise to print about where the other fellow is and what he's doing, what the old hometown club is doing, who's encountered whom in the Services, what new radio plans are being made, and so on. Information of possible military importance isn't wanted and won't be printed, but with the gang off the air there is much that a column of type can do to keep us in contact. Service notes are particularly desired. Send us news of your club, your gang, your pals, yourself. A letter or a post card to *QST*, West Hartford, Conn., will start the column rolling.

We are asking all the VE affiliated clubs and the S.C.M.'s in Canada to send us reports of the activities of themselves and their fellows. We hope that the S.C.M.'s will be in a position to centralize the news just as they did reports of operating activity in days of yore. Some of them aren't at home, though, so unless you are sure your S.C.M. is on the job and participating in this work, we suggest that you send your notes direct to *QST* at West Hartford until further announcement.

K. (Begin sending!)

P.O.W.

It is reported that the following amateurs are being held as prisoners of war:

P.O. H. Cunningham, ZB2A.

Lt. A. W. Lister, G5LG.

Capt. E. Shackleton, G6SN.

—T. & R. Bull.

The Month in Canada

STARTING next month, *QST* will endeavor to assemble each month a column of notes and news on the activities of Canadian amateurs, under the above heading. How successful it will be depends upon the collaboration of VE amateurs and clubs. The Canadian General Manager, Alex Reid, VE2BE, who we hope will be a regular contributor, makes the following appeal to Canadian hams:

Many a VE amateur, whether he is serving with the armed forces in this country or overseas, or even if he is still at home, must be wondering what we're doing with ourselves these days, how the amateur movement is faring in Canada, where we shall sit when the present turmoil subsides. Well, boys, it should be rather easy for you to understand that there is more going on than we can talk about, and little that we are free to tell you. But we do feel that you will find it good news to know that we aren't just idly sitting by, that we do maintain our government contacts as we did in more placid years, that our relations are as friendly as ever, and that we shall be able to count on the recognition and renewed encouragement of our government when it's all over.

Now in the meantime we have to take some pains lest we lose contact with each other during the period of our temporary shutdown. What was difficult for *QST* a year ago is possible now:

★ WHAT THE LEAGUE IS DOING ★

LEAGUE FIELD DAY AUTHORIZED!

The big news of the day is that the Federal Communications Commission on March 11th authorized us to hold our Field Day tests on June 7th and 8th in the grand old manner. Its Order No. 73 of last June, it will be remembered, prohibited low-frequency portable operation except in the daylight hours of week-ends, and permitted it then only upon 48 hours' notice and only provided the apparatus was self-powered, intended for emergency use. Some time ago the A.R.R.L. went to F.C.C. and asked for another relaxation this year, pointing out the importance of these tests as a stimulant to the building and testing of apparatus useful in emergency. As a very nice indication of their realization of the importance of this work, their Order No. 73-D says that the public interest would be served by permitting portable and portable-mobile operation during this period by amateur stations participating in these tests, and therefore:

It Is Ordered, That during the period of the American Radio Relay League Field Day test from 4:00 P.M. E.S.T., June 7, 1941, to 6:00 P.M. E.S.T., June 8, 1941, the prohibition contained in Commission Order No. 73 shall not apply to communications transmitted by licensed portable and portable-mobile amateur stations participating in such tests.

This relaxation applies only to stations participating in our Field Day. Portable apparatus may be operated within the stated hours on any frequency bands, whether it is self-powered or not, and upon simple advance notice to the inspector. It may be operated during the night of June 7th-8th as well as in the daylight hours. Portable-mobile may be operated as before last June. But all of this applies only to participation in the A.R.R.L. tests, not to non-participants.

Pretty good, don't you think? The usual swell time is promised. Get your gear ready and lay your plans!

BOARD MEETING

THE A.R.R.L. Board of Directors has its annual meeting in Hartford, May 9th and 10th. Before leaving for the meeting, the directors would like to hear the reactions of interested members to the proposals on the calendar of this year's meeting. Your director's address may be found in the front of this issue. The following proposals are on the Board's agenda:

1. To ask F.C.C. to extend 10-meter 'phone down to 28,100 kc. (leaving only 28-28.1 Mc. exclusively for c.w.), and to open 29,250 kc. to 30,000 kc. to f.m. transmission. This latter is the harmonic shadow of the 5-meter f.m. allocation.

2. To amend Article VII of the Constitution to exclude the President and Vice-President from voting on amendments to the Constitution.

3. To recommend to manufacturers of amateur receivers the adoption of a uniform standard for S scales.

4. To change the requirements for membership in the League to provide for Full Members, who shall have all rights and privileges, and Associate Members, who shall have all privileges except the right to vote and the right to hold the office of director or alternate. Any interested person would be eligible to associate membership but full membership would be granted only to a member resident in one of our divisions and holding either an amateur station license or an amateur operator license, or both, at the time he made application for full membership. This would be granted for only one year at a time, and the continued possession of an amateur license would be required to be demonstrated at the beginning of each new year of membership.

5. To eliminate the "family memberships" now provided by By-Law 4.

6. To change the status of the Philippine Islands to that of attachment to the Pacific Division for Communications Department purposes.

7. To postpone the election of new Canadian General Manager and alternate, because of doubt of the eligibility of candidates and voters, since Canadian licenses are now suspended; and because the Canadian membership is temporarily at a low figure because of the effects of the war, with many members absent from their homes. It is proposed that the incumbents continue in office until a new election can be held promptly after the resumption of Canadian licensing.

APPLYING FOR RENEWALS

F.C.C.'s extension of expiring licenses until September 30th applies only in cases where applications for renewal have been filed. It continues of great importance to get your renewal application in on time — sixty days before expiration. If you don't comply with this requirement of the rules in Sec. 1.360, there is question whether you are entitled to carry on under Order 76-A. If you don't get your application in before actual expiration date, you may be required to appear for reexamination, be required to file for a new license instead of a renewal, be put off of the air because your license has expired, and have to wait until F.C.C. can get around to issuing your *new* license (even though you will get your old call back).

MISCELLANY

THE Communications Department has written letters to the governor of every state, calling attention to the existence of the A.R.R.L. Emergency Corps and its usefulness in state communication emergency plans, particularly on behalf of the State Guards which are being formed in most states. . . . Clinton B. DeSoto, Assistant Secretary of the League and author of *Two Hundred Meters and Down—The Story of Amateur Radio*, has written a popular book on amateur radio, *Calling CQ—Adventures of Short-Wave Radio Operators*, published in late March by Doubleday-Doran & Company, and now on your bookstands. It's swell reading for you and your "prospect." . . . Although the A.A.R.S. page in March *QST* announced the availability of Under Communication Operator positions in the War Department, the Civil Service examination forms have not been released yet because no great difficulty has been found in filling vacancies for the higher grade of Junior Communication Operator. Need for additional J.C.O.'s in the near future may yet result in the formal announcement of the U.C.O. positions. . . . It is expected that the distribution of the Army questionnaires to amateurs will be completed in April. See our previous references, particularly page 22 last month. We recommend that amateurs promptly fill out and return the forms.

Strays

RADIO INTERFERENCE CONFERENCE

ON MAY 10th the University of Illinois will be the scene of a one-day conference on radio interference, with attention focused on the technical aspects of the subject. A number of papers will be presented, the tentative program including Prof. H. J. Reich of the University, R. M. Planck of R.M.E., L. Podolsky of Sprague Products Co., Prof. M. A. Faucett of the University, Alfred Crossley and N. Hogenbirk of Belden Manufacturing Co., and Dana Pratt, RCA Manufacturing Co., as speakers. Subjects to be covered will include generation of combination frequencies, multiple response in receivers, damped-wave interference, trouble shooting on power lines, noise-reducing antennas, and elimination of spurious radiations from transmitters. There will also be a panel discussion on amateur interference with broadcasting.

Registration will open at 8.30 A.M. A banquet at 6.00 P.M. has been arranged, with Dr. Wheeler of the FCC as speaker. Price of banquet tickets will be nominal. There is no registration fee, but those expecting to attend are requested to advise the conference committee so that appropriate facilities can be provided. Communications should be addressed to A. James Ebel, W1LL, University of Illinois, Urbana, Ill.

BIG AURORA SESSION MARCH 30TH!

Though not quite equal to the peaks of March 24th and 29th last year, a magnetic storm of sufficient magnitude to tie up wire services and low and medium-frequency radio communication of all kinds broke on Sunday, March 30th. This one found more 56-Mc. operators on deck than any previous session, and most of them knew what to do. They went on c.w. without delay, with the result that more contacts were made between 3 and 7 p.m., E.S.T., than during any previous period of aurora refraction. Here are a few early reports:

W1AEP—Worked W8's QXV OPB CLS, W3GUF. Heard W8's FGV CIR DDO NSS PKJ BJK, W8's BYM GLF HDJ.

W1VC—Worked W8CIR, W1SI. Heard many W8's and 3's.

W1KTF—Worked W8's CIR FGV, W3HDJ, W1SI.

W1KLJ—Heard W8's CLS OPB FGV CIR.

W1LLL—Worked W8's CIR OPB QXV FGV KQC RVT(?) GR(?), W3's HDJ ACC CGV GUF. Heard W8's NSS PKJ BJK KKD RUE.

W1KHL—W8's CIR OPB, W3's HDJ GUF.

W1SI (Reported by W1EKT)—Worked W8's FGV QXV OPB OKC CIR CLS, W3's GUF HDJ ACC GLF, W1's VC KTF, W2BYM. Heard W8's FYC KQC KKD PKJ NBV DDO QQV QOV, W3's IIS CUD, BKB, W2's TP AMJ BQK, W1's LLL BJE.

W2BYM—Worked W8's OPB OKC, W1SI. Heard W9UUN, W8's CIR QQP.

W2AMJ—Worked W8's OPB QXV OKC KQC CLS JLQ. Heard W1's SI KHL, W8's PKJ CIR QQP KKD FGV. Heard by W9UNS and W3BZ.

W8OPB—Worked W3's HDJ BKB, W1's ILL AEP BJE KHL SI, W2's AMJ BYM BYW, W9's ZHB NFM, W8's DDO RKE KQC KKD. Heard W2HGU, W9's ANH QCY WMI RGH.

W8OKC—Worked W1's SI KTF, W3's BKY BKB, W8's NSS DDO, W9NFM, W1KTF. Heard W8's PKJ QQP KKD KQC, W1's LLL AEP BJE, W2's HGU AMJ TP, W3HDJ, W9's ANH ZHB QCY RGH.

There are some obvious inaccuracies in the above list, and it represents but a small fraction of the work done. W8's were heard calling W9's, indicating that the area affected was unusually widespread. It is hoped that everyone taking part will send in complete lists of stations heard and worked in order that we may learn more of this most fascinating of all u.h.f. phenomena.

—W1HDQ



ARMY-AMATEUR RADIO SYSTEM ACTIVITIES

WAR QSL CARDS

THE distribution of the new WAR QSL cards to the more than 800 amateur stations who were successful in working WAR since the inauguration of this activity last December, was com-

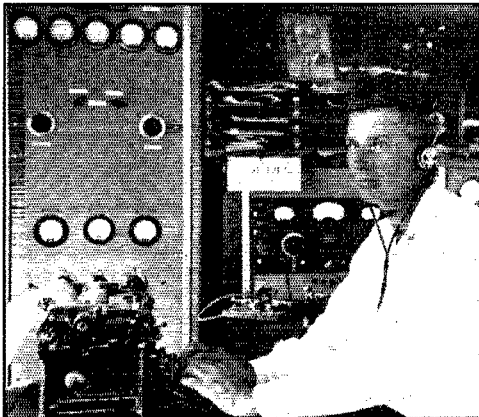

W. B. HOLLIS, W5FDR/WLJR, Houston, winner of the annual AARS code speed contest at 65 w.p.m. Born in San Antonio in 1903, an amateur since 1935 and a member of AARS since 1936, Mr. Hollis has had an active radio and military career. From 1919 to 1921 he was in the Navy at the radio school at Great Lakes. Following a year as a commercial operator he served in the Marine Corps during the period 1922-25 as operator and chief at Naval radio station NPP at Peking, China, remaining in the Marine Corps Reserve until 1929. Since 1925 he has been associated with the Southwestern Bell Telephone Co. at Houston, but the years 1931-35 saw him also serving as radio operator in the observation squadron of the Texas National Guard. In the ARRL he has been West Gulf alternate director, Route Manager, ORS, OBS, A-1 Operator, RCC, and manager of Trunk Line D. It is interesting to note that he also won the AARS speed contest in 1939, also at 65 w.p.m. He is married, has six children. While amateur radio traffic handling is his first interest, other hobbies include woodworking and model airplanes.

pleted last month. The QSL cards received from these stations were checked with the WAR logs to verify the contacts claimed. It is hoped that the distinctive design of these cards (which includes a photo of the WAR transmitting station at Fort Myer, Va., the list of WAR-Amateur Schedules, the WAR call in large red letters with the Signal Corps emblem below and a short personal message from Major General J. O. Mauborgne, the Chief Signal Officer) will always be a reminder of the close relations existing between the Signal Corps and the amateur radio operator.

AARS CODE SPEED CONTEST RESULTS

THE annual AARS Code Speed Contest, held February 10th, had over 800 participants from the ranks of the AARS membership. The Ninth Corps Area (States of Washington, Montana, Oregon, Utah, Idaho, Nevada and California) again won this competition with 221 members taking part to attain a score of 3695 points. The winning Army amateur and the only one to qualify at the 65 w.p.m. speed was W. B. Hollis, W5FDR/WLJR, Houston, Texas. W5FDR is not a commercial or government radio operator by profession and, therefore, he is eligible for the Marconi Memorial Award of the Veterans Wireless Operators Association.

The automatic tape transmissions were made from WLM/W3CXL, Washington, simultaneously on the 3497.5 and 6990 kc. frequencies starting at 20 w.p.m. and progressing to 65 w.p.m. in steps of 5 w.p.m. about every five minutes. In addition, WLW/W6NLL, Presidio of San Francisco, California, sent a different text on 3497.5 kc. later at night for the benefit of west-coast stations. The copy for this contest was taken from a romantic story appearing in a monthly magazine, which served to make the contestants strive for the higher speeds in order to follow the story.

Place	Corps Area	Points	Participation Factor	Total Score	Corps Area Winner and Speed
1.....	IX	6310	58.5%	3695	W6BRV — 55 w.p.m.
2.....	II	2340	54.0%	1264	*W2KYF — 60 w.p.m. W2KLD — 50 w.p.m.
3.....	V	2625	48.2%	1262	W8KKG — 50 w.p.m. W8HRA — 50 w.p.m.
4.....	III	2030	42.2%	859	W3AKB — 45 w.p.m.
5.....	VIII	2055	35.6%	731	W5FDR — 65 w.p.m.
6.....	VI	2210	25.9%	574	W9HLB — 50 w.p.m.
7.....	VII	2325	23.9%	556	W9TKX — 50 w.p.m.
8.....	I	1930	27.7%	534	W1LVQ — 50 w.p.m.
9.....	IV	935	10.5%	98	W4DVO — 45 w.p.m. W4AAO — 45 w.p.m.

* Ineligible because professional radio operator.

"Perfect copy for one minute was necessary to enable one to qualify at any speed. The corps area scores were computed by multiplying the number qualifying at a speed by that speed in words per minute. The points obtained, in turn, were multiplied by the corps area participation factor, which was based on the percentage of Army-amateur members participating, to arrive at the final scores which appear.

An analysis of the reports submitted indicates that the average Army-amateur member can copy at least 25 w.p.m. and that many can record transmissions up to 35 w.p.m. The following table illustrates these points:

Code Speed	Percentage of Contestants Qualifying
20 w.p.m.	13.3%
25 w.p.m.	39.6%
30 w.p.m.	23.2%
35 w.p.m.	12.7%
40 w.p.m.	5.5%
45 w.p.m.	4.4%
50 w.p.m. and over.....	1.3%

As most of the AARS members who participated already have their ARRL Code Proficiency Certificates for the speeds up to and including 35 w.p.m., the calls of only those attaining the higher speeds in this contest are listed below:

W.P.M.	Those Qualifying
65 ...	W5FDR
60 ...	W2KYF
55 ...	W6BRV
50 ...	W1LVQ, W2KLD, W8KKG, W8HRA, W9HLB, W9TKX, W5GPV, W6IIG
45 ...	W1LWH, W1INT, W2LEI, W8UXT, W3AKB, W4DVO, W4AAO, W8QLO, W9QIL, W9YTV, W9YXH, W9RLB, W9GMT, W8TJV/9, W9FLI, W9WIN, W9UHT, W9ZQW, W9GNS, W5BML, W9WFB, W5ENI, W6MKW, W6BMC, W6ETJ, W6DVD, W6FII, W6IMI, W6JGA, W6AGF, W6HKM, W6CVL, W6MRT, W6INH, W6NLL, W6HAP, W1AKS, W1INU, W2DW, W8BJO, W3ECP, W3EIZ, W3FIO, W3GKO, W3ICT, W8SSA, W4AWO, W5JII, W4BIH, W9KAQ, W9QG, W8OLV, W8BBH, W8CJL, W8JLF, W9DOU, W9ZCH, W9YZE, W9ESA, W9GBN, W5HBQ, W6UO, W6KGO, W6RIG, W6FQU, W6PFK, W6GTM, W6JBF, W6PBG, W6OKF, W6MFH, W6SN, W7ZL, W7DBZ, W7IFN, W7DET, W7IM, W7EBQ, W7HAO.

How to Build a Code-Instruction Table

THOUSANDS of people who don't know the code want to learn it to-day. Additional thousands of hams who do know it want to build up their speed. Scores of amateurs are being called in to start code classes — for the YMCA, the Boy Scouts, men's clubs, girls' colleges, NYA, vocational classes, what not. Three or four persons can sit around a plain table with a buzzer set and an instructor; but when the group is larger, something more comprehensive and versatile is necessary. What to do? The answer lies

in a code table specially wired up to do the job.

It is intriguing to contemplate what can be done with a wiring diagram that is not too complicated. The first thing, of course, is for the instructor to be able to send code to the whole class. But by keying a constantly-running tone source, many other things are possible. Each student can practice sending, independently and to himself. The instructor, by means of a selector switch, can listen in on each student in turn, can break in on him and correct his errors. Moreover,

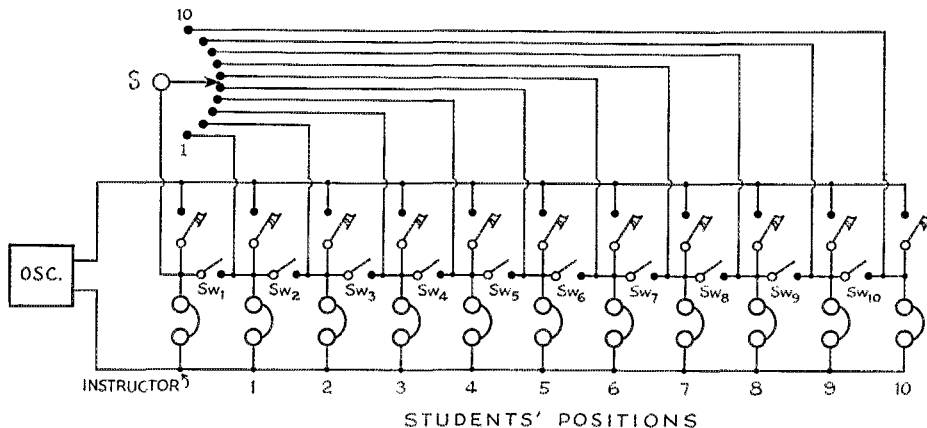
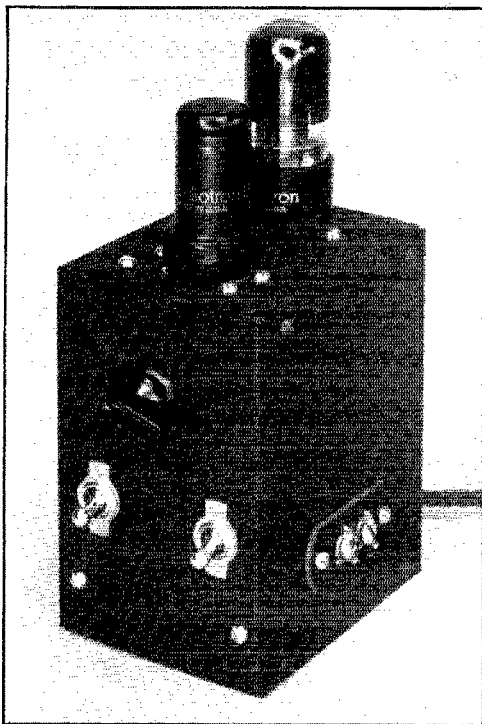

Fig 1. — Wiring diagram of the code-instruction table



The code-practice oscillator circuit of Fig. 2 built into a 3 by 4 by 5 box. All wiring is insulated from the case.

simply by throwing a few switches, facing pairs of students may join in two-way QSO's, and each pair may be monitored in turn by the instructor — all from a common oscillator. Bigger "nets" can be built at will, while other students at the same table continue practice either singly or in pairs, all under control and supervision.

Such a code table is simply invaluable to any group learning the code. It can be built by any club at modest expense. In presenting a description of how to build one, we hope that many of the affiliated ARRL clubs will find it something useful to construct to provide training and increased proficiency for members,

Since any convenient arrangement of parts may be used, the assembly can be quite compact. A side view of the code-practice oscillator, showing the tone-selector switch mounted on the side of the case.

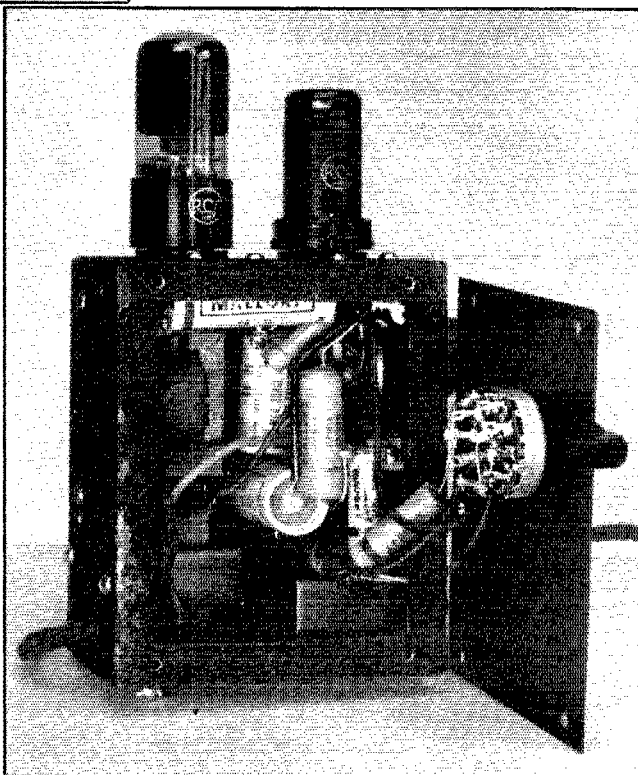

and that amateurs who are called upon to set up classes will find the article a helpful guide.

The instructor should sit at one end of the table, facing down its length, the students arranged along each side. Down the center of the table there should be a partition of such height as to prevent the student from seeing the copy of his opposite number. Cross-partitions are similarly useful and make a sort of "private office" of each operating position, each with its 'phones, key and switch. The oscillator is at or handy to the instructor's end of the table, his controls on a low panel in front of him, running across the table.

All the service schools of course have tables more or less of this description, and of varying degrees of complexity and flexibility. The particular diagram we present in Fig. 1 seems best adapted to the needs of amateur groups. It was devised by Chief Radioman Frank B. Fucile, USNR, W8GZS, of the instruction staff of the Naval Reserve Radio School at Noroton Heights, Conn., at the request of our (on-leave) assistant communications manager, Ensign E. L. Battey, WIUE, who is also serving at that school.

How It Works

At each student's position, a key and headset in series are bridged across the line carrying the continuously-running audio tone. The headsets

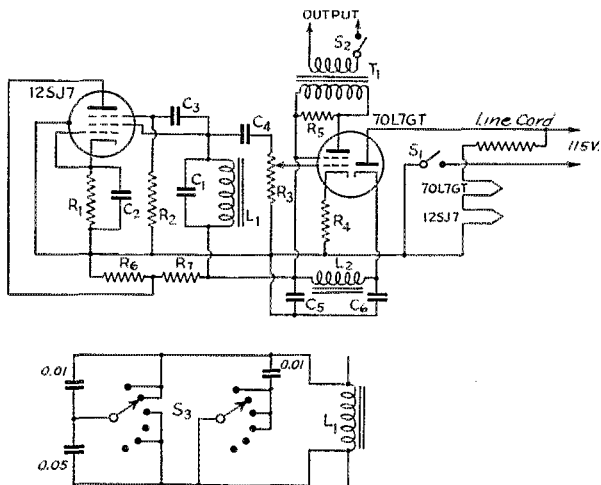

Fig. 2 — Circuit of code-practice oscillator suitable for large groups.

- C₁ — 0.05- μ f. paper (for tone of approximately 650 cycles with L₁ = 1 henry); substitute lower circuit for variable tone.
- C₂ — 25- μ f. electrolytic, 25-volt.
- C₃, C₄ — 0.01- μ f. paper.
- C₅, C₆ — 30- μ f. electrolytic, 150-volt.
- R₁ — 2000 ohms, 1-watt.
- R₂ — 0.25 megohm, $\frac{1}{2}$ -watt.
- R₃ — 0.25-megohm volume control.
- R₄ — 150 ohms, 1-watt.
- R₅ — 3000 ohms, 1-watt.
- R₆, R₇ — 10,000 ohms, 1-watt.
- L₁ — 1 henry, approx. (see text).
- L₂ — 8-henry 55-ma. filter choke.
- T₁ — Universal output transformer, tube to voice coil (set for matching 8-ohm v.c. to 2000-ohm plate load).
- S₁, S₂ — S.p.s.t. toggle.
- S₃ — 2-pole 6-position wafer switch.
- Line Cord — 220-ohm.

(and keys) may be paralleled by closing the interconnecting switches, each switch being associated with the position of the same number. A tap from each position is taken off to the multi-point switch (S) at the instructor's position so that the latter can also place his headset and key in parallel with those at any of the ten positions.

When the instructor sends to the entire class all the small switches are closed, connecting all positions in parallel. With all switches open each student can practice sending by himself, and the instructor can listen to any student by setting

the selector switch S to the appropriate position. This also puts the instructor in parallel with the student at that position so that the instructor can "work" the student.

Suppose now that students are to practice together in groups of two. Closing Sw₂ connects Positions 1 and 2; closing Sw₄ connects 3 and 4; Sw₆ connects 5 and 6, and so on. The odd-numbered switches would be open in this case. The instructor can listen in on any group by setting the selector switch to either position in the group, and again can break in on the work. Larger groups can easily be formed; for instance, closing switches Nos. 2, 3 and 4 will connect positions 1, 2, 3 and 4 together; closing Sw₆ and Sw₇ will connect positions 5, 6 and 7 together, and so on.

The number of positions can be extended indefinitely by following the same wiring system. Separate tables, grouping perhaps ten men to a table, can be used if the room is too small to accommodate a single table for a large class. In such a case the instructor could have a central position with a separate selector switch for each table.

Tone Source

The tone requirements are few, but are not readily met by a simple audio oscillator. The output voltage of the source should be great enough for good volume with an ordinary 2000-ohm headset, and should

(Continued on page 68)

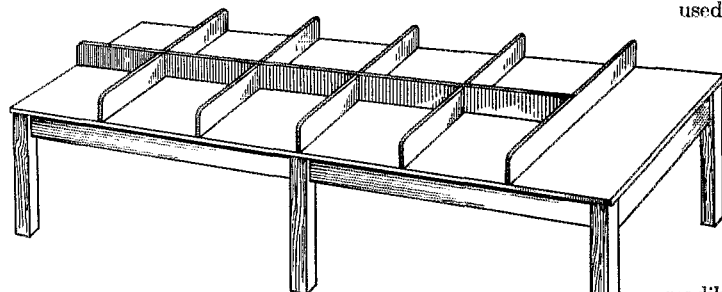
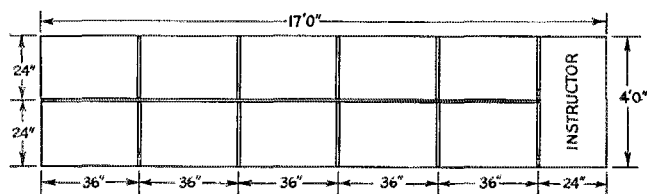

Fig. 3 — A suggested form of construction for the code-instruction table. Dimensions may be varied to suit individual club needs. Legs may be made of 4 by 4 stock; top and side rails of 1-inch boards. Appropriate bracing should be provided underneath. A coat or two of shellac after the table is finished will prevent shrinkage.



ON THE ULTRA HIGHS



CONDUCTED BY E. P. TILTON,* W1HDQ

AROUND Chicago there was one fellow you could always count on. Whether it was a relay to be promoted, some DX to be worked, or just a pleasant chat with some of the local gang, W9VHG was always ready. When a relay message was addressed "to any Chicago station" it invariably ended up on the hook at W9VHG, and when the band opened up there was one call we always heard in there — W9VHG. It was, therefore, a most disheartening shock to learn of the tragic death of DeMotte H. Little, W9VHG, of Glenview, Ill., on March 14th. U.h.f. enthusiasts the country over have suffered a real loss; a loss the more tragic because it was accidental — electrocution, while working in the power room of WBBM.

Dud had been in the employ of the Columbia Broadcasting System for eleven years, and had held the position of transmitter supervisor for the past year. He is survived by his wife, Mrs. Jeannette Little, and two children, Patricia, 8, and DeMotte, jr., aged six weeks. Dud was a charter member of the Ultra-High-Frequency Club of Chicago, having been its first president. For years he had been one of the most consistently active 56-Mc. operators in the Middle West, and in recent months had been working on 112 Mc. as well.

Activity on Five in March was highlighted by

* 329 Central St., Springfield, Mass.

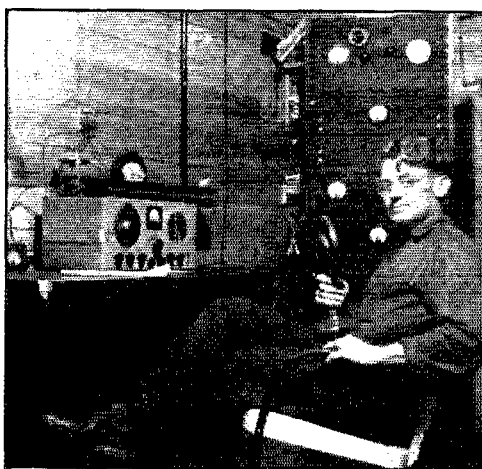

DeMotte H. "Dud" Little, W9VHG, Glenview, Ill. His death, by electrocution at WBBM, on March 14, 1941, was a loss that will be felt wherever DX is worked on Five.

several bursts of aurora DX, and a few scattered openings for sporadic-E skip. The most pronounced occurrence of aurora refraction was mentioned briefly last month. This was early in the evening of March 1st. Since our hurried résumé of this session was prepared, several additional reports have been received. Those not mentioned last month include W3's CIR, OPB, and FGV. Apparently work was confined to W1, 2, 3, and 8 during this period, but on March 13th the boys in the Middle West had a fling at it. At 8:30 p.m. W9ARN, Bartonville, Ill., heard the characteristic distortion on W9BDL, Marshall, Ill. With the beam aimed at BDL, Jack could make him out on voice, but on turning the beam the signal became much stronger, although unintelligible as to modulation. W9YKX, Woodbine, Iowa, was also heard on c.w. On the mighty W9YKX-NFM sked the boys noted the same conditions. YKX worked both NFM and ZJB, both over 200 miles, on the usual type of transmission but noted that signals were more than doubled when beams were turned toward the north. This March-13th one is hard to explain, as it doesn't fall in with any 28-day cycle of previous occurrences as far as we know. W2AMJ reports hearing a weak signal, obviously of the aurora-refracted variety, on this date, the only eastern report on this one.

Skip DX doesn't happen often in February and March, but apparently it can be expected in the warmer parts of the country at almost any time. Skip not previously reported includes the following:

Feb. 23rd: W6MYS worked W7FDJ.

Feb. 27th: W6QG worked W5AFX. W6OVK worked W5FSC and W9ZJB.

March 2nd: W4FKN worked W5AFX. W4FBH worked W5's AFX, HTZ, and EHM. All these were morning contacts, 9:50-10:45 a.m. W6QLZ worked W5FSC, as did W6SLO, in the early evening.

March 6th: W5VV worked W6SLO and W6QLZ shortly after noon.

Over the colder parts of the country the month of March represents the toughest time of the year for extended-local work. There were a few good nights, as always, but there were more when signals over paths in excess of 100 miles were down to rock-bottom. A moderation of the weather late in the month, after blizzards and severe cold, brought improvement in general, and a promise of better days soon to come.

HERE AND THERE

Our Atlantic Seaboard Five-Meter Net is really clicking. Each Monday night a rapid-fire relay is conducted,

with messages shuttling back and forth between New England and Washington, D. C., in record time. It would appear that this set-up would be ideal in case of an emergency — a network, capable of functioning under almost any condition, connecting most of the major cities from Portland, Maine, to Washington.

WIAP, atop Mt. Washington, was forced off the air for a short time by — of all things — broadcast interference. In this case, however, it was interference with the pickup of Yankee Network programs from Paxton, Mass. That has all been corrected now, and WIAP is again heard nightly on 57 Mc. with a fine signal. The rig is a pair of 807's. Contact has been established with Portland, Maine, where W1MFK has finally made the grade. Two other stations are also known to be active in Portland.

W2MO keeps things going for the Net in W2. Earl skeds your conductor at 8:30, W1LLL at 8:45, and a whole group of W3's at 9 P.M., each Monday and Friday night.

W2MPA, Highlands, N. J., really gets out with that little mobile rig of his. Ted was heard, believe it or not, by K6OQM, calling CQ-Five, mobile! The catch is that mobile W2MPA ends up with a doubler — but this is not to be sneezed at even on 28 Mc. Ted's home rig now is heard on 56,060 running 1/2 kw. to a pair of TW-75's with a linear tank circuit. An 8-element vertical beam is in the works.

Good news for searchers after Vermont! W1MEP/1 is again on deck with his flea-power portable atop Glastenbury Mountain. We expect Chet to have something in the way of a horizontal array for the benefit of the W9's — so keep watch on 57,486, boys. Who'll be the first to get him, and thereby set a new record for low-power DX on Five? For Maine on Five, look for W1MFK on 57,320. Rhode Island will have W1JTB, 57,980, along with W1BCA, W1GJZ, and others.

"Deacon" Gravely, W3BZ, is still banging away in Danville, Va., looking for someone to the north so that he can connect in with the net. He now has a 4-element horizontal array and a vertical extended double Zepp, but can find no one to try them out on. W3IIS, Rockdale, Md., lost his antenna in the March storms, but is coming back strong with a 12-element (6 half-waves with reflectors) array.

W2CUZ gets around. Don is out on tour with NBC army pickups, but that doesn't prevent some nice personal QSO's. W5AJG reports that he and Don spent a very enjoyable evening together recently. W5AJG and W5EHH are running skeds three times weekly with W5VV and W5AFX, both just about 200 miles distant. No contacts have been made as yet, but all hands insist that they will make the grade eventually. A new beam, designed with this in mind, is going up at W5AJG.

W6BPT reports that W6DOU has gone to National Guard camp for his year in the service, leaving W6NHO as the only other local inhabitant within reliable range. W6CME is coming on in Santa Cruz, and tests over the mountains to BPT in Santa Clara are about to begin. W6BPT would like to round up a bunch of fellows who might be interested in the formation of a 56-Mc. network. Candidates?

Ever hear of Pullman-car Charlie? He is W6TAT/6, and he has the life! Charlie lives the year round in a Pullman coach on the Southern Pacific Railroad. He has a 25-watt rig and a DM36-Howard 450 combination aboard. Both horizontal and vertical antennas are mounted on top of the coach, and a 4-element array which can be raised and rotated is under construction. Mobile, with no ignition noise — ah me! Charlie has heard the signals of W6QLZ as far west as Yuma, nearly 150 miles! He travels from Portland, Oregon, to Tumucari, New Mexico, at speeds between six and ten miles per hour! Want to check your coverage? Just get in touch with Charlie Kaehms, W6TAT/6; mail address, Room 1039, 65 Market St., San Francisco.

Good news from Oregon! W7CIL of Salem reports the formation of another of those strangely-named networks that are springing up all around. This one, the Five-Meter Screwball Net, includes the following W7's: SO and CN of Albany, just getting started; FFE, 58.1, and FDJ, 57.1, of Houlton; ERA, Milwaukie, 57.7; and DNB, 57.65, CIL,

U.H.F. MARATHON

First period winner: W1MBS, 194 points

Call	Contacts Through March 15th				Score	States in 1941
	56	112	224	400		
W1AEP	28				152	4
W1AYV	31	9			162	5
W1BBM			1		10	1
W1DJJ	62				200	4
W1EHT	29				141	2
W1EKT	43				166	3
W1HDQ ¹	71	15	4		552	7
W1IJ	23	15			209	4
W1JAX	9				25	2
W1JJR	1	28	1		122	2
W1KJL	33				99	3
W1LLL	34	3			219	7
W1LSN	34				161	2
W1MBS		100			304	2
W1NBU		23			73	2
W2ADW	1	7			72	2
W2AMJ	62				332	8
W2BYM	17				60	4
W2COT	47				129	5
W2DZA	47	92			306	3
W2FJQ	30	10			143	6
W2LAL	49				174	3
W2LXO		22			71	2
W2MEU	32				135	5
W2MGU		53			210	3
W2MPA	23				92	4
W2MQF		24			80	2
W1MUX/2	10	10			63	3
W3ABS	35				153	5
W3ACC	45				195	7
W3AXU	19	12			99	3
W3BYF		4			14	1
W3BZJ		29			64	3
W3CGV	42	1			187	3
W3FSM		2			6	1
W3HOH	43	55			377	7
W3IIS	15				69	4
W4FBH	3				30	2
W5FSC	4				31	2
W5VV	3				30	1
W6ANN	19	26			224	1
W6IOJ	13	18	1	1	157	1
W6OVK	10	1			149	3
W6QG	18				103	2
W6QKM	4	25	1		110	1
W6QLZ	8	3			130	2
W6RVL	67				247	1
W7CIL	7				47	2
W8CIR*	30	10			404	9
W8KRD	9	23			142	1
W8PKJ	11				75	4
W8QQS	4				17	2
W8RUE	17	2			104	3
W8SPY	6				63	2
W8UUY		6			36	1
W9AB	2				16	1
W9ANH	8				119	2
W9ARN	18				174	3
W9BDL	15				171	3
W9PNV		56			224	2
W9RGH	14				84	3
W9YKX	8				147	4
W9ZHL	14				140	2
W9ZJB	6				41	3

¹ Not eligible for award.

* Second period score of 271 appears to be high for the month.

57.08, and BVV, of Salem. All except FDJ have horizontal rotary beams. W7CIL is in the process of moving to a better location and will be all set in time for the spring opening. He would like skeds during the morning any day, and

Monday, Wednesday, or Thursday nights after 7 P.M., or Tuesdays, Fridays, Saturdays, and Sundays in the afternoon, before 6 P.M. He works Five exclusively. How about giving these boys a hand? — they are really trying to put W7 on the 56-Mc. map in a big way!

In western New York W8PK, East Bloomfield, and W8FYC, Belleville, have maintained skeds since January 1st over a 100-mile hop. PK runs 150 watts and uses 12 half-waves in phase, vertical. FYC has 300 watts and four half-waves in phase, with reflectors. Skeds start at 7:30 and sometimes run until after midnight.

W9ANH hears from W9AQQ that there are several new stations in Indianapolis, but only W9VEK and W9AQQ make the 100-mile hop to Terre Haute, to date. W9UNS is back on in Marshall, Ind., with 200 watts to 812's and a Lester converter.

W9ZHB, Zearing, Ill., now has some local support, with W9OPB running 60 watts feeding a 3-element "Q" array atop a 65-ft. windmill tower.

W9ZJB, Gashland, Mo., says that when Ten has a few dead days all the Kansas City gang pile up to 160 and gripe about the QRM. And all the time there's a band just one jump higher in frequency where they could work out to 200 miles or more regularly, with occasional bursts of DX and no QRM! They'll wake up someday, Vince.

By courtesy of W2KOJ who furnished some snappy relayng service, we present an excerpt from a message from W7IFL, ex-W1MHM, of Cheyenne, Wyoming. "Am on 57.152 each evening, seven to eight, Mountain Standard Time, calling CQ, phone and c.w. —" There's Wyoming for you fellows in W5, 6, 7, and 9. Keep up the good work, Johnny!

W9YKX, Woodbine, Iowa, now works four states on consistent skeds — no mean accomplishment out there where states cover a lot of territory. In addition to the workouts with W9ZJB (200 miles) and W9NFM (235 miles), Bill now works W9USI who is back in Brookings, S. Dak. This is also a 200-mile hop, in the opposite direction to W9ZJB. Over in Omaha, W9YDC and W9UEV provide the fourth state, Nebraska. Now Bill is looking for someone in Kansas to add another spoke to the 400-mile wheel of which Woodbine is the hub!

112 MC. AND UP

WHEREVER u.h.f. population increases rapidly, the old problem of receiver radiation becomes a sore spot. The interference from the transceiver is worse when it is receiving than when it is serving as a transmitter, and most other super-regen receivers are nearly as bad. Yet it is not necessary that this be so. A few simple changes can be made in almost any super-regen which will hold its radiation to a minimum — and improve its performance, too. First of all, let it be borne in mind that *any* super-regen will cause bad local interference, even when an r.f. stage is used, if high-plate voltage is used on the detector. But there are several types of receivers in which interference can be reduced to a negligible value. The accompanying diagram, submitted by W2DZA, Teaneck, N. J., is an example.

Most receivers use the familiar center-tapped coil, with plate voltage fed into the tap. Antenna coupling to this coil provides plenty of output for the plate power, in this case. The receiver shown runs the plate at ground potential, from an r.f. standpoint, and antenna coupling is to the grid or cathode circuits. Many variations are possible, but in any case where the antenna coupling is to the grid or cathode, radiation can be held well down, if the plate voltage is operated at its lowest possible value. Let's see if we can't do something about these 112-Mc. transmitting receivers which ruin the band for all the gang for miles around. W2DZA and W2MWJ get along together — and they're only two blocks apart!

And while we're in the helpful-hints department, Charles E. Hunt, Tuckahoe, N. Y., says that the metal bases of loctal tubes can be removed easily if they are heated and the base forced carefully. Better see your service-man friends for some defunct tubes to practice on, but it's easy when you get the knack — and there is a world of difference in the way the tubes will work, and in the maximum frequency at which they can be made to oscillate. And did you

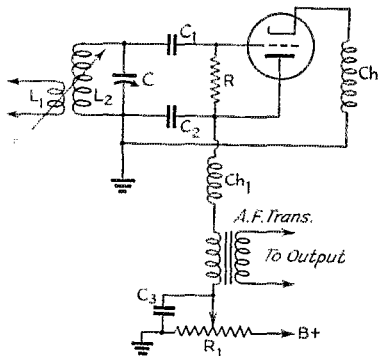

W2DZA's 112-Mc. non-radiating superregen

- L₁ — 2 turns hook-up wire, 1/8-inch diam.
- L₂ — 955 — 7 turns No. 16, 3/8-inch inside diam.
- 7A4 — 4 turns No. 16, 3/8-inch inside diam.
- 6J5 — 3 turns No. 16, 3/8-inch inside diam.
- C — Cardwell trim-air cut to 1 rotor and 1 stator (double spaced when using 955).
- C₁ — 0.0001- μ fd. midget mica.
- C₂ — 0.002- to 0.006- μ fd. mica.
- C₃ — 0.25- μ fd. paper.
- R — 10 megohms.
- R₁ — 100,000-ohm pot.
- CH — Ohmite Z-1.
- CH₁ — 2.5-mhy. choke.

Modifications

- R — Up to 30 megohms (or more) or 750,000 ohms to 2 megohms from grid to ground or across C₁.
- CH₁ — Use 10,000-ohm wire wound instead of choke.
- L₁ — Antenna may be coupled to CH. Three turns or so wrapped fairly tight around choke so that it can be moved along choke for best coupling.

see the characteristics on those 7V7 and 6SG7 tubes (April QST, p. 98) last month? There may be the answer to gain on 2 1/2 without pocketbook paralysis.

The Hartford Ski Club tried out 2 1/2 for race timing at the Connecticut Championships held at East Hartland March 9th. W1KXM, stationed at the top of the hill, transmitted the "Go" signal. The timer, at the other end, heard the signal on the rig of W1MYA. Clicking the stopwatch he was then ready to time the finish. KXM and MYA used Abbott transceivers, and were assisted by W1MPB using equipment loaned by W1LAL.

W6PPO writes of work in a plane by W6JCB. With a 10-watt pack rig on his lap, W6JCB maintained contact with W6PPO during a 45-minute flight from Chandler Field, Fresno, Cal., to Friant Dam and return. This was a forerunner of attempts to be made at working longer distances across the San Joaquin Valley this spring.

W6OVK, Tucson, Ariz., has been using a converter (1232-6J5GTX) on 2 1/2 for reception of W6QLZ of Phoenix over the 105-mile mountainous path, as mentioned last month. When Clyde used anything but crystal control, however, the going was rather bad, even though the i.f. used was around 18 Mc. So Jim hooked up a super-regen on 18 Mc. and fed the converter into this, and presto! — smooth quiet reception of signals of the frequency-modulated variety, with none of the characteristic drawbacks of the super-regen, tricky coupling, radiation, etc. This simplified version of the S.I.G. developed by the late Ross Hull should be well worth trying by anyone interested in improving reception on 112 Mc.

W7RT reports the gang around Seattle going strong for 2 1/2 in amateur radio defense work. Aircraft, mobile, and fixed-portable stations have taken part in maintaining emergency communication set-ups during the Seattle

(Continued on page 88)

Emergency Transmitter Design Considerations

A 25-Watt Output C.W.-'Phone Unit for 5-Band Operation

BY O. W. READ,* W2JHR, AND W. J. STILES,** W2MBS

THE minimum requirements that must be met in a truly modern emergency transmitter can be summarized under six headings. (1) The power output should be a full 25 watts. (2) Radiophone as well as telegraphy is an absolute necessity. (3) Construction must be such that any part of the equipment which fails under actual operation can be quickly removed and replaced without disturbing other components. (4) Power-supply requirements should be within the capabilities of a 6-volt automobile battery. (5) Antenna requirements must be non-critical to the extent of permitting practically any length of wire to be loaded at any frequency. (6) All connecting cables and other accessories must be standardized and simplified to the extent that, under emergency conditions, any civilian of average intelligence can put the unit into operation.

The fulfillment of the first consideration requires more than a glance over a tube chart. In our case it entailed the canvassing of radio service shops and other establishments handling radio tubes to determine what types would most likely be available during a prolonged emergency. Contrary to popular belief the 6L6 is almost universally available. This condition does not seem to apply to the 6V6 which is the next most acceptable type, especially for d.c. operation.

The question of e.c.o. versus crystal control is bound to come up in the design of such a universal unit. Ample thought was given this matter and as a direct result of experience obtained from

When reliable operation under emergency conditions is wanted, all sorts of factors must be taken into account. This article discusses the requirements and presents a transmitter design which meets them.

operating under emergency conditions the choice of crystal control was imperative. One crystal can be used for operation in three harmonically related bands and thus only three crystals permit at least one spot in each c.w. and 'phone band. Furthermore, very few amateurs start their careers with e.c.o. and therefore the man who hasn't already available at least a few crystals is rare indeed.

The design of the crystal oscillator is of major importance. The Tri-tet was selected not after the reading of a convincing article, but after a prolonged series of tests in which many types of oscillator circuits were checked with the assortment of crystals available. Its selection was influenced principally by that property which permits even the weakest of crystals to oscillate under practically all conditions. Crystal current, while not the lowest of the various circuits tested, was well within reasonable limits.

Original design called for a 6L6 crystal oscillator followed by another 6L6 operating either as a doubler or as a straight amplifier. After considerable experimenting the conclusion was drawn that such a line-up did not come within the requirements of simplicity as outlined under requirement number 6. As might be expected the neutralizing problem could not be made entirely fool-proof over such an extended range of frequencies.

The natural development in such a case was the use of an 807, but this seriously conflicted with our original desire to use only tubes commonly available. For emergencies this admittedly is a drawback, but the 807 is a sturdy tube and comparatively long-lived so that the original tube and one spare should more than outlast any emergency one is likely to encounter.

Power input to the 807 does not exceed 50 watts, even when used as a doubler, for the realization of the required 25 watts output. This puts a

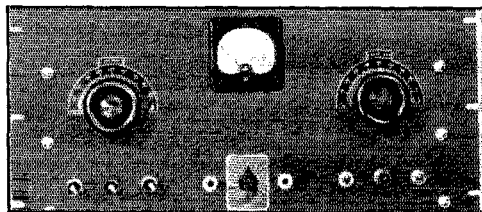

The front panel view shows a pleasing symmetrical appearance. Controls, etc., along the bottom from left to right are push-buttons for oscillator cathode current, amplifier cathode current, and modulator cathode current, microphone jack, audio gain control, key jack, standby switch, pilot light, power switch.

◆ This bottom view shows the ready accessibility of all parts in case replacement is necessary. Since this unit was intended for a.c. operation the filament transformer is permanently mounted in the chassis. Tuning condensers are mounted on small feed-through insulators.

◆

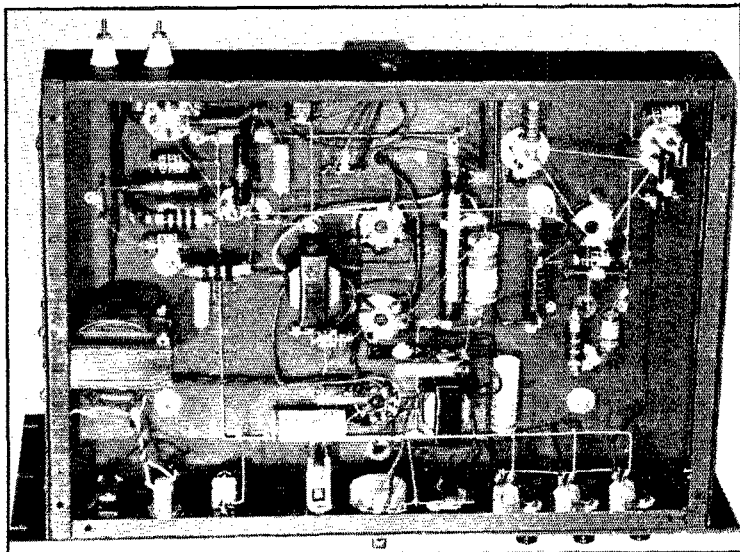

25-watt requirement on the audio system if full modulation is to be realized. Fortunately such output is well within the ratings of a pair of 6L6's, and their use helps to standardize the tube lineup. At this output the 6L6 tubes need barely be driven beyond Class "A", thus the plate voltage regulation and the speech amplifier requirements are simplified.

Returning to our tube survey we find that, for speech amplifier requirements, the 6C5 stands head and shoulders above other tubes from the standpoint of availability. Using a conventional telephone-type single-button carbon microphone the 6C5 furnishes ample gain to drive the modulators with only 12 to 18 ma. of microphone current. The low drain allows the current to be bled from the high-voltage supply and gives the single-button carbon microphone quality comparable with the average crystal microphone. The major advantage of using the carbon microphone, aside from its high output, is its availability, especially in an emergency.

The construction problem is one that cannot be given too much consideration. One has but to be isolated from repair facilities and experience trouble to realize the importance of this problem. The removing of a so-called "top layer" of resistors and condensers to reach a defective part is not only time-consuming but highly detrimental to one's physical stability, which has to be guarded during time of emergency. The heavy metal panel and chassis, for example, are far from contributing favorably to the weight/power ratio, but for the purpose under consideration are indispensable.

A feature not commonly found in such equipment is the use of push-buttons for taking meter readings. These not only have the advantage of

permitting the metering of three stages with one meter but allow the total drain to be observed at any time as well as the monitoring of any two stages at once. For example after the amplifier has been tuned and loaded to say 80 ma. and the modulator cathode current has been observed as normal, or 80 ma., both the amplifier and modulator buttons can be closed with the resultant reading of 160 ma. This permits observation of the modulator plate current swing and at the same time furnishes a constant check on the loading of the amplifier. The push buttons are easier to service than rotary switches and cannot be lost or left at home like a patch cord.

Two coil considerations should be noted. First the mounting of the coil sockets above the chassis so as to shorten tank leads, none of which are 1 inch long, and second the attachment of the 807 plate connection directly to each amplifier coil rather than to the condenser. The latter permits a complete additional turn to be added to the 10-meter coil, which produces a minimum plate current, unloaded, of 35 ma. instead of the 50 ma. formerly obtained.

Power Supply

One of the first questions always asked about any emergency equipment is from what source the primary power is derived. Before this question can even be touched the prospective builder must settle in his own mind whether he wants a lightweight unit which can be carried as a suitcase, or a heavier one built to stand up under long periods of operation and deliver a signal which will get through 24 hours a day, 365 days a year. To provide the latter a full 25 watts of output is necessary and this means you either use a.c. or arrange for a continuous stream of recharged batteries.

Practical experience has proved that it is as easy to transport a small gas-driven 110-volt a.c. unit as it is a motor-generator, a set of storage batteries, and a battery charger which in turn must derive its power from some external source. Consequently the present transmitter was designed primarily for a.c. operation but provision was made to eliminate all unnecessary power drain so that d.c. operation is practical.

The power-supply system is connected to the transmitter proper by a 5-wire cable terminated at both ends with an octal plug. The same cable is used regardless of whether the power is obtained from a.c. or the motor-generator set and storage battery. For this reason the two filament leads should be made of No. 8 flexible cable so as to guard against filament-voltage drop. The length of the cable is approximately 6 feet, as anything

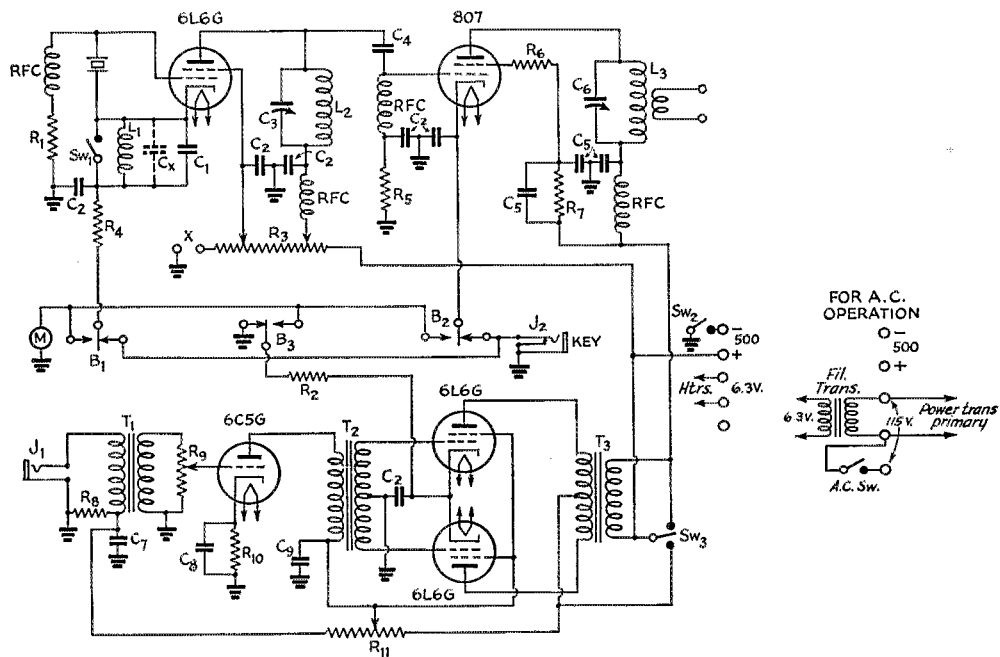

Fig. 1 — The emergency transmitter circuit.

- | | | |
|--|--|--|
| C ₁ — 100- μ fd. mica. | R ₃ — 25,000 ohms, 50-watt. | SW ₁ — Cathode shunting switch. |
| C ₂ — 0.01- μ fd. paper, 1600-volt. | R ₄ — 500 ohms, 10-watt. | SW ₂ — B-switch (operate/standby). |
| C ₃ — 75- μ fd. variable. | R ₅ — 50,000 ohms, 2-watt. | SW ₃ — Phone-c.w. switch. |
| C ₄ — 100- μ fd. mica. | R ₆ — 100 ohms, 2-watt. | M — 0-200 milliammeter. |
| C ₅ — 0.001- μ fd. paper, 1600-volt. | R ₇ — 15,000 ohms, 10-watt. | T ₁ — Microphone transformer (Stancor A4706). |
| C ₆ — 100- μ fd. variable, double spaced. | R ₈ — 1,000 ohms, 2-watt. | T ₂ — Input transformer (Stancor A4741). |
| C ₇ — 40- μ fd., 25-volt electrolytic. | R ₉ — 500,000-ohm volume control. | T ₃ — Modulation transformer (Stancor A3845). |
| C ₈ — 10- μ fd., 25-volt electrolytic. | R ₁₀ — 1500 ohms, 2-watt. | X — Shorted for a.c. operation, open for d.c. |
| C ₉ — 8- μ fd., 450-volt electrolytic. | R ₁₁ — 25,000 ohms, 25-watt. | |
| R ₁ — 20,000 ohms, 2-watt. | J ₁ — Open circuit microphone jack. | |
| R ₂ — 250 ohms, 10-watt. | J ₂ — Closed circuit keying jack. | |
| | B ₁ , B ₂ , B ₃ — Push-button switches. | |

Coil Data

All coils wound on 1½-inch diameter forms.

Cathode Coil, L₁:

- 1.75-Mc. crystal — 32 turns No. 22 d.s.c., close-wound.
- 3.5-Mc. crystal — 10 turns No. 22 d.s.c., length 1 inch; C_x = 100- μ fd. mica.
- 7.0-Mc. crystal — 6½ turns, No. 22 d.s.c., length ¾ inch.

Oscillator Coil, L₂:

- 1.75-Mc. crystal — 60 turns No. 28 d.s.c., close-wound.
- 3.5-Mc. crystal — 33 turns No. 18 enameled, length 1 inch.
- 7.0-Mc. crystal — 14 turns No. 18 enameled, length 1 inch.

14.0-Mc. crystal — 8 turns No. 18 enameled, length 1 inch.

Amplifier Coil, L₃:

- 1.75 Mc. — 60 turns No. 24 d.s.c., close-wound.
- 3.5 Mc. — 34 turns No. 20 d.s.c., length 1½ inches.
- 7.0 Mc. — 16 turns No. 18 enameled, length 1½ inches.
- 14.0 Mc. — 10 turns No. 18 enameled, length 1½ inches.
- 28.0 Mc. — 5 turns No. 18 enameled, length 1½ inches.

Power supply requirements for a.c. are 500 volts (under load) at 300 ma. For d.c. operation a 400-volt vibrator or motor-generator supply with as much current as possible will be satisfactory, but the output will be somewhat lower.

longer results in too much filament voltage drop and anything shorter tends to bring the motor-generator noise field too close to the operating position.

The transmitter has very little 60- and 120-cycle response, but is substantially flat from 200 to 10,000 cycles. This eliminates the need for an expensive filter and further insures against long break-down periods caused by failure of power supply components. Phone conversation is understandable with the filter choke shorted out, and the quality of the c.w. signal is unimpaired under the same conditions. Such operation is definitely of an emergency quality but does indicate the versatility of the unit.

Antennas and Adjustment

The antenna problem is unquestionably one of major importance. While most any wire can be made to take a load it is highly desirable to have a resonant antenna if the best results are to be realized with the power available. For this reason a twisted pair doublet should be made up for 80 meters. For other frequencies the antenna tuner of Fig. 2 will provide a means of matching the doublet, with the feeders connected together, to the transmitter. The use of a 66-foot wire, end fed, is another simple way of working all amateur bands with a minimum of antenna equipment.

To put the transmitter in operation the following procedure may be used: (1) With all tubes removed adjust the oscillator voltage divider so that the plate voltage is 450 and the screen voltage 250. (2) Put in the modulator tubes and adjust the screen voltage until they draw the normal 80 ma. cathode current. (3) Insert the oscillator tube and with a flashlight bulb and a loop of wire tune for maximum output. This point of maximum should appear at the point of minimum plate current when doubling in the oscillator stage but when working straight through it does not. (4) Insert the 807 and tune for resonance, then quickly shut off the plate

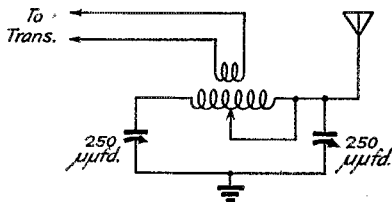
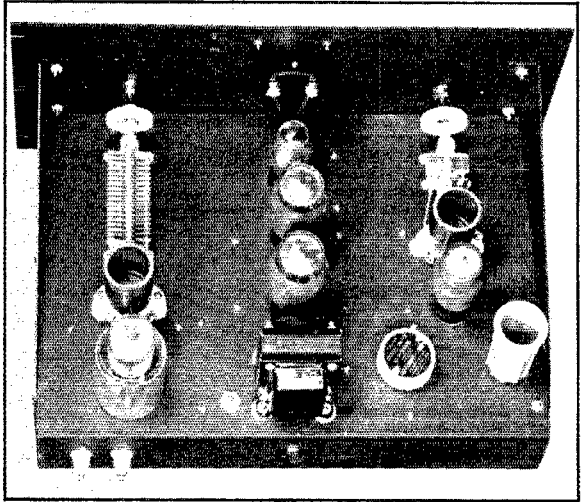

Fig. 2 — Pi-section antenna-coupling filter for working into random-length antennas. The inductance may consist of 20 or so turns tapped every two or three turns, wound with No. 12 wire on a 2-inch form. Link turns should be adjusted by trial to give optimum loading.



Looking at the top of the chassis from the rear. The oscillator section is at the right, modulator and speech amplifier in the center, and amplifier at the left. The 'phone-c.w. switch is just to the left of the modulation transformer. The key of the oscillator tube socket should face the right-hand chassis edge to permit short, direct leads to the coils.

voltage. A resonated and unloaded 807 doesn't last long in any transmitter. (5) Normal loading for the 807 is 80 ma. on 'phone and 100 ma. on c.w. This degree of loading should now be obtained and the 807 grid current noted by plugging a meter into jack J_3 . The operating grid current should be between $1\frac{1}{2}$ and 4 ma. and is controlled by varying the screen voltage on the crystal oscillator. Naturally different coil combinations will alter this grid current but by a little experimenting a point will be found where it is within the limits mentioned over the whole range of frequencies. (6) For c.w. operation the 'phone-c.w. switch should be put in the c.w. position. The switch shown may seem a little small but it has been in use for some time and is fully capable of doing the job.

While the 807 behaves very well — even under modulation — as a doubler it is advisable to run it straight through whenever possible. The oscillator can be used either straight through (switch SW_1 closed) or as a doubler (SW_1 open) thus providing three output frequencies with each crystal. The oscillator can be made to quadruple but this form of operation is not advised.

Most articles on this type of equipment end with an explanation that while the prospective builder is awaiting an emergency the unit makes a fine station exciter. If for no other reason than just to be different we are going to modify our statement to the extent that the completed unit makes a fine station transmitter. Crystal keying, 100% modulation with excellent quality, and 25 to 30 watts on all bands doesn't leave much to be desired from a transmitter in its price range.

Code Proficiency Program Expanded

**Practice Sessions Lengthened—WIAW Adds Day Qualification Run
May 6th—Flash! Method of Using WIAW Runs for
Improving Your Sending**

BY F. E. HANDY,* WIBDI

In addition to an extension of the Code Proficiency Program schedules for practice which will double the time given for "mill copy" at each speed, the article includes suggestion of a method by which you can get *sending practice*. QST lists herein practice texts and references covering WIAW practice transmissions on three days of the six practice schedules of each week. Try these schedules for the next several weeks and let us know how you make out.

PROFICIENCY in handling code is a matter of such importance to Uncle Sam that every amateur radio licensee has to pass a code test before he is given his license. Many of the new defense jobs opening up for amateurs require specified code ability. Amateur operating, when confined to code work, automatically increases the proficiency of every ham given a license through his on-the-air endeavors.

Advanced proficiency is so very desirable for all radio amateurs in times of national stress that the League has set up a special program to recognize Code Proficiency above the license requirements, and to assist and encourage everyone of the 56,000 F.C.C. amateur-licensees to *increase* code and operating ability above the speeds that can be initially demonstrated. The program is broader than any classifications of amateur interest. All amateurs are invited to participate. For every *four* of the thousands of amateurs who hold Code Proficiency Certificates *one* amateur already has increased his copying speed by five words per minute or more since starting the program! 25% of those receiving stickers have gained 10 w.p.m. or more on their first attainment. Many of those who are polishing off their ability to put code down on paper are also practicing the art of putting "ten on a line" on a mill. Radiotelegraph procedure is the basis for the modified procedure used in radiotelephone work in the services. To get this basic procedure many amateurs are supplementing plain copying by making code schedules and handling traffic, the kind of brass-pounding that has most value in cultivating systematic operating *procedure ability*. For best progress about 30% of the advanced man's practice time should be spent in transmitting code. A method for getting sending practice from WIAW has now been evolved.

* Communications Manager, A.R.R.L.

WIAW Practice Schedule Expanded

Every amateur operator licensed by the F.C.C. is invited to use WIAW code practice. This is sent nightly — except Friday. Look for WIAW on the frequency that comes in best at your location: 1762-, 3825-, 7150-, 14,253, 28,510-, or 58,970 kcs. Effective April 27th, the code practice runs will start at 9:45 p.m. EST (6:45 p.m. PST), the tape transmitter operating progressively at 15-20-25-30-35 words per minute. Besides the practice run time which is now to be doubled, giving ten minutes for copying practice at each speed, or 50 minutes in all, the official messages "to all radio amateurs" are sent at 8:30 p.m. and midnight EST by tape and give opportunity for additional practice. A readjustment of other schedules was made to permit sending twice as much practice. We hope a great many amateurs will enjoy the increased copying time made possible. We also hope it may assist many licensees to get their stickers attesting to advance from a first qualifying speed sooner.

How to Get Your Certificate

For those not yet equipped with the quality certificates that A.R.R.L. has provided let us pause here to explain how to get your copying Proficiency Award in connection with this national and patriotic amateur program. To take part in the program adds to the accomplishment record of the amateur. In addition to getting the recognition due you personally, your effort (at whatever speed) is your part contributing to the proof that amateur radio is really a self-training school, the sum total of the A.R.R.L. program making amateur radio more secure for all amateurs . . . a defense program for the nation and for the amateur combined.

To get the Proficiency Certificate in connection with this national program get daily copying

Win This Certificate Recognition of your Proficiency and Attainment — Endorsement Stickers are given for each Increase in Proficiency Shown to 35 w.p.m. — You will find the Code Proficiency Program interesting. A Certificate at 15 w.p.m. (or any speed) can be Your Contribution to the Patriotic Cause of Demonstrating the interest of All Amateurs in Attainment. The Article Tells How — Start Today!



practice, using W1AW, commercial press transmissions, traffic, etc. to get your hand in. Then be sure to be on hand on the date of one of the announced *qualifying runs*. These are sent from W1AW on preannounced dates at the usual practice time. The official text, sent after preliminary explanations, lasts about 25 to 30 minutes. You are invited to copy the test text at the best speed possible on our next qualifying run. Underline the *full minute* of perfect copy that you believe qualifies you at any speed. Tell us if you are working for a first certificate or an endorsement sticker, and add a statement that you copied by ear without aid (except typewriter or pencil) from others. Send this to us, advising if taken off the air by typewriter or pencil, and we will check your paper with the official text, writing you of your success or failure, and sending

your appropriate AWARD at the speed for which you qualified within about thirty days from the date of the run.

Added Schedule of Qualifying Runs

The next *qualifying runs* follow fifteen minutes of advance notice transmission (to enable listeners to tune in as well as to explain what is taking place) starting on the dates and at the times indicated:

- May 6th (Tuesday) 1:30 P.M. EST. Official Run at 1:45 P.M. EST.
- May 14th (Wednesday) 9:45 P.M. EST. Qualifying Text starts at 10 P.M. EST.
- June 1st (Sunday) 1:30 P.M. EST. Qualifying Text starts 1:45 P.M. EST.
- June 17th (Tuesday) 9:45 P.M. EST. Qualifying Text starts 10 P.M. EST.

(Continued on page 62)

SUNDAY-TUESDAY-THURSDAY W1AW CODE

Practice Subjects for April 27th to June 1st
(See April, 1941, QST)

Start	End
Apr. 27. Page 9, <i>Hamming on Howland Island</i> .	On page 11.
Apr. 29. 4th par., page 11, to end. <i>A Hurricane-Proof Mast</i> (p. 12).	To last par. on page 12.
May 1. Last par., page 12.	To end, bottom of page 76.
May 4. Last par., page 76, page 78 to end. Start <i>A Bugless 5-Meter Transmitter</i> .	To last par., page 16.
May 6. Last par., page 16, cont. page 58 to end. Start <i>Some Thoughts on Keying</i> , p. 18.	Through 15th line, 2nd col., page 18.
May 8. Start 16th line, page 17, 2nd col.	End of 2nd par., 2nd col., page 20.
May 11. Start 3rd par., 2nd col., page 20.	End of article on keying.
May 13. <i>What the League is Doing</i> . All page 22. Then: <i>A Compact Portable Emergency Transmitter</i> , page 24.	At first new par. on page 25.
May 15. Start 2nd par., page 25 and finish article. Then: <i>U.H.F. Superhet Design</i> , page 27.	To last sentence on page 27.
May 18. On May 18th W1AW omits a code practice session for another membership program.	
May 20. Start with last sentence on page 30 and finish article. Then: <i>A Portable Emergency Transmitter</i> . . . , page 32.	At first new par., page 33.
May 22. At first par., page 33.	At first par., page 86.
May 25. At first par., page 86. Then: <i>A Dual Diversity Preselector</i> , page 37.	At 3rd par., 2nd col., page 38.
May 27. At 3rd par., 2nd col., page 38.	On page 82.
May 29. <i>The QSL-25</i> , page 40 (start with box).	First par., 2nd col., page 42.
June 1. First par., 2nd col., page 42 to end of WWV Schedules. Then: <i>Ham Shacks</i> , page 45.	To near end of page.



HINTS AND KINKS FOR THE EXPERIMENTER

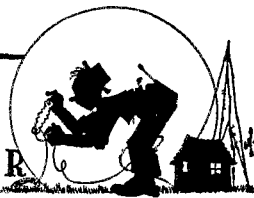

WARNING TO USERS OF TRANSFORMERLESS-POWERED EQUIPMENT

UNDERWRITERS' LABORATORIES recently issued a warning regarding the design and use of transformerless or "a.c.-d.c."-type power supplies or equipment operating from such supplies, stating that five recent deaths had been reported in the Chicago area due to contact between the chassis and ground.

In most h.c. receivers, the chassis is enclosed in a plastic case with no opportunity in normal usage for contact with the chassis. Nevertheless, in correctly-designed receivers, no d.c. connection is made between the circuits and the chassis. The only electrical connection to the chassis is through a single condenser between the chassis and the negative side of the rectifier supply.

Recently several small units of ham gear operating from transformerless supplies have become quite popular. The usual practice is to

build the unit up on a metal chassis with no protection against personal contact with the chassis. In such cases, special precautions should be taken to make certain that there will be complete safety in making contact between the chassis and ground.

The most fool-proof way to insure against injury is always to connect the chassis to a water pipe or other actual ground. If this is done, the worst possible result is a blown fuse in case the line is not correctly poled. To avoid fuse-blowing with incorrect polarity, attention is called to the scheme suggested by W8CMP in the Hints and Kinks section of *QST* for November, 1940, in which only a single connection is made to the power plug. The essentials of the circuit are shown in Fig. 1. *A* shows connections where the negative side of the supply is normally grounded, while *B* shows the connections for a grounded positive which is usually required in bias supplies.

The chassis must be connected to an actual ground to complete the 115-volt circuit. If the plug is inserted in the wrong direction, no circuit is completed and the supply is inoperative; the supply will operate only when the plug is polarized correctly.

In cases where a d.c. output connection from the unit is not required (unit self-contained) it is a good idea to follow approved h.c. practice and insulate the circuit from the chassis. Even in this case, however, the actual ground connection to the chassis is advisable to avoid every possibility of injury.

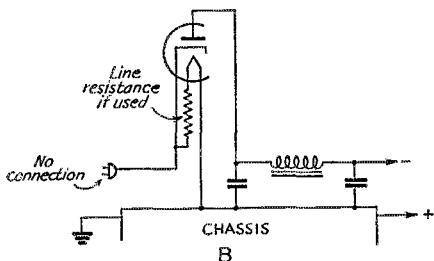
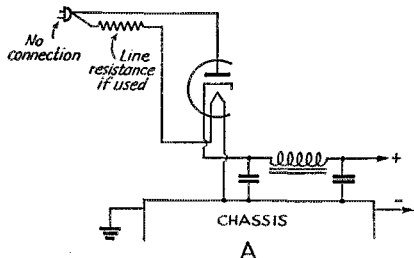

Fig. 1—Exposed chassis of a.c.-d.c. equipment should be grounded to avoid danger of personal injury. The circuits shown avoid the possibility of fuse-blowing with a grounded chassis by making the ground connection part of the 115-volt return circuit. Only one connection is made to the power plug. *A*—Connections for supply with grounded negative. *B*—Connections for

SINGLE-SWITCH CHANGE-OVER SYSTEMS

THE diagrams shown in Fig. 2 show three systems for doing the entire job of change-over from transmitting to receiving with a single switch and, in spite of this, no multiplicity of relays is required.

The arrangement shown at *A* is used by W2JRG. S_1 closes the circuit through branches 1 and 2 which include all filament transformers and plate transformers for the speech amplifier. S_2 is the main change-over switch. It is a double-pole double-throw toggle switch which was mounted on the receiver panel in place of the original s.p.s.t. "on-off" switch. When thrown to the right, the circuits through branches 3, 4 and 5 are closed. Branch 3 includes all high-voltage transformers required for the exciter and final ampli-

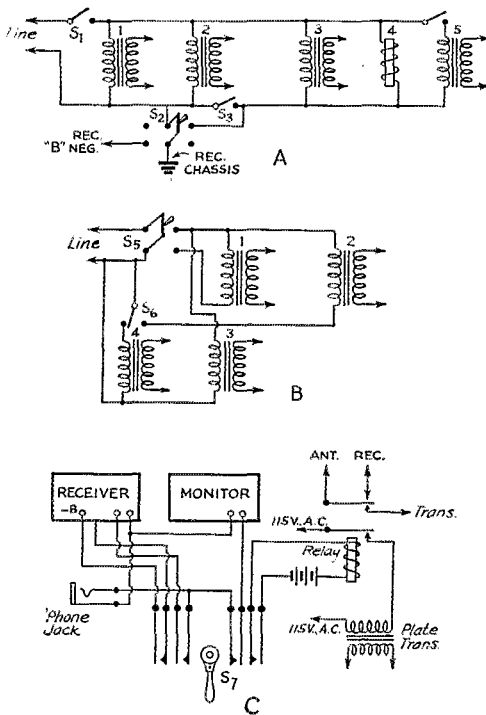

Fig. 2 — Change-over switching systems requiring only a single control switch. See text for discussion.

fier. Branch 4 is the antenna change-over relay, while branch 5 is for the plate supply to the modulator. When S_2 is thrown to the left, the high-voltage circuits are opened and the receiver plate-supply circuit is completed. In the "transmit" position, the receiver plate-supply is open.

S_4 is used to cut off the plate voltage to the modulator for c.w. operation. S_3 permits the receiver to operate while S_2 is thrown to the "transmit" side for monitoring purposes. W2JRG says he has used the ordinary 35-cent toggle switch to handle all the current required for his transmitter which he operates with 300-watts input to the final amplifier.

The system, shown at B, is similar and was suggested by VE1DU. S_5 is a d.p.s.t. push-button switch which closes the circuit to all transmitter filament transformers which are connected in parallel in branch 1. This switch also turns on the separate filament transformer in branch 3 which has been installed in the receiver.

S_6 , the main control switch, is a "three-way" push-button switch connected as a s.p.d.t. switch. Turned to the right, S_6 closes the circuit to branch 2 which includes all high-voltage transformers. When the switch is thrown in the opposite direction, the plate voltages are turned off, while the plate-supply transformer for the receiver in branch 4 is turned on.

W6JZJ's arrangement, shown in Fig. 2C, differs somewhat from the two previously described. S_7 is a multi-pole double-throw switch of the "anti-capacity" type. When the switch handle is thrown to the left, closing the contacts on the right side and opening the contacts on the left side, the headphones are connected to the output of the monitor, the receiver "B" supply is turned off and the antenna relay operated to connect the antenna to the transmitter. This relay, which is a revamped telegraph sounder, is fitted with an extra set of contacts for opening and closing the supply to the high-voltage transformer supplying the final amplifier.

When the switch is thrown to the opposite side, the plate power to the final is cut off, the antenna is shifted to the receiver, the headphones are returned to the output of the receiver and the receiver "B" supply is turned on.

SOMETHING NEW IN SIDE SWIPERS

FOR the benefit of the stiff-fingered or those with hair-bound knuckles, for infectees of Charlie-horse, for those with glass arms or fingers that are all thumbs — we suggest a way out; by offering to this class of suffering Hamdom a workable foot pedal that really eliminates many of the disadvantages of the straight key and at the same time permits stepping into the semi-speed field. We present the new floating bar contact of the side swiper in the swaddling clothes of 1941.

From the sketch of Fig. 3 one may dope it correctly that the whole assembly is mounted on a rather heavy brass plate about 5 by 6 inches, which in this case was originally an engraved



Fig. 3 — Constructional details of W1PV's side swiper with the floating contact bar.

litho plate, rigged sunny side up and topping a wooden base for appearance.

The innovation is the floating contact strip which introduces elements which make for easier formation of characters. The controlling lever may be hacked and filed out from a solid bar of brass or made up from heavy flat strip as shown in the sketch. Holes in the control bar are drilled to clear the contacts on the spring strip which may be made from a corset steel (if you can find one) or anything similar.

All metal parts are vanadium-plated which contrasts nicely with the black-enameled supporting wooden base. Depending upon the spring used, some damping may be found necessary, but this is by no means a problem. Use a small-diameter rubber band, about a half-inch wide, strung

(Continued on page 60)



CORRESPONDENCE FROM MEMBERS

The Publishers of *QST* assume no responsibility for statements made herein by correspondents.

"A CALL TO 'PHONE MEN?"

127 Graham Ave., Whitewater, Wis.

Editor, *QST*:

Regarding your editorial in the March issue of *QST*, I think you have been misled . . . about the lack of 'phone nets. Maybe out your way there are few good 'phone nets, but here there are so many using specific operating procedure and trying in every way to improve their procedure and operating ability that they interfere with each other a great deal. There are very active nets that I hear continually in this area on 3930, 3940, 3942, 3945, 3950 (two on this frequency besides W1AW), 3955, and 3990. . . . I don't listen very much on 160 but I know that there are many active nets there, too.

Maybe some figures would help. In the A.A.R.S. report for the month ending December 15, 1940, the total A.A.R.S. membership was 1404 c.w. and 764 'phone stations in the whole country. In our Corps Area (sixth), the score is 106 c.w. and 203 'phone, necessitating the introduction of a waiting list for 'phones and an urgent request for more c.w. stations. Now don't say, "Well, look, there are nearly twice as many c.w. men as 'phone men in the A.A.R.S.," because I'll say there are probably three or four times as many hams that operate c.w. most of the time. Of course, the A.A.R.S. doesn't represent the greater part of hamdom by any means, but it is a good cross section of it.

I am very much in favor of your statements that there are many 'phone men who have neglected their c.w., that there is a lot of senseless drivel on the band, that there is a great deal of thoughtless operating and that we have a great need for better operating and operators, but *please* don't paint such a dismal picture of us 'phone men before you get the facts. We are really trying to improve our operating technique and we have more nets now than we have room for in the traffic-handling bands. You are right when you say that we need better operating procedure. We need a greater percentage interested in the improvement of the art, and the nets we now have need improving plenty, but before you give us too black an eye, there are a few things you must remember. First, it is much easier to listen to and follow a 'phone conversation, thus showing the flaws in operating far more than in c.w. conversation. Second, we talk somewhere in the neighborhood of one hundred words per minute and, comparing that with a fast c.w. gab, it gives many more opportunities for glaring errors. Multiply the first statement by the second and it spells real trouble for us 'phone men. Third, c.w. nets don't have half or even a quarter the QRM to deal with that the 'phone nets have; I know because I work c.w. and 'phone nets regularly. Fourth, don't forget that most 'phone men work c.w. at least some but in comparison very few c.w. men work 'phone, so I think you c.w. birds still have a great deal to be desired in numbers of active men if not in quality. I'm glad to admit that the c.w. nets are doing a fine piece of work and are very efficient, and I'm proud to be a member of one of them, but I will not admit that the 'phone men are not doing their full share of this defense work. We want to do it and we are. . . .

— M. C. Sayre, W9MIJ-WLTX

202 Carew St., Chicopee Falls, Mass.

Editor, *QST*:

Having read your article in March *QST* three times and still running a temperature over 108°, I must take pen in hand and give vent to my hurt if not outright fractured feelings.

I am an active licensed ham of some five years, and a member of our League. I have nothing but the best regard

for hams and ham radio. It has become a very large part of my and my family's life. But, Mr. Warner, you have rubbed me the wrong way. Contrary to your most profound attempt to make it otherwise, it is still a *hobby* and not a profession. Please let — and help — us keep it that way. Why must an amateur be advised or even coerced by certificates, etc., to apply him or herself to messages, traffic handling, and why, above all, necessarily c.w.?

We are in radio for the relaxation and amusement plus knowledge it may afford, not as a service benefactor for the League, government or private individual. If we like traffic handling, okay; c.w., okay; rag-chewing on 'phone, okay — but please let us follow our own inclinations and moods. Knowing with full conviction that each and every one of us would and are doing all we can to help defend this grand big island of ours, I say don't keep shoving a crisis in front of our noses. There is no such thing and I pray and hope there never will be. . . .

Why don't you fellows realize that a 'phone man is just as much a ham as a c.w. man? Give him the same consideration and breaks the c.w. man gets, and then see if he will cooperate.

He's a funny individual and doesn't like to be pushed, yet you admit trying to push him into practicing procedure, forming nets and trunklines, handling third-party messages, etc. Why shouldn't he shun you? Maybe he doesn't like to handle messages.

Maybe he doesn't like nets and procedure.

Maybe he just likes to gas. Let him — it's his *hobby* — not his *duty*!

Traffic is only one phase of amateur radio, c.w. another. I don't like spinach — maybe you do! But I don't eat spinach — would you?

Mr. Warner, please don't let or make the A.R.R.L. run us. It's ours; let us run it. We want it to be nonpartisan, but it most certainly hasn't been so far.

The 'phone man begs you to see us as we are — amateurs and experimenters — aimless gassers but happy in our own way!

Please let it be our own.

— Fred H. Allen, WIKUW

Error's Note. — The Communications Act of 1934 provides for the issuance of a radio station license only "if public interest, convenience and necessity will be served thereby" (Sec. 307(a)). Every applicant for facilities is required to make an affirmative showing that operation of his station will be in the public interest. In the case of applicants for amateur licenses, the individual is not required to make a personal showing because A.R.R.L. has done so on behalf of the amateur body as a whole.

But this does not mean that WIKUW or any other amateur is justified in operating his station solely for the "relaxation and amusement it may afford." He has a definite public service responsibility, just as much so as the broadcasting, police radio and all other classes of stations.

Bellefonte, Pa.

Editor, *QST*:

. . . I heartily agree with your line of thought, particularly that portion referring to 'phone operation. There is certainly a decided need for system in operation of 'phone transmitters. This has been noticed here on several occasions during emergency operation. I have had my share of this type of operation and therefore speak from experience. The 1936 and 1937 floods kept me busy. I am and always have been a 'phone man, and hope to continue as such. . . .

(Continued on page 88)



OPERATING NEWS

F. E. HANDY, WIBDI, Communications Mgr.

J. A. MOSKEY, WIJMY, Asst. to the Coms. Mgr.

Field Day! With the F.C.C. action authorizing portable operation June 7th-8th for those participating in A.R.R.L.'s Field Day the stage is set for the usual successful annual activity dedicated to testing emergency powered portables. A bulletin suggesting club building and planning, including a local Round-Up meeting to get all amateurs and equipments lined up has been sent all affiliated clubs. The 9th A.R.R.L. Field Day Contest will resemble its successful predecessors in most respects. The rules will follow the setup indicated in *last* June *QST* except for such modifications as accepted by the seven-man "rules committee" which will be detailed with the final announcement next month. Get your self-powered sets in readiness. See you in the F.D.!

Red Cross Test Becomes History. The April 4th test by the American Red Cross of amateur radio message handling facilities was enthusiastically supported. *QST* will give the highlights as soon as all reports are in hand. League Emergency Coördinators swung into action to designate starting stations. Amateurs by the hundreds got good training from relaying the test messages. The Test had other important results: It added registrations to the A.R.R.L. Emergency Corps (2931 members) bringing to 621 the number of Emergency Coördinators. The American Red Cross is the primary agency for administering emergency relief. All amateurs contacting Chapters learned something of the practical communication needs of the agency served. Red Cross chapter officials in turn learned more about the nature of amateur radio communication; whom to call upon when amateur radio may be needed! All publicity noted was favorable to both organizations. Good will continue to flow from the Test and the exchange of information. Analysis of strengths and weaknesses will make possible continued organizing progress. Emergency Coördinators will continue to extend the registration of amateurs, and their plans for giving best service to the American Red Cross and other agencies with need for radio in the light of any possible contingency. Every amateur is asked to assist in this.

Belong to A.R.R.L.'s Emergency Corps. The privilege of registration in the corps is open to every U. S. licensee. Each year this group of amateurs volunteering willingness to aid the public interest systematically in the event of emergency need for radio communications becomes

larger, though records are overhauled annually. Through the June Field Day tests more corps members build and test self-powered equipment, and become skilled in using it coöperatively. The emergency-prepared group assumes increasing importance each passing year. The Corps is dedicated to serve the Red Cross and officials or agencies that require communications when the wire service is overloaded or becomes nonexistent. Emergency Coördinators are needed to carry on a local program of registrations and planning, and represent the amateur service in every county jurisdiction of the American Red Cross. They are the captains and organizers, in many cases selected from the Emergency Corps registration list. *May we suggest that right now, every amateur not yet registered in the a.e.c. either fill out the Emergency Corps blanks that are as near as the local Western Union Telegraph office . . . or drop a postal or send a message to A.R.R.L. Hq. asking for the duplicate forms to be filled out.*

Be Watchful! Avoid Trouble! F.C.C.'s Order No. 72 prohibits U. S. radio amateurs from engaging in foreign radio communications. Due to recent developments, it is recommended that all amateurs be alert for any calls from such stations as the following, and alert to advise any unsuspecting amateurs who might be taken in by any pretense. D4CVK operating on 14 Mc. is said to have "made his prefix into K4" to draw reply from a W amateur. XE1AM and HK1AK on 28 Mc., CM2RL, CM5FL, CMS2J, etc., on 7 Mc. are also reported to have called certain W's this past month, although unlawful for W's to work with them. Indignant W's are reporting the practices and calls to F.C.C. and to us. This is just to repeat what we said on the subject in this section last month and to call for your continued watchfulness. Thanks.

N. Z. Recognition of Amateur's Value. From the N. Z. A.R.T.'s "Break-In" we note with interest that even in war time in New Zealand, "emergency licenses have been issued to three amateurs in Hamilton to permit them to possess emergency radio apparatus . . . and in Wellington selected amateurs, members of the R.E.C., have been given permission to retain their transmitting apparatus . . . which is to remain sealed at the moment." It is all part of an Emergency Precautions Scheme coöperating with Home Guard on radio links, which plans go forward under local E.P.S. committees. The appropriate groups acting in an advisory capacity

to the United States government's D.C.B. may note with interest the confidence placed in amateurs under wartime conditions in N. Z. Amateurs are being assigned their part. Here in the United States we look forward to our coming A.R.R.L. Field Day Tests in June. Operating proficiency and skill in giving planned emergency communication make us fully ready to establish emergency radio links on any occasion that it might be required. This N. Z. item reminds us how important it is for each amateur to get into all worthwhile amateur organization programs to make himself so skilled, proficient, and useful that under all circumstances the amateur will receive governmental recognition "in the public interest, convenience and necessity" as our Communications Act puts it!

Next WIAW Qualification Runs. For your information we tabulate herewith the next four qualification dates. See full details on frequencies and on the Code Proficiency program expansion elsewhere in this issue:

Day Runs:	
May 6th (Tuesday).....	1:30 P.M. EST
June 1st (Sunday).....	1:30 P.M. EST
Evening Runs:	
May 14th (Wednesday).....	9:35 P.M. EST
June 17th (Tuesday).....	9:45 P.M. EST

Progress in proficiency in code reception is shown after the initial test and certificate award by a separate dated and initialed Endorsement. This is arranged for display on the certificate. The Silver Endorsement Stickers come in distinctive designs for each speed. All United States amateur operators may try for the progressive endorsements, once they win a certificate recognition at any speed. Practice runs now are sent at 15-20-25-30-35 w.p.m. rates (progressively) daily-except-Friday from WIAW. Every F.C.C. licensee is invited to go "all out" for our Awards by sending in copy transcribed by his personal efforts on one of the above qualifying runs. Get your certificate . . . then the progress awards!



— F. E. H.

Rotary Hams Hobnob

It is customary for Rotary clubs lying in fairly close proximity to each other to hold intercity meetings from time to time. An out-of-the-ordinary "intercity" meeting was held March 13th via the 28-Mc. band. This unique get-together was planned by Dr. M. C. Hecht of the Rotary Club of Wilmette, Ill., known to his ham brethren as W9IJX, and Kenneth Bryan, K6MUV, President of the Wahiawa-Waialua, Hawaii, Rotary Club. Other Rotarians who participated in the meeting were W4EDD of Miami, Fla., and W5HDD of Alamogordo, N. M. These chaps are wondering how many of their brother members are hams and would like very much to hear from all Rotary amateur operators, with their call letters and frequencies used.

ARTICLE CONTEST

The article by Mr. R. C. Miles, W9KBL, wins the C.D. article contest prize this month. *We invite entries for this monthly contest.* Regarding subject matter, we suggest that you tell about what activity you find most interesting in amateur radio. Here you will find an almost limitless variety of subjects. Perhaps you would like to write on working for code proficiency, Emergency Corps planning, traffic work, working in Section Nets, Phone and Telegraph operating procedures, holding a League appointment, working on radio club committees, organizing or running a radio club, the most interesting band or type of ham activity, or some other subject near to your heart.

Each month we will print the most interesting and valuable article received. Please mark your contribution "for the C.D. contest." Prize winners may select a bound *Handbook*, *QST* Binder and League Emblem, six logs, eight pads radiogram blanks, DX Map and three pads, or any other combination of A.R.R.L. supplies of equivalent value. Try your luck!

Log Keeping

BY R. C. MILES, W9KBL *

THERE are probably as many different ways of keeping an amateur station log as there are amateurs. However, certain fundamentals must be adhered to in order that the rules and regulations of the Federal Communications Commission are not violated.

Many hams, either because of ignorance or because they just don't care, keep logs which are not in compliance with the law or keep no logs at all! The finger of suspicion is moving faster and stopping more often these days. One never knows when the Radio Inspector may drop in for a friendly chat — armed with a warrant. A properly-kept log has saved many a license.

One of the most common faults in log keeping is failure to log every transmission. Each CQ, unsuccessful call, test, and QSO must be logged. This applies during contests the same as any other time. There are no exceptions. Incidentally, when you test be sure to sign your call at least once every ten minutes. (One of the fellows you are QRM'ing may want to drop you a line and tell you how your e.o.o. sounds.)

If you want to use one of the columns on the log page for other than its intended use as indicated at the top of the page, be sure to make the proper changes in the column headings on every page of the log. Using the ARRL log as an example, it will be seen that the column between the two RST report columns is for the frequency or dial setting of the station heard or worked and is not intended as a place to list the frequency of your station for the transmission in question. This should be placed at the top of the page in the space provided and any changes should be noted in the "Remarks" column.

While the column to the left of the "Remarks" column is headed "Time of Ending QSO," it is advisable to indicate also the time of ending an unsuccessful call if that call is the last transmission of a period of operating. The time of closing the station should be recorded in the "Date-Time" column and "QRT" indicated in the "Remarks" column.

The blanks on the inside cover of the ARRL log should be filled in completely, as necessary data are contained there. If an operator other than the one indicated on the cover of the log uses the station, he should sign his full name, not just his initials, opposite every transmission for which he is responsible. If more than one operator uses the station frequently, the signatures and initials of the operators may be

* 906 Vine St., West Lafayette, Ind.

placed at some prominent place in the log together with a statement that an operator's initials in the log indicate that he was the operator during the transmission for which they appear. Then, and only then, is it permissible to sign initials only. Of course, every person who speaks into the microphone of a 'phone transmitter is required to sign the log.

Aside from the legal aspects of log keeping, there are many ways in which a well-kept log can add to operating pleasure in addition to producing a justified pride in a neat station record.

Of course, the other station's location and the operator's nickname may be listed in addition to any other information about the operator or station which is kept for future reference. If you send a QSL, indicate that fact. Information such as this is valuable only if it is readily accessible. It is a good idea to number each QSO, placing the numbers in the right-hand margin of the log page. An alphabetical record by call letters of stations worked and the number of the QSO with each station may be kept in a separate notebook or card file. When a station is worked a second or subsequent time, the number of that QSO should be listed also. Thus, it can be ascertained immediately whether a particular station has been worked, how many times, and where in the log book to find additional information. A record of this sort is well worth the small effort it requires.

A record of traffic handled for each QSO, if kept as suggested in the ARRL log, will greatly facilitate figuring totals at the end of the month.

Any equipment changes, special circuits used, or any difficulties encountered may be recorded in detail on the blank left-hand pages.

Special means may be used in special cases to make log keeping more enjoyable and more effective. For instance, here at W9KBL the chief interests are operating contests, traffic handling, and Official Observer work. The log for contests is kept in green ink, and for transmissions logged for Official Observer notification in red ink. Thus, it is apparent at a glance what type of work was in progress during a particular operating period.

Keep a careful, complete log. You will enjoy your hobby more.

Addendum — 1939 DX Competition

AT THE request of Lieutenant A. W. Greenlee, U.S.N., W4HGM ex-K6NYD, a contestant in the 1939 DX Competition, the following statement is published:

STATEMENT OF K6NYD

"K6NYD bases its claim that it was not off-frequency at the time charged, on the evidence that over a period of fifteen minutes (which period includes the time at which the disqualifying citations arose) it was given eight direct checks by Naval Radio (which activity is a sub-frequency standard, and has for many years been used by amateur and commercial stations in this area), and was during this fifteen-minute period constantly logged at 14,247.0 kc. The checking station was at the time operated by regularly-assigned personnel. The station's frequency meter has been approved by the Bureau of Standards, which recognizes 'no tolerance of error' (excerpt from instruction book and calibration chart). This check was officially requested and received by K6NYD. The official report was forwarded to the A.R.R.L. Communications manager.

"The frequency as reported checked within 100 cycles with the frequency meter of K6NYD which is of the crystal calibrator type combined with a dynatron oscillator, in accordance with the best engineering principles. It is temperature-controlled, temperature-compensated, and voltage-regulated, in addition to being wired with power on twenty-four hours a day. It is a separate and distinct unit from the frequency control section of the transmitter. This frequency meter is also of the continuous monitoring type and so arranged that a 4000-cycle variation of the transmitter fre-

quency from the frequency meter causes a warning howl in the operating room and prevents modulation of the transmitter. During this contest period, results of a direct check from W1AW using special frequency measuring equipment showed an error of 600 cycles. This check was happenstance. A check by the RCA Frequency Measuring Bureau (Point Reyes station) was prearranged and Mr. K. B. Warner and the Pacific Division Director were notified of the frequency to be transmitted on by K6NYD by letter postmarked prior to the designated time. The frequency of K6NYD checked plus or minus five cycles with RCA. K6NYD claims a maximum error of plus or minus 1 kc. in this portion of the 20-meter band. The Communications Manager refused to accept this check as proof of ability to set up a frequency.

"Secondly, K6NYD relies on the fact that the Official Observer stations of the A.R.R.L. that cited it for off-frequency operation are not shown to have had accurate measuring equipment and, as conceded by the A.R.R.L., they might have been as much as 1 kc. off even though Official Observer stations were not required to pass periodic accuracy checks at that time. If this admitted possible error of 1 kc. is applied in favor of K6NYD, even the A.R.R.L.'s Official Observers would have to put K6NYD under 14,250.0 kc.

"If K6NYD had been operating at 14,249.99 kc. at the time, so that the citations were issued for side-bands extending above 14,250.0 kc., in the light of the decision of the F.C.C. (Memo No. 44-B, 12/12/39), it would have been allowable. This memo holds that, 'Side bands extending into c.w. portions of amateur band are considered as not extending into another service band.' This decision was rendered by way of interpretation of Section 152.31 of the F.C.C. regulations, and is of course retroactive and the only official word on the subject. Competent legal advice states that (a) 'F.C.C. regulations have the force of law when not contrary to the Constitution or Statutes, or clearly outside the authority of the Commission to promulgate' and that (b) 'Any interpretative ruling seldom is not retroactive.' The above is within the power of the F.C.C. to promulgate and is of such a nature to be automatically retroactive for failure of the Commission to negative such application. Even though Mr. Warner does not agree with this F.C.C. memorandum and sees fit not to publish it in the pages of *QST*, he should not penalize a station for failure to comply with his unspoken, unpublished differences with the F.C.C. It should be pointed out that in the 1939 DX Contest Rules (*QST*, February, 1939), no mention was made of an allowance for side bands of a 'phone station operating near a band edge. The use of 3 kc. by *QST*, based on the claim that an unnamed monitoring station of the F.C.C. used the figure, should not be accepted because the monitoring station itself violated a memo of the F.C.C. (1934) in which Field Personnel are ordered not to attempt to interpret the rules of the Commission. If contest officials wanted contestants to keep 3 kc. from the band edge they did not say so, therefore the F.C.C. regulations as interpreted by the F.C.C. itself should apply.

"Throughout the volumes of correspondence concerning this matter *QST* officials have claimed to have unerringly followed the course of carrying out to the letter the contest rules as written, but conveying the idea that had K6NYD presented its case before the publication of the contest results, its claim might have been considered. Had K6NYD been notified of its disqualification prior to this time, or received the two Official Observer notifications, it most certainly would have submitted its case immediately and perhaps received the same consideration as a well-known American amateur who received a DX Contest section award even though he received the F.C.C. citation during the Contest.

"In view of the above, K6NYD believes that while perhaps an honest difference of opinion exists, it has justifiable claim that *QST* accept its score of about 57,000 and announce it as high score in the Hawaiian area for this contest."

A. W. Greenlee, Lt., U. S. N.

— — — — —

There is a very great deal that could be said about the technical and regulatory matters mentioned in the foregoing

letter. However, from the League's standpoint, the deciding factors are simply these:

1. Entrants in the DX Contest agree to be bound by the rules of same.
 2. One of the rules provided that entries shall not be considered for certificate awards if two or more accredited A.R.R.L. Official Observers report operation outside of assigned band limits.
 3. Two Official Observers independently so did.
- The League deeply regrets its inability to reissue the Hawaiian 'phone certificate in view of these facts.

MEET THE S.C.M.'S



W. J. Wilkinson, Jr., W5DWW

The Louisiana S.C.M. is at present serving a term of office which began in 1940. Previously he served as Section Communications Manager from 1932 to 1936. His first station went on the air in 1928, and he formerly held the calls W5AWL and W5VT. Locally the gang have nicknamed him "Dubs," and in the southern part of the State he is known as "Pops." W5DWW is O.R.S., O.B.S., R.M., former O.O. and A.A.R.S., and holds Al-Op, R.C.C., W.A.S. and a 35 w.p.m. Code Proficiency Certificate. Contacts are a phase of amateur operating he enjoys, managing to participate in most of them. He won the Sweepstakes award for his Section on two occasions. The attic shack boasts of a home-built multi-stage transmitter terminating in a P.P.-838 final stage, running at 450 watts input, and receiving is taken care of by an AR-77. All operation at present is on 7032 kc., although the rig is capable of being tuned to either 3.5 or 14 Mc. S.C.M. Wilkinson is secretary-treasurer of the Shreveport Amateur Radio Club. He is an ardent baseball fan, and claims "eating" as another hobby, secondary to amateur radio, of course! Broadcast station KRMD employs him as an engineer.

O.B.S.

The following is a supplement to the list of A.R.R.L. Official Broadcasting Stations in December QST (page 72): W1AAR, W1BFA/MOF, W1FPS, W1IP, W1JQD, W1LZW, W2JGC/4, W2JZX, W3AOC, W3CQU, W3EQK, W3INF, W3OQ, W3UA, W4GJW, W5BPM, W5CJW, W5EWD, W5EGL, W5HNW, W5HQC, W5IGW, W5MN, W6BAM, W6CHV, W6DHS, W6EBR, W6JQB, W6QKB, W7CZJ, W7DXQ, W8AFV, W8KNP, W8MJK, W8OTY, W8PER, W8PNR, W8QFF, W8ROA, W8UUP, W8UWZ, W8WF, W9AGL, W9BFW, W9BQF, W9BQJ, W9BYV, W9DCW, W9DZC, W9EMQ, W9INU, W9KXB, W9FSP, W9VVA.

BRIEFS

For the benefit of beginning amateurs in the Woodrow Wilson High School Amateur Radio Club of Washington, D. C., W3ILD is transmitting code practice on the high end of 14-Mc. c.w. For the information of others who might be interested in making use of the transmissions, W3ILD transmits on 14,386 kc. daily from 8:00 to 9:00 p.m. E.S.T. This schedule will be in effect until the end of July.

Brass Pounders' League

(February 16th-March 15th)

Call	Orig.	Del.	Rel.	Extra Del. Credit	Total
W3GKO	21	48	1696	43	1808
W4PL	11	29	1342	22	1404
W9INU	25	87	1196	75	1383
W5FDR	32	198	786	184	1200
W3BWT	97	121	862	115	1195
W9QMD	51	28	976	21	1076
W9ILH	35	162	672	58	927
W1MGC	61	34	760	17	872
W7EBQ	47	72	690	58	867
W3CIZ	17	55	745	41	858
W4AAO	41	36	748	20	845
W3AOC	68	69	640	58	835
W9JMG	18	16	788	2	824
W6RWW	95	140	418	123	776
W2BO	38	43	619	38	738
W2SC	18	89	561	56	724
W9OZN	11	7	692	3	713
W5MN	34	131	418	107	690
W8SAY	16	18	597	15	646
W6DH	91	186	361	0	638
W5DWW	37	62	458	53	610
W8DAQ	17	30	494	26	567
W9GKS	118	15	416	11	560
W9OUD	29	78	397	45	549
W5CEZ	18	109	403	14	544
W2BO*	31	32	448	32	543
W5GFT	72	125	242	101	540
W2AYJ	42	64	386	34	526
W2KI*	50	221	26	216	513
W3BZX	5	12	492	2	511
W8SJF	3	11	482	7	503
W2MNT	40	68	339	55	502
W6IOX	16	27	432	25	500

MORE-THAN-ONE-OPERATOR STATIONS

Call	Orig.	Del.	Rel.	Extra Del. Credit	Total
KAIHR	1016	303	14	776	2609
W5OW	154	93	1174	48	1469
W1AW	122	144	600	132	998
KAIHQ	238	112	138	90	578

These stations "make" the B.P.L. with total of 500 or over. One hundred deliveries + Ex. Del. Credits also rate B.P.L. standing. The following one-operator stations make the B.P.L. on deliveries. Deliveries count.

W2KI, 298	W2SC*, 151	W3BZE, 111
W6SPB, 280	W6ITH, 149	W3CSC, 108
W8JW, 247	W6IG, 147	W6IZ, 108
W9ELV, 198	W6SG, 146	W5CDU, 107
W2CGG, 187	W9VEE, 138	W7APS, 102
W5BN, 171	W8CKO, 128	W9DUX, 101
W9TTJ, 170	W5AAJ, 121	W6ZX, 100
W2LPJ, 160	W2BWC, 119	More-than-one-opr.
W8KWA, 153	W9QIL, 113	WCSEB/5, 152

A.A.R.S.

Call	Orig.	Del.	Rel.	Extra Del. Credit	Total
WLR (W4AAO)	0	0	850	0	850
WLMW (W9QIL)	56	83	406	73	618

MORE-THAN-ONE-OPERATOR STATIONS

Call	Orig.	Del.	Rel.	Extra Del. Credit	Total
WLM (W3CXL)	330	285	2516	285	3416

A total of 500 or more or 100 deliveries + Ex. D. Cr. will put you in line for a place in the B.P.L.

* Jan.-Feb.

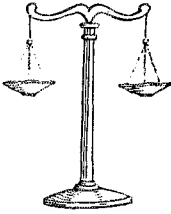

LAST MONTH we had to sign off before finishing our story on receiver testing. We were about to discuss receiver noise, so that seems to be the best place to start this month.

We are going to limit ourselves to noise caused by the electrons themselves — thermal agitation, shot effect, etc. These are the cause of the “rushing sound” one hears when the gain is turned up. Other sources of noise — such as defective parts — can be, and should be eliminated from a communication receiver. Electron noise is always with us, however.

It can be minimized by low-loss design, because improving the “Q” of the input circuit will increase the signal amplification without corresponding increase in noise. Therefore, it is the input circuit which places a practical limit on the signal-to-noise ratio of the receiver.

Of course, other stages will produce equal noise, but a good RF stage will have a gain of 15 to 20 even at high frequencies and with this amplification the signal will be strong enough to over-ride the noise in following stages.

Try operating a receiver on manual volume control, with no signal, and with enough gain to hear a “rushing noise” in the speaker. Now kill the first RF stage, by removing the tube or by putting your finger on the grid connection. This will stop the noise coming from the input circuit, so that what noise remains is coming from other stages. In a good receiver, this noise will be much less than the noise when the input is coming through. On the other hand, a poor receiver will show little reduction in noise when the test is made.

This simple test will give valuable information on the relative merits of two receivers’ RF stages, provided that two precautions are observed. In “killing” the RF tube, touching the grid cap and removing the tube entirely are two different things, so in making a comparative test, use the same method on each receiver. Also, use an output meter for measuring the ratio of noise reduction. The ear is very deceptive, partly because it works on a logarithmic scale, and partly because it has a poor memory when comparing intensities.

Our statement above that the input circuit limits the signal-to-noise ratio of the receiver needs one qualification. Where tone quality is not important, noise can be reduced along with the sidebands by means of a very selective circuit, such as a crystal filter. As you know, this will also reduce the apparent strength of the signal, but there is still a net improvement.

So much for noise. We will finish our story next month with comments on dead spots, images and over-all gain.

JACK IVERS





Color CODED FOR INSTANT RATING IDENTIFICATION

Mallory Tubular Paper Condensers now come dressed in brilliantly colored labels. Capacities are completely legible... and voltages are instantly identifiable by the bottom band of color... coded to RMA specifications. This color code band goes clear around the condenser. You can spot the voltage no matter how the condenser is placed in your set.



The outstanding high quality of Mallory Tubular Paper Condensers has been further enhanced by the new paper label which is applied over the familiar heavy cardboard tube and thick wax coating.

See these new condensers today. Your Mallory distributor has them.

P. R. MALLORY & CO., Inc.
INDIANAPOLIS INDIANA
 Cable Address — PELMALLO

Use

P. R. MALLORY & CO., Inc.

MALLORY

APPROVED
PRECISION PRODUCTS

MICHIGAN EMERGENCY COUNCIL FORMED

The M.A.R.E.C. was formed in Detroit, Sunday, March 10, 1941, at the Annex Theatre, after a first-class display of amateur equipment in the lobbies of two theatres for three weeks in connection with the picture, "Western Union." Messages were solicited from the public for all parts of the country — about 500 all told. Daily newspaper publicity was accorded during the displays.

The climax to the displays was a general meeting of some 600 hams at the theatre on March 9th, called together at the request of Emery H. Lee, Federal Communications Commission Inspector serving as chairman of the Radio Division of the Wayne County Chapter, American Red Cross Emergency Communications Committee, as the first step in a program to coordinate all of the country's preparedness and relief agencies as a unit, to function in times of national emergencies. Represented were the American Radio Relay League, the Great Lakes Radiophone Association, the "73" Club of Dearborn, the Detroit Amateur Radio Association, the Motor City Radio Club, and the Edison Radio Amateur Association. Representatives from the Michigan "QNN" Net, the Army Amateur Radio System, the "W8"-10 Meter Net and the Michigan Emergency Net were also in attendance.

The Wayne County Chapter, Michigan Amateur Radio Emergency Council, is the name of the newly-formed amateur group. They will be known in amateur circles as M.A.R.E.C. Officers elected were: Lewis H. Schmidt, W8AIZ, President; Kenneth Conroy, W8DYH, Vice-President; Bernard D. Fellows, W9TMN, Secretary; and Walter H. Fuller, W8CYX, Treasurer. Charles A. Wise, W8WF, and R. P. Thetreau, W8FX, were chosen as members of the Board of Directors. Temporary offices of the organization have been established at 1836 Fincrest Drive, Ferndale, Mich. The Council, made up of two members from each club, will meet once a month at the Ft. Shelby Hotel, Detroit.

The letterhead of the Council includes practically every network and club of the area, as well as the identity of officers, directors, and committees. This phase of amateur work should be pushed at this time to show the public something more than just the ability to "gas" on the ham bands.

A 24-hour station (W8AIZ), on 3663 kc., is available at a moment's call. Drills are held at the call of the president of the M.A.R.E.C.

Here is a list of speakers at the first general meeting: Clyde M. Ford, Acting Mayor of Dearborn; A. J. Berres, Chairman American Red Cross Detroit Chapter; W. Calvin Patterson, Associate Chairman American Red Cross Emergency Communications Committee; Frank Curtis, Customers Relations Michigan Bell Telephone Company; J. T. Shaefer, Chairman R.C.A. Emergency Communications Committee, Secretary and Treasurer, Michigan Bell Telephone Company; Emery Lee, Inspector-in-Charge, Detroit Federal Communications Commission; Captain Donald S. Leonard, Commander Eastern District Michigan State Police; Lieutenant Edwin Denstaedt, Supervisor Radio Detroit Police; E. C. Bowen, Superintendent Detroit Office Western Union Telegraph Company; Carl Sedan, Detroit Convention and Tourist Bureau; J. B. Austin, Executive Council, Boy Scouts of America; Major Dan Wilkerson, General Staff Michigan Home Guard; J. O. Elleson, Assistant Director, Central Division ARRL; Harold C. Bird, SCM, Michigan Section ARRL; Tim Henshaw, United Detroit Theatres.

— George O. St. Charles, W8SWF

DX NOTES

Through the efforts of W9NBX and W6LBM and the cooperation of Elmer (W1LWD) at KC4USB, the Little America station devoted four hours (Midnight to 4:00 A.M. C.S.T.) to a schedule on 7220 kc. with the Y.L.R.L. on February 8th. Twenty of the gals attempted contact. The following were the lucky ones: W1FTJ, W3FKZ, W8NAL, W8UDA, W9FRR, W9OWQ, W9NBX and W9ZWL. . . . K6SKN19 advises that he has received a number of QSL cards since leaving Hawaii last July, indicating that someone is making active and illegal use of his call on the 3.5- and 7-Mc. bands. This may serve as an explanation to anyone who has been disappointed in not receiving a card from K6SKN. . . . W6OCM reports KB6OCL coming through

*QUALITY

*PERMANENCE

*DEPENDABILITY

... ALL Present a
United Front to make

Centralab RESISTORS

the Only Resistor
in ANY Emergency!

* **QUALITY** backed by years of experience, engineering supervision and the best of materials.

* **PERMANENCE** of resistance values under high temperatures and excessive loads.

* **DEPENDABILITY** proved by countless tests and constant use for over twelve years.

● For service work, amateur needs or industrial equipment, Centralab Resistors will serve every purpose. The hard-as-stone insulating jacket and conducting core of ceramic are fired together at 2500° F. into a durable shockproof unit as ageless as stone . . . heat resisting and humidity proof. For every occasion and every use specify Centralab Resistors.

Centralab

Division of Globe-Union Inc.
MILWAUKEE, WIS.

AT NO EXTRA COST GET THE

HIDDEN EXTRAS

IN C-D CAPACITORS

THE AMATEUR MAY WONDER why Cornell-Dubilier's superior capacitor performance costs no more. For there is, unquestionably, extra value in the longer capacitor life, added quality and greater dependability of a C-D Transmitting Capacitor. You get these hidden extras at no extra cost because they're a product of experience—the thirty-one years Cornell-Dubilier has spent as capacitor specialist. Take advantage of this extra value—specify C-D's and get more for your money.

send for new catalog no. 185a

GET THESE ADVANTAGES
AT NO EXTRA COST IN C-D
MICA CAPACITORS

TYPE 86

- low radio frequency resistance
- low power factor
- extremely high d.c. resistance
- dehydrated porcelain case
- in wide range of capacities at all voltage ratings to 12,500 volts



Get the extras

AND YOU GET THE
TOPS IN CAPACITOR
PERFORMANCE!



CORNELL-DUBILIER
ELECTRIC CORPORATION

1013 HAMILTON BLVD. • SO. PLAINFIELD, N. J.

most every night after 10:30 P.M. P.S.T., on 14,238 kc. . . . Using only a Meissner Signal Shifter (rated at 7 watts) and a half-wave doubler, W51GJ raised KB6GJX, K6SXX, KC4USB and K4GNM all within a few hours one night. All were 100% contacts, using the bug, and the KC4 QSO lasted 55 minutes! . . . W4FLI was awarded the first "W4" W.P.R. certificate at the last meeting of the P.R.A.R.C. . . . Three new cards, ZP3AC, UX1CP and KD4GYM, finally trickled through to W2GT. . . . W6ITH continues to work flocks of KA 'phones on 14 Mc. On March 8th he worked the following, who, he says, were coming in very well as late as 11:00 A.M. P.S.T.: KA7FS (14,128), KA1CW (14,138), KA1CM (14,063), KA1AC (14,090), KA6FB (14,120), KA4LH (14,103) and KA1AK (14,107). Reg also worked KB4HBX (28,740) and K5AT (29,020) the same day. . . . W9ZDS worked KD4HHS on 14,280, March 6th, at 10:45 A.M. C.S.T. . . . W2FLL passes along a hot tip for those who have not yet cleaned up the Pacific islands. In conversation with W2ESA, he was told that a mutual acquaintance of theirs, a Mr. John L. Loeb, has been assigned the call KD6RTW for operation on the French Frigate Shoals, a small island about 500 miles northwest of Honolulu. The chap is enroute now, and will be active for about three weeks on 14,396 kc. with a fair amount of power some time after the middle of April. He will then move on to Midway, then to Wake, and finally to Guam, spending about three to four weeks at each stop and will use the same frequency for all contacts.

Code Practice

THE amateur stations listed below conduct automatically-sent code practice transmissions for the benefit of those who are trying to improve their code copying ability. There follows the schedules of several commercial stations whose press and weather transmissions make excellent code practice material. It should be noted well that press and other data specifically addressed *may not be divulged* except to the addressee. Amateurs are cautioned against using such material except for practice.

Amateur-Band Code Practice

- W1AW — 10:15 P.M. EST, except Fri. (15-35 wpm); 1761-3825-7280-14254-28510 kcs.
W6AM* — 5:45-6:10 P.M. PST, Mondays (15-35 wpm); 14306 kcs.
W7YG — 7:30-8:30 P.M. PST, Mon. (15 wpm), Tues. (20 wpm), Wed. (25 wpm), Thurs. (30 wpm), Fri. (35 wpm); 7022 kcs.
W9HCC — 8:30-9:30 P.M. CST, Tues. and Thurs. (20 and 25 wpm); simultaneously on 3538-7058-14312 kcs.

* Subject to cancellation on occasional dates when opr. is away.

Press and Weather Transmissions

(All Times Given are E.S.T.)

22 W.P.M.	1:50 P.M.	Mon. thru Sat.	WBE/WCB
	6:30 P.M.	Mon. thru Sat.	WBE/WJP
	9:00 P.M.	Sun. thru Fri.	WCB/WBG2
30 W.P.M.	Midnight	Mon. thru Fri.	WJP/WBC2
	5:00 A.M.	Mon. thru Sat.	WDH/WHL
	8:00 A.M.	Sun. only	WDH/WRK
	9:00 A.M.	Mon. thru Sat.	WDH/WRK
	2:00 P.M.	Daily	WDE/WRK
37 W.P.M.	6:15 P.M.	Daily	WRK
	7:00 P.M.	Daily	WRK/WHL
	7:00 A.M.	Mon. thru Sat.	WCX/WJS
	8:00 A.M.	Mon. thru Sat.	WCX/WJS
	10:00 A.M.	Sun. only	WJS
	11:00 A.M.	Mon. thru Sat.	WCX/WJS
	Noon	Mon. thru Sat.	WCX/WJS
	Noon	Sun. only	WCX/WJS
	1:15 P.M.	Mon. thru Sat.	WJS
	2:15 P.M.	Mon. thru Sat.	WJS
4:30 P.M.	Daily	WCX/WJS	
5:15 P.M.	Daily	WCX/WJS	
6:00 P.M.	Mon. thru Sat.	WCX/WJS	
8:05 P.M.	Daily	WCX/WJS	
8:50 P.M.	Daily	WCX/WJS	
10:05 P.M.	Daily	WCX	

(Continued on page 54)

Choosing a "RECEIVER"?

ONCE you have operated a "Super-Pro" you will immediately understand why engineers, both military and civilian, specify it for so many difficult jobs. In choosing a receiver, the amateur can and should weigh every detail just the same as the engineer does. Actually, what you want is the best possible performance over the longest period of time. Side-by-side tests will give a pretty good indication of performance and one look at the "insides" will tell you whether the receiver is going to continue that performance for any length of time. The "Super-Pro" is built to give years of service. Based on five years of service, it costs less to own a "Super-Pro" than many of the lowest priced receivers.

Write Dept. Q-5 for "Super-Pro" booklet

SEE - HEAR The Super Pro

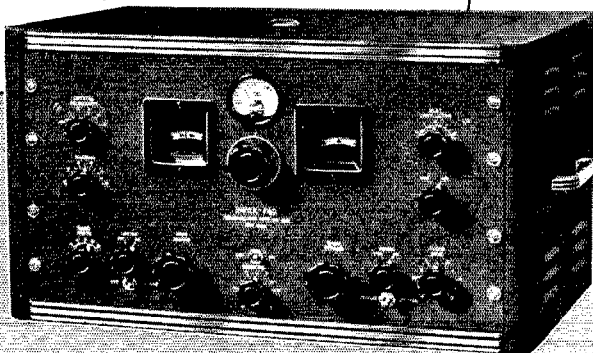

Check THESE FEATURES!

- ✓ Two tuned RF stages with shielded input circuit — high image rejection — low noise
- ✓ Variable IF band width—3-16 kc. with 5 range xtal filter
- ✓ Automatic noise limiter designed to work with either AVC or manual gain
- ✓ High quality audio
- ✓ Three IF stages
- ✓ Calibrated S-Meter can be adjusted to suit conditions
- ✓ Available in ranges down to 100 kc.

HAMMARLUND MFG. CO., INC.
424-438 WEST 33rd ST., NEW YORK

The Meissner DeLuxe SIGNAL SHIFTER



Makes an Ideal COMPLETE XMTR For the Beginning Amateur!

Maybe you've heard about the rapidly increasing interest in Amateur Radio—maybe you know one or more enterprising young fellows who are itching to get into the game! Why not help him to get started right by recommending a Meissner DeLuxe Signal Shifter for his first transmitter?

Did you know that this versatile ECO has been hanging up some remarkable records in performance as a complete transmitter? Its ability to place its clean-cut, crystal-toned signal anywhere you want it, on any band—and keep it there—offsets much of the advantage of higher power! Reports prove that the entire country is its playground!

Where else can you get a complete, all-band C-W transmitter, all ready to hook up to antenna and key and begin operating, with a panel area less than twice the size of this page? And when the station's ready to grow—there's one of the finest variable-frequency exciters available—all set to keep right on going—doing the job for which it was originally designed! Last, but far from least, is the remarkable economy in cost, for it's complete with tubes at only \$47.50!

DON'T DELAY—GET YOURS TODAY!

See your Meissner Distributor at once or write for further details to the address below—now!

Write for Free Complete Catalog!



Dept. Q-5

5:00 W.P.M.	6:00 A.M.	Mon. thru Sat.	WPU
	6:30 A.M.	Mon. thru Sat.	WRM
	8:00 A.M.	Mon. thru Sat.	WRM
	10:00 A.M.	Mon. thru Sat.	WRM
	Noon	Mon. thru Sat.	WRM
	1:50 P.M.	Mon. thru Sat.	WRM
	2:50 P.M.	Mon. thru Sat.	WRM
	6:30 P.M.	Mon. thru Sat.	WPU
	8:40 P.M.	Mon. thru Sat.	WPJ
	9:15 P.M.	Mon. thru Sat.	WPK2

Frequencies: WBE 19850; WBG2 7615; WCB 15580; WCX 7850; WDH 19470; WEL 10750; WJP 8810; WJS 15700; WPJ 11640; WPK2 13185; WPU 14635; WRK 15910; WRM 18560.

Miscellaneous:

3:30-4:30 P.M.	IAC 12865 (Appx. 40 W.P.M.)
5:00-8:00 P.M.	GIC 8640; GID 13555; GIH 10650 (20 W.P.M.)
6:00-8:00 P.M.	DLE 10130 (Appx. 20 W.P.M.)
6:30-8:00 P.M.	DON 10128 (Appx. 35 W.P.M.)
7:00 P.M.	LOL 8690; PPR 8310; WFC 6785
8:00 P.M.	WAC 10470; WFD 4985
8:30 P.M.	WPN 6410
9:00 P.M.	NSS 5965 (50 W.P.M.)
10:00 P.M.	KUP 6440; NAA 9250; NPG 12885; NSS 4525; XDP 4800; XDD 13043
11:15 P.M.	WSC 8430; WSL 5555
Midnight	KPH 8440, 12735; KTK 6400, 8680; NSS 4525 (All Times P.S.T.)
7:00 A.M.	NPG 9090 kc.
8:30 A.M.	JUP 13060 kc.
2:30 P.M.	KTK 16740 and 12495 kcs.
4:00 P.M.	NAA/NSS 9250 kc.
5:15 P.M.	WPN 11295 kc.
7:00 P.M.	NPG 9090 kc.
8:00 P.M.	KJH 7815 kc.
8:20 P.M.	WGG/WSC 6340 kc.
9:00 P.M.	KTK 8680 and 12495 kcs.
10:00 P.M.	KFS 8380, 12550 and 97.5 kcs.
10:00 P.M.	KWJ 15000 kc.
12:10 A.M.	KPH 8440 and 12380 kcs.

W1AW Operating Schedule

SINCE 72% of the country remains on standard time, we shall continue to list schedules on standard time as a convenience to the majority. The following schedule is effective starting April 27th:

OPERATING-VISITING HOURS:

2:00 P.M.—2:00 A.M. E.S.T. daily, except Saturday-Sunday.
Saturday and Sunday — 7:00 P.M.—1:00 A.M. E.S.T.

OFFICIAL BROADCAST SCHEDULE (for sending addressed information to all radio amateurs).

Frequencies

C.W.: 1761-3825-7150-14,254-28,510-58,968 kc. (simultaneously)

Starting Times (P.M.)		Speeds (W.P.M.)							
E.S.T.	C.S.T.	M.S.T.	P.S.T.	M	T	W	Th	F	Sat Sun
8:30	7:30	6:30	5:30	20	15	25	15	20	— 20
Midnight	11:00	10:00	9:00	15	25	15	20	15	15 —

PHONE: 1806, 3950.5, 14,237, 28,510, 58,968 kc.

Each code transmission will be followed in turn by voice transmission on each of the above frequencies.

CODE PRACTICE:

Besides the O.B.S. times and word speeds given above, W1AW will adhere to a schedule for sending code practice transmissions at progressively increasing speeds (15 to 35 w.p.m. in 5 w.p.m. steps) daily except Friday, starting at 9:45 P.M. E.S.T. On May 18th, practice will be omitted for another station program. The Proficiency Certificate Award qualifying runs, after a 15-minute advance notice at 9:45 P.M. E.S.T., start at 10:00 P.M. E.S.T., May 14th and June 17th. Daytime runs for qualification, after notice at 1:30 P.M. E.S.T., start at 1:45 P.M. E.S.T. on May 6th and June 1st.

(Continued on page 58)

You owe it to yourself - TRY THE HQ-120-X

- ★ Tuning range 540 kc. to 31 mc. in six bands. Uniform sensitivity easier tuning.
- ★ Amateur bands calibrated directly in frequency and spread over 310° of dial.
- ★ Variable crystal filter provides ideal reception in crowded phone or CW bands.
- ★ Ant. compensator — noise limiter — high gain TRF — calibrated S-Meter — voltage regulation.
- ★ \$138.00 AMATEUR NET

Write Dept. Q-5
for
16-Page Booklet

IF YOU are interested in fine performance at a reasonable cost, "you owe it to yourself to try the 'HQ-120-X,'" for in it you will find low background noise, high sensitivity and ease of operation. The "time test" has proved the "HQ" a superior product — for two years it has led the field. Its one stage of T.R.F. with the antenna compensator is so well designed that its image rejection is equal to, or better than, many two-stage receivers. There are many other things about the "HQ" which make it distinctive. Finely calibrated dials; lack of parallax, and smoothness of controls, coupled with an honest-to-goodness ability to perform, even under adverse conditions, make this the outstanding amateur receiver.

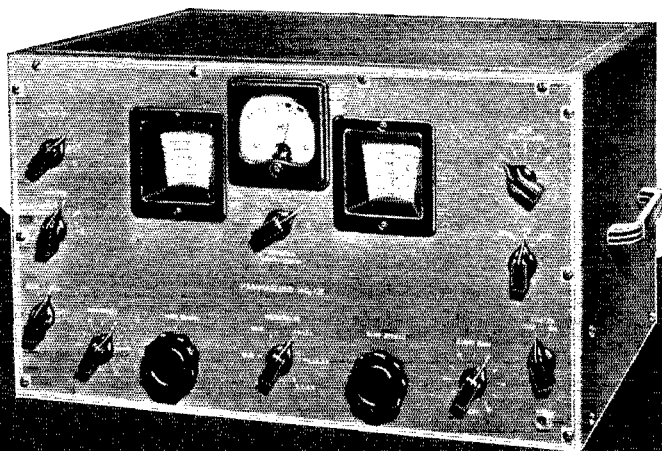

H A M M A R L U N D

424 W. 33 Street, New York City, N. Y.



Industry is making a great contribution to the National Defense Program. Research departments are attempting to keep pace with urgent requirements . . . With miraculous swiftness and efficiency, productive capacities are expanding to fill our country's needs. It is a major achievement.

It is an effort in which high morale, and not economic benefit, plays the vital role in preserving our American way of life.

Because we believe that we, too, are contributing to the defense of America and American institutions, THE ALLEN D. CARDWELL MANUFACTURING CORPORATION is cooperating with this program of intensive expansion. Our Engineering and Design developments are producing unprecedented refinements.

Logically, in the face of this greater output for defense, essential raw materials are being subjected to law-enforced priorities and our production for commercial, industrial and amateur requirements is curtailed.

When conditions return to normal . . . our greatly expanded engineering and production facilities and developments will be geared to serve you as never before.

Now we are obliged to ask your consideration and cooperation when deliveries are necessarily slow.

THE ALLEN D. CARDWELL
MANUFACTURING CORPORATION
 83 PROSPECT STREET • BROOKLYN NEW YORK

How to Build a Code-Instruction Table

(Continued from page 52)

have good regulation so that the level will not change appreciably whether all keys or only one is closed. A choice of tones should be available to avoid monotony, and there should be no change in the pitch regardless of the number of circuits that may be closed at a particular instant. And finally, there should be no interaction or cross-talk between independent circuits.

These requirements can be met by a low-impedance source capable of delivering a great deal more power than is actually required. Fortunately, the ordinary headset takes very little power for good signal strength, so that a large number of headsets can be operated from an available power of well under one watt. The voice-coil winding of an output transformer coupled to a small pentode output tube will give about the right voltage, and preloading of the power amplifier will insure good voltage regulation of the output.

A circuit diagram suitable for handling thirty or forty headsets is shown in Fig. 2. Operating directly from the 115-volt line, it consists of a 12SJ7 oscillator followed by a 70L7GT power amplifier and rectifier. The 12SJ7 is used in the transitron oscillator circuit, which requires no tickler winding as is the case with a triode, and also generates a practically pure tone as contrasted to the "blocking" type of oscillation characteristic of triodes used with audio transformers. The pitch of the tone is determined by the constants of the tuned circuit, L_1C_1 . The inductance should be of the order of 1 or 2 henrys for use with readily-available paper condensers. In the unit shown in the photographs this inductance is an ordinary small filter choke (Thordarson T-14C61) with the straight section of the core removed and a piece of wood of the same size and shape substituted so that the mounting clamp can be replaced. This gives a choke of approximately 1 henry inductance.

Variable tone is secured by means of the switching arrangement shown. With three condensers of the values indicated, an assortment of six tones ranging from about 600 to 1600 cycles can be obtained. If the circuit values given are followed there should be no trouble in getting oscillation; the only adjustment which might be called critical is that of the plate voltage, but even here the oscillator will work over a fairly wide range of values.

The amplifier circuit is pre-loaded by means of the 3000-ohm resistor across the plate circuit. Besides improving the regulation the loading also helps keep the output transformer from "singing." Omitting the customary by-pass across the cathode resistor, R_4 , provides a small amount of negative feedback which further helps matters in this respect.

The output switch, S_2 , enables the instructor to cut off the tone from the entire class, and thus serves as a simple means of attracting attention

(Continued on page 68)

Are You Ready for Emergencies LIKE THIS?

FOR building or rebuilding emergency rigs, the GL-807 has more possibilities than a K-6 on a clear channel.

Long a mainstay in many a shack, the GL-807 presents an unusual array of advantages for emergency work, even up to 125 megacycles. Great stuff for 60-mc FM, by the way.

Ask your dealer to show you the GL-807. And for your other tube needs, too, try G-E's and measure the difference. General Electric, Schenectady, N. Y.

Why GL-807's Meet Requirements in Emergency

- Low heater drain
- Amazingly low driving power
- Excellent frequency-multiplier
- Low plate voltage
- Full ratings up to 60 mc
- ICAS ratings
- High output as crystal oscillator
- Sturdy construction
- High efficiency
- No neutralizing difficulties

RATINGS

Heater Volts.....6.3 Heater Amp.....0.9

	Class C 'Phone	Class C Telegraph	Class AB ₂ A-F (2 tubes)
Max. Plate Volts	600	750	750
Max. Plate Milliamp.	100	100	240
Driving Power, Watts	0.1	0.22	0.5
Output Power, Watts	37.5	50	120

**Best of all—GL-807's
cost ONLY \$3.50 at your G-E dealer's**

'Hams' Active Again
As in past storms and floods, station-owning radio amateurs stepped to the fore with their transmitters as an emergency communication link in the current hurricane onslaught on Charleston, S. C., and vicinity. Charleston amateurs were reported to have set up portable equipment using battery power to get out their messages, while other amateurs in various parts of the Eastern seaboard cooperated in handling "traffic."

The amateurs are members of the American Radio Relay League, which long has been active in cooperative efforts of like nature. The amateurs serve without pay, operating their stations for the fun as well as the experience they gain. In the past, quite a number of them have been highly commended for their efforts, and several have received special medals.

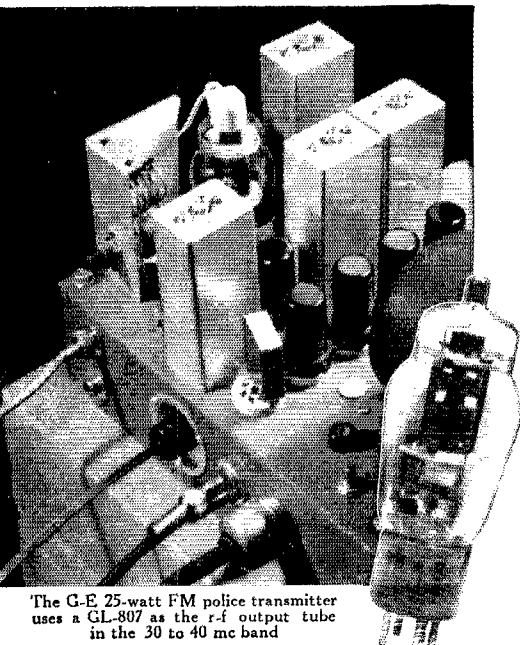

The G-E 25-watt FM police transmitter uses a GL-807 as the r-f output tube in the 30 to 40 mc band

QUALITY ABOVE ALL!
SOLAR
CAPACITORS

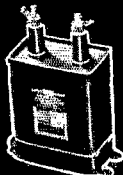

**XL
TRANSOIL**
 For
 Permanent
 Filters

**XD, XC
TRANSOIL**
 for Filters
 and Bypass

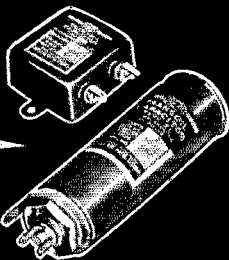

**XA, XH
MICA**
 Oscillator
 Tank Circuits

**XR, XS
MICA**
 Tank Circuits,
 R. F. Bypass

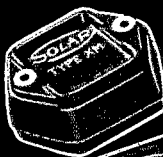
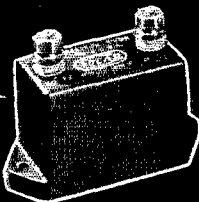

**XM, XQ
MICA**
 Coupling, Blocking
 R. F. Bypass

**MH, MW
MT, MO
MICA**
 Low-voltage

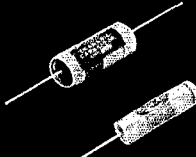
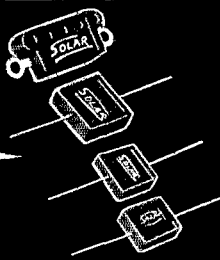

**XT
OIL TUBULAR
S**
 Wax-Molded
 Paper Tubular

Catalog Free Upon Request

SOLAR MFG. CORP., Bayonne, N. J.

WIAW Schedule

(Continued from page 64)

GENERAL OPERATION:

Besides specific schedules in different bands, WIAW devotes the following periods, except Saturday and Sundays, to GENERAL work in the following bands:

Time E.S.T.	Frequency
3:30 P.M.-4:00 P.M.	7150-kc. c.w.
4:30 P.M.-5:00 P.M.	14,237-kc. 'phone
6:00 P.M.-6:30 P.M.	14,237-kc. 'phone
6:30 P.M.-7:00 P.M.	14,253-kc. c.w.
8:00 P.M.-8:30 P.M.	14,253-kc. c.w.
9:15 P.M.-9:45 P.M.	3950-kc. 'phone
12:45 A.M.-1:15 A.M.	1806/1760-kc. 'phone/c.w.
1:15 A.M.-2:00 A.M.	3825-kc. c.w.

7:00 P.M.-8:00 P.M.: Schedules on 3500-kc. band
 9:45 P.M.-11:00 P.M.: Code Practice, all c.w. freqs.
 11:00 P.M.-Midnight: National Trunk Line Net N.C.S.

At other times, and on Saturdays and Sundays, operation is devoted to the most profitable use of bands for general contacts and to participation in special week-end operating activities. The station is not operated on legal national holidays.

BRIEFS

W9HWH suggests including the identifying letters C.P.-15, C.P.-20, etc., on QSL cards, to indicate the speeds at which holders of the A.R.R.L. Code Proficiency Certificate have qualified.

W8TJU requests amateurs located near Philadelphia who have pleasure boats on the Delaware River to send him a postcard. He has a 24-foot cabin cruiser at Camden, N. J., and is planning a trip through the intra-coastal waterways down to the Southern States this summer. He will take along a 10-watt 6L6 transmitter and a Sky Champion receiver powered from a vibrapack, and anticipates making boat-to-boat contacts on 7090-kc. and 14,180-kc. 'phone while at points along the route.

Hamfest Schedule

April 27th, at Ypsilanti, Mich.: The Annual Hamfest of the Detroit Amateur Radio Association will be held at the National Guard Armory, Ypsilanti, Mich., Sunday, April 27th. Activities will start at 10:00 A.M. Admission: Ladies, 25¢; O.M.'s, 75¢.

May 17th, at Syracuse, N. Y.: The Central New York Radio Club will hold its Annual Hamfest in Syracuse, Saturday, May 17th. Further information may be obtained from the Secretary, H. M. Pattat, W8AN, 206 Mattydale Drive, Syracuse, N. Y.

May 18th, at St. Paul, Minn.: The St. Paul Radio Club will hold its Tenth Anniversary Hamfest, Sunday, May 18th, at the Ryan Hotel, St. Paul, Minn. The day's activities will be highlighted by talks and demonstrations of frequency modulation, meeting of the Amateur Emergency Corps, demonstrations of emergency equipment, and various technical talks of great interest to all amateurs. A banquet in the Marquette Room of the hotel will wind up the festivities. Registration: \$1.50, Saturday afternoon and evening of May 17th will be spent in an informal gathering at the Frederic Hotel for those interested. The program will consist of meetings, demonstrations, a Dutch supper, followed by an evening of varied entertainment. XYL's, YL's and OM's are all invited! Further details are available from George C. Hansen, W9HZV, Publicity Chairman, 366 Marshall Ave., St. Paul, Minn.

May 24th, at Boulder, Colo.: The University of Colorado Radio Club will sponsor a hamfest to be held at the university in Boulder, Colo. on May 24th. The program schedule includes a transmitter hunt on 1.75 Mc., a 112-Mc. portable mobile activity and a picnic supper. Additional information may be obtained by writing George F. Baroch, W9ZNH, Secretary, University of Colorado Radio Club, 1229 University Ave., Boulder, Colo.



TMK

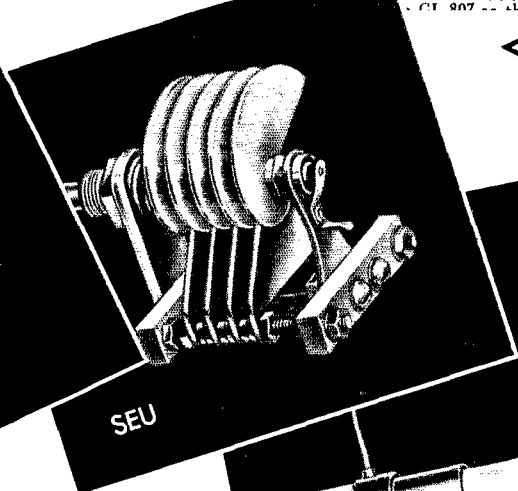

SEU

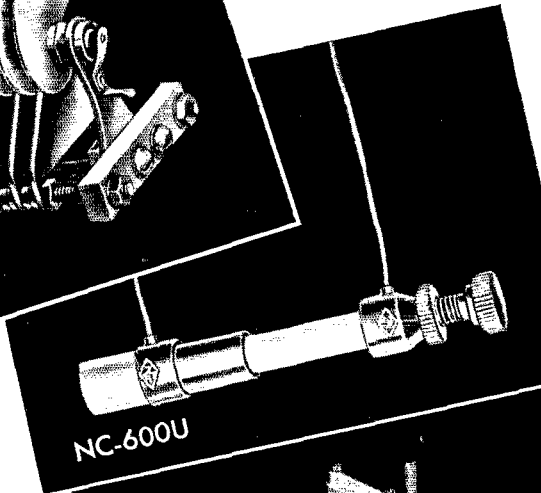

NC-600U

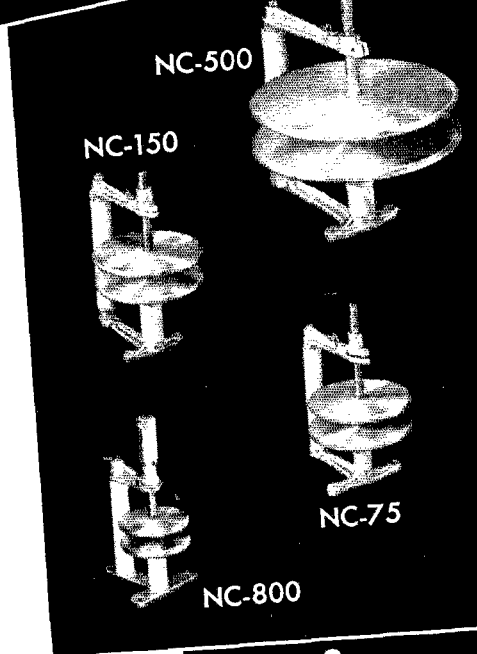

NC-500

NC-150

NC-75

NC-800

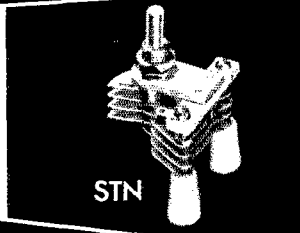

STN

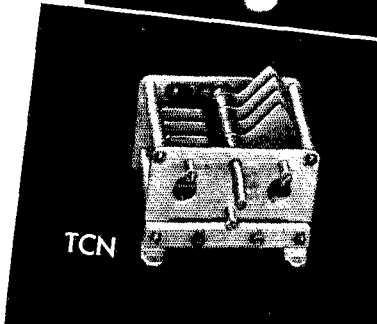

TCN

TMK ■ A new condenser for exciters and low powered transmitters, which features a swivel plug-in mount for air-spaced AR-16 Coils. For panel or stand-off mounting.

SEU ■ An old favorite which features a constant-impedance pigtail connection to the rotor. The SEU is a "natural" for wavemeters or any job where compactness and reliable calibration are necessary.

NEUTRALIZERS ■ The NC-600U is for neutralizing low power beam tubes requiring from .5 to 4 mmf, and 1500 peak volts, such as the 6L6. Net price \$.33, with removable standoff insulator.

DISK TYPE NEUTRALIZERS have aluminum disks and steatite insulation. All have clamps for locking adjustments.

NC-500 ■ Net Price \$7.50
For WE-251, 450TH, 450TL, 750TL, etc.

NC-150 ■ Net Price \$3.90
For HK354, RK36, 300T, 852, etc.

NC-75 ■ Net Price \$2.40
For 75T, 808, 811, 812, etc.

NC-800 ■ Net Price \$1.80
For 35T, HK54, 800, etc.

STN neutralizes such tubes as the 10 and 45. 18 mmf., peak voltage 3000 V. Net Price \$1.20

TCN is suitable for neutralizing the 203A, 211, etc. 25 mmf., peak voltage 6000 V. Net Price \$2.40

NATIONAL COMPANY, INC.
MALDEN, MASS.

Hints and Kinks

(Continued from page 45)

FOR EMERGENCY DUTY!

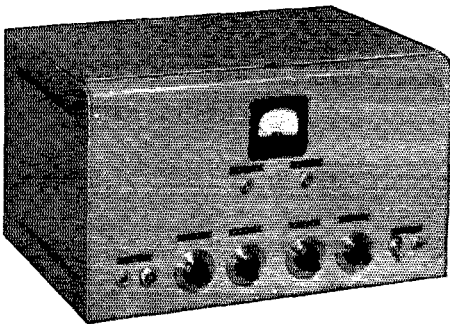
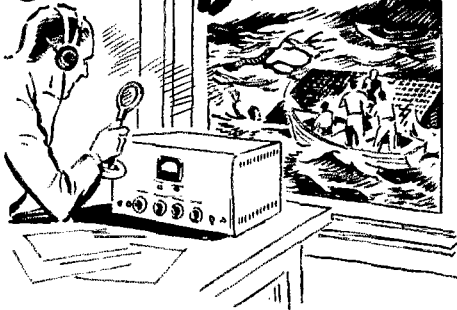

When Disaster Strikes! Wires Down . . . or Power Out! Will Your Rig Work Effectively?

Your calls WILL go through when you use a Thordarson Universal Transmitter. For every day rag chew, use it on 115 volts AC. For emergencies change the circuit from 115 volts AC to 6 volts DC by merely inserting the proper power plug. No wiring changes necessary. Covers all bands from 160 to 10 meters. Power output 12 watts either phone or CW.

Kit including all parts, except accessories, available from your local Thordarson Distributor. Ask for kit T-22K13, list price \$72.50. Fully described in bulletin SD464 — FREE.

THORDARSON

ELECT. MFG. CO.

500 WEST HURON STREET
CHICAGO, ILLINOIS, U.S.A.

TRANSFORMER SPECIALISTS SINCE 1895

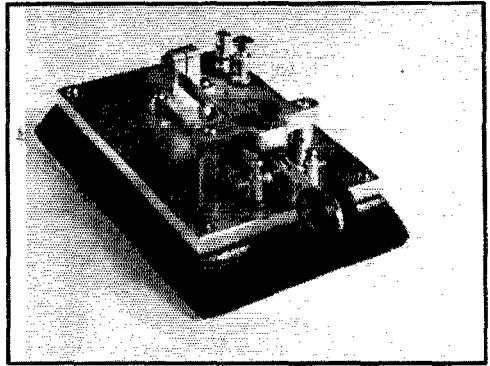

along over the main bar, like a wedding bar in dispair, so that it chafes against the top bar or bridge, providing friction for damping in any degree desired by simply elevating the key bar the desired amount. — H. A. Livingston, W1PV.

Silent Keys

It is with deep regret that we record the passing of these amateurs:

Tel. K. Abbott, G3JY, Blackpool, Lancs., Eng.

Ft. Lt. E. J. Allway, G5AU, Epsom, Surrey, Eng.

C. D. Bakker, PK1HB, Soebang, Java
L.A.C. D. O. Biggs, G6BI, Egham, Surrey, Eng.

Tel. Gilbert Blackah, G3LI, Shipley, Eng.
A.C.I. J. Buchan, G4QA, Westcliff, Eng.
Paul V. Clotfelter, W5BPM, Gladewater, Texas.

Louis L. Driggs, Jr., W8HEQ, Dayton, Ohio

William H. Ehrich, W9LYB, Indianapolis, Ind.

Frederick Marshall Field, W5HUX, Blytheville, Ark.

Tel. J. W. Hamilton, G5JH, Hardwicke, Glos., Eng.

Arthur Aubin Hebert, W1ES, West Hartford, Conn.

A.C.I. R. W. Hunter, G3FL, Swindon, Wilts, Eng.

Rudolph Ihring, W2GKO, Montclair, N. J.
Bernard F. Lagen, W9WDX, Omaha, Nebraska

Demotta H. Little, W9VHG, Glenview, Ill.

George C. Neblett, Ajo, Arizona
Denver Park, W8UQZ, Three Springs, Pa.

Otto J. Schott, W8CTY, Canton, Ohio
W.O. H. G. Simmons, G5SI, Gravesend, Kent, Eng.

Wilmer A. Stekly, W7HJO, Wilder, Idaho
W.O. J. Vyse, G4IR, Hull, Eng.

Robert Webster, G5BW, Eastbourne, Sussex, Eng.



..... and now it's
FOR UNCLE SAM

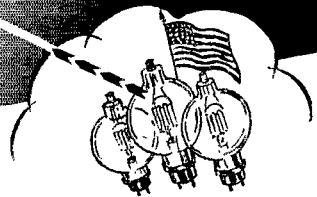

*American industry comes through
with flying colors.*

With almost machine gun rapidity Eimac tubes have been adopted by one after another of the leading radio communication fields. The radio amateur, commercial airlines, frequency modulation, blind landing equipment, police radios, television, diathermy, general industrial applications . . . and now Uncle Sam.

It is fitting that defense equipment be of the finest obtainable and of proven merit. Eimac tubes fit that description and more too. Their service in the ground stations of practically every major airline...their pioneering in frequency modulation . . . in hundreds of equally important commercial transmitters throughout the world . . . and many other shining examples make them important to the national cause.

Eimac is continuing to produce more and ever more of the tubes which are unconditionally guaranteed against premature failures caused by gas released internally and Eimac is continuing to improve performance capabilities . . . set higher and higher standards of quality...develop new tube types as the industry needs them. But Uncle Sam comes first—you may experience short delays in delivery, but expanded facilities will bring them as fast as possible.

In the field of electronics the swing is to E.

EITEL-McCULLOUGH, INC.
San Bruno, California

Eimac
TUBES

See the nearest Eimac representative.

Observing Individuals choose . . .

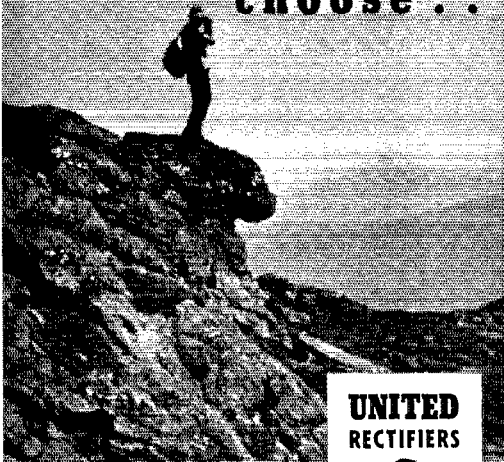

The real thinkers of the engineering fraternity are predominant users of UNITED rectifier tubes. The familiar styling of these famous tubes is now a hallmark of professional wisdom. Others, with a change here and a change there, come and go. Those "in the know" steadfastly insist on UNITED.

- TWO TYPES TO CHOOSE FROM**—Unshielded and shielded—each has specific advantages.
- GREAT SAVING IN TIME DELAY**—10 seconds initial or routine—this quality of the 966 places it in a class by itself.
- FULLY SHIELDED CONSTRUCTION**—For certain applications where shielding is important, type 966A is the uncompromised solution.
- NO EXCESS MERCURY**—966 and 966A have measured mercury content, preventing harmful amalgams and costly time delay.
- LONG AND SATISFACTORY LIFE**—is not merely predicted, it is a matter of history.

Types illustrated interchangeable with 866 and 866A. Write for technical data covering these and larger types 972, 972A and 975A.

UNITED ELECTRONICS COMPANY

42 SPRING
STREET



NEWARK,
NEW JERSEY

UNITED RECTIFIERS



966A \$1.50

966 \$1.20



RATINGS
(both types)

Filament
2.5 volts, 5 amps.

Peak inverse
10,000 volts

Plate current
1.0 amp. peak
25 amps. average

Tube voltage drop
10 volts average

Code Proficiency Program

(Continued from page 41)

Note that new daytime schedules for qualification have been added in between the usual night runs at monthly intervals. These added runs are purely an experiment and unless they are adequately useful they will be discontinued or changed. We hope that they will be a convenience to those few amateurs who "work nights" and that additional numbers of amateurs may find it convenient to use some of them. Due to the fact that copies are received over a considerable period after an official run, it will not be possible to get out the certificates and reports on papers on the May 6th run by May 14th, but you should have them by June 1st and you are free to try your hand on May 14th *anyway!* Checking copies is an individual and a painstaking job. The secretarial and editorial department workers on this require a 25- to 30-day period for checking papers and will continue to try to take care of certificate returns within a monthly period.

Getting Sending Practice from W1AW

In early January WIBXC wrote us that he believed our program could be made even more useful if we would provide the text of some of the runs in advance . . . not that they should be consulted by those working on bettering their receiving ability, at least until after they have taken down copy to be checked . . . but that with a text before him an individual may try to send the same text on a code practice oscillator, simultaneously with the running of the tape from W1AW. The practical slant is that this should enable one accurately to emulate tape sending, or at any rate find out just what is wrong with his spacing, length of dots or dashes, etc. By following a standard by ear an operator can best correct his tendencies and positive mistakes and most quickly absorb into his consciousness exactly what the rhythm of good sending is like. We at once suggested to Mr. Swan that our O.B.S. messages to amateurs are repeated some twelve times per week on schedule, and that when these had been copied once, they could be used subsequently for *sending practice*.

All amateurs will be interested in the method of attack on the problem of improving one's fist as in use by Dean C. Swan, Jr., W1BXC. We quote from his comments:

"For the sake of simplicity I am using two pairs of headphones, one pair connected to the receiver and the other to my code practice audio oscillator. I cross the phones on my head so that in one ear I am receiving W1AW and in the other ear my own fist. I wish to report to you that the relatively small amount of practice I have had in this manner has improved my fist tremendously! Errors in spacing and in character formation become glaringly apparent and correction of such errors becomes the most natural thing in the world. I send the O.B.S. text to myself at the same time the words are sent by tape from W1AW.

"It would not be too emphatic to say that about 99% of the amateurs actually NEED to improve their sending. What a surprise many amateurs would receive if they took the regular sending test for a commercial ticket! Listen on any amateur band and notice how rare it is to hear sending that even approaches the perfection of tape sending.

"I feel certain that if sufficient publicity were given this matter so that amateurs will try this scheme just once, they

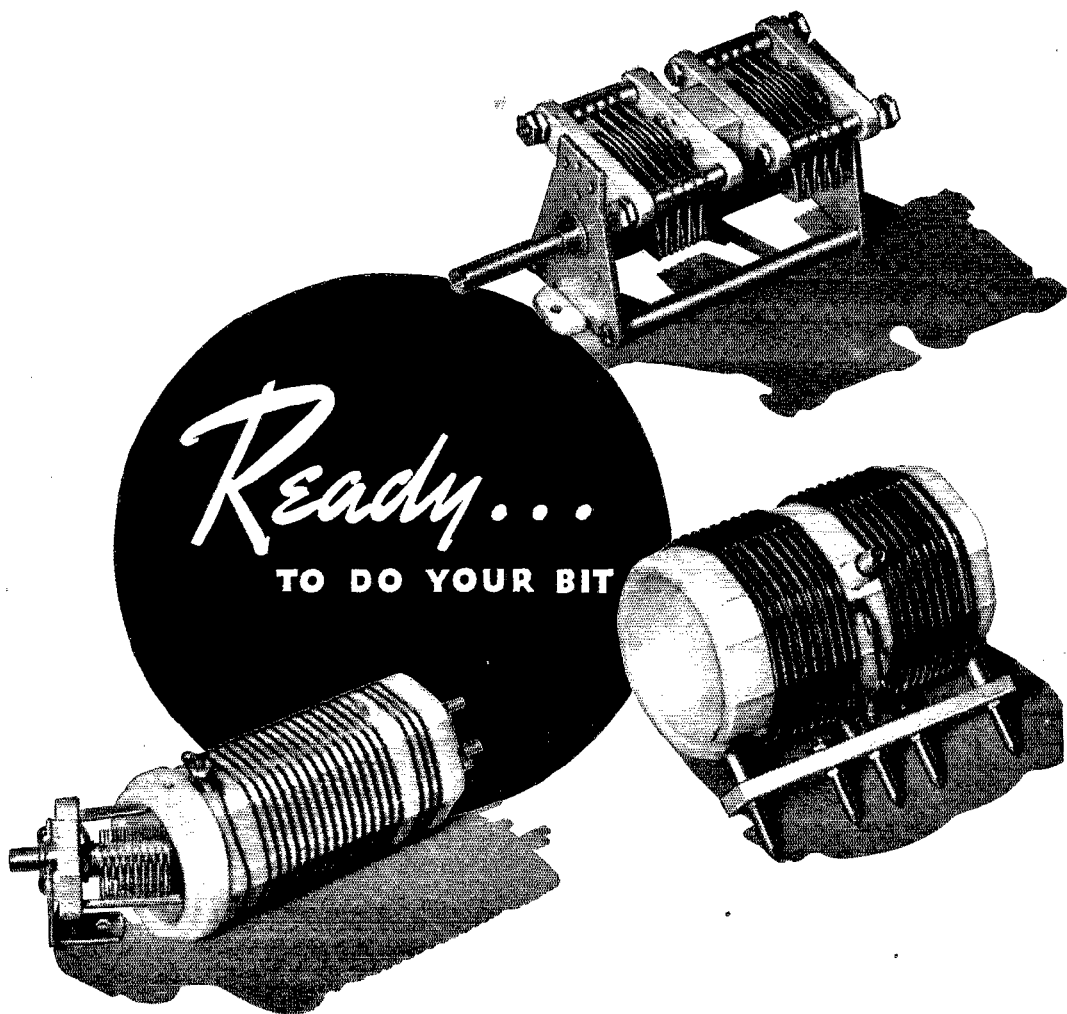

Is your rig ready to go on the air if it is needed in an emergency?

If it is equipped with Johnson Inductors and Condensers, you know these parts have been designed for highest circuit efficiency and that they will "stay put".

If you are using old type, poorly designed components, you will be surprised at the increase in signal strength when you change to Johnson.

Standard with Broadcast Stations and other commercial services for years, you can now get the same precision engineering and painstaking manufacture in the Condensers and Inductors for your own rig.

Ask your favorite jobber to see these fine parts today. He also has your copy of the new Johnson-Bassett Antenna Handbook at only 25c.

Ask for Free Catalog 966J



E. F. JOHNSON CO

WASECA, MINNESOTA

EXPORT, 25 WARREN ST., NEW YORK, N. Y.

"MANUFACTURERS OF RADIO TRANSMITTING EQUIPMENT"

RADIO TRAINING



PORT ARTHUR COLLEGE — not privately owned, not operated for profit, a college built and endowed by the late capitalist-philanthropist, John W. Gates — offers the most thorough practical Radio training in America. P. A. C. owns Radio Station KPAC, which is equipped with the very latest type 1000-Watt high fidelity RCA transmitter, operating on 1220 kc. with directional antenna system. The Radio training covers thoroughly Airways, Press, Announcing, Teletype, Typewriting, Laboratory and practical experience at KPAC transmitter, control room and studios. Announcing is an optional part of this training; nevertheless a number of students annually make successful announcers.

Port Arthur College pioneered the teaching of radio with its first classes in 1909, and for thirty-one years has maintained an active Employment Bureau that is successful in placing graduates in airways, broadcast and marine radio industries.

*If interested in details about the Radio Course,
write for Bulletin R*

PORT ARTHUR COLLEGE
PORT ARTHUR (World-Known Port)
TEXAS

LEARN TO SEND AND RECEIVE **CODE**

Learn to send and receive code signals, like operators on ships at sea and at commercial and amateur land stations. Intercept distress signals, news flashes, bulletins, and dozens of other kinds of interesting radio communications.

MASTER TELEPLEX teaches you to receive code exactly the way the world's best operators do — by sound. A heavy waxed paper tape, running through a machine, operates an automatic key which sends messages to you, at any speed you desire. As you improve in speed, the machine sends faster, gradually preparing you for top-speed amateur and commercial signals. With the new All Electric MASTER TELEPLEX you learn to send by sending and the signals you send are repeated back to you, exactly as you sent them, thus enabling you to correct your own errors. We furnish a complete course, lend you the improved All Electric MASTER TELEPLEX and give you personal instruction with a **MONEY BACK GUARANTEE**. Send for our new TELEPLEX FOLDER Q5 today. **IT'S FREE.**



**"HAM"
SPECIAL**

Standard Teleplex — a highly efficient code teacher using heavy specially prepared waxed paper tape, having two rows of perforations. Write for Free folder "Q. T.-5"

TELEPLEX CO., 107 HUDSON ST. JERSEY CITY, N. J.

will be 'sold' on it. Perhaps I am missing some angles on this, but it would appear that there is everything to be gained and nothing to be lost in using *QST* texts."

Fist-Tape Comparisons Advance Coördination of Hearing and Sending Process; Any Amateur Can Now Rig Oscillator and Check His Fist with WIAW Sending

We concur that the described method is capable of contributing benefits by making rapid perception of sending faults, and corrections possible. This should be especially beneficial in helping one get started correctly in his early formation of characters. Dr. W. G. Hallstead (Penn Yan, N. Y.) has for months helped amateurs by sending them inked recordings of their fists. These have shown a need. The direct aural method of comparing personal keying ability with ideal word and letter spacing give us a powerful tool for remedying defects. Our WIAW schedule makes possible a *direct* comparison between one's normal fist and tape sending.

This comparison can be carried out without much of any trouble by any amateur individually. The simplest form of buzzer, or an audio oscillator properly connected to a headset and key and a check of the fist against the machine sending at definite known speeds will tell every amateur some things he is anxious to know! This trial and some regular comparing should make rapid sending improvement possible. To hear (and compare) signals directly will most rapidly aid in gaining control of the key! The battle is half won when a proper "mental standard" for the operator which is free of imperfections has been established. Looking at tape records and even more important listening to automatic transmission will help anyone analyze and perceive imperfections. There is usually some room for improvement! Just to listen regularly to a tape which is clean cut with perfect spacing or near it will help one's sending ability a great deal. But to listen and attempt to superimpose one's sending of the same copy is to *learn good sending* by the instantaneous comparisons — and receiving speed comes upward too!

Unconsciously one emulates tape sending if he is fortunate enough to hear a great deal of it. Unconsciously (by practice) a mental establishment of machine spacing as a proper personal standard is brought about. By all means practice copying stations having automatic transmitters. Use all the Press stations whose schedules are listed in *QST* from time to time. Use the enlarged WIAW schedule of practice transmissions in accordance with the method described!

The League repeats its recommendation that in individual stations listening and keying monitors should be used consistently to help the ear perform its function in aiding the fist to send *good Continental*! It is a personal view that a 25% improvement or better would result in the overall perfection of sending in the amateur bands if the senders would only "hear themselves as others hear them." A tape recording or electrical transcription of signals helps one see his faults. The remedy is as near as one's facilities for listening to his sending in many cases!

Quick HOUR SERVICE

ON EVERYTHING YOU ORDER FROM THIS AD!

Echophone COMMERCIAL

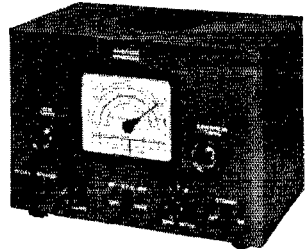

EC-1
A SENSATIONAL BUY
Only \$49.95 COMPLETE!

Try and beat all these amazing features at this sensationally low price. Tunes from 545 kc. to 30.5 mc. (550 to 9.85 meters) on 3 bands. Electrical bandspread on all bands. 6 tubes. Self-contained speaker. AC/DC-115-125 volts. (Model EC-1.) A real communications receiver.

EC-2 8 TUBES, DYNAMIC SPEAKER \$29.95

Up to the minute communications receiver performance. 8 tubes; 3 bands; covers 545 to 2100 kc. — 2.1 to 8.1 mc. — 7.9 to 30.5 mc.; self-contained 5" PM dynamic speaker; preselection on all bands; calibrated bandspread scale on 80/40/20/10 meter amateur bands; automatic noise limiter; electrical bandspread at all frequencies in the tuning range; operates on 115 volts AC/DC. (Model EC-2.) Never before have you been offered these outstanding communications features at a price so low.

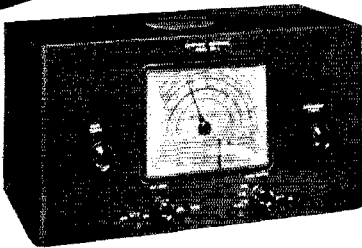

EC-3
10 TUBES, FLYWHEEL TUNING \$49.95

Here's your opportunity to have all these communications features at this remarkably low price. Crystal filter (four position variable selectivity); calibrated bandspread; automatic noise limiter; preselection on all bands; 2 stage IF amplifier; fly-wheel tuning; separate 6" PM speaker; CW monitor; 10 tubes; 3 bands; covers 545 to 2100 kc. — 2.1 to 8.1 mc. — 7.9 to 30.5 mc.; electrical bandspread. Operates on 115 volts AC/DC.

LATEST CONDENSER BARGAIN LIST

Oil Filled — Oil Impregnated
FILTER CONDENSERS

As low as 59¢

Thousands now in use by "hams" who are still wondering how we can sell such dependable quality condensers at such low prices. No compromise with quality. Made by a leading manufacturer and GUARANTEED at rated voltages.

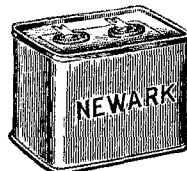

Mfd.	Volts DC.	Size	Price
1	1000	5 x 3 1/2 x 1 1/2	\$.59
18.3	1000		2.15
4.4	1500	5 x 3 1/2 x 1 1/2	1.50
2	2000	4 1/2 x 3 1/2 x 1 1/2	1.50
8	2000	5 x 3 1/2 x 3 1/2	2.75
4	3000	5 x 3 1/2 x 3 1/2	3.75

TERMS
ON ECHOPHONE EC-2 OR EC-3
\$5 DOWN and \$5 PER MONTH
Order from Newark Now

It's easy to buy an Echophone on our time payment plan. Send \$5.00 down payment and credit references with your order. We ship at once when credit is O.K. Pay balance, plus 6% carrying charge, at \$5.00 per month.

DISPLAY YOUR CALL LETTERS

Your call letters in GOLD ... on your ham shack door or auto window ... will look mighty fine!

10c

Big, shadowed decalomania letters nearly 2" high. Send time for yours today. Don't forget to give your call letters.

SEND FOR THIS FREE BOOK

Our latest issue, with illustrations, descriptions and lowest prices on thousands of bargains. Sets, parts, supplies and accessories of all the better makes. No ham should be without his NEWARK CATALOG. It's FREE!

WRITE TODAY!

NEWARK Electric Company
323 W. MADISON ST.
Dept. Q CHICAGO, ILL.

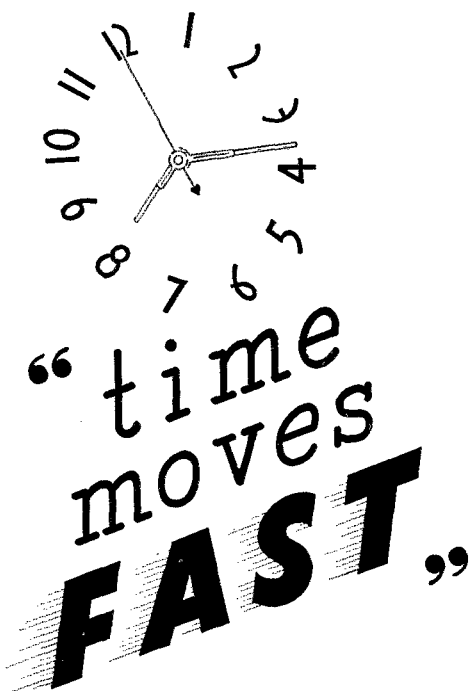

Time is relative, for Time is measured by a rubber yardstick called Change.

When the earth was young, time meant nothing. It took millions of years to turn lush vegetation into fields of oil and coal. Change came slowly — but who cared?

Today time moves F-A-S-T! Changes come with lightning-like rapidity. Overnight a peaceful countryside is turned into a smoldering ruin. Consternation and fear grip men's hearts as they bend their bodies in back-breaking tasks.

Overnight modern industry has changed its complexion, using makeshift means and methods to adapt itself to pressing emergencies — of national defense, of labor problems, of lack of skilled hands, of lack of raw materials.

In these trying times it is comforting to know that there still are some individuals and firms who remain unperturbed — who carry on their traditions of loyalty. Here at Kenyon, where we have made transformers exclusively for 20 years, there is quiet confidence among management and personnel that every demand made upon us will be met — with quality unchanged and unchanging.

KENYON
TRANSFORMER CO., INC.

840 BARRY STREET NEW YORK, N. Y.

This article is to suggest a possible wider use of WIAW to help those interested in making their sending top-notch, as well as to invite everybody to get into this campaign to award Code Proficiency certificates. Sending and receiving go hand in hand, and extra-ability developed in one branch is sure to be reflected favorably in the other. Thus time in sending practice is not wasted, but is a stepping-stone to improvement in receiving. The cultivation of proper mental standards for the all important spacing of characters and words is vital to operating success. Those who have not been too many years in the game will do well to arrange a setup that will enable them to profit from the plan-for-improving-sending that has been presented. It should start them *right*, so they will not have bad habits to unlearn. For the chap many years an amateur who has never checked his sending or who has a need to break himself of certain habits, there is no faster method than this one of *direct comparison* of his sending with automatically sent signals having the proper characteristics.

Try it! Starting this month we are listing April *QST* references to be followed in preparing tapes for the code practice transmissions sent on Sundays, Tuesdays, and Thursdays between the dates of April 27th and June first. Whether references will continue to be given will depend largely on whether users find them helpful for getting *sending* and other practice, so let us know if you find this new feature a real service or not when you write or send in copy on qualifying runs.

To every amateur licensee, we renew our invitation to join the fraternity of organized radio amateurs in the A.R.R.L. program to strengthen amateur radio by helping each of us add to our Code Proficiency. We're reserving a fine certificate award for you. If you haven't got yours, get in on the next qualifying run at 15 w.p.m. (or any speed) and get started. You will find it worthwhile, and good fun at the same time.

Delta Division Convention Monroe, Louisiana, May 24th-25th

FOUR northern Louisiana ham clubs — the Caddo Parish, Ouachita Valley, Red River and Advance Radio Clubs — are uniting to sponsor the Delta Division Convention at the Hotel Frances, Monroe, Louisiana, May 24th and 25th.

As this will be the first Delta convention in several years, a large attendance is expected. Secretary Foster, W5HNV, promises a fast-moving program with no blank spots — yet plenty of time for get-togethers and rag chews so necessary for a successful convention. There will be dancing Saturday night of the convention and a banquet Sunday afternoon, as well as large displays of new ham gear by distributors and manufacturers. The Y.L.R.L. will provide activities for the feminine contingent.

Complete registration fee is \$2.50 per person. Address all communications to Chairman Charles L. Kelley, W5IRO, Hodge, Louisiana.

Be Right with **OHMITE** RHEOSTATS · RESISTORS · CHOKES · SWITCHES

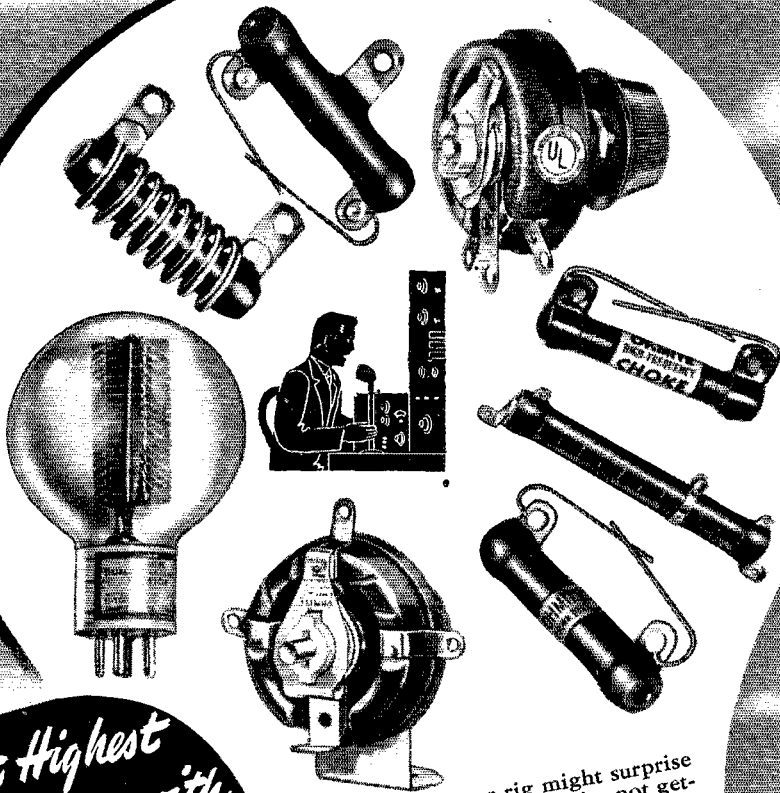

Get Highest Efficiency with **OHMITE** Units...

A check-up of your rig might surprise you — it may reveal that you're not getting the efficiency you think! Hook up an Ohmite Dummy Antenna and check your R.F. power, determine your transmission line losses, check your line to antenna impedance match. You'll probably find that by replacing old or inferior parts with dependable Ohmite units, you may make a big improvement in the efficiency of your rig. Ask your Jobber for these Ohmite parts: Parasitic Suppressor, Center-tapped Resistor, Rheostat, R.F. Plate Choke, Dividohm Resistor, Brown Devil, or Band-Change Switch. They're built right to give you long, trouble-free service!

Write today for Ohmite Catalog 17
OHMITE MANUFACTURING COMPANY
 4864 Flournoy Street Chicago, U. S. A.



send 10c for **OHMITE Ohm's Law Calculator**

That "PRO"
touch...



● If you want your "rig" to look professional, just use these Aerovox paper condensers. Likewise other Aerovox quality condensers in all types. And for superlative assemblies, use Aerovox commercial-grade capacitors listed in special catalog. ● Consult your jobber about Aerovox quality condensers.

Heavy-duty paper condensers. Wax-impregnated, wax-filled sections.

Rust-proof metal container. Convenient soldering terminals.

Conservatively rated for cool operation and long life.

1000 v. D.C.W. .5 to 4 mfd.



★ BOOK REVIEWS ★

Calling CQ—Adventures of Short-Wave Radio Operators, by Clinton B. DeSoto. Published by Doubleday, Doran & Co., Inc., New York City. 291 pages, not illustrated. Price, \$2.00.

Considering its forty-odd years of existence, its rich tradition of service, the many instances when amateurs have demonstrated their value to their communities in times of stress, it is remarkable that amateur radio has received so little treatment in the field of popular literature; certainly if a writer is looking for stories of adventure, the high call to duty, the thrills incident to distant expeditions in far lands, he need look no further than this unique of all hobbies. Perhaps the trouble has been that the average writer, lacking the intimate knowledge of amateur practices which only the active pursuit of ham radio can give, finds himself helpless to create genuine ham atmosphere around the bare incidents themselves.

Five years ago Clinton DeSoto, W1CBD, of the League's secretarial staff, brought out his first book, "Two Hundred Meters and Down — the Story of Amateur Radio." As an historical account it is a valuable work, but its very nature has confined its interest to hams themselves, for the most part. With the publication of "Calling CQ" he has now filled the need for a popular work on amateur radio. A grand answer to the friends and family who ask, "What is amateur radio all about?" it is also a book that few hams will be able to put down until they've read through to the last page. The essential facts of amateur radio's history and development are sketched, but briefly — the body of the book is a collection of stories of the adventures, friendships and heroism of hams the world over. Some of the yarns are about incidents you will remember but of which you never knew the inside story; others will be entirely new. All make swell reading.

— A. L. B.

Code-Instruction Table

(Continued from page 56)

when group work or individual sending practice is being carried on.

Any convenient type of construction may be used. However, as in any a.c.-d.c. sets, the wiring should be completely insulated from the metal chassis or case.

Table Construction

Fig. 3 is a sketch showing the general method by which a table may be built. No specific construction is indicated, since bracing and other details will depend upon the size of the table and preferences of the builder. The important thing is to be sure each position provides enough room for the student to work comfortably. In particular there should be sufficient depth so that the key can be placed the proper distance — about 18 inches — from the edge of the table.

The interconnecting switches, Sw_1 , Sw_2 , etc., can be ten-cent store s.p.s.t. knife switches and the instructor's selector switch a wafer-type unit. The latter can be obtained in the single-pole type with as many as 23 contacts. Since no special precautions need be taken with respect to insulation or voltage drop, probably the most economical wiring job can be done by using ordinary bell wire. In cases where the students bring their own headsets it would be advisable to mount a tip-jack assembly at each position to facilitate connection.

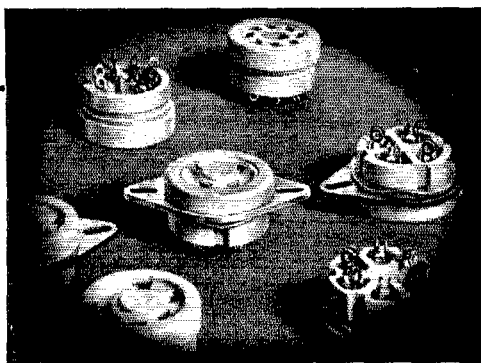

Designed for Application

● The new MILLEN line of MODERN PARTS for MODERN CIRCUITS includes: transmitting condensers, receiving condensers, sockets, QuartzQ coil forms, standoffs, dials, IF transformers, RF chokes, safety terminals, etc., etc.

Catalogue Upon Request

JAMES MILLEN
150 EXCHANGE ST.



MFG. CO. INC.
MALDEN, MASS.

Sales Leaders in

TAYLOR'S Tube Parade!

**T-40
TZ-40
\$3.50**



**TW-75
\$8.00**

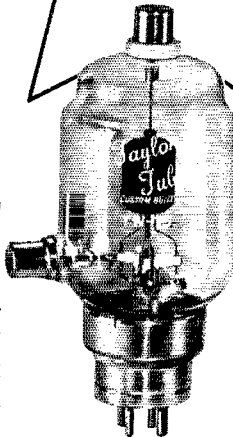

**EACH TUBE IS
CUSTOM BUILT
TO GIVE
"More Watts
Per Dollar"**

OUTSTANDING FEATURES

Taylor's T-40, TZ-40, TW-75 and TW-150 are able to stand up to 1000% temporary overload without injury to any of their elements. This extremely high *Safety Factor* is due to their famous "Processed Carbon Anodes". This Taylor margin of extra safety is of vital importance, as many tubes are ruined in tuning up amplifiers. (When a stage goes out of resonance, the plate current soars, resulting in plate dissipation far in excess of the tube's

normal rated dissipation.) Taylor's "Processed Carbon Anode" Tubes thus have longer service life and represent to the amateur "More Watts Per Dollar".

**TW-150
\$15.00**

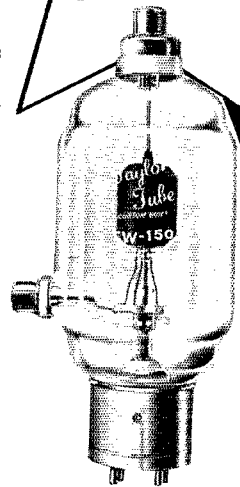

866-A/866*

**Half Wave Mercury
Vapor Rectifier**

\$1.50

RATINGS

Fil. Volts.....2.5
Fil. Amps..... .5
Max. Inverse Peak
Plate Volts....10,000
Average Plate Amp..0.25
Peak Plate Amp... 1.0

**THE FIRST LOW PRICED
RECTIFIER OF ITS TYPE**

* For the past 2 years, Taylor's 866 has had the ratings of an 866A. See QST advertisement—April 1939.

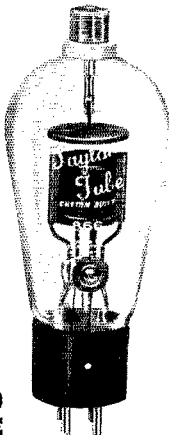

TAYLOR MANUAL

Contains full operating information and ratings of all Taylor Tubes, plus 48 pages of up-to-the-minute transmitting data. It's FREE for the asking at your distributors or send five cents to Taylor Tubes, Inc., to cover cost of mailing.

Taylor HEAVY **CUSTOM BUILT** DUTY **Tubes**

TAYLOR TUBES, INC., 2341 WABANSIA AVE., CHICAGO, ILLINOIS

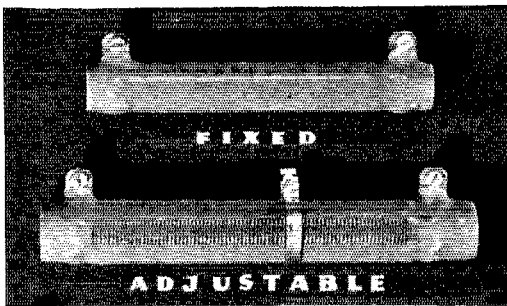

(WL) RESISTORS

WITHSTAND MOISTURE

The elimination of minute cracks due to its crazeless structure, enables Ward Leonard enamel to withstand humidity, moisture and immersion better than any other known enamel or protective coating.

Send for circular 507. It not only gives Resistor data and prices but other valuable information for the ham.



WARD LEONARD ELECTRIC COMPANY

41 South Street, Mount Vernon, N. Y.

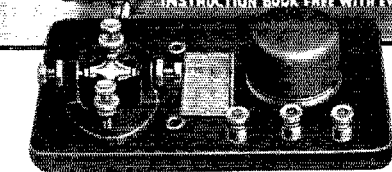

Make your spare moments count now! Learn the wireless code with a Signal wireless Practice Set. Set consists of key and high frequency buzzer mounted on a mahogany finished wood base equipped with binding posts. The code is printed on a plate fastened to the base between the key and buzzer. Adjustable buzzer. Price of instrument illustrated is \$3.40 list. If your jobber cannot supply you, order direct.

SIGNAL ELECTRIC MFG. CO.
MENOMINEE, MICHIGAN

Established
1892

SIGNAL

25 YEARS AGO THIS MONTH

WITH League membership passing the 1000 mark, *QST* for May, 1916, presents reports of the first Monday and Thursday tests of the new trunk lines by Managers Hebert and Matthews. Station ranges are increasing and gaps in the trunk lines are being filled, but the first tests got no messages to the ends of the lines, and the editor doubts that the goal will be reached before summer because there are already signs of the approach of "our ceaseless enemy, The Static."

The first "rotten" story by The Old Man, "Rotten Sending," appears in this issue. T. O. M.'s reputation for humor not yet having arrived, it is a short and serious damning of poor fists, bad swings, and excessive abbreviation. The one and only technical article, a symposium, deals with "The Audion as a Detector of Undamped Waves," showing several circuits for obtaining feedback to achieve heterodyne detection. This, of course, is all for long-wave commercial and government stations, as all amateur transmission is by spark

"Deacon" Gravely, 3RO, of Danville, Va. (now W3BZ and formerly for many years the Roanoke's director), has a letter in the Correspondence Department making suggestions for the improvement of *QST*, one of which is the establishment of a Query Department. The department is in fact started with this issue. Two of the questions that are very much bothering the boys are where does the charge go in an air-dielectric condenser when the plates are removed, and why is it that with 1 kw. input they have a secondary voltage of 20,000 and 5 amperes in the antenna? Why isn't that 100 kw.? Already the shadowy outline of the classic argument on power factor may be seen!

In the Services

(Continued from page 19)

operations section at Allegan, Mich., monitor the ether. . . . When the 107th Cavalry, one of the Cleveland sections of the Ohio National Guard, is inducted at Camp Peay, Tenn., Sgt. I. C. Klepper, W8NGZ, and Plc. Lloyd Frohring, W8PMJ, will get some heavy brass pounding assignments. . . . At Fort Lewis, Wash., we find Edward Damen, W7GTQ, and G. M. Larson, W7HJN, in communications work. . . . Karl Knudsen, W2OZ, is chairman of his local (Brooklyn No. 204) draft board, but hasn't run across any hams being inducted as yet. . . .

Have you sent *your* service record to the League, OM? If so, we'll have you recorded here next month, even if we have to go to 6 pt. type! If not, please refer to January or March *QST* for a list of data we'd like to have on you, and drop us a postcard. Get any other hams in your outfit to do likewise. We'd like a complete record of amateur participation.

★ ★ ★ ★ ★ ★

The radio amateur's handbook

THE STANDARD MANUAL OF AMATEUR
RADIO COMMUNICATION



1941

PUBLISHED BY THE
AMERICAN RADIO
RELAY LEAGUE

\$1 IN CONTINEN-
TAL U. S. A.

The Handbook tells the things which are needed for a comprehensive understanding of Amateur Radio. From the story of how Amateur Radio started through an outline of its wide scope of the present — from suggestions on how to learn the code through explanations of traffic-handling procedure and good operating practices — from electrical and radio fundamentals through the design, construction, and operation of amateur equipment — this book covers the subject thoroughly. It includes the latest and the best information on everything in Amateur Radio.

\$1 postpaid in Continental U.S.A.

\$1.50 elsewhere

Buckram bound edition, \$2.50

American Radio Relay League, West Hartford, Conn.

Station Activities



ATLANTIC DIVISION

EASTERN PENNSYLVANIA — SCM, Jerry Mathis, W3BES — Due to various reasons, including removals and inactivity, several former ORS/OPS have been dropped from the rolls. We now have 54 O.R.S., 15 O.P.S., 4 O.O. (all Class I), 3 R.M., and 7 O.B.S. With the appointment of many new E.C.'s and their assistants, the enrolling of A.E.C. stations is going ahead nicely. W3BYS is circularizing all amateurs in the Phila. County. He found that there were only 27 men listed with the A.E.C. out of the 600-odd licensed operators in the city. This vital work may determine the status of amateur radio, so please contact your local Emergency Coordinator to share in this endeavor. BXE is now a member of T.L.M. FJU is quite active in 'phone traffic these days, and is also taking over the E.C. job for his territory. ADE reports into the Eastern Pa. O.R.S. Net daily, and reports much interest in code proficiency in the Harrisburg area. 8EU is coaching three prospective hams. 3ASW is trying to line up a traffic net to handle messages to and from Indiantown Gap. 3GYK lost his antenna mast in the recent gales. GAG will be on with his $\frac{1}{2}$ -kw. c.w. rig soon. 8UQM worked 44EBB on 3.5 Mc. with $7\frac{1}{2}$ watts, and has received a card to prove it. GYY has a new HQ-120, a new mill, and a qsl from WAR. The Navy is keeping HFE plenty qrl, but he is working on an 815 mobile job. 8ABP is back from a month's visit in Florida. KT used his new Field Day rig in the 28-Mc. W.A.S. Party. The ice was too much for AOC's antenna. EDC almost joined the Army, but we have him back with us again. AKB copied 45 w.p.m. in the Army speed test. QV is making phonograph recordings of the gang over the air. AOC sticks to the idea that we should have a Section bulletin. The last time it was mentioned there was practically no response. 8ATF had a visit from W8CR and W8LZD, Technical Sergeants in the communications section of the 28th Division. 8LZD reports that there are ten hams in his company. Many of the O.R.S. are reporting their traffic via radio. W2MNT of Irvington, N. J., wants a schedule in or near Bethlehem. 3FRY is building a super band-switching, gang-tuning emergency transmitter. 3GQW has an NC101X. The Phila. Elec. Co. has a thriving Radio Club among its employees.

Traffic: W3GKO 1808 3AOC 855 8AKB 318 3BXE 252 3AQN 153 3FJU 153 8ATF 137 8EU 134 3ADE 134 3ASW 117 8AOE 75 3GYK 21 3DRO 20 3HCT 19 3GDI-SUQM 17 3DXC 16 3IAY 14 3EEU 12 3BES 10 3GGY 6 3HFE-SQEW 5 3KT 4 3FPC-SSNZ 2 8GV 1 GTS (WLMG 159) (Jan.-Feb.: W3IKW 34 3GDI 14).

MARYLAND-DELAWARE-DISTRICT OF COLUMBIA — SCM, Hermann E. Hobbs, W3CIZ — 3AEA now has an 807 final stage and is interested in traffic. AXP is located at Barksdale Field, La. CAB is on 3.5 and 7 Mc. and keeps a few schedules. DWX is Secy. of the Balto. Amateur Radio Assn. DEI is President and Comm. Mgr.; GRT is Vice-Pres.; GXO is Treas.; and DWC and Charles Reddick, Directors. The Club Room is at 425 North Eutaw St., Baltimore, Md. EQK expects to put the finishing touches on his new all-wave c.w. 'phone rig. EIZ is qrl with A.A.R.S. nets and traffic. Mr. Clinton DeSoto of A.R.R.L. H2 visited the Western Maryland Amateur Radio Club, on Feb. 14th, as its guest, and participated in an interview over the local BC station; in the evening he spoke to the club membership. IEM has joined the Md. A.A.R.S., and will make a welcome addition to that flourishing gang. IIS has a new 12-element motor-driven beam for 56 Mc., with three sets of 2 half-waves in phase and three sets of reflectors. The Wilson High School in Washington, D. C., has its own station with JEP, ILD, IML and IRO as operators and others in line for tickets. IML took Class A exam. JDK keeps daily schedules with 1KKE. 8JTT/3 is busy with trunk lines, and has finished his ganged-tuning retro exciter with 25 watts output. 8CL from Buffalo has taken a job in this Section. 3OZ/3 has been appointed 'Phone Radio Aide in the 3rd C.A. with the call WLQO, and moved recently. 3PV is interested in the 3rd C.A. cryptography classes.

Traffic: W3AEA 3 BKZ 129 BWT 1195 CAB 14 CDQ 17 CJZ 858 EQK 27 EIZ 219 FE 7 GMK 3 IEM 34 IIS 95 8JTT/3 81 OZ/3 PV 47 CXL (WLM 3416).

SOUTHERN NEW JERSEY — SCM, Lester H. Allen,

W3CCO, Ass't SCM and A.A.R.S. Liaison R.M., Ed. G. Raser, W3ZL, Regional Coordinator in charge of Emergency Coordination, Ted Toretti, W3BAQ, R.M.'s: W3BEI, W3BYR, W3ITU, P.A.M., Bill Hannah, W3EUI. Section Net frequencies: O.P.S., 1980 kc. (Thursday, 8 p.m.); O.R.S., 3700 kc. (Tuesday, Thursday and Saturday, 8 p.m.); O.R.S., 7280 kc. (Monday, Wednesday and Friday, 8 p.m.). I wish to welcome all you new fellows to our Section, particularly the Army men at Fort Dix: I trust you will enjoy your stay with us and hope you can get around and meet the boys in our Section. For those who have not reported to the S.C.M. as yet, I suggest you drop a line to me and let me know of your activities. Both O.P.S. and O.R.S. Nets are progressing nicely and, if you are interested, there is always room for one more. The Section QSO Party proved highly interesting, and top honors go to W3BAQ/3 who turned in a score of 512 points. Second place went to W3CWG with 156 points. Other participants were: W3AQ, W3HDW, W3FXV, W3ABS, W3ACC, W3EUI and W3OQ. New appointees this month are: BWF, O.P.S.; EBC, Emergency Coordinator for Somerville; HDW and JBU, O.R.S. EWK had his O.R.S. endorsed for another year. TL has applied for O.P.S. and IUO for O.R.S. Walt Scott, W3HOJ, wishes to be remembered to the S.N.J. gang, and says he would like to have a few of the boys write him care of Postmaster C, Radio Division, U.S.S. *New York*, New York City, N. Y. W8NPQ is now operating portable at Atlantic City, and will report into the A.A.R.S. shortly. W3BEI has applied for membership in A.A.R.S. 3BZX was recently appointed Alternate Net Control (N.C. 6) for the A.A.R.S. Harvey made B.P.L. this month, which makes the second time anyone has done it since I have held office as S.C.M.; it happens he has done it on both occasions. Congratulations. The Delaware Valley Radio Association of Trenton held its annual election, and the following were voted to office: CCO, Pres.; EED, Vice-Pres.; HAZ, Secy.; EUI, Treas. The D.V.R.A. wishes to advise that their station, W3AQ, will be open to visitors every Sunday afternoon from 1 to 5 p.m. If you go out for a Sunday drive, make Trenton one of the towns to visit and see W3AQ. JBU received his Code Proficiency Certificate three months from the time he received his ticket. FB, Sam! HAZ reports regular schedules with W3VE/4 at Fort Bragg, N. C. IDZ is looking for Arizona and Idaho for W.A.S. on 1.75-Mc. 'phone. OQ has temporarily left the 'phone bands for c.w. and is doing an fb job as O.B.S. DNU is still being heard on the 3.5 Mc. A.A.R.S. nets with an fb signal. We hope to see you back in the O.R.S. ranks soon. HW joined the A.A.R.S. He was a member back in 1928. HAZ has been appointed alternate net control in NJ-80. Net. ATF is a new member of the NY-80 AARS Net. ZI schedules his xyl, HVO, daily from W2NPV. 3AVJ manages to keep his schedules with the O.R.S. and A.A.R.S. AEJ has been doing an fb job with traffic on 1.75-Mc. 'phone. 3FXV schedules W2GIC daily at 7:30 p.m. and W9GBC/4 at 6 p.m. GMY had quite a siege of the flu, but promises to be back in the harness shortly. Due to the increased activity on 56 Mc. in our Section, we are going to form a 56-Mc. O.P.S. Net. Send in your application blanks for an O.P.S. appointment and join the U.I.F. Net. We need a few fellows to get the 7 Mc. Net under way, and we shall be glad to receive applications. IOK received qsl cards from NAA and WAR. BAQ won the D.V.R.A. QSO contest during the past month, with HAZ running a close second. Third honors went to BWF. HKY has a nice sounding rig on 1.75-Mc. 'phone. DGE is now teaching at the High Bridge High School. W2HDV was a recent visitor at W3CCO. W3JAR is putting out an fb signal on 28-Mc. 'phone. JAG is a new call in Trenton. IOW has a new modulator unit for the rig, and sounds fb on 1.75-Mc. 'phone. HPE changed qth. IIN is heard regularly on 1.75-Mc. 'phone. HW has a new NC-200. CFS has a new 300-watt all-band transmitter. Until next month, 73.

Traffic: W3BZX 511 3BYR 267 (WLNV 107) HAZ 77 IDZ 76 OQ 73 DNU 65 ZI 62 AVJ 61 AQ 59 ASQ 45 AEJ 29 PXV 26 EWK 22 GMY 20 ATF 17 CCO 15 BEI 14 GCU-CFB-ACC 9 CWG 7 ABS-GHR 6 ITU 5 HPX 2.

WESTERN NEW YORK — Fred Chichester, W8PLA — With two hamfests out of the way, the Section is getting back to normal. W8NCM has been called to active duty in the U.S.N.R. and is stationed at Brooklyn. OQC, QMW, and SJZ are at the N.C.R. Radio School at Noroton, Conn. PTB is now on 7 Mc. from an Army camp in Georgia. UPH is still trying to work a K4 on 7 Mc. Charlie is a native of Puerto Rico. MOI and JAD are sporting new HRO's. NVK has donated a key, used by the late ABX, to the

R.A.R.A. It will be known as the John Long Trophy and will be given to the Rochester operator who first succeeds in working all states after April first. The winner will keep the key one year. CEX expects to be on 112 Mc. soon. DOD is moving to a new location in the spring. Following the lead of a Buffalo club, a Rochester C.W. Net is being formed. The main purpose will be to teach proper operating procedure, make the gang proficient in handling traffic, acquaint them with the QN signals, etc. FNT and DFN report into W.N.Y. Net occasionally to clear Rochester traffic. USF expects to apply for O.R.S. as soon as he gets a 3720-ke. crystal. MC is keeping a daily schedule with PLA to help out in Rochester. The Rochester Hamfest, Feb. 22nd, at the Sagamore Hotel, was one of the best it has been your S.C.M.'s pleasure to attend. RGA acted as toastmaster, and the principal speaker was "Clint" DeSoto from A.A.R.L. Headquarters. TUQ, pianist, and Foster Brooks (formerly of WHAS, now announcer at WHAM) furnished the entertainment. A fine dinner was served, and there were prizes for all; 164 were present in spite of inclement weather. DFN copped the trophy as winner of the R.A.R.A. QSO Party and EBR, of Dewitt, was awarded the prize given in the W.N.Y. QSO Party. SGX has a new 3-element beam for 28 Mc. RTX worked KB4HBX on 28 Mc. UHI has increased power to 500 watts and has applied for membership A.A.R.S. LQC is doing a bang-up good job as N.C.S. of the K.B.T. Net. PQC was called for selective service duty. KCA and UXL have new HT-6 rigs on all bands. UYV is on 1.75-Mc. 'phone and is building a portable rig. UDD is working hard to make his 809 "mehirpy." RNU is building a 14-Mc. rig with TW75's. LQC is engaged to NVO's sister. Congrats, Don. NNP needs a 2-h.p. gas motor for a kw. generator for F.D. RRL is back on 1.75 Mc. with 100 watts. He is also trying for Class A. OWE will soon join K.B.T. Net. UBR will soon be on 1.75 Mc. with high power. LFQ was married March 21st. VNT is active on 7 Mc. with 20 watts to 6L6G's. INK was also married in March. KYR has moved to 80 Dunlop Ave. BDO, the new E.C. for Niagara County, announces TPA is western and UAX southern outlet for that county network. PFK is trying for the Army Air Corps. OMD has a husky signal on 3.5 Mc. now. IIE is working in Iowa for a few weeks and will apply for O.R.S. when he returns. Your S.C.M. has just been appointed N.C. 3 in the W.N.Y. A.A.R.S. Net and assigned WLND as a call. PAL has been called for selective service duty. They will hold a hamfest on May 10th. This will be an all-day affair with dinner at 6:00 P.M., with entertainment thereafter. TJN is chairman in charge of the affair. K.B.T. Radio Club elected NVO to the office of treasurer in place of PQC, who was called for selective service duty. K.B.T. won a return bowling match from the Greater Buffalo 5-Meter Club. The club announces the following Field Day committees: General Chairman, NVJ; Power Supplies, NWH; Transmitters, LQC; Receivers, UJW; Operators, PCN; Transportation, NVO; Antennas, NNP. K.B.T. has started a swap column in their paper. "QRML." Buffalo Mike and Key Club held election of officers, March 7th. The following officers were elected: Pres., UOK; Vice-Pres., UHT; Secy., MEU; Treas., SSC; Directors, NEY, HJG, FYH, INK, IIO. K.B.T. held their regular meeting, Feb. 21st, in the Iroquois Room at the Hotel Statler. Guest speaker was Mr. Clinton DeSoto, of A.R.R.L. Hq., who spoke on A.R.R.L. activities. Dinner was held in the main dining room at 6:00 P.M. in honor of Mr. DeSoto, and at 10:30 the WIAW Code Proficiency Qualifying Run was put on. Capt. James Spriggs of the Army Signal Corps Reserve was guest speaker at K.B.T. meeting, March 14th. The club will have emergency test equipment demonstrated at meetings for the remainder of the season. The Western New York Radio Council will hold election of officers in April.

Traffic: W8AOR 43 BJO 181 CSE 25 CDM 5 DSS 57 EBR 41 FCG 247 JIW 492 IIE-KCA 4 LQC 63 MQX 28 NVO-MVB 10 NNP 31 PCN 443 PLA 286 QDP 13 QZP 21 RZX 16 RKM 277 SFD 133 SMI 114 SBV 71 SJV 23 UXT 41 UDD 45 UHI 51 UPJ 54 BHK 82 RVM 23 RME 36 AQE 105 2CDJ/8 108.

WESTERN PENNSYLVANIA — SCM, E. A. Krall, W8CKO — Asst. SCM in charge of ORS activities, W8KWA. Asst. SCM in charge of Emergency Coordinators, W8AVY. Chief RM, W8NCJ. We certainly can rely upon KWA and NCJ to keep the W. Pa. Net on its toes, and all credit for its success should go to them. CKO finds that one way to find traffic is to call for it every time he gets on the band. TWI is operator at WLMA State College. Pa. TTD needs four more states to make W.A.S. on 3.5 Mc. JSU is

a reliable man for O.R.S. work. SNA needs Iowa to net him WAS on 3.5 Mc. HKU says he enjoys net work very much. OKK is on his toes, as his monthly traffic report will testify. PER spends 90% of his time in traffic work, FB, OM, RNO has been rebuilding his rig, and expects to be on 'phone. We hope it does not interfere with his O.R.S. schedules. UWZ is a new O.R.S. and spends most of his time between O.R.S. and A.A.R.S. PX and KBJ are active in Trunk Line I, on 3.9-Mc. 'phone. WQ placed fourth in Y.L.R.L. party and made W.A.S. on 3.5 Mc. in exactly one month. He is an up-and-coming O.R.S. MJK can be counted upon for an excellent report. His activities are broad and varied. NCJ reports the O.R.S. Net going strong with plenty of traffic flowing. He now is running a pair of RK20A's with $\frac{1}{2}$ kw. to the final. Our traffic report reflects the good work he is doing. RIS recently acquired a new NC-200. BWP maintains four schedules per week on 28 Mc. if conditions permit. ROA is a new O.P.S. and O.B.S. at Altoona, Pa. How about a volunteer for a few O.R.S. up that way? We need them to maintain a steady flow of traffic. The Horse Shoe Radio Club of Altoona will soon be on the air with the call QZF. O.R.S. and O.P.S. are reminded to get their reports in by the 19th of the month so that they can be properly credited for traffic handled. Believe it or not, fellers, CUG your former S.C.M. and BSO are operating 'phone rigs these days. Hi! Cooperation with Red Cross and Weather Bureau is being taken care of in fine shape by the W. Pa. gang. So long.

Traffic: W8CKO 460 KWA 336 NCJ 321 MJK 258 WQ 145 TOJ 102 CMP 93 OKK 80 PX 83 JSU 65 PER 62 RBC-YA 36 UWZ 30 IOH 24 HKU 23 SNA 21 RNO 19 RAT 9 AXD 6 NDE-BWP 5 TTD 4 RIS 2.

NEW ENGLAND DIVISION

CONNECTICUT — SCM, Frederick Ells, Jr., W1CTI. WIAW and W1MGC make B.P.L. ITI is now taking part in the R.R. Net. CTI and BCG spent a pleasant Saturday afternoon visiting UE at the Naval Radio School in Noroton. BQL operated at KXB while home on leave from active duty in the Navy. DMLK is on 3520 kc. with a new transmitter. Stations active in the A.E. (1850 kc., 10 A.M. Sunday) are BPL, ABX, LJU, MEM, JQD, NCL and KAT. GYT is again active on 3640 kc. reporting into the Nutmeg and A.A.R.S. nets. NEM, station of the H.C.A.K.A. will get some code practice going on 1.75 Mc. soon. DGG spent three weeks in Florida. HYF worked W6JEB, Los Angeles, Calif., with 7 watts input on 3770 kc. ABEY is now located in Spartanburg, S. C. EFW reports the following N.C.R. members are on active duty: GVV, HVF, KAA, ADW, BQL and FKR. DWP has been appointed E.C. for New Milford and BIH is coordinator for Torrington. LQK is attending the Naval Radio School at Noroton. ILY is now signing portable 4 at Camp Blanding, Fla., and contacts his brother, BCG, on 7 Mc. CTC is now portable 1 at Camp Edwards and expects to report into the Nutmeg Net with traffic for the folks back home.

Traffic: W1AW 998 (WLMEK 21) MGC 872 ITD 197 ITI 134 CTI 103 JQD 89 KQY 72 BDI 26 UE 25 KAT 24 MEM 34 LOP 22 GYT 21 FMV 9 EAO 5 GB 3 GC 3 DGG 1 (Jan.-Feb. W1UE 96).

MAINE — SCM, H. W. Castner, W1IIE — Am very glad to be able to give you a report of the All Maine QSO Party. There were many stations taking part but, as usual, only a small percentage sent in their logs as they thought they would not be "in the money". The following winners are announced in the two divisions. Phone Division: (1st) W1GKJ with 71,955; (2nd) W1DID with 62,598; (3rd) W1KYT with 59,850. C.W. Division: (1st) W1GKJ with 71,955; (2nd) W1OR with 35,000; (3rd) W1GXV with 33,060. In the C.W. division W1OR would have been first but for the fact that it was a more-than-one-operator station. Great credit should be given the boys at W1YA for such a fine party and we all extend our real thanks to Pres. Bob Kelly and the members of the U. of M. Radio Society. The Fifteenth Biennial Science Exhibit at Bates College was most successful. IKE demonstrated amateur radio and handled a very large number of messages for the visitors. AUC is back from his Florida vacation and again active on the Sea Gull Net. A great deal of individual arranging has been made to contact the local boys at the various Southern training centers. LEV and LLQ have gone with the forces and left word with DTS that they would be on 14,292, 7188 and 7196, from Fort Blanding. Captain Carl Rounds, LOZ, is at school at Fort Benning. When he returns to Fort

(Continued on page 76)

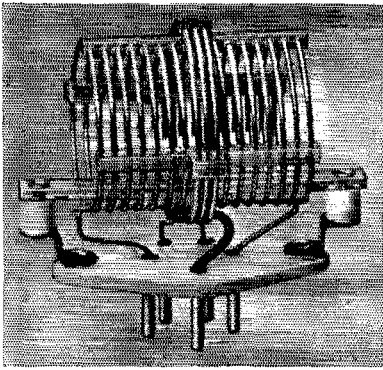

Amateur net
\$1.00 each

MORE EFFICIENCY IN LESS SPACE

B&W 75-WATT "JUNIORS" are designed to provide optimum performance in many types of 75-watt applications. Particularly suited for crowded layouts, portables and other limited-space rigs, "Juniors" are actually more rugged and efficient than most larger, more bulky coils of comparable rating. The economical answer to 75-watt inductor problems, B&W "Juniors" deliver the ultimate in efficiency in a minimum of space. Your jobber will be glad to show you — or write for details.

BARKER & WILLIAMSON

Radio Manufacturing Engineers • ARDMORE, PENNSYLVANIA

Variety . . .

There's much to be said for the adage "Variety is the Spice of Life" . . . and there's much to be said for the great variety of Racks, Panels, Chassis and Cabinets in the Par-Metal Line. Variety gives you greater latitude in selecting just the right units for the job you build — whether it's a receiver, a transmitter, an amplifier or a complete Sound System.

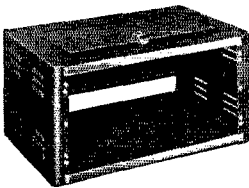

Chassis ★ Cabinets
Racks ★ Panels

in both Standard and Deluxe models are listed in the Par-Metal Catalog No. 40. More than 400 items — all accurately machined for easy assembly. They're modern, streamlined, handsomely finished and with chrome hardware for enduring beauty!

PAR-METAL PRODUCTS CORP.

3262 49th St., Long Island City, N. Y.
Export Dept: 100 Varick St., New York, N. Y.

An Improved Electron-Coupled Oscillator

(Continued from page 17)

The curves of Fig. 7 illustrate the frequency stability of this oscillator with respect to plate and anode-screen voltages. This stability is superior to that usually obtained with the conventional e.c. oscillator. An inspection of the plate voltage curve indicates that close regulation of the plate supply voltage is not particularly important. The cost of a regulator tube for this purpose is low enough to justify its use anyway, and with gas-tube regulation of both supply voltages, the frequency stability is then determined almost entirely by the design of the tank circuit and by the stray interelectrode and wiring capacitances.

According to the specifications of the type 6A8 converter used in this oscillator circuit, the signal-grid-to-plate capacitance of the tube is 0.03 μmfd . This is somewhat higher than the control-grid-to-plate capacitance of the 6J7, 6K7, 6SJ7, and 6SK7 types (0.005 μmfd). With the 3500 kc. oscillator mentioned above, however, a frequency variation of about one cycle per megacycle was noted as the plate circuit was tuned through the fundamental frequency, indicating a high degree of plate circuit isolation. No frequency shift was detected as the plate circuit was tuned through the second harmonic frequency. The use of an impedance-coupled buffer or doubler is nevertheless a worthwhile precaution, particularly at the higher frequencies.

In closing, it is worth noting that the rotor of condenser *C*, Fig. 2, is at a d.c. potential of 100 volts. The use of parallel feed to allow grounding this rotor for d.c. is not generally advisable, since the r.f. choke necessarily shunting the frequency-determining tank circuit would probably have a detrimental effect on the frequency stability, particularly at the resonant and anti-resonant frequencies of the choke. Simply grounding the rotor is likewise not to be recommended, since the bypass condenser *C*₁ (Fig. 2) would then be in a position to adversely affect the stability, particularly at the higher frequencies.

Strays

According to the dentists attending the Health Defense Exposition in Los Angeles, CQ means "Chewing Quotient," a figure which is determined by the effectiveness with which one can chew raw carrot cubes in a given length of time. How about chewing the rag? — *W6EH*.

W4GOP wants it distinctly understood that he is a confirmed Democrat. He swears that some plotting Republican issued the call letters to him just for spite. — *W4RS*.

Spots of red paint on dangerous high-voltage points will make the operator think twice before touching them. — *John D. Robb*.

DEPENDABLE

ACCURATE

ACTIVE

PRECISION
MADE

BLILEY

B5

CRYSTAL

UNIT *for*

40 METERS

ASK YOUR BLILEY DISTRIBUTOR FOR A COPY OF CIRCULAR A-8



wire wound
**PRECISION
RESISTORS**

Super DAVOHM

Recommended for use in exacting equipment where accuracy, stability and dependability over long periods of time are of prime importance.

Accuracies from $\pm 1\%$
to $\pm 0.1\%$ available

PRICES AND LITERATURE UPON REQUEST

THE DAVEN COMPANY

158 SUMMIT STREET • NEWARK, N. J.



Do You Have a Low Number?

Well it's not too late to train the Candler Way in your own home. The Candler System for over a quarter of a century has taught radio code by the easy, practical method. The U. S. Navy will need many thousands of expert radio operators. You can easily qualify with the Candler System for this and other increased pay positions. Now is the time to train for the Army, Navy or Commercial Communications field, the Candler System can train you easily and quickly — you owe it to yourself to find out how today!

It's FREE — drop a postcard today, for Candler Free book of **FACTS**. Gives you all the inside tips. This may be your opportunity — Do It Now!



**CANDLER
SYSTEM CO.**

DEPT. Q-5
ASHEVILLE, N. C., U. S. A.



(Continued from page 73)

Blinding he expects to have his rig on 28 Mc. with about 25 watts and will probably contact LSK. There are eight of the Lewiston area boys in the Service. By the time you read this there will probably be some of you having schedules with the boys in the South. We hope you will contact various nets and outlets in order that relatives and friends may communicate with their boys in the Service. MGP is working in Malden, Mass. LMM is on 7103 kc. LWO has moved to new QTH. DTS is adding power. GXY has ordered a fine emergency power supply consisting of a motor-driven generator. HSD has a new Harvey transmitter. AIS was in the "Party" on c.w. and made a few contacts. LML is very busy with work, but he does attend to his traffic schedules. The A.A.R.S. boys had another of those fine meetings at the home of KOU on March 23rd. LIP, who is at Quoddy, writes that the location of the quarters for the amateur radio station has been changed twice but they hope to be settled soon and be on the air with quite a number of schedules. He has rebuilt his own rig with three times as much power and is anxious to get on again. BNG and GXY continue their schedules at 6.30 p.m. for the benefit of the Bath boys in the service. MPK is on 56 Mc. looking for contacts. RU in South Thomaston is also searching the 56-Mc. band frequently. MID has been very active on 3.5-Mc. c.w. lately. IBR took his first whack at N.C.S. and did a swell job. INW is now a resident of West Boothbay Harbor, Me., and on the air from home. BOR has been on 3.5-Mc. c.w. some of late. Your S.C.M. is very thankful for so many traffic reports this month. Don't forget to include any news you have with these each month. While we are on the subject, let me say that traffic reporting cards can be addressed and sent me for a cent. There is no need of putting them in an envelope with three cent postage. I hope many of the gang had a chance to read "It Seems To Us" in March QST. That advice will not hurt any of us. Quite a lot of the boys are joining the Rag Chewers Club; March QST tells how to do it. I hope every amateur operator will remember what it means to the boys in the Service to contact home and friends and I urge you to offer this public service to your citizens wherever you live. A story on this is also in March QST. New O.P.S.: W1AI, LNL.

Traffic: W1IIE 147 LYK 7 VF 7 IKE 157 GKJ 9 GXY 38 LKA 6 LNI 9 AUC 2 A1 5 LKP 58 BAV 233 KTT 10 MFK 3 BNG 14 KYT 7 GMD 23 LOA 34 LML 122 BTY 33 CMO 13. A.A.R.S.: W1AMR 86 CPO 64 EFR 44 FAP 130 GE 16 GHT 12 GVS 107 IJF 70 KOU 166 KTN 49.

EASTERN MASSACHUSETTS — SCM, Frank L. Baker, Jr., W1ALP. Please note, gang, my new address is now 91 Atlantic St., North Quincy, Mass. In mailing letters please note that I am in the Boston Postal District. Interest in the Emergency Corps is still high. We have new Emergency Coordinators for the following cities and towns: BHW, Chelsea; IXL, Walpole; MQO, Somerville; WI, Lexington; LMO, Wintthrop; ARE, Bedford; LXL, Suffolk County; AWA, North Reading; ATQ, Malden; MDN, Amesbury; LFF, Lowell; KRR, Mansfield; LSA, No. Attleboro; AAL, Attleboro; EKT, Wakefield; LTG, Middleboro; AR, Belmont. NFW is a new ham on 1.75 Mc. in Somerville. Welcome, Howard. KH is now on 112 Mc. portable-mobile. HIL is active on 1.75- and 3.9-Mc. 'phone and 3.5-Mc. c.w. The Parkway Radio Club held its annual banquet. W4ARP/1 is now NGL in Braintree. Fb, Harry. MSK takes traffic for his vicinity from W1LDR/5. JWC will be back on 28 Mc. MYO has a new 28-Mc. beam. MSS is going to have new frequency meter. MME keeps schedules with several hams on 28 Mc. KQN says 14-Mc. 'phone is improving some at night. Glad to hear that JNU is home from the hospital and pounding brass on 7 Mc. again. JGQ is fixing up speech equipment. JFS, HWE and TY have new receivers. MVQ is a new ham on 28 Mc. JNK has a new 4-element beam on 28 Mc. KMT, MSY and MBV are now at Naval Reserve Radio School at Noroton, Conn. Good luck to you, fellers. WI says all his regular traffic gang must be in the Army or sumthin. KDC had Boston-No. Shore Fest. NBI has a new 28-Mc. antenna. MGQ has a new e.c.o. BDM is going on 3.5-Mc. 'phone and has a new beam on 28 Mc. MQO still schedules 1LDR/5. LCV in Cambridge is on 28 Mc. WV has a new e.c.o. per July QST, and is on 4 bands c.w. and 'phone. EHT lined up schedules for the A.R.R.L. Red Cross Test. GAG has a new 600-watt 'phone and is also active on 7-Mc. c.w. EHT is now E.C. for Middlesex County. FKS made himself Sec'y for the No. Cambridge DX hounds. He is getting over a serious operation. Hope you're fb now. OM, KID has a 500-watt c.w. rig. GNE has

100 watts on 14 Mc. IQY is on 14-Mc. c.w. and 'phone. IQW-KOP has a new 500-watt rig. MON has a pair of HK24's on 112 Mc. NBT is moving to Roxbury. NFX is a new Army recruit. HA will be on 112 and 14 Mc. soon. AAR is working on a mobile rig for 112 Mc. Also had meeting of A.A.R.S. 'phone nets at his QTH. IYU is new E.C. for Braintree. The following applied for O.P.S.: HDJ, LQQ, MSK, JRN, HOB, MZF. AAR is new O.P.S. on 112 and 1.75 Mc. MJY is new O.R.S. JSM is new Route Manager for 3.5 Mc. c.w. AUU is a new ham in Braintree. JKR has a new rig on the air. LYG, JOW and HRE have gone to camp. Good luck, fellers, and let's hear from you.

Traffic: W1AKS 265 BDU 181 EVJ 48 AAL 45 HWE 41 AGX 28 MZE 27 LVD 26 BXC 25 KH 13 EHT 17 HIL 15 WI 13 MQO 10 KTE 9 LQQ 8 MME 4 WV 3 MKN 6 HUV 1 ALP 8 MDU 12 AAR 171 LSA 66 HA 37 EMG 35 LWH 466 JSM 350 FSL 186 KXU 168 KCT 140 JCK 114 (WLGV 43) LYG 63 FWQ 55 (Jan.-Feb. W1WI 15) 2 1/2-meter A.A.R.S. Net: AAR 28 BHL 18 EYR 73 LWI 57 MBS 55 MIF 21 MMY 11 MON 133 MQH 40 NBT 22 NFX 12 QD 93. 160-Meter A.A.R.S. Net: JFS 48 LVZ 27 KMQ 22 AHP 88 KRR 2 DKS 33 FVL 16 MEZ 32 LVD 33 MOJ 33 KYN 14 CCL 26 HIL 17 AAL 20 MNW 46 LGH 17 IYU 84. 80-Meter C.W. A.A.R.S.: MTQ 70 MAN 11 LPX 9 FGT 28 FRO 39 EPE 233 QA 78.

WESTERN MASSACHUSETTS — SCM, William J. Barrett, W1JAH. Our list of traffic reports this month is the longest in many a moon, thanks to the kindness of IOR, R.M. and Central Mass. A.A.R.S. Radio Aide, in sending me a traffic list for his A.A.R.S. net. Judging from the fact that our traffic list this month comprises a membership list of A.A.R.S. in the WMS and CMS nets, it is apparent that our active O.R.S. are also active A.A.R.S. Arrangements are being made to incorporate the CMS reports monthly. News seems to be scarce this month. BIV ran up top score for the month, and is wishing for spring to come around so he can erect a mast at the new QTH. FOI is handling plenty of traffic as N.C.S. of the WMS 'phone net and liaison to the WMS 3.5-Mc. A.A.R.S. net. Hank is that rarity, a 'phone man who takes 35 w.p.m. with the greatest of ease. AZW is new S.N.C.S. for WMS A.A.R.S., succeeding BKG, who resigned due to pressure of work. MIM reports for first time since appointment as O.R.S. She says NDR is new op at LXT, Fitchburg Recreation Radio Club, which recently affiliated with A.A.R.L. LUA is moving to Great Barrington. BVR is now WLG. KZU reports LRE and LRA on 56 Mc. JAH overhauled frequency standard. IJL is serving a year with the Army. HNE is recovering from operation at Mass. Gen. Hospital. AJ has been having crystal trouble. Ralph has a new NC-200 and is awaiting a warm day to erect a 3.5-Mc. antenna.

Traffic: W1BIV 247 (WLGN 71) IOR 221 FOI 218 ELT 144 AZW 116 (WGLD 13) JAH 107 (WLGH 17) IHI 93 JXE 89 JFK 85 MIM 79 LWA 72 DCH 36 NVF 33 BXF 30 LJF 22 EAX 22 LLN 20 MND 20 KZS 18 BVR 17 (WLG 115) AJ 17 MJT 10 IZW 10 DXY 9 KTK 9 JLM 4 FQD 3.

NEW HAMPSHIRE — SCM, Dorothy W. Evans, W1FTJ — Our New Hampshire QSO Party of February 8th and 9th went over 100%. It did our hearts good to hear so many N. H. stations join in and to hear a lot of the old calls that haven't been on for some time. It was a sort of "Old Home Day" for us New Hampshireites! The results were in some ways surprising, but in all ways pleasing. Reports were received from 37 New Hampshire stations and 28 outside stations. According to the logs submitted, 75 New Hampshire stations participated in the Party, and 186 from outside, making a total of 261 participating stations. It is planned to make this an annual affair and we hope that when another year rolls around that even more will participate. Scores were as follows:

Phone Only	C. W. Only
HJI.....	JDP.....
AXL.....	GEY.....
IDY.....	KL.V.....
HQS.....	MUW.....
EAW.....	HFO.....
CNX.....	FGO.....
IUI.....	MMG.....
AUY.....	KIN.....
ITF.....	MXL.....
GGK.....	TA.....
GMH.....	DUB.....
LCD.....	MJO.....
1504	1856
1463	1589
1416	1400
1398	1316
637	1281
570	1158
564	1022
488	906
486	852
444	828
300	780
240	612

AQO.....	604	1KJO.....	486
*MOF.....	552	1BGZ.....	483
LIN.....	540	1CBW.....	462
*IP.....	462	1LEF.....	441
MLW.....	410	1MEJ.....	420
JKH.....	370	1BIG.....	378
MOI.....	252	2N1Y.....	375
		1LJZ.....	288
Phone/C.W.		1LYJ.....	180
*BFT.....	2168	1BTY.....	168
ABF.....	2080	1HZD.....	165
*FTJ.....	1928	1EFN.....	99
*APK.....	1302	1ALP.....	81
IVU.....	1169	1HNE.....	72
KMH.....	1078	1HA.....	45
		1NAS.....	45
Outside Stations		3DRO.....	24
W1GKJ.....	672	1LKP.....	12
2GFW.....	594	3AOC.....	6
1KYT.....	546	2MIY.....	3
1KQY.....	522	2LXI.....	3
1DLC.....	486	SEBR.....	3

* Committee Members ineligible for prizes.

AQO is rebuilding. JDP says the Forest Service has been keeping him QRL lately. LVG is now located at Scott Field, Illinois, where he is attending Air Corps Technical School. He is instructor for the new fellows and is himself in the 23 to 33 w.p.m. code class. LSN is looking forward to summer DX on 56 Mc. He advises that AP on Mt. Washington has a fine signal covering all of N. H. and most of Massachusetts on that band. LIN has a new sky hook. KLV is keeping daily schedules with Mt. Washington on 56 Mc., using an HTC transmitter. Nashua Mike and Key Club had a booth at the recent Nashua Progress Exposition and handled plenty of traffic. Nice work, fellows! GFC and EDN are new members of the A.A.R.S. KKL is sporting a new Super Defiant receiver. CNX has been down in the 3.5-Mc. c.w. band. MOF/BFA has moved to a new QTH and, when a new antenna is up, will be back on the air to resume his usual schedules.

Traffic: W1KIN 324 MOF 163 JDP 115 FFL 95 GMM 78 JKH 58 IDY 57 IP 53 MMG 47 BFT 37 FTJ 32 MLO 31 FHO 23 KLV 3 LSN 2.

RHODE ISLAND — SCM, Clayton C. Gordon, WIHRC — The Westerly Radio Club held Open House at the club rooms on March 5 with a large representation from Providence, New London, Norwich and Hartford. Mr. Budlong of A.R.R.L. Hq. was the principal speaker and endorsed the writer's sentiments that more fellows ought to get into some sort of a traffic net to increase their ability and knowledge, thereby making themselves more useful to their community and Country in the event of an emergency. JEZ worked on the boys for more and better emergency powered rigs and brought along a sample power supply. DET talked about "Queer People" and explained some of the things that are being done with electricity to help these people in Institutions where their cases are being treated. The evening wound up with some mighty fine eats and drinks. BOS has been designated as control station for the local 1.75-Mc. 'phone net which functions every Sunday at 10 a.m. NBU of No. Providence is now operating 1.75, 3.5 and 112 Mc. NDQ is another new station in Providence. Rhode Island has a new Monday night round table on 112 Mc., known as the "Four Minute Club." It starts at 8:30 p.m. with each transmission limited to 4 minutes. The N.A.A.R.O. report that the entire club membership now possess code proficiency certificates. MO, MQF, MJL, LDL, KOG, and LWA all had a swell time down at MDW's while visiting with Dottie, W2MIY. MJL has moved to North Kingston. MQF is active on 1.75-Mc. 'phone and a member of the Blackstone Valley net on 1850 kc. LWA reports that MWK from Jamestown is on 3.5 Mc. and is practicing A.A.R.S. procedure before formally joining up. NES is new ham down in East Greenwich and is the son of MDW. JNO is home week-ends now and is planning to resume activities as our Official Phone Station down there. EOF took his turn on the P.R.A. Net from INM. LYE dropped his HK24 on the floor and was off 112 Mc. for a spell, but got another one and says it's working much better than the first one did. JP built up a new speech and driver to use with the "hard luck" crystal mike. NCD is in the Army at Newport; he gets on week-ends and is using 6L6-809 rig and SX28 receiver. MUH has acquired a 6L6-809 transmitter for 3.5 and 7 Mc. He is changing the

6L6 to a Hytron 6L6GX and shielding it. He also put in an 83 with hash filter in place of the 5Z3. LUS is active on 3.5-Mc. c.w. and working on his e.c.o. DDDY is rejuvenating and increasing his emergency equipment. This next makes me sore. MEK says "Busy working Cal. and Nevada in A.R.R.L. parties on 80 and built a new keying oscillator." Wonder how many years it will be before I get that last state (Nevada)? The P.R.A. nominated CPV for S.C.M. to succeed me as my term runs out April 15th, but although CPV said he was very pleased to have the gang think so well of him, what with his State Guard, A.A.R.S. and other activities, he didn't feel up to accepting the honor and has declined. Whoa is me. 73.

Traffic: W1LWA 227 KKE 59 HRC 32 NBU 20 LBY 12 EOF 10.

VERMONT — SCM, Clifton G. Parker, W1KJG — W1MMV contacted five "hard-to-get" states in a row to complete his W.A.S. on 1.75 Mc. KUY, NDL and MJU are experimenting on 112 Mc. and trying to find the band. MJU has acquired a new e.c.o. unit. We are glad to welcome to the Vermont Section GXI, formerly of Maine, who is now located at Barre. AD has an 8:15 a.m. schedule with 2NAA which may help on traffic. CBW is temporarily off the air while moving, has his new rig completed and is now O.R.S. and O.P.S. IQG visited JRU, KUY and MLJ visited JRU, KJG and MCQ recently. HLH is busy on 28-Mc. 'phone. LWN is now operating on 7 Mc. LVP gave a lecture and demonstration on superhets at the April meeting of the Burlington Amateur Radio Club. GAN is moving to Burlington. NDB is having great luck on his W.A.S. list and is now O.R.S. FPS reported that a fine new daughter had arrived at his QTH recently. Congratulations! MEG is a welcome addition to our Section, coming here from Massachusetts; he is located at St. Johnsbury, Vt., and is using 3604 and 7140 kc. at present. JVS reports fine luck on 14-Mc. 'phone. MJU is on the air occasionally from MMV. MMU is now working on a band-switcher and a new final. LWN, GAE and KDB are also reported to be in various stages of construction and reconstruction with hopes of returning to the air soon. KOO is now in Florida with the Vt. National Guard. Paul has a portable outfit with him and is looking for Vermont contacts to handle traffic for the boys. ND has completed a new modulator and mike installation. MCQ has finally eliminated the bugs in his 500-watt 'phone unit and is now on the air with excellent results. KJG is still tied up at Montpelier with prospects of returning home by mid-April.

Traffic: W1JVT 28 KJG 14 AD 33 NDB 10 CBW 63.

HUDSON DIVISION

EASTERN NEW YORK — SCM, Robert E. Haight, W2LU — KWG is back on the job keeping West Point well covered. LSD reports the F.T.S. 2nd Anniversary Party sure kept the boys QRL with traffic. LSD is handling traffic for the Army and Navy boys. LU is QRL as Commander Section 2 N.C.R. JRG is operating on 7000 to 7250, 2018 and 112,500 kc. SZ is spending a great deal of time on 3.9-Mc. 'phone. MEC reports a nice record. In three hours he worked Florida, Kansas, Calif., Oregon, Alaska and Hawaii on 14-Mc. 'phone. NIY is ex-Commander of Unit 2, N.C.R., and new Commander Unit 1. Congrats, Andy. MHW is doing nice work on T.L.G. LLU is happy while grinding crystals. JRG is using a new e.c.o. on 7 Mc. and installed a c.w. keying monitor. NJF is on 28- and 1.75-Mc. 'phone with a 350-watt rig. ELD of Mt. Vernon is back on 7 Mc. after a long layoff. KSV is heard on 112 Mc. VJ is pounding out with a new bug. HNH is cruising around Virgin Islands on the U.S.S. *Oml*, and visited K4ERA. The Port Jervis news as reported by MHV: NQW is a new ham in town on 3.5 and 7 Mc. LOR moved to the eighth district and is now 8VLX. MUB has a 60-watt rig in the making, applies for O.R.S. and joins A.E.C. KXF and MHV drew a 203A as prize at annual banquet. NQW won a 3506-ke. crystal. JW K is at the N.C.R. Radio School, Noroton, Conn. JWK was honored by a send-off visit from MHV, NQW, and NFZ. The Orange County Radio Assn. of Middletown is now active. Meetings are held every Wednesday p.m. at W2GFT's shack. ACB is preparing for Field Day and rallying the A.E.C. boys for emergency work in line with the defense program of the local American Legion. MUB, club station of the Delaware Valley Brass Pounders Assn., has been appointed O.R.S. MVE and NQW joined the A.E.C. All O.R.S., O.P.S.,

(Continued on page 80)

Bob Henry
W9ARA

INVITES YOUR INQUIRIES!

YOU need assistance in getting the right receiver for your use and I can help you. I can make it to your advantage to buy from me. Here are five good reasons why it will pay you to write me before you buy.

YOU GET specialized personal attention of genuine value that you can't expect to get from other jobbers.

YOU GET prompt shipment from the world's largest stock of all makes and models of amateur communications receivers.

YOU GET easy 6% terms which I finance myself so you have less cost — no red tape — quicker delivery. Write me for terms.

YOU GET best trade-in for your receiver. Describe it and I will tell you its trade-in value. Pay the balance on my 6% terms.

YOU GET ten-day free trial. You don't buy unless you are satisfied.

So write me and I will help you get the best receiver and will cooperate with you to see that you are 100% satisfied. Your inquiries invited.

HENRY RADIO SHOP

**BUTLER
MISSOURI**



F. H. Ritzke
Pres. CREI

• Here's How You Can Qualify for a BETTER RADIO JOB!

**CREI Technical Training Is Preparing Others for
Good-Paying Radio Jobs — WHY NOT YOU?**

Are you "pinned down" into a routine radio job? Are you plodding along while others are advancing to important engineering jobs? It is the lack of technical training that is the stumbling block that keeps the average radioman from getting a better job or even holding his present job. YOU CAN do something about it — if you will!

Your own radio experience backed by advanced technical training will equip you to share in the good-paying jobs that await trained men. CREI courses in Practical Radio and Television Engineering are prepared for experienced radiomen who realize not only the value — but also the necessity of training now if they are to rise above the routine jobs to make good in the important engineering jobs where trained men are well-paid and always in demand.

Write for Facts Today!

Our free booklet and personal recommendations may hold the answer to your future success. In your inquiry, please state briefly your background, education, present position — and whether you are interested in Home Study or Residence training.



Capitol Radio Engineering Institute
Dept. Q-5, 3224 16th St. N. W., Washington, D. C.

WWV Schedules

IMMEDIATELY after the standard frequency station WWV of the National Bureau of Standards was destroyed by fire November 6th last, a temporary transmitter was established in another building and partial service was begun. The service has now been extended, although still with temporary equipment. It is on the air continuously at all times day and night, and carries the standard musical pitch and other features. The radio frequency is, as before, 5 megacycles per second.

The standard musical pitch carried by the broadcast is the frequency 440 cycles per second, corresponding to *A* above middle *C*. In addition there is a pulse every second, heard as a faint tick each second when listening to the 440 cycles. The pulse lasts 0.005 second, and provides an accurate time interval for purposes of physical measurements.

The 440-cycle tone is interrupted every five minutes for one minute in order to give the station announcement and to provide an interval for the checking of radio measurements based on the standard radio frequency. The announcement is the call letters (WWV) in telegraphic code.

The accuracy of the 5-megacycle frequency, and of the 440-cycle standard pitch as transmitted, is better than a part in 10,000,000. The time interval marked by the pulse every second is accurate to 0.000,01 second. The 1-minute, 4-minute, and 5-minute intervals marked by the beginning and ending of the announcement periods are accurate to a part in 10,000,000. The beginnings of the announcement periods are so synchronized with the basic time service of the U. S. Naval Observatory that they mark accurately the hour and the successive 5-minute periods; this adjustment does not have the extreme accuracy of the time intervals, but is within a small fraction of a second.

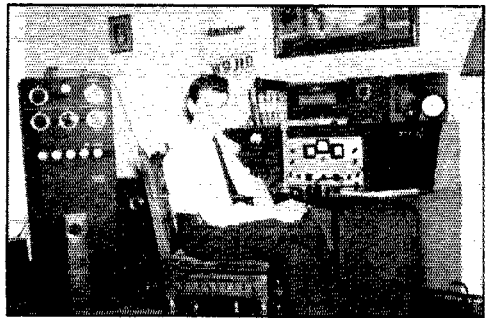

W9JID, Chicago, Ill.

Operator — William Guimont, airlines operator. Transmitter — Collins 250-watt, revamped for use with e.c.o., break-in and push-to-talk. Receiver — HQ120 and Peak preselector. W9JID works c.w. and 'phone impartially and handles traffic, chews the rag, works DX or whatever comes along. He has made the BPL over 20 times, did emergency work in two floods and an earthquake, is O.R.S. and S.N.C. in the A.A.R.S. Contests are one of his diversions. From early reports, he is apparently the first and thus far the only operator to work all states in the 1.75-Mc. WAS Contest.

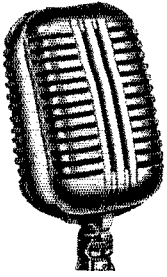

Model
WR-20

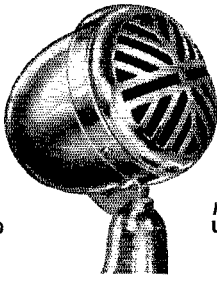

Model
UT-48

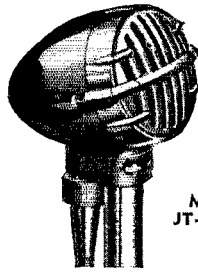

Model
JT-31-TT

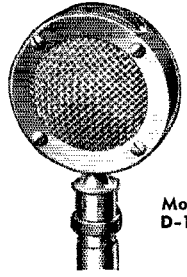

Model
D-104

A QUARTET OF HIGH CLASS PERFORMERS

YES, that's right . . . high class performers . . . applauded wherever they appear . . . popular for their efficiency and good looks. The veteran amateur in the seclusion of his "shack," the sound technician with his public address equipment, professional artists appearing before the public, and home enthusiasts making their own recordings . . . these, and many others . . . know and praise the dependability and efficiency of Astatic Crystal Microphones. Unexcelled performance and proven practicability make Astatic Microphones favorites with amateurs, service men, dealers and manufacturers alike. Astatic Microphones are available in many models with frequency response characteristics to meet every demand. You'll enjoy their performance. Try one out. Judge for yourself.

See your Radio Parts Jobber or write for Catalog

ASTATIC MICROPHONE
 IN CANADA: CANADIAN ASTATIC Ltd., TORONTO, ONT.
 YOUNGSTOWN OHIO
Laboratory Inc.

SHURE UNIDYNE CARDIOID DYNAMIC

Solves Sound Pickup Problems

Reduces reverberation, background noise pickup. Gives studio performance on remotes. Stops feedback, permits more volume in P.A. Cuts down room noise pickup and echoes in police, amateur and commercial phone. Employs exclusive Shure Uniphase principle (Shure Patents Allowed). Extra sturdy and rugged. High or low impedance models. List prices \$42.50, \$45.00 and \$60.00.



Write for Catalog 153Q

SHURE **MICROPHONES & ACOUSTIC DEVICES**
 SHURE BROTHERS
 225 W. HURON ST. CHICAGO, U.S.A.
 CABLE ADDRESS: SHUREMICRO

HIGH- OHMAGE *Controls*

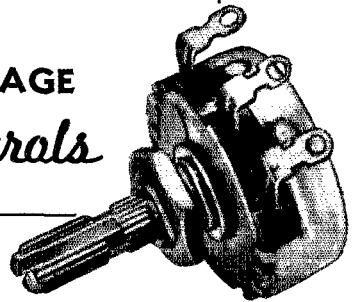

★ For that receiver — or for any other application calling for high ohmage adjustable resistance, just count on a Clarostat composition-element control. Remember, here's 20 years of specialization boiled down to the finest control available today. And there's just what you need — 1000 ohms to 5 megohms; choice of tapers and taps; choice of shafts. A trial will convince you!

Order from your local Clarostat jobber. Ask for latest catalog. Or write direct to Clarostat Mfg. Co., Inc., 285-7 N. 6th St., Brooklyn, N. Y.

CLAROSTAT
 TRADE MARK
 REG. U.S. PAT. OFF.
CONTROLS
RESISTORS

APPROVED by the AIRLINES



... that's why you can depend on PINCOR Dynamotors! All types and sizes available. Submit your requirements.

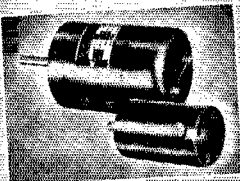

PINCOR D. C. Motors will meet your needs. Specify them for band switching and other power supply uses.

POWER SUPPLY by PINCOR



PIONEER GEN-E-MOTOR
CHICAGO, ILLINOIS

Export Address: 25 Warren Street, N. Y., N. Y.
Cable: SIMONTRICE, New York

SICKLES COILS

ALL TYPES OF RF AND IF WINDINGS

Manufactured by

F. W. SICKLES COMPANY

P. O. Box 920

Springfield, Mass.

RADIO TECHNOLOGY



RCA Institutes offer an intensive course of high standard embracing all phases of Radio and Television. Practical training with modern equipment at New York and Chicago Schools. Also specialized courses in Aviation Communications, Radio Servicing and Commercial Operating.

Illustrated Catalog on request.

RCA INSTITUTES, INC. Dept. ST-41

A Radio Corporation of America Service

75 Varick St., New York

1154 Merchandise Mart, Chicago

LEARN CODE THE WAY YOU'LL USE IT — BY HEARING IT

Type S - \$17.50

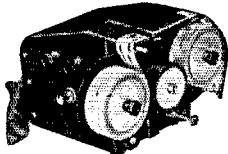

Sends from 4 to 60 words per minute. Higher speeds if desired. Complete with 10 rolls of double-perforated lesson tape of carefully selected and arranged matter for speediest results in learning code. Most compact and practical code teacher on market.

Type J - \$12.50

Sends 6 to 65 words per minute. Built-in tape perforator. Cut your own practice and message tapes. Complete with one roll of practice tape covering Alphabet, Numerals, Words to five letters; and 5 rolls of blank tape.

If your dealer can't supply you, write us

GARDINER-LEVERING CO. Haddon Heights
New Jersey, U. S. A.

(Continued from page 77)

R.M.'s and officials of E.N.Y. are urged to report monthly to the S.C.M., in order that their appointment can be maintained in a valid status. Reports must be sent to the S.C.M. on the 16th of each month.

Traffic: W2KVG 142 LSD 118 LU 56 JRG 25 SZ 16 MEC 6 NIY-MHW 7 LLU 1.

NEW YORK CITY AND LONG ISLAND — SCM, Ed. L. Baunach, W2AZV — Reports are getting bigger and bigger every month. This is as it should be. BGV and NLQ are now O.R.S., and MSS is O.P.S. LOS is out for O.R.S. appointment. ADW is moving to East Quogue. IYX is now operating on 3.9-Mc. 'phone with emergency-powered rig. UK is now on 3.9 Mc. 'phone with a pair of 204A's. 1XZ has 40 watts input to his p.p. 48's. MNF's xyl complained about so many antennas that he had to take them all down but one. INF only manages to keep his A.A.R.S. schedules. EXR operates after 10:30 r.m. every night. It took FAQ twenty-one days to get the bugs out of his new Utah 80 kit. E.C. BGO has appointed BGV 3.5-Mc. Asst. E.C. More of the gang in Bronx are wanted so get in touch with BGO. MRL is now a member of the A.A.R.S. NAZ and MSC attended a dinner of the Blackland Blue Net at AD's restaurant. JZX is now WLNN in the A.A.R.S. DBQ is seeking active station for the A.A.R.S. 7-Mc. Net. BWC makes the B.P.L. on deliveries for the first time. LPJ had all members of the QRA Club copy the WIAW Code Proficiency Run. BO has eight schedules and operated every day. BCS is looking for traffic on 28 Mc. GDF is active again on 3710 kc. KTA is studying for his Class A ticket. JAU finally got his e.c.o. working. MHD is going after more traffic. EYS and NDQ operate in the F.T.S. EC takes Section traffic for the west on A.P. Net. The 1941 officers of the K.A.R.A. are: FNV, Pres.; JSY, Vice-Pres.; IYL, Secy.; JOF, Treas.; CK, Sergeant at Arms. After several years of rebuilding, PK finally got on 28 Mc. IBU is rebuilding his T55's in an enclosed rack for 28 Mc. GIJ will soon be sailing on the bounding main for the Navy. CK has become the local service man for ailing 112-Mc. transmitters and receivers, having rebuilt several commercial and homemade jobs. KZN has become the frequency standard station for the K.A.R.A., and the club is going to purchase additional equipment to help him in his work. JVE has joined the stations on 112 Mc. in the Bay Ridge Section. The K.A.R.A. is looking for more members in Brooklyn, especially those in Bay Ridge and nearby sections. All interested should get in touch with W2IVL, the secretary, or any of the officers. January 16th to February 15th report: DW, W2MRV and NDQ are now O.R.S. JZX is again O.P.S. and O.B.S. on 3.9 Mc. CTN is assistant E.C. for the Babylon area. DOG is Assistant E.C. for the North Fork Chapter of the Red Cross, and IYX is Assistant E.C. for the North Suffolk Chapter. More Assistant E.C.'s are wanted in the Section. Anyone interested should get in touch with AZV. DW is now operating on Trunk Line L. MT recommends LNY for O.R.S. appointment. MYI is working for O.R.S. CKQ is now operating on the S.S. *Comol Cuba*, HPJD. LYC is building a portable 56-Mc. emergency rig with five watts output. LJU is working on his frequency meter and 'phone monitor, field strength meter and oscilloscope. EXR went to town using his new e.c.o. HAE and HSP have erected half-wave 1.75-Mc. antennas with fb results. KTA is getting out to all districts on 2046 kc. Both LJU and LR report fb results with e.c.o. BIV is busy tracking down power leak QRM. VG is experimenting with line filters and wave traps to eliminate 'phone QRM. HXT boasts of a six-year schedule with W5ELC. KDC is working for Westinghouse in Bloomfield, N. J. MNF is looking for Arizona, Wyoming and Oregon for W.A.S. NLQ is now located at Bay Shore. IRC moved to Flanders. LWZ is trying to sell his Utah jr. and Howard preselector. LUT worked KB6VV on 7150 kc. HGO schedules 6HGO once a week, and they are going to work HGO's in all districts. MIL purchased a new X-E.C. unit. IYX and QF are looking for more stations to join the Sunday morning New England 28-Mc. round table which operates between 9 and 11 a.m. Stations are wanted from New Hampshire, Vermont and Rhode Island. Since LZR is working nights, all schedules have been cancelled. MFR will soon be sailing with the U.S.C.G. PF is on regularly week-ends from Brooklyn. 3MA/2 has been ordered to radio school at Fort Monroe, Va.

(Continued on page 84)

It's HARRISON for NATIONAL!

Prompt Delivery
of all models —

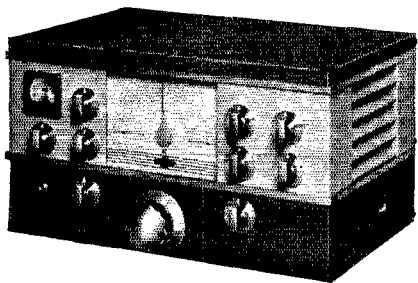

Free 10-Day Trial
to convince yourself how
good these new receivers
are —

**Highest Trade-In
Allowances —**

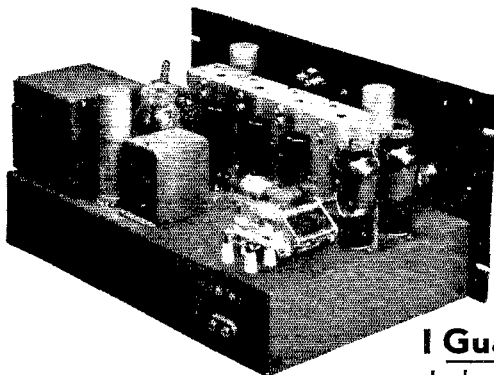

Easiest Terms
10% down —

**A 100%
Square Deal —**

**My Personal
Cooperation**
to see that you are
entirely satisfied —



I Guarantee You
the best deal!
Order your new
receiver, or parts — to-day —
from me! —

73,
Bill Harrison,
W2AVA

P.S. Send for my list of new and reconditioned sets

HARRISON RADIO CO.

12 WEST BROADWAY • NEW YORK CITY

WOrth 2-6276

HAMS!

This is YOUR Book!

Here is the *human* story of short wave radio — a "log book" of the adventures of amateurs throughout the world! Clinton B. DeSoto, staff writer for QST, tells the experiences on the air lanes of many operators you know, and stories you never heard. He tells how one ham provided communication for a beleaguered Chinese province; how "the greatest sporting event in scientific history" was carried off; how radio tracked down murder in the North-west Angle and saved an airliner in Colorado, and dozens of other true stories of heroism and high adventure. This is *your* book. Send coupon *today* for your copy!

CALLING CQ

Adventures of Short Wave Radio Operators

To Your Bookseller or Radio Store or
DOUBLEDAY, DORAN
Dept. QST 5, 14 West 49th Street, New York, N. Y.

Send me copies of CALLING CQ, by Clinton B. DeSoto at \$2.00 per copy.

Remittance herewith Send C.O.D.

Name

Address

RADIO OPERATING QUESTIONS ^AND ANSWERS

Nilson & Hornung's new edition covers all FCC commercial license exam elements. Standard handbook 20 years. \$2.50, postpaid. Money back if not satisfied and book returned in 10 days. Send check or money order . . . not cash. *Free circular on request.*



NILSON RADIO SCHOOL, 51 East 42nd St., New York

CRYSTALS by HIPOWER

The Hipower Crystal Company, one of America's oldest and largest manufacturers of precision crystal units, is able to offer the amateur and manufacturer attractive prices because of their large production and the exclusive Hipower grinding process. Whatever your crystal need may be, Hipower can supply it. Write today for full information.

HIPOWER CRYSTAL CO.

Sales Division—205 W. Wacker Drive, Chicago
Factory—2035 Charleston Street, Chicago, Ill.

EASY TO LEARN CODE

It is easy and pleasant to learn the modern way — with an **Instructograph Code Teacher**. Ideal for the beginner or advanced student. ■ Many tapes available ranging from alphabet for beginners to typical messages on all subjects. Speed range 5 to 40 WPM. ■ Always ready, no QRM, beats having someone send to you.

FOR SALE OR RENT

STANDARD with 10 tapes and book of instructions, A.C. motor \$24.50
With spring-wound motor \$18.50
JUNIOR with 5 tapes and book of instructions (not rented) \$12.00

RENTAL Standard with 10 tapes and book of instructions \$3.00 first month, \$2.25 each additional month. References or \$10 deposit required. All rental payments may be applied on the purchase price should you decide to buy the equipment.

Write for details today

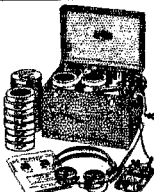

INSTRUCTOGRAPH COMPANY

Dept. Q, 4701 Sheridan Road, Chicago, Illinois
Representative for Canada:
Radio College of Canada, 54 Bloor St. West, Toronto

On the Ultra Highs

(Continued from page 86)

blackout tests. W7's HCU, HCS, FVC, IEK, HQR, and EUI have been worked and GXP and NU are also on. Later in the summer the boys are going out after that California record. A W7 would relieve the monotony of those W6 calls in that DX-Records Box! W7RT would like to see a try at a 112-Mc. Transcon Relay. Think it could be done, gang?

W8LVV, Akron, Ohio, says that the gang there congregated on 160 and then make for 2½ at 8 P.M. nightly. W8's CJL, GCI, UJB, PYZ, and VUG are on, with UYY, VAD, SKM, UGF, LHU, and others in various stages of getting ready.

W6QKM, Beverly Hills, goes mobile on 5, 2½, and 1¼. On 56 Mc. an HY-75 doubler is driven by a 7A4 with a 28-Mc. rock. For 2½, an RK-34 parallel-rod oscillator runs 15 watts, and on 1¼ an HY-75 with parallel rods is used. All are modulated by a 6N7 Class B. Receivers are a 955 working into the audio of the car radio, and a National One-Ten.

The Marathon now has a YL entrant. Anne Schieferstein, W8UUY, tells us that there is plenty doing in western Pennsylvania on 2½, what with W8's BHY, EUO, RIB, RWI, TTQ, TUN, CIR, and UUY among those present each Sunday afternoon and Wednesday and Friday evenings.

W9PNV reports that 2½ sounds like a real ham band around Chicago. George has worked over 70 stations since last August. But if you want to get some idea of activity, take a look at Boston, where WIMBS took the first monthly award in the 1941 Marathon with 72 stations worked in one month. Stan ran this total up to an even hundred in the second period!

Here's one fellow who really has "all-band" equipment. W2TY of Hollis, Long Island, has rigs operating on nine bands, 1.7 to 448 Mc. One contact on 448 Mc. and four on 224 Mc. are proof of the u.h.f. end of this lineup.

Ever work on a project for months at a stretch? If so, you have an idea of how W1HDF and W1A1Y feel over their success in pushing 224-Mc. signals over the 18-mile indirect path between Elmwood and Wolcott, Conn. Al and Carl have been at it for over a year, trying just about everything in the way of antennas. W1A1Y heard W1HDF some time back, but the trip in reverse was made when Al installed a horizontal antenna with a 20-element square-corner reflector for transmitting, and Carl tipped his 12-element birdcage over into a horizontal position for reception. W1A1Y is now S-9 at Wilbraham, 45 miles distant, in comparison to S-7 with the best former combination.

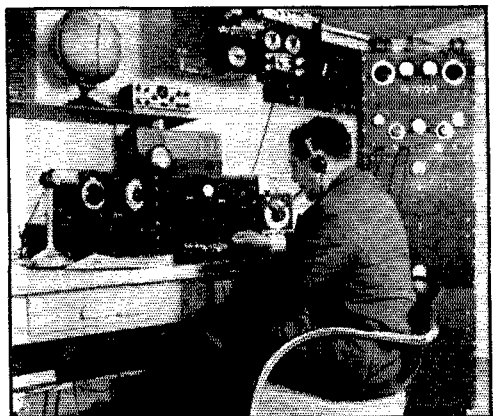

W7GGG, Cheyenne, Wyo.

Operator — Samuel S. Zuckerman, M.D. Transmitter — X-EC, 807, p.p. TW75's. 700-watts input on 3.5-, 7-, 14- and 28-Mc. bands, 'phone and c.w. Modulator — HY51A's. Antennas — 350-ft. Vee, 14-Mc. 3-section 8JK, 28-Mc. vertical double Zepp, and 3.5-Mc. Zepp. Receiver — Super-Pro.



It's Got to be Right to be **TRIPLETT**



Nobody "bosses" Cliff Elliott, chief of the Triplett inspection line. Production is up, — way up, but nobody puts the heat on "Inspection" for the slightest variation from the most hardboiled inspection scrutiny in the industry. For it is an axiom in the whole Triplett plant — regardless of position or the pressure

of orders — "It's got to be *right* to be Triplett." Under expanded industrial demand there continues to be no compromise in those rigid Triplett standards which have become the International Hallmark of Precision and Quality. For more information write Section 255, Harmon Avenue.

THE TRIPLETT ELECTRICAL INSTRUMENT CO., BLUFFTON, OHIO

Piezo-Electric Crystals Exclusively

● Quality crystals of all practical frequencies supplied SINCE 1925. Prices quoted upon receipt of your specifications.

Our Pledge: **QUALITY FIRST**
SCIENTIFIC RADIO SERVICE

"The Crystal Specialists Since 1925" University Park, Hyattsville, Md.

HELP WANTED

Licensed radio Amateur wanted. Permanent position with large established radio parts store in New York. One with pleasing personality and living in New York or very close to N.Y.C. Capable of selling "ham" receivers, transmitters, parts, tubes, etc. Write giving age, experience, and full details. Excellent opportunity for right man. Write: Box NY, c/o Advertising Dept. QST, West Hartford, Conn.

ONAN ELECTRIC PLANTS

OVER 40 STOCK MODELS — 350 TO 10,000 WATTS

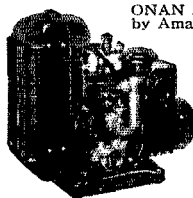

ONAN A. C. ELECTRIC PLANTS are used by Amateurs ALL OVER THE WORLD for Emergency Power during shut-down caused by Hurricanes, Floods and Sleet Storms. AMATEUR RADIO CLUBS participating in recent Field Day scored High with ONAN Powered Equipment.

ONAN PLANTS used in Radio and Electrical Work, operate Radio Transmitters and Receivers, Telephonic Communication Systems, News and Advertising Cars, Lights, All Appliances.

NEW MODELS — Any Voltage — Any Frequency Air or Water-Cooled — Any Starting Method, Gasoline, Natural Gas, Oil or Diesel Powered. Write for Complete Details.

D. W. ONAN & SONS

349 Royalston Avenue

Minneapolis, Minnesota

LEARN RADIO • TELEVISION

60-page catalog on request. Oldest, largest and best equipped in New England. New classes now forming. Write for new catalog.

MASS. RADIO SCHOOL

18 Boylston Street

Boston, Massachusetts

▶ RADIO CONTROL ◀

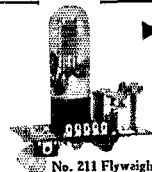

Get in on the thrilling new hobby — radio control of models. RCH equipment is widely and successfully used. Ask your dealer or send 10¢ for illustrated Instruction Manual.

RADIO CONTROL HEADQUARTERS, INC.

330 West 42nd Street

New York City

No. 211 Flyweight Receiver, \$6.75

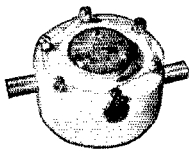
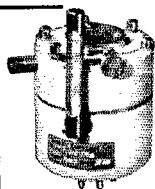

GENERAL COMMUNICATIONS CRYSTALS HOLDERS AND OVENS

Precision Made by *Biley*

WRITE FOR CATALOG G-12

BILEY ELECTRIC CO., ERIE, PA.

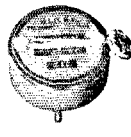

NEW

ABBOTT DK-3

2½ Meter Portable Battery Transceiver
In Stock—On Demonstration at Both
Terminal Stores

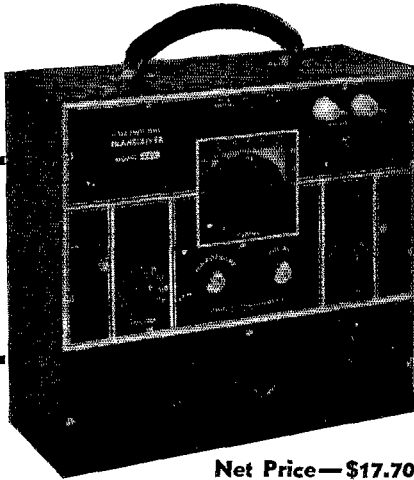

Net Price—\$17.70
Less Tubes and Batteries

Portable battery 2½ M. transceiver with inductive antenna coupling variable from front of panel permitting maximum transfer of power in the transmit position and additional tuning refinements in the receiver position.

The Abbott DK-3 functions as a completely self-contained 112 Mc. radiophone transmitter and receiver. Its extremely compact size makes it desirable and convenient to use in a car, plane, boat or carried for portable work. Range will vary between 2 to 30 miles depending on the terrain. Ideal as an emergency communications unit. Exceptional results have been obtained.

Specifications:

Case: Size 11" long x 11" high x 4½" wide, grey wrinkle finish, heavy leather handle. All batteries are self-contained in case. Back is removable, making batteries and tubes easily accessible.

Frequency: Covers 112-116 mc. (Amateur 2.5 meter band.)

Battery Requirements: Three 45 volt B batteries like Eveready No. 482 or Burgess M30 and four 1½ volt batteries like Burgess 4FH or Eveready No. 742.

Tubes: One 6J5GT, one 6G6G.

Shipping Weight: 11 pounds.

You'll want these accessories, too!

Amateur Net

- | | |
|-------------------------------------|--------|
| 1 Hytron 6J5GTX, ceramic base..... | \$.95 |
| 1 RCA Radiotron 6G6G..... | .67 |
| 3 Burgess M30 batteries @ 1.05..... | 3.15 |
| 4 Burgess 4FH batteries @ 33c..... | 1.32 |
| 1 Abbott 2½ meter antenna..... | .60 |

Order from this ad or visit us in N. Y. C.

TERMINAL Radio Corp.

68 West 45th St. • 80 Cortlandt St.
2 stores in NEW YORK CITY
Vanderbilt 6-5050 • Cable: TERMRADIO

(Continued from page 80)

APB and LUD both portable mobile on 112 Mc. worked at a distance of 20 miles. BGO is adding a 242A final to his present exciter. KI has a regular schedule with Fort McClellan, Ala. BO, BGV and MRL joined the A.A.R.S. EC is the connecting link between the Section Net and T.L. AP. The N.N.W.A. invites all of the gang to visit their new shack and 600-watt National transmitter. Fifteen members of the Fisherman's Net met at LEB, in East Hampton, and had an fb hamfest. NPT reports for the 28-Mc. gang in Elmhurst. LXC has gone on active duty in the N.C.R. MYR lost his antenna in a slight breeze after it came through the ice storms. NFU has a new three-element on 28 Mc. He also won five dollars at the 28-Mc. round-up at Carney, N. J. LUG is making up for lost time on 28 Mc. after a year's absence. LXN is putting 40 watts into an 807 on 28 Mc. MXB is using an indoor doublet on 28 Mc. JLC finally got his new modulator going after considerable work. The Section Net is doing very fine work handling traffic and getting prepared for any emergency. More stations are desired. The aim of the net is to get every town on Long Island active and the gang are invited to call in any night that they desire.

Traffic: W2BO 738 SC 724 AYJ 526 LPJ 459 KI 434 BWC 271 EC 166 GIC 133 DBQ 125 LR-MRL 124 BGV 115 DW 105 NDQ 92 AZV 90 LGK 70 MT 84 LYC 47 JZX 43 EYS 34 NAZ 33 BGO 32 LBI 31 FAQ 30 EXR 25 MZB 22 INF 20 CET 15 HGO-MNF 12 IXZ-IXY 11 BIV 6 DOG 5 NLQ 4 NHD-AV 3 JAU-MHD 2 GDF-KTA-ADW-CHK-IRC-CTN 1 (January 16th to February 15th): BO 543 KI 513 SC 489 LPJ 293 BWC 250 MRL 132 DBQ 131 MRV 123 MT 182 EC 113 LR 76 BGV 66 FAQ 64 DW 60 LGK 54 LBI-AZV 45 NAZ 44 3MA/2 42 LZR 39 EXR 28 MZB 30 MNF 23 LYC 21 BGO 19 IYX 14 BIV-JAU 12 AYJ-IXZ 10 HGO 5 DOG-CET 4 PF-PLD 3 BCS-VG-ADW2GDF-NLQ-NHD-BYL-CCD-CTN-CHK-IRC-FF 1.

NORTHERN NEW JERSEY—SCM, Edward Gursky, Jr., W2LMN — R.M.'s: BZJ, CGG, HXI, IYQ — P.A.M.: LXI. Section Net frequency: 3630 kc., 8:30 to 9:30 p.m. daily except Sunday. New appointments: O.R.S.: MLW, MNO, NCY, O.P.S.: LJB, E.C.; Cranford, BYD; Paterson, EYE; Kenilworth, MIG; Woodbridge, MEO. The N.N.J. 7-Mc. Traffic Net is being discontinued, due to lack of activity and trouble with skip conditions. IYQ will take over the R.M. appointment in place of HXI, who will be inactive for a while. HXI has been one of the leading brass-pounders in the Section, and the gang will miss him. Bob is busy building e.c.o.'s in his spare time and just received his A-1 Operator Certificate. The North Newark Amateur Radio Club held a get-together on March 15th in Kearny, and a swell time was had by the 250 or so hams, YLs and YFs who were present. IAT, NJE and NJO have applied for O.R.S. appointment. KSR joined the N. J. 40 A.A.R.S. Net. JRU schedules 21TD/4, who is at the Univ. of N. C. MRJ put up his antenna for the umpteenth time, and hopes it doesn't blow down again. He also received his 30 w.p.m. sticker. 1KEN/2 and 1LRP/2 are at Ft. Monmouth, and will be on all bands from 1.75 to 28 Mc. with 200 watts 'phone and c.w. on 112 Mc. with 15 watts. Greetings, fellas; glad to have you with us. JKH is active on 3.5 and 1.75 Mc., and worked WAR. CIZ is working on a 112-Mc. portable rig. MRK joined the F.T.S. LMN is building a modulator and will soon be on 'phone. JPJ built a new home in Chatham. NPA has a new 56-Mc. rig. GMM, our ex-S.C.M., has a new SX-28 receiver. LCA has a new shack in Allwood. IZV is active as E.C. in Bloomfield. NDL has his new rig working, and is after O.R.S. appointment. JKH and HXI enjoyed the 1.75-Mc. W.A.S. Party. JT built an audio oscillator that really works. Activity in the Section is rapidly increasing. Reports were received from 25 stations this month, which is a good increase over past periods. Non-O.R.S. stations are urged to send in their reports of activity and traffic handled. Secretaries of radio clubs in the Section are urged to send in reports of club activities. Let the rest of the Section know what is going on in your locality.

Traffic: W2CGG 413 MNT 502 (WLNW 61) HXI 344 IYQ 187 LMN 141 (WLNW 46) MLW 94 MHJ 132 MNO 80 HCO 79 BNU 58 LDB 58 BZJ 49 JUU 47 ANW 41 KSR 36 NCY 14 MRJ 16 JRU 12 HZY 9 CJX-NJE 8 LXI-MRX 6 IZV 4 NDL 2 (January 16 to February 15): BZJ 78 (WLNW 36) NDL 33 LXI 10.

Two Top HAMMARLUND Receivers... IN STOCK AT HARVEYS

The "Super-Pro" has been widely accepted as the top receiver for communications service. Electrically, it has many outstanding features such as variable band width in addition to the variable selectivity crystal filter, and a noise limiter that is really effective. Mechanically, the "Super-Pro" is built to stand the wear and tear of continuous duty. Net **\$279**



HQ-120-X and SUPER-PRO

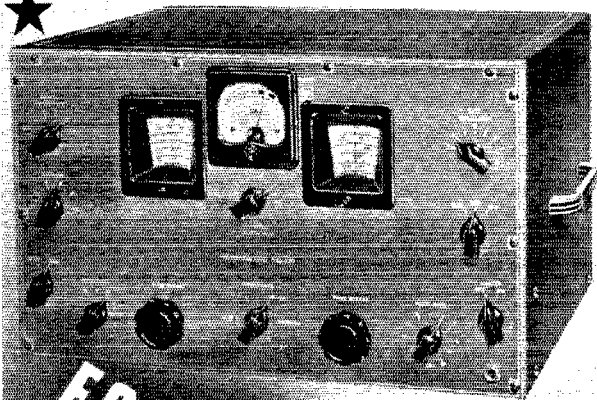

The "HQ-120-X" is a shining example of a popularly priced unit with mechanical and electrical features not found in the ordinary receiver. Examine every detail of the "HQ." Note that it does not follow the design of production type broadcast receivers. It is really a special receiver and is not made on a mass-production basis. Try it in your own shack and you will agree it's tops.

\$138 Net

FOR STELLAR PERFORMANCE!

W21JL • W2LJA • W2PL • W2JKD • W2KWY

HARVEY *Radio Company*

103 West 43rd Street • New York, N. Y. • Cable Address: "HARADIO"

AIRLINES NEED RADIO MEN

The knowledge and experience of Amateur Radio Operators has been responsible in a large measure for the outstanding record established by Midland Schools. Following is a brief resume of that record:

★ After an inspection of approximately 143 radio schools, Midland is one of three chosen by the U. S. Army Signal Corps to provide enlisted men with three months' radio training. ★ Recognition by the Air Transport and Radio industries. ★ Airline instructors secured from major Airlines. ★ Training directed by a 9-Airline Advisory Board. ★ Graduates employed in more than 32 states, at more than 50 airports, and by all major Airlines. ★ Demand for qualified graduates exceeds the supply.

WRITE US TODAY

Midland Schools specialize in training men for positions as Airline Radio Operators and Radio Maintenance Men, with more than \$40,000.00 in equipment available for training. Write us today for a copy of our new 58-page catalog and training outline, containing photos and information provided by Airlines and aircraft manufacturers. No obligation.

List in on the Midland Grad circuit, 7225 kc.,
CQ call, "CQ—MR."

MIDLAND RADIO
AND TELEVISION SCHOOLS INC.
Dept. Q-2, 29th Floor
Power & Light Bldg. Kansas City, Missouri

"Field Day" EVERY DAY PRECISION keeps you ON THE AIR

PRECISION Series 31 Range
832
Rotary Selective AC-DC Multi-Range Tester

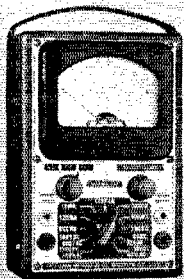

★ **LARGEST METER** ever provided (3½ inches ACTUAL WIDTH) in such a compact instrument ★ **A single Master Rotary Range Selector** allows ALL measurements to be made from ONLY TWO polarized tip jacks, except for the two highest voltage ranges ★ **RANGES** ● 6 DC voltage ranges to 1200 volts and 6 AC voltage ranges to 2400 volts ● 4 DC current ranges to 600 mils ● 3 OHMMETER ranges to 5 MEGS up to 500M ohms on internal battery ● 6 DB ranges (-10 to +62 DB) ● 6 OUTPUT ranges to 2400 volts. ★ **IT'S "PRECISION" BUILT!**—1% wire wound bobbins and matched metallized multipliers.

COMPARE THIS "PRECISION" VALUE at only **\$14.95 net**
There are more than 40 models in the "PRECISION" line of dynamic mutual conductance type tube and combination testers, multi-range testers, signal generators, etc. Prices start as low as \$14.95.

Ask for the PRECISION TEST EQUIPMENT 1941 CATALOG

PRECISION TEST EQUIPMENT
Standard of Accuracy SEE THEM AT YOUR JOBBER

PRECISION APPARATUS COMPANY
647 Kent Avenue Brooklyn, New York
Export Div.: 458 Broadway, New York, U. S. A. — Cables: Morhanex

★ New Receiving Tubes ★

6SF7-12SF7-6SN7GT

R.C.A. ANNOUNCES three new receiving tubes. The 6SF7 and 12SF7 are identical except for heater ratings which are 6.3 volts, 0.3 amperes and 12.6 volts, 0.15 amperes respectively. The type is a single-ended metal tube containing a remote-cutoff pentode and a single diode detector. It is recommended for use as a combined i.f. amplifier and detector. When so used in radio-phonograph combinations, it minimizes the difficulty from "play-through" from the radio circuits. It may also be used as a resistance-coupled a.f. amplifier and will give the same high-gain output as other similar pentodes.

The 6SN7GT is a single-ended twin triode amplifier having separate cathode terminals for each triode unit. It is recommended for use in resistance-coupled circuits as a voltage amplifier or phase inverter.

45Z3-3Q4

RCA announces two new receiving types. The 45Z3 is a miniature filament-type half-wave high-vacuum rectifier designed especially for service in a.c.-d.c. receivers. The filament operates at 45 volts, 0.075 amp. With condenser input, the tube has a maximum r.m.s. plate voltage rating of 117 and d.c. output rating of 65 ma.

The 3Q4 is a miniature-type power-amplifier

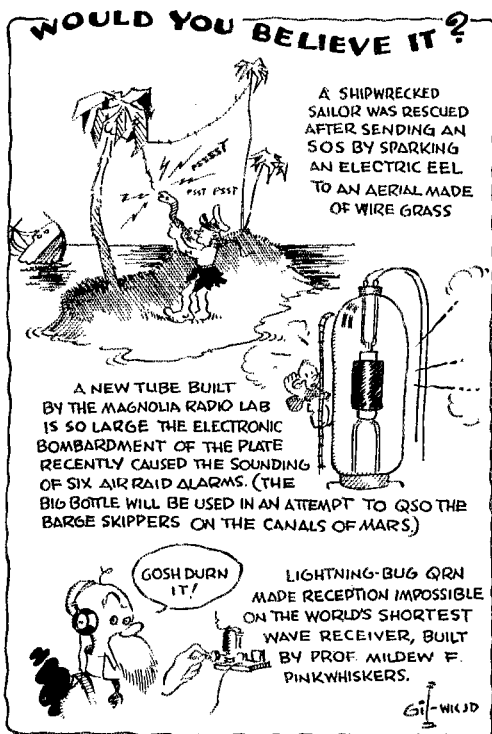

Where to buy it

A directory of suppliers who carry in stock the products of these dependable manufacturers.

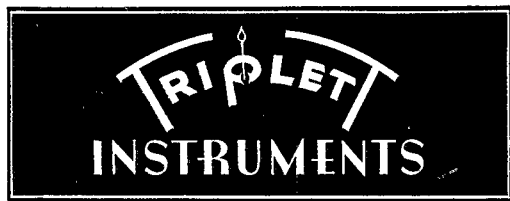

ALBANY, N. Y. Uncle Dave's Radio Shack 356 Broadway
ATLANTA, GEORGIA 265 Peachtree Street
 Radio Wire Television Inc.
BOMBAY, INDIA Eastern Electric & Engineering Company
BOSTON, MASS. Radio Shack 167 Washington Street
BOSTON, MASS. 110 Federal Street
 Radio Wire Television Inc.
BRIDGEPORT, CONN. 177 Cannon Street
 Hatry & Young, Inc.
BRONX, N. Y. 542 East Fordham Rd.
 Radio Wire Television Inc.
BUFFALO, N. Y. 1531 Main Street
 Dymac
BUTLER, MISSOURI 211-215 N. Main Street
 Henry Radio Shop
CHICAGO, ILL. 833 W. Jackson Blvd.
 Allied Radio Corp.
CHICAGO, ILL. 901-911 W. Jackson Blvd.
 Radio Wire Television Inc.
CINCINNATI, OHIO 1103 Vine Street
 United Radio, Inc.
DETROIT, MICH. 325 E. Jefferson Ave.
 Radio Specialties Co.
DETROIT, MICHIGAN 11800 Woodward Ave.
 Radio Specialties Co.
HARTFORD, CONNECTICUT 227 Asylum Street
 Radio Inspection Service Company
HOUSTON, TEXAS 1021 Caroline Street
 R. C. & L. F. Hall
INDIANAPOLIS, INDIANA 34 West Ohio Street
 Van Sickle Radio Supply Co.
JAMAICA, L. I. 90-08 166th Street
 Radio Wire Television Inc.
KANSAS CITY, MO. 1012 McGee Street
 Burstein-Applebee Company
LITTLE ROCK, ARKANSAS 409 W. 3rd Street
 Beem Radio Company
NEW HAVEN, CONN. 1172 Chapel Street
 Hatry & Young, Inc.
NEW YORK, N. Y. Harrison Radio Co. 12 West Broadway
NEW YORK, N. Y. 100 Sixth Ave.
 Radio Wire Television Inc.
NEWARK, N. J. 24 Central Ave.
 Radio Wire Television Inc.
READING, PENN. 404 Walnut Street
 George D. Barbey Company
SCRANTON, PENN. 519-21 Mulberry Street
 Scranton Radio & Television Supply Co.
WASHINGTON, D. C. 938 F Street, N. W.
 Sun Radio & Service Supply Co.

ALBANY, N. Y. Uncle Dave's Radio Shack 356 Broadway
ATLANTA, GEORGIA 265 Peachtree Street
 Radio Wire Television Inc.
BOSTON, MASS. Radio Shack 167 Washington Street
BOSTON, MASS. 110 Federal Street
 Radio Wire Television Inc.
BRIDGEPORT, CONN. 177 Cannon Street
 Hatry & Young, Inc.
BRONX, N. Y. 542 East Fordham Rd.
 Radio Wire Television Inc.
BUFFALO, N. Y. 1531 Main Street
 Dymac
BUTLER, MISSOURI 211-215 N. Main Street
 Henry Radio Shop
CHICAGO, ILLINOIS 833 W. Jackson Blvd.
 Allied Radio Corp.
CHICAGO, ILL. 901-911 W. Jackson Blvd.
 Radio Wire Television Inc.
CINCINNATI, OHIO 1103 Vine Street
 United Radio, Inc.
HARTFORD, CONN. 203 Ann Street
 Hatry & Young, Inc.
JAMAICA, L. I. 90-08 166th Street
 Radio Wire Television Inc.
LITTLE ROCK, ARKANSAS 409 W. 3rd Street
 Beem Radio Company
MINNEAPOLIS, MINNESOTA 1211 LaSalle Avenue
 Lew Bonn Company
NEW HAVEN, CONN. 1172 Chapel Street
 Hatry & Young, Inc.
NEW YORK, N. Y. 100 Sixth Avenue
 Radio Wire Television Inc.
NEWARK, N. J. 24 Central Ave.
 Radio Wire Television Inc.
READING, PENN. 404 Walnut Street
 George D. Barbey Company
SCRANTON, PENN. 519-21 Mulberry Street
 Scranton Radio & Television Supply Co.
WASHINGTON, D. C. 938 F Street, N. W.
 Sun Radio & Service Supply Co.

Listings on this page do not necessarily imply endorsement by QST of the dealers or of other equipment sold by them.

SPRING

TIME

HAM'S HOBBY TIME



SAILING ON THE DEEP?

Take Along a Hallicrafters

S-29 SKY TRAVELER

Truly a remarkable, self-contained portable. Take it wherever you go. Operates on 110 V. A.C. or D.C. or internal batteries. Covers 542 Kc. to 30.5 Mc. on 4 bands. High gain antenna coupling circuit. PRICE — including \$59.50 tubes, ready to operate.

HT-8 RADIOTELEPHONE

No boat should be without this radiotelephone, transmitter-receiver. 25 watts phone carrier. Separate power supply. 5 marine frequencies 2000-3000 range. Operates from 110 volts 60 cycles A.C. or 12, 32 or 110 V. D.C. on special order. PRICE — complete with tubes, less \$250.00 crystals.

Many other models to choose from — \$149.50 and up

SKYRIDER MARINE RECEIVER

Model S-22R. Specially designed for marine service. Frequency range 16.2 to 2150 meters (18.5 Mc. to 110 Kc.). Highly efficient mechanical bandspread with separate dial, built-in speaker, 110 volts AC-DC operation. PRICE — complete with tubes. \$64.50

Send for free descriptive literature

NOW IN STOCK!

R.C.A. 8000 HI-POWER TRIODE

Power Plus! A new addition to RCA's famous line of air-cooled transmitting tubes, designed to withstand high peak voltages. Rated at 275 Ma. and 2250 volts ICAS. Plate dissipation 150 watts. Highly recommended as an r.f. amplifier and class B modulator. AMATEUR NET PRICE \$13.50

A HIT WITH HAMS! VERTROD COMMUNICATIONS ANTENNA

Taken the amateur world by storm! This 9 ft. duraluminum rod antenna system is specially peaked for 10, 20 and 40 meter operation with entire range coverage of 500 Kc. to 60 Mc. Weatherproofed. Easily installed. \$7.06 AMATEUR NET PRICE.

Write for descriptive folder

GREAT SPRING CLEARANCE

Save up to 50 to 60% in our great annual clearance sale! Well-known names, well-known brands — hard-to-get parts, tubes, test instruments (new, used, re-conditioned and discontinued models) new and used ham receivers — all at bargain prices! Come early while quantity lasts! Or, write at once for free copy of Special Clearance Bulletin 201A.

NOW! Enjoy HI-FIDELITY at HOME!

Write for SUN's free booklet "Music Appreciation — at Home" — devoted to latest high fidelity developments and recommendations for fine home entertainment.

JUST OFF THE PRESS!

W2JEH — W2LFV — W2CLH — W2IOP — W2EMR

SUN RADIO CO.
212 Fulton Street, Dept. WT New York
Cable Address: SUNRADIO NEW YORK.

pentode suitable for operation with 90 volts on plate and screen. It has an output power of 270 milliwatts with 7-per cent distortion. The filament is center-tapped permitting either series operation at 2.8 volts, 50 ma., or parallel operation at 1.4 volts, 100 ma.

Correspondence Dept.

(Continued from page 44)

I had the pleasure several years ago of holding the second trick position on United Airlines radio circuit when they operated through Bellefonte. There I learned much about real good 'phone operation. Where constant "watch" and minimum air time are essential, I know that for speed in dispatching traffic there is nothing to compare with good 'phone operation. While on the above job, I timed a "sequence" transmission starting in Chicago, going to Toledo, to Cleveland, to Bellefonte, to Newark and return through the same stations, in which each operator gave station call, location, operator's name and acknowledgment. The elapsed time for the round trip was just 10 seconds. It is common practice to take a message as read, relay it to the next point, and then write your original copy. I have done this on many occasions. Of course, this is only possible on short, standard form messages, such as flight, arrival, and departure reports.

I would certainly like to see more 'phone men learn to operate this way. . . .

— Edgar R. Mallory, W8UR

DYNAMIC PROGNOSTICATION

CORAPOLIS PA

EDITOR QST

FURTHER DEVELOPMENTS DYNAMIC PROGNOSTICATION INDICATE TUBE AND POWER SUPPLY ENTIRELY UNNECESSARY STOP LATEST CIRCUIT AND OPERATION AS FOLLOWS COLON CRYSTAL IS CONNECTED BETWEEN TUNED ANTENNA AND GROUND STOP ANTENNA PICKUP FROM LOCAL BROADCAST STATION CAUSES CRYSTAL TO OSCILLATE COMMA THE WELL KNOWN EINSTEIN EQUALIZING EFFECT COMMA PRODUCING SIGNAL AT ANTENNA RESONANCE STOP RIG IS KEYED BY RAISING AND LOWERING ANTENNA THIS PRODUCING ONLY LOCAL THUMPS.

(Sig.) W8FVU AND W8KWA

Strays

W2KWB's house number is 410. His car license plate bears the number CQ-410.



KAINF, Rizal, P. I.

Operators — J. M. Molitor, J. H. Porter, M. P. Quandt, attached 2nd Obs. Squadron, Air Corps. Transmitter — E.c.o., 6V6, 807, p.p. 225 watts input on 14- and 7-Mc. c.w. Rhombic antenna. Receiver — RME-69 and preselector.

BUY ON EASY TERMS · MAIL ORDERS PROMPTLY FILLED · WRITE FOR FREE CATALOG

Your **FREE** for 2½ Meters

ABBOTT DK 3

FOR YOUR PLEASURE . . .

The new DK-3 portable transceiver for 2½ meter operation, taking the place of the very popular DK-2, will, we are sure, satisfy every requirement for portable 2½ meter operation — it is small — more efficient — and in addition to all the features heretofore found in the DK-2 inductive antenna coupling from front of panel has been added, assuring the maximum transfer of energy in the transmitting position.

Battery Kit.....\$4.21 Tube Kit.....\$9.96
Handset.....\$5.88

IMMEDIATE DELIVERY ON RECEIPT OF ORDER



\$17.35

ABBOTT MRT 2



\$27.96

For those who want more power, the MRT-3 2½ meter high-powered transceiver is the answer. 20 watts of input make it possible to get 6 to 7 times more power than is furnished by the ordinary unit. The range is consequently much greater. Its small size makes for easy and simple installation in a car.

Dimensions: 9" x 8" x 4". Built-in permanent dynamic speaker. Band coverage 112 to 116 megacycles. You can depend on the MRT-3 for reliable communication.

Tube kit, HY75, 6C5, 6V6.....\$ 4.60
Universal hand microphone..... 5.85
Vibrator power supply for automobile..... 12.64
AC power supply for home use..... 12.45

Immediate Delivery on Receipt of Order

Liberal Time Payments

	6 Monthly Payments	8 Monthly Payments	12 Monthly Payments
HALLICRAFTER			
SX-28.....	\$15.95		
S-29.....	5.95		
S-27.....	17.50		
SX-25.....	9.95		
SX-24, less speaker.....	6.95		
S-20R.....	4.95		
S-19R.....	4.43	8.29	
S-32.....	6.45	5.90	
HIT-6.....	9.90	7.69	
HIT-9.....	19.95		
EC-1.....	3.95		7.87
EC-2.....	4.95		15.86
EC-3.....	4.95		4.24 (for four months)
HAMMARLUND			4.42 (for six months)
HQ-120-X.....	13.80		7.95 (for six months)
SP-210-SX.....	27.90		
NATIONAL			
NC-44, with speaker.....	4.95		
NC-200.....	14.75		
HRO, less speaker and power supply....	17.97		
RME			
RME-99, complete.....	13.74		
MEISSNER			
SIGNAL SHIFTER, with tubes.....	4.65		
		5.90	
			10.97
			22.18
			11.72
			14.28
			10.92
			5.55

The **RADIO SHACK**
167 WASHINGTON ST., BOSTON, MASS., U.S.A.

Try to Beat
ALL THESE AMAZING FEATURES!

AT THESE SENSATIONALLY
Low Prices!

Model EC-1. Six tubes. Three bands covering from 545 kc to 30.5 mc. (550 to 9.85 meters). Electrical bandspread on all bands. Beat frequency oscillator. Self-contained PM dynamic speaker. AC/DC operation—115/125 volts. Good selectivity and exceptional sensitivity. Every necessary feature for tip-top communications receiver performance.

\$19⁹⁵

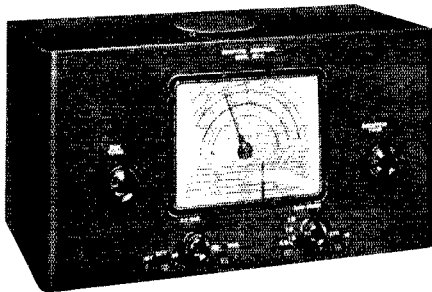

Model EC-3. 10 tubes; 3 bands; covers 545 to 2100 kc—2.1 to 8.1 mc.—7.9 to 30.5 mc; Electrical bandspread; Crystal filter (4 position variable selectivity) calibrated bandspread; automatic noise limiter; preselection on all bands; 2 stage IF amplifier; fly-wheel tuning; separate 6" PM speaker; CW Monitor; operates on 115/125 volts AC/DC.

\$49⁹⁵

\$29⁹⁵

Model EC-2. 8 tubes; 3 bands; covers 545 to 2100 kc—2.1 to 8.1 mc.—7.9 to 30.5 mc; built-in 5" PM dynamic speaker; preselection on all bands; calibrated bandspread scale on 80/40/20/10 meter amateur bands; automatic noise limiter; electrical bandspread at all frequencies in the tuning range; operates on 115/125 volts AC/DC. Now, for the first time you can have all these features at this low price



Echophone
COMMERCIAL

"The Ears of the World"

Echophone Radio Co., 201 East 26th Street, Chicago, Illinois

HAM-ADS

(1) Advertising shall pertain to radio and shall be of nature of interest to radio amateurs or experimenters in their pursuit of the art.

(2) No display of any character will be accepted, nor can any special typographical arrangement, such as all or part capital letters be used which would tend to make one advertisement stand out from the others.

(3) The Ham-Ad rate is 15¢ per word, except as noted in paragraph (6) below.

(4) Remittance in full must accompany copy. No cash or contract discount or agency commission will be allowed.

(5) Closing date for Ham-Ads is the 25th of the second month preceding publication date.

(6) A special rate of 7¢ per word will apply to advertising which, in our judgment, is obviously non-commercial in nature and is placed and signed by a member of the American Radio Relay League. Thus, advertising of bona fide surplus equipment owned, used and for sale by an individual or apparatus offered for exchange or advertising inquiring for special equipment, if by a member of the American Radio Relay League takes the 7¢ rate. An attempt to deal in apparatus in quantity for profit, even if by an individual, is commercial and all advertising by him takes the 15¢ rate. Provisions of paragraphs (1), (2), (4) and (5) apply to all advertising in this column regardless of which rate may apply.

Having made no investigation of the advertisers in the classified columns, the publishers of QST are unable to vouch for their integrity or for the grade or character of the products advertised

QUARTZ — direct importers from Brazil of best quality pure quartz suitable for making piezo-electric crystals.

Diamond Drill Carbon Co., 719 World Bldg., New York City.

QSL'S, Cartoons, Albums, Free samples, Theodore Porcher, 7708 Navaho, Philadelphia, Pa.

USED receivers, Bargains, Cash only. No trades. Price list 3¢. **W3DQ**, Wilmington, Del.

CALLBOOKS — Spring edition now on sale containing complete up-to-date list of radio hams throughout entire world. Also world prefix map, and new time conversion chart. Single copies \$1.25. Canada and foreign \$1.35. **Radio Amateur Call Book**, 610 S. Dearborn, Chicago.

COMMERCIAL radio operators examination questions and answers. One dollar per element. **G. C. Waller, W5ATV**, 6540 Washington Blvd., Tulsa, Okla.

CRYSTALS: police, marine, aircraft. **C-W Mfg. Co.**, 1170 Esperanza, Los Angeles.

QSL'S — Brownie, **W3CJ1**, 1725 Frankfield Ave., Allentown, Pa.

MAC Auto code machines, low monthly rental, 50,000 words practice tapes. For those who own MacAutos, tapes for Macs, recording ink and blank tapes for sale. Write **C. M. Ayers**, 711 Boylston St., Boston, Mass. Tel. **GRAnite 7189-W**.

LEO, **W9GFQ**, offers the hams more and a better deal always. Lowest terms, no red tape (as finance own paper) on all new and used equipment. Free trial, personalized service. Write for 124-page bargain catalog and get acquainted. Wholesale Radio Laboratories, Council Bluffs, Iowa.

TRANSMITTING headquarters on latest Stancor Thordarson & other kits — commercially wired at low cost. New 70 watt transmitter kits complete only \$35 — speech amplifier modulator up to 80 watts \$25 — up to 150 watts \$49.50. Genuine Utah ham transformers at less than 1/2 original cost, 600 volts — 200 ma. \$2.25 — kilowatt modulation types \$13.95. Big list. Easy terms. Write **Leo, W9GFQ**, today.

CRYSTALS: famous **P.R.**, mounted in latest Alsimag 35 holders — 40, 80 meter **PR-X**, 160 meter **PR-Z**, \$3; 40, 80 meter **PR-Z** (low drift), \$3.50; 20-meter **PR-20**, \$4.50; unconditionally guaranteed. Immediate shipment. Quality blanks, 65¢. Wholesale Radio Labs., Council Bluffs, Iowa, **W9GFQ**.

RECEIVERS — New Howard 460's with crystal in original carton, \$59.95. New factory reconditioned **SX-23's**, \$79.50. Reconditioned types, all makes, lowest terms. Write for free list. **Leo, W9GFQ**.

PICK your values — 100 assorted half one watt insulated resistors \$2.95 — your **QSL** gets list used receivers. Technical Equipment Co., 135 Liberty St., New York, N. Y.

CRYSTALS, mounted, 80-160 medium drift \$1.50; low drift 40-80-160 \$2.25. **R9 Crystals**, 338 Murray Ave., Arnold, Pa.

SELL 1 kw. phone — \$100; 200 watt phone — \$50; South Bend lathe \$95; 5 kw., 120 v. alternator — \$100; 1 kw. alternator — \$50. Box 226, Liberal, Kansas.

QSL'S? — **SWL's?** — **QSL's?** Not the cheapest, but the finest **QSL's**. Samples? **W8DED**, Holland, Mich.

NC-100XA receiver ten months old, perfect condition, \$85. **Lloyd Rekow**, 144-32 Barclay Ave., Flushing, N. Y.

SELL — 150 watt xmitter \$35. **W2HFM**.

MIMS Direction Indicator, standard rotator, Brush four cell-mike, Twenty dollars each. Send for list. Selling out. **W4DAA**, Savannah, Ga.

FOR sale: Used Junior Candler code course. **W5JOM**, 1220 Proctor, Port Arthur, Texas.

TRANSMITTER wanted, 500 or 1000 watts complete with microphone, tubes, etc. Prefer National or other well known make. **Guy F. Stark**, 7518 Bel Air Rd., Baltimore, Md.

SELLING out — send for list. **W1BFJ**, 13 Union St., Winsted, Conn.

FABERADIO crystals, mounted, **AB \$2.50**; **X 80-40 \$2**; **Y 160-80 \$1.50**. **Elkay, Oglesby, Ill.**

SELL. 500 watt CW transmitter \$50. **Austin Harrison, c/o KGNF**, North Platte, Nebr.

NATIONAL SW3 20-40-80 mtr. handsread coils less pwr supply \$10. **Sky Buddy** model **S19 \$17**. Both A-1 receivers and f.o.b. priced. **W9CHF**.

BRIDGE, capacity, resistance, **Aerovox**, offers. Box 602, Fall River, Mass.

HARVEY 200R transmitter for sale. 250 watts CW 60 watts phone. **W1BHM**.

SELL, swap, surplus ham equipment. Want defective meters. **W9ARE**.

QSL'S — **SWL's**, Colorful, Economical. **W9KXL**, S19 Wyandotte, Kansas City, Mo.

WANT 250 watts 60 cycle 110 generator. **W1JZD**, 12 Commonwealth, Boston.

SELL — 400 watt, 4 stage, 40 and 20 mtr xmitr in rack; **SX-16** recvr; **Browning** freq. mtr; **Macbug** key. All for \$385. Xmitr only, \$300. Cash only. Write to **W1GRK**.

THREE element beam complete less rotator \$24. High Frequency Engineering Co., Lorain, Ohio.

SELL **Harvey UXH10R** transmitter complete with dynamotor, remote control panel. Designed five meter mobile. Range 1500-60,000 kilocycles. **W6ITH**.

FOR sale — new **RCA** transmitting tubes in original cartons at a bargain price. Send for list. **Lowell Ecker**, Sedan, Kansas.

QSL'S, Finest quality. Samples. **Maleco**, 1805 St. Johns Place, Brooklyn, N. Y.

CRYSTALS in dustproof, low-loss, plug-in holders. Active oscillators. 160 and 80 M low-drift AT \$1.25; 40X \$1.75. State frequency desired. **Pacific Crystals**, Box 6679, East Los Angeles Branch.

SELL — **QST 1929-1941** inclusive. **W2CIZ**.

WANTED — receiver, also low powered transmitter — cash. **Geo. Laine**, 933 New York Ave., Brooklyn, N. Y.

SELL — 400 watt CW xmitr 6L6 — 155 — 204A extra tubes, parts, 7 Jewell meters; \$85. cash. Write for photo. **W9ACK**.

CRYSTALS, mounted in plug-in holders. Guaranteed. 160M-80M AT, \$1; 40X, \$1.25. **COD's** OK. Telephone **ANGelus 15905**. **Copple, W6JEB**, 344 So. Fetterly, Los Angeles.

WRITE **Bob Henry, W9ARA**, for the best deal on all amateur receivers, transmitters, kits, parts. You get best terms (financed by myself) big trade-in allowances; personal cooperation; lowest prices. **NC-20's** and other latest model receivers positively in stock. Special bargain prices on several models of new receivers. Write, **Henry Radio Shop**, Butler, Mo.

RECONDITIONED guaranteed amateur receivers and transmitters. All makes and models. Lowest prices. Free trial. Terms. List free. Write, **Bob Henry, Butler, Mo.**

QSL'S, **SWL's**, 100 — 3 color — 75¢. **Lapco**, 344 W. 39th, Indianapolis, Ind.

CRYSTALS: commercial or amateur: A complete line of fine crystal units at attractive prices is available for police, marine, aircraft and other commercial services. Send for catalog. Amateurs: our **T9 40, 80** and **160** meter crystals at \$1.60 are unbeatable. Close frequency choice. Amateur spot frequencies \$2. Fully guaranteed. **T9** ceramic holder \$1. **COD's** accepted. Sold by: **Henry Radio Shop**, Butler, Mo.; **Radio Doc**, 721 S. Main St., Los Angeles, Calif.; **Distribuidora Fronteriza**, Laredo, Texas; **Pembleton Labs.**, Ft. Wayne, Ind.; **The Hargis Co.**, Austin, Texas; **Frank Anzalone**, 375 W. 46th, N. Y. C.; **Kerr's Radio Shop**, El Paso, Texas; and **Eidson's**, Temple, Texas.

EXPERIMENTERS: three crystal blanks \$1. **W8OUE**, Crystal Manufacturer, Indiana, Pa.

QSL'S — **Fritz**, 1213 Briargate, Joliet, Ill.

BIG buy of year — Must sell complete hamshack for cash. 1 kw. operated 6 mo. on 75M. Write for line up details. Receiver and all accessories go. **R. W. Bentley, W9CAH**, 1306 Davis St., Evanston, Ill.

QUALITY **QSL's**. **Arthur Harrison**, 8001 Piney Branch Rd., Silver Spring, Md.

SELLING out — testing equipment, transmitters, modulators, speech equipment power supplies, etc. Box 268, Blackwell, Okla.

WHEATSTONE tape automatic transmitters. Also new parts for Creed automatic transmitters. **Probor Instruments**, 99 Rogers Ave., Brooklyn, N. Y.

NEW ABBOTT DK-3

Portable battery 2½ M. transceiver with inductive antenna coupling variable from front of panel permitting maximum transfer of power in the transmit, position and additional tuning refinements in the receiver position.

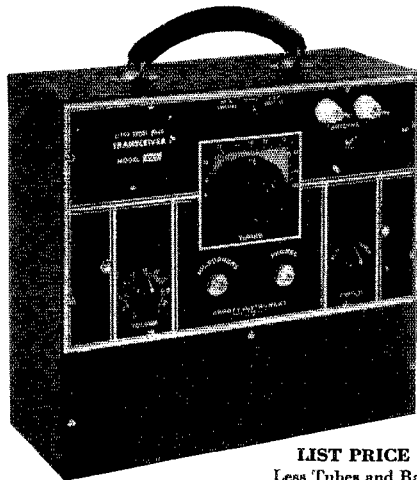

LIST PRICE \$29.50
Less Tubes and Batteries

40% DISCOUNT TO AMATEURS

THE ABBOTT DK-3 functions as a completely self-contained 112 Mc. radiophone transmitter and receiver. Its extremely compact size makes it desirable and convenient to use in a car, plane, boat, or carried for portable work. Range will vary between 2 to 30 miles depending on the terrain. Ideal as an emergency communications unit. Exceptional results have been obtained.

MRT-3-2½ METER

HI-POWER MOBILE TRANSCIEVER

20 WATTS—INPUT

The unit you need for your car operates from car battery and vibrator power supply. Real transmitting tube Hytron HY-75 used in the R.F. EXTREMELY COMPACT. Size 9" long — 8" high — 4" deep. Self contained PM dynamic speaker.

PRICE \$47.00 List

Less 40% to Amateurs

SEE IT AT YOUR FAVORITE DEALER. Write for bulletin S

ABBOTT INSTRUMENT, INC.

51 Vesey Street New York City

FULLFILL YOUR AMBITION

Train yourself at home for that technical radio job or promotion you want. Study under personal direction of A. R. Nilson — for twenty years expert author-instructor. Three up-to-the-minute, low-cost, home-study technical radio courses:

1. Essentials of Radio Communication
2. Advanced Radiotelegraphy
3. Broadcast Operating

will help you succeed in your job or on license examinations

FREE BOOKLET "What the Modern Radioman Must Know" describes these courses in detail. Send for your copy now!

NILSON RADIO SCHOOL

51 East 42nd St., New York, N. Y.



Janette

ROTARY CONVERTERS

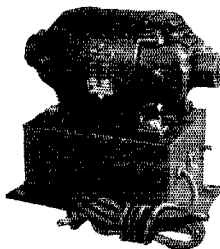

Janette Converters were the ORIGINAL machines designed and built especially for radio apparatus.

These machines progressed with the industry and have made record for economical, trouble-free operation that today Janette and quality products are synonymous.

such an outstanding reliable, trouble-free operation that today Janette and quality products are synonymous.

WARNING: Janette converters are being imitated — be sure Janette is stamped on the name plate. Dynamotors, generators and motor-generators are also available.

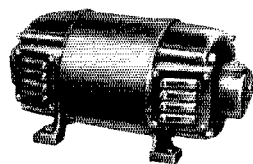

MAY WE SEND LITERATURE?

Janette Manufacturing Company

556-558 West Monroe Street Chicago, Ill. U. S. A.

AMATEUR RADIO LICENSES

Day and Evening Classes in Code and Theory

HOME STUDY COURSES

Reasonable, Efficient and Thorough, Hundreds of Licensed Students Now on the Air

American Radio Institute, 1123 Broadway, New York, N. Y.

RADIO

ENGINEERING, broadcasting, aviation and police radio, servicing, marine radio telegraphy and telephony, Morse telegraphy and railway accounting taught thoroughly, 48 weeks' engineering course, equivalent to three years of college radio work. School established 1874. All expenses low. Catalog free.

DODGE'S INSTITUTE, Day Street, Valparaiso, Indiana



**DIRECT-COUPLED
AMPLIFIERS**

ENGINEERED BY
A. C. SHANEY

Write For Complete Details

AMPLIFIER COMPANY of AMERICA

17-25 West 20th St., New York, N. Y.

Your Nearby Dealer Is Your Best Friend

Your nearby dealer is entitled to your patronage. He is equipped with a knowledge and understanding of amateur radio. He is your logical source of advice and counsel on what equipment you should buy. His stock is complete. He can supply your needs without delay. His prices are fair and consistent with the high quality of the goods he carries. He is responsible to you and interested in you.

One of these dealers is probably in your city — Patronize him!

ATLANTA, GEORGIA

Radio Wire Television Inc.
265 Peachtree Street
"The World's Largest Radio Supply House"

JAMAICA, L. I., NEW YORK

Radio Wire Television Inc.
90-08 166th Street (Merrick Road)
"The World's Largest Radio Supply House"

BALTIMORE, MARYLAND

Radio Electric Service Co.
3 N. Howard St.
Everything for the Amateur

MONTREAL, CANADA

Canadian Electrical Supply Co., Ltd.
285 Craig Street West
Largest Distributors of Radio Parts & Testers in British Empire

BOSTON, MASS.

Radio Wire Television Inc.
110 Federal Street
"The World's Largest Radio Supply House"

NEWARK, N. J.

Radio Wire Television Inc.
24 Central Avenue
"The World's Largest Radio Supply House"

BRONX, NEW YORK

Radio Wire Television Inc.
542 East Fordham Road
"The World's Largest Radio Supply House"

NEW YORK, N. Y.

Radio Wire Television Inc.
100 Sixth Avenue
"The World's Largest Radio Supply House"

BUFFALO, NEW YORK

Radio Equipment Corp.
326 Elm Street
W8PMC and W8NEL — Ham, service and sound equipment

NEW YORK, N. Y.

Harrison Radio Company
12 West Broadway
Harrison Has It! Phone WO 2-6276 for information or rush service

BUFFALO, NEW YORK

Dymac Radio
1531 Main Street — Cor. Ferry
Owned and operated by Hams for Hams GA. 0252

PHILADELPHIA, PENNSYLVANIA

Eugene G. Wile
10 S. Tenth Street
Complete Stock of Quality Merchandise

HARTFORD, CONNECTICUT

Radio Inspection Service Company
227 Asylum Street
What do you want? We have it. Radio exclusively

PROVIDENCE, RHODE ISLAND

W. H. Edwards Company
85 Broadway
National, Hammarlund, Hallicrafter, Thordarson, Taylor, RCA

HARTFORD, CONNECTICUT

Hatry & Young, Inc.
203 Ann Street
Stores also in Bridgeport and New Haven

RICHMOND, VIRGINIA

The Arnold Company
Broad at Harrison St.
W3EQQ — "The Virginia Ham Headquarters" — W3FBL

HOUSTON, TEXAS

R. C. & L. F. Hall
1021 Caroline Street (C 0721)
"Specialists in Amateur Supplies"

SCRANTON, PENNSYLVANIA

Scranton Radio & Television Supply Co.
519-521 Mulberry Street
Complete Stock of Quality Amateur Supplies

YOU CAN BE SURE
WHEN YOU BUY FROM

QST

ADVERTISERS

“Advertising for QST is accepted only from firms who, in the publisher’s opinion, are of established integrity and whose products secure the approval of the technical staff of the American Radio Relay League.”

Quoted from QST’s advertising rate card.

Every conceivable need of a radio amateur can be supplied by the advertisers in QST. And you will know the product has the approval of the League’s technical staff

Index to Advertisers

	PAGE
Abbott Instrument, Inc.	92
Aerovox Corporation	68
American Radio Institute	92
Amplifier Company of America	92
Astatic Microphone Laboratory, Inc.	79
Barker & Williamson	74
Billey Electric Company	75, 83
Candler System Company	75
Capitol Radio Engineering Institute	78
Cardwell Mfg. Corp., Allen D.	56
Centralab	51
ClaroSTAT Mfg. Company, Inc.	79
Collins Radio Company	Cov. 2
Cornell-Dubilier Electric Corp.	52
Daven Company, The	75
Dodge’s Institute	92
Doubleday, Doran & Company, Inc.	82
Echophone Radio Company	90
Eitel-McCullough, Inc.	61
Gardiner-Levering Company	80
General Electric Company	57
Hallcrafters Company, The	1, 2
Hammarlund Mfg. Company, Inc.	53, 55
Harrison Radio Company	81
Harvey Radio Company	85
Henry Radio Shop	78
Hipower Crystal Company	82
Instructograph Company, The	82
Janette Mfg. Company	92
Jensen Radio Mfg. Company	5
Johnson Company, E. F.	63
Kenyon Transformer Company, Inc.	66
Mallory & Company, Inc., P. R.	50
Massachusetts Radio School	83
Messner Mfg. Company	54
Midland Radio & Television Schools, Inc.	86
Millen Mfg. Company, Inc., James	68
National Company, Inc.	Cov. 3, 49, 59
Newark Electric Company	65
Nilson Radio School	82, 92
Ohmite Mfg. Company	67
Onan & Sons, D. W.	83
Par-Metal Products Corp.	74
Pioneer Gen-E-Motor Corp.	80
Port Arthur College	64
Precision Apparatus Corp.	86
RCA Institutes, Inc.	80
RCA Mfg. Company, Inc.	Cov. 4
Radio Control Headquarters, Inc.	83
Radio Mfg. Engineers, Inc.	95
Radio Parts Distributing Company	89
Radio Shack, The	89
Scientific Radio Service	83
Shure Brothers	79
Sickles Company, F. W.	80
Signal Electric Mfg. Company	70
Solar Mfg. Corporation	58
Sun Radio Company	83, 88
Taylor Tubes, Inc.	69
Teleplex Company	64
Terminal Radio Corporation	84
Thordarson Electric Mfg. Company	60
Triplitt Elec. Instrument Company, Inc.	83
United Electronics Company	62
United Transformer Corp.	96
Ward Leonard Electric Company	70
Wholesale Radio Laboratories	84
Yaxley	50

New RME'S

FULL-SIZE performance at a medium sized price is a good description of RME'S newest series of communications receivers. Made in two identical models (with the exception of crystal filter and R-db meter), these receivers offer the amateur and short-wave listener the ultimate in true communications reception at a real saving in initial cost. These receivers, while not as elaborate as the more expensive RME models, nevertheless are built to the same high-quality, precision RME standards which have been known and depended upon for years.

RME-41 \$9450

Less Crystal
and Meter

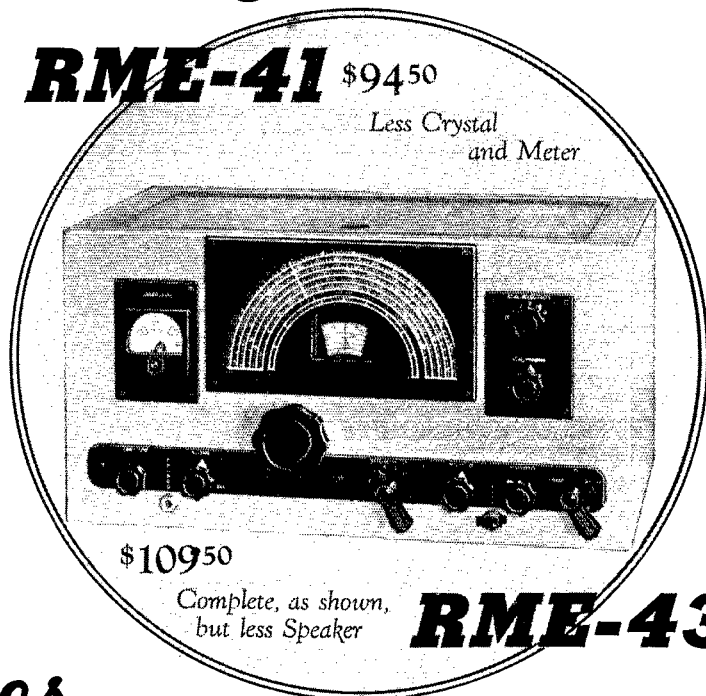

\$10950

Complete, as shown,
but less Speaker

RME-43

New Features

- CAL-O-MATIC
bandsread dial
- 550-33,000 KC
in 6 bands
- LOKTAL TUBES
- TWO-TONE FINISH
- PLUG-IN CRYSTAL
and meter units
- SPECIAL TUNING
condenser
- STANDBY CONTROL
- DOUBLET ANTENNA
input
- TEMPERATURE
COMPENSATED
high-freq. oscillator

BRAND NEW in every detail the RME'S 41 and 43 are completely universal in their service scope. Equally effective as precision commercial or amateur communications receivers, they are at the same time extremely economical instruments for average short-wave use. The RME-41 may be purchased without crystal filter or R-db signal level meter and later, with the addition of these units, converted into the *complete* 43 model. (This conversion is easily made without the aid of special tools of any kind.)

Featured for the first time in these receivers is the CAL-O-MATIC type bandsread dial. This new type dial, operating on a new principle, gives *complete bandsread* calibration on 5 amateur bands, 10 to 160 meters . . . and IN ADDITION arbitrary bandsread calibration is provided over the *entire* tuning range. In this system there are no extra dials to be pre-set . . . all bandsread calibration points are automatically located as these receivers are tuned. The total amount of bandsread tuning available for the entire spectrum is equivalent to 480 inches or 40 feet.

Uniform sensitivity, excellent image ratios, and a high degree of stability coupled with a medium price make the value of these new receivers outstanding.

For further information and complete technical details just drop a postal to Radio Mfg. Engineers, Inc., Peoria, Illinois. TIME WILL TELL the entire radio fraternity of new accomplishments in radio reception as the RME'S 41 and 43 are produced.

New Low Prices

UTC OUNCER SERIES

of High Fidelity Transformer Components

The UTC OUNCER series represents the acme in compact quality transformer practice. These units weigh approximately one ounce and those which do not carry D. C. have high fidelity characteristics suitable for broadcast and similar applications. The OUNCER transformers are ideal for hearing aid, aircraft, glider, portable, concealed service, and similar applications.

The overall dimensions of these units are $\frac{7}{8}$ " diameter by $1\text{-}\frac{3}{16}$ " height, including lugs. Mounting is effected by two screws, opposite the terminal board side, spaced $\frac{13}{16}$ ".

The frequency response of these units is illustrated in the curves below, uniform response being obtainable from 40 to 15,000 cycles. The useful range of the 0-14 and 0-15 units is 150 to 4,000 cycles. Due to the very small size of the transformers, hum pickup is comparatively low.

OUNCER HIGH FIDELITY AUDIO UNITS

(MAX. LEVEL 0 DB)

200 ohm balanced winding may be used for 250 ohms.

Type No.	Application	Pri. Imp.	Sec. Imp.	List Price
0-1	Mike. pickup or line to 1 grid	50, 200, 500	50,000	\$10.00
0-2	Mike. pickup or line to 2 grids	50, 200, 500	50,000	10.00
0-3	Dynamic mike to 1 grid	7.5/30	50,000	9.00
0-4	Single plate to 1 grid	8,000 to 15,000	40,000	8.00
0-5	Single plate to 1 grid, D.C. in Pri.	8,000 to 15,000	60,000	8.00
0-6	Single plate to 2 grids	8,000 to 15,000	95,000	9.00
0-7	Single plate to 2 grids, D.C. in Pri.	8,000 to 15,000	95,000	4.00
0-8	Single plate to line	8,000 to 15,000	50, 200, 500	10.00
0-9	Single plate to line, D.C. in Pri.	8,000 to 15,000	50, 200, 500	10.00
0-10	Push pull plates to line	8,000 to 15,000 each side	50, 200, 500	10.00
0-11	Crystal mike or pickup to line	50,000	50, 200, 500	10.00
0-12	Mixing and matching	50,200	50, 200, 500	9.00
0-13	Reactor, 200 Hys.—no D.C.—50 Hys.—2 MA D.C.—8,000 ohms			
0-14	50:1 mike or line to 1 grid	200	$\frac{1}{2}$ megohm	7.00
0-15	10:1 single plate to 1 grid	8,000 to 15,000	1 megohm	10.00

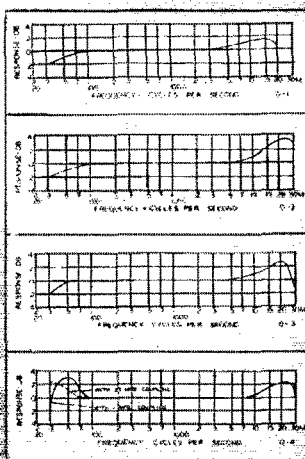

UNITED TRANSFORMER CORP.

150 VARICK STREET

NEW YORK, N. Y.

EXPORT DIVISION: 100 VARICK STREET, NEW YORK, N. Y. CABLES: "ARLAB"

NC-200

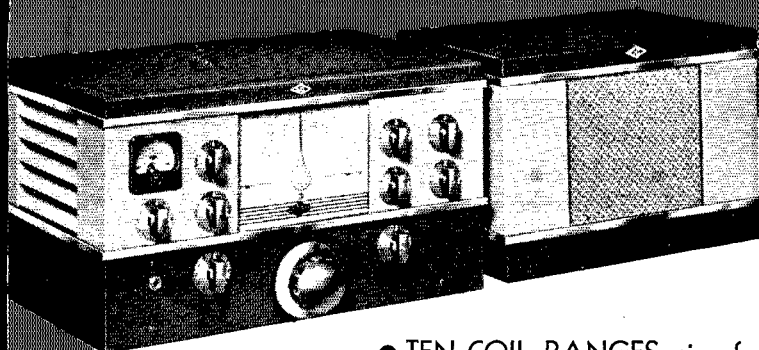

The Outstanding Amateur Receiver

- TEN COIL RANGES, six of which provide continuous coverage from 490 KC to 30 MC. Four separate, independent ranges provide extreme bandspread on the 10, 20, 40 and 80 meter bands.
- WIDE RANGE CRYSTAL FILTER with selectivity adjustable in six steps from 200 to 7600 cycles bandwidth.
- MOVABLE COIL TUNING SYSTEM which has proved its efficiency through many years of use in the NC-100 receivers.
- PORTABLE OR AC OPERATION by merely shifting plugs at the back of the receiver.
- LOW PRICE: only \$147.50 net, complete with 10" speaker in cabinet to match the receiver, with tubes and ready to run.

NATIONAL COMPANY, INC.

MALDEN, MASSACHUSETTS, U. S. A.

The Tops-in-Performance Receiver

- Two high-efficiency preselector stages with high gain on all ranges, resulting in outstanding signal-to-noise ratio.
- Precision worm-drive tuning condenser with micrometer dial. Extreme accuracy in calibration and in logging.
- Each coil set covers two amateur bands and the spectrum between. The higher frequency amateur band of each range, by a simple change-over operation may be "spread" to occupy 400 divisions of the 500 division precision dial.
- Frequency coverage available from 30 MC to as low as 50 KC.
- Net price of the HRO-C unit as illustrated \$259.50, complete with power supply, speaker, coil storage compartment, four coils covering from 30 MC to 1.7 MC and relay rack.

A technical bulletin covering completely all details of these receivers will be mailed on request

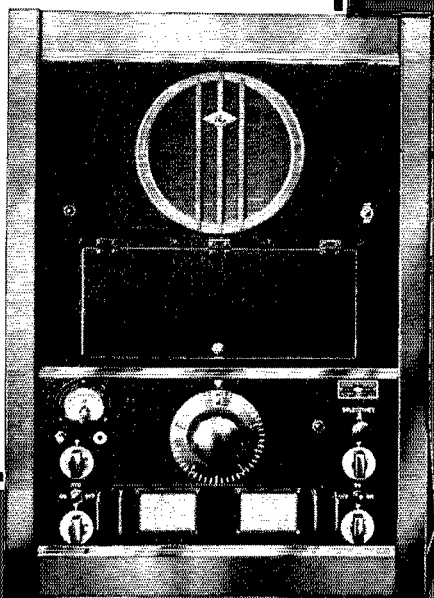

HRO

Real Power

**COSTS LESS
THESE DAYS...**

In a little over a year the RCA-812 has become one of the most widely used, most highly praised triodes in the entire amateur field. And no wonder!

Here is a tube that delivers real power in true big-league style at the rate of over 60 watts input per dollar. The only low-priced tube with the Zirconium-Coated anode, the RCA-812 gives you 170 watts output with only 6.5 watts of grid drive; or, if you want still higher power, two 812's in class C telegraph service will take a plate input up to 450 watts with the exceptionally low driving power of only 13 watts!

Equally important, the RCA-812 is built to stand the gaff. Its Zirconium-Coated anode, an RCA development, has exceptional heat-dissipating qualities and, in addition, functions as a highly effective getter. The tube will take heavy temporary overloads and come back for more. In brief, the 812 gives you just about all any amateur could ask for—at a price within easy reach of all.

RCA-812 Medium-Mu Triode (ICAS RATINGS)

Plate Voltage . . . 1500 V. max.
Plate Input 225 W. max.
Plate Dissipation . . 55 W. max.
Amplification factor 29
Amateur Net, \$3.50 each.

HIGH-MU RCA-811

Similar to the 812, the RCA-811 has the extremely high mu of 160. Like the 812, it is unexcelled as an r-f power amplifier, frequency doubler, class B modulator, or oscillator.

NEW RCA TT-100 Transmitting and Special-Purpose Tube Chart

Contains comprehensive characteristics, descriptions, etc. See your RCA Tube and Equipment Distributor or send 10c to the Commercial Engineering Section, RCA Manufacturing Co., Inc., Harrison, N. J.

W3HF's 812 R-F

Frank Fenimore of Carol P. Pa., gets outstanding results with a pair of 812's working either as buffer or as final in his 10-, 20-, and meter transmitters. RCA Transmitting Tubes are used exclusively at W3HF and include 807's, 806's, 810's, 812's, 866's and 872's.

