

SERVICE HINTS

BREAKDOWN OF BACKGROUND CONTROL

In sets prior to Run 6, the background control, R108, may fail because of transients or surges under certain operating conditions. When replacing this control, it is suggested that the circuit be rewired as shown in the drawing. This change was incorporated in production in Run 6.

REPLACING PICTURE TUBE

In sets prior to Run 6, when replacing the picture tube with one of a different type (7JP4, replacing 7GP4, or vice versa), it is desirable to change the second-anode voltage, to obtain optimum performance with minimum astigmatism.

For the 7JP4, best results are obtained with a second-anode voltage of +150v; connect the anode to the junction of R322 and R321.

For the 7GP4, best results are obtained with a second-

anode voltage of +250v; connect the anode to the junction of R100A and C103.

The astigmatic control, which was added in Run 6, is used to adjust the second-anode voltage of the picture tube. Whenever this tube is replaced, the control should be adjusted as directed below.

ADJUSTING ASTIGMATIC CONTROL

1. Tune in a station test pattern, preferably one having a wedge-type design.
2. Adjust the contrast and brilliance controls to produce a bright picture, just below "blooming."
3. Adjust the focus control for picture sharpness in one plane, either vertical or horizontal.
4. Adjust the astigmatic control for picture sharpness in the opposite plane.
5. Readjust the focus control.

PRODUCTION CHANGES

Run. No.	Description of Change	New or Added Part No.	Old or Removed Part No.	Reason for Change
1 to 4 inclusive	Changes in physical wiring. (Service Manual PR-1469 applies to Runs 1 to 4, inclusive.)			
5	Standoff for the 1B3GT was made longer. R535 (30,000 ohms) replaced by two 1/2-watt resistors in parallel: 47,000 ohms 150,000 ohms	54-7309-1 66-3473340* 66-4153340	54-7309 66-3333340*	Reduce high-voltage breakdown. Temporary shortage of properly rated resistor.
6	R107 changed to 100,000 ohms, and rewired as shown in drawing. Addition of: R110 (astigmatic control), 500,000 ohms R111, 100,000 ohms C106, .0047 mf. Wired as shown in drawing.	66-4103340 33-5539-18 66-4103340* 45-3502*	66-3223340	Improve background-control operation. Improve focus of picture tube with wide range of tube characteristics (7JP4 or 7GP4). See ADJUSTING ASTIGMATIC CONTROL.

PRODUCTION CHANGES, MODEL 48-700

ADDITIONS TO PARTS LIST

SECTION 1

Reference Symbol	Description	Service Part No.
C106	Condenser, by-pass, .0047 mf.	45-3502*
R110	Resistor, astigmatic control, 500,000 ohms	33-5539-18
R111	Resistor, series, 100,000 ohms	66-4103340*

CORRECTIONS TO PARTS LIST

SECTION 1

C100 should be Condenser, oil-filled, 3-section.

SECTION 3

C316, a-g-c filter condenser, should be 22 mmf., Part No. 62-022009001.

SECTION 5

C515, condenser, coupling, 820 mmf., Part No. 60-10825404, should be Part No. 60-10825401.

L500, choke, 60 millihenries, Part No. 32-4256, should be Part No. 32-4284.

MISCELLANEOUS

Baffle, wood and cloth, Part No. 406862, should be Part No. 40-6862.

Oscillator-and-mixer contact panel (4 connections), Part No. 76-2678, was changed to a kit including mounting rivets, Part No. 45-9520.

Aerial and r-f contact panel (7 connections), Part No. 76-2664, was changed to a kit including mounting rivets, Part No. 45-9519.

CORRECTION TO SCHEMATIC

SECTION 1

Delete plus (+) from C100A, C100B, and C100C.

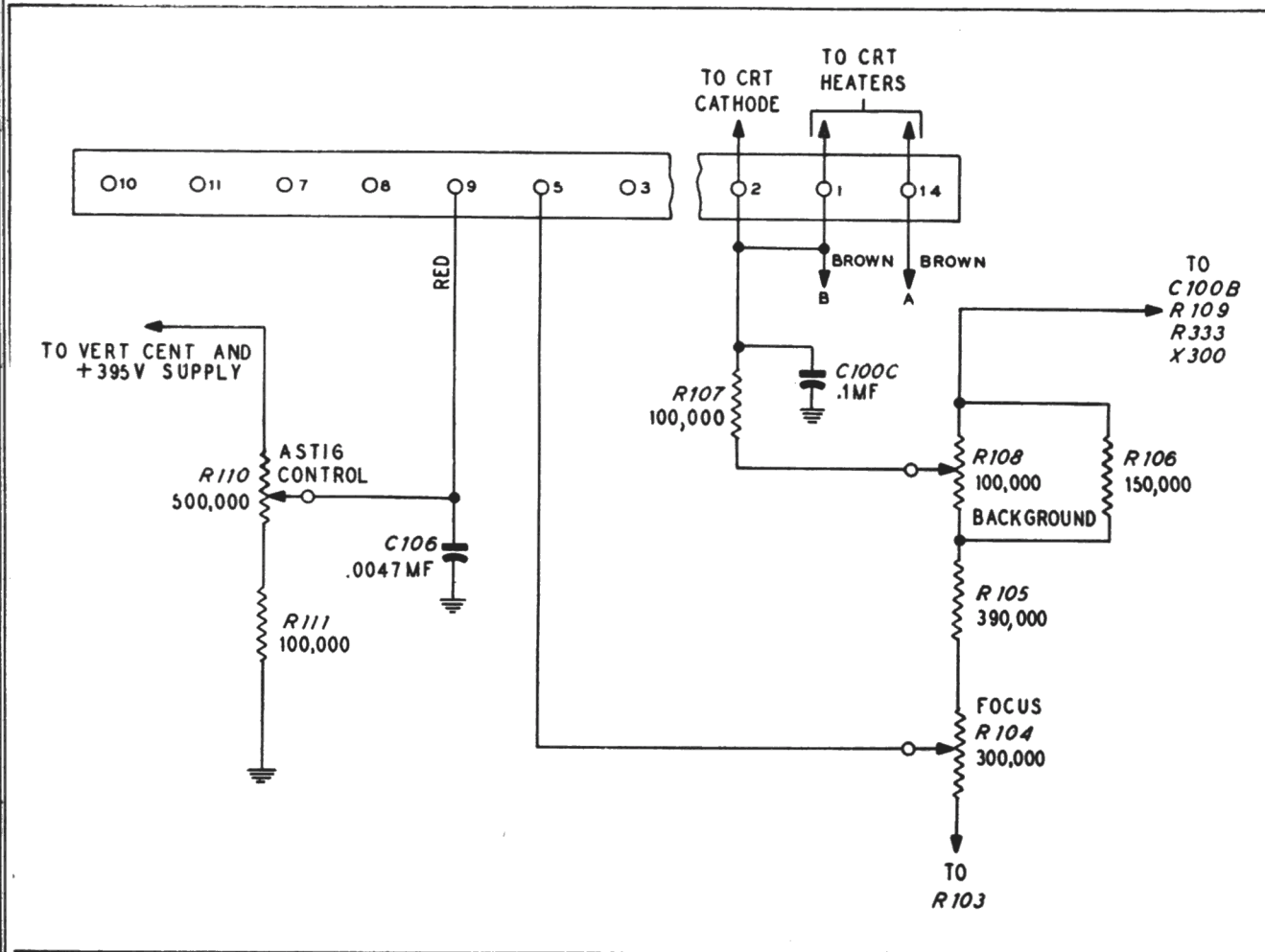

ADDITION OF ASTIGMATIC CONTROL, RUN 6

TP-5686

Vacuum Tubes (25)

LOKTAL	OCTAL	MINIATURE	CRT
1—7B4	1—1B3GT	6—6AG5	1—7GP4
2—7B5	1—5U4G	2—6AL5	or
1—7F8	2—6SL7GT	1—6J6	1—7JP4
2—7W7			
5—7C5			

TYPE	FUNCTION
1B3GT	High-voltage rectifier
5U4G	Low-voltage rectifier
6AG5	R-f amplifier
6AG5	Mixer
6AG5	Input i-f amplifier
6AG5	First video-i-f amplifier
6AG5	Second video-i-f amplifier
6AG5	First video amplifier
6AL5	Discriminator (FM detector and a.f.c)
6AL5	Video detector and a-g-c rectifier
6J6	Oscillator and oscillator control
6SL7GT	Vertical-sweep generator
6SL7GT	Horizontal-sweep generator
7B4	Audio amplifier
7B5	Audio output
7B5	Sync separator
7C5	Video output
7C5	Vertical-sweep output
7C5	Vertical-sweep output
7C5	Horizontal-sweep output
7C5	Horizontal-sweep output
7F8	Vertical-sync amplifier and horizontal-sync amplifier
7W7	First audio-i-f amplifier
7W7	Second audio-i-f amplifier
7GP4 or 7JP4	Picture tube

Philco Television Receiver Model 48-700 is a 25-tube, modern-style, mahogany-finish table model. This direct-view Receiver is designed to provide reception of television broadcasts on channels 1 through 13.

Channel Tuning

The Philco Precision Channel Selector provides for selection of any one of eight television channels, thereby covering all channels allotted to any locality. (The FCC has allotted a maximum of seven channels to any one locality.)

The use of Automatic Tuning with Electronic Control compensates for any undesirable changes in frequency, and eliminates the need for a fine-tuning control. Automatic Level Control of Picture and Sound overcomes fading of picture and sound.

Aerials

Provision for two aerials, one for the low-frequency television channels (1 to 6 inclusive), and one for the high-frequency channels (7 to 13 inclusive), using 300-ohm, balanced transmission line.

Audio

Audio output, 2.5 watts; 6-inch electrodynamic speaker with 3.2-ohm voice coil at 400 cycles; ratio-type FM detector.

Picture

Picture size, 5-3/4 x 4-3/8 inches; 7-inch picture tube with electrostatic deflection, using blocking-oscillator-type horizontal and vertical-sweep generators.

Intermediate Frequencies

Video carrier: 26.6 megacycles

Audio carrier: 22.1 megacycles

Electrical

Operating voltage: 110—120 volts, 60 cycles, a.c.; power consumption: 180 watts; power supplies (two): 395 volts at 200 ma., d.c.; negative 3450 volts at 2 ma., d.c.

Dimensions

Cabinet (outside): height, 14 inches; width 21-1/4 inches; depth, 18-3/4 inches.

Chassis (over-all): height, 9-1/2 inches; depth, 13-1/16 inches; width, 17-1/2 inches.

TELEVISION-AERIAL INFORMATION

A good aerial installation, with proper aerial adjustment and orientation, is required to secure the best possible performance from Model 48-700. Complete aerial-installation instructions are given in "Installation Instructions for Philco Television and FM Aerials," which is included with each aerial kit.

The following aerial kits and parts are available:

Philco Broad-Band Television Aerial Kit, Channels 1 through 6, Part No. 45-1563.

Reflector Kit for Broad-Band Television Aerial, Channels 1 through 6, Part No. 45-1564.

Philco Broad-Band Television Aerial Kit, Channels 7 through 13, Part No. 45-1561.

Reflector Kit for Broad-Band Television Aerial, Channels 7 through 13, Part No. 45-1562.

Philco 8-Foot Guyed Aerial Mast Kit, Part No. 45-1560.

Philco Aerial Mast Mounting Bracket Kit, Part No. 45-1551-1 (for wall mounting).

Sloping Roof Mast Mounting Bracket, Part No. 28-3757-1.

Peaked Roof Mast Mounting Bracket, Part No. 28-3758-1.

Philco 12-Foot Self-Supporting Mast Kit, Part No. 45-1569.

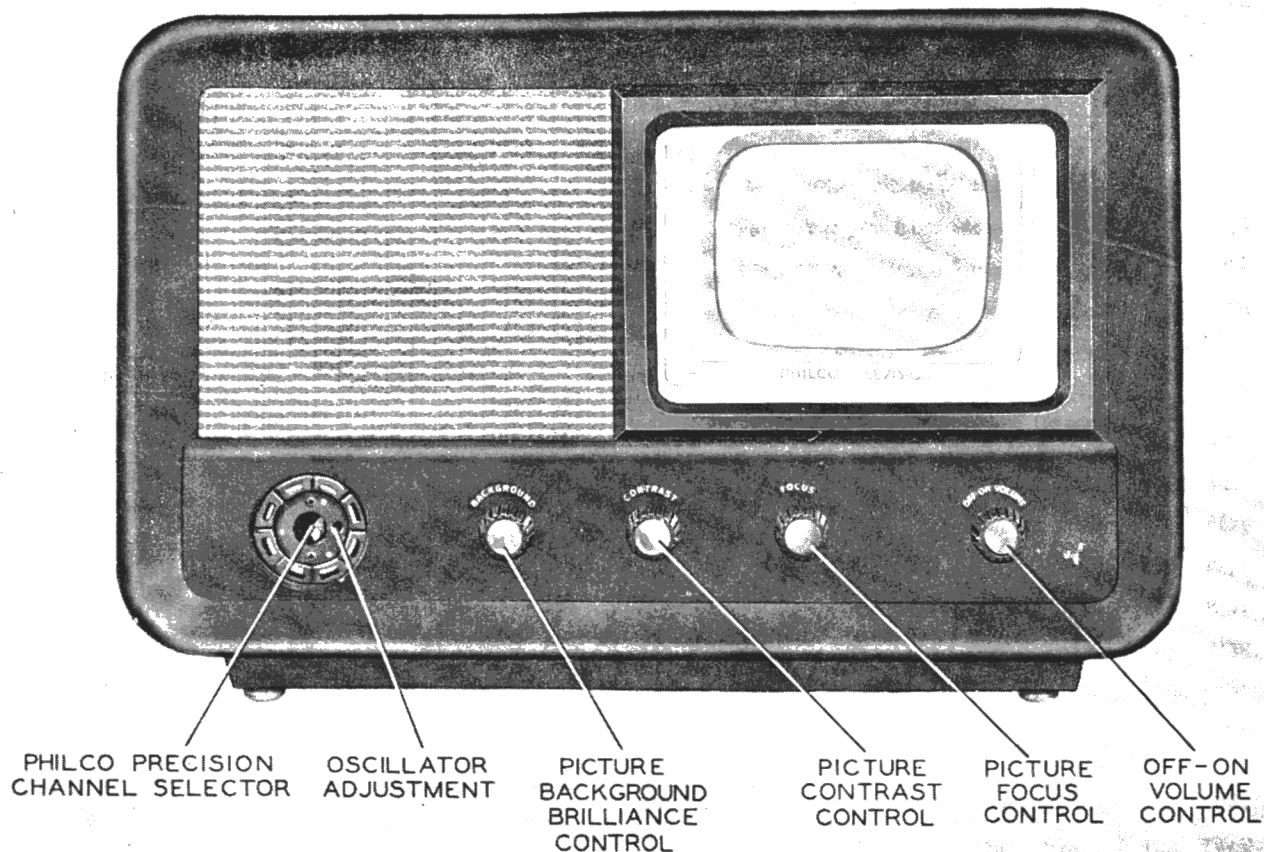

FIGURE 1. MODEL 48-700, FRONT VIEW, SHOWING CONTROLS.

TP-500

ELECTRICAL-CONTROL FUNCTIONS

A number of controls and adjustments are located on the front, rear, and top of the chassis. The operating instructions furnished with each Receiver explains the use of the controls which are to be operated by the owner. All of the controls are adjusted by the serviceman at the time of installation, or while he is testing and aligning the Receiver. Figure 1 shows the front-panel controls, figure 2 indicates the adjustments on the rear of the chassis, and figure 3 shows the chassis mounted in the cabinet. The adjustments on top of the chassis are shown in figure 34. The reference symbol and function of each control and adjustment is given in the following chart:

CONTROL	REFERENCE SYMBOL	FUNCTION
Philco Precision Channel Selector	Z400 Z401	Eight-position rotary turret; connects proper aerial, and r-f, mixer, and oscillator coils for the television channel selected.
OFF-ON VOLUME	S101 R216	Line switch; operated by turning shaft of VOLUME control in clockwise direction from OFF position. VOLUME control adjusts input voltage to audio-amplifier stages.
BACKGROUND	R108	Sets bias level of picture tube. Adjust together with CONTRAST control for pleasing picture. See figure 4.
CONTRAST	R326	Adjusts cathode bias of video-output tube to control output level of video signal. This control primarily determines range of gray shades in picture; however, together with BACKGROUND control, it also determines sharpness (focusing) of picture. Adjust both controls alternately until pleasing picture is obtained. See figure 5.
FOCUS	R104	Determines d-c voltage applied to focusing anode of picture tube. Adjust for best over-all picture clarity. See figure 6.
VERT. HOLD	R518	Controls frequency of vertical-sweep generator. Adjust to center of range over which picture remains vertically stationary. See figure 7.
HORIZ. HOLD	R534	Controls frequency of horizontal-sweep generator. Adjust to center of range over which picture remains horizontally stationary. See figure 8.
HEIGHT	R514	Controls vertical-sweep amplitude. Adjust so that picture fills screen vertically. See figure 9.
WIDTH	R539	Controls horizontal-sweep amplitude. Adjust so that picture fills screen horizontally. See figure 10.
VERT. CENT.	R525	Controls d-c voltage applied to vertical-deflection plates. Adjust for vertically centered picture. See figure 11.
HORIZ. CENT.	R546	Controls d-c voltage applied to horizontal-deflection plates. Adjust for horizontally centered picture. See figure 12.
VERT. LIN.	R523	Controls amount of feedback to vertical-sweep output tubes. Adjust for vertically symmetrical pattern. See figure 13.
HORIZ. LIN.	R545	Controls amount of feedback to horizontal-sweep output tubes. Adjust for horizontally symmetrical pattern. See figure 14.
Oscillator-core Adjustment	L400A	Adjusts oscillator coil for correct inductance. See Alignment Procedure, page 26.

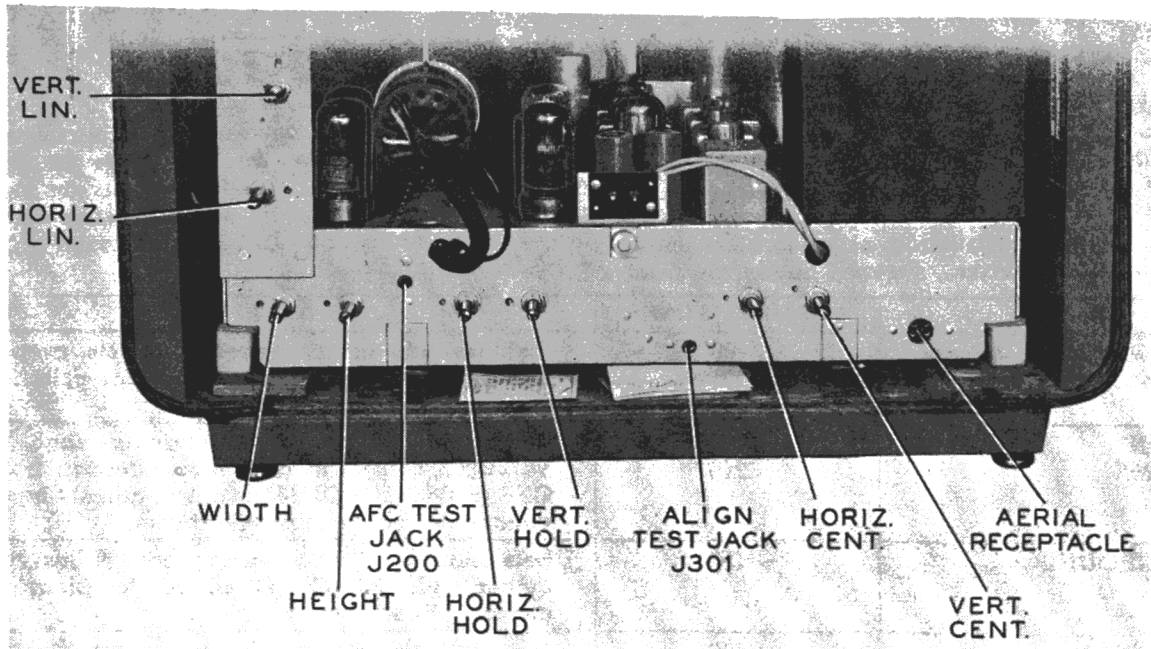

FIGURE 2. MODEL 48-700, REAR VIEW OF CHASSIS, SHOWING CONTROLS.

TP-5006

PICTURE TUBE CLIP PICTURE TUBE PICTURE TUBE BRACKET SPEAKER PLUG HIGH VOLTAGE DANGER POINT

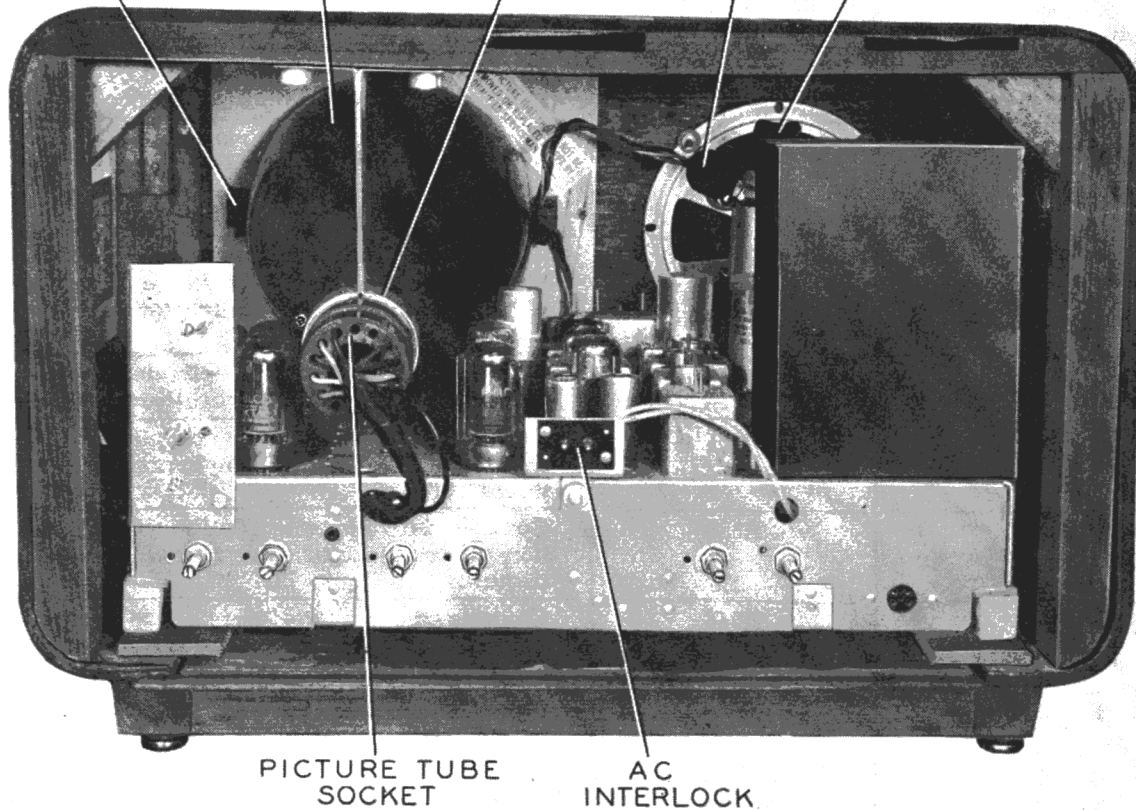
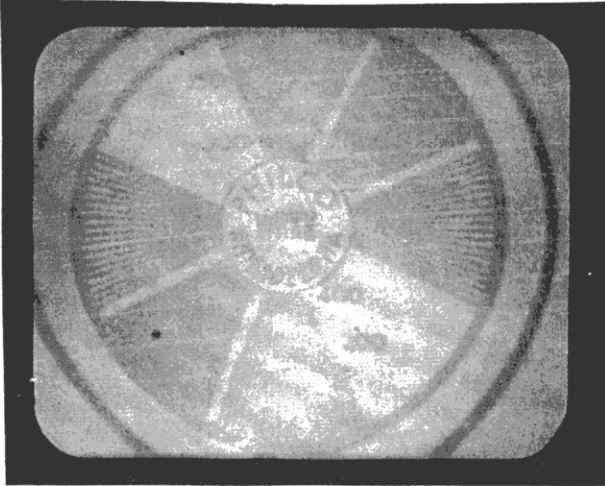

FIGURE 3. MODEL 48-700, REAR VIEW OF CABINET.

TP-5008A



TP-3812

FIGURE 4. BACKGROUND CONTROL REQUIRES ADJUSTMENT.

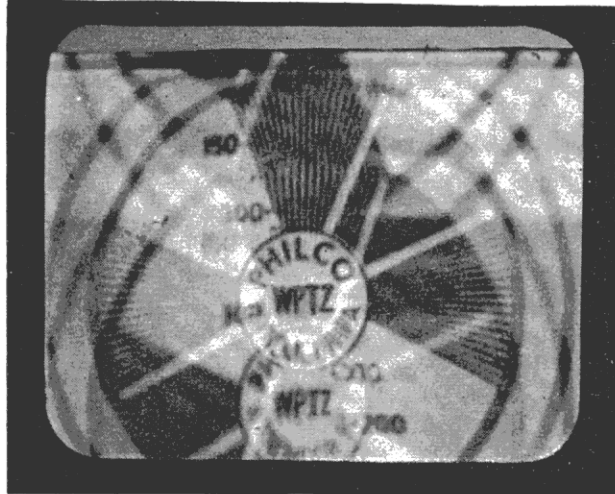

TP-3820

FIGURE 7. VERT. HOLD CONTROL REQUIRES ADJUSTMENT

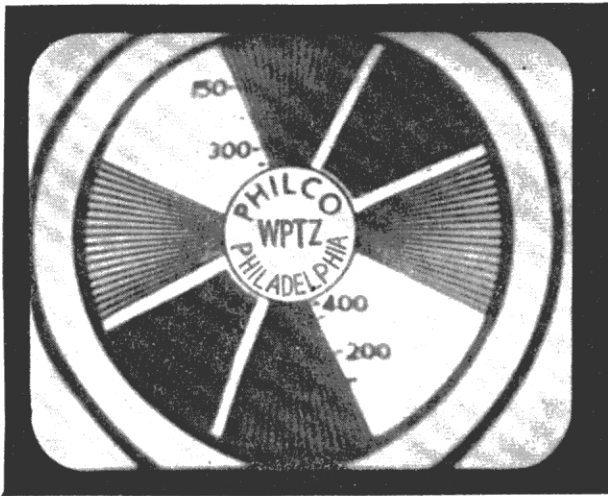

TP-3807

FIGURE 5. CONTRAST CONTROL REQUIRES ADJUSTMENT.

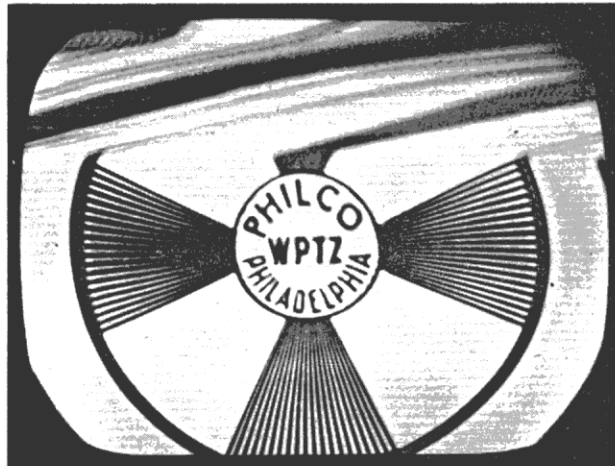

TP-4978

FIGURE 8. HORIZ. HOLD CONTROL REQUIRES ADJUSTMENT

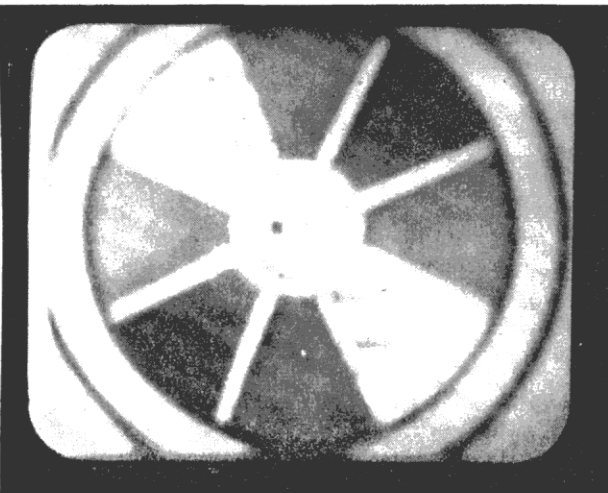

TP-3825

FIGURE 6. FOCUS CONTROL REQUIRES ADJUSTMENT.

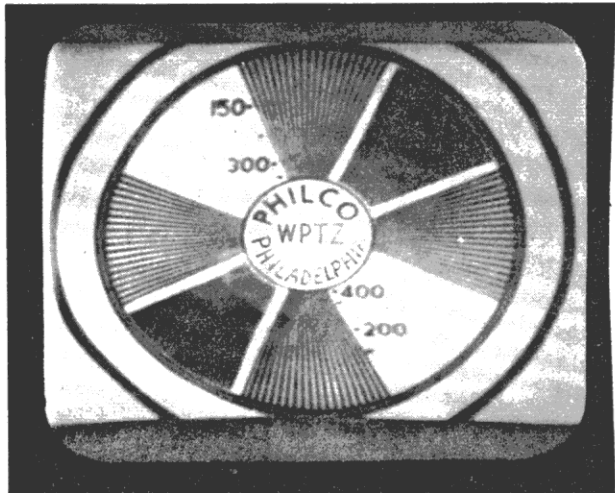

TP-3813

FIGURE 9. HEIGHT CONTROL REQUIRES ADJUSTMENT.

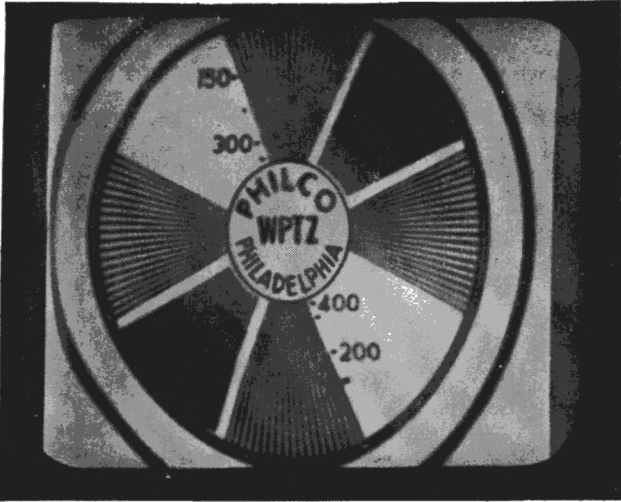

TP-3814

FIGURE 10. WIDTH CONTROL REQUIRES ADJUSTMENT.

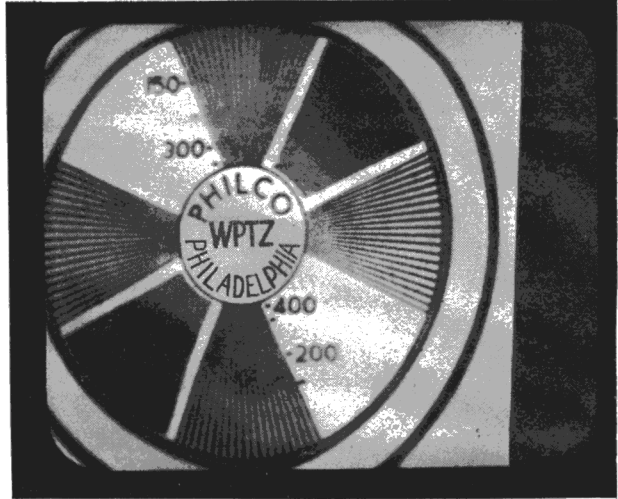

TP-382

FIGURE 12. HORIZ. CENT. CONTROL REQUIRES ADJUSTMENT.

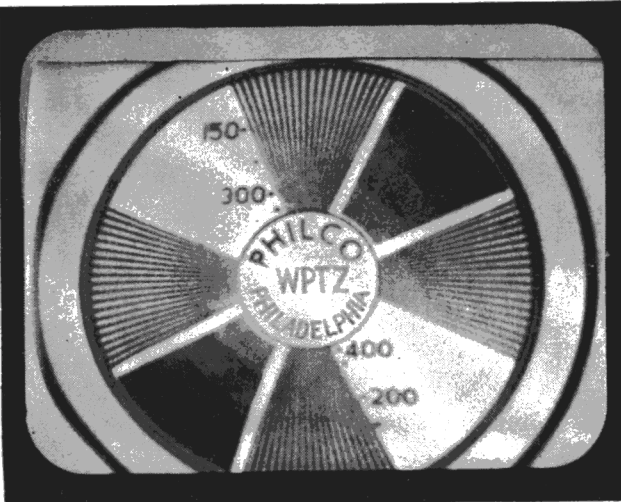

TP-3821

FIGURE 11. VERT. CENT. CONTROL REQUIRES ADJUSTMENT.

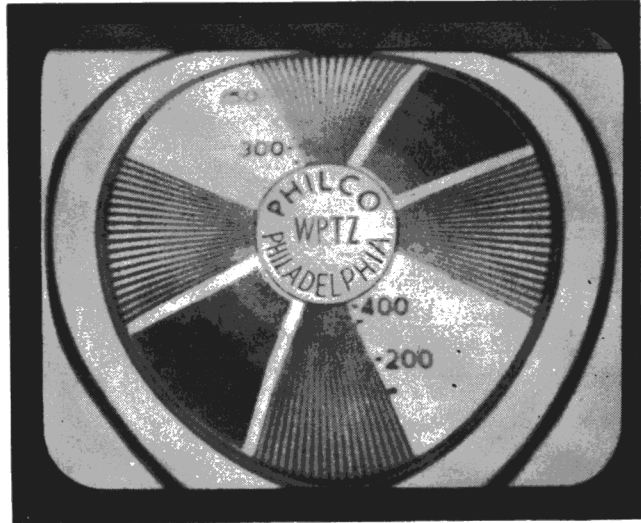

TP-3822

FIGURE 13. VERT. LIN. CONTROL REQUIRES ADJUSTMENT.

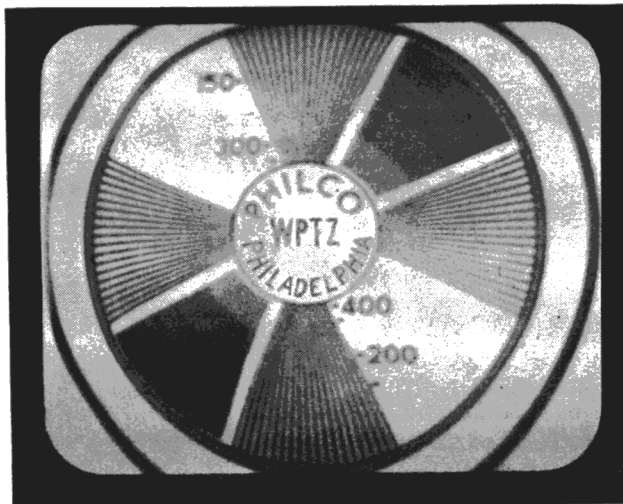

TP-3817

FIGURE 14. HORIZ. LIN. CONTROL REQUIRES ADJUSTMENT.

CIRCUIT DESCRIPTION

General

Philco Television Receiver Model 48-700 is designed for maximum sensitivity and selectivity consistent with the six-megacycle band width required for a television channel.

The Philco Precision Channel Selector employs snap-in coils so that the Receiver may be readily adapted to receive any eight of the thirteen television channels. Since the FCC limits any one area to a maximum of seven channels, the Receiver provides more than adequate selection of channels within any given area.

Provision is made for the use of two aeriels, one for the low-frequency band and the other for the high-frequency band. When the Philco Precision Channel Selector is set to the desired channel, the proper aerial, aerial coil, r-f coil, mixer coil, and oscillator coil are automatically selected. In special installations, as many as four aeriels may be used by a simple modification of the aerial input circuit. Instructions for this modification are included with each Philco television aerial kit.

The use of Automatic Tuning with Electronic Control (automatic frequency control) insures that the Receiver is properly tuned at all times for the maximum clarity of the picture and sound. The use of Automatic Level Control of Picture and Sound (automatic gain control) prevents fading of the picture and sound.

The schematic diagram of the complete Receiver, shown in figure 33, is divided into five sections: the Radio-Frequency Section, the Video Section, the Audio Section, the Sweep Section, and the Power-Supply Section. The interrelation of circuit functions for these sections is shown clearly in the block diagram, figure 15.

Radio-Frequency Section

The entire radio-frequency assembly is mounted on a sub-chassis, which is mounted on the main chassis. The Philco Precision Channel Selector is divided into two compartments, Z400 and Z401. Z400 contains the oscillator and mixer coils, and Z401 contains the r-f

and aerial coils. The r-f coil and the aerial coil for each channel are wound on the same snap-in coil form, and the two coils are inductively coupled. Condenser C401B is used only on those channels for which the capacitance of C412 is too small to tune the circuit properly. Trimmer condensers C410 and C412 tune the Receiver input, and are adjusted properly at the factory. (Special test equipment must be used for the proper adjustment of C410 and C412. If these adjustments are disturbed, the picture signal will be clipped and distorted.)

The output of the 6AG5 r-f amplifier is impedance-coupled to the 6AG5 mixer. The mixer coil and the oscillator coil for each channel are also wound on the same snap-in coil form, and these two coils are inductively coupled on channels 1 through 6, and are capacitively coupled on channels 7 through 13, to provide the proper amount of oscillator-injection voltage. A Colpitts-type oscillator, employing one section of a 6J6 dual triode, is shunted by a reactance tube (osc. control), which employs the other section of the 6J6. The reactance tube is controlled by a d-c voltage obtained from the output of the discriminator. When a positive voltage is applied to the grid of the reactance tube, the oscillator frequency is decreased; conversely, when a negative voltage is applied, the oscillator frequency is increased. Since the output of the discriminator, at the point from which the control voltage is taken, varies in polarity from a negative maximum through zero to a positive maximum in accordance with the frequency of the signal, any change in the oscillator frequency changes the frequency of the audio i.f. and produces a correction voltage. In this manner, the oscillator is maintained constantly at the correct frequency, and a maximum of stability is obtained, regardless of the aging of tubes, changes in component values, and input-signal drift.

The output of the mixer is applied to the input-i-f impedance coupler Z300. The various frequencies existing in the Receiver for each channel when the oscillator coil for each channel has been correctly adjusted is given in the following chart:

CHANNEL NO.	BAND (mc.)	VIDEO-CARRIER FREQUENCY (mc.)	AUDIO-CARRIER FREQUENCY (mc.)	LOCAL-OSC. FREQUENCY (mc.)	VIDEO I.F. (mc.)	AUDIO I.F. (mc.)	ADJACENT-AUDIO I.F. (mc.)
1	44—50	45.25	49.75	71.85	26.6	22.1	None
2	54—60	55.25	59.75	81.85	26.6	22.1	32.1
3	60—66	61.25	65.75	87.85	26.6	22.1	28.1*
4	66—72	67.25	71.75	93.85	26.6	22.1	28.1*
5	76—82	77.25	81.75	103.85	26.6	22.1	32.1
6	82—88	83.25	87.75	109.85	26.6	22.1	28.1*

CHANNEL NO.	BAND (mc.)	VIDEO-CARRIER FREQUENCY (mc.)	AUDIO-CARRIER FREQUENCY (mc.)	LOCAL-OSC. FREQUENCY (mc.)	VIDEO I.F. (mc.)	AUDIO I.F. (mc.)	ADJACENT-AUDIO I.F. (mc.)
7	174—180	175.25	179.75	201.85	26.6	22.1	None
8	180—186	181.25	185.75	207.85	26.6	22.1	28.1*
9	186—192	187.25	191.75	213.85	26.6	22.1	28.1*
10	192—198	193.25	197.75	219.85	26.6	22.1	28.1*
11	198—204	199.25	203.75	225.85	26.6	22.1	28.1*
12	204—210	205.25	209.75	231.85	26.6	22.1	28.1*
13	210—216	211.25	215.75	237.85	26.6	22.1	28.1*

* Adjacent-channel audio-i-f signal falls within the Receiver band pass, and is rejected by the adjacent-channel-sound trap.

Video Section

The intermediate-frequency signals present in the plate circuit of the mixer are transferred by impedance coupler Z300 to the grid of the 6AG5 input i-f amplifier and amplified. The plate and grid windings of the first video-i-f impedance coupler Z301 are tuned to accept the video-i-f signal (26.6 mc.), while the sound trap L301B is adjusted to reject the audio-i-f signal (22.1 mc.); thus very little, if any, of the audio-i-f signal remains in the video section. Since the plate supply to the input i-f amplifier is connected through the first audio-i-f transformer Z200, the audio-i-f signal is transferred to the first audio-i-f stage.

The video-i-f signal is amplified by the 6AG5 first video-i-f amplifier, and passed through the second video-i-f impedance coupler Z302. This coupler is tuned to a frequency slightly different from that of Z301 to achieve the desired band pass. The adjacent-channel-sound trap L302B is tuned to the adjacent-channel audio-i-f signal (28.1 mc.), and offers a high impedance to the adjacent-channel audio-i-f signal, if present. (Because of channel allocation, the adjacent-channel sound appears on some channels as a 32-mc. i.f. Since this frequency is not within the band pass of the Receiver, no interference results.) The amplified video-i-f signal is transferred by the third video-i-f impedance coupler Z303, which is tuned to a frequency slightly different from that of Z302 or Z301, to the video detector. The video detector, consisting of one section of a 6AL5 dual-diode, rectifies the negative portion of the video-i-f signal. The resultant video signal is then amplified by the 6AG5 first video amplifier and the 7C5 video output tube, and is applied to the grid of the picture tube. The amplitude of this signal is controlled by the CONTRAST control R326, which varies the bias on the video output tube. High and low-frequency compensation is employed to provide a video response

from approximately 30 cycles to 4 mc. D-c restoration by means of a 1N34 crystal establishes a d-c bias level according to the picture content of the signal on the grid of the picture tube, thus insuring that the picture brightness changes only with each change of scene — not with each frame.

Automatic Control of Picture and Sound is achieved by means of an a-g-c circuit which is controlled by a voltage obtained by rectifying the sync tips. Since the sync tips are always at the same modulation level but vary in amplitude with the strength of the signal, they are a suitable reference for a-g-c. One half-section of the video-detector diode is used to rectify the sync tips. Enough a-g-c voltage is available at all times to regulate the gain of the r-f amplifier, the input i-f amplifier, and the first video-i-f amplifier, so that any change in the strength of the incoming signal is compensated for by a change in the gain of these stages.

Audio Section

The audio section employs two audio-i-f stages (tuned to the accompanying-sound frequency of 22.1 mc.), a discriminator, and two stages of audio amplification. The audio section can supply an undistorted output of approximately 2.5 watts to the 6-inch electrodynamic loud-speaker.

The discriminator is an improved FM detector of the ratio type. The band width of this discriminator is approximately 500 kc., to permit high-quality FM reception. The output of the discriminator is connected to the a-f-c test jack for test purposes, and is also connected through a two-section r-c filter to the grid of the oscillator-control tube to supply a voltage for controlling the oscillator frequency, as described in the discussion of the RADIO-FREQUENCY SECTION.

Sweep Section

A portion of the video signal is taken from the screen of the 7B5 sync-separator tube, so that the synchronizing and equalizing pulses, which must be used to control the recurrence rate of the horizontal and vertical-sweep generators, may be separated from the video signal. The sync-separator-tube potentials are such that the video portion of the composite video signal applied to its input circuit is insufficient to operate the tube, and only the "blacker-than-black" portion of the video signal is passed. This blacker-than-black portion contains the horizontal and vertical-synchronizing pulses and the equalizing pulses, each type of pulse differing greatly in duration and recurrence rate from the others. The output of the sync separator is applied to the 7F8 vertical-sync and horizontal-sync amplifiers through separate r-c coupling circuits, each circuit having a different time constant.

C502 and R506 form a long-time-constant circuit, which accepts both vertical and horizontal-synchronizing pulses and applies them to the vertical-sync-amplifier grid. These signals are amplified and applied to an

integrating network consisting of C504 and C505, and then to the vertical-sweep-generator grid. The horizontal-sync pulses, being of short duration, have little effect on the voltage build-up in the integrating network, whereas the long, serrated, vertical-sync pulses have a maximum effect; thus they trigger the vertical-sweep generator (which is also a blocking oscillator) in synchronism with the vertical-sweep pulses, which occur at a rate of 60 c.p.s. The output of the vertical-sweep generator is applied to the grid of vertical-sweep output tube No. 1, which operates in push-pull with vertical-sweep output tube No. 2. A portion of the output voltage from vertical-sweep output tube No. 1 is used to drive vertical-sweep output tube No. 2. Two output voltages of the proper saw-tooth wave shape but of opposite polarity are coupled to the vertical-deflection plates of the picture tube. The HEIGHT control R514 determines the amplitude of the input voltage to the vertical-sweep output tubes, and is adjusted for the desired picture height. The VERT. LIN. control R523 determines the amount of voltage fed back to, and in phase with the input of the vertical-sweep output tubes, to control the linearity of the vertical sweep. Vertical centering is achieved by the VERT.

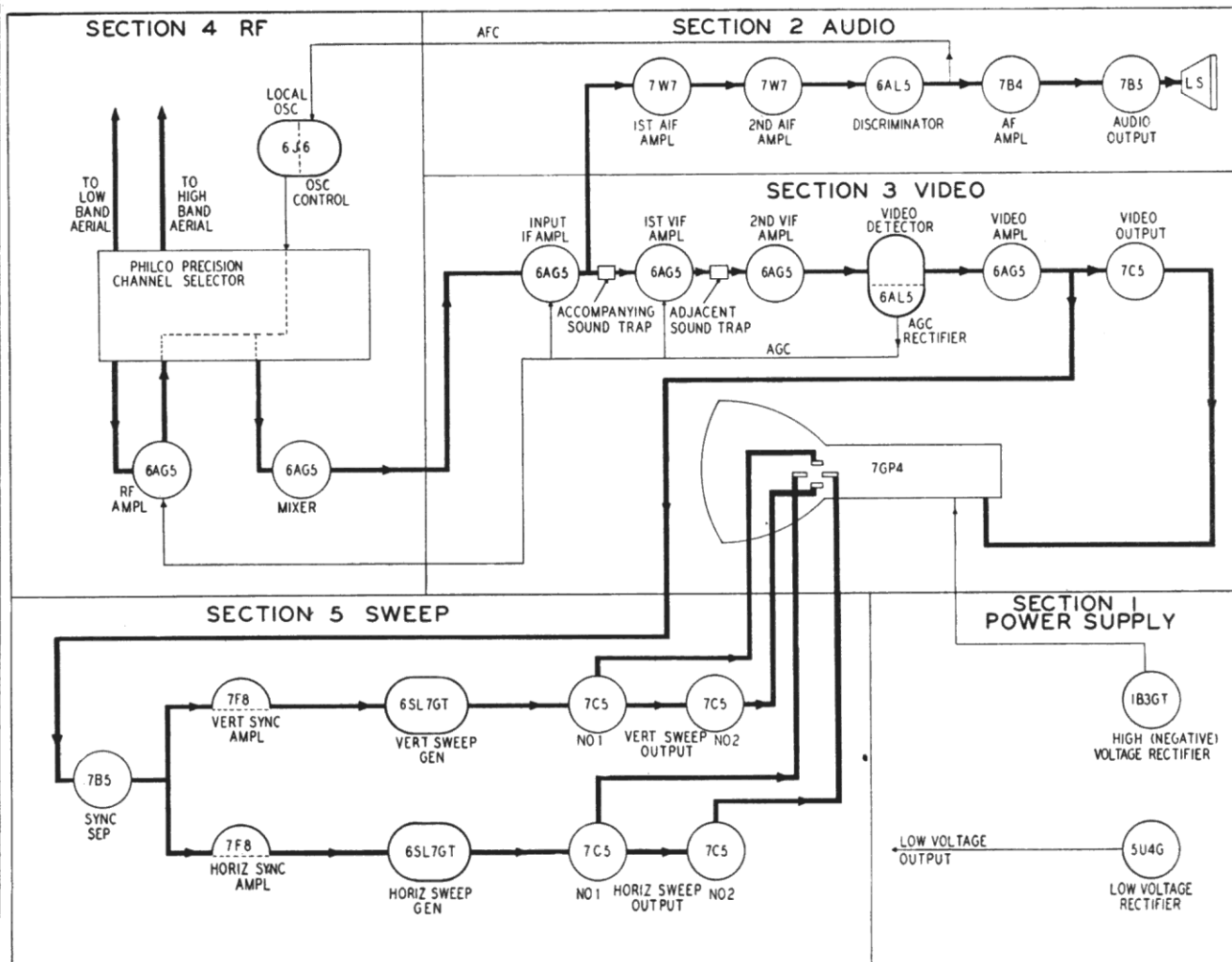

FIGURE 15. MODEL 48-700, BLOCK DIAGRAM.

TP-4736F

CENT. control R525, which varies the d-c voltage applied to the vertical-deflection plates of the picture tube to deflect the beam up or down, as required for proper centering of the picture.

C513 and R527 form a differentiating network which changes the short-time horizontal-synchronizing pulses to sharp negative pips. These pips are amplified and inverted by the horizontal-sync amplifier and are applied to the grid of the 6SL7GT horizontal-sweep generator.

Since the horizontal sweep is much faster than the vertical sweep, certain circuit components are required in the horizontal-sweep-generator circuit which are not needed in the vertical-sweep-generator circuit. The plate circuit of the horizontal-sweep-generator tube contains a tuned circuit consisting of L500 and C518, which is resonant at a frequency of approximately 15,000 c.p.s. The positive sync pulse at the first grid (pin 4) triggers the blocking oscillator. During the positive swing of the grid, the plate current of the first section of the tube increases rapidly. When the grid voltage falls sharply to its maximum negative peak (see figure 26), due to the feedback developed in the transformer, the plate current is abruptly cut off. The sudden stopping of the plate-current flow shock excites the tuned circuit, causing it to oscillate and produce a voltage at its resonant frequency. This sine-wave voltage is combined, at the second cathode (pin 3) of the horizontal-sweep-generator, with the negative pulse from the first plate (pin 5). See figure 29. The frequency of the resonant circuit, in conjunction with the generator-circuit time constant, determined by the setting of the HORIZ. HOLD control R534, sets the frequency of the horizontal-sweep generator. The stabilization produced by the tuned circuit reduces the effect of noise on the horizontal sweep. The output of the horizontal-sweep-generator is applied to the grid of horizontal-sweep output tube No. 1, which operates in push-pull with horizontal-sweep output tube No. 2. A portion of the output voltage from horizontal-sweep output tube No. 1 is used to drive horizontal-sweep output tube No. 2. Two output voltages of the proper saw-tooth shape but of opposite polarity are coupled from the horizontal-sweep output stage to the horizontal-deflection plates of the picture tube. The WIDTH control R539 adjusts the bias applied to horizontal-sweep output tube No. 1, thus increasing or decreasing the amplitude of the sawtooth voltage applied to the horizontal-deflection plates. The HORIZ. LIN. control R545 determines the amount of voltage fed back to, and in phase with the input of the horizontal-sweep output tubes, to control the linearity of the horizontal sweep.

Horizontal centering is controlled by HORIZ. CENT. control R546, which varies the d-c voltage applied to the horizontal-deflection plates of the picture tube to deflect the beam to the left or right, as required for proper centering of the picture. Focusing is achieved by FOCUS control R104 which varies the d-c voltage applied to the first anode of the picture tube.

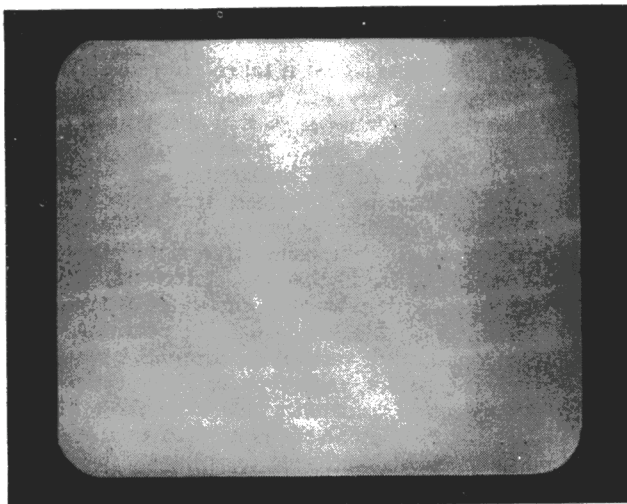

TP-4200

FIGURE 16. NO VIDEO SIGNAL (RASTER ONLY).

Power-Supply Section

The power-supply section contains two power supplies; one is a low-voltage high-current supply for the Receiver circuits, and the other is a negative high-voltage low-current supply for the picture tube.

The low-voltage supply employs a 5U4G tube in a full-wave rectifier circuit, the output of which is filtered by a low-pass filter.

The negative high-voltage supply uses a 1B3GT tube in a half-wave rectifier circuit, the output of which is filtered by a low-pass filter. A bank of series resistors make up the bleeder network, which supplies voltages for the FOCUS and BACKGROUND controls and the picture-tube bias.

A safeguard is provided by an interlock which disconnects the primary a-c voltage when the back of the Receiver is removed.

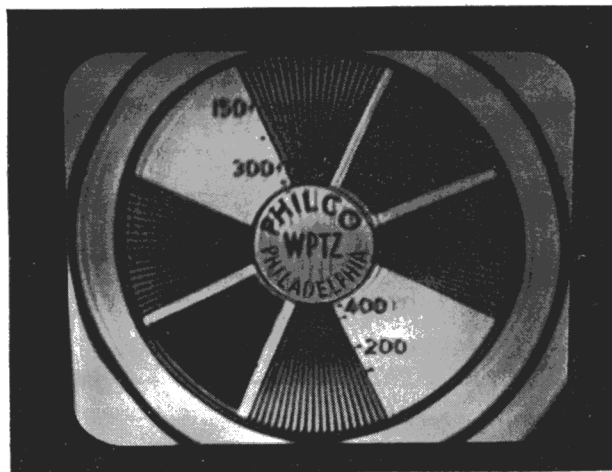

TP-4205

FIGURE 17. REFLECTIONS (GHOSTS).

TROUBLE-SHOOTING PROCEDURE FOR TELEVISION RECEIVERS

First, localization of the trouble to a functional section, or block of circuits.

Second, isolation of the faulty circuit, or stage, within that section.

Third, location of the defective part within that circuit.

The receiver circuit is divided into five functional sections, or blocks of circuits, as follows:

Section 1—the power-supply circuits

Section 2—the audio circuits

Section 3—the video circuits

Section 4—the r-f circuits

Section 5—the sweep circuits

In the Philco trouble-shooting procedure, localization of the trouble to a functional section is accomplished, if possible, by the OPERATIONAL CHECK. Charts are given to help the serviceman make this check quickly and accurately. Practically all of the troubles which occur in a television receiver cause abnormal indications on the screen or from the speaker, or both. By simply looking and listening, the serviceman often can localize the trouble to a block of circuits immediately, without needless testing.

If the trouble cannot be localized by the OPERATIONAL CHECK, it can be localized by the TEST-

POINT ANALYSIS. To aid in this analysis, the parts in the schematic diagram, base layouts, and replacement parts list are symbolized according to the section numbers, and a trouble-shooting chart is given for each section. Each sectional chart refers to one or more "major" test points (numbers within stars) and a subordinate group of "key" test points (letters within circles), which are indicated on the schematic diagram and base layout. A few tests at the "major" test points throughout the receiver, as directed in the trouble-shooting charts, will definitely localize the trouble to a particular section, and eliminate other sections from suspicion.

After the trouble has been localized to a section, either by the OPERATIONAL CHECK or by the TEST-POINT ANALYSIS, a few additional tests at the "key" test points, specified in the chart for that section, will isolate the faulty circuit. The defective part can then be located by testing tubes, by simple voltage and resistance measurements, by substitution of parts, or, in some circuits, by waveform checks. Trouble revealed by any test should be corrected before testing further.

IMPORTANT!

To insure proper operation, all repairs should be made using exact replacement parts, and the new part should be located in the exact position from which the original part was removed. If it is necessary to temporarily move other parts or wiring to make the repair, be sure to dress the parts and wiring back to their original positions after the repair has been made.

OPERATIONAL CHECK

NOTE: Do not make an operational check if the complaint indicates that the Receiver cannot be turned on without risk of further damage — proceed with the TEST-POINT ANALYSIS, page 16.

If the complaint indicates that the Receiver can be turned on without risk of further damage, turn on the Receiver and set the Philco Precision Channel Selector to receive a television station which is on the air. Either the picture or the sound, or both, may be unsatisfactory.

If both are unsatisfactory, apply a signal of the proper frequency from an AM signal generator to the aerial receptacle; this should produce audio output from the speaker and modulation bars on the screen. If both are satisfactory, check the aerial installation. If either the sound or modulation pattern, or both, are unsatisfactory, disconnect the signal generator and refer to the classified portions of the following charts.

SOUND PRESENT, BUT PICTURE MISSING

INDICATION	PROBABLE TROUBLE	REFERENCE
Only bright, horizontal line appears on picture tube.	Defective vertical-sweep circuits.	Refer to Section 5 trouble-shooting chart.
No picture, but sound is good, and raster appears. See figure 16.	Trouble in video circuits, except input i-f amplifier stage.	Refer to Section 3 trouble-shooting chart.
Sound good, but picture tube unlighted.	Defective high-voltage power supply or defective picture tube.	Refer to Section 1 and Section 3 trouble-shooting charts.

SOUND PRESENT, BUT PICTURE MISSING (Continued)

INDICATION	PROBABLE TROUBLE	REFERENCE
Only bright vertical line appears on picture tube.	Defective horizontal-sweep circuits.	Refer to Section 5 trouble-shooting chart.
Only bright spot appears on picture tube.	Defective horizontal and vertical-sweep circuits.	Refer to Section 5 trouble-shooting chart.

PICTURE PRESENT, BUT SOUND MISSING

Picture good, but no sound.	Trouble in audio circuits.	Refer to Section 2 trouble-shooting chart.
-----------------------------	----------------------------	--

BOTH PICTURE AND SOUND MISSING

No picture or sound, but raster appears. See figure 16.	Trouble in r-f circuits. Defective input i-f amplifier stage or a-g-c circuit.	Refer to Section 3 and Section 4 trouble-shooting charts.
No picture, sound, or raster.	Defective low-voltage power supply.	Refer to Section 1 trouble-shooting chart.

PICTURE NOT CLEAR

Sound and picture weak.	Weak r-f amplifier, oscillator, mixer, or input-i-f amplifier tube. Defective aerial. Defective a-g-c circuit.	Refer to Section 3 and Section 4 trouble-shooting charts. Check aerial.
Picture too dark (CONTRAST and BACKGROUND controls properly adjusted).	Defective a-g-c circuit.	Refer to Section 3 trouble-shooting chart.
Flashes in raster with aerial disconnected.	High-voltage power supply arcing (corona discharge).	Refer to Section 1 and Section 3 trouble-shooting charts. Check lead dress of high-voltage circuit.
Multiple images (ghosts) appear. See figure 17.	Defective aerial installation, or incorrect orientation of aerial. Standing waves on transmission line.	Check aerial and transmission line.
Insufficient contrast in picture (CONTRAST control properly adjusted). See figure 5.	Insufficient gain in video circuits, or defective picture tube.	Refer to Section 3 trouble-shooting chart.
Sound in picture (horizontal bars following modulation). See figure 19.	Microphonic tubes, L301B (accompanying-sound trap) incorrectly adjusted, or oscillator-core adjustment incorrectly set.	Refer to alignment chart, page 27.
Picture lacks sharpness of detail.	Defective FOCUS control. Defective picture tube. Trouble in r-f or video circuits.	Refer to Section 1, Section 3, and Section 4 trouble-shooting charts and to alignment charts.
Picture lacks detail (FOCUS control properly adjusted).	Misalignment of Receiver, or defective aerial system.	Refer to alignment chart, page 27. Check aerial system.
Picture background unstable.	Trouble in d-c restorer.	Refer to "D-C RESTORATION CHECK," page 29.
Beat pattern (fine, weaving, meshed lines).	Interference from short-wave transmitter. Misalignment of Receiver. Improperly adjusted oscillator coil L400A.	Check aerial orientation and installation. Refer to alignment chart, page 27. Refer to Installation Instructions for Philco Television Receiver Model 48-700, PR-1468.

PHILCO CORP.

PICTURE DOES NOT REMAIN STATIONARY

INDICATION	PROBABLE TROUBLE	REFERENCE
Picture will not sync vertically and horizontally. See figures 7 and 8.	Defective sync-separator tube or associated circuit, or weak signal with high noise level.	Refer to Section 5 trouble-shooting chart.
Picture will not sync vertically. See figure 7.	Defective vertical-sync-amplifier or vertical-sweep-generator tube, or associated circuits.	Refer to Section 5 trouble-shooting chart.
Picture will not sync horizontally. See figure 8.	Defective horizontal-sync-amplifier or horizontal-sweep-generator tube, or associated circuits.	Refer to Section 5 trouble-shooting chart.

IMPROPER PICTURE SIZE

WIDTH control will not reduce width of raster.	Defective WIDTH control or associated circuit, or low anode voltage.	Refer to Section 1 and Section 5 trouble-shooting charts.
Raster too small, either vertically or horizontally (HEIGHT and WIDTH controls properly adjusted). See figures 9 and 10.	Low output from low-voltage power supply. Weak or defective vertical or horizontal-sweep-output tube, or insufficient drive for output tubes. Defective WIDTH or HEIGHT control circuits.	Refer to Section 1 and Section 5 trouble-shooting charts.

RECEIVER DOES NOT OPERATE ON ALL CHANNELS

Trouble on one channel only (stations received on other channels).	Improper adjustment of oscillator for defective channel, or open oscillator or r-f coil.	For oscillator adjustment, refer to "Installation Instructions for Philco Television Receiver Model 48-700," PR-1468. Refer to Section 4 trouble-shooting chart.
--	--	--

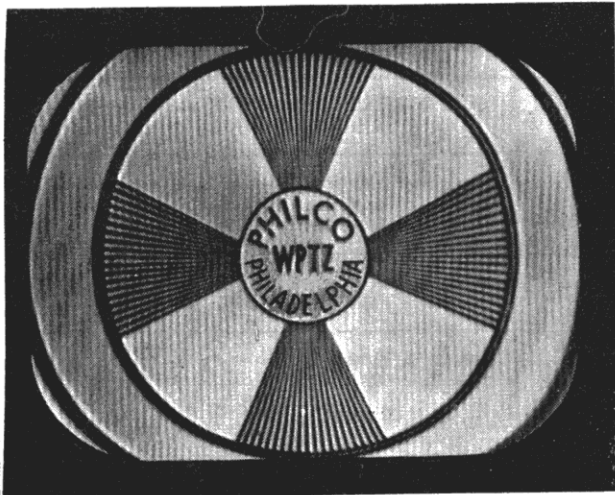

TP-1005

FIGURE 18. BEAT PATTERN.

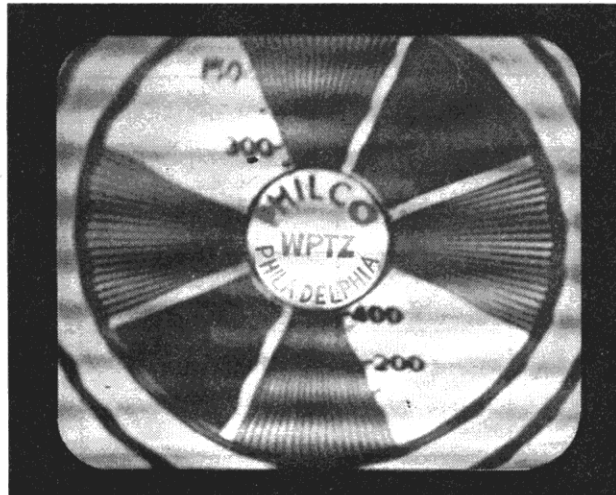

TP-4191

FIGURE 19. SOUND IN PICTURE.

TEST-POINT ANALYSIS

Preliminary Check

Remove the Receiver chassis from the cabinet and carefully inspect it for evidence of burnt or overheated parts, tubes broken or loose in sockets, broken or loose connections, defective insulation, or other indication of trouble. If any indications of trouble are found, locate the cause of the trouble before replacing the damaged part.

After the inspection has been made, and any necessary repairs have been completed, connect the Receiver for operation on the bench, using the speaker and picture tube from the set being repaired.

Test Equipment Required for Test-Point Analysis

To perform the trouble-shooting tests, the following test equipment and parts are required:

- VTVM or 20,000-ohms-per-volt voltmeter
- OSCILLOSCOPE with broad-band amplifiers
- SIGNAL GENERATORS
 - Audio signal generator

AM signal generator (frequency range of 20 mc. to 28 mc. for i-f tests; frequency range for r-f tests to cover local-station carrier frequencies)

FM signal generator (center-frequency range of 20 mc. to 30 mc., and sweep range of at least 250 kc. A television FM signal generator with a sweep range of 8 mc. may be used.)

MISCELLANEOUS

- .1-mf. condenser (paper, 600-volt rating)
- 50-mmf. condenser (mica, 2000-volt rating)
- .002-mf. condenser (mica, 2000-volt rating)
- 1000-ohm resistor

Line cord, with standard male connector, Part No. L2183, a special female connector, Part No. 27-6217, and shell flange, Part No. 56-4346 (to fit a-c interlock).

CAUTION

High voltage dangerous to human life is used in this Receiver. Unless the high voltage is required for a picture-tube presentation or for a voltage check, the 1B3GT high-voltage rectifier should be removed while trouble-shooting, to avoid possible physical contact and serious injury.

TROUBLE SHOOTING SECTION 1 — POWER-SUPPLY CIRCUITS





NOTE: For step 1, connect a VTVM or a 20,000-ohms-per-volt voltmeter across test point. For steps 2 and 3, connect an a-c voltmeter across test point. For steps 4, 5, 6, and 7, connect a VTVM or a 20,000-ohms-per-volt voltmeter between test point and ground. For steps 8, 9, 10, and 11, turn BACKGROUND and FOCUS controls fully counterclockwise, and connect a 20,000-ohms-per-volt voltmeter (5000-volt range) be-

tween test point and ground.

Voltage readings given were measured at a line voltage of 117 volts, a.c.

If the "NORMAL INDICATION" is obtained in steps 1 and 8, proceed with the tests for Section 2 (audio circuits); if not, isolate and correct the trouble in this section.

LOW-VOLTAGE POWER SUPPLY

STEP	TEST POINT	NORMAL INDICATION	ABNORMAL INDICATION	POSSIBLE CAUSE OF ABNORMAL INDICATION
1		140 volts, d.c.		If normal indication is obtained, proceed with step 8. If abnormal indication is obtained, proceed with step 2.
2		117 volts, a.c. (110 to 120 volts)	High or low voltage No voltage	Incorrect power source. Defective: P100, J100, W100.
3	 Remove 5U4G tube.	745 volts, a.c.	Low voltage No voltage	Defective: T100. Defective: T100, S100.
4	 Replace 5U4G tube.	395 volts, d.c.	High voltage Low or no voltage	Open: L100, L101, R100A. Shorted or leaky: C101A, C101B, C101C, C102, C103, C206*. Defective: 5U4G, T100.

TROUBLE SHOOTING SECTION 1 — POWER SUPPLY CIRCUITS (Cont)

STEP	TEST POINT	NORMAL INDICATION	ABNORMAL INDICATION	POSSIBLE CAUSE OF ABNORMAL INDICATION
5	D	350 volts, d.c.	High voltage No voltage	Open: L100, R100A. Open: L101.
6	E	250 volts, d.c.	No voltage	Open: R100A.
7	F	395 volts, d.c.	No voltage	Open: L100.

**HIGH-VOLTAGE POWER SUPPLY
BE SAFE! TURN OFF RECEIVER BEFORE MAKING CONNECTIONS.**

8	2	Negative 2100 volts, d.c.		If abnormal indication is obtained, proceed with step 9.
9	G	Negative 3050 volts, d.c.	High voltage Low voltage No voltage	Open: R105, R104, R103, R102, R101. Leaky: C100A, C100B, C100C. Open: C100A. Defective: 1B3GT, T100. Open: R109. Shorted: C100A, C100B.
10	H	Negative 2900 volts, d.c.	Low voltage	Open: R108, R106.
11	2	Negative 2100 volts, d.c.	No voltage	Open: R104.

This part, located in another section, may cause abnormal indication in this section.

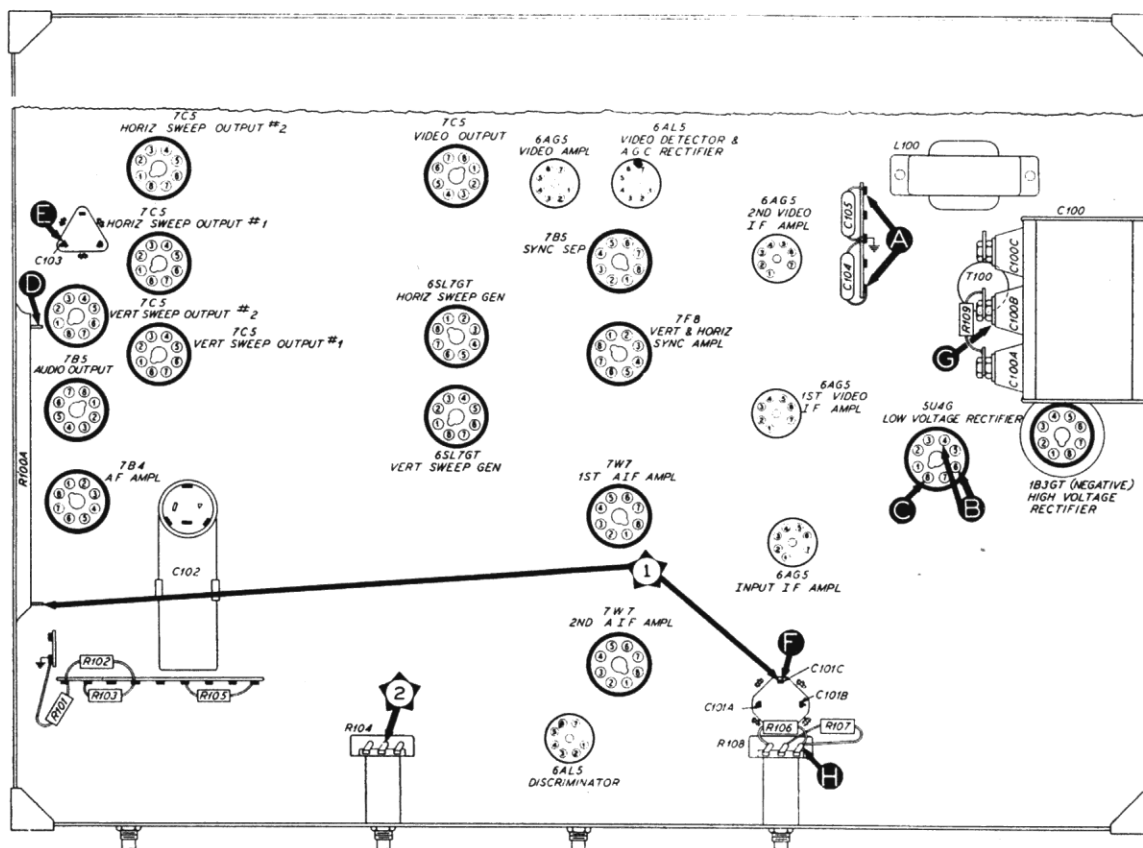

FIGURE 20. BOTTOM VIEW OF CHASSIS, SHOWING SECTION 1 TEST POINTS. TP-4736A

TROUBLE SHOOTING SECTION 2 — AUDIO CIRCUITS

Set VOLUME control to maximum.

NOTE 1: Use an FM signal generator, set to 22.1 mc. An AM signal generator with 400-cycle modulation may be used if an FM signal generator is not available. If an AM signal generator is used, it should be adjusted slightly below 22.1 mc. For steps 1, 5, 6, and 7, connect the signal generator between test point and ground; use a .1-mf. condenser in series with the signal lead. Use moderate to weak output.

NOTE 2: For steps 2, 3, and 4, connect an audio signal generator, set at 400 cycles, between test point and ground; use a .1-mf. condenser in series with the signal lead. Use moderate to weak output.

If the "NORMAL INDICATION" is obtained in step 1, proceed with the tests for Section 3 (video circuits); if not, isolate and correct the trouble in this section.

STEP	TEST POINT	NORMAL INDICATION	POSSIBLE CAUSE OF ABNORMAL INDICATION
1 See note 1.		Loud, clear audio signal.	Trouble in this section; proceed with step 2.
2 See note 2.		Loud, clear audio signal.	Defective: LS200, T200, C221, 7B5. Open: C220A, R220, R221. Shorted or leaky: C220B.
3 See note 2.		Loud, clear audio signal, louder than in step 2.	Open: C219, R219, R218, R217. Defective: 7B4. Shorted or leaky: C218.

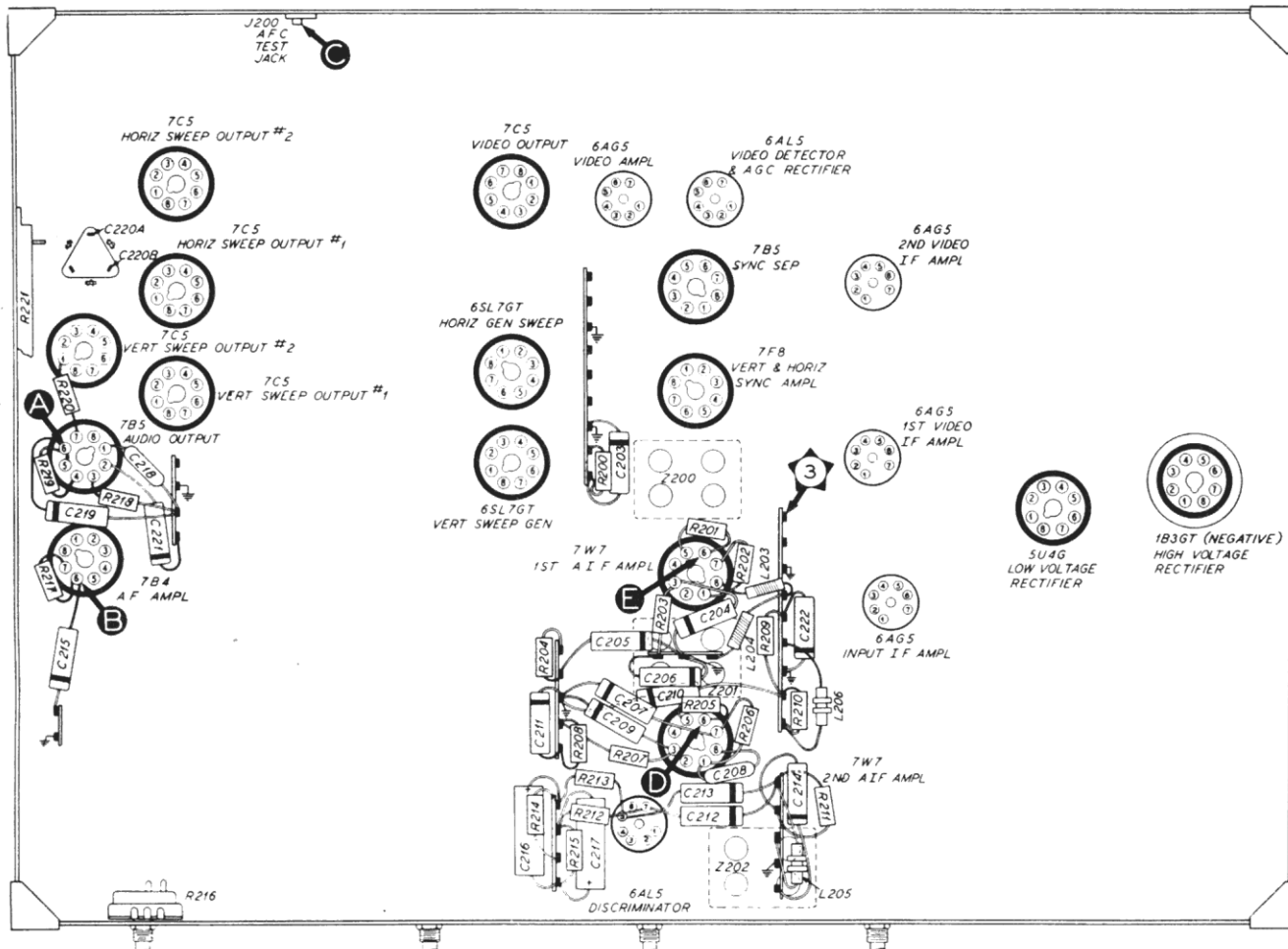

FIGURE 21. BOTTOM VIEW OF CHASSIS, SHOWING SECTION 2 TEST POINTS.

TP 4736B

TROUBLE SHOOTING SECTION 3 — VIDEO CIRCUITS (Cont.)

STEP	TEST POINT	NORMAL INDICATION	POSSIBLE CAUSE OF ABNORMAL INDICATION
8 See note 1.	G	Same as step 2, with less signal-generator output than in step 7.	Defective: 6AG5 (input i.f.), Z301. Open: R200*, R307, R306, L304. Shorted: C306, C307, C203*.
9 See note 1.	4	Same as step 1.	Defective: Z300.

* This part, located in another section, may cause abnormal indication in this section.

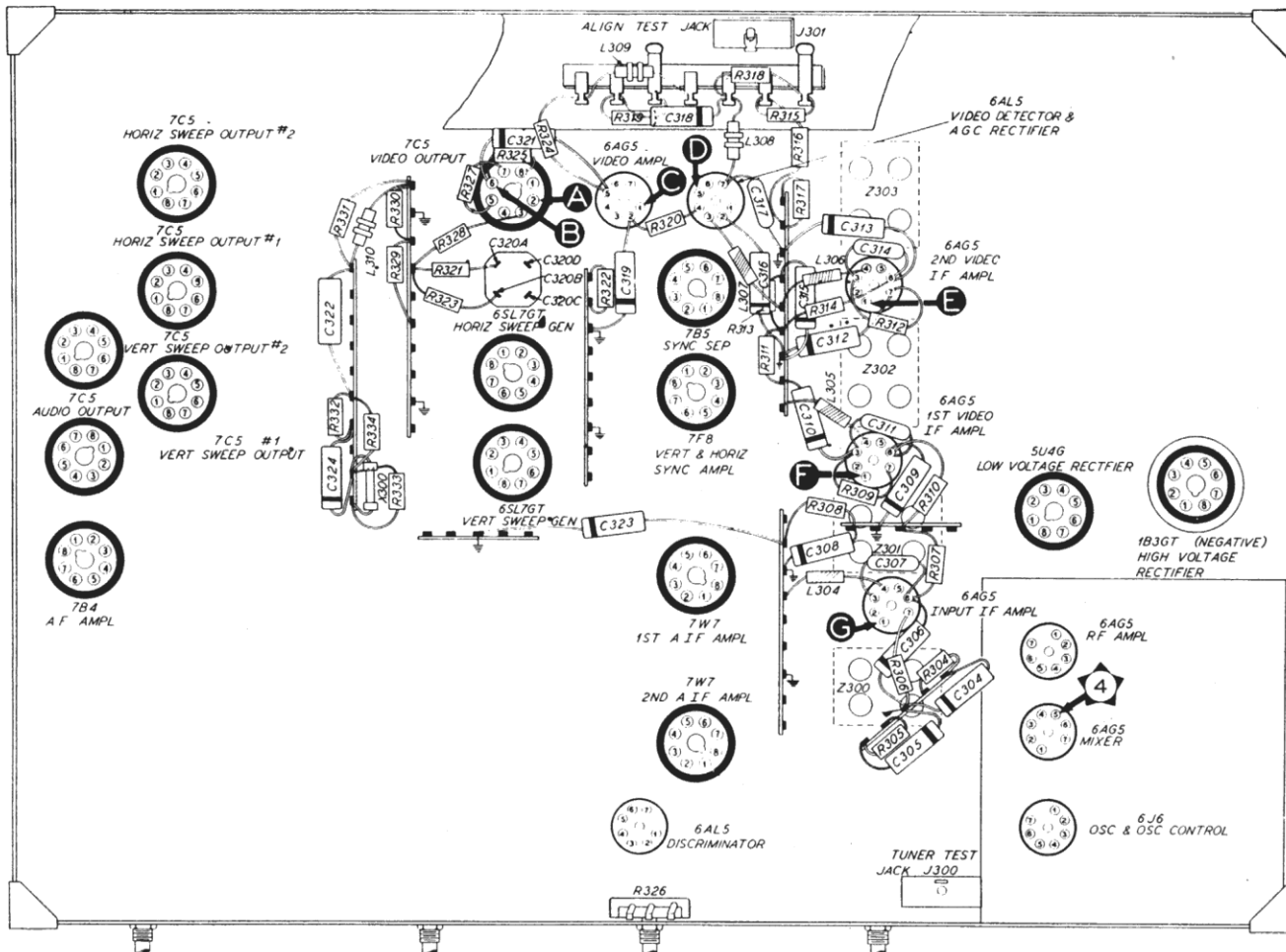

FIGURE 22. BOTTOM VIEW OF CHASSIS, SHOWING SECTION 3 TEST POINTS.

TP-4736C

TROUBLE SHOOTING SECTION 2 — AUDIO CIRCUITS (Cont.)

STEP	TEST POINT	NORMAL INDICATION	POSSIBLE CAUSE OF ABNORMAL INDICATION
4 See note 2.	Ⓒ	Clear audio signal, weaker than in step 3.	Shorted: C212, C213, C216, C217. Open: C214, C215. Defective: R216.
5 See note 1.	Ⓓ	Loud, clear audio signal, louder than in step 4.	Defective: 6AL5 (discriminator), 7W7 (2nd a.i.f.), Z202. Open: L205, R208, R207, R205, R206, R211, R212, C209, C207. Shorted: C211, C209.
6 See note 1.	Ⓔ	Loud, clear audio signal, louder than in step 5.	Defective: 7W7 (1st a.i.f.), Z201. Open: R201, R202, R204, R203, C204, C205, L203. Shorted: C205, C204.
7 See note 1.	Ⓢ	Loud, clear audio signal.	Defective: Z200. Open: R200. Shorted: C203. Misalignment: See alignment chart, page 27. Trouble in Section 3.

TROUBLE SHOOTING SECTION 3 — VIDEO CIRCUITS

Set CONTRAST control fully clockwise. Set BACK-GROUND control so that raster is faintly visible on picture tube. If raster cannot be obtained, proceed to Section 5, and test for horizontal and vertical-sweep action; after correcting the trouble, return to this section.

NOTE 1: For steps 1, 5, 6, 7, 8, and 9, connect an AM signal generator, set at 26.6 mc. and modulated at 400 cycles, between test point and ground; use a .1-mf. condenser in series with the signal lead.

condenser in series with the signal lead.

NOTE 2: For steps 2, 3, and 4, connect an audio signal generator, set at 400 cycles, between test point and ground; use a .1-mf. condenser in series with the signal lead.

If the "NORMAL INDICATION" is obtained in step 1, proceed with the tests for Section 4 (r-f circuits); if not, isolate and correct the trouble in this section.

STEP	TEST POINT	NORMAL INDICATION	POSSIBLE CAUSE OF ABNORMAL INDICATION
1 See note 1.	Ⓢ	Strong, alternate white and black bars on picture tube, with weak signal-generator output.	Trouble in this section; proceed with step 2.
2 See note 2.	Ⓐ	Alternate white and black bars, with strong signal-generator output.	Defective: 7GP4 (picture tube). Open: C322, L310, L314. Shorted: C322.
3 See note 2.	Ⓑ	Same as step 2, except stronger bars, with less signal-generator output than in step 2.	Defective: 7C5. Open: R329, R330, R325, R326, R327, R328. Shorted: C320C, C320D.
4 See note 2.	Ⓒ	Same as step 2, except stronger bars, with less signal-generator output than in step 3.	Defective: 6AG5 (video amplifier). Open: R319, R324, L307, R320, R321, R322, C321. Shorted: C320A, C320B.
5 See note 1.	Ⓓ	Same as step 2, with strong signal-generator output.	Defective: 6AL5 (video detector). Open: L308, C318, R318, L307.
6 See note 1.	Ⓔ	Same as step 2, with less signal-generator output than in step 5.	Defective: 6AG5 (2nd video i.f.), Z303. Open: R313, R314, L306, R312. Shorted: C315, C313, C314.
7 See note 1.	Ⓕ	Same as step 2, with less signal-generator output than in step 6.	Defective: 6AG5 (1st video i.f.), Z302. Open: R310, R311, L305, R309. Shorted: C309, C311, C310.

TROUBLE SHOOTING SECTION 3 — VIDEO CIRCUITS (Cont.)

STEP	TEST POINT	NORMAL INDICATION	POSSIBLE CAUSE OF ABNORMAL INDICATION
8 See note 1.	Ⓞ	Same as step 2, with less signal-generator output than in step 7.	Defective: 6AG5 (input i.f.), Z301. Open: R200*, R307, R306, L304. Shorted: C306, C307, C203*.
9 See note 1.	⬠	Same as step 1.	Defective: Z300.

This part, located in another section, may cause abnormal indication in this section.

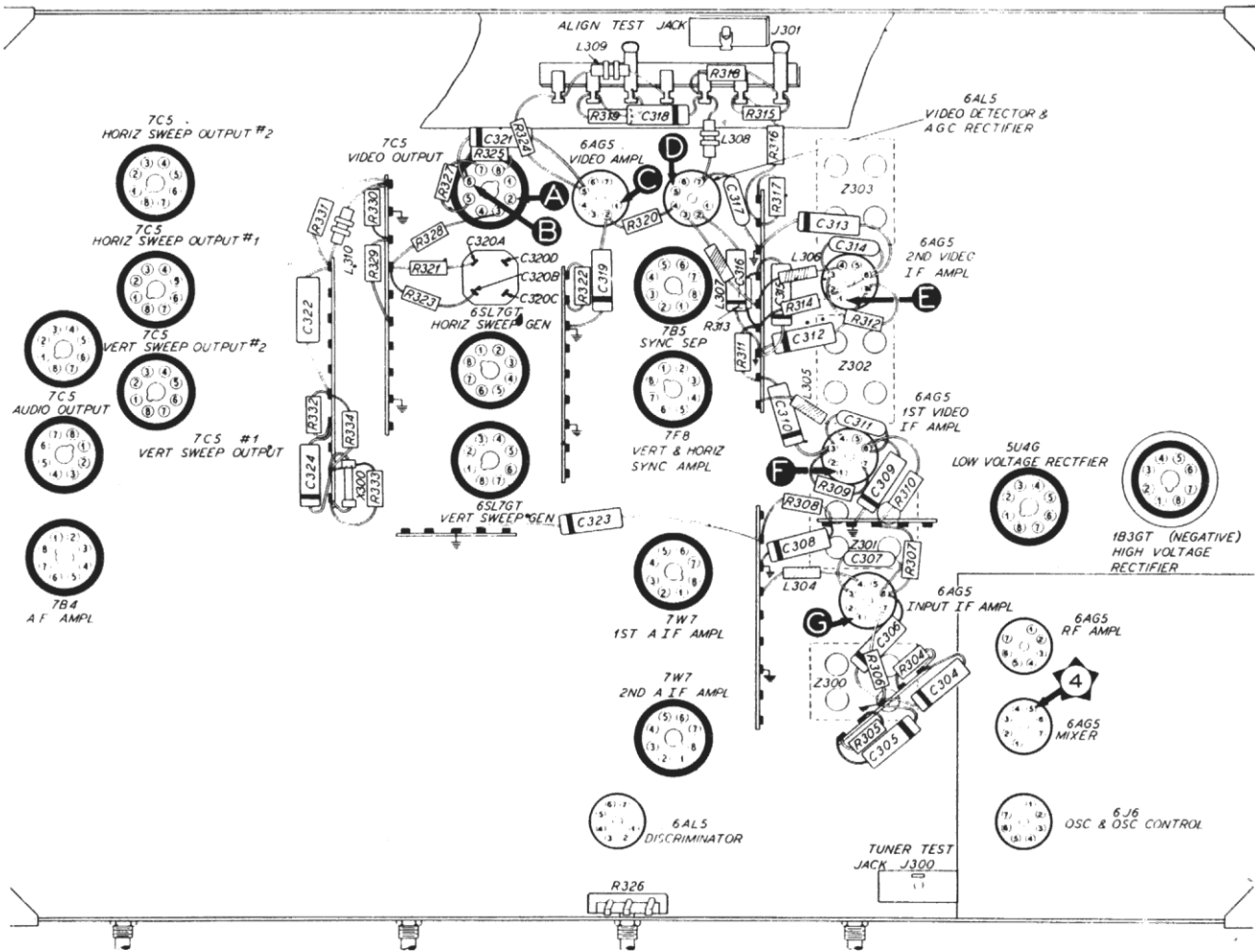



FIGURE 22. BOTTOM VIEW OF CHASSIS, SHOWING SECTION 3 TEST POINTS.

TP 4736C

TROUBLE SHOOTING SECTION 4 — R-F CIRCUITS (Cont.)

STEP	TEST POINT	NORMAL INDICATION	ABNORMAL INDICATION	POSSIBLE CAUSE OF ABNORMAL INDICATION
4		Loud, clear audio signal.	Weak or no signal.	Defective: 6AG5 (r-f amplifier), Z400. Open: R406, C413, R411, R412. Shorted: C417, C418.
5		Loud, clear audio signal.	Weak or no signal.	Defective: Z401.

* This part, located in another section, may cause abnormal indication in this section.







TROUBLE SHOOTING SECTION 5 — SWEEP CIRCUITS

For all steps, connect the vertical-plate leads of an oscilloscope between the test point and the Receiver chassis. For the waveforms taken at the vertical-sweep and vertical-sync circuits, the oscilloscope must be synchronized at approximately 30 c.p.s. (half the vertical-sweep rate), and for the waveforms taken at the horizontal-sweep and horizontal-sync circuits, the oscilloscope must be synchronized at approximately 7875 c.p.s. (half the horizontal-sweep rate). These tests must be

made with a standard RMA television signal applied to the Receiver input. The test-chart signal from a television station may be used. The voltage values indicated under each waveform in the "NORMAL INDICATION" column are peak-to-peak values.

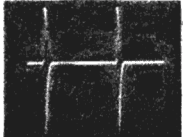
If the "NORMAL INDICATION" is not obtained in steps, 1, 7, 12, and 16, follow the steps, or sections, specified for testing the circuits in which abnormal operation is indicated.

VERTICAL-SWEEP CIRCUITS

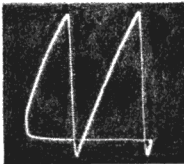
STEP	TEST POINT	NORMAL INDICATION	POSSIBLE CAUSE OF ABNORMAL INDICATION	SPECIAL NOTES
1		 230 volts	Trouble in vertical-sweep circuits; proceed with step 2.	
2		 220 volts	Defective: 6SL7GT (vertical-sweep generator), T500. Open: R507, R510, R511, R517, R518, C505, C503B, C506. Shorted: C505, C503B, C506, C504.	
3		 35 volts	Open: R512, R513, R514, R515, C508. Shorted: C508.	
4		 38 volts	Open: C508, C509, R516. Shorted: C508, C509.	





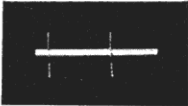
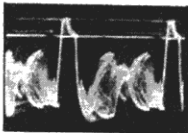
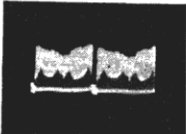
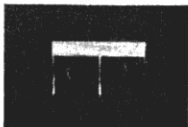

TROUBLE SHOOTING SECTION 5 — SWEEP CIRCUITS (Cont.)

VERTICAL-SYNC CIRCUITS



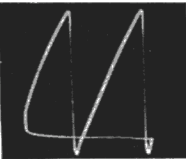

STEP	TEST POINT	NORMAL INDICATION	POSSIBLE CAUSE OF ABNORMAL INDICATION	SPECIAL NOTES
5	D	 280 volts	Defective: 6C5 (vertical-sweep output). Open: R519, R521. Shorted: C512, C510.	
6	6	Same as step 1.	Defective: 6C5 (vertical-sweep output). Open: C510, C511, R522, R520. Shorted: C511, C510.	See figure 25.
7 Remove vertical-sweep generator tube.	7	 22 volts	Trouble in vertical-sync circuits; proceed with step 8.	
8	E	 20 volts	Defective: 6AG5* (video amplifier) or other trouble in Section 3. Open: C500, R500, R501. Shorted: C500.	
9	F	 4 volts	Defective: 7B5 (sync separator). Open: R502, R503, R504, R505. Shorted: C501.	
10	G	 3 volts	Open: C502, R506. Shorted: C502.	
11	7	Same as step 7.	Defective: 7F8 (vertical-sync amplifier). Open: C504, R507, R508, R509. Shorted: C503A, C504.	After step 11, replace vertical-sweep-generator tube.

TROUBLE SHOOTING SECTION 5 — SWEEP CIRCUITS (Cont.)

HORIZONTAL-SWEEP CIRCUITS

STEP	TEST POINT	NORMAL INDICATION	POSSIBLE CAUSE OF ABNORMAL INDICATION	SPECIAL NOTES
12		 250 volts	Trouble in horizontal-sweep circuits; proceed with step 13.	
13		 60 volts	Defective: 6SL7GT (horizontal-sweep generator), T501. Open: R530, R531, R532, R533, R534, R535, R536, R537, R538, C516, C519, C520, L500. Shorted: C516, C517, C518, C503C, C519, C520, C521.	See figures 26, 27, 28, and 29.
14		 200 volts	Defective: 7C5 (horizontal-sweep output). Open: R539, R540, R541, R543, R544, L501. Shorted: C522, C523.	
15		Same as step 12.	Defective: 7C5 (horizontal-sweep output). Open: R542, R548, R545, R549, C522. Shorted: C522.	See figure 30.

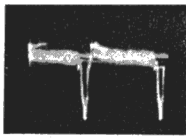
HORIZONTAL-SYNC CIRCUITS

16 Remove horizontal-sweep-generator tube.		 5 volts	Trouble in horizontal-sweep circuits; proceed with step 17.	
17		 3 volts	Open: C513, R527. Shorted: C513.	See steps 8 and 9.
18		Same as step 16.	Defective: 7F8 (horizontal-sync amplifier). Open: R528, R529, R530, C515. Shorted: C514, C515.	After step 18, replace horizontal-sweep-generator tube.

TROUBLE SHOOTING SECTION 5 — SWEEP CIRCUITS (Cont.)

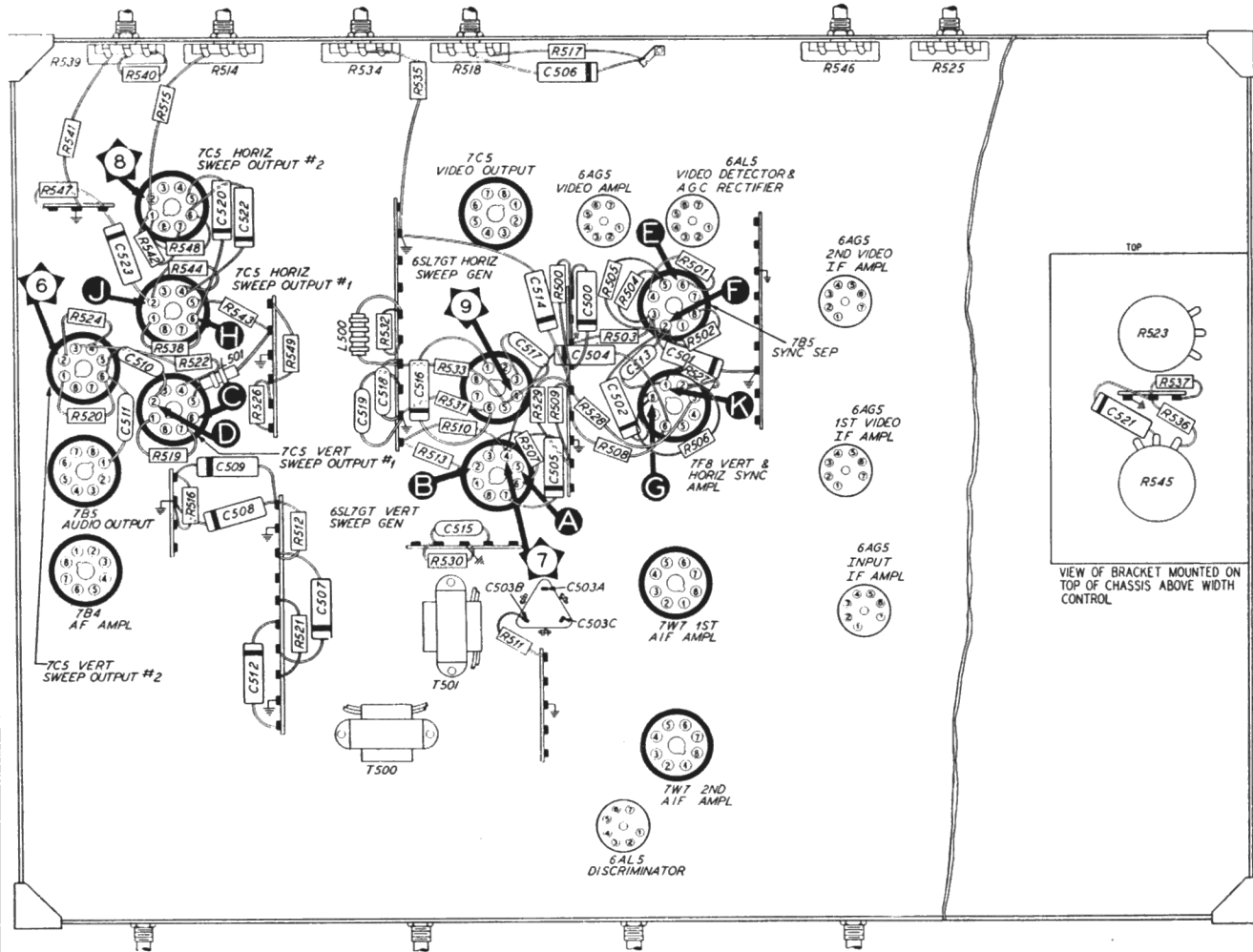

FIGURE 24. BOTTOM VIEW OF CHASSIS, SHOWING SECTION 5 TEST POINTS.

TP-4736E

SUPPLEMENTARY WAVEFORMS

The following waveforms supplement the troubleshooting procedure for Section 5. The oscilloscope was synchronized at half the vertical-sweep rate for vertical waveforms, and at half the horizontal-sweep rate for horizontal waveforms. The station was trans-

mitting a standard test chart. Note that the picture-waveform content will appear different if other than the test chart is being transmitted; however, the blanking and synchronizing pulses will be unchanged.



Figure 25. Waveform at Grid (Pin 6) of Vertical-Sweep Output No. 2.

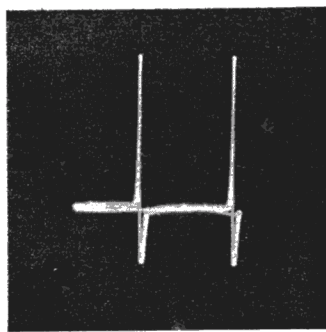

Figure 26. Waveform at Grid (Pin 4) of Horizontal-Sweep Generator.

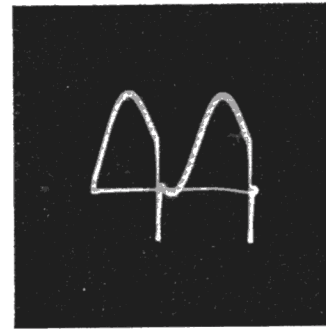
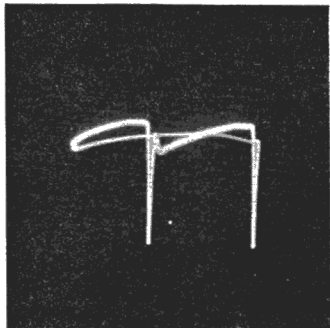

Figure 27. Waveform at Plate (Pin 5) of Horizontal-Sweep Generator.

SUPPLEMENTARY WAVEFORMS — Continued



TP-4648

Figure 28. Waveform (Taken Through a 50-mmf. Condenser) at Plate (Pin 2) of Horizontal-Sweep Generator.

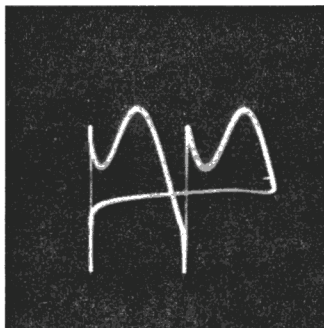

TP-4651

Figure 29. Waveform at Cathode (Pin 3) of Horizontal-Sweep Generator.

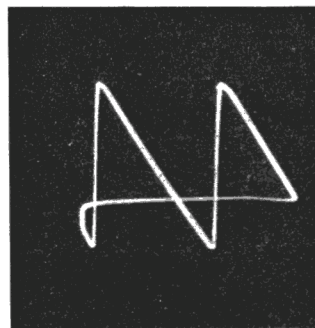

TP-4641

Figure 30. Waveform at Grid (Pin 6) of Horizontal-Sweep Output No. 2.

ALIGNMENT

CAUTION

Dangerous potentials are present in the Receiver when it is operating, and for a short time after it has been turned off.

General

The intermediate frequencies of the Receiver are 22.1 megacycles for the audio channel and 26.6 megacycles for the video channel. The alignment of circuits operating at these high frequencies requires accurately calibrated equipment and extreme care in making the adjustments. The following precautions must be observed.

The top of the work bench should be metallic, or a separate metal plate should be placed on the bench; the Receiver chassis and signal-generator case must make good metal-to-metal contact with the bench top or plate, which should be securely grounded.

All leads from the signal generator must be shielded. The unshielded length of signal lead must be kept very short and the shield must be clipped to the Receiver chassis at a point close to the signal-lead connection. The signal-generator output lead should be terminated with a shunt resistance equal to its characteristic impedance.

The signal-generator output must be kept low enough to prevent overloading the Receiver circuits. Limiting action produced by overloading circuits causes incorrect response curves.

All adjustments should be made with low-loss, non-metallic alignment tools.

Never disconnect the picture tube or loud-speaker while the Receiver is turned on.

NOTE: Before starting the alignment, allow the Receiver and signal generators to warm up for at least 20 minutes.

Test Equipment Required for Alignment

Special test equipment for television-receiver alignment will be available in the near future. Such equipment may combine several of the test instruments listed below. The information given for each instrument is generalized, so that the serviceman can determine whether his present equipment is adequate.

The following equipment is necessary to properly align and adjust the Receiver:

IMPORTANT!

Do not attempt to align the Receiver unless the specified test equipment is available.

FM SIGNAL GENERATOR

Deviation, ± 4 mc.; center-frequency ranges, 20 mc. to 30 mc.; sweep-sync output with either built-in or separate phase corrector.

AM SIGNAL GENERATOR

Carrier-frequency ranges, 20 mc. to 30 mc. (accurately calibrated); accurate output indicator (either calibrated attenuator or separate output meter); known modulation percentage (variable up to 100% is preferred).

VOLTMETER

VTVM or 20,000-ohms-per-volt voltmeter, with ranges of 0—1, 0—10, and 0—600 volts, a.c. and d.c.

OSCILLOSCOPE

Calibrated; vertical sensitivity of 1 volt (peak-to-peak) per inch, or better.

ALIGNMENT CHART

VIDEO I-F

STEP	OUTPUT-INDICATOR CONNECTION	SIGNAL-GENERATOR CONNECTION	SIGNAL-GENERATOR SETTING	ADJUST
1	Connect oscilloscope vertical input to align test jack. Connect horizontal input to sweep output of FM generator. See note 1	Connect FM and AM generators to grid (pin 1) of 2nd video-i-f amplifier. See note 2.	Set FM generator to 25 mc., deviation ± 4 mc. Set AM generator (unmodulated) to 27.1 mc., to produce marker "pip" on response curve.	Set C303B fully counterclockwise. Adjust L303A and L303B for single peak at 27.1 mc. (indicated by position of marker "pip").
2	Same as step 1.	Same as step 1.	FM generator, same as step 1. AM generator, (unmodulated) to 23.1 mc., to produce marker "pip" on response curve.	Adjust C303B clockwise until low-frequency peak of response curve is at 23.1 mc.; curve should resemble curve 1 in figure 36. It may be necessary to readjust L303A or L303B slightly, to equalize amplitude of peaks.
3	Same as step 1.	Disconnect FM generator. Connect AM generator to grid (pin 1) of 1st video-i-f amplifier.	28.1 mc. (modulated).	Adjust L302B for minimum signal.
4	Same as step 1.	Connect FM and AM generators to grid (pin 1) of 1st video-i-f amplifier. See note 2.	FM generator, same as step 6. Set AM generator (unmodulated) to 23.75 mc. and 26.6 mc., as required, to produce marker "pips" on response curve.	Adjust L302A for low-frequency peak, and L302C for high-frequency peak, to obtain response curve similar to curve 2 in figure 36.
5	Same as step 1.	Disconnect FM generator. Connect AM generator to grid (pin 1) of input-i-f amplifier.	22.1 mc. (modulated).	Adjust L301B for minimum signal.
6	Same as step 1.	Connect FM and AM generator to grid (pin 1) of input-i-f amplifier. See note 2.	Set FM generator to 25 mc., deviation ± 4 mc. Set AM generator (unmodulated) to 22.75 mc., 24.25 mc., 25.75 mc., and 27.0 mc., as required, to produce marker "pips" on response curve.	Adjust L301A and L301C for response curve similar to curve 3 in figure 35.
7	Same as step 1.	Connect FM and AM generator to grid (pin 1) of mixer. See notes 2 and 3.	FM generator, same as step 6. Set AM generator (unmodulated) to 22.6 mc., 23.75 mc., 24.6 mc., and 26.6 mc., as required, to produce marker "pips" on response curve.	Adjust L300A, C300B, and L300B for over-all response curve similar to curve 4 in figure 35. (C300B controls band width). If curve is not satisfactory, see note 4.

AUDIO I-F

8	Connect oscilloscope vertical input to a-f-c test jack. See note 1. Connect horizontal input to sweep output of FM generator.	Connect FM and AM generators to grid (pin 6) of 2nd audio-i-f amplifier. See note 2.	Set FM generator to 22.1 mc., deviation ± 3 mc. Set AM generator (unmodulated) to produce marker "pips" on discriminator curve at each of the three following points, in turn: <ol style="list-style-type: none"> 1. crossover point 2. negative peak 3. positive peak 	No adjustments for this step. Observe the frequency setting of the AM generator required to produce "pips" at each of the 3 points. The following frequencies should be indicated: <ol style="list-style-type: none"> 1. crossover point—22.1 mc. 2. negative peak—21.8 mc. 3. positive peak—22.4 mc. Discriminator curve is shown in figure 37.
9	Same as step 8.	Same as step 8.	FM generator, same as step 8. Set AM generator (unmodulated) to produce marker "pip" at crossover point on discriminator curve.	Adjust L202B until crossover point occurs at frequency setting of 22.1 mc. See note 5.

ALIGNMENT CHART — Continued

AUDIO I-F

STEP	OUTPUT-INDICATOR CONNECTION	SIGNAL-GENERATOR CONNECTION	SIGNAL-GENERATOR SETTING	ADJUST
10	Same as step 8.	Same as step 8.	FM generator, same as step 8. Set AM generator (unmodulated) first to 21.8 mc., then to 22.4 mc. as adjustments are made, to produce marker "pips" on discriminator curve.	Adjust L202A and C202C until marker "pips" occur at negative and positive peaks of discriminator curve (thus making the two peaks 600 kc. apart). See note 5.
11	Same as step 8.	Connect FM generator to grid (pin 6) of 1st audio-i-f amplifier.	22.1 mc., deviation ± 3 mc. Adjust output for same amplitude obtained in step 10.	Adjust L201A for maximum amplitude, while keeping amplitude of peaks equal.
12	Same as step 8.	Connect FM generator to grid (pin 1) of input-i-f amplifier.	Same as step 11.	Adjust L200A for maximum amplitude.
13	Same as step 8.	Connect FM and AM generators to grid (pin 1) of mixer. (See notes 2 and 3.)	Set FM generator to 25 mc., deviation ± 4 mc. Set AM generator (unmodulated) to 22.4 mc., 22.1 mc., and 21.8 mc., as required, to produce marker "pips" on discriminator output curve.	If necessary, adjust L200A and L201A slightly to equalize amplitude of negative and positive peaks of discriminator output curve.
FINAL I-F CHECK				
NOTE: The procedure given in the following step is performed to make certain that the accompanying-sound trap and the discriminator are tuned to the same frequency.				
14	Connect oscilloscope vertical input to align test jack. Connect VTVM or 20,000-ohms-per-volt meter to a-f-c test jack.	FM generator not used. Connect AM generator to grid (pin 1) of input i-f amplifier.	22.1 mc. Set generator (unmodulated) for minimum signal on oscilloscope.	D-c output of discriminator should be zero; if not, readjust L202B. See note 6.

ALIGNMENT NOTES

NOTE 1: Connect the "hot" lead of the oscilloscope vertical input through a 10,000-ohm isolating resistor, to prevent radiation from the lead.

NOTE 2: Connect the signal lead of the AM generator through a small isolating condenser, approximately 10 mmf.

NOTE 3: Grounding of the signal lead shield is critical at this point. Try adding additional grounding, while observing the output curve, until no change in curve results from added grounds.

NOTE 4: If necessary, readjust L301A, L302C, L301C, and L302A *slightly*, to obtain best possible reproduction of curve 1. IMPORTANT: DO NOT DISTURB L303A, L303B, C303B, L302B, or L301B.

NOTE 5: When making this adjustment, it is possible to apparently obtain the proper curve, and yet have the discriminator output (a-f-c) voltage so phased as to shift the oscillator frequency away from the correct frequency, thus preventing the oscillator from locking in. To avoid this difficulty, check the phasing by observing the polarity of the discriminator output voltage; negative output voltage is produced when the audio-i.f. is lower than the center frequency. If this condition does not exist, turn L202A further in (clockwise) until the required polarity is obtained.

NOTE 6: If this adjustment requires more than 1/2 turn of L202B, the discriminator output curve should be rechecked (see step 8). If necessary, readjust C202C *slightly*, to obtain equal peaks on the response curve.

REMOVAL AND REPLACEMENT OF PARTS

Channel Coils

The proper method of inserting the channel coils is shown in figure 38. The oscillator coil, which is slug-tuned, should be placed in the front compartment of the Philco Precision Channel Selector; the antenna coil, which is fixed-tuned, should be placed in the rear compartment. The coil part numbers should both end with the same suffix numeral. The suffix numeral indicates the television-broadcast channel number; for example, 32-4115-3 and 32-4222-3 are the part numbers of the antenna and oscillator coils, respectively, for channel 3. Should the oscillator-coil slug be all the way out, it must be turned in until the coil can be properly inserted. Be sure that the coil-holding lip is underneath the edge of the channel-selector rim, as it is possible to snap in the coil with the lip outside. Each pair of coils may be inserted in any one set of channel com-

partments provided that the two coils are inserted in corresponding compartments; if the channel-3 oscillator coil were paired with the channel-4 antenna coil, for instance, poor reception or no reception would result.

Chassis

To remove the chassis, proceed as follows: Remove the five control knobs. Remove the wood screws which hold the back cover of the Receiver, and take off the cover. Remove the four chassis mounting bolts, and disconnect the speaker and picture-tube cable connectors. Slide the chassis out of the cabinet.

Speaker

To remove the speaker, first remove the chassis; then remove the four nuts and washers, while holding the speaker to keep it from falling.

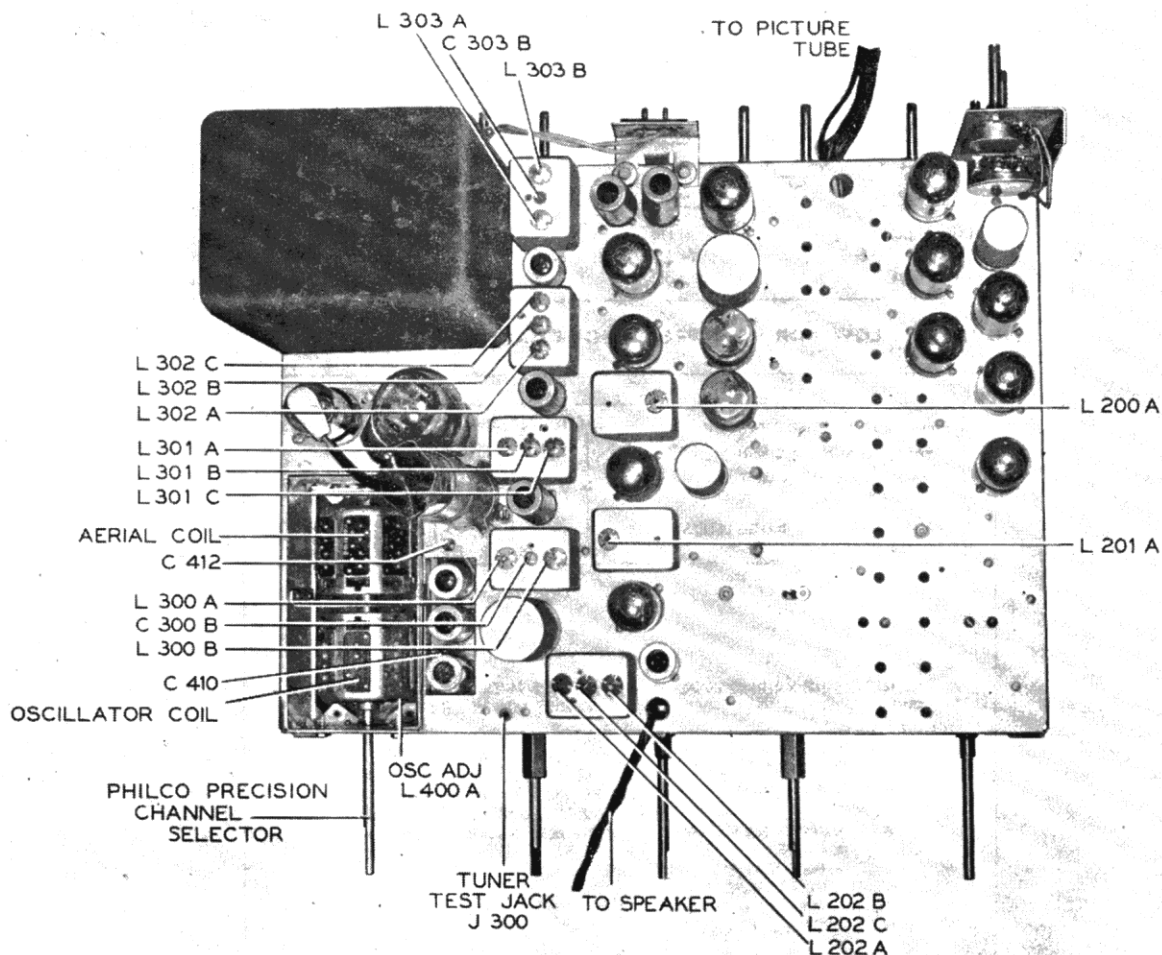

FIGURE 34. LOCATION OF ADJUSTMENTS FOR ALIGNMENT OF RECEIVER.

TP-5010

SPECIAL CHECKS

Video-Amplifier-Gain Check

The video-amplifier stages should have a gain of 35 to 40. To check the gain, connect the AM signal generator to the aerial receptacle J400, and set the frequency to any picture-carrier channel for which coils are provided. Adjust the signal generator for 100% modulation, if possible. Connect the calibrated oscilloscope to the align test jack J301 (video-detector output), and note the peak-to-peak voltage. Set the CONTRAST control fully clockwise. Connect the calibrated oscilloscope through a .01-mf. condenser to the plate (pin 2) of the video output tube, and note the peak-to-peak voltage. The gain of the video stages will be the output voltage (plate of the video output tube) divided by the detector voltage. This should be about 35 to 40.

If the video-amplifier gain is low, try new video-amplifier and video-output tubes; if the gain is still low, check for trouble in Section 3.

D-C Restoration Check

A general check of d-c restoration may be made as follows: With the Receiver turned on and a picture appearing on the picture tube, disconnect the aerial. If the d-c restorer is operating properly, the raster will disappear when the aerial is disconnected; if not, the raster will remain visible.

To make a more accurate check of the d-c restorer, proceed as follows: Turn off the Receiver, disconnect the picture tube, remove the high-voltage rectifier, and discharge the high-voltage circuit. Turn the CONTRAST control fully clockwise. With a normal video-signal input (approximately 2 volts peak-to-peak at the video-detector output), measure the voltage developed across the d-c restorer (1N34 crystal). This voltage, measured with a 20,000-ohm-per-volt meter, should be 15 to 25 volts.

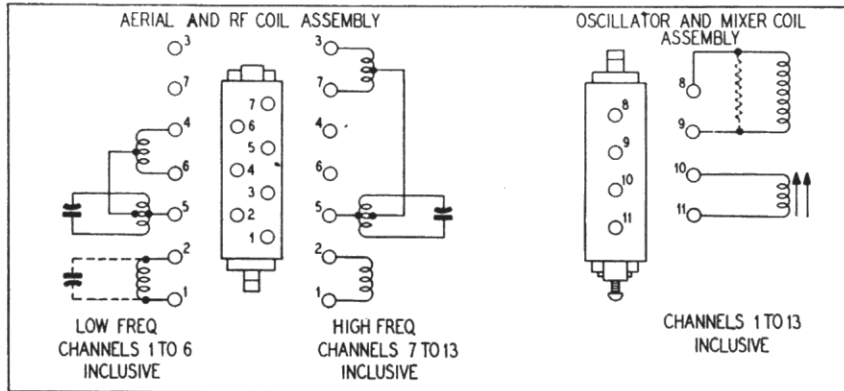

TP-4044-1

FIGURE 31. LOW AND HIGH-FREQUENCY-CHANNEL COIL CONNECTIONS.

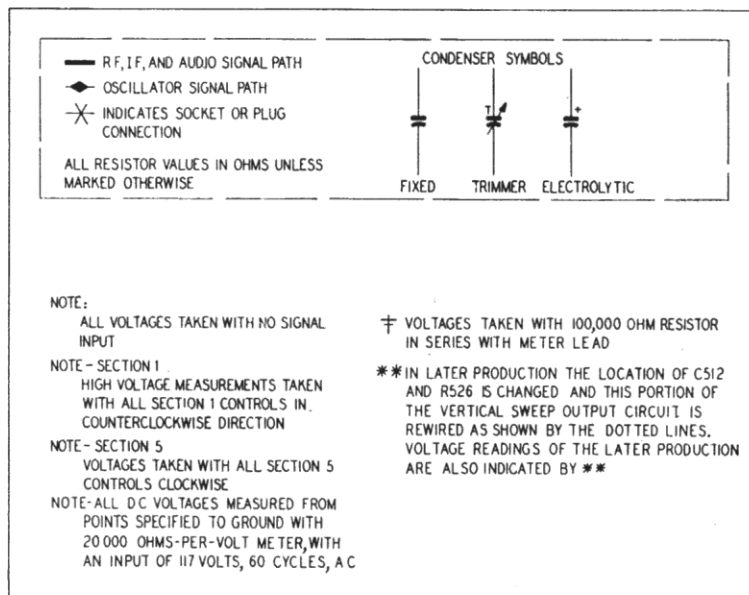

TP 4736G

FIGURE 32. LEGEND FOR SCHEMATIC DIAGRAM.

Picture Tube

To remove the picture tube, first remove the chassis from the cabinet. Then loosen the clamping screw on the picture-tube mounting bracket. Remove the mounting bracket from the top of the cabinet, and pull the

picture tube with the mounting bracket out of the holding clips. On early models, there is a metal shield around the neck of the picture tube. Before replacing this shield, make sure that the three rubber strips and the rubber shim are held securely to the picture tube by rubber cement.

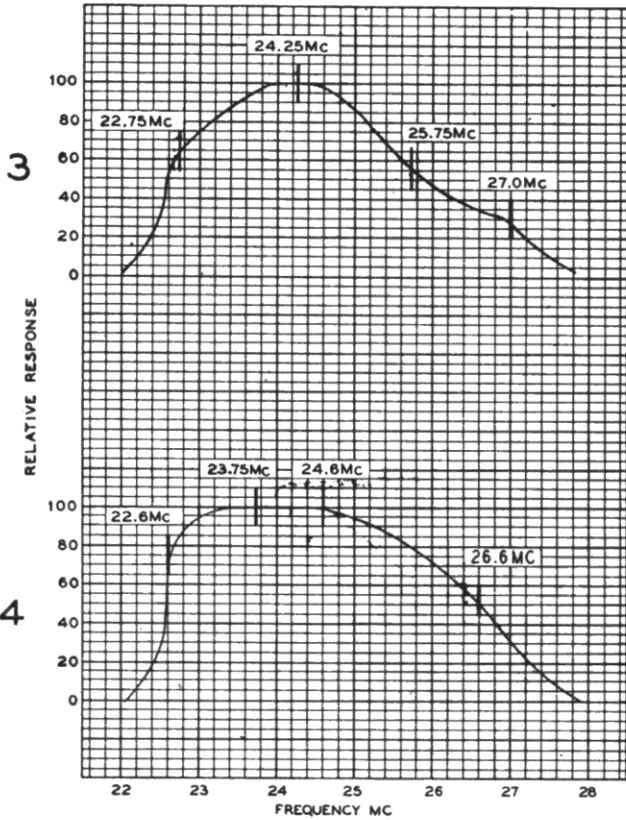

FIGURE 35. VIDEO-I-F CURVES (2nd and 3rd V-I-F COUPLERS).

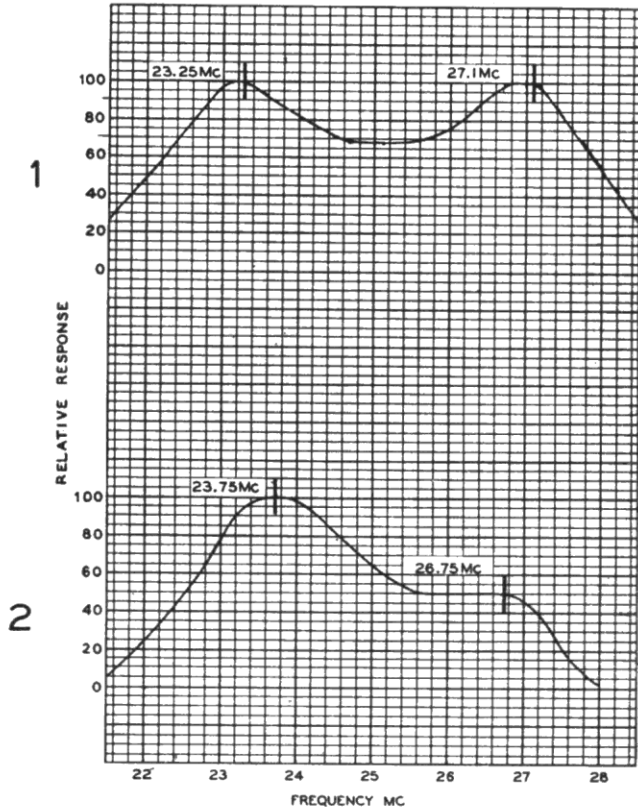
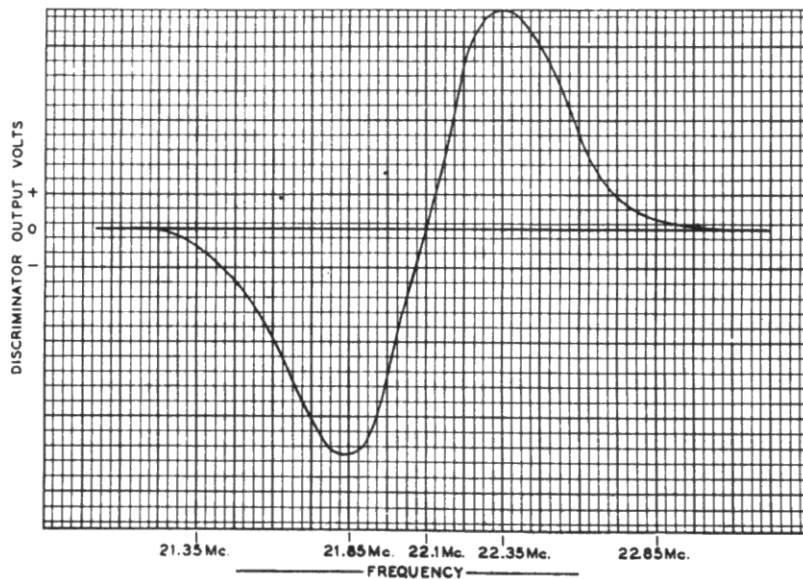

FIGURE 36. VIDEO-I-F CURVES (INPUT AND 1st V-I-F COUPLERS).



DISCRIMINATOR CHARACTERISTIC - SWEEP GENERATOR FED INTO INPUT I-F STAGE

FIGURE 37. DISCRIMINATOR-RESPONSE CURVE.

TP-2640

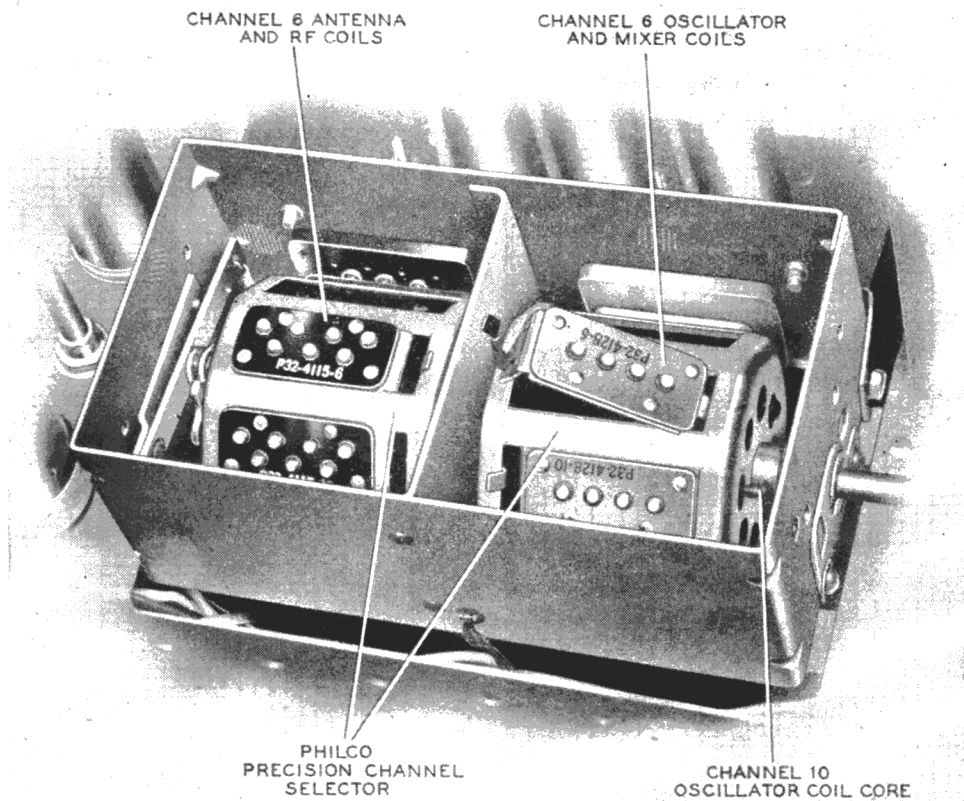

TP-3668A

FIGURE 38. PROPER METHOD OF COIL INSERTION.

SYMBOLIZATION

The components in the Receiver circuit are symbolized according to the types of parts and the sections of the Receiver in which the parts are located. The prefix letter of the symbol designates the type of part, as follows:

C —condenser	R —resistor
I —pilot lamp	S —switch
J —connector (receptacle)	T —transformer
L —choke or coil	W —power cord
LS —loud-speaker	X —crystal
P —connector (plug)	Z —electrical ass'y.

The number of the symbol designates the section in which the part is located, as follows:

- 100-series components are in Section 1 — the power supply circuits.**
- 200-series components are in Section 2 — the audio circuits.**
- 300-series components are in Section 3 — the video circuits.**
- 400-series components are in Section 4 — the r-f circuits.**
- 500-series components are in Section 5 — the sweep circuits.**

A suffix letter identifies the part as a component of the assembly which bears an identical number without a suffix letter, and with perhaps a different prefix letter.

SECTION 4 R F

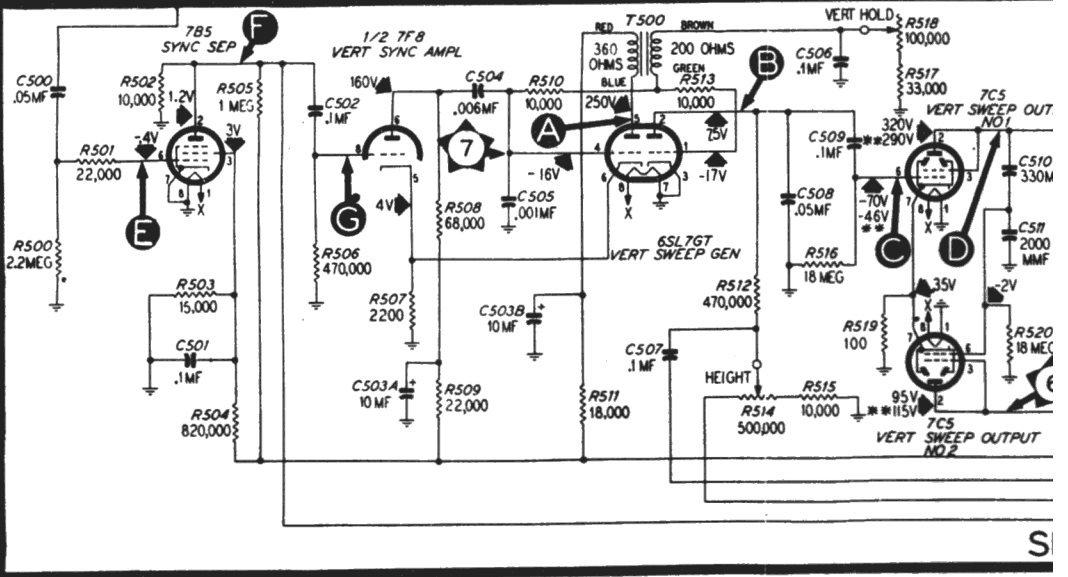
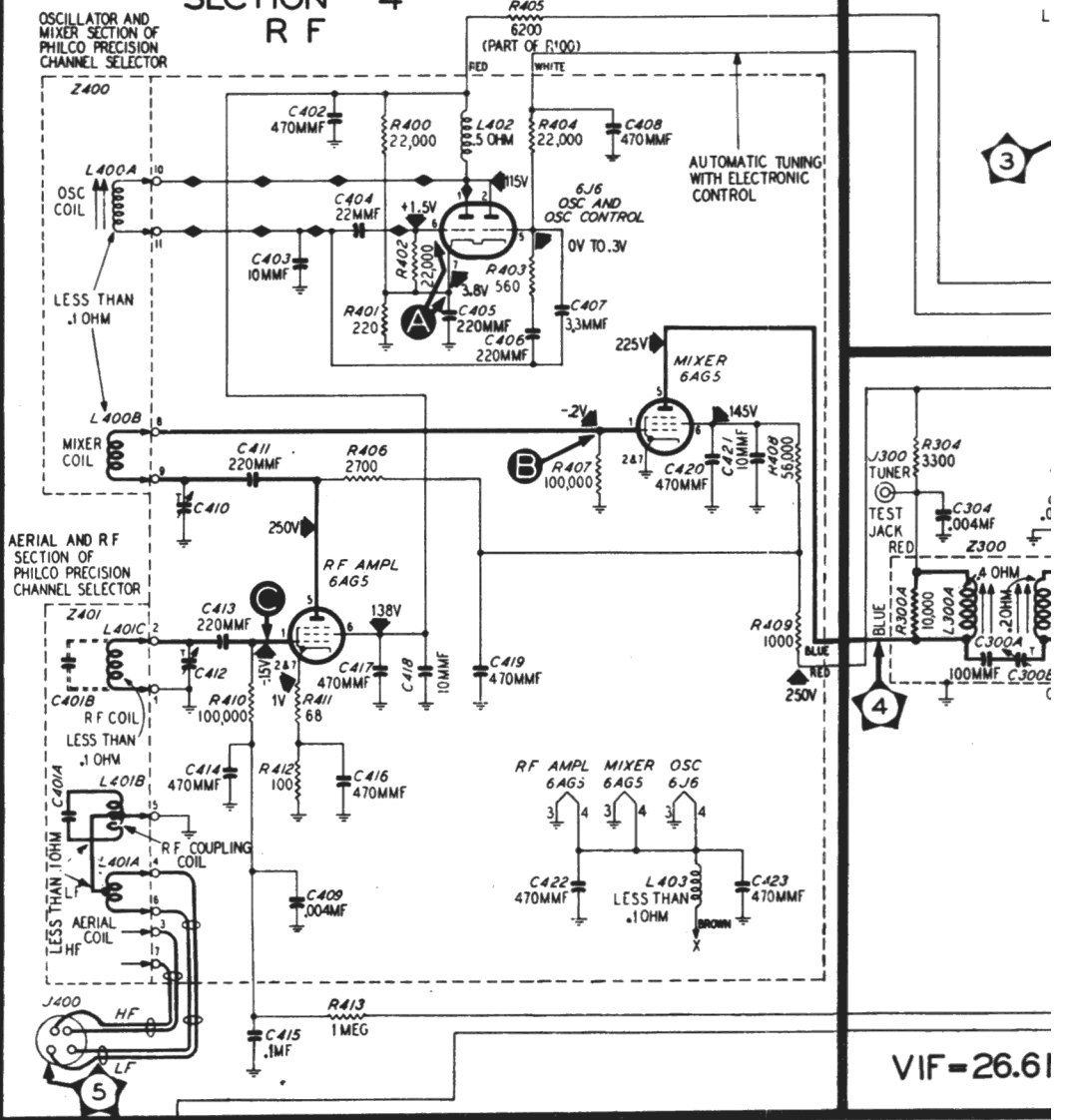

SECTION 2 AUDIO

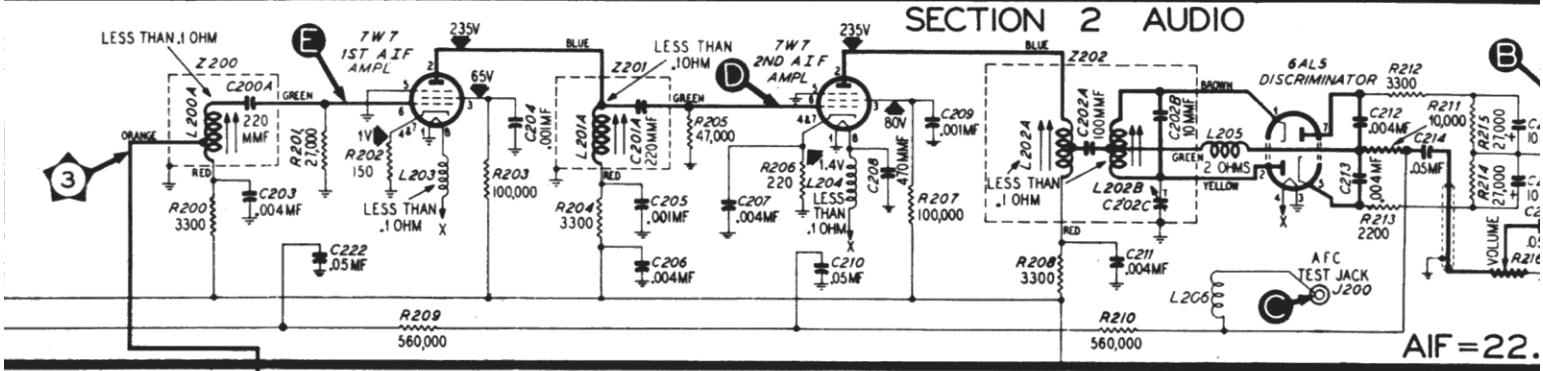

AIF=22.

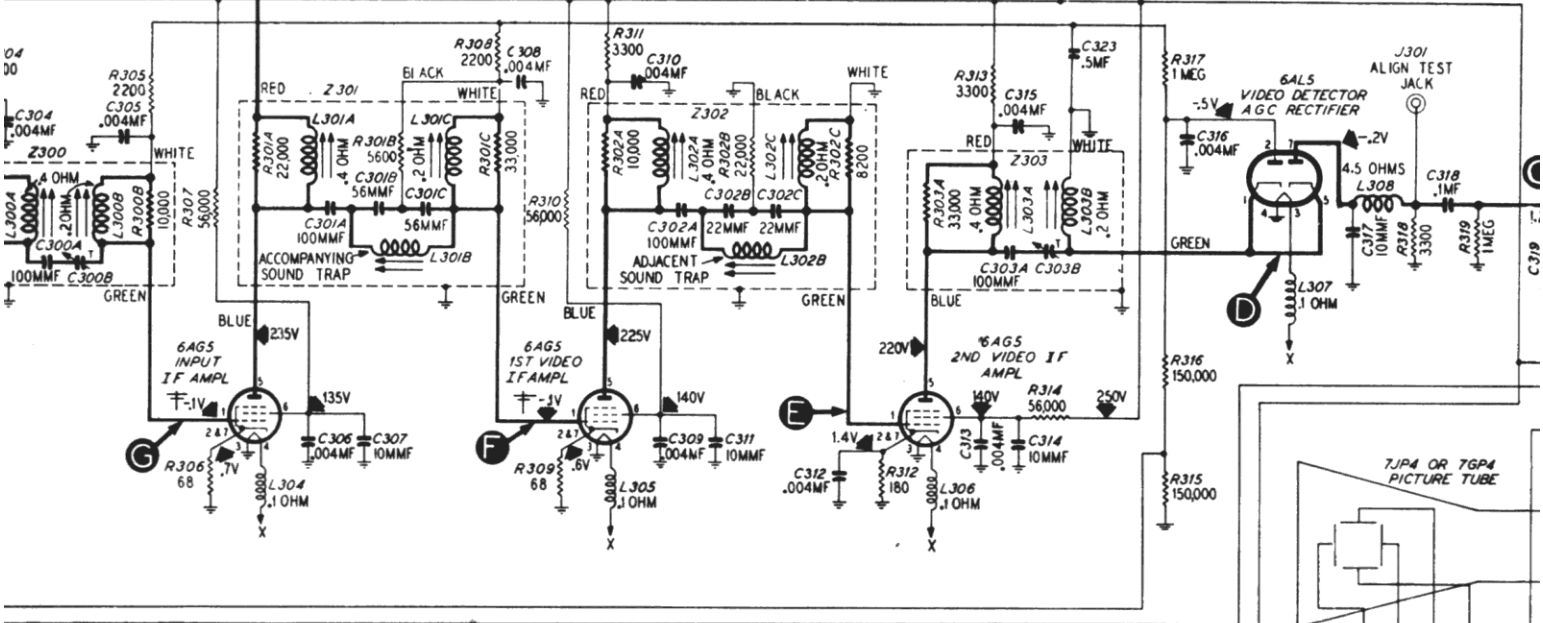

-26.6 MC

SECTION 3 VIDEO

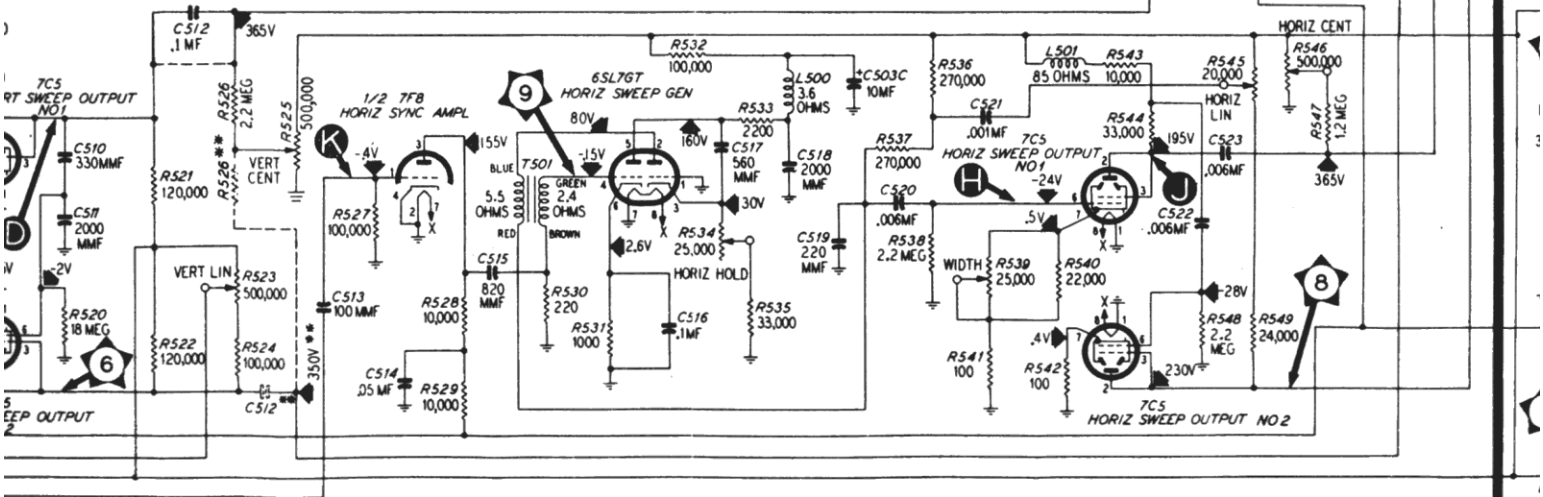

SECTION 5 SWEEP

FIGURE 33. MODEL 48-700, SECTIONALIZED SCHEMATIC DIAGRAM, SHOWING TEST POINTS.

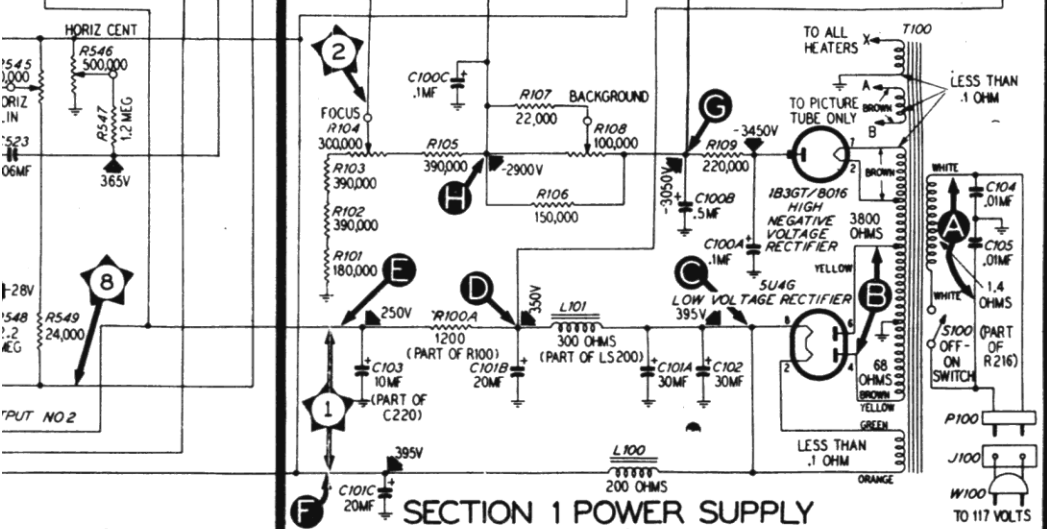
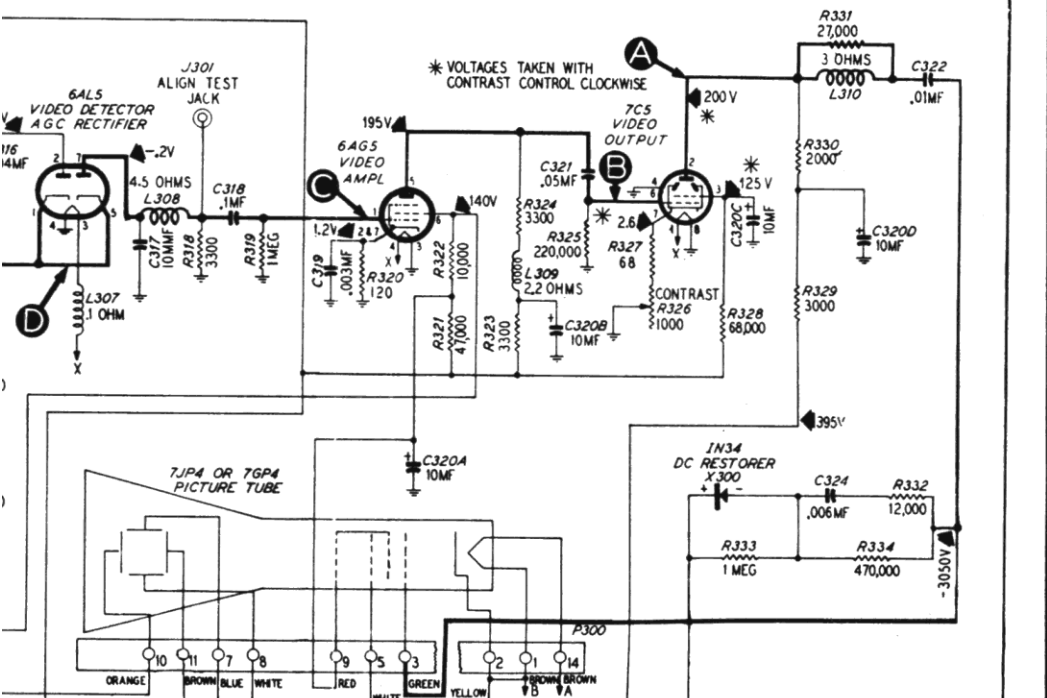
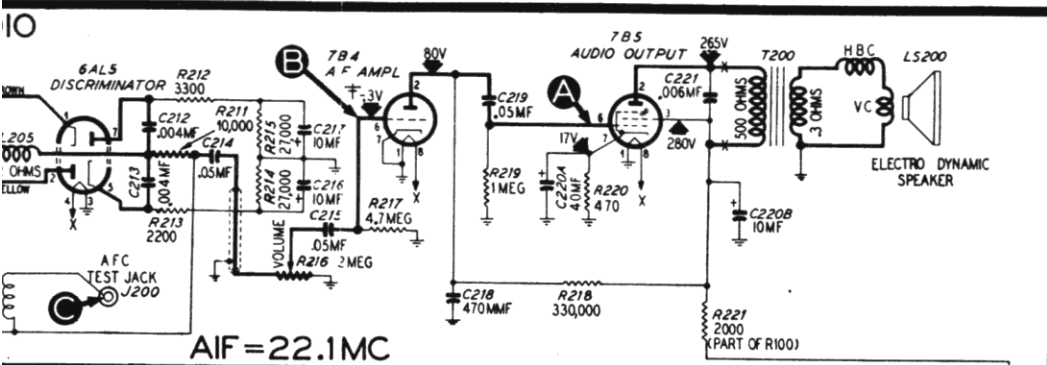

REPLACEMENT PARTS LIST

SECTION 2 — AUDIO CIRCUITS

NOTE: Part numbers marked with an asterisk (*) are general replacement items. These numbers may not be identical with those on factory assemblies; also, the electrical values of some replacement items may differ from the values indicated in the schematic diagram and parts list. The values substituted in any case are so chosen that the operation of the receiver will be either unchanged or improved. When ordering replacements, use only the "Service Part No."

SECTION 1 — POWER SUPPLY

Reference Symbol	Description	Service Part No.	Reference Symbol	Description	Service Part No.
C100	Condenser, electrolytic, 3-section, includes C100A, C100B, C100C	30-4646	C200A	Condenser, coupling, 220 mmf.	Part of Z200
C100A	Condenser, high-voltage filter, .1 mf.	Part of C100	C201A	Condenser, coupling, 220 mmf.	Part of Z201
C100B	Condenser, high-voltage filter, .5 mf.	Part of C100	C202A	Condenser, coupling, 100 mmf.	Part of Z202
C100C	Condenser, cathode by-pass, .1 mf.	Part of C100	C202B	Condenser, balancing, 10 mmf.	Part of Z202
C101	Condenser, electrolytic, 3-section, includes C101A, C101B, and C101C	30-2570-12	C202C	Condenser, tuning, trimmer, 1 to 8 mmf.	Part of Z202
C101A	Condenser, low-voltage filter, 30 mf.	Part of C101	C203	Condenser, plate by-pass, .004 mf.	61-0179*
C101B	Condenser, low-voltage filter, 20 mf.	Part of C101	C204	Condenser, screen by-pass, .001 mf.	45-3500-5*
C101C	Condenser, low-voltage filter, 20 mf.	Part of C101	C205	Condenser, plate by-pass, .001 mf.	45-3500-5*
C102	Condenser, electrolytic, low-voltage filter, 30 mf.	30-2568-9	C206	Condenser, plate by-pass, .004 mf.	61-0179*
C103	Condenser, electrolytic, low-voltage filter, 10 mf.	Part of 30-2570-16	C207	Condenser, cathode by-pass, .004 mf.	61-0179*
C104	Condenser, line-voltage filter, .01 mf.	30-1226-1	C208	Condenser, filament filter, 470 mmf.	62-147001001
C105	Condenser, line-voltage filter, .01 mf.	30-1226-1	C209	Condenser, screen by-pass, .001 mf.	45-3500-5*
J100	Connector (female), cabinet interlock	27-6217	C210	Condenser, a-f-c filter, .05 mf.	61-0122*
L100	Filter choke	32-8312	C211	Condenser, plate by-pass, .004 mf.	61-0179*
L101	Field coil, filter	Part of 36-1613-1	C212	Condenser, r-f by-pass, .004 mf.	61-0179*
P100	Connector (male), cabinet interlock	54-4426-2	C213	Condenser, r-f by-pass, .004 mf.	61-0179*
R100	Resistor, 3-section, includes R100A, R221, and R405	33-3435-6	C214	Condenser, coupling, .05 mf.	61-0122*
R100A	Resistor, voltage dropping, 1200 ohms	Part of R100	C215	Condenser, coupling, .05 mf.	61-0122*
R101	Resistor, high-voltage bleeder, 180,000 ohms	66-4184340	C216	Condenser, electrolytic, noise suppression, 10 mf.	30-2417-3
R102	Resistor, high-voltage bleeder, 390,000 ohms	66-4395340	C217	Condenser, electrolytic, noise suppression, 10 mf.	30-2417-3
R103	Resistor, high-voltage bleeder, 390,000 ohms	66-4395340	C218	Condenser, plate by-pass, 470 mmf.	60-10515307*
R104	FOCUS control, 330,000 ohms	33-5548-1	C219	Condenser, coupling, .05 mf.	61-0122*
R105	Resistor, high-voltage bleeder, 390,000 ohms	66-4395340	C220	Condenser, electrolytic, 3-section, includes C220A, C220B, and C103	30-2570-16
R106	Resistor, picture-tube bias, 150,000 ohms	66-4153340*	C220A	Condenser, cathode by-pass, 40 mf.	Part of C220
R107	Resistor, picture-tube bias, 22,000 ohms	66-3223340*	C220B	Condenser, filter, 10 mf.	Part of C220
R108	BACKGROUND control, 100,000 ohms	33-5548	C221	Condenser, audio by-pass, .006 mf.	61-0105*
R109	Resistor, high-voltage current limiting, 220,000 ohms	66-4225340	C222	Condenser, a-f-c filter, .05 mf.	61-0122*
S100	Switch, power	Part of 33-5538-12	J200	A-f-c test jack	27-6180
T100	Transformer, power	32-8364-1	L200A	Coil, 1st a-i-f	Part of Z200
W100	Power cord	L-2183	L201A	Coil, 2nd a.i.f.	Part of Z201
			L202A	Discriminator primary	Part of Z202
			L202B	Discriminator secondary	Part of Z202
			L203	Choke, filament	32-4112-3
			L204	Choke, filament	32-4112-3
			L205	Choke, balancing, 40 millihenries	32-4143-1
			L206	Choke, r-f, 40 millihenries	32-4143-1
			LS200	Loud-speaker, electrodynamic	36-1613-1
			R200	Resistor, plate filter, 3300 ohms	66-2333340*
			R201	Resistor, grid, 27,000 ohms	66-3273340*
			R202	Resistor, cathode, 150 ohms	61-1153340*
			R203	Resistor, screen dropping, 100,000 ohms	66-4104340*
			R204	Resistor, plate filter, 3300 ohms	66-2333340*
			R205	Resistor, grid, 47,000 ohms	66-3473340*
			R206	Resistor, cathode, 220 ohms	66-1223340*
			R207	Resistor, screen dropping, 100,000 ohms	66-4104340*

REPLACEMENT PARTS LIST (Continued)

SECTION 2 (Continued)

SECTION 3 (Continued)

Reference Symbol	Description	Service Part No.	Reference Symbol	Description	Service Part No.
R208	Resistor, plate filter, 3300 ohms	66-2333340*	C319	Condenser, cathode by-pass, .003 mf.	61-0109*
R209	Resistor, a-f-c filter, 560,000 ohms	66-4563340*	C320	Condenser, electrolytic, 4-section, includes C320A, C320B, C320C, and C320D	30-2570-10
R210	Resistor, a-f-c filter, 560,000 ohms	66-4563340*			
R211	Resistor, isolating, 10,000 ohms	66-3103340*	C320A	Condenser, screen decoupling, 10 mf.	Part of C320
R212	Resistor, isolating, 3300 ohms	66-2333340*	C320B	Condenser, plate decoupling, 10 mf.	Part of C320
R213	Resistor, isolating, 2200 ohms	66-2223340*	C320C	Condenser, screen decoupling, 10 mf.	Part of C320
R214	Resistor, discriminator load, 27,000 ohms	66-3273340*	C320D	Condenser, plate decoupling, 10 mf.	Part of C320
R215	Resistor, discriminator load, 27,000 ohms	66-3273340*	C321	Condenser, coupling, .05 mf.	61-0122*
R216	VOLUME control, 2 megohms	33-5538-12	C322	Condenser, coupling, .01 mf.	30-4642
R217	Resistor, grid, 4.7 megohms	66-5473340*	C323	Condenser, a-g-c filter, .5 mf.	61-0133*
R218	Resistor, plate load, 330,000 ohms	66-4333340*	C324	Condenser, coupling, .006 mf.	45-3500-7*
R219	Resistor, grid, 1 megohm	66-5103340*	J300	Tuner test jack	27-6180
R220	Resistor, cathode bias, 470 ohms	66-1475340*	J301	Align test jack	27-6180
R221	Resistor, plate dropping, 2000 ohms	Part of 33-3435-6	L300A	Coil, plate tuning	Part of Z300
T200	Transformer, audio output	32-8244-2	L300B	Coil, grid tuning	Part of Z300
Z200	Coupler, 1st a-i-f, includes C200A, and L200A	32-4100	L301A	Coil, plate tuning	Part of Z301
Z201	Coupler, 2nd a-i-f, includes C201A, and L201A	32-4099	L301B	Coil, trap tuning (accompanying sound)	Part of Z301
Z202	Transformer, discriminator, includes C202A, C202B, C202C, L202A, and L202B	32-4214-1	L301C	Coil, grid tuning	Part of Z301
			L302A	Coil, plate tuning	Part of Z302
			L302B	Coil, trap tuning (adjacent sound)	Part of Z302
			L302C	Coil, grid tuning	Part of Z302
			L303A	Coil, plate tuning	Part of Z303
			L303B	Coil, grid tuning	Part of Z303
			L304	Choke, filament	32-4112-3
			L305	Choke, filament	32-4112-3
			L306	Choke, filament	32-4112-3
			L307	Choke, filament	32-4112-3
			L308	Coil, video peaking, 150 millihenries	32-4143
			L309	Coil, video peaking, 70 millihenries	32-4143-2
			L310	Coil, video peaking, 70 millihenries	32-4143-2
			P300	Connector, picture-tube base	Part of 41-3779
			R300A	Resistor, plate damping, 10,000 ohms	Part of Z300
			R300B	Resistor, grid damping, 10,000 ohms	Part of Z300
			R301A	Resistor, plate damping, 22,000 ohms	Part of Z301
			R301B	Resistor, balancing (sound trap), 5600 ohms	Part of Z301
			R301C	Resistor, grid damping, 33,000 ohms	Part of Z301
			R302A	Resistor, plate damping, 10,000 ohms	Part of Z302
			R302B	Resistor, balancing (sound trap), 22,000 ohms	Part of Z302
			R302C	Resistor, grid damping, 8200 ohms	Part of Z302
			R303A	Resistor, plate damping, 33,000 ohms	Part of Z303
			R304	Resistor, plate filter, 3300 ohms	66-2333340*
			R305	Resistor, a-g-c filter, 2200 ohms	66-2223340*
			R306	Resistor, cathode bias, 68 ohms	66-0683340*
			R307	Resistor, screen dropping, 56,000 ohms	66-3563340*
			R308	Resistor, a-g-c filter, 2200 ohms	66-2223340*
			R309	Resistor, cathode bias, 68 ohms	66-0683340*
			R310	Resistor, screen dropping, 56,000 ohms	66-3563340*

SECTION 3 — VIDEO CIRCUITS

C300A	Condenser, coupling, 100 mmf.	Part of Z300
C300B	Condenser, coupling, trimmer	Part of Z300
C301A	Condenser, coupling, 100 mmf.	Part of Z301
C301B	Condenser, balancing, 56 mmf.	Part of Z301
C301C	Condenser, balancing, 56 mmf.	Part of Z301
C302A	Condenser, coupling, 100 mmf.	Part of Z302
C302B	Condenser, balancing, 22 mmf.	Part of Z302
C302C	Condenser, balancing, 22 mmf.	Part of Z302
C303A	Condenser, coupling, 100 mmf.	Part of Z303
C303B	Condenser, coupling, trimmer	Part of Z303
C304	Condenser, plate by-pass, .004 mf.	61-0179*
C305	Condenser, a-g-c filter, .004 mf.	61-0179*
C306	Condenser, screen by-pass, .004 mf.	61-0179*
C307	Condenser, screen by-pass, 10 mmf.	62-010009001
C308	Condenser, a-g-c filter, .004 mf.	61-0179*
C309	Condenser, screen by-pass, .004 mf.	61-0179*
C310	Condenser, plate by-pass, .004 mf.	61-0179*
C311	Condenser, screen by-pass, 10 mmf.	62-010009001
C312	Condenser, cathode by-pass, .004 mf.	61-0179*
C313	Condenser, screen by-pass, .004 mf.	61-0179*
C314	Condenser, screen by-pass, 10 mmf.	62-010009001
C315	Condenser, plate by-pass, .004 mf.	61-0179*
C316	Condenser, a-g-c filter, .004 mf.	61-0179*
C317	Condenser, r-f filter, 10 mmf.	62-010009001
C318	Condenser, coupling, .1 mf.	61-0113*

REPLACEMENT PARTS LIST (Continued)

SECTION 3 (Continued)

Reference Symbol	Description	Service Part No.
R311	Resistor, plate filter, 3300 ohms	66-2333340*
R312	Resistor, cathode bias, 180 ohms	66-1183340*
R313	Resistor, plate filter, 3300 ohms	66-2333340*
R314	Resistor, screen dropping, 56,000 ohms	66-3563340*
R315	Resistor, a-g-c voltage divider, 150,000 ohms	66-4153340*
R316	Resistor, a-g-c voltage divider, 150,000 ohms	66-4153340*
R317	Resistor, a-g-c filter, 1 megohm	66-5103340*
R318	Resistor, diode load, 3300 ohms	66-2333340*
R319	Resistor, grid, 1 megohm	66-5103340*
R320	Resistor, cathode bias, 120 ohms	66-1123340*
R321	Resistor, screen filter, 47,000 ohms	66-3473340*
R322	Resistor, screen dropping, 10,000 ohms	66-3103340*
R323	Resistor, plate filter, 3300 ohms	66-2333340*
R324	Resistor, plate load, 3300 ohms	66-2333340*
R325	Resistor, grid, 220,000 ohms	66-4223340*
R326	CONTRAST control, 1000 ohms	33-5546-7
R327	Resistor, cathode bias, 68 ohms	66-0683340*
R328	Resistor, screen dropping, 68,000 ohms	66-3683340*
R329	Resistor, plate filter, 3000 ohms	33-1335-16
R330	Resistor, plate load, 2000 ohms	33-1335-74
R331	Resistor, peaker damping, 27,000 ohms	66-3273340*
R332	Resistor, d-c restorer isolating, 12,000 ohms	66-3123340*
R333	Resistor, d-c restorer load, 1 megohm	66-5103340*
R334	Resistor, d-c restorer coupling, 470,000 ohms	66-4473340*
X300	Crystal, d-c restorer	54-6001
Z300	Coupler, input i-f (22.1 mc. and 26.6 mc.), includes C300A, C300B, R300A, R300B, L300A, and L300B	32-4093
Z301	Coupler, 1st v-i-f (26.6 mc.), includes C301A, C301B, C301C, R301A, R301B, R301C, L301A, L301B, and L301C	32-4213
Z302	Coupler, 2nd v-i-f (26.6 mc.), includes C302A, C302B, C302C, R302A, R302B, R302C, L302A, L302B, and L302C	32-4213-1
Z303	Coupler, 3rd v-i-f (26.6 mc.), includes C303A, C303B, R303A, L303A, and L303B	32-4093-3

SECTION 4 — R-F CIRCUITS

C401A	Condenser, aerial tuning	Part of Z401
C401B	Condenser, aerial tuning	Part of Z401
C402	Condenser, plate by-pass, 470 mmf.	62-147001001
C403	Condenser, grid by-pass, 10 mmf.	62-010009001
C404	Condenser, coupling, 22 mmf.	62-022009001
C405	Condenser, cathode by-pass, 220 mmf.	62-122001001
C406	Condenser, phase shifter, 220 mmf.	62-122001001
C407	Condenser, frequency compensating, 3.3 mmf.	30-1221

SECTION 4 (Continued)

Reference Symbol	Description	Service Part No.
C408	Condenser, a-f-c filter, 470 mmf.	62-147001001
C409	Condenser, a-g-c filter, .004 mmf.	61-0179*
C410	Condenser, plate tuning, trimmer	31-6493
C411	Condenser, coupling, 220 mmf.	62-122001001
C412	Condenser, aerial trimmer	31-6493
C413	Condenser, grid isolating, 220 mmf.	62-122001001
C414	Condenser, a-g-c filter, 470 mmf.	62-147001001
C415	Condenser, a-g-c filter, .1 mf.	61-0113*
C416	Condenser, cathode by-pass, 470 mmf.	62-147001001
C417	Condenser, screen by-pass, 470 mmf.	62-147001001
C418	Condenser, screen by-pass, 10 mmf.	62-010009001
C419	Condenser, plate by-pass, 470 mmf.	62-147001001
C420	Condenser, screen by-pass, 470 mmf.	62-147001001
C421	Condenser, screen by-pass, 10 mmf.	62-010009001
C422	Condenser, filament by-pass, 470 mmf.	62-147001001
C423	Condenser, filament by-pass, 470 mmf.	62-147001001
J400	Aerial receptacle	27-6214-1
L400A	Coil, oscillator	Part of Z400
L400B	Coil, mixer	Part of Z400
L401A	Coil, aerial	Part of Z401
L401B	Coil, r-f coupling	Part of Z401
L401C	Coil, r-f	Part of Z401
L402	Choke, oscillator plate	32-4112-2
L403	Choke, filament	32-4112-4
R400	Resistor, cathode bleeder, 22,000 ohms	66-3224340
R401	Resistor, cathode bias, 220 ohms	66-1228340*
R402	Resistor, grid leak, 22,000 ohms	66-3228540
R403	Resistor, phase shifter, 560 ohms	66-1568340*
R404	Resistor, grid leak, 22,000 ohms	66-3228540
R405	Resistor, plate filter, 6200 ohms	Part of R100
R406	Resistor, plate load, 2700 ohms	66-2278340
R407	Resistor, grid leak, 100,000 ohms	66-4108540
R408	Resistor, screen dropping, 56,000 ohms	66-3568340
R409	Resistor, plate filter, 1,000 ohms	66-2108540
R410	Resistor, grid leak, 100,000 ohms	66-4108540
R411	Resistor, cathode degeneration, 68 ohms	66-0688340
R412	Resistor, cathode bias, 100 ohms	66-1108340
R413	Resistor, a-g-c filter, 1 megohm	66-5103340*
Z400	Oscillator-and-mixer-coil assembly	
	Channel 2	32-4222-2
	Channel 3	32-4222-3
	Channel 4	32-4222-4
	Channel 5	32-4222-5
	Channel 6	32-4222-6
	Channel 7	32-4222-7
	Channel 8	32-4222-8
	Channel 9	32-4222-9
	Channel 10	32-4222-10

REPLACEMENT PARTS LIST (Continued)

SECTION 4 (Continued)

SECTION 5 (Continued)

Reference Symbol	Description	Service Part No	Reference Symbol	Description	Service Part No.
	Channel 11.....	32-4222-11	R500	Resistor, grid, 2.2 megohms	66-5223340*
	Channel 12.....	32-4222-12	R501	Resistor, current limiting, 22,000 ohms	66-3223340
	Channel 13.....	32-4222-13	R502	Resistor, plate bleeder, 10,000 ohms	66-3103340*
Z401	Aerial-and-r-f-coil assembly		R503	Resistor, screen bleeder, 15,000 ohms	66-3153340*
	Channel 2	32-4115-2	R504	Resistor, screen dropping, 820,000 ohms	66-4824340*
	Channel 3	32-4115-3	R505	Resistor, plate load, 1 megohm	66-5104340*
	Channel 4	32-4115-4	R506	Resistor, grid, 470,000 ohms	66-4473340*
	Channel 5	32-4115-5	R507	Resistor, cathode bias, 2200 ohms	66-2223340*
	Channel 6	32-4115-6	R508	Resistor, plate load, 68,000 ohms	66-3684340*
	Channel 7	32-4115-7	R509	Resistor, plate filter, 22,000 ohms	66-3223340*
	Channel 8	32-4115-8	R510	Resistor, grid, 10,000 ohms	66-3103340*
	Channel 9	32-4115-9	R511	Resistor, plate filter, 18,000 ohms	66-3183340*
	Channel 10.....	32-4115-10	R512	Resistor, plate load, 470,000 ohms	66-4474340*
	Channel 11.....	32-4115-11	R513	Resistor, grid, 10,000 ohms	66-3103340*
	Channel 12.....	32-4115-12	R514	HEIGHT control, 500,000 ohms	33-5539-18
	Channel 13.....	32-4115-13	R515	Resistor, height-control bleeder, 10,000 ohms	66-3103340*
			R516	Resistor, grid, 18 megohms	66-6183340*
			R517	Resistor, minimum grid bias, 33,000 ohms	66-3333340*
C500	Condenser, coupling, .05 mf.	61-0122*		VERT. HOLD control, 100,000 ohms	33-5539-15
C501	Condenser, screen by-pass, .1 mf.	61-0113*	R518	Resistor, cathode, 100 ohms	66-1103340*
C502	Condenser, coupling, .1 mf.	61-0113*	R519	Resistor, grid, 18 megohms	66-6153340*
C503	Condenser, electrolytic, 3-section, includes C503A, C503B, and C503C	30-2570-13	R520	Resistor, plate load, 120,000 ohms	66-4125340
C503A	Condenser, plate decoupling, 10 mf.	Part of C503	R521	Resistor, plate load, 120,000 ohms	66-4125340
C503B	Condenser, plate decoupling, 10 mf.	Part of C503	R522	VERT. LIN. control, 500,000 ohms	33-5539-18
C503C	Condenser, plate decoupling, 10 mf.	Part of C503	R523	Resistor, vertical-linearity range fixing, 100,000 ohms	66-4103340
C504	Condenser, coupling, .006 mf.	45-3500-7*		VERT. CENT. control, 500,000 ohms	33-5539-18
C505	Condenser, integrating, .001 mf.	45-3500-5*	R525	Resistor, isolating, 2.2 megohms	66-5223340*
C506	Condenser, by-pass, .1 mf.	61-0113*	R526	Resistor, differentiating, 100,000 ohms	66-4103340*
C507	Condenser, feedback, .1 mf.	45-3500-8*	R527	Resistor, plate load, 10,000 ohms	66-3103340
C508	Condenser, plate by-pass, .05 mf.	61-0122*	R528	Resistor, plate filter, 10,000 ohms	66-3103340*
C509	Condenser, coupling, .1 mf.	45-3500-8*	R529	Resistor, grid, 220 ohms	66-1223340*
C510	Condenser, coupling and voltage divider, 330 mmf.	60-10335407*	R531	Resistor, cathode, 1000 ohms	66-2103340*
C511	Condenser, voltage divider, 2000 mmf.	60-20205304	R532	Resistor, plate filter, 100,000 ohms	66-4103340*
C512	Condenser, coupling, .1 mf.	61-0113*	R533	Resistor, plate load, 2200 ohms	66-2223340*
C513	Condenser, differentiating, 100 mmf.	60-10105407	R534	HORIZ. HOLD control, 25,000 ohms	33-5539-28
C514	Condenser, plate filter, .05 mf.	61-0122*	R535	Resistor, cathode bias, 33,000 ohms	66-3333340*
C515	Condenser, coupling, 820 mmf.	60-10825404*	R536	Resistor, plate filter, 270,000 ohms	66-4273340*
C516	Condenser, cathode by-pass, .1 mf.	61-0113*	R537	Resistor, plate load, 270,000 ohms	66-4273340*
C517	Condenser, coupling, 560 mmf.	60-10515307*	R538	Resistor, grid, 2.2 megohms	66-5223340*
C518	Condenser, plate filter, 2000 mmf.	60-20205304	R539	WIDTH control, 25,000 ohms	33-5539-28
C519	Condenser, plate by-pass, 220 mmf.	60-10205307*	R540	Resistor, width-control range fixing, 22,000 ohms	66-3223340*
C520	Condenser, coupling, .036 mf.	45-3500-7*		Resistor, cathode bias, 100 ohms	66-1103340*
C521	Condenser, feedback, .001 mf.	45-3500-5*	R541	Resistor, cathode bias, 100 ohms	66-1103340*
C522	Condenser, coupling, .036 mf.	45-3500-7*	R542	Resistor, plate dropping, 10,000 ohms	66-3105340
C523	Condenser, coupling, .036 mf.	45-3500-7*	R543	Resistor, plate load, 33,000 ohms	66-3335340
L500	Choke, 60 millihenries	32-4256	R544	HORIZ. LIN. control, 20,000 ohms	33-5546-5
L501	Peaking coil, 10 millihenries	32-4276	R545		

REPLACEMENT PARTS LIST (Continued)

SECTION 5 (Continued)

Reference Symbol	Description	Service Part No.
R546	HORIZ. CENT. control, 500,000 ohms	33-5539-18
R547	Resistor, isolating, 1.2 megohms	66-5123340*
R548	Resistor, grid, 2.2 megohms	66-5223340*
R549	Resistor, plate load, 24,000 ohms	33-1335-25
T500	Transformer, vertical-sweep generator	32-8304
T501	Transformer, horizontal-sweep generator	32-8307

MISCELLANEOUS (Continued)

Description	Service Part No.
Cable-and-socket assembly, picture tube	41-3779
Cable, speaker	41-3734-6
Rubber, chassis mounting	27-4571
Screw, chassis mounting	1W-19780FA3
Shaft, background control	56-4582
Shield base, miniature	56-3978FA3
Shield, miniature tube	56-3979FA5
Socket, Loktal, 11 required	27-6138
Socket, miniature (6J6 tube)	27-6203-1
Socket, miniature, 6 required	27-6226
Socket, octal, 3 required	27-6174
Socket, octal-ring mounting (1B3GT tube)	27-6222
Socket, test, 3 required	27-6180
Spacer, threaded (background-control assembly)	76-2813
Spring, background-control assembly	56-4583FE7
Spring, 6J6 tube	56-4724
Spring, station-selector knob	56-5241
Stand-off, for 1B3GT, 2 required	54-7309
Stand-off, for 10-lug terminal panel, 2 required	54-7309-3
Stand-off, for 9-lug terminal panel, 2 required	54-7309-3
Tube holder (for 5U4G rectifier)	56-4125FA3
Tuner Assembly	76-3109-1
Oscillator-and-mixer-contact panel (4 connections)	76-2678
Aerial-and-rf-contact panel (7 connections)	76-2664
Shaft-and-drum assembly	76-3110-1
Washer, chassis mounting	56-4997FA3

MISCELLANEOUS

Description	Service Part No.
Cabinet	10671
Cabinet Hardware and Parts	
Baffle, wood (picture tube)	219073
Baffle, wood and cloth	406862
Bolt, speaker	W-1695
Bracket (a-c interlock)	56-4344FA3
Cabinet, back	76-3057FJ31
Escutcheon assembly	76-2924-1
Knob	54-4376
Mask, picture tube	54-4453
Metal cover (bottom)	56-4524
Mounting feet, 4 required	27-4911
Selector-knob-and-spring assembly	76-2953
Shell, a-c interlock	56-4346
Tab kit	40-6948
Window, glass (for picture tube)	27-5948

